









505.73

679  
N.Y.

THE  
**AMERICAN JOURNAL**  
 OF  
**SCIENCE AND ARTS.**

CONDUCTED BY  
**BENJAMIN SILLIMAN, M. D. LL. D.**

Prof. Chem., Min., &c. in Yale Coll.; Cor. Mem. Soc. Arts, Man. and Com.; and For. Mem. Geol. Soc., London; Mem. Geol. Soc., Paris; Mem. Roy. Min. Soc., Dresden; Nat. Hist. Soc., Halle; Imp. Agric. Soc., Moscow; Hon. Mem. Lin. Soc., Paris; Nat. Hist. Soc., Belfast, Ire.; Phil. and Lit. Soc., Bristol, Eng.; Hon. Mem. Roy. Sussex Inst., Brighton, Eng.; Lit. and Hist. Soc., Quebec; Mem. of various Lit. and Scien. Soc. in America.

AIDED BY  
**BENJAMIN SILLIMAN, JR., A. B.**

Assistant in the department of Chemistry, Mineralogy and Geology in Yale College; Sec. of the Yale Nat. Hist. Soc., Mem. of the Conn. Acad. of Arts and Sci.; Cor. Mem. of the Lyceum of Natural History, New York, &c.

1835 to  
 VOL. XXXV.—~~JANUARY~~, 1839.

NEW HAVEN:

Sold by A. H. MALTBY and B. & W. NOYES.—*Philadelphia*, CAREY & HART and J. S. LITTELL.—*Baltimore, Md.*, N. HICKMAN.—*New York*, G. & C. CARVILL & Co., No. 108 Broadway, and G. S. SILLIMAN, No. 44 William St.—*Boston*, C. C. LITTLE & Co.—*London*, JAMES S. HODSON, No. 112 Fleet St.—*Paris*, CHARLES DUPERRON, Rue Mabillon.

PRINTED BY B. L. HAMLEN.



AMERICAN BIBLE SOCIETY

1832



CONTENTS OF VOLUME XXXV.

---

NUMBER I.

	Page.
ART. I. Memoir of the Life and Character of Nathaniel Bowditch, LL. D., F. R. S.; by Rev. ALEXANDER YOUNG,	1
II. Cursory Remarks upon East Florida, in 1838; by Maj. HENRY WHITING, - - - - -	47
III. Geology of St. Croix; by Prof. S. HOVEY, - - - - -	64
IV. Geology of Antigua; by Prof. S. HOVEY, - - - - -	75
V. Remarks on the Geology and Topography of Western New York; by GEORGE E. HAYES, - - - - -	86
VI. On Electro-Magnetism, as a Moving Power; by CHARLES G. PAGE, M. D. - - - - -	106
VII. Magnetic Electrometer and Electrotome, to be used with flat spirals; by CHARLES G. PAGE, M. D. - - - - -	112
VIII. Observations on the Vascular System of Ferns, and Notice of a monstrous flower of <i>Orchis spectabilis</i> , (with a plate;) by Prof. J. W. BAILEY, - - - - -	113
IX. On Fossil Infusoria, discovered in Peat-Earth, at West Point, N. Y., with some notices of American Diatomæ, (with a plate;) by Prof. J. W. BAILEY, - - - - -	118
X. Description of experiments with the Voltaic Battery, in the course of which, certain Insects constantly appeared; by ANDREW CROSSE, Esq., of Broomfield, Eng.; (from the Trans. of Lond. Elec. Soc.) - - - - -	125
XI. Notice of Danburite, a New Mineral Species; by Prof. CHARLES UPHAM SHEPARD, - - - - -	137
XII. On Certain Cavities in Quartz, &c.; by Dr. W. L. ATLEE,	139
XIII. On the Atmospheric Origin of the Aurora, and its connexion with the crystallization of snow; by B. F. JOSLIN, M. D. - - - - -	145
XIV. Letters on Atlantic Steam Navigation; by JUNIUS SMITH,	160

## MISCELLANIES.

	Page.
1. Report on the Shooting Stars of the 9th and 10th of August, 1838, - - - - -	167
2. Observations made at Yale College on the Solar eclipse of Sept. 18, 1838, - - - - -	174
3. Supposed New Mineral at Bolton, Mass. - - - - -	178
4, 5. New Locality of Crichtonite—Stilbite, Chabasie, and other minerals at Stonington, Ct. - - - - -	179
6, 7. Crichtonite in R. I.—Notice of the New Flora of North America now publishing by John Torrey and Asa Gray, - - - - -	180
8. Redfield's Law of Storms;—Notice of Lieut. Col. Reid's work on hurricanes, - - - - -	182
9. Notice of Lea's Observations on the genus Unio, &c. - - - - -	184
10. Notice of Holbrook's North American Herpetology, Vols. 1 & 2, - - - - -	186
11, 12. Announcement of Second Part to Shepard's Descriptive Mineralogy—Blowpipe mouth for oxygen and hydrogen, - - - - -	187
13. Salisbury's Analysis of the Mineral Waters of Avon, N. Y. - - - - -	188
14. Notice of Feuchtwanger's Treatise on Gems, - - - - -	189
15. Extreme heat at Cumberland, Md. in July, 1838, - - - - -	190
16. Evidences of diluvial currents, &c. - - - - -	191
17. Notice of the American Almanac for 1839, - - - - -	191
18, 19, 20. Green Feldspar and Galena—Fossil fishes in the red sandstone of New Jersey—U. S. South Sea Surveying and Exploring Expedition, - - - - -	192
21. Annals of Natural History, or Magazine of Zoology, Botany, and Geology, - - - - -	194
22. Analysis of Gmelinite or Hydrolite, - - - - -	195
23. Prof. Owen on the Fossil Animals collected by Mr. Charles Darwin, - - - - -	196
24, 25. Presentation of the Wollaston Medal—On the Rapidity of Motion in Railway Cars which is consistent with safety, - - - - -	197
26. On the Gases contained in the Blood, and on Respiration, - - - - -	198
27. Eighth Meeting of the British Association for the Advancement of Science, - - - - -	200

## NUMBER II.

	Page.
ART. I. On the Courses of Hurricanes ; with notices of the Ty- foons of the China Sea, and other Storms ; by W. C. REDFIELD, - - - - -	201
II. On the Meteor of May 18th, 1838, and on Shooting Stars in general ; by Prof. ELIAS LOOMIS, - - -	223
III. Account of a Storm in New Hampshire, in a letter ad- dressed to Prof. O. P. Hubbard of Dartmouth College ; by Rev. JOHN WOODS, - - - - -	233
IV. Notes on American Geology ; by T. A. CONRAD, - - -	237
V. Magneto-Electric and Electro-Magnetic Apparatus and Experiments ; by CHARLES G. PAGE, M. D., - - -	252
VI. Description of some new Shells ; by BENJAMIN TAP- PAN, - - - - -	268
VII. On the employment of <i>Uvularia perfoliata</i> as a reme- dy for Poisoned Wounds ; by BENJAMIN HORNER COATES, M. D., - - - - -	270
VIII. An Account of the proceedings of the Eighth Meeting of the British Association for the Advancement of Science, - - - - -	275
IX. On Cupellation, an easy, an accurate, and new method ; by W. W. MATHER, - - - - -	321
X. Meteoric Observations made at Cambridge, Mass. ; by Prof. J. LOVERING, - - - - -	323
XI. Notice from Prof. ROBERT HARE, respecting the Fu- sion of Platina, also respecting a new Ether, and a Series of Gaseous Compounds formed with the Ele- ments of Water, - - - - -	328
XII. Letters on Steam Navigation ; by JUNIUS SMITH, Esq. —with a Letter to the Editors, from Mr. HENRY SMITH,	332
XIII. On a New and Effectual Method of Preserving Speci- mens of Organic Nature, and of Obviating the Blanch- ing influences of Light, and the Depredations of Insects ; —most Advantageously Applicable to the Formation and Unlimited Preservation of a Hortus Siccus, or Mu- seum of Dried Plants ; by Professor JOHN L. RIDDELL, M. D., - - - - -	338
XIV. Electro-Magnetic Engine, constructed by the late A. W. CAMPBELL, - - - - -	343
XV. Miscellaneous Notices in Opelousas, Attakapas, &c. ; by Prof. W. M. CARPENTER, - - - - -	344

	Page.
XVI. On the Liquefaction and Solidification of Carbonic Acid; by J. K. MITCHELL, M. D., - - - - -	346
XVII. On a general Electro-Magnetic and Magneto-Electric Formula, - - - - -	356
XVIII. Fossil Encrinite; by JOHN G. ANTHONY, - - - - -	359
XIX. Report on the Shooting Stars of Dec. 7, 1838, with re- marks on Shooting Stars in general; by E. C. HER- RICK, - - - - -	361
XX. On the Meteoric Shower of November, 1838; by Prof. DENISON OLMSTED, - - - - -	368
XXI. Communication respecting Fossil and Recent Infuso- ria made to the British Association at Newcastle; by Prof. EHRENBERG, - - - - -	371

## MISCELLANIES.

1. Dr. TORREY's Experiments on the Condensation of Carbonic, Sulphurous, and Chloro-chromic Acid Gases, - - - - -	374
2. Critical Interpretation of <i>bara</i> and <i>asah</i> , in a letter from Dr. NOAH WEBSTER to the Rev. WILLIAM BUCKLAND, Oxford, England, - - - - -	375
3. Notice of the Height of Mountains in North Carolina, - - - - -	377
4, 5. Fossil Shells and Bones—Auroral Arch in Vermont, - - - - -	380
6, 7. Geological Specimens from the East Indian Archipelago— Resemblance to an Aurora, - - - - -	381
8. Meteorological Register for 1837, - - - - -	382
9, 10. Geological Surveys—Dr. Mantell's Wonders of Geology, - - - - -	384
11, 12, 13. Mr. Bakewell's Geology—Elements of Geology—Dr. Lewis C. Beck's Manual of Chemistry, - - - - -	385
14, 15. Notice of a Manual of Conchology according to the sys- tem laid down by Lamarck, with the late improvements by De Blainville—Eulogiums on the late Dr. Nathaniel Bowditch, - - - - -	386
16, 17. The Science of Geology, from the Glasgow Treatises, with additions—Dr. Charles T. Jackson's Reports on the Geology of Maine, - - - - -	387
18, 19. Callinite or Indian Pipe Stone—Encke's Comet, - - - - -	388
20. Grave of Godfrey, the inventor of the Quadrant, and of Charles Thomson, - - - - -	389
21. Marble and Serpentine in Vermont, - - - - -	390
22, 23, 24. Oil from White Fish—Calcium—N. Dunn's Chinese Collection, at Philadelphia, - - - - -	391
25. Prof. Agassiz and his Works, - - - - -	400

## ERRATA.

---

P. 200, 5th line fr. bot. after *presiding*, read *over the Math. and Phys. Section*.—  
P. 207, 4th line fr. top, for 1837, read 1835.—P. 216, 4th line from bot. for *Paracels*, read *Pratas*.—P. 325, last line, for *commenced*, read *enumerated*.—P. 374, 6th  
line from bot. for *It it*, read *It is*.—P. 400, 13th line from bot. for *Moranies*, read  
*Moraines*.

---

*Fossils of the Medial Tertiary of the United States*, by Mr. T. A. Conrad.—Mr.  
Dobson of Philadelphia, in a letter dated Dec. 31, 1838, (received after our present  
number was printed,) announces that he has published the first part of this new  
work of Mr. Conrad. It will be completed in about 15 months, in 3 parts. The  
first No. contains 17 plates, and 47 species. He will again visit the Tertiary re-  
gion, and give a detailed description of the various localities in a future number.  
The price of the whole, will be \$ 4 50.



THE  
AMERICAN  
JOURNAL OF SCIENCE, &c.

---

---

ART. I.—*Memoir of the Life and Character of Nathaniel Bowditch, LL. D., F. R. S.*; by Rev. ALEXANDER YOUNG.

NATHANIEL BOWDITCH was born at Salem, in the Commonwealth of Massachusetts, on the 26th day of March, 1773. He was the fourth child of Habakkuk and Mary Ingersoll Bowditch. His ancestors, for three generations, had been shipmasters, and his father, on retiring from that perilous mode of hard industry, carried on the trade of a cooper, by which he gained a scanty and precarious subsistence for a family of seven children.

I had a curiosity to trace up the life of this wonderful man, if possible, to his childhood, to ascertain his early character and powers, and the influences under which his heart and mind had been formed. Accordingly, on a recent visit to Salem, I took a walk, of some two or three miles, to see a house where he used to say that he and his mother had lived when he was as yet hardly advanced beyond infancy. My walk brought me among the pleasant farm-houses of a retired hamlet in Essex county; and I found the plain two-story house,\* with but two small rooms in it, where he dwelt with his mother; and I saw the chamber-window where he said she used to sit and show him "the new moon with the old moon in her arm," and, with the poetical superstition of a sailor's wife, jingle the silver in her pocket that her husband

---

\* This house is in Danvers, near the junction of several roads, this side of the Derby farm. See wood cut, next page.

might have good luck, and she good tidings from him, far off upon the sea. I entered that house and two others in the vicinity, and found three ancient women who knew her well, and remembered her wonderful boy. I sat down by their firesides and listened with greedy ear to the story, which they gladly told me, of that remarkable child, remarkable for his early goodness as well as for his early greatness. Their words, uttered in the plain, hearty English of the yeomanry of New England, I took down from their lips, and now give them without any alteration or improvement whatever.



The first one I interrogated said that "Nat. was a likely, clever, thoughtful boy. Learning came natural to him; and his mother used to say that he would make something or nothing." I asked her whether she had ever heard what became of him. "O yes," she replied, "he became a great man, and went to Boston, and had a mighty deal of learning." "What kind of learning?" I asked. "Why," she answered, "I believe he was a pilot, and knew how to steer all the vessels." This evidently was her simple and confused idea of "The Practical Navigator."

The second old lady stated that "Nat. went to school to her aunt, in the revolutionary war, in the house where we were then sitting, when he was about three years old, and that she took mightily to him, and that he was the best scholar she ever had.



He learnt amazing fast, for his mind was fully given to it. He did not seem like other children ; he seemed better. His mother was a beautiful, nice woman."

The third old lady said that "Nat. was a little, still creature ; and his mother a mighty free, good-natured woman. She used to say, ' Who should n't be cheerly if a Christian should n't ? ' Her children took after her, and she had a particular way of guarding them against evil."

These I testify to be their very words, as I pencilled them down at the time. And they show, I think, very clearly, the influence of the mother's mind and heart upon the character of her son. Of that mother, in after life, and to its close, he often spoke in terms of the highest admiration and the strongest affection, and in his earnest manner would say—" My mother loved me—idolized me—worshipped me."

After leaving the dame's school, the only other instruction he ever received was obtained at the schools of his native town, which were wholly inadequate to furnish even the groundwork and elements of a respectable education. I have heard it stated, on the authority of one of his schoolfellows, that the only book in their school was a dictionary, which belonged to the master, who gave out the words from it to be spelt by the boys. I have likewise been told by one who lived in Salem at the time, that the master of this school, a person of violent temper, gave young Bowditch, when he was about five or six years old, a very difficult sum in arithmetic to perform. His scholar went to his desk, and soon afterwards brought up his slate with the question solved. The master, surprised at the suddenness of his return, asked him who had been doing the sum for him ; and on answering " Nobody—I did it myself," he gave him a severe chastisement for *lying*, not believing it possible that he could, of himself, without any assistance, perform so difficult a question.

But the advantages of school, such as they were, he was obliged to forego at the early age of ten years, " his poverty and not his will consenting," that he might go into his father's shop and help to support the family. He was soon, however, transferred as an apprentice to a ship-chandler, and afterwards became a clerk in a large establishment of the same kind, where he continued until he went to sea. It was whilst he was an apprentice in the ship-chandler's shop that he first manifested that strong bent, or what

is commonly called an original genius, for mathematical pursuits. Every moment that he could snatch from the counter, was given to the slate. An old gentleman, who used frequently to visit the shop, said to his wife, one day, on returning home, "I never go into that shop but I see that boy ciphering and figuring away on his slate, as if his very life depended upon it; and if he goes on at this rate, as he has begun, I should not at all wonder if, at last, in the course of time, he should get to be an almanac-maker!"—this being, in his view, the summit of mathematical attainment. The expectation was speedily fulfilled, for in the year 1788, when he was only fifteen years old, he actually made an almanac for the year 1790, containing all the usual tables, calculations of the eclipses and other phenomena, and even the customary predictions of the weather. The original manuscript is still in the possession of his family.

From his earliest years, he seems to have had an ardent love of reading, and he has been heard to say that, even when quite young, he read through the whole of Chambers's Cyclopaedia, in two large folio volumes, without omitting a single article.

He sailed on his first voyage, on the 11th of January, 1795, at the age of twenty-two, in the capacity of captain's clerk, on board the ship *Henry*, of Salem, owned by Elias Hasket Derby, Esq., and commanded by Captain Henry Prince, who still lives to glory in the fame of his clerk. Captain John Gibaut, with whom young Bowditch had been engaged the year before in taking a survey of Salem, had previously been appointed to the command of the ship, and had invited his friend to accompany him as clerk. He consented; but in consequence of some misunderstanding subsequently springing up between the owner of the ship and Captain Gibaut, he relinquished the command, and of course his agreement with his friend was at an end. Mr. Derby, however, on the appointment of Captain Prince, said to him, "Do you know young Bowditch?" "Yes, very well." "How should you like to have him go in the ship with you?" "I should like it above all things," said the captain. He accordingly went on board as clerk, although his name was entered on the shipping-papers as second mate. The ship sailed for the Isle of Bourbon, and returned home after an absence of exactly one year.

His second voyage was made as supercargo, on board the ship *Astræa*, of Salem, belonging to the same owner, and commanded

by the same captain. The vessel sailed in March, 1796, to Lisbon, touched at Madeira, and then proceeded to Manilla, and arrived at Salem in May, 1797, after an absence of fourteen months.

At Madeira, the captain and supercargo were very politely received by Mr. Pintard, the American consul there, to whose house the ship was consigned, and were frequently invited to dine with his family. Mrs. Pintard had heard from another American shipmaster that the young supercargo was "a great calculator," and she felt a curiosity to test his capacities. Accordingly, she said to him one day at dinner, "Mr. Bowditch, I have a question which I should like to have you answer. Some years since," naming the time, "I received a legacy in Ireland. The money was there invested, and remained some time on interest; the amount was subsequently remitted to England, where the interest likewise accumulated; and lately the whole amount has been remitted to me here. What sum ought I to receive?" She of course mentioned the precise dates of the several remittances, as she went along. Mr. Bowditch laid down his knife and fork, said it was a little difficult, on account of the difference of currency and the number of the remittances; but squeezing the tips of his fingers, he said, in about two minutes, "The sum you should receive is £843 15s. 6¼d." "Well, Mr. Clerk," said Mrs. Pintard to the head clerk of the house, an elderly person, who was esteemed a very skilful accountant, "you have been figuring it out for me on paper; has he got it right?" "Yes, madam," said the clerk, taking his long calculation out of his pocket, "he has got it exactly. And I venture to say, that there is not another man on the island that can do it in two hours."

In August, 1798, he sailed in the same ship with Capt. Prince, on his third voyage, to Cadiz, thence to the Mediterranean, loaded at Alicant, and arrived at Salem in April, 1799.

On the voyage from Cadiz to Alicant, they were chased by a French privateer, and having a strong armament of nineteen guns, they prepared for action. The post assigned to Bowditch was the cabin, and his duty was to hand the powder upon deck. In the midst of the preparations for the engagement, Captain Prince had a curiosity to look into the cabin, and see whether all things were going on right there; and, to his astonishment, he found Bowditch calmly sitting at the table, with his slate and pencil, and figuring away, as usual. The thing was so ludicrous,

that Captain Prince burst out laughing, and said, "Well, Mr. Bowditch, can you be making your will now?" "Yes," was his good-natured reply. After this affair, (the French privateer having hauled off without molesting them,) the supercargo requested to be stationed at one of the guns, and his request was granted. Captain Prince testifies, that in all cases of danger, he manifested great firmness and presence of mind.

The fourth and last voyage which they made together, was in the same ship from Boston to Batavia and Manilla. They sailed in August, 1799, and returned home in September, 1800.

On their arrival at Manilla, a Scotchman, by the name of Murray, asked Captain Prince how he contrived to find the way there, through such a long, perplexing, and dangerous navigation, and in the face of the northeast monsoon, by mere dead reckoning, without the use of lunars,—it being a common notion at that time, that the Americans knew nothing about working lunar observations. Captain Prince told him that he had a crew of twelve men, every one of whom could take and work a lunar observation as well, for all practical purposes, as Sir Isaac Newton himself, were he alive. Murray was perfectly astounded at this, and actually went down to the landing-place, one Sunday morning, to see this *knowing* crew come ashore.

Mr. Bowditch was present at this conversation, and as Captain Prince says, sat "as modest as a maid," said not a word, but held his slate-pencil in his mouth. Another person on the island, a broker, by the name of Kean, who was present, said to Murray, "If you knew as much as I do about that ship *Astræa*, you wouldn't talk quite so glib." "Why not? what do you know about her?" "Why, sir, I know that there is more knowledge of navigation on board that ship, than there ever was in all the vessels that ever floated in Manilla Bay."

The knowledge which these common sailors had acquired of navigation, had been imparted to them by the kindness of Mr. Bowditch. Captain Prince relates that one day the supercargo said to him, "Come, Captain, let us go forward and see what the sailors are talking about, under the lee of the long-boat." They went forward, accordingly, and the Captain was surprised to find the sailors, instead of spinning their long yarns, earnestly engaged with book, slate and pencil, and discussing the high matters of tangents and secants, altitudes, dip, and refraction. Two of them,

in particular, were very zealously disputing, one of them calling out to the other, "Well, Jack, what have you got?" "I've got the *sine*," was the answer. "But that an't right," said the other. "I say it is the *cosine*."

Captain Prince says, that although Mr. Bowditch had such a thorough knowledge of navigation, he knew but little about what is technically called *seamanship*. He also mentions the fact, which he had often heard him repeat, that although, in his youth, he had long lived in the vicinity of the ship-yards, he had never seen a launch; and rather scouted the idea that such a sight, or any thing like it, should be able to draw him away from his books. Captain Prince likewise testifies that during the whole course of these four voyages, he does not recollect the slightest interruption of harmony and good feeling between them.

I am happy to be able to corroborate the statements of Captain Prince, by the testimony of an officer in our navy, who sailed in the *Astræa* the two last voyages to Alicant and Batavia. In a letter recently written, after speaking in terms of the warmest gratitude of the kindness and attention with which Mr. Bowditch treated him, when a poor sea-sick cabin-boy, and acknowledging his great obligations to him for instructing him in navigation, he goes on to say that it was Mr. Bowditch's practice to interest himself in all the sailors on board, and to take pains to instruct all who could read and write, in the principles of navigation. The consequence of this was, that every one of a crew of twelve men, who could read and write, subsequently rose to the rank of captain or chief mate of a ship. Indeed, at Salem, it was considered the highest recommendation of a seaman, that he had sailed in the same ship with Mr. Bowditch, and this circumstance alone was often sufficient to procure for him an officer's berth. In illustration of this statement, he mentions the fact that on his second voyage, the first and second mates had been sailors in the same ship on the previous voyage. He also speaks of Mr. Bowditch's urbane and gentlemanly deportment to every one on board, and says that he never appeared so happy as when he could inspire the sailor with a proper sense of his individual importance, and of the talents he possessed, and might call into action.

Some idea of the extent to which a knowledge of navigation was diffused among the seamen of Salem, chiefly by the influence of Mr. Bowditch, may be gained from the following nautical

anecdote which is contained in the fourth volume of Baron von Zach's "*Correspondance Astronomique*," page 62. The Baron is relating the sensation caused at Genoa, by the arrival there, in 1817, of that splendid packet, the "Cleopatra's Barge," owned by George Crowninshield, Esq. of Salem. He says that he went on board with all the world, "and it happened," to use his own words, "that in inquiring after my friends and correspondents at Philadelphia and Boston, I mentioned, among others, the name of Mr. Bowditch. 'He is a friend of our family and our neighbor at Salem,' replied the captain, a smart, little old man, 'and that young man whom you see there, my son, was his pupil; in fact, it is he, and not myself, who navigates the ship. Question him a little, and see if he has learnt any thing.' Our dialogue was as follows:—'You have had an excellent teacher of navigation, young man; and you could not well help being a good scholar. In making the Straits of Gibraltar, what was the error in your reckoning?' The young man replied, 'Six miles.' 'You must then have got your longitude very accurately; how did you get it?' 'First by our chronometers, and afterwards by lunar distances.' 'What! do you know how to take and calculate the longitude by lunar distances?' The young captain seemed somewhat nettled at my question, and answered me with a scornful smile—'I know how to calculate the longitude! Why, our *cook* can do *that!*' 'Your *cook!*' Here the owner of the ship and the old captain assured me that the cook on board could calculate the longitude very well, that he had a taste and passion for it, and did it every day. 'There he is,' said the young man, pointing with his finger to a negro at the stern of the ship, with a white apron before him, and holding a chicken in one hand and a butcher's knife in the other. 'Come forward, Jack,' said the captain to him; 'the gentleman is surprised that you can calculate the longitude; answer his questions.' I asked him, 'What method do you use to calculate the longitude by lunar distances?' His answer was, 'It's all one to me: I use the methods of Maskelyne, Lyons, Witchell, and Bowditch; but, upon the whole, I prefer Dunthorne's; I am more used to it, and can work with it quicker.' I could not express my surprise at hearing this black face talk in this way, with his bloody chicken and knife in his hand. 'Go,' said Mr. Crowninshield to him, 'lay down your chicken, bring your books and your journal, and show the gentleman your cal-

culations.' The cook soon returned with his books under his arm. He had Bowditch's Practical Navigator, the Requisite Tables, Hutton's Tables of Logarithms, and the Nautical Almanac. I saw all this negro's calculations of the latitude, the longitude, and the true time, which he had worked out on the passage. He answered all my questions with wonderful accuracy, not in the Latin of the caboose, but in the good set terms of navigation."

Capt. Prince relates a little incident that occurred under his observation, that is worth preserving. In the year 1796, there was an Englishman in Boston, who called himself a professor of mathematics. He boasted a great deal about his mathematical knowledge, and said that he had not found any body in this country who knew any thing about the science. "I have a question," said he, "which I have proposed to several persons here who are reputed the most knowing, and they cannot solve it." This Englishman was a friend of E. H. Derby, Jr. of Salem, to whom Capt. Prince had some time previously said that he thought Mr. Bowditch "the greatest calculator in America." Mr. Derby and the Englishman being one evening at the theatre, and the latter repeating the remark about his question, "Well," says Mr. Derby, "there is a young man sitting opposite in that box, who, I think, will do it for you. You had better hand it over to him." Accordingly, after the play was over, the problem was brought to the house where Capt. Prince and Mr. Bowditch boarded, by a man named Hughes, who asked him whether he thought he could solve it. "Yes," was his instantaneous reply. The next morning Hughes called and asked him how he was getting along with the question. "I've done it," says Mr. Bowditch, "and I wish you would tell the Englishman that the answer is the logarithm of such a number," naming it. In addition to this, I have heard that the American mathematician said, "Tell your friend that I have got a question which puzzled me once a good while before I could make it out, and I should like to have him try his hand upon it." He gave him the question, and it was handed over to the Englishman; but nothing more was heard of it. For once, he had probably got enough of mathematics.

Capt. Prince states some facts in relation to the origin of one of Mr. Bowditch's principal works, which will be interesting to all, particularly to all seafaring men. Every thing relating to "The Sailor's Own Book," must be acceptable to them. He states,

that on the day previous to their sailing on their fourth and last voyage together, Mr. Edmund M. Blunt, a noted publisher of charts and nautical books, then residing at Newburyport, came to Boston, where the ship lay, on purpose to see Mr. Bowditch. In the course of the conversation between them, which Capt. Prince overheard, Mr. Blunt said, "If you had not corrected the declination, I should have lost the whole of the last edition;" meaning the last edition of John Hamilton Moore's book on Navigation, then in common use on board our vessels. "Why," continued he, "can't you be good enough to look over Hamilton Moore again, more carefully? Take a copy of it with you, and mark whatever you may find; and when you get home, I will give you a new one." "Well," replied Mr. Bowditch, "I will." On the home passage Capt. Prince says that Mr. Bowditch remarked to him, "Now I am going to assist Blunt, and begin with Hamilton Moore." When he had been engaged upon it several days, Capt. Prince passed by him in the cabin, and said, "Well, sir, you seem to put a great many black marks on Johnny Moore." "Yes," replied Mr. Bowditch, "and well I may, for he deserves it; his book is nothing but a tissue of errors from beginning to end." After he had been hard at work for some time, Capt. Prince said to him, "If I were you, I would sooner make a new book than undertake to mend that old thing." Mr. Bowditch smiled and said, "I find so many errors that I intend to take out the work in my own name." Capt. Prince closed the conversation by adding, "I think you ought to do so, for the work will be new, and the fruit of your own labor, and will be the best work on navigation ever published;" a prediction that was wonderfully fulfilled to the letter.

As an illustration of the dangerous blunders of Moore's work, I will mention a fact related to me by John Waters, Esq. of Boston. He states that in the beginning of the year 1800, he was returning from Canton in the ship *Eliza*, and that somewhere this side of the Cape (he thinks off the West India Islands,) in taking the sun's declination one day, they turned to Moore's "Table XVII. of The Sun's Declination for the years 1792, 1796, 1800, 1804," to which he had appended the remark, "*each being leap year.*" In consequence of thus erroneously making 1800 a leap year, he gives the declination on the 1st of March  $7^{\circ} 11'$ , whereas by reference to the Nautical Almanac of that



year, it will be found to be  $7^{\circ} 33'$ , making a difference of twenty-three miles. Mr. Waters fortunately had a Nautical Almanac on board, and likewise a copy of Pike's Arithmetic, which explained the reason *why* the year 1800 was *not* leap year. In consequence of this he escaped the dangers to which other vessels in the same latitude were subjected; for he afterwards read in the newspapers of several ships that were wrecked solely by reason of that blunder. It was, indeed, quite time for Hamilton Moore to be laid up, high and dry, on the shelf.

Before publishing his own work, Mr. Bowditch had prepared for Mr. Blunt two corrected editions of Moore's book, in which he had actually discovered and corrected *eight thousand* errors in the nautical tables, as he himself testifies in the preface to the last stereotype edition.

Such was the germ of "The New American Practical Navigator," the first edition of which he issued in the year 1800, at the age of twenty-seven; a work abounding with the actual results of his own experience, and containing simpler and more expeditious formulas for working the nautical problems. This work has been of immense service to the nautical and commercial interests of this country. Had Dr. Bowditch never done any thing else, he would still, by this single act, have conferred a lasting obligation upon his native land; and the national legislature might well acknowledge it by erecting a monument to his memory. Just consider the simple fact, that every vessel that sails from the ports of the United States, from Eastport to New Orleans, is navigated by the rules and tables of his book. And this has been the case nearly ever since its publication, thirty-eight years ago. Notwithstanding the competition of other English and American works on the subject, "The Practical Navigator" has never been superseded. It has kept pace with the progress of nautical science, and incorporated all its successive discoveries and results; and the last edition, published within the last year, contains new tables and other improvements, which will probably secure its undivided use by our seamen for years to come.

In compiling "The Navigator," he was essentially aided by a series of manuscript journals, preserved in the East India Museum, at Salem. It is one of the regulations of the East India Marine Society, to whom that splendid collection belongs, that each member shall keep a journal of every thing remarkable

that has occurred, and that he has observed, during his voyage. On his return his journal is examined by a special committee, who extract whatever they think valuable, and copy it into large volumes, kept for that purpose. Dr. Bowditch was accustomed to say, that these volumes contained a mass of nautical information that could be found no where else in the world.

The quiet and leisure of the long East India voyages, when the ship was lazily sweeping along under the steady impulse of the trade-winds, afforded him fine opportunities for pursuing his mathematical studies, as well as for indulging his taste for general literature. It was at these times that he learnt the French and Spanish languages, without any instructor. Subsequently in life he acquired the German and the Italian.

I have heard it stated, that, on the voyage to Manilla, the ship sprung a leak, and was obliged to put into the Isle of France to refit. Young Bowditch was the only one on board who knew any thing about French, having learnt it from his grammar on the voyage; and this casual knowledge thus proved of essential service to the interests of the owners, as well as to the crew of the ship. He used to say, that nothing that he learnt ever came amiss.

He had previously commenced the study of Latin at the age of seventeen. The first Latin book that he undertook to read was a copy of Euclid's Geometry, which had formerly belonged to the Rev. Dr. Byles, of Boston, and having been purchased at the sale of his books, was presented to the young mathematician by his brother-in-law, David Martin, of Salem. The following words I copy from the blank leaf in the beginning of the book, "Began to study Latin Jan. 4, 1790." He afterwards read and translated Newton's "Principia," a copy of which book, rare, doubtless, at that time in this country, had come into his possession through the kindness of the learned and reverend Dr. Bentley of Salem. Dr. Bentley told him that he could not give him the book, as it had been presented to him by a friend, but said he would loan it to him, and that he might keep it till it was called for. He did keep it; it was never called for; and it is still among his books.

What he once learned he ever afterwards remembered, and it may be mentioned as an instance of the singular tenacity of his memory, that, on lately reading the splendid History of the Reign

of Ferdinand and Isabella,\* the last book he read through, and one for which he expressed the highest admiration, he remarked that many of the incidents in it were quite familiar to him, he having once read the great work of Mariana on the History of Spain, in the original language, in the course of one of his voyages. The French mathematician, Lacroix, acknowledged to a young American, that he was indebted to Mr. Bowditch for communicating many errors in his works, which he had discovered in these same long India voyages.

The extraordinary mathematical attainments of the young sailor soon became known, and secured to him the notice of our most distinguished men,—among others that of the late Chief Justice Parsons, himself an eminent mathematician,—and likewise the deserved, yet wholly unexpected, honors of the first literary institution in the land. In the summer of 1802, at the age of twenty-nine, his ship lying wind-bound in Boston harbor, he went out to Cambridge to attend the exercises of Commencement Day; and whilst standing in one of the aisles of the church, as the President was announcing the honorary degrees conferred that day, his attention was aroused by hearing his own name called out as a Master of Arts. The annunciation came upon him like a peal of thunder; it took him wholly by surprise. He has been heard to say that that was the proudest day of his life; and that of all the distinctions which he subsequently received from numerous learned and scientific bodies, at home and abroad,† (among which may be mentioned his election, in

---

\* By WILLIAM H. PRESCOTT, Esq. of Boston. This noble contribution to the youthful literature of our country is, at the same time, one of the most remarkable instances, in literary history, of the triumph of genius over difficulties and discouragements. It seems almost incredible, that so extensive a work, demanding the perusal of so many books, and the consultation of so many authorities, could have been composed without the full and free use of the eyes. And yet it is a fact known to me, that the author, although he wrote the book through with his own hand, never saw the words while he was writing them. His work is a noble evidence of his perseverance as well as of his learning and good taste, and reflects honor upon himself as well as upon his country.

† Dr. Bowditch was elected a Fellow of the American Academy of Arts and Sciences, in 1799, and was its President from 1829 to the time of his death. He was also a Fellow of the Royal Societies of Edinburgh and Dublin; of the Astronomical Society of London; of the American Philosophical Society held at Philadelphia; of the Connecticut Academy of Arts and Sciences; of the Literary and Philosophical Society of New York; Corresponding member of the Royal Societies at Berlin, Palermo, &c. &c. &c.

1818, as a Fellow of the Royal Society of London, an honor to which few Americans have attained,) there was not one which afforded him half the pleasure, or which he prized half so highly, as this degree from Harvard. It was, indeed, his first honor, his earliest distinction; it was not only kindly meant, but timely done; and it no doubt stimulated him to perseverance in his scientific pursuits, as well as created that interest which he always took in the prosperity of that institution.\*

Mr. Bowditch's fifth and last voyage was made in the ship Putnam, of which he was part owner, and in which he sailed in the combined capacities of master and supercargo. He sailed for Sumatra in November, 1802, and returned in December, 1803. His habits of life and study, when on shipboard, are thus related by one who accompanied him in his two last voyages in the capacity of a seaman and mate.

"His practice was, to rise at a very early hour in the morning, and pursue his studies till breakfast; immediately after which, he took a rapid walk for an hour, and then went below to his studies till half past eleven o'clock, when he returned and walked till twelve o'clock, the hour at which he commenced his meridian observations. Then came dinner, after which he was engaged in his studies till five o'clock; then he walked till tea time, and, after tea, was at his studies till nine o'clock in the evening. From this hour till half past ten o'clock, he appeared to have banished all thoughts of study, and, while walking, he would converse in the most lively manner, giving us useful information, intermixed with amusing anecdotes and hearty laughs, making the time delightful to the officers who walked with him, and who had to quicken their pace to accompany him. Whenever the heavenly bodies were in distance to get the longitude, night or day, he was sure to make his observations once, and frequently twice, in every twenty-four hours, always preferring to make them by the moon and stars on account of his eyes. He was often seen on deck at other times, walking rapidly, and apparently in deep thought, when it was well understood, by all on board, that he was not to be disturbed, as we supposed he was solving some difficult problem, and when he darted below, the conclusion was,

---

\* Mr. Bowditch was a Fellow of the Corporation of Harvard from 1826 till his death. He received the degree of LL. D. from the same University in 1816.

that he had got the idea ; if he were in the fore part of the ship, when the idea came to him, he would actually run to the cabin, and his countenance would give the expression, that he had found a prize."

On quitting the sea, in 1803, he was appointed President of the Essex Fire and Marine Insurance Company in Salem, the duties of which he continued to discharge till the year 1823. During this time he was frequently solicited to accept posts of honor and emolument in various literary institutions, in different parts of the country. Though his salary as President of the Insurance Company was small, being only twelve hundred dollars, yet the larger offers from a distance could not induce him to leave his blessed New England home. Thus in 1806, he was chosen to fill the Hollis Professorship of Mathematics at Harvard University. In 1818, he received a letter from Mr. Jefferson, requesting him to accept the Professorship of Mathematics in the new University at Charlottesville, in Virginia. Mr. Jefferson said in his letter, "We are satisfied we can get from no country a Professor of higher qualifications than yourself for our mathematical department." And in 1820, on the death of Mr. Ellicott, Professor of Mathematics at the United States' Military Academy at West Point, he received a letter from Mr. Calhoun, then Secretary of War, desiring him to permit his name to be presented to the President to fill the vacant chair. Mr. Calhoun in that letter said, "I am anxious to avail myself of the first mathematical talents and acquirements to fill the vacancy."

In the year 1806, Mr. Bowditch published his accurate and beautiful chart of the harbors of Salem, Beverly, Marblehead, and Manchester, the survey of which had occupied him during the summers of the three preceding years. So minutely accurate was this chart, that the old pilots said he had found out all their professional secrets, and had put on paper points and bearings which they thought were known only to themselves. They began to fear that their services would no longer be needed, and that their occupation and their bread were gone.

On the establishment of "The Massachusetts Hospital Life Insurance Company," in 1823, he was elected to the office of Actuary, being considered the person best qualified for this highly responsible station, from his habits of accurate calculation and rigid method, and his inflexible integrity. Immediately on

accepting the office he removed to Boston, at the age of fifty, and there spent the last fifteen years of his life. On his leaving Salem, a public dinner was given him by his fellow citizens, as a testimony of their respect. No man ever left that place more regretted.

It scarcely needs to be stated that he discharged the duties of his high trust with the greatest fidelity and skill, and to the entire satisfaction of the Company. The capital was five hundred thousand dollars. But, at his suggestion, the Company applied to the Legislature for additional power to hold in trust and loan out the property of individuals. This power was granted; and upwards of five millions of dollars, nine tenths of which belong to females and orphans, have been thus received and invested. The institution has, in this way, been of incalculable service, it being in fact nothing more nor less than a Savings Bank on a large scale. "Providence"—I use his own language, in his parting letter to the Directors—"has seen fit to bless our efforts to make it an institution deserving of public regard." It deserves to be mentioned, that Dr. Bowditch was never willing to receive and tie up any investment, without himself seeing or hearing in writing from the person in whose behalf the investment was to be made, and ascertaining that it was done with his or her full and free consent, and that the individual perfectly understood the mode and conditions of the investment, before it was put into the *dead hand* of the institution.

I may here also notice the fact, that during the late unexampled commercial embarrassments and financial difficulties, when almost all our moneyed institutions have sustained heavy losses from the bankruptcies of their debtors, "and," to use his own words in the same letter, "by having dealt with corporations, whose affairs have been managed with a recklessness which has never before been witnessed in this country," yet so carefully and skillfully have the affairs of The Life Office been managed, that, although the largest moneyed institution in New England, having a capital equal to ten common banks, and with a loan out of six millions, its loss has not been greater than that sustained by some of the smallest banks.

It was a hard struggle for Dr. Bowditch to break away from the pleasant scenes and associations of his native place. There were his earliest friends, and there his strongest ties. But he felt

that he owed it to his family to make the sacrifice of personal attachments and preferences; and for some time he and his amiable consort fondly cherished the hope of returning and spending their last days in the City of Peace.

In March, 1798, just before sailing on his third voyage, he married his first wife, Elizabeth Boardman, who died during his absence at the age of eighteen. In October, 1800, he was married to his cousin, Mary Ingersoll, a lady of singular sweetness of disposition and cheerful piety, who, by her entire sympathy with him in all his studies and pursuits, lightened and cheered his labors, and by relieving him from all domestic cares, enabled him to go on, with undivided mind and undistracted attention, in the execution of the great work, on which his fame, as a man of science, rests. He has been heard to say, that he never should have accomplished the task, and published the book in its present extended form, had he not been stimulated and encouraged by her. When the serious question was under consideration as to the expediency of his publishing it at his own cost, at the estimated expense of ten thousand dollars, (which it actually exceeded,) with the noble spirit of her sex, she conjured and urged him to go on and do it, saying that she would find the means, and gladly make any sacrifice and submit to any self-denial that might be involved in it. In grateful acknowledgment of her sympathy and aid, he proposed, in the concluding volume, to dedicate the work to her memory—a design than which nothing could be more beautiful or touching. Let it still be fulfilled.\*

It is hardly necessary for me to say that this was a Translation and Commentary on the great work of the French astronomer, La Place, entitled "*Mécanique Céleste*," in which that illustrious man undertakes to explain the whole mechanism of our solar system, to account on mathematical principles for all its phenomena, and to reduce all the anomalies in the apparent motions and figures of the planetary bodies, to certain definite laws.

La Place himself, in his Preface, states the object of his work as follows. "Towards the end of the seventeenth century, Newton published his discovery of universal gravitation. Mathema-

---

\* This noble-minded and excellent woman, whose unflinching cheerfulness and vivacity rendered her admirably suited to be the wife of such a man, died in Boston, on the 17th of April, 1834, in the 53d year of her age.

ticians have since that epoch, succeeded in reducing to this great law of nature all the known phenomena of the system of the world, and have thus given to the theories of the heavenly bodies and to astronomical tables, an unexpected degree of precision. My object is to present a connected view of these theories, which are now scattered in a great number of works. The whole of the results of gravitation, upon the equilibrium and motions of the fluid and solid bodies, which compose the solar system, and the similar systems, existing in the immensity of space, constitute the object of *Celestial Mechanics*, or the application of the principles of mechanics to the motions and figures of the heavenly bodies. Astronomy, considered in the most general manner, is a great problem of mechanics, in which the elements of the motions are the arbitrary constant quantities. The solution of this problem depends, at the same time, upon the accuracy of the observations, and upon the perfection of the analysis. It is very important to reject every empirical process, and to complete the analysis, so that it shall not be necessary to derive from observations any but indispensable data. The intention of this work is to obtain, as much as may be in my power, this interesting result."

It is a work of great genius and immense depth, and exceedingly difficult to be comprehended. This arises not merely from the intrinsic difficulty of the subject, and the medium of proof employed being the higher branches of the mathematics,—but chiefly from the circumstance that the author, taking it for granted that the subject would be as plain and easy to others as to himself, very often omits the intermediate steps and connecting links in his demonstrations. He jumps over the interval, and grasps the conclusion as by intuition. Dr. Bowditch used to say, "I never come across one of La Place's '*Thus it plainly appears*,' without feeling sure that I have got hours of hard study before me to fill up the chasm, and find out and show *how* it plainly appears."

Dr. Bowditch says, in his Introduction to the first volume, "The object of the author, in composing this work, as stated by him in his Preface, was to reduce all the known phenomena of the system of the world to the law of gravity, by strict mathematical principles; and to complete the investigations of the motions of the planets, satellites, and comets, begun by Newton in his *Principia*. This he has accomplished, in a manner deserving the highest praise, for its symmetry and completeness; but from the



abridged manner, in which the analytical calculations have been made, it has been found difficult to be understood by many persons, who have a strong and decided taste for mathematical studies, on account of the time and labor required to insert the intermediate steps of the demonstrations, necessary to enable them easily to follow the author in his reasoning. To remedy in some measure, this defect, has been the chief object of the translator in the Notes."

It was in the year 1815, at Salem, that he began this herculean task, and finished it in two years. The Commentary, which exceeds the original in extent, kept pace with the Translation; but whilst the publication was in hand, his alterations and additions were so numerous that it might almost be considered a new draft of the work.

Let it not be said, in disparagement of the labors of Dr. Bowditch, that this was not an original work, but merely a translation. Suppose that it had been so. What then? Was it not still a benefaction to this country and to Great Britain, thus to bring it within the reach and compass of the American and English mind? It is truly said by an old writer, "So well is he worthy of perpetual fame that bringeth a good work to light, as is he that first did make it, and ought always to be reckoned the second father thereof." But the fact is, it is more than half an original commentary and exposition, simplifying and elucidating what was before complex and obscure, supplying omissions and deficiencies, fortifying the positions with new proofs and giving additional

---

\* The only attempts that have been made in England to grapple with the great work of La Place are, 1. "An Elementary Treatise upon Analytical Mechanics, being the First Book of the *Mécanique Céleste* of La Place; translated and elucidated with Explanatory Notes, by the Rev. John Toplis, B. D., London. 1814." 8vo.—2. "Elementary Illustrations of the Celestial Mechanics of La Place, [by Thomas Young, M. D.] London. 1821." 8vo.—3. "A Treatise on Celestial Mechanics, by P. S. La Place; translated from the French, and elucidated with Explanatory Notes, by Rev. Henry H. Harte, Fellow of Trinity College, Dublin. Part First, Book First, 1822. Book Second, 1827. Dublin." 4to.

It is highly honorable to the sex, that the best, may I not say the only *Exposition* of La Place's work that has appeared in England, is from the pen of a female, the accomplished MARY SOMERVILLE, wife of Dr. Somerville, of Chelsea Hospital. The Edinburgh Review said of her work, entitled "The Mechanism of the Heavens," "This unquestionably is one of the most remarkable works that female intellect ever produced, in any age or country; and with respect to the present day, we hazard little in saying that Mrs. Somerville is the only individual of her sex in the world who could have written it."

weight and efficiency to the old ones; and above all, recording and digesting the subsequent discoveries, and bringing down the science to the present time. I have heard it said that La Place, to whom Dr. Bowditch sent a list of errors, (which however he never had the grace to acknowledge in any way,)\* once remarked, "I am sure that Mr. Bowditch comprehends my work, for he has not only detected my errors, but he has also shown me how I came to fall into them."

The manner in which he published this work affords a striking illustration of the spirit of independence, which was a prominent feature in his character. He had been frequently solicited and urged by his numerous wealthy friends, and by eminent scientific men, and formally requested by the American Academy of Arts and Sciences, to permit them to print it at their expense, for the honor of the country, and for the cause of science. He was well aware, however, that there was not sufficient taste in the community for such studies to justify an enterprise which would involve a great outlay, and, as he thought, would bring him under pecuniary obligations to others. I recollect conversing with him once on this subject, when he said to me, in his usual ardent way, "Sir, I did not choose to give an opportunity to such a man (mentioning his name) to point up to his book-case and say, 'I patronized Mr. Bowditch by subscribing for his expensive work,'—not a word of which he could understand. No, I preferred to wait till I could afford to publish it at my own expense. That time at last arrived; and if, instead of setting up my coach, as I might have done, I see fit to spend my money in this way, who has any right to complain? My children I know will not."

On the publication of the first volume, the London Quarterly Review, expressed the following high opinion of its merits. "The

---

\* This, possibly, may have been an inadvertence, or the letter of acknowledgment may have miscarried on the way. It is certain that his widow received the son of the American mathematician with great kindness and consideration, when in the year 1833, he went to Paris to pursue his medical studies, carrying out with him the second volume of his father's work. He was immediately invited to a splendid *soirée*, and on entering the brilliant saloon, filled with the *savans* of France, he was unexpectedly greeted by seeing on the centre table,—the only thing on it,—the identical volume which he had brought over with him—a delicate compliment, which none but a graceful French woman would have thought of paying. Madame La Place subsequently sent to Dr. Bowditch a noble colossal bust of her husband.

idea of undertaking a translation of the whole 'Mécannique Céleste,' accompanied throughout with a copious running commentary, is one which savors, at first sight, of the *gigantesque*, and is certainly one which, from what we have hitherto had reason to conceive of the popularity and diffusion of mathematical knowledge on the opposite shores of the Atlantic, we should never have expected to have found originated—or, at least, carried into execution, in that quarter. The first volume only has as yet reached us; and when we consider the great difficulty of printing works of this nature, to say nothing of the heavy and probably unremunerated expense, we are not surprised at the delay of the second. Meanwhile the part actually completed (which contains the first two books of La Place's work) is, with few and slight exceptions, just what we could have wished to see—an exact and careful translation into very good English—exceedingly well printed, and accompanied with notes appended to each page, which leave no step in the text of moment unsupplied, and hardly any material difficulty either of conception or reasoning unelucidated. To the student of 'Celestial Mechanism,' such a work must be invaluable, and we sincerely hope that the success of this volume, which seems thrown out to try the feeling of the public, both American and British, will be such as to induce the speedy appearance of the sequel. Should this unfortunately not be the case, we shall deeply lament that the liberal offer of the American Academy of Arts and Sciences, to print the whole at their expense, was not accepted. Be that as it may, it is impossible to regard the appearance of such a work, even in its present incomplete state, as otherwise than highly creditable to American science, and as the harbinger of future achievements in the loftiest fields of intellectual prowess."

The first volume of the work was published in the year 1829, the second in 1832, and the third in 1834, each volume containing about a thousand quarto pages. The fourth volume was nearly completed at the time of his decease. He persevered to the last in his labors upon it, preparing the copy and reading the proof-sheets in the intervals when he was free from pain. The last time I saw him, a few days previous to his death, a proof-sheet was lying on his table, which he said he hoped to be able to read over and correct.

The publication of the book proved, as he anticipated, and as I have already mentioned, a very expensive undertaking, it being one of the largest works and most difficult of execution ever printed in this country, and at the same time one of the most beautiful specimens of typography.

Though it met with more purchasers than the author ever expected, still the cost was a heavy draught upon his income, and an encroachment on his little property. Yet it was cheerfully paid; and besides that, he gladly devoted his time, his talents, and may I not add, his health and his life, to the cause of science and the honor of his native land. That work is his monument. *Si monumentum quæris, aspice librum.\** He needs no other monument; and at the same time it is the most precious and honorable legacy that he could bequeath to his children.

Among the numerous services which Dr. Bowditch rendered to the cause of good learning and the diffusion of useful knowledge, after he came to Boston, was the deep and active interest which he took in the Boston Athenæum. When, in 1826, the Perkins family, in that liberal spirit which has ever characterized them, gave to the Athenæum sixteen thousand dollars, on condition that an equal sum should be raised from other sources, Dr. Bowditch exerted himself to the utmost to accomplish the object. Many of the best friends of the institution thought the enterprise a hopeless one, and were indisposed even to make an attempt to raise the amount. But Dr. Bowditch said, "It is a good thing, let us try it; if we fail, we fail in a good cause." He called personally on many individuals to solicit subscriptions, and chiefly in consequence of his exertions, the additional sum of twenty-seven thousand dollars was raised.

The permitting the books to be taken out of the library was another measure proposed and effected by him. Strenuous opposition was made to it; but he believed and said that the circulation of the books would make the library ten times more useful, and he persevered till he accomplished the measure. It was always a favorite object with Dr. Bowditch to render books easily accessible to those who wanted them, and could make a good use of them. He doubtless remembered the difficulties under which

---

\* I have ventured to alter a little and apply to Dr. Bowditch, the well-known epitaph on Sir Christopher Wren, beneath the dome of St. Paul's Cathedral, London:—"SI MONUMENTUM QUÆRIS, CIRCUMSPICE."

he labored in early life for want of books, and was disposed to obtain for others the advantages which had been extended to himself.

Immediately after his election as Trustee of the Athenæum, in 1826, Dr. Bowditch, perceiving the paucity and poverty of the scientific department of the library, which might all be put into one small compartment,—“*dum tota domus rhedâ componitur unâ*,”—declared that “it was too bad, and a disgrace to the institution and to Boston.” He accordingly set about supplying the deficiency, by collecting subscriptions for this express purpose. Col. T. H. Perkins gave \$500, his brother James the same amount, Dr. Bowditch himself \$250, and other gentlemen \$100 apiece. With this sum were purchased the Transactions of the Royal Societies of London, Dublin, and Edinburgh, of the French Academies and Institute, of the Academies of Berlin, Göttingen, St. Petersburg, Turin, Lisbon, Madrid, Stockholm, and Copenhagen; forming, as Dr. Bowditch once told the librarian, “the most extensive and complete collection of philosophical and scientific works on this continent.”

Dr. Bowditch also took a deep interest in the “Boston Mechanics’ Institution,” which was established in 1826, and of which he was elected the first President, January 12, 1827. In 1828, more than a thousand dollars was subscribed for the purchase of philosophical apparatus, chiefly through his influence with his friends, and he headed the list with the sum of one hundred dollars. On resigning the Presidency, in 1829, he was elected first honorary member of the institution.

Dr. Bowditch was likewise an honorary member of the Massachusetts Charitable Mechanic Association. On the 3d of April a Eulogy on their departed associate was pronounced before that body by the author of this Memoir, on which day the flags of all the shipping in the port were hauled to half-mast by direction of the Boston Marine Society, of which he was likewise a member. His sense of the honor thus conferred on him by these elections, and his affectionate regard for these Societies, and for the city of his adoption, will be best seen by the following extract from his Will:—

“And, in respect to Boston, the home of my adoption, where, as a stranger, I met with welcome, and where I have ever continued to receive constantly increasing proofs of kindness and re-

gard, I should have been most happy to have made a similar acknowledgment of my gratitude, by legacies to those literary and charitable institutions for which that city has always been so preëminently distinguished. And, in particular, it would have given me pleasure to have noticed the Boston Marine Society, of which I am a member, and the Boston Charitable Mechanic Association, which has placed my name on its small and select list of honorary members; since these institutions are of a similar character to the Marine Societies in Salem, and have, for one of their important objects, that of affording valuable aid to the destitute families of deceased members. But the pecuniary circumstances of my estate do not permit it."

In delineating the character of Dr. Bowditch, it deserves to be mentioned, first of all, that he was eminently a self-taught and self-made man. He was the instructor of his own mind, and the builder up of his own fame and fortunes. Whatever knowledge he possessed,—and we have seen that it was very great,—was of his own acquiring, the fruit of his solitary studies, with but little, if any, assistance from abroad. Whatever eminence he reached, in science or in life, was the product of his untiring application and unremitting toil. From his youth up, he was a pattern of industry, enterprise, and perseverance, suffering no difficulties to discourage, no disappointments to dishearten him.

Within a few years, a very interesting work has been published in England, under the patronage of the Society for the Diffusion of Useful Knowledge, entitled "The Pursuit of Knowledge under Difficulties." Dr. Bowditch deserves a place in that work, if any man does, and had he died before its appearance, he would, unquestionably, like our countryman Franklin, have occupied a prominent chapter. We sometimes hear persons say, how much they would do, if they only had the means and the opportunities. But almost any body can work with means and opportunities. It is the privilege and characteristic of genius to work without means, to be great in spite of them, to accomplish its object in the face of obstacles and difficulties.

It would be interesting and instructive, had we space for it, to draw a parallel and contrast between the lives, characters and scientific attainments of Franklin and Bowditch, unquestionably the two greatest proficients in science that America has produced.

Both rose from obscure situations in humble life, and from the straits of poverty. Both left school at the age of ten years, to assist their fathers in their shops. Both had an early and passionate love of reading, and the vigils of both often "prevented the morning." Both had the same habits of industry, perseverance and temperance. The contrast between their characters would be still more striking than the resemblance.

It was my good fortune, some years since, in one of those familiar interviews with him in his own house with which I was favored,—and which those who have once enjoyed them will never forget,—to hear him narrate, in detail, a history of his early life. From that day to this, I have never ceased to regret that, on my return home, I did not instantly put it down upon paper, for the refreshment of my own memory, and for the benefit of others. At this distance of time, I can recollect but a few, the most striking, particulars; the rest have faded away and are lost. I remember, however, very distinctly, his relating the circumstance which led him to take an interest in the higher branches of mathematical science. He told me that, in the year 1787, when he was fourteen years old, an elder brother of his, who followed the sea, and was attending an evening school, for the purpose of learning navigation, on returning home one evening, informed him that the master had got a new way of doing sums and working questions; for, instead of the numerical figures commonly used in arithmetic, he employed the letters of the alphabet. This novelty excited his curiosity, and he questioned his brother very closely about the matter; who, however, did not seem to understand much about the process, and could not tell how the thing was done. But the master, he said, had a book, which told all about it. This served to inflame his curiosity; and he asked his brother whether he could not borrow the book of the master, and bring it home, so that he might get a sight at it. (It should be remembered that, at this time, mathematical books of all sorts were scarce in this country. In the present multitude of elementary works on this subject, we can hardly conceive of the dearth that then prevailed.) The book was obtained. It was the first glance that he had ever had at algebra. "And that night," said he, "I did not close my eyes." He read it, and read it again, and mastered its contents, and copied it out from beginning to end. Subsequently, he got hold of a volume of the *Philosophical Trans-*

actions of the Royal Society of London, which he treated pretty much in the same summary way, making a very full and minute abstract of all the mathematical papers contained in it; and this course he pursued with the whole of that voluminous work. He was too poor at this time to purchase books, and this was the only mode of getting at their results, and having them constantly at hand for consultation. These manuscripts, written in his small, close, neat hand, and filling several folio volumes, are now in his library, and, in my opinion, are the most curious and precious part of that large and valuable collection.

I have more than once heard him speak in the most grateful manner,—and he repeated it the last time that I saw him,—of the kindness of those friends in Salem who aided him in his early studies by the loan of their books. He named particularly the late eminent Dr. Prince,\* the pastor of the First Church, who gave him free access to his library; and he likewise mentioned a society of gentlemen who had a private collection of their own. The manner in which these latter books came into the country, is so remarkable, that I am happy to be able to relate it in Dr. Bowditch's own words, as contained in his last Will. The extract is as follows:—

“*Item.* It is well known, that the valuable scientific library of the celebrated Dr. Richard Kirwan† was, during the revolutionary war, captured in the British Channel, on its way to Ireland, by a Beverly privateer; and that, by the liberal and enlightened views of the owners of the vessel, the library thus captured was sold at a very low rate; and in this manner was laid the foundation upon which have since been successively established, The Philosophical Library, so called, and the present Salem Athenæum. Thus, in early life, I found near me a better collection of philosophical and scientific works than could be found in any other part of the United States nearer than Philadelphia. And by the kindness of its proprietors I was permitted freely to take

---

\* It is gratifying to find the clergy, the scientific Dr. Prince, and the learned Dr. Bentley, the earliest encouragers of the precocious powers of the American mathematician. It has always been so. The Christian clergy have, from the beginning down to this day, not only been themselves among the most learned men of their times, but have always been the fosterers of early talent, and the patrons of unfriended genius.

† The Rev. Richard Kirwan was a native of Ireland, and was distinguished for his attainments in mineralogy and chemistry. His principal work was his *Elements of Mineralogy*, published in 1784. He died in 1812.



books from that library and to consult and study them at pleasure. This inestimable advantage has made me deeply a debtor to the Salem Athenæum; and I do therefore give to that Institution the sum of one thousand dollars, the income thereof to be for ever applied to the promotion of its objects and the extension of its usefulness."

I have two remarks to make on this singularly interesting extract. In the first place, it seems to me there was something like a special providence in the capture of that library, consisting of such a peculiar class of books, by a Beverly vessel, and its being brought into the port of Salem rather than any other port in the United States. Here was apparent design, the fitting of means to ends. The books came exactly to the place where they were wanted; to the only place, probably, in the country where they were wanted. They came, too, at the right time, just in season to be used by the person who could make the best possible use of them, and to whom they were, above all computation, valuable and necessary. If this be not an act of Providence, I hardly know what is.

The good Dr. Kirwan mourned, no doubt, over the loss of his books, and not least of all that they had become so utterly misplaced and useless. He probably thought that the vessel which contained them might as well have been wrecked on the coast of Africa, and the leaves of his philosophical works employed to adorn the heads and persons of the Caffres and Hottentots, a use to which we are told "The Practical Navigator" was once put by the inhabitants of one of the South Sea islands.\* But had the learned philosopher known that his lost library had supplied the intellectual food for the growth of one of the greatest scientific men of his age, he might, perhaps, have become reconciled to his loss.†

---

\* "It happened that among the few articles saved from the ship, [the whale-ship *Mentor*, of New Bedford,] was a copy of 'Bowditch's Navigator;' an article of as little use as we can conceive any one thing to have been at that place. But the ingenuity of the females, who also have their passion for ornaments, tore out the leaves of the book, and making them into little rolls of the size of one's finger, wore them in their ears, instead of the tufts of grass which they usually employed to give additional attractions to their native charms."—*American Quarterly Review of Holden's Narrative*, Vol. XX, p. 25.

† Since the above was written, I have learnt that the gentleman into whose hands Dr. Kirwan's library fell, offered to remunerate him for the loss which he had sustained. He however declined receiving any compensation, and expressed himself gratified that his books had fallen into such good hands.

My other remark is, that this item in his Will is an indication of a very prominent feature in his character, namely, his grateful and generous spirit. Dr. Bowditch never forgot a favor; length of time did not obliterate it from his memory. The kindness shown him when a poor boy he remembers and repays by a liberal legacy. The Salem Marine Society, a mutual charitable institution, which had aided his father in his straits by the small annual stipend of fifteen dollars, he repays, and wipes off the obligation, though not his sense of the benefit, by a similar bequest of a thousand dollars. And the East India Marine Society, whose peculiar and splendid collection of curiosities is so well known, receives a legacy of the same amount. And let it be remembered that these were not the donations of a rich man. He was far from being one. These three legacies constituted one tenth part of his whole personal property. Others sometimes give to such institutions from their abundance—he from his comparative penury. Let the deed be an example and an incitement to our wealthy men!

Dr. Bowditch combined, in a very remarkable degree, qualities and habits of mind which are usually considered incompatible and hostile. He was a contemplative, recluse student, and at the same time, an active, public man. He lived habitually among the stars, and yet, I doubt not, he seemed to many never to raise his eyes from the earth. He was a profound philosopher, and at the same time, a shrewd, practical man, and one of the most skilful of financiers. Judging from his published works, you would suppose that he could have no taste nor time for business or the world; and judging from the large concerns which he managed, and the vast funds of which he had the supervision,—involving the most complex calculations and the most minute details,—you would say that he could have no taste nor time for study. His example is a conclusive proof and striking illustration of the fact, that there is no inherent, essential, necessary incompatibility between speculation and practice—that there need be no divorce between philosophy and business. The man most deeply engaged in affairs need not be cut off from the higher pursuits of intellectual culture; and the scholar need not be incapacitated by his studies from understanding and engaging in the practical details of common life. In fact, they should be blended in order to make up the full, complete man. Contemplation should be always united

with action. This was the doctrine and the practice of the great father of inductive philosophy, as well as of this his illustrious pupil. "That," says Lord Bacon, "will indeed dignify and exalt knowledge, if contemplation and action may be more nearly and strongly conjoined and united together than they have been,—a conjunction like unto that of the two highest planets, Saturn, the planet of rest and contemplation, and Jupiter, the planet of civil society and action." And speaking of himself in another place, he says, "We judge also that mankind may conceive some hopes from our example; which we offer not by way of ostentation, but because it may be useful. If any one therefore should despair, let him consider a man as much employed in civil affairs as any other of his age,—a man of no great share of health, who must therefore have lost much time,—and yet, in this undertaking, he is the first who leads the way, unassisted by any mortal, and steadfastly entering the true path, that was absolutely untrod before, and submitting his mind to things, may somewhat have advanced the design."

In the management of all his affairs and transactions, Dr. Bowditch was a man of great order and system, and he required it of all with whom he had to do, or over whom he exercised any control. He considered that there was a sort of moral virtue in this, and he could not tolerate any thing like negligence or irregularity. He doubtless had himself acquired this habit from the nature of his favorite study, which demands the undivided attention of the mind, and is peculiarly suited to form habits of exactness and precision. He felt, too, that it was by a strict and undeviating adherence to order and system, that he had been enabled to accomplish so much in life, to unite the scholar with the financier, the speculative with the practical man. It may have been thought by some, that he carried this love of order to an extreme, and sometimes visited too harshly the deviations from the straight line of his directions. But he felt assured that it was the way to effect the most work and do the greatest good; he knew that the habit could be easily formed in a short time, and that it would then approve and recommend itself; and therefore he would admit of no apology for infractions of his rules.

In the common sense of the word, Dr. Bowditch would not be called a public man, although I have ventured to call him so; for though he twice held a seat in the Executive Council of

Massachusetts, under the administrations of Governors Strong and Brooks, yet he had no taste for public life, no ambition for political honors. He could not be drawn from "the still air of delightful studies," to mingle in the turmoil and strife of politics. And yet he was a true-hearted and sound patriot, and not a whit the less so for not being a noisy one. He loved his country, and prized her peculiar institutions. He felt a deep interest in the welfare and honor of his native State, and would do any thing to maintain the supremacy of the laws, and preserve the peace and order of the community. He had a remarkably sound and sober mind, good sense being one of its most prominent qualities. Accordingly, he could have no sympathy with those visionary reformers who would jumble society into its original elements, and bring back ancient chaos again, in order to get a chance to try their hand at making the very best possible commonwealth out of the fragments. No. He valued the lessons of experience, and prized the gathered wisdom of ages. He had faith in other men's intelligence, as well as his own, and trusted in the light that had been reflected from a thousand brilliant minds who had pored and pondered over the great questions of government and civil polity, and given us their results in laws and institutions.

Dr. Bowditch thought, with Governor Winthrop, in his noble apology for himself, that "there is a great mistake in the country about liberty. There is a two-fold liberty; natural, and civil or federal. The first is common to man with beasts and other creatures. By this, man, as he stands in relation to man simply, hath liberty to do what he lists; it is a liberty to evil as well as to good. This liberty is incompatible and inconsistent with authority, and cannot endure the least restraint of the most just authority. The exercise and maintaining of this liberty makes men grow more evil, and, in time, to be worse than brute beasts: 'omnes sumus licentiâ deteriores.' This is that great enemy of truth and peace, that wild beast, which all the ordinances of God are bent against, to restrain and subdue it. The other kind I call civil, or federal; it may also be termed moral, in reference to the covenant between God and man, in the moral law, and the politic covenants and constitutions, amongst men themselves. This liberty is the proper end and object of authority, and cannot subsist without it; and it is a liberty to that which is good, just, and honest. This liberty you are to stand for, with the haz-

ard not only of your goods, but of your lives, if need be. Whatsoever crosses this, is not authority, but a distemper thereof. This liberty is maintained and exercised in a way of subjection to authority.”\*

The lawless and flagrant assaults upon property and life which have occurred in this country within a few years past, casting upon its fair name a stain of dishonor, grieved him to the heart, and stirred his spirit within him. Conversing with him about one of the earliest and most wanton and unprovoked of these outrages,—I mean the conflagration of a religious house in the vicinity of Boston, inhabited solely by women and children, by a ferocious mob at midnight,—he told me that had he been summoned, or had an opportunity, he would readily have shouldered his musket, and marched to the spot, and stood in defence of that edifice to the last drop of his blood. There was nothing, indeed, that stirred his indignation like oppression.†

Immediately after this outrage, he called on the Catholic bishop in Boston, and put into his hands a sum of money, to buy clothes for the women and children, who had lost every thing in the flames. It is an agreeable circumstance, well worth recording, that as soon as the bishop heard of Dr. Bowditch’s illness, he sent and informed the family, that, to prevent his being disturbed, the bell of the cathedral, which is in the vicinity of his house, should not be rung during his illness, although it was the season of Lent, and religious services were going on almost every day. It is pleasant to see kindness thus reciprocated between divergent sects, and the middle wall of separation broken down by the humane and grateful feelings of a common nature.

Why is it, that all the youthful talent of this country is rushing madly into political life? To how many of these aspirants may we apply, with literal truth, the remark of Lord Bacon, in reference to himself, that “they were born and intended for literature, rather than any thing else, and, by a sort of fatality, have been drawn, contrary to the bent of their own genius, into the walks of public life.”‡ Is it not a great mistake, on their part, to sup-

---

\* Winthrop’s History of New England, II. 229.

† “The Ursuline Convent,” on Mount Benedict, in Charlestown, about two miles from Boston, was burnt on the night of the 11th of August, 1834.

‡ Ad literas potius quam ad aliud quicquam natus, et ad res gerendas, nescio quo fato, contra genium suum abreptus.—*De Aug. Sci. Lib. 8. Cap. 3.*

pose that politics is the only or the principal avenue to enduring fame? Is the science of government the only one worth studying, or are civil honors the only ones worth aspiring to? It seems to me that the young men of competent abilities among us, who aim at distinction, those certainly who have leisure and property, might quite as securely seek it in the retired and quiet walks of science and literature, as in the bustling and dusty paths of political life. Are the names of Newton and Milton less eminent than those of Chatham and Fox? Do they not stir the spirit as soon? ay, even as soon as those of Marlborough and Wellington? Are Cuvier and La Place names less likely to live than those of the statesmen and marshals of France? Which are the two greatest names in our own annals, the best known and the most honored the world over? First, Washington; then Franklin; and the latter chiefly as a philosopher, from his attainments and discoveries in science.

The example and success of Dr. Bowditch are full of incitement and encouragement to our young men in this particular, and should especially stimulate those who have leisure and fortune, to do something to enable our country to take a respectable place in science and letters among the other nations of the earth; so that the stigma shall not adhere to us of being a race of unlettered republicans. Let them look, too, at more than one recent and successful attempt among us in the department of history.\* How much may they not accomplish? And into what pleasant fields will they not be led? Into the various departments of natural history, the different walks of exact science, the rich and instructive annals of our own country, and the delightful province of general literature and philosophy. Let them labor in this field, which will reward all their efforts, instead of delving in a stony and sterile soil.

I have no fear that the path of politics will be deserted, or that the republic will suffer detriment from the absence of candidates for its offices and emoluments. Alas! these will always be too attractive; and what we chiefly need is some counteracting influence, some striking example, like that of Dr. Bowditch, to con-

---

\* Mr. Prescott's "History of the Reign of Ferdinand and Isabella, the Catholic," already alluded to, and Mr. George Bancroft's "History of the United States." These are very important and honorable contributions to the growing literature of our country; and we rejoice that we can claim them as the works of New-England men.

vince our young men that political life is not the only road to eminence, nor the only adequate and honorable sphere for the exercise and display of their talents. For affording us this evidence, his memory deserves to be honored, and his name to be held in everlasting remembrance.

Dr. Bowditch was a remarkably domestic man. His affections clustered around his own fireside, and found their most delightful exercise in his "family of love," as he called it in almost his last moments. His attachment to home, and to its calm and simple pleasures was, indeed, one of the most beautiful traits in his character, and one which his children and friends will look back upon with the greatest satisfaction. As Sir Thomas More says of himself, "he devoted the little time which he could spare from his avocations abroad, to his family, and spent it in little innocent and endearing conversations with his wife and children; which, though some might think them trifling amusements, he placed among the necessary duties and business of life; it being incumbent on every one to make himself as agreeable as possible to those whom nature has made, or he himself has singled out for, his companions in life."\*

His time was divided between his office and his house; and that must have been a strong attraction, indeed, that could draw him into company. When at home, his time was spent in his library, which he loved to have considered as the family parlor. By very early rising, in winter two hours before the light, "long ere the sound of any bell awoke men to labor or to devotion," and "in summer," like Milton, "as oft with the bird that first rises or not much tardier," he was enabled to accomplish much before others were stirring. "To these morning studies," he used to say, "I am indebted for all my mathematics."† After taking

---

\* "Dum foris totum ferme diem aliis impertior, reliquum meis, relinquo mihi, hoc est literis, nihil. Nempe, reverso domum, cum uxore fabulandum est, garriendum cum liberis, colloquendum cum ministris. Quæ ego omnia inter negotia numero, quando fieri necesse est, (necesse est autem nisi velis esse domi tuæ peregrinus,) et danda omnino opera est, ut quos vitæ tuæ comites aut natura providit, aut fecit casus, aut ipse delegisti, his ut te quam jucundissimum compares."—*Preface to Utopia.*

† He might literally apply to himself the apology of the great Roman orator, "Quare quis tandem me reprehendat, aut quis mihi jure succenseat, si quantum cæteris ad suas res obeundas, quantum ad festos dies ludorum celebrandos, quantum ad alias voluptates, et ad ipsam requiem animi et corporis conceditur temporis; quantum alii tribuunt tempestivis conviviis; quantum denique aleæ, quantum pilæ; tantum mihi egomet ad hæc studia recolenda sumpsero?"

his evening walk he was again always to be found in the library, pursuing the same attractive studies, but ready and glad, at the entrance of any visitor, to throw aside his book, unbend his mind, and indulge in all the gayeties of his light-hearted conversation.

There was nothing that he seemed to enjoy more than this free interchange of thought on all subjects of common interest. At such times the mathematician, the astronomer, the man of science, disappeared, and he presented himself as the frank, easy, familiar friend. One could hardly believe that this agreeable, fascinating companion, who talked so affably and pleasantly on all the topics of the day, and joined so heartily in the quiet mirth and the loud laugh, could really be the great mathematician who had expounded the mechanism of the heavens, and taken his place with Newton, and Leibnitz, and La Place, among the great proficient in exact science. To hear him talk, you would never have suspected that he knew any thing about science, or cared any thing about it. In this respect he resembled his great Scottish contemporary, who has delighted the whole world by his writings. You might have visited him in that library from one year's end to another, and yet, if you or some other visitor did not introduce the subject, I venture to say, that not one word on mathematics would cross his lips. He had no pedantry of any kind. Never did I meet with a scientific or literary man so entirely devoid of all cant and pretension. In conversation he had the simplicity and playfulness and unaffected manners of a child. His own remarks "seemed rather to escape from his mind than to be produced by it." He laughed heartily, and rubbed his hands, and jumped up, when an observation was made that greatly pleased him, because it was natural for him so to do, and he had never been schooled into the conventional proprieties of artificial life, nor been accustomed to conceal or stifle any of the innocent impulses of his nature.

Who that once enjoyed the privilege of visiting him in that library, can ever forget the scene? Methinks I see him now, in my mind's eye, the venerable man, sitting there close by his old-fashioned blazing wood fire, bending over his favorite little desk, looking like one of the old philosophers, with his silvery hair, and noble forehead, and beaming eye, and benign countenance; whilst all around him are ranged the depositories of the wisdom and



science of departed sages and philosophers, who seem to look down upon him benignantly from their quiet places, and spontaneously and silently to give forth to him their instructions. On entering this, the noblest repository of scientific works in the country, I almost fancy I hear him saying with Heinsius, the keeper of the library at Leyden, "I no sooner come into my library, than I bolt the door after me, excluding ambition, avarice, and all such vices; and, in the very lap of eternity, amidst so many divine souls, I take my seat with so lofty a spirit and such sweet content, that I pity all the great and rich who know not this happiness."

It may be here remarked, that although mathematics was his chief and favorite pursuit, Dr. Bowditch still had a taste and love for general literature. He was fond of Shakspeare and Milton, and remembered and could repeat whole passages from their works. He loved, too, the poetry of Burns and our own Bryant and Sprague. Many of his favorite pieces he not only had by heart, but also had them written down, for convenience' sake, on the covers of his mathematical common-place book. I recollect, among others, thus copied off, "The Cotter's Saturday Night," a selection which evinced at the same time his good feeling and his good taste. I also recollect observing on the covers and blank leaves of his copy of Newton's Principia many commendatory verses on Newton, selected from Voltaire and other French poets.

But I must hasten on to speak, as briefly and comprehensively as I can, of what is the most important part of every man—namely, his moral and religious character—the qualities of his heart, and his principles of action.

Dr. Bowditch was a man of unsullied purity, of rigid integrity, and uncompromising principle. Through life, truth seems to have been at once the great object of his pursuit, and his ruling principle of action. "FOLLOW TRUTH," might have been the motto on his escutcheon. "*Truth! Truth! Truth!*" were among his last words to one whom he dearly loved. He was himself perfectly transparent. A child could see through him. There was no opaqueness in his heart, any more than in his intellect. It was as clear as crystal, and the rays of moral truth were transmitted through it without being refracted or tinged. In all his intercourse and transactions he was remarkably frank and candid. He revealed himself entirely. He had no secrets. He kept noth-

ing back, for he had nothing to conceal. He lived openly, and talked freely, of himself, and of his doings, and of every thing that was uppermost in his mind. He never hesitated to speak out what he thought on all subjects, public and private, and he avowed his opinions of men and things with the utmost freedom and unconcern. It seemed to me that he never had the fear of man before his eyes, and that it never checked, in the least, the free and full utterance of his sentiments.

Dr. Bowditch was perfectly fair and just in the estimate which he formed of his own capacities and gifts. He did not, on the one hand, overrate his talents; nor, on the other hand, did he, as some do, with a sort of back-handed humility, purposely undervalue his powers, in order to enjoy the pleasure of being contradicted by those about him and told that he was really a much greater man than he seemed willing to admit. As an illustration of this, let me mention a little conversation of his. "People," said he, "are very kind and polite, in mentioning me in the same breath with La Place, and blending my name with his. But they mistake both me and him; we are very different men. I trust I understand his works, and can supply his deficiencies, and correct his errors, and render his book more intelligible, and record the successive advancements of the science, and perhaps append some improvements. But La Place was a genius, a discoverer, an inventor. And yet I hope I know as much about mathematics as Playfair!"

I have been informed by a gentleman of Boston, that soon after his return from Europe a few years since, he happened, in a conversation with Dr. Bowditch, to mention to him incidentally, the high estimation in which he and his labors were held by men of science abroad, and told him that he had often heard his name spoken of in terms of the strongest commendation by persons in the most elevated walks of society in England. "Dr. Bowditch," says my informant, "seemed to be sensibly affected by my statement, so much so that I saw the tears glisten in his eyes. But he immediately remarked that however flattering such testimonials might be, yet the most grateful tribute of commendation he had ever received was contained in a letter from a backwoodsman of the West, who wrote to him to point out an error in his Translation of the *Mécanique Céleste*. 'It was an actual error,' said the Doctor, 'which had escaped my own observation. The

simple fact that my work had reached the hands of one on the outer verge of civilization, who could understand and estimate it, was more gratifying to my feelings than the eulogies of men of science and the commendatory votes of Academies.”

He was a singularly modest man. He made no pretensions himself and there was nothing that he so much despised in others. He was remarkably simple in all his manners and intercourse with the world. He put on no airs and assumed no superiority on the ground of his intellectual attainments, but placed himself on a level with every one with whom he had any concern. He revered integrity and truth wherever he found them, in whatever condition in life. He felt and showed no respect for mere wealth or rank. He fearlessly rebuked, to his face, the mean and purse-proud nabob, and “condescended to men of low estate.”

Dr. Bowditch used to relate a little anecdote concerning himself, which strongly and beautifully illustrates the childlike simplicity and naturalness of his character.

In the year 1824, when General Lafayette, in his progress through the country, among other places, visited Boston, the mayoralty of the city was filled by the Honorable Josiah Quincy. Dr. Bowditch, in common with all the world, had a curiosity to behold the entrance of the nation's guest into the city; and accordingly accepted an invitation from a friend, whose house was in Colonnade Row, to take a station on his balcony. But finding that the chariot wheels tarried, and the General delayed his coming, he thought that he should have time to go down to his office to transact a little business, and return in season for the spectacle. But, in the mean time, the procession had arrived and passed on, and was fast advancing to State street. He concluded, therefore, to wait where he was, and, in order to get a nearer and better view, took his stand on the steps of the United States' Bank. On the appearance of the barouche in which Lafayette was seated, Dr. Bowditch remarked, that he was glad to see Mr. Quincy at his side; he was the proper man for that place, being the son of one of the earliest and best of the patriots of the Revolution. “As the shout of the multitude rose unto heaven,” he said, “I know not how it happened, but I could not keep my place; my hat would not stay on my head, nor could I hold my tongue. And to my astonishment, I found myself, all at once, in the midst of the crowd by the side of the chariot, and shouting with the

rest at the top of my voice." The President of Harvard University recollects distinctly seeing him in the position and attitude thus described.

At first sight there may seem something ludicrous and puerile in this grave philosopher and calculator, this votary of abstract science, huzzaing in a mixed crowd on a city's holiday. But to me it seems a most natural and beautiful expression of his simplicity, his self-forgetfulness, his utter unconsciousness of greatness, his generous sympathy with the people, and his grateful and ardent patriotism. This little incident cannot fail to raise him in the estimation of every right-minded and single-hearted man.

Dr. Bowditch was a truly conscientious man. He was always true to his moral as well as intellectual convictions, and followed them whithersoever they led. He had great faith in the rectitude of his moral perceptions, and in the primary decision of his own judgment and moral sense; and he carried them forth and acted them out instantly. The word followed the thought, and the deed the feeling, with the rapidity of lightning. This straightforwardness and frankness were among the secret causes of the remarkable influence which he confessedly exercised over the minds and judgments of others. By his honesty, as well as by his resoluteness and decision, he was the main-spring of every thing with which he was connected. By his moral influence he controlled and swayed all men with whom he was associated. As Ben Jonson says of Lord Bacon, "he *commanded* where he spoke."

Dr. Bowditch was a man of ardent natural feelings, and of an impetuous temperament. A venerable lady, after her first interview with him, said, "I like that man, for he is a *live* man." He was strong in his attachment to men and to opinions, and was not easily turned from any course of speculation or action, which he had once satisfied himself was right; wise and good. At the same time, he always kept his mind open to evidence; and if you brought before him new facts and arguments, he would reconsider the subject—deliberately, not hastily—and *the next day*, perhaps, would tell you that you were in the right, and that he had altered his mind. He was sometimes quick, warm, and vehement in expressing his disapprobation of the character or conduct of an individual, particularly if he thought that the person had practiced any thing like duplicity or fraud. In such cases, his indignation

was absolutely scorching and withering. But he never cherished any personal resentments in his bosom. He did not let the sun go down upon his wrath. His anger was like a cloud, which passes over the disk of the moon, and leaves it as mild and clear as before; or, as the judicious Hooker's was represented to be, "like a vial of clear water, which, when shook, beads at the top, but instantly subsides, without any soil or sediment of uncharitableness."

Let me relate an incident illustrative of this remarkable trait in his character. Dr. Bowditch had been preparing a plan of Salem, which he intended soon to publish. It had been the fruit of much labor and care. By some means or other, an individual in the town had surreptitiously got possession of it, and had the audacity to issue proposals to publish it as his own. This was too much for Dr. Bowditch to bear. He instantly went to the person, and burst out in the following strain: "You villain! how dare you do this? What do you mean by it? If you presume to proceed any farther in this business, I will prosecute you to the utmost extent of the law." The poor fellow cowered before the storm of his indignation, and was silent; for his wrath was terrible. Dr. Bowditch went home, and slept on it; and the next day, hearing from some authentic source, that the man was extremely poor, and had probably been driven by the necessities of his family to commit this audacious plagiarism, his feelings were touched, his heart relented, his anger melted away like wax. He went to him again, and said, "Sir, you did very wrong, and you know it, to appropriate to your own use and benefit the fruit of my labors. But I understand you are poor, and have a family to support. I feel for you, and will help you. That plan is unfinished, and contains errors that would have disgraced you and me, had it been published in the state in which you found it. I'll tell you what I will do. I will finish the plan; I will correct the errors; and then you shall publish it for your own benefit, and I will head the subscription list with my name."

What a sublime, noble, christian spirit was there manifested! This was really overcoming evil with good, and pouring coals of fire upon the poor man's head. The natural feeling of resentment, which God has implanted within all bosoms for our protection against sudden assault and injury, was overruled and conquered by the higher, the sovereign principle of conscience.

Dr. Bowditch was, in all his habits of life, a very regular and temperate man. He never tasted any wine till the age of thirty-five. He approved the remarkable changes which have been effected in the customs of society, within a few years, by "the temperance reform," and he heartily rejoiced in the success of that good cause. God bless it and speed it!

In his religious views, Dr. Bowditch was, from examination and conviction, a firm and decided Unitarian. His parents were Episcopalians, and he himself had been educated in the tenets of that church. But he had no taste for the polemics or peculiarities of any sect, and did not love to dwell on the distinctive and dividing points of christian doctrine. His religion was rather an inward sentiment, flowing out into the life, and revealing itself in his character and actions. It was at all times, and at all periods of his life, a controlling and sustaining principle. He confided in the providence and benignity of his Heavenly Father, as revealed by his blessed Son, our Lord, and had the most unshaken confidence in the wisdom and rectitude of all the divine appointments. He looked forward with firm faith to an immortality in the spiritual world.

He said to one, in his last illness, "From my boyhood my mind has been religiously impressed. I never did or could question the existence of a Superintending Being, and that he took an interest in the affairs of men. I have always endeavored to regulate my life in subjection to his will, and studied to bring my mind to an acquiescence in his dispensations; and now, at its close, I look back with gratitude for the manner in which he has distinguished me, and for the many blessings of my lot. I can only say, that I am content, that I go willingly, resigned, and satisfied." To another he said, "I cannot remember when I had not a deep feeling of religious truth and accountableness, and when I did not act from it, or endeavor to. In my boyish days, when some of my companions who had become infected with Tom Paine's infidelity, broached his notions in conversation with me, I battled it with them stoutly, not exactly with the logic you would get from Locke, but with the logic I found *here*, (pointing to his breast,) and here it has always been, my guide and support; it is my support still. My whole life, has been crowned with blessings beyond my deserts. I am still surrounded with blessings unnumbered. Why should I distrust the goodness of God?"

Why should I not still be grateful and happy, and confide in his goodness?"

Dr. Bowditch was very familiar with the Scriptures, both of the Old and New Testaments, more so than some professed theologians who make it their special study. He had read the Bible in his childhood, under the eye of a pious mother, and he loved to quote and repeat the sublime and touching language of Holy Writ.

Such had been the life, and such the character of this distinguished man; and such was he to the last, through all the agonies of a most distressing illness. In the midst of health and usefulness, in the full discharge of the duties of life, and in the full enjoyment of its satisfactions, the summons suddenly comes to him to leave it. And he meets the summons with the utmost equanimity and composure, with the submission of a philosopher and with the resignation of a Christian. He certainly had much to live for—few have more—but he gave up all without repining or complaint. He said he should have liked to live a little longer, to complete his great work, and see his younger children grown up and settled in life. "But I am perfectly happy," he added, "and ready to go, and entirely resigned to the will of Providence." He arranged all his affairs, gave his directions with minuteness, and dictated and signed his last will and testament. While his strength permitted, he continued to attend to the necessary affairs of his office, and on the day previous to his death, put his name to an important instrument. In the intervals of pain, he prepared, as I have already remarked, the remaining copy, and corrected the proof-sheets, of the fourth volume of his great work, the printing of which was nearly finished at the time of his death. It is a little remarkable that the last page that he read was the one thousandth. It was gratifying to him to find that his mind was unenfeebled by disease and pain; and one day, after solving one of the hardest problems in the book, he exclaimed, in his enthusiastic way, "I feel that I am Nathaniel Bowditch still—only a little weaker."

He continued, indeed, in all respects, the same man to the last. He did not think that this was the time to put on a new face or assume a new character. His feelings were unaffected, his manners unchanged, by the prospect before him. He seemed to those about him only to be going on a long journey. To the

end, he manifested the same cheerfulness, nay pleasantry, which he had when in health, without, however, the least admixture of levity. In his great kindness, he exerted himself to see many friends, every one of whom, I believe, will bear testimony to his calm, serene state of mind. The words which he spoke in those precious interviews, they will gather up and treasure in their memory, and will never forget them so long as they live. She certainly will not, to whom, when on her taking leave of him she had said "Good night," he replied, "No, my dear, say not 'Good night,' but 'Good morning,' for the next time we meet will be on the morning of the resurrection."

One day, toward the close of his lingering illness, after he had himself given up all hope of recovery, he asked one who stood by him, what were the two Greek words which signify "easy death." The word not immediately suggesting itself to the person, and he having mentioned over several phrases and combinations of words, Dr. Bowditch said, "No, you have not got the right word; but you will find it in Pope's Correspondence." The person found the letter, which was the last that Dr. Arbuthnot\* wrote to his friend. The conclusion of it is as follows: "A recovery, in my case, and at my age, is impossible. The kindest wish of my friends is *euthanasia*." On hearing this read, Dr. Bowditch said, "Yes, that is the word, *euthanasia*. That letter I read forty years ago, and I have not seen it since. It made an impression on my mind which is still fresh. It struck me, at the time I read it, that the good physician who wrote it would certainly have an easy death. It could not be otherwise. The excellent, the virtuous, must be happy in their death." He afterwards frequently recurred to this subject, and the day previous to his departure, he said, "This is, indeed, *euthanasia*."

Through the whole of his illness he manifested the same happy and delightful frame of mind. His room did not appear like the chamber of sickness and dissolution. The light of his serene

---

\* Dr. Arbuthnot was an eminent physician and brilliant wit in the time of Queen Anne, the contemporary and friend of Swift and Pope. He died in 1735. Dr. Johnson, in his *Life of Pope*, says of him, "Arbuthnot was a man of great comprehension, skillful in his practice, versed in the sciences, acquainted with ancient literature, and able to animate his mass of knowledge by a bright and active imagination; a scholar, with great brilliance of wit; a wit, who, in the crowd of life, retained and discovered a noble ardor of religious zeal; a man estimable for his learning, amiable for his life, and venerable for his piety."



and placid countenance dispelled all gloom, and his cheerful composure robbed death of all its bitterness and anguish. He exemplified in his own case the sentiment so beautifully expressed by the Persian poet, which he loved to repeat:—

“ On parent knees, a naked, new-born child,  
Weeping thou sat'st, whilst all around thee smiled:  
So live, that, sinking in thy last, long sleep,  
Calm thou may'st smile, when all around thee weep.”

He did not wish to see those about him look sad and gloomy. On one occasion he said, “ I feel no gloom within me; why should you wear it on your faces?” And then he called for Bryant's Poems, and desired them to read his favorite piece, “ The Old Man's Funeral.”

“ Why weep ye then for him, who, having won  
The bound of man's appointed years, at last,  
Life's blessings all enjoyed, life's labor's done,  
Serenely to his final rest has passed?”

And then he went on and commented on the remaining lines of the poem, pointing out those which he thought were descriptive of himself, and modestly disclaiming others that were commendatory, as not belonging to him; but which all impartial persons would unite in saying were singularly applicable to his character.

On the morning of his death, when his sight was very dim, and his voice was almost gone, he called his children around his bedside, and arranging them in the order of age, pointed to and addressed each by name, and said, “ You see I can distinguish you all; and I now give you all my parting blessing. The time is come. Lord, now lettest thou thy servant depart in peace, according to thy word.” These were his last words. After this, he was heard to whisper, in a scarcely audible tone, the words “ pretty, pleasant, beautiful.” But it cannot be known, whether he was thinking of his own situation as pleasant, in being thus surrounded at such a time by those he loved, or whether he “ snatched a fearful joy” in a glimpse of the spiritual world. Soon after this, he quietly breathed away his soul, and departed. “ And the end of that man was peace.” Such a death alone was wanting to complete such a life, and crown and seal such a character. He died on Friday, the 16th day of March, having nearly completed his 65th year.

The disease of which Dr. Bowditch died was found, by a *post mortem* examination, to be a schirrus in the stomach, a disease of the same type with that which caused the death of Napoleon Buonaparte. For four weeks previous to his death, he could take no solid food, and hardly swallowed any liquid. He suffered, however, but little from hunger, but constantly from thirst; and the only relief or refreshment he could find, was in frequently moistening his lips and mouth with cold water. His frame was consequently exceedingly attenuated, and his flesh wasted away. At intervals his sufferings were so intense, that, as he said, the body at times triumphed over the spirit; but it was only for a moment; and the spirit resumed again and retained its natural and legitimate sovereignty.

He was buried, as he had lived, privately, and without parade or show, on the quiet morning of the Lord's day.\* His funeral was attended only by his family and two others; yet, in the person of the Chief Magistrate, I fancied I saw the Spirit of the Commonwealth doing homage to the talents and virtues of her illustrious son. As the hearse passed along through the silent streets, bearing that precious dust to its last resting-place, the snow-flakes fell upon it, the fit emblems of his purity and worth. And many a wet eye, in the city of his adoption, and in the place of his nativity, and elsewhere, wept for him, and many a heart blessed his memory, and mourned that a friend, and a benefactor, and a good man, had departed.

He has built his own monument, more enduring than marble; and in his splendid scientific name, and in his noble character, has bequeathed to his country the richest legacy. The sailor traverses the sea more safely by means of his labors, and the widow's and the orphan's treasure is more securely guarded, in consequence of his care. He was the Great Pilot who steered all our ships over the ocean; and, though dead, he yet liveth, and speaketh, and acteth, in the recorded wisdom of his invaluable book. The world has been the wiser and the happier that he has lived in it.

He has left an example full of instruction and encouragement to the young, and especially to those among them who are struggling with poverty and difficulties. He has shown them that

---

\* "Funus, sine imaginibus et pompâ, per laudes ac memoriam virtutum ejus celebre fuit."—*Tacitus, Ann. Lib. II. § 73.*

poverty is no dishonor, and need be no hindrance ; that the greatest obstacles may be surmounted by persevering industry and an indomitable will. He has shown them to what heights of greatness and glory they may ascend, by truth, temperance, and toil. He has proved to them that fame need not be sought for solely in political life ; although that is a worthy field, and the country must be served,—and served, too, not by the worst but by the best of men,—not by the factious, the ignorant, the scheming, but by the wisest, the most enlightened, the best accomplished, that we have among us ; by men who dare to tell the people of their duties as well as of their rights ; and who, instead of meanly flattering them for their votes, will boldly speak to them the words of truth and soberness, and point out to them their errors and faults.

Above all, Dr. Bowditch has left us a most glorious and precious legacy in his example of integrity, love of truth, moral courage, and independence. He has taught the young men here, and the world over, that there is nothing so grand and beautiful as moral principle, nothing so sublime as adherence to truth, and right, and duty, through good report and through evil report. He has, indeed, blessed the world greatly by his science and his practical wisdom ; but quite as much, nay, far more, I think, by his upright and manly character. He has taught mankind that reverence for duty, and trust in Providence, and submission to His will, and faith in the rectitude of all His appointments, and a filial reliance upon His love, are sentiments not unworthy nor unbecoming the greatest philosopher. For this we honor and eulogize him ; not for wealth, title, fortune, those miserable outsides and trappings of humanity, but for the qualities of the inner man, which still live, and will live forever. He studied the stars on the earth—may he not now be tracking their courses through the heavens ? Long ere this, perhaps, he knows all the beauties and the mysteries of their tangled mazes—has examined the rings of Saturn and the belts of Jupiter, traversed the milky way, and chased the comet through infinity. Methinks I hear his departing and ascending spirit exclaiming, as it wings its flight upwards, in the language of the beautiful hymn :—

“ Ye golden lamps of heaven ! farewell,  
With all your feeble light :  
Farewell, thou ever-changing moon,  
Pale empress of the night !

And thou, refulgent orb of day !  
 In brighter flames arrayed,  
 My soul, which springs beyond thy sphere,  
 No more demands thine aid.

Ye stars are but the shining dust  
 Of my divine abode,  
 The pavement of those heavenly courts,  
 Where I shall reign with God.

The Father of eternal light  
 Shall there his beams display ;  
 Nor shall one moment's darkness mix  
 With that unvaried day."

#### DR. BOWDITCH'S SCIENTIFIC PAPERS.

The following is a list of the Papers contributed by Dr. Bowditch to the *Memoirs of the American Academy of Arts and Sciences*. It will serve to show the extent of his observations and the variety of his inquiries.

##### VOL. II.

New Method of Working a Lunar Observation.

##### VOL. III.

Observations on the Comet of 1807.

Observations on the Total Eclipse of the Sun, June 16, 1806, made at Salem.

Addition to the Memoir on the Solar Eclipse of June 16, 1806.

Application of Napier's Rule for solving the cases of right-angled spheric trigonometry to several cases of oblique-angled spheric trigonometry.

An estimate of the height, direction, velocity and magnitude of the Meteor that exploded over Weston, in Connecticut, Dec. 14, 1807.

On the Eclipse of the Sun of Sept. 17, 1811, with the longitudes of several places in this country, deduced from all the observations of the eclipses of the Sun, and transits of Mercury and Venus, that have been published in the Transactions of the Royal Societies of Paris and London, the Philosophical Society held at Philadelphia, and the American Academy of Arts and Sciences.

Elements of the orbit of the Comet of 1811.

An estimate of the height of the White Hills in New Hampshire.

On the variation of the Magnetic Needle.

On the motion of a pendulum suspended from two points.

A demonstration of the rule for finding the place of a Meteor, in the second problem, page 218 of this volume.

##### VOL. IV.

On a mistake which exists in the solar tables of Mayer, La Lande, and Zach.

On the calculation of the oblateness of the earth, by means of the observed lengths of a pendulum in different latitudes, according to the method given by La Place in the second volume of his "*Mécanique Céleste*," with remarks on other parts of the same work, relating to the figure of the earth.

Method of correcting the apparent distance of the Moon from the Sun, or a Star, for the effects of Parallax and Refraction.

On the method of computing the Dip of the Magnetic Needle in different latitudes, according to the theory of M. Biot.

Remarks on the methods of correcting the elements of the orbit of a comet in Newton's "Principia," and in La Place's "Mécanique Céleste."

Remarks on the usual Demonstration of the permanency of the solar system, with respect to the Eccentricities and Inclinations of the orbits of the Planets.

Remarks on Dr. Stewart's formula, for computing the motion of the Moon's Apesides, as given in the Supplement to the Encyclopædia Britannica.

On the Meteor which passed over Wilmington in the State of Delaware, Nov. 21, 1819.

Occultation of Spica by the Moon, observed at Salem.

On a mistake which exists in the calculation of M. Poisson relative to the distribution of the electrical matter upon the surfaces of two globes, in vol. 12 of the "Mémoires de la classe des sciences mathématiques et physiques de l'Institut Impérial de France."

Elements of the Comet of 1819.

---

Dr. Bowditch was also the author of the article on Modern Astronomy, in the North-American Review, Vol. XX. pp. 309—366. In the Monthly Anthology, Vol. IV. p. 653, there is a brief account of the Comet of 1806, drawn up by him at the request of the Editors.

---

ART. II.—*Cursory Remarks upon East Florida, in 1838*; by  
Maj. HENRY WHITING, U. S. Army.

PUBLIC attention has most naturally been turned towards Florida for the last two or three years. That peninsula has been the scene of a contest of remarkable character, awakening a curiosity respecting its topography, resources, &c. which has found but scanty means of gratification. Although the first portion of the United States to be permanently occupied, (St. Augustine having been founded in 1564,) and early signalized by political revolutions, military events, and romantic enterprises, yet its history, both statistical and natural, has been but imperfectly understood by us. The Spaniards no doubt had a tolerably accurate knowledge of the interior, which was formerly somewhat extensively occupied by them. Their settlements, however, were much broken up during the insurrectionary movements which immediately preceded the transfer of jurisdiction to the United States, and the majority of them, when that transfer took place, were abandoned, under the influence of strong national prejudices, which led to a distrust or dislike of a new and dissimilar gov-

ernment. Much local information was thus withdrawn. St. Augustine in the east and Pensacola in the west, with some few subsidiary plantations, were all the settlements that came into our possession. The rest was nearly an unoccupied waste. Even a knowledge of the St. John's, the grand artery of the country, had nearly passed away; so much so, that at the commencement of the present campaign (1837-8) the form, extent, and depth of its upper waters were unascertained.

The war which has lately been carried on with the Florida Indians has opened the country generally to observation, and its character will hereafter be better, if not well understood. Our troops have traversed it in almost every direction; nearly all parts have been explored, excepting the interior of the lower parts of the peninsula south of the Okachobee Lake. From the 26th degree of latitude northward, the geography may be laid down with general accuracy. Indeed, United States maps of this character are already in the hands of some of our officers, which will no doubt soon be lithographed.

The river St. John's was early entered into both by the French and the Spaniards, the rise and fall of whose establishments there form an interesting and sanguinary portion of history. At the present time (1838) there is scarcely a dwelling occupied on either of its banks fifty miles above its mouth, though many evidences of former occupancy, such as falling buildings, or fields bearing the marks of having been cultivated, are seen some hundred miles higher up. Many of these farms or plantations were abandoned by the Spaniards at the change of jurisdiction; others were the work of Americans at a later date. But all had shared a common fate at the opening of the present contest. The Indians burnt all the buildings and plundered and massacred all the inhabitants that were not defended by a garrison, and desolation is now seen, where, a few months since, were sugar fields, cotton fields, orange groves, and many other proofs of a thriving population.

This river (St. John's) is in most respects of a remarkable character. It is unlike most if not all of the rivers in North America, having little current at any point of its course, and passing through a country, from its very source, so level in its surface, as scarcely to warrant the expectation of any stream at all. At low stages of the water there is no visible current even in the upper parts of the river, though at high stages it is visible, having perhaps a

movement of one mile an hour. Below Lake George, which is more than two hundred miles from its mouth, the tides have a slight effect, and vary the current accordingly, modified, however, by strong winds. Still, the waters have not any where a stagnant appearance, and if unpalatable, they are so from causes independent of their want of proper agitation. They are uniformly of a dark color, like that of tolerably strong coffee, the bottom scarcely being discoverable even in the shoal parts. The origin of this tint may be various; decomposition of vegetable matter can contribute but little to affect a body of water so large, particularly when a considerable portion of the banks are either savannas or pine bluffs, neither likely to have much agency in this way. Lake Monroe may furnish a chalybeate tincture, as its shores abound in chalybeate earths. The lakes above may bear the same character. The waters do not lose their color when suffered to stand in a vessel and to make deposit of such particles as may be afloat in them.

The St. John's is a large river for some hundred and fifty miles from its mouth, being from three miles to a mile wide nearly as high as Lake George. Thus far it has the appearance of an arm of the sea, and in fact feels the influence of the tides. From Lake George upwards it is comparatively narrow, excepting where it dilates into lakes, and very winding, running perhaps several miles in one mile of a straight line. Lake George has been long known, and Lake Monroe, about sixty miles above, was occupied by our troops the first campaign of the present war. Thence upwards the river was to be explored at the commencement of the present campaign. It was soon penetrated through Lake Jesup to Lake Harvey, and afterwards to Lake Poinsett, about a hundred miles above Lake Monroe.

Charleston and Savannah steamboats ascended with army supplies without difficulty, at the high stage of the waters, to Lake Harvey, which supplies were sent thence by row-barges to Lake Poinsett, where the river ceased to be subservient to the purposes of transportation. This high stage was in the fall; as the winter months set in, the larger boats could ascend no higher than Lake Monroe, until spring rains again raised the level of the waters.

The banks of the river as high as Pilatka, or more than one hundred miles from its mouth, are generally elevated several feet above the water. From that point to Lake George they are com-

paratively low, and are probably mostly submerged at high stages of the water. Between Lake George and Lake Monroe the banks are generally high enough to be dry, excepting where savannas prevail. Wherever the pine-barrens strike upon the river, the banks are eight or ten feet high, with a substratum of shelly soil or rock. To Lake Monroe they are for the most part clothed with a growth of wood—chiefly live oak, pines, and cypress, as high as Lake George; the palmetto or cabbage tree, being largely intermixed thence upwards.

The grey moss clothes nearly all the trees upon the river, excepting the pine and palmetto. These are respected or avoided by this general associate of the trees, from some want of affinity which may not be understood. This moss is a most singular production, having a rank luxuriance little according with its kindred species. It hangs from every bough many yards in length, and wears the appearance at a distance of dingy muslin thrown with a careless grace over every part of the tree, waving to and fro in the breeze and forming a most striking embellishment of the scene; and the effect is not diminished by the presence of the tall and symmetrical palmetto, which rises up some forty or fifty feet perpendicular, like a perfectly wrought column, surmounted by a capital of most appropriate beauty. The moss never throws its foldings over this handsome tree; as we have before remarked, the pine is equally avoided by it. This capricious forbearance with respect to these two kinds of trees, introduces a beautiful variety into the river scene. Where the banks are high and sandy, the pine prevails; where they are low and wet, the cypress—"the melancholy cypress." The live oak, and other miscellaneous trees, prefer the banks of an intermediate character, as also the palmetto. The cypress seems to exclude all associations; no other trees mingle with it, or if they happen to start up along side they are soon overshadowed above by the spreading tops, or crowded out by the cone-like bases below, which last leave only room for the thousand "knees," or sharp excrescences, from one to several feet high, which shoot up like so many dwarf pinnacles.

Ascending the river, which is constantly winding and shifting the point of view, wherever the cypress permits, there the moss is seen in all its sweeping luxuriance. As these trees spring from nearly a water level, and grow to about an equal height, their flat



and spreading tops present nearly a horizontal line, where the green appears in all its depth and freshness. Thence, however, to within a few yards of the ground, the folds of moss, like ample curtains, conceal nearly all from view, leaving the trunks exposed below, which are covered with a whitish bark. This aspect may prevail for half a mile, when the banks may rise and become covered with the live oak, whose angular and scraggy arms give a new appearance to the moss, which is still as luxuriant as on the cypress. But the outline above is far different here. Palmettos perhaps raise their graceful heads above the oaks in striking contrast with their associates; or perhaps the pine may show in the barren beyond; while over all is the clear azure of the sky, always in Florida

“So purely dark, and darkly pure.”

These changeful beauties, combined with the occasional sight of a wild orange-grove, with its golden fruit bespangling the foliage, altogether render a trip up the St. John's delightful in a high degree.

The ash, poplar, swamp oak, &c., which line the banks of a part of the upper St. John's, drop their leaves during the winter months, unlike all the other trees to which we have been alluding. But these trees would seem to be deciduous, to exhibit more plainly the verdant parasite which attaches itself to most of their branches. In passing up the river for the first time, the uninstructed gazer is surprised and puzzled to see on all these trees a tuft of evergreen, while the branches in general are stripped of their foliage, until informed that it is the mistletoe, which, having attached itself thus to a foreign stock, continues to smile in verdure, while its supporter is standing in gloomy nakedness. The mistletoe bough is always of a rounded form, varying in size from a few inches to thirty or more in diameter. The seeds, which are said to be winged, have a gluten surrounding them, which enable them to attach themselves where they alight and at once to draw forth nourishment as if fixed to a parent stem. The *nullius filius* of the forest, it is adopted by the first tree to which it flies for protection and sustenance.

Sulphur springs are very abundant on the upper parts of the St. John's. They bubble up like *jets d'eau*. In passing up to Lake Monroe, there is one a few miles below, which attracted,

among others, the notice of Bartram. An inlet on the right bank is seen, nearly of the width of the river, which at once attracts the eye, by the contrast between the color of its waters and that of the river. Two pieces of lumber, placed at right angles with each other, one of mahogany and the other of yellow pine, could not be more dissimilar. And the liquid line of separation is almost as distinct as it would be in the supposed case. The St. John's has here, as elsewhere, its coffee-like hue, while the waters of the sulphureous inlet are as transparent as the air, the fishes swimming in them being nearly as discernible as the birds flying over their surface. The alligators, diving, as usual, at the approach of a boat, when they happen to take refuge in this limpid inlet, continue to struggle downwards in apprehension, as if they felt that it did not afford the usual refuge.

Ascending this inlet several hundred yards, it is found to terminate in a well head or basin, of some thirty feet diameter, with high banks, in the centre of which there is a prominent turmoil of the waters, as if a fountain below threw up its contents with much force. Rowing the boat upon this agitated spot, it was with difficulty kept there in its position, against the efforts of the ebullition to throw it off. A strong odor of sulphur fills the air around, and the taste of the waters is equally sulphureous.

Above Lake Monroe, wide-spread savannas become prevalent. They form the main body of the section of country through which the St. John's flows, and are so slightly inclined, that its course is extremely tortuous, the bends having more the shape of a horse shoe, than of a segment of a circle. The immediate banks in these savannas are somewhat elevated above the level of the waters, as the growth of a wild cane indicates, but the greater portion of them bear a tall, rank grass, which shows that it is often inundated, and that the soil is constantly saturated with moisture. Lakes George, Monroe, Jesup, Harvey and Poinsett, are fine sheets of clear water, of no great depths, but generally free from aquatic vegetation. They all abound in fish and wild fowl.

Fort Taylor, (a mere stockade, like all the other forts in Florida of recent origin,) which was built a few miles above Lake Poinsett, three hundred and fifty miles or more from the mouth of the St. John's, is the highest point to which the army boats ascended. Above that post, the river narrowed and shoaled, so as to become

useless for all purposes of transportation. The army there took its course southwardly, reaching the head waters of the St. John's, some seventy or eighty miles S. S. E. The source of this river has been in question up to this time, having been supposed to be connected either with the everglades or the sea. Both of these suppositions are now at an end. The strip of land between the coast and the St. John's, as far south as Cape Florida, has been sufficiently explored, to determine the fact, that it has no channel connection with the sea in that quarter; and it has been equally ascertained, by various army movements, that it is also without a like connection with the everglades or the lakes, to the west and south-west. In rainy seasons, when the water overspreads nearly the whole country, the St. John's may be connected in a diffused way with both sides. Fall and spring rains, when they come, elevate the river sometimes many feet, as would appear by marks on the banks. The last two or three seasons, the difference has been from two to three feet. The low stages are, at mid-summer and mid-winter, and when the periodical rains happen to fall, or are only moderate, the subsidence must be very great. It has been remarked by the Indians, that all the waters occasionally drain out. This may be an exaggeration; but such a result, nearly to the extent expressed by it, might easily be supposed to follow a year of drought, the St. John's being evidently dependent for its supply on the tides below and the rains above.

The interior of Florida, south of Lake Monroe, was scarcely known, until the present war. It was assigned by conjecture and common report, to the "everglades," an indefinite and comprehensive term, which means neither land nor water, but a mixture of both. These supposed everglades, have been much circumscribed by late examinations. They have lost, at least, one or two degrees of latitude. Okachobee Lake, a body of water of some forty miles in diameter, and of a decided lake character, and the lands east and west of it, can no longer be thus classed. The lake south of this, reported to be still larger than Okachobee, called by the Indians, Pai-hai-okee, or grassy lake, may prove, on examination, the true everglades. But it is now about as probable, that even this, their last hold, will be found to partake of the general character of that part of the peninsula, and that land and water will then have its usual divisions, so far as a sandy country of unusual flatness permits. The name which the Indians have

given the lake, shows that it must be generally so shallow as to allow grass to predominate; rendering it probable, that it has a less decided-lake character than the lakes above.

It was until lately taken for granted, that the interior of Florida was without any eminent parts, but the army movements have opened to observation, some sandy ridges or hills of considerable elevation. These are not far from that central region where the waters diverge to different sides of the peninsula. The course of the various streams which take their rise within these central parts, marks out the character of the slope, running north-west, south-west, south-easterly and northwardly. The Onithlacoochee, Pease Creek, Kissimmer, St. John's, and the waters emptying into the Indian River lagoons, all illustrate this central elevation; and general inclination towards the coast.

One of the striking features of the coast of Florida, is the lagoons, as they are termed, or long and narrow bodies of water, separated from the sea by a strip of sand, generally not more than a mile or two wide. They are connected with the sea here and there by inlets, which are made and kept open by the out-rushing or in-rushing tides, as they happen to prevail. The outward current is that which chiefly prevails, from the most natural causes. Accumulations from rains, must give a great preponderance to the inner waters, which, however, may, in the course of a dry season, drain out to a level with the outer waters, when the drift of a storm blocks up, at least for a time, the usual passage, and so it remains until the balance of force is turned by new rains.

This alternate operation of counter causes, explains the fact well known by those who frequent this coast, that these inlets are at one time very accessible, and at others, nearly or quite closed up. These lagoons extend from above St. Augustine to Jupiter inlet, a stretch of three or more hundred miles, with but a few miles interruption by land. Their common depth is several feet, though they all are traversed by shoals or bars, which reduce their navigable facility to about three feet. These shoals, however, could easily be made passable for useful purposes. It has been proposed to connect the river St. John's by a canal with the Matanzas river, separated by about ten or fifteen miles; the Matanzas with the Halifax, twice that distance, perhaps, apart. Between the waters of which the Musquito inlet is the embouchure, and those of the Indian River, there is only a narrow neck

of about half a mile. Such a project would open an interior navigation from Charleston to Jupiter inlet; and below Cape Florida it is well known that a practicable and sheltered channel runs around the peninsula, within the "keys."

The mangrove tree is a conspicuous embellishment of the Indian River lagoon. Being of an aquatic character, these trees, by a happy provision of nature, are radicated to suit their thrifty habits, not unlike the long-legged species of birds which are fitted for the water; they stand with their trunks lifted several feet in the air, sending out roots from that elevated point, like so many bow-legs, to seize the earth or water below, with a base often as wide-spread as the branching head above. Then, again, as if these roots could not drink moisture enough to satisfy their cravings, each branch sends down many a slender tube perpendicularly to the water, like so many syphons to draw it up. The foliage is of the brightest green. Altogether, a mangrove thicket is a most attractive object to the eye. These thickets sometimes shoot out a spur into the lagoon, resembling just above the water a fisherman's weir-net, but surmounted by a most redundant foliage, and almost closing up the channel.

The bars at the mouths of the lagoons are an obstruction to the commercial facilities of Florida. The entrance to St. Augustine harbor is perhaps the best on the coast, and, with proper attention to the tides and winds, is safely practicable for vessels of light draft. The drift of the ocean, which in this quarter is strongly charged with alluvion, heaps up the sands along the coast, constantly changing their position, with, probably, a gradual augmentation. The inlets would share the common fate, and be closed up, if it were not for the outseting currents, arising either from the tides, or the accumulation of waters within. These causes, with partial exceptions, keep open a channel, but cannot preserve it in one place. The bar off St. Augustine has widely shifted, being now nearly one half the points of the compass to the north of its position, within the memory of living pilots. Those of the more southern inlets are less practicable, excepting that of the Musquito. The channels are known only to those who are habitually upon them. A fearful looking surf is always coursing over them, when a wind is blowing with freshness, which renders them formidable to strangers, while those who are accustomed to them, pass through it with little real haz-

ard. The evil, however, is a great one, and apparently irremediable.

The rivers of Florida, though of no great length, are, generally, of a most convenient depth. The banks are bold and firm. Those which empty into the lower part of the St. John's, are fitted for any craft that comes into the main river, or have no impediments in the way, excepting what arise from fallen trees. There is no current to change their character, which belongs to a level country.

The botany of Florida was early examined by the Bartrams, and Audubon was some time among its birds, which are rich in number and variety. Many anecdotes are told of the latter, showing the patience with which he kept his station in swamps and marshes, in order to ascertain the habits of the feathered creatures there, in spite of musquitoes, reptiles, and other intolerable annoyances. Doct. Leitner, who was killed in a skirmish with the Indians, this campaign, (1838,) is said to have been a skilful botanist, and an ardent votary of science. Accompanying a portion of the active force, he would have had uncommon opportunities for observing the plants of the southern interior, which probably, came little within the scope of the Bartrams, whose investigations were mostly, if not altogether, on the river St. John's and the coast. He had already made considerable advances towards the object he had in view, with a most flattering prospect before him, when he fell in the honorable performance of his duty.

The orange tree has been extensively cultivated in Florida, since its first occupation. The Seville or sour, and bitter-sweet orange, are apparently indigenous to the country, as many groves of both are now found flourishing, where no labor of man would seem to have placed them. The China, or sweet orange, is probably an exotic. These were found, not only around nearly every house in the country, but occupying a part of nearly every garden in the towns. They were an important article of commerce. The oranges of Florida excelled all others in the northern markets. More than two millions, were annually shipped from St. Augustine alone. One tree there is said to have produced six thousand in one year. But this staple of the country was cut down in one night, in 1835. A severe frost occurred in the time of Bartram, (1765,) which killed the lemon, citron, and other tender trees,

but only partially injured the orange. There were trees standing in 1835, more than a century old.

This calamitous event, besides destroying one of the principal sources of revenue of St. Augustine, divested the place of its chief ornament. Each lot became, as it were, denuded of its drapery, which had been thrown over every building, high and low, giving them all a borrowed beauty. A person who was absent at the time of the frost, in revisiting the place, could scarcely recognize the most familiar scenes, their aspect was so entirely changed. It takes about seven years to renew the orange tree to a bearing state.

Cotton and sugar grow well in Florida, but silk will probably be the staple of the country after a few years. The mulberry tree, *multicaulis*, &c., grow there with a vigor and luxuriance that have no parallel in the United States. More than eight months in the year afford a fullness of food for the worms.

The soil of Florida wears a forbidding aspect. Sandy barrens form the principal part of the surface. Hammock land, that which bears the oak, maple, and other "hard woods," and which are the richer and more productive parts, constitutes but a small proportion. But the sands of Florida are but in part siliceous. They are probably for the most part comminuted shells or limestone. Hence they have a degree of fertility which often surprises those who undertake their cultivation. The surface, however, is so level, that it is liable to the extremes of drought and inundation. In riding from the St. John's to St. Augustine, a distance of eighteen miles, the road will be found, after a moderate rain, one half or two thirds under water, which is carried off more by evaporation than by subsidence; and this is a sample of the country in general.

The yellow pine, *Pinus palustris*, is a conspicuous tree in Florida, both on account of its lofty symmetry, and its adaptation to many useful purposes. It affords tar and turpentine in inexhaustible abundance, and is an equally inexhaustible material for lumber. Whether it be the only growth the soil can yield, or merely a pre-occupant, as in many other parts of the country, giving place, when removed, to a species of hard wood, is, perhaps, not yet ascertained. It is probable, however, that when this tree shall be cut down, and fires, scorching the whole face of the country, shall cease, the growth of the forest lands will assume

a better aspect, and that the soil will improve in a corresponding degree. It is the fallen tree of this pine, which furnishes the Indian with his "light-wood;" a source of comfort and convenience that strongly attaches him to the soil which produces it. The fuel formed from these prostrate trunks, is at hand on every spot, and is easily ignited, making, in all weathers, a bright and durable fire. The nights of Florida are almost invariably cool, and the facility with which the Florida Indian can temper their chilliness, by means of this ready and combustible wood, is a conspicuous item in the privileges of his life, the great design of which is to attain desirable objects with the least effort. Our troops, in the late campaigns, have been equally indebted to it for many a comfortable encampment, as, even in the midst of heavy rains, a brilliant fire might be kindled, which, with due care, no rains could extinguish.

The hammocks at present are generally secure from encroachment from the barrens, being mostly covered with a dense growth of trees, which preserves them from change. But, whenever the time arrives in which they shall be cleared up, and become exposed to external influences, it is not unlikely that the surrounding barrens, clothed in a soil of such levity as to be acted upon by winds and rains, will gradually overspread these comparatively small spots on the surface of the country, and reduce nearly the whole to one general character.

The waters of Florida abound in fish. Even the upper parts of the St. John's afford a large supply of very tolerable quality. But the lagoons of the coast have not only an abundance of the finest fish, but also of the finest oysters. The oysters of Indian river are surpassed by none, in size or quality, on the Atlantic coast. Want could never approach the inhabitants of that region.

The present war, during which the Indians have been too much harassed to attend to seed-time or harvest, has turned attention to the class of indigenous esculent vegetables, which, by their spontaneous abundance, have, through the extremities of this period, afforded them ample means of subsistence. The most conspicuous among these are the red and white coonta roots. The first is the China-briar, or *Smilax china*, a vine of great thriftiness, spreading sometimes over the space of more than a hundred feet, with roots like a large, long and irregular potatoe. The white coonta is the *Zamia integrifolia*, which has a full tap-root, rounded with



the symmetry of a boy's top. The leaves are large and fern-like, forming, when the seed-bud is in its fullness, a handsome plant.

Both of these roots are grated or bruised by the Indians, and the starch separated, by frequent changes of water, from the fibrous or woody parts, as also, in the white coonta, from a poisonous quality which is combined with it in its natural state. The flour of the latter has the look and feel of arrow-root, and is equally nutritious and well suited to weak stomachs. The flour of the China-briar is of a reddish hue, and more easily obtained than the white coonta.

These two important articles of food are found in abundance, the one or the other, in most parts of southern Florida; the China-briar in nearly all the hammocks, and the *Zamia* in most of the barrens along the coast lagoons. Thousands could subsist upon them, with only the labor necessary to gather the roots and prepare the flour. Previous to the war, one or two persons were established near Cape Florida, who manufactured the white coonta in large quantities for shipment. Medical men often prefer it, for hospital purposes, to the arrow-root.

The palmetto is often called the cabbage-tree, from its containing an edible substance within its top, which somewhat resembles a cabbage—more in look, however, than in taste, which is not unlike that of a raw chestnut. Where the fan-shaped leaves of this beautiful tree put out at the top, is found infolded a pith, forming about one third the diameter of the trunk, and about twelve or fifteen inches long, which is of an eatable quality, particularly when boiled, or preserved as a pickle. It is true, a tree some half-century old might be sacrificed to the attainment of a single meal; but these trees are abundant, and no doubt have often afforded one to a roving Indian, who sat down hungry and unprovided beneath their shade.

But the necessities of the war now going on, have opened a new resource to the Indians, or which, at least, does not appear to have been used by them in more abundant times. This is found in the root of the *saw-palmetto*, a singular species of most common vegetation in Florida, which overspreads nearly every pine-barren, covering it like a vast reticulated carpet. In passing over these barrens, the palmetto leaf is seen shooting up from the ground in great luxuriance, forming, as is found on close inspection, the termination of a recumbent cabbage-tree, several feet

long, and probably half buried beneath the surface, or deciduous vegetation. Lying constantly on the ground, it never acquires the bony hardness of the exterior coat of the upright cabbage tree, but is covered with a fibrous hairiness, which gives it almost the softness of silken plush, prevailing through every fold, to the very heart, excepting within a few inches of the end, where is found a nutritious pith, smaller than, but not unlike, that of the cabbage tree. This is bruised into meal, and made subservient to the purposes of food. These roots spread, as we have before remarked, over nearly every barren; and, since a portion of them is convertible into food, there can be no limit to the spontaneous subsistence of those who frequent them. The leaves or foldings of this root are thin and pliable, several inches long, and three or four wide, and are worked into many articles of ornament and use.

There is also found in Florida a wild potatoe, of tolerable quality, and much wild fruit. Game of all kinds is abundant, and wild fowls are numerous on every stream and lake. The Indians, in Spanish times, were accustomed to herd cattle largely, and at the commencement of the present war, they are said to have had thousands.

From this enumeration of the articles of food which present themselves spontaneously to the wants of the Indian, it will be seen that they are little dependent on care, foresight, or labor, for subsistence.

The mineralogy of Florida is scanty. The rocks found in situ are all calcareous, though siliceous boulders, of a small size, are occasionally seen, and nodules of hornstone are here and there mingled with the limestone, which elicit sparks, and are sometimes used by the Indians for flints.

The geology of Florida presents many interesting features; but it has as yet been examined with little attention, warranting few definite conclusions. The coast, as far as Cape Florida, is alluvial, a seeming mass of comminuted shells, resting on a rocky formation, composed also of shells, more or less broken and abraded. From Cape Florida, the formation is mostly coralline, the Keys being of that character. The shells around the Keys are found in nearly a perfect state. Take up a handful at random, and it will exhibit little else than fragments of coral and univalves, generally of a small size, and diminishing almost to a point.

As high as Indian River Inlet, the beach is still formed of shells, though less distinct and perfect in their form, mingled with some sand; while about Cape Carnaverel the sand predominates, until shelly fragments almost disappear to the naked eye. Still, it seems probable that the whole beach is of a calcareous character.

The coquina rock (as the Spaniards called it) is a formation found in the spits of sandy land which separate the lagoons near the coast from the sea. It has been quarried in Anastasia island, for more than a century, affording a material for structures of all kinds in St. Augustine, worked with uncommon facility, and of a durable character. A large fort, of Spanish construction, at that place, is of coquina. In latitudes where there is little or no frost, it is, perhaps, the best material that can be used in fortifications; being firm enough to sustain the form of any work, and receiving a shot like a plastic mass, exhibiting no fracture, and throwing off no splinters.

The quarries near St. Augustine are generally about ten feet deep. The profile of the strata, as presented to the eye there, exhibits, first, a superficial covering of vegetable mould; next, a stratum of shelly fragments, quite small, and without any distinctness of character, with no cohesion. This stratum varies much in thickness, according to the undulations of the surface, being generally from two to three feet. The next in the descending series is a stratum of several inches thickness, composed of similar shelly fragments, but united in a mass by some cement. Then intervenes a stratum of sand, an inch or two in thickness. Immediately below this sand is a stratum of shelly rock, between two and three feet in thickness. This stratum is formed of shells in various states, the upper several inches being much like the stratum above, that is, of small and indistinct fragments, when, for several inches more, it assumes a new character, many of the shells being perfect in their outlines, and only much abraded, and most of them of a size to give some clue to their species. The interstices in this portion of the mass are large in proportion to the size of the shells, and the cement which holds them together is hardly visible. Bivalves, cockles, of the cardium species, predominate, while here and there is found a conch of large size, as also oyster fragments. Some of these conchs are several inches in length, though much worn. This coarse and comparatively unbroken deposit has a substratum, with which it is equally

closely joined, like that superimposed. A thin stratum of sand next succeeds; and then a third stratum of shelly rock, about two feet and a half thick, the component parts of which are in a state rather more comminuted than any lying above. This stratum is likewise of a more solid and uniform character than its associates, and gives the largest blocks for building purposes. A sandy stratum is found below this, and, so far as an examination has penetrated, the coquina formation descends no lower.

All these strata are firm concretions, their component parts being obviously conglutinated by a calcareous substance, which holds them well together. This foreign substance, or cement, is quite visible in the finer formations, though little seen in the coarser. Taking up a piece of the latter, the cause of cohesion is apparently so slight, that one is surprised that the mass does not crumble at a touch.

It is a common conjecture that the coquina is of recent formation, and that causes are still operating to produce it. This conjecture has some apparent and plausible grounds. It wants, however, the support of deeper investigation into the character and force of these causes. Fragments have been constantly heaping up on the coast, portions of which have been long lying in a quiescent state, without exhibiting any evidences of a change, or a tendency to one, particularly of a change from a loose to a concrete state. The upper stratum of the quarries we have been describing, would be likely to assume the character of the strata below, if such a change were in progress. But the century during which it has been subject to observation, has witnessed no alteration. The fragments all lie in a separated state, without showing any signs of cohesion.

It has been surmised, that the animal matter of the shells might have furnished the element of cohesion. But this surmise would seem to be at once disproved by the condition in which the shells were found, when the concretion took place. It is evident that they must have been subjected to a long and severe process of attrition and contusion, previous to that event; such a process as must have widely separated all animal matter, from its former covering. Besides, there is no reason for supposing, that this animal matter, even if it had existed in connection with the shells at the time the rocky formation occurred, could have produced the effect assigned to it.

A more probable conjecture is, that the shells themselves, by some chemical exertions or agency, which operated in connection with their partial dissolution, furnished the bond of union among the fragments, though not in a way that leaves the same agency still in operation. These different strata are evidently so many distinct deposits, probably at different and distant periods; broken shells thrown up or spread over a certain space, and no doubt converted at equally different and distant periods into solid masses, either by sudden or gradually operating causes, ceasing with their effect. Such a hypothesis is in harmony with our notions of other formations of rock.

There are appearances of shelly formations on the St. John's, particularly the upper parts of it, but the shells are of a different character. Scarcely a bivalve is seen on or near that river, either loose, or in rocky connection. The prevailing shell there, is the *Helix*, while univalves are as rare in the formations on the coast. The soil at Volusia and Fort Mellon consists of half shells, which are generally perfect in their shape, the defects evidently arising rather from decay than abrasion or contusion.

The limestone does not show itself on the coast, nor on the St. John's until you reach Lake Monroe, where it is intermixed sparingly with shells. On Black creek, west of the St. John's, a porous, rotten limestone appears, and this is said to be the character of the rock formations throughout the western part of the peninsula. Hence the many "surth-holes," deep and (some of them) unfathomable orifices in the earth, which appear in these regions, and the disappearance of streams for many miles beneath the surface of the earth, while others come forth in all their fullness at once.

The climate of Florida, during the six or seven months from October is truly delicious. The frosts are generally few and slight, leaving vegetation its verdure, and flowers their bloom, throughout the year. Such frosts as kill the tender trees or shrubs are of rare occurrence. Rains occasionally prevail during the winter months, but more commonly during the latter part of summer. Our troops have now been operating during three winters. Two of them have been decidedly dry. The first was rainy.

By a loose diary, kept in Florida, since the last October (1837) and continued through two hundred and fourteen days, more than one hundred and fifty of them, were decidedly clear and pleas-

ant days; about forty somewhat cloudy or foggy; and about twenty rainy, but of these nearly one half were single rainy or showery days, leaving only about ten which were of a rain-storm character. Mosquitoes have bitten, and frogs have peeped throughout the whole time, though not always in the same numbers or with the same spirit.

It is perhaps a common impression, that there are some formidable animals and many venomous reptiles in Florida. The alligator is a clumsy, timid animal, never, it is believed, the assailant, unless it mistake a swimming boy, for its common prey. Scorpions, snakes, lizards, &c., are common upon the barrens, and our soldiers, in sleeping on the ground, often came in contact with all of them, and were often stung by the former, generally with unpleasant, but never with fatal consequences.

Invalids have long looked to Florida as a refuge from the northern winter, and during the disturbances of the last few years, St. Augustine has necessarily been the only place of resort. But when peace shall be established, and the St. John's re-occupied, that river will present many places of great attraction to the infirm and pulmonic.

ART. III.—*Geology of St. Croix*; by Prof. S. HOVEY, late of the Faculty of Yale College, Ct., and Amherst College, Mass.

DURING two winters which I passed at St. Croix for the recovery of my health, I found great relief from *ennui*, the well-known natural enemy of invalids in such circumstances, in examining the physical features of the island; and, had my observations been more complete, the record of them might have been a valuable contribution to science. Limited, however, and imperfect as they were, I am unwilling entirely to suppress them; especially, as they relate to a quarter of the world highly interesting, and but little known. Should they be productive of no other benefit, I hope they may lead some more competent individual, who may, perhaps, be driven, as I was, to seek refuge from the rigors of a New England winter, in the balmy climate of the tropics, to continue the examination, and to present to the public the more ample results of his investigations. My object in this article is to give a brief outline of the geology of St. Croix. Should time

and health permit, I may, perhaps, on a future occasion, extend my remarks to one or two other islands, and touch on some other topics.

I am not aware that more than two or three of the West India islands have attracted the attention of any geological observer. Indeed, the tropical countries in both hemispheres must yet be regarded, so far as geology is concerned, as nearly a *terra incognita*. Still, they will no doubt furnish highly important results in this interesting science. Here some of its most specious theories will be tested; and here, too, will be found entombed new races of organized beings, brought into existence and advanced to maturity, and finally destroyed, in circumstances differing from any present or past in other parts of the globe. If the axis of the earth has been changed, as some philosophers maintain, here we shall find the evidence of it, in a change of organic remains, corresponding with that in the northern regions, but in a reverse order. On the other hand, if the extraordinary size and character of fossil relics, in the high latitudes, are owing to a secular refrigeration of the earth, it will be interesting to know what were the types of animal and vegetable life, during the same geological periods, in the equatorial regions. If past periods in the tropics were as much more favorable than the present to the gigantic development of organic existences, as they certainly were in ours, the imagination can scarcely paint the monsters, which careful research may bring to light. I must confess, however, I saw nothing in the West Indies to countenance such suppositions. No animals or saurians, to my knowledge, contemporaneous with those imbedded in the secondary and tertiary formations of Europe and America, have yet been detected; nor, if we except the island of Trinidad, do I know of any indications of the existence of extensive subterranean deposits of vegetable matter. The pitch-lake of that island, and the petroleum which oozes from the rocks on the coast, are probably due to a vegetable origin; but if similar indications of carbon in a fossil state exist in other islands, they are yet to be discovered.

Most of the islands in the West Indies, as is well known, exhibit marks of volcanic action. Though not lying within the range of that great line of volcanoes which extends along the western coast of South America, and reaches to Mexico, they have often been subject to destructive earthquakes; and two of

them, St. Vincent's and Guadaloupe, are at present the seats of active volcanoes. By inspecting a map of the West Indies, it will be seen, that St. Croix is near the northern termination of the crescent of islands, which, commencing with Trinidad on the south, and ending with St. Thomas on the north, constitutes the eastern boundary of the Caribbean Sea. These islands extend through more than eight degrees of latitude; and yet, it is impossible to look at their relative position, without suspecting that they were elevated by a common force, and have been subject to similar geological revolutions. This, so far as my own observation and the information otherwise obtained extend, I believe to be true. Many of the islands contain several formations, dissimilar in age and geological constitution; but they all bear, if I may use the expression, a striking family likeness. The prevailing formations in the West Indies are, in the first place, recent igneous rocks, comprising the products of active volcanoes and different varieties of trap; in the second, tertiary groups, consisting of marl, calcareous sandstone, and shell limestone; and in the third, a stratified deposit, which, without at present intending to intimate its place in the geological series of rocks, I shall call *indurated clay*. As I have already suggested, some of the islands present all these formations, indications of which are seen upon the first approach to them. St. Croix contains only the two latter, which divide the superficial area of the island about equally.

This island is in north lat.  $17^{\circ} 45' 28''$ , and west long.  $67^{\circ} 12' 40''$ . It is about 26 miles in length, and, on an average, not more than four or five in breadth. Its shape is irregular. The northern and southeastern parts comprise the clay formation, and the central and southern are calcareous. There is a striking contrast in the elevation of the two portions of the island. The clay formation is a pile of mountains, separated, however, by gorges and valleys, which run in every direction, and give to it a beautifully diversified aspect. The highest point is Mount Eagle, which is estimated to be about 1200 feet above the level of the sea. The calcareous formation is much lower and less broken, but undulating. The greatest elevation in this part of the island, is about 600 feet. It is that on which stands Bulow's Mindo, the elegant country-seat of the governor, so named in memory of his friend, Gen. Bulow.



The most striking feature of the mountains of the clay formation, is their high state of cultivation, even when they are so steep that they cannot be ascended except in mule paths, which wind up their sides in zigzag lines. All bear the marks of great violence in their elevation. The strata were much broken by the unequal application of the uplifting forces, and formed into many distinct and grotesque summits; some of which, however, have since been rounded by the hand of time. Nothing can exceed the beauty of these mountains and the intervening valleys, when covered by a luxuriant growth of the sugar-cane, interspersed with plantations and orange groves, and seen from a summit, which, at the same time, commands a view of several vistas to the ocean. Some of the mountains, however, are too precipitous for cultivation, and the rocks are too hard to be readily broken down into an arable soil. Such is most of the eastern section of the group on the north, and the extreme portion of the southeastern range. In favorable seasons, the cultivated tracts yield good crops of cane, but they are peculiarly susceptible to the drought.

As a mass, this formation is distinctly stratified. The strata vary in thickness from six inches to three feet; and, in many places, are exceedingly regular and well defined. A good section of this description may be seen on the coast, below the Mount Washington estate. In others, they are schistose, and much contorted, as near Punch, in ascending from Little La Grange, and at a quarry contiguous to Jolly Hill garden. In some cases, no stratification is visible—the whole mass breaking up into small angular fragments, or being consolidated into columnar blocks, with a structure and cleavage resembling trap. Localities, however, of the last description, are not common; and the angular fragments of the other beds are generally soft and easily decomposed.

The strata are highly inclined. The lowest angle I observed was near Capt. Sempill's house, at Butler's Bay, which was about  $45^{\circ}$ . The inclination varies in different places, from this to  $90^{\circ}$ . It is generally from  $70^{\circ}$  to  $80^{\circ}$ . The direction of the dip is pretty uniform, and is nearly north. The composition and general aspect of the strata in different localities, and even in juxtaposition, are often various. In some cases, they are decidedly aluminous; in others, siliceous predominates. They also vary much in hardness, the more aluminous being generally soft and inclined

to crumble, and the silicious requiring a smart blow of the hammer to break them. The grain is uniformly fine. I did not see, in this mass of rock, any thing like a pudding-stone. The formation seems to have been deposited in quiet waters, though there are frequent contortions in the strata, which may be due in part to the troubled state of the element from which they were deposited; but probably more to the force by which they were uplifted. There are beds in the ravine near Mount Victory, as we ascend on the road from Sprat Hall, which strongly resemble argillaceous slate. The color of the strata, in other places, passes through all the varieties of brown to that of clay. They are frequently colored red by the oxide of iron.

This is particularly true in the region of Annesley. In such cases, however, the oxide does not appear to have penetrated the substance of the rock, but to have been infiltrated through the seams and crevices. The soil is also impregnated with this substance.

Thin layers of quartz, from one fourth to half an inch in thickness, are often interstratified with this rock, and sometimes cut the regular strata, and also each other, diagonally. Mingled with schistose formations, I often found small beds of marl and calcareous spar. In some instances, the marl had been introduced from above, in the form of a deposit; in others, it was obviously interstratified with the rocks when they were formed. The streams, also, which ran down from the mountains over the hardest rocks, were more or less impregnated with lime.

I have already intimated, that the strata are often intersected by diagonal cleavage planes. This appeared to me a striking peculiarity of the formation. These planes were from one to three inches apart, sometimes parallel, but generally more or less inclined to each other. They were often crossed by others; so that the rocks naturally broke into angular, columnar, or rhomboidal fragments. It was often difficult to distinguish these cleavage planes from the true lines of stratification. In this respect, I was much struck with the similarity between these rocks and the greywacke formation of Wales, as described by Mr. Murchison.

The valleys and ravines of this formation, as I have already said, run in all directions, but more generally in that of the anti-clinal lines of the strata. Such, for example, are those which extend from the coast road, at the west end of the island, towards Jolly Hill, Mount Victory, and New Caledonia.

Sometimes these valleys and the impending mountains are wild and picturesque in the extreme; in other cases, they are highly cultivated. The contrast is owing principally to the different degrees of hardness in the rocks.

One is at first surprised, that any portion of soil can be retained on the cultivated parts of the mountains, as they are so steep that, in ordinary cases, it would all be washed away. It would be in this, but for the fact, that the cane is planted in deep trenches, dug horizontally along the sides of the mountains, which prevent in a great measure the flowing of water; and also, that the rocks are continually decomposing and forming a new soil. Indeed this process of decomposition may every where be seen at present going on, in sections of roads cut through the rocks, where the passage from the solid, unchanged strata beneath, to the cultivated soil on the surface, is so gradual, that no distinct line of separation can be drawn.

A similar explanation is applicable to the different states in which the talus is found at the foot of the mountains. In some places, it is many feet deep, but thoroughly pulverized; in others, it remains in the state of broken fragments, covered with so little soil, as not to be susceptible of cultivation. This is strikingly seen at Ham's Bluff, which presents a stratum of undecomposed detritus twenty-five or thirty feet in depth.

The thickness of this formation is at least several hundred feet. On the west coast, north of Sprat Hall, the strata are seen standing side by side, in uninterrupted succession, for several rods; and, were it not for the gorges which break, occasionally, their continuity, the thickness might appear much greater.

As to its age, I am not prepared to express a decided opinion. On the one hand, it cannot be so low down as the older slates or the *metamorphic* rocks of Lyell; and, on the other, its composition, structure, and high inclination, bear a striking resemblance to those of greywacke. I did not observe it associated with older rocks, except in one place, near South Gate, where a bed of sienite occurs, thirty or forty rods in extent. As to organic remains, though I made diligent search, I found none; from which it must at least be inferred, that, if they exist at all, they are very uncommon. I ought, however, to mention, that, on the road from Little La Grange to Punch, I discovered in this formation, from two to three hundred feet above the level of the sea, a bed

of limestone, in which were imbedded the leaves and trunks of dicotyledonous plants. They were both converted into the substance of the rock, but were well preserved. The largest specimens of wood I obtained were about four inches in diameter; though, if I am not mistaken, I saw the impressions of those much larger. The cortical layers were very distinct, and, through the smaller pieces, were holes, which the pith of the plant once obviously occupied. The bed which contains them is of limited extent. It was clearly raised with the formation in which it is implicated; and, if they are both contemporaneous, the clay formation is obviously of recent origin. I am in doubt, however, whether this bed is not the remnant of a calcareous stratum, which may have covered the whole of this formation when it was raised, but has since been removed by meteoric agents. If this supposition is true, other beds will probably be found, from which farther light may be obtained. I may also add, that just before leaving the island, I received some specimens of limestone, containing casts of corals and marine shells, taken from a bed, which was said to be found in this formation near Judith's Fancy. I would especially recommend this locality to the attention of any one who may hereafter have an opportunity to examine the geology of the island.

It may not be improper to remark, that this formation is exceedingly well developed at St. Thomas, an island about forty miles north, which bears a strong resemblance in its geological character to that part of Santa Cruz which I have just described. The columnar and trappean forms of the rock, imperceptibly graduating into regular schistose strata, are, perhaps, more common. This island, also, contains extensive localities of trap and porphyry. On the west side of the harbor, they are seen protruded among and overlying stratified and altered rocks, where the peculiar globular concretions of the trap are very apparent in the decomposing surfaces of large insulated masses. The clay and the trap are the only two formations of this island. Of the corresponding groups of Antigua, I intend to speak at another time. I will only add here, that indurated clay constitutes a district of considerable extent on the island of Barbadoes. I saw it near Codrington College, where it is not fully developed, and cannot therefore speak of it with confidence. Here it was more aluminous and less indurated than the rocks of which I have

been speaking in St. Croix and St. Thomas. Indeed, at this place, the consolidated rocks were nearly covered by thick strata of clay mingled with sand, some of which were partially hardened into stone and dipped with the others at an angle of about ten degrees under the calcareous and tertiary formations, which constitute so striking and interesting a feature of that island. The greater portion of this district, consisting of strata highly inclined, is, I was informed, exceedingly wild, broken, and mountainous. Upon the whole, the entire class of rocks which I have been describing, though they may not be of precisely the same age, appear to me to have been formed in similar circumstances, and to owe their varieties principally to the different degrees of heat to which they have been subjected.

The general aspect of the calcareous part of the island, as I have before said, is undulating. With the exception of some estates on the south and southwest coasts, where the limestone rises to the surface of the ground, the soil is easily tilled and very fertile.

The strata incline at different angles and in different directions. Their prevailing position at the east end of the island, is a dip towards the west at an angle of about  $10^{\circ}$ . They crop out towards the east at Constitution Hill, and at King's Hill; but at an eminence near La Reine, towards the west, I saw them inclining in other directions, and, also, nearly horizontal, as at a quarry south of Mount Pleasant.

This formation presents considerable diversity also in composition. Perhaps it can best be described under three general divisions—the section which is now forming on the northwest coast—the marl and the calcareous sandstone, which occupy the central portion—and the limestone and coral crag, the former in most places overlying the latter, and together covering the south side of the island.

The first of these divisions is of limited extent. It is a narrow belt, from two to six rods wide, extending along the west, with few interruptions, from the bluff to Frederickstad. It consists of corals, shells, and comminuted detritus, thrown up by the waves upon the coast and agglutinated by a calcareous cement. Most of the shells are broken; the stronger ones, however, such as *Strombus gigas*, *Turbo pica*, *Tellina remies*, *Arca Noe*, are found entire, and even retain their natural colors. I observed a

few more delicate shells of the genera *Serpula*, *Lucina*, *Voluta*, *Bulla*, &c.; all these species still inhabit the surrounding seas. In addition to this fact, there are other circumstances which show the recent origin of this deposit. This part of the coast is liable to a strong surf, which is constantly drifting shells and other substances upon the shore, and dashing over them spray charged with calcareous matter. These generally unite and harden, especially near the surface, and form into a tolerably compact mass. I also found imbedded in these rocks, iron utensils, which had been employed at no very remote period, in quarrying them. It contains many fragments and rounded pebbles of indurated clay, which as a general thing unfit it for the kiln.

Though it is obvious these rocks are still in the process of formation, they have been much abraded and broken by the surf. I doubted, indeed, for some time, whether they could have been formed in the face of such powerfully abrading agents; but the fact, that the windward coasts of coral islands are generally distinguished by the greatest accumulations of matter, removes the difficulty. I saw in one place a mass of rock containing about four hundred cubic feet, which had been detached from its bed, raised several feet, and thrown back upon the shore. This deposit every where rests upon the tilted strata of the indurated clay, which often form a precipitous bank, and generally rise within a short distance into high mountains. The shore is lined with tropical shrubs and trees, such as *Hippomane mancinella*, *Guilandina bonducella*, *Coccoloba uvifera*, *Lantana involucrata*, *Turnara ulmifolia*, *Mimosa spinosa*, &c.

The marl varies in composition, and hardens even within moderate distances. It often comprises extensive beds of lime nearly pure, and so soft that it may be dug with a hoe; in other places, it is mingled with sand, becomes harder, and forms a good building stone. In such cases, it is easily broken at first, but hardens by exposure to the atmosphere. In structure and general aspect I saw quarries much resembling those of the Paris basin, from which such ample materials for building are derived.

It is impossible to draw a dividing line between these beds and the purer lime deposits on the south and west. Both are no doubt contemporaneous, and owe their difference to peculiar circumstances in their deposition. The limestone sometimes occurs in a compact form; but the structure is generally loose and friable.

ble, especially at a little distance below the surface. It is often dug up for the purpose of deepening the soil, and left to decompose upon the surface. The lower beds, which rarely appear on the surface, are seen to good advantage along the southern coast, and consist principally of coral and shells converted into a ragged mass of nearly pure lime. The name *coral crag*, which I have applied to them, well describes their general appearance. The superficial beds, which are very imperfectly stratified, and have the appearance of a chemical deposit, vary in thickness on the coast from two to ten feet. The coral crag is not peculiar to St. Croix. I saw extensive beds of it in Barbadoes and Jamaica, where it often rises to the surface of the ground.

The whole calcareous group, which I have now described, obviously belongs to the tertiary formation. The first and most recent division may be classed with the formation of Guadaloupe, in which human skeletons have been found; and the others I am inclined to think do not extend back beyond the newer Pliocene of Lyell. I do not speak with entire confidence, because nearly all the shells which are found occur in the form of casts, from which it is often difficult to decipher the genera and species.\*

Fossil coral, unaccompanied by marine shells, also occurs in many places; sometimes beautifully colored, and incrustated with calcareous depositions. Whatever may be the age of this formation, it is no doubt more recent than the indurated clay; for, in addition to other facts already suggested, we find imbedded in it great quantities of angular fragments and even large masses of rocks from that group. This circumstance may be explained on the supposition that the island has been elevated at two different periods; indications of which, if I mistake not, are found at several places, and especially at Jolly Hill, a distance of about a mile from the west coast, and near a hundred feet above its level. They consist of a calcareous deposit by the side of the road, near the mill, upon the uplifted strata of the indurated clay, resembling those which I have already described; and stratified banks of gravel contiguous to the garden, in which marine and lagoon shells are promiscuously imbedded. On the lower grounds be-

---

\* The two best localities for shells are a quarry near Dr. Stedman's at the west end of the island, and one at the east end, from which building stone was obtained for the new prison.

tween this and the sea, there are at present two lagoons, and also extensive beds of unstratified gravel, which have obviously been washed down from the mountains, and contain large quantities of shells belonging to the genera *Helix*, *Caracolla*, *Bulimus*, and *Pupa*, which are now extinct upon this island, but are found upon others in the neighborhood. I might adduce other evidence bearing on the same point, but the limits of this article will not allow.

The beds of the ocean are lined with coral on every side of the island, and, in many places, the reefs rise near the surface of the water. This is particularly true on the south coast, and at the harbor of Christianstad; which is, indeed, with the exception of a narrow break that affords a passage for vessels, completely enclosed by a coralline bank.

St. Croix contains but few minerals. Calcareous spar and arragonite are the only two varieties which I saw. The latter occurs in the form of small, parallel, combined columns, and of six-sided prisms with re-entering angles on the sides. Both kinds are well developed.

Though the soil of the island was originally very productive, it has been much impoverished by a long course of unvaried cultivation. The elements however of an admirable soil still remain; and all that is necessary is to bring them into a suitable combination. Many parts of the island might be exceedingly improved by an artificial admixture of the marl and clay; and all need a fresh supply of the nutritive principle of a vegetable compost. The island of Barbadoes, which much resembles St. Croix, both in the geological formations and in the worn state of the soil, has been wonderfully revived by improved agricultural processes, and especially by compost manures and a more frequent alternation of crops. I do not doubt that the productive powers of St. Croix might be doubled in a few years by similar methods; an object certainly deserving the attention of the landed proprietors.



ART. IV.—*Geology of Antigua*; by Prof. S. Hovey, late of Yale College, Ct., and Amherst College, Mass.

As I passed but two or three weeks at Antigua, and as these were principally devoted to a public object, I should not feel prepared to give even an outline of the geology of the island, without aid from foreign sources. This I fortunately have, in an interesting article, prepared by Dr. Thomas Nugent, and published in the fifth volume of the Transactions of the London Geological Society; and in another brief notice, written for the Antigua Almanac and Register by Dr. Thomas Nicholson. I had the happiness to become acquainted with both of these distinguished gentlemen, and to visit in company with them several of the most interesting localities of the island. Were the articles, to which I have referred, before the American public, I should not attempt to add any thing more; but as they are nearly or quite inaccessible to most of the readers of the Journal of Science, a brief sketch of the geology of the island, will not, I hope, be an unacceptable offering.

Perhaps there is no island in the West Indies, whose geology is so rich in variety and interest. It contains all the three formations, viz. indurated clay, recent calcareous deposits, and trap, which I mentioned in a preceding article as constituting the West India islands. They are all distinctly developed also within a territory of moderate extent, and yet are separated by broad lines of demarcation. But what constitutes the peculiar charm of the geology of Antigua, are the uncommonly beautiful and variegated silicious fossils with which it abounds. In this respect, I am not aware of the existence of any deposit in the world, which can be compared with it. I should confine my remarks to these extraordinary relics, were I not persuaded, that a knowledge of them must create a desire to learn something of their geological relations. For the purpose of best accomplishing the object which I have in view, I shall not follow a strictly geological arrangement in my observations, but having noticed the trap formation, I shall describe the two others in the order of their contiguity, and then give some account of the silicious minerals and fossils which are more or less common to all the formations.

Antigua is a little north of the centre of the circular segment of islands, which bound the West India Archipelago on the east. It is in north lat.  $17^{\circ}$ , and west long.  $62^{\circ}$ , and comprises an area of one hundred and eight square miles.

The trap formation commences on the southeast corner, and includes nearly one quarter of the island. The district is broken and mountainous, rising occasionally into summits of eight hundred or one thousand feet in height, some of which are bold and precipitous, and others more gentle and rounded, affording a luxuriant soil for cultivation. It is also divided by valleys, which intersect each other in different directions, and are beautifully mantled by a rich and ever-blooming vegetation. The rocks are considerably diversified. Basalt, in extremely distinct globular concretions, is not uncommon. Indeed, I saw concretions so perfect, that they might justly be compared to piles of cannon balls from three to six inches in diameter. In some instances, the interior was decomposed, and the concretions were presented in the form of well defined and regularly arranged cups imbedded in the surface of the rocks. Breccias and porphyry are very common. The latter is often of a comparatively light porous character; and, at a little distance, might easily be mistaken for red sandstone. The matrix has a red earthy appearance, and the imbedded feldspar and scoriæ are soft and easily decomposed. Drew's Hill is composed principally of a rock of this description. Breccias, of an exceedingly hard and compact character, are not unfrequent. I often saw them in the form of boulders, at considerable distances from their beds. Genuine greenstone, of a nearly homogeneous aspect, also occurs, and is sometimes employed for macadamizing the streets of St. John's. These rocks overlie, and are protruded among the stratified rocks of the contiguous formation in every possible manner. Not unfrequently one is enveloped in the other; and both are so blended and changed by having been suddenly brought in contact in opposite states of heat, that the line of separation can scarcely be perceived without examining their composition. At Drew's Hill, a vein of lamellar sulphate of barytes occurs in this formation; but of how great extent it is not easy to decide from the excavations which have yet been made.

This group is separated from the clay formation on the northeast, by what are called the Body Ponds, and by a small stream

which issues from them and runs toward the northeast. The superficial area of this deposit is not great. It is an irregular belt, extending from Five Island Division and Dickinson's Bay on the northwest, through the island to English Harbor and Willoughby Bay on the southeast, and separating the calcareous formation on the northeast from the trap on the southwest. This district is much less mountainous than the one which I have just described. The greatest elevation is Monk's Hill, near English Harbor, which I should judge not to exceed five or six hundred feet. The whole formation is distinctly stratified, the strata inclining nearly north at an angle of  $15^{\circ}$  or  $20^{\circ}$ . They often crop out on the south in bold and prolonged escarpments; on the north the slopes are more gradual.

The mineralogical character of this formation, as well as that of the trap, varies exceedingly. As I have already remarked, the rocks contiguous to the trap have been much modified by heat, frequently losing not only their color but even their stratification. The most marked rock in the group is the one, which the traveller first strikes in leaving English Harbor on the road to St. John's. It constitutes Monk's Hill. It is of a green aspect; and, as it is broken up on the roads, very much resembles green earth. When minutely examined, it is found to consist of feldspar imbedded in green clay. In some places the clay greatly predominates, and gives the rock a homogeneous aspect; in others, not only feldspar but fragments of different minerals are cemented by the clayey basis, and the rock assumes the character of a conglomerate. Extensive beds are found in this formation, composed of yellow earth instead of green, and containing a foreign substance of a brown color. The coloring matter in both cases is probably iron or manganese. In the vicinity of St. John's, the rocks are more hard and silicious. Near Scot's Hill there is a quarry of a dull, homogeneous aspect, which much resembles a yellow free-stone. I also observed, about two miles southeast of St. John's, superficial strata of red sandstone imperfectly hardened, in which, however, clay much predominates over siliceous. Indeed, throughout this formation, clay, with few exceptions, is the prevailing constituent. Compared with corresponding formations of St. Croix and St. Thomas, these rocks contain much more feldspar—an ingredient, which, indeed, scarcely exists at all at those places; they have also more of the

character of a conglomerate, but are much less inclined, and have been less subjected to heat.

The remaining formation is the calcareous. It is far the most extensive of the three, and comprises the north and northeast parts of the island. It is no where very elevated—the highest hills not rising more than 300 or 400 feet above the level of the ocean. The surface of the ground is generally undulating; sometimes the hills are abrupt and broken, having summits covered with a light soil and overgrown with tropical shrubs, particularly *Lantana involucrata*, *Pisonia subcordata*, and *Croton balsamiferum*. The slopes of the hills and the lower grounds are highly cultivated; and, in an agricultural point of view, constitute the best portion of the island. This formation is separated from the preceding by a low tract, extending from Dickinson's Bay to Willoughby Bay, which Dr. Nicholson thinks was, at no very remote period, submerged, and divided the island into two nearly equal parts.

The composition of this formation, like that of the corresponding one in St. Croix, is by no means uniform. In many places, it consists of marl, which may be easily quarried with a heavy hoe; in others, it is a tolerably compact limestone which can be broken only with a hammer. I did not observe any specimens of what I called "coral crag" in the geology of St. Croix, though further observation might have brought them to light. Dr. Nugent describes strata running through the marl, which I had not an opportunity to see, "consisting of a grit stone, divisible into thin layers," and appearing under a magnifying glass to be "made up of very minute fragments of quartz, hornblende, jasper, hornstone, and green earth, held together by an argillaceous cement." It also contains localities of a yellow calcareous sandstone, breaking with an earthy, conchoidal fracture, and employed extensively in architecture. As a group, this formation is stratified; but, in many places, the planes disappear, and the mass bears the aspect of a precipitate from water. Though it obviously rests upon the clay, the strata of the two formations are not conformable; those of the marl being sometimes horizontal, and at others inclined in different directions.

This formation contains a great variety of fossils. "Of these we may enumerate," says Dr. Nugent, "as most frequently presenting themselves, different species of madreporæ, echinus, ser-

pula, pecten, cardium, strombus, cerithium, ostrea, trochus, cypræa, turritella, venus, lucina," &c. These are sometimes found entire, but they generally occur in the form of casts, either calcareous or silicious. Dr. Nugent also mentions several species of land and fluviatile shells, belonging principally to the genus *Helix*, which he has observed associated in the same locality with marine genera, as *murex*, *arca*, *nerita*, *purpura*, *chama*, *trochus*, &c. The most of these fossils have living exemplars in the surrounding seas. From the specimens which came in my way, (for I did not see a complete collection,) I think I should be safe in estimating the proportion of such as high as 70 per cent. If this estimate be taken as an approximation to the truth, the formation must belong to the latest tertiary or newer Pliocene period of Lyell. No relics of mammalia have yet been discovered in this group, nor indeed in any upon the island.\*

As to the age of the clay formation, I have not sufficient data to form an opinion. With the exception of some petrified leaves found near its junction with trap at Drew's Hill, I could not ascertain that any organic remains had been discovered in it. These leaves belong to trees of the dicotyledonous class. Dr. Nicholson thinks he recognizes among them those of the *Ficus pertusa*, and a species of *Melastoma*. The mineralogical character of these rocks certainly does not indicate great age; still, neither this nor any thing in their relations to other rocks, points out their absolute place in the series of geological formations. We must wait, therefore, for farther light on this point, till their organic contents are better investigated.

Intimately connected with the clay formation, if not constituting a part of it, is another class of rocks of a most interesting character. I refer to the extensive beds of chert and the silicious petrifications with which this part of the island abounds. Dr. Nugent describes these beds as a distinct deposit, lying above the clay and below the marl. His opinion is probably well founded; but they are so intimately associated with the clay formation, that I prefer to class them with that group. Their comparative extent is not great. They are found principally in the neighbor-

---

\* Of the age of the corresponding formation in Barbadoes I can speak with greater certainty. Of forty one species of conchifera and mollusca, which I obtained during ten days' residence upon the island, there were only three which are not found at present in a living state in the West Indies.

hood of St. John's and of Constitution hill. Near St. John's they have been disturbed by uplifting forces, and constitute two or three summits of moderate elevation, on one of which stands the cathedral.

At this place, the chert is strangely intermingled with limestone, and it is not very obvious which occupies the lowest position. At an eminence a little south of this, it is broken up into immense masses, which appear like outliers or ledges on the sides of the hill. In the region of Constitution hill, and farther south on the road to English Harbor, it appears in the form of square and angular blocks, from a few inches to two feet in diameter, strewed in great quantities over the surface of the country. I saw only one or two beds which had not been disturbed. They were distinctly stratified, and lay in a position, so far as I could judge, conformable with the strata of the clay formation. I saw no place, however, where one distinctly graduated into the other, or where they came directly in contact.

The aspect of this rock is various; generally, however, highly vitreous. It sometimes approaches to jasper, both in constitution and color; at others it is a pale hornstone; and it is often seen of a still coarser structure. The fracture is sometimes even, often conchoidal, and not unfrequently splintery. The structure of the masses of which I spoke on the eminence south of the church, differs from any which I saw elsewhere. It was more porous, giving to the rocks an appearance not unlike a silicious tufa, which had been impregnated with iron and hardened by heat. This family of rocks is altogether of an interesting character, entirely unlike any thing which I have seen in other parts of the West Indies or of the world. Their geological interest is greatly increased by the immense quantities of shells which they contain, supposed by Dr. Nicholson to be *Melaniæ*.\* These shells are always silicified; sometimes standing out from the rock in beautiful relief; at others entirely imbedded, and, with the exception of the coloring matter, converted into its substance. I saw specimens of this description most elegantly polished. According to the best information which I could obtain, these shells

---

\* Dr. Nugent calls these shells *cerithium*. I am not satisfied that either of the above names is correct; nor have I been able to consult any conchologist in regard to them, on whose opinion I can rely.

are found only in rocks of the chert family, which is a very important circumstance in ascertaining the origin of the beds.

As I have already intimated, the two preceding formations abound in the silicious fossils of an exceedingly interesting and important character. For variety of structure, for fineness and beauty of material, and for richness of color, I know of none in any part of the world in comparison with which they would suffer. They are found in the form of jasper, cornelian, agate, chalcedony—sometimes existing separately, at others all beautifully blended in the same specimen. The coloring matter also varies in intensity, presenting every tint and shade which are peculiar to those minerals. But the most striking feature of all, is the perfect preservation of the form and structure of the petrified substances, even of such as in a living state are most delicate. For example, the opening leaves of the banana, than which no vegetable fibre can be more tender, have been converted into silex and perfectly preserved. I saw myself the petrified pod of a tamarind, so entire in its shape and all its parts, that no one could mistake it.

These fossils may conveniently be divided into two classes—the *marine* and the *land* fossils. The former consist of corals, shells, &c., which are found principally in the calcareous formation, and are particularly abundant and beautiful in Belfast Division. They frequently appear on the surface, but are often found at considerable depths. The corals are frequently very striking; they are converted into chalcedony both pure and colored, but still retaining their pattern so perfectly, that the genus may be recognized when they are set in a breastpin. All the fossils in the calcareous formation are by no means of this character. Many of them are calcareous. The silicious prevail only in particular districts.

But the most interesting class of fossils is the silicified wood—the ordinary trees and shrubs of the climate still retaining their individual structures, but converted into the choicest mineral substances. Fossils of this class are confined to the chert and clay formations. They are generally found intermingled with the chert in broken fragments, and scattered over the surface of the earth. Sometimes in low districts, they constitute immense beds, and give one the idea of a thick forest, which has been prostrated by some mighty tempest, converted into silex, and buried be-

neath the ground. The fragments are not usually more than ten or twelve inches long, and are frequently split in the direction of the fibres. The most perfect specimen which has been found, is described by Dr. Nugent, as being the "trunk of a tree about twelve feet in length and as many inches in diameter, rent cross-wise asunder, but all the parts lying contiguous to one another." The largest section which I saw, was eighteen or twenty inches in diameter, and about two feet in length.

Though these fossils are all silicious, they vary exceedingly in the perfection of the material and in the beauty of their colors. Sometimes they present a dull, compact, earthy aspect—sometimes the grain is coarse and the fibres are indistinct; but when a combination of fine grain, variety and beauty of colors, and distinctness of structure, is found, the specimens are exceedingly elegant. Among these may be particularly specified, dendritic and moss agates, and the petrifications of the loblolly (*Pisonia subcordata*.) The cocoanut, also, is often very beautiful, especially its involved fibrous roots. A person who has seen the tree in its natural state, would instantly recognize its petrifications. The same may be said of many other specimens. Indeed, they are generally as distinct from each other, as the living fibre of one tree is from that of another. The most of these fossils, I do not doubt, are relics of shrubs and trees identical with those now growing upon the island, though some of them are probably extinct. In addition to these petrifications, specimens of jasper, either pure or mingled with chalcedony, are abundant. They often occur in veins of trap, and abound most in the neighborhood of that formation. Fortification agates are also found in the form of nodules, both upon and below the surface of the earth.

The preceding details open to the geologist a most interesting field of speculation. The extent to which silex, in its purest and most interesting forms, here presents itself, is, I believe, within the same compass of country, without a parallel. It has converted into its own substance organized bodies of the most opposite characters, and in every variety of circumstances. It presents them under all forms and of every degree of color and perfection. It reminds one of Midas's touch, which changed every thing into gold. It will hardly be expected that phenomena, so varied and complicated, can be referred to a common origin. Indeed it is obvious,



from the partial examinations already made, that they are due, not to a single cause, but to a combination or rather a diversity of causes. For example, some of the finest specimens of jasper are found in trap veins, and in the neighborhood of trap rocks. There can be no doubt, therefore, that these are to be ascribed to igneous agency, converting an aqueous rock into this beautiful substance. Lyell, De La Bèche, and other authors, have detailed similar facts occurring in other parts of the world. But in regard to the chert deposits, and the immense quantities of petrified wood connected with them, I think we must look for the agency of some other cause. The circumstance that those beds contain shells, either marine or fresh water, or both, is indubitable evidence, that they are an aqueous deposit. But whether they were originally deposited in their present form, or whether they are altered rocks, is a question about which there may perhaps be some difference of opinion. It is perfectly obvious, that since their formation, they have been subjected to the action of an internal force, which has thrown them up and broken them in pieces, and perhaps in some degree changed their constitution. The island, also, in the trap formation and in the contiguous altered rocks, affords the most ample evidence of comparatively recent igneous action on a broad scale. The position of the strata, also, being conformable with those of the clay formation and not separated by any definite lines, might be considered as favoring the supposition, that they both belonged originally to the same class of rocks. Though I know of no example on so large a scale, where rocks of this description can clearly be traced to such an origin, yet cases of a more moderate extent are not unfrequent. And if we admit, with Lyell, that all the earlier slates are merely metamorphic rocks, changed from sandstone and other fragmentary deposits into their present semi-crystalline forms by internal heat, we seem to have an acknowledged cause adequate to the effect. But, however sublime and interesting such a conception may be, we are not perhaps yet prepared to admit it among the sober truths of geology. But independently of this objection, there are peculiar circumstances, which seem to refer the beds in question to another origin. I have already remarked that the shells imbedded in them show, that they were originally deposited from water; and the fact that these shells are peculiar to the chert—that is, are not found in strata of the clay formation—seems to be

conclusive evidence, that the two classes of rocks were formed under different circumstances. All the chert beds do not, indeed, contain shells; but as they are not found in *any* of the strata of the other formation, they seem to indicate a palpable line of distinction between the two.

If then we refer the chert and the petrifications connected with it to a silicious solution, we may still inquire from what source such a solution could have been derived. It is well known, that pure silicious deposits from hot springs are not uncommon, and that such springs abound in volcanic countries. The Geysers of Iceland are striking examples of this kind. And though Antigua is not at present a volcanic island, it presents the most manifest exhibitions of igneous agency at no very remote period. These silicious deposits and immense fossil transformations may have taken place at that time, either from subaqueous springs charged with silex, or large bodies of water thrown up from the bowels of the earth, and spread out on the surface in the form of basins. The low position of the part of the island where these beds abound, would perhaps favor this supposition. I am, indeed, aware that the subject of silicious solutions is yet involved in great mystery—the process by which nature dissolves silica having yet in a great measure evaded the scrutinizing eye of science—but the fact is among the best ascertained phenomena of geology, and may therefore be employed in the explanation of those deposits, which other circumstances would naturally refer to such an origin.

I cannot but regard the fact, that minute fibres of the roots of trees, and tender leaves and fruits, which must certainly have been destroyed by the least degree of violence, are found among the fossils, as furnishing additional evidence, that the lapidifying process took place in a silicious solution. It does not appear possible, that any great degree of heat should have existed in the superficial strata of the earth, without having destroyed every thing on the surface in the form of woody fibre.

But there is another class of silicious fossils, found in the calcareous formation, at a distance of several miles from the chert deposits, which cannot be explained upon any of the preceding hypotheses. They are the silicified shells and corallines, which I have already described as occurring both upon the surface of the earth and in lower strata. The corallines, especially, are so per-

fectly agatized, that they are cut by lapidaries for jewelry and other ornamental purposes. In addition to these, nodules of chert are found in the clay formation, detached from the beds of chert; and also agate nodules, of which I have before spoken. I do not see how either of these classes of fossils and minerals can be referred to silicious springs; for there is no evidence that such springs have existed where they are found, or that they could, under any circumstances, have been produced by them. I am aware, that Lyell and some other geologists have ascribed analogous phenomena to heated vapors and aqueous solutions charged with silex, and forced up through the superficial strata from the interior of the earth. To say nothing of the adequacy or inadequacy of such a cause to produce the phenomena in question, I think a person who has well considered the concretions with which many clay beds abound—the nodules of flint in chalk—the segregation of mineral matter from the mass with which it must have been originally blended, and its aggregation into distinct crystalline forms—and, also, the contents of metalliferous veins and fossil fissures of rocks, must have recognized an agency better adapted to the present case, than any sublimation from the interior of the earth. Mr. Bird's suggestion, at the last meeting of the British Association for the Advancement of Science, that wood is silicified by electrical influence, is certainly countenanced by many facts; and it is to be hoped, that the experiments which he has commenced on the subject, together with those on the formation of minerals, will do something towards defining another boundary of the immense but mysterious domain of electrical agency. It is possible that all the petrifications of which I have spoken in Antigua, may at length be referred to this source. I see nothing in their character or circumstances which forbids such a supposition; but, in the present state of our knowledge, I think the explanation which I have given is the most probable. I am aware, however, that these fossils and the whole geology of the island need a much more minute examination than they have yet received, in order to draw any theoretical conclusions, in which entire confidence can be placed. I know of no field which would more amply repay the geologist for such an examination; and should the imperfect sketch which I have given, have no other effect than to direct the attention of some one to this island, I shall not consider myself to have labored in vain.

ART. V.—*Remarks on the Geology and Topography of Western New York*; by GEORGE E. HAYES, of Buffalo.

IN a former paper, inserted in this Journal,\* I endeavored to show, that the rock formations in the western part of this state belong to the transition series.† I now propose to offer some observations on the causes which produced the disintegration and removal of extensive strata of these rocks from their ancient beds of deposit, and gave rise to the existing topographical phenomena.

The "saliferous rock" of Prof. Eaton, which I there designated as the old red sandstone, forms the southern shore of Lake Ontario. It has an average breadth of about six miles, nearly a level surface, and is little elevated above the lake. Its southern boundary is marked by the great limestone terrace, under which it passes.

Overlying this old red sandstone, is a group of calcareous rocks—the "geodiferous" and "cornitiferous" of Prof. Eaton—with their accompanying shales; which are evidently equivalent to the mountain limestone of Europe. This formation terminates on the north, in a line nearly parallel to the lake shore, by an abrupt precipice, which forms what is here called the "mountain ridge." The limestone district forms a kind of terrace, bounded on the north by this precipitous escarpment, and on the south by the mountainous region which occupies the south tier of counties.

Superimposed on the mountain limestone, we have a series of shales and slaty sandstones of great aggregate thickness, dipping, as do the formations already noticed, in a southerly direction, but less able to resist the powerful, degrading action to which all have

\* Vol. xxxi. p. 241.

† As early as 1824, Dr. Bigsby suggested that the horizontal limestone of Western New York, as well as that of the Canadas, was "the representative of the mountain or Carboniferous limestone of England." See American Journal, Vol. viii. p. 76 and onward.

Again, in 1829, Prof. Vanuxem stated his conviction that they were transition rocks. Ibid. Vol. xvi. p. 254.

In Bakewell's *Geology*, second American edition, p. 369, the same opinion is repeated; notwithstanding which, from the confusion produced by the introduction of new names, and an apparent disposition to adhere to the classification of Prof. Eaton, they have till very recently been generally regarded as belonging to the secondary class.

evidently been exposed. The deep valleys, which penetrate this formation in a southerly direction from the great limestone terrace; the dividing ridges, also, which have their northern terminations on the same terrace, becoming more rugged and mountainous as they approach the Pennsylvania state line, with their sides deeply furrowed by precipitous gullies and ravines, are sufficient proofs that other causes of denudation than the insignificant streams which traverse these valleys, have been in operation.

One peculiar feature, which adds greatly to the picturesque scenery of Western New York, arises from the fact that many of these valleys have been excavated to a level below the general escarpment of the limestone terrace,\* which consequently forms a barrier at their mouths, and gives rise to most of those beautiful sheets of water so justly admired by the lovers of fine scenery. This feature will again be alluded to further on.

The aggregate thickness of the rock strata, from Lake Ontario to the northern outcrop of the coal in Pennsylvania, is estimated by Mr. James Hall at six thousand and fifty one feet.† How far they extended to the north, and whether the primitive regions on either or both sides of the St. Lawrence, were originally overlaid by them, are questions difficult to solve, and which require the minute and careful examination of the geologist. There are some circumstances, however, which seem to favor this conclusion. It is stated by Dr. Bigsby,‡ when speaking of the horizontal limestone of the Canadas, that "this limestone forms a horizontal girdle around the trap mountain of Montreal, from which, as from a centre, large veins or dykes radiate into the adjoining limestone to the distance of two miles in some cases to my own knowledge, and even to La Chine, according to information received from M. Burnett, chief engineer to the La Chine Canal. The limestone in its upper strata, is brown and crystalline, but black, compact, and slaty below. It contains in immense quantities the organic remains peculiar to the mountain limestone of England and Ireland." It is also stated by Prof. Vanuxem,§

---

\* Since writing the above, my attention has been called to the fact that Mr. David Thomas communicated this phenomenon to Prof. Eaton in 1830. See *American Journal*, Vol. xviii. p. 376.

† *New York Geological Report*, 1838. See Atlas.

‡ *American Journal*, Vol. viii. p. 71.

§ *New York Geological Report*, 1838, p. 255.

that extensive uplifts have been produced on the northern slope of the valley of the Mohawk, "which have deranged the surface, and destroyed the continuity of strata and rock, and created to the casual observer, where the uplift exists, the greatest apparent confusion as to their superposition or order of arrangement." This being the case on the flank of this primitive range, where the sedimentary rocks come in contact with it, is conclusive evidence that they were deposited before the uplifts took place, and may therefore have been spread out, and occupied the whole district.

Whether this were so or not, there can be no doubt that the rock strata in the western part of New York, have been disintegrated and removed, from extensive tracts north of their present limits. It would be absurd to suppose they were deposited in such ridges, with steep escarpments, as we now find them. Nature does her work less artificially. The outcropping edges of these strata; the waterworn and somewhat polished surface of the limestone rocks; the deep valleys which penetrate the shale; and the precipitous escarpments of the more enduring strata, bear the unequivocal impress of secondary causes. All must admit, that the present surface has been shaped by the process of removal, long since that of deposition was completed.

That these rocks were deposited at the bottom of an ocean, is evinced by their fossil contents; that they have been elevated from its watery bed, requires no additional evidence other than their present altitude above its permanent level. If we seek for the cause of this gigantic phenomenon, and trace the ascending strata in a direction opposite to their dip, we invariably come to primitive rocks, or other proofs, equally unequivocal, of volcanic agency.

If, then, as is now very generally admitted, these primitive districts were the original centres of elevation; if the process was gradual and continued for an indefinite period; or was intermittent, being active at one point while dormant at others; these vast changes, as well as those of a like character in other parts of the world, may be explained on rational principles. We need no longer be driven to the poor necessity of supposing a train of causes which may never have existed, and which if admitted to have operated, would probably have produced results far different from those usually attributed to them. Why not then lay aside the fashion of attempting to explain such phenomena by invoking the assistance of the Noachian Deluge, or of tremendous inunda-

tions, sweeping over the tops of the highest mountains, produced "by the flux and reflux of mighty deluges, caused by the sudden elevation of mountain chains in various parts of the globe?"\* Sound philosophy forbids these violent presumptions, particularly when the facts admit of explanations more consonant with the natural order of events.

The condition of a continent, gradually elevated from the ocean, whether by volcanic action, or by the expansive force of crystallization, or by any other cause whatever, would be such as to account for all the geological phenomena hitherto attributed to the mechanical action of water. Every portion of a continent thus reclaimed, must, in succession, have been the bed, and then the beach of an ocean. Every portion must have been subjected to the action of the waves and the tides, when lashed into fury by the raging storm; and for a period of time only limited by the greater or less rapidity of the elevatory process.

When any considerable portion had become permanently elevated above tide water, it would form a water shed, collecting the rain into rivulets, which, finding their way to the ocean, would cut out narrow channels for their beds. But the effect of these streams in the formation of valleys, by denuding and tearing up the rocky strata, would be insignificant in comparison with the action of the surge at those points where their waters were disembogued. As each portion of such channels would successively be exposed to their combined action, and must successively form the bed of an estuary at the valley's mouth, we can readily account for their excavation, to a greater or less extent, in proportion to the hardness of the rocky bed, to the violence of the waves and tides, and the duration of their action. In these estuaries, the comminuted materials would assume nearly a horizontal position, and when left dry, would resemble the alluvial plains or "bottoms," which border most of our rivers. Should a sudden rise of a few feet take place, the water would at first

---

\* Nearly every geological writer, excepting Lyell, whose works have fallen under my observation, even without including those who have evidently been influenced more by theological than scientific views, has drawn largely on these wonderful deluges; and the means by which they are supposed to have been produced, are equally fanciful with the presumption itself. The passage from which the above quotation is taken, (see Hitchcock's *Geology of Mass.*, p. 242,) is perhaps not a very extravagant specimen of this kind of hypothetical reasoning. See also p. 218.

recede; but by the action of the waves and tides on this alluvial mud, they would soon regain possession of that part of their former bed, bordering the stream to a greater or less extent. The centre of the valley would thereby be lowered; and this process being repeated, a series of terraces, or steps, would result, precisely similar to those in the valley of the Connecticut river, which Prof. Hitchcock attributes to the fluvial action of existing streams.\* Valleys could thus be formed where streams of no great magnitude ever flowed, and where currents, except the ordinary ones of the ocean, never existed.

The formation of sand banks and of gravel beds, the rounding and transportation of boulders, the formation and distribution of what we call diluvium, all admit the same simple explanation. Truth is said to be more wonderful than fiction; however this may be, it usually proves more simple than hypothesis. We ought not, therefore, to be surprised, if the phenomena which have led to the crude notion of a deluge, or a succession of deluges, have been produced by an agent no less active now than at any former time; an agent, as much more powerful in its action, as it is permanent in its duration.

Could the Atlantic be drained of its waters, we should find great diversity of surface; and that portion occupied by the Gulf stream, would unquestionably present a succession of beds of sand, gravel, clay, &c., with boulders, more or less profusely distributed, in proportion to their proximity to beds of rock, or cliffs, which have been successively undermined by the continued action of the surge. In other words, we should find the surface covered with diluvium, and arranged, perhaps, very much after the fashion of that in Massachusetts, described by Prof. Hitchcock, as exhibiting "concavities and convexities resembling very much the sandy or gravelly bottom of existing streams, where the current has been very rapid."†

Assuming, then, that the transition rocks of western New York extended far to the north, probably or possibly covering that portion of this State, and of Canada, which now constitute the primitive districts, and which seem to have been the nearest points of disturbance, it must follow as a consequence, that they were the first brought into contact with the waves by the process

---

\* *Geology of Massachusetts*, p. 134.

† *Ib.* p. 144.



of elevation. As few points could then have been permanently raised above the ocean, east of the Rocky Mountains, the action of the surge was unbroken; and it is highly probable, that for a considerable time, the two processes of elevation and disintegration, made equal progress. When, however, the primitive nucleus was laid bare, and Mount Marcy had attained an elevation above the level of the ocean, and bid defiance to its waves and the thunders of its storms, then, and not till then, New York obtained her first "foothold on terra firma." This "war of the elements," however, must have been of long continuance before any portion of the sedimentary rocks were rescued from the dominion of the ocean. Mount Marcy has an elevation of 5467 feet;\* while Roundtop, of the Catskill, composed of sedimentary rocks, is but 3804 feet;† and from the best data in my possession,‡ the highest peaks of the dividing ridge which separates the streams flowing south from those which take a northern course to the St. Lawrence, do not probably exceed 2000 feet above tide water. The elevation of this part of the continent, therefore, must have been exceedingly gradual, to give time for the degradation and removal of such an immense amount of matter; and it would seem probable, that it was not till the shoals had become so extensive as to obstruct the further action of the waves and arrest the removal of the detrital matter, that this ridge attained a permanent elevation above tide water.

Whether it prove true or not, that these rocks have been removed to so great an extent as the foregoing train of reasoning presupposes, is of little consequence to the main question under consideration. The broadest ground has been assumed, in order to show that the causes assigned for the topographical phenomena of this part of the state, are abundantly sufficient, not only to account for what we actually witness, but also for any extent of change which facts may hereafter demonstrate.

Supposing even, that no very great extent of strata have been removed, that these ancient deposits thinned out rapidly on the north, and that the surface has only received such modifications as are every where apparent, from the remaining strata; is there

---

\* Prof. Emmons, *New York Geological Report*, 1838, p. 244.

† Prof. Emmons, *New York Geological Report*, 1837, p. 100.

‡ See *Am. Journal of Science*, Vol. xxxiii. p. 122.

any power in nature with which we are acquainted, other than the one suggested, capable of effecting the change with so much regularity and order? Every inch of surface has been subjected to the denuding agent; the tops of the highest hills, no less than the limestone platform, bear the scars and scratches of the contending elements. The surface, except on the steep escarpments, is every where covered with a thick coat of diluvium, composed of water-worn pebbles, boulders, sand, &c. The valleys are often deeply filled with these materials, more or less comminuted; and sometimes they contain large quantities of detrital matter, little worn, evidently derived from strata similar to those of the adjoining hills.

The condition of an ancient inland lake\* which has burst its barriers and disappeared, could not account for these things; nor could its drainage from a higher to a lower plain, as suggested by Prof. Rogers,† excavate the deep and long ravine through which the Niagara now flows. It is equally idle to suppose, that the existing streams have excavated the valleys through which they flow; much less could they have effected the comminution and uniform distribution of the coat of diluvium. And as for a sudden inundation, deluge, or any succession of them, (aside from the improbability of nature stepping so far out of her ordinary track,) had they been sufficiently powerful to tear up the strata, and lay bare so large a district of the limestone rocks, we should hardly expect to find the work so systematically accomplished. A great deluge, it is true, may account for the uncovering of the limestone; and by sweeping heavy boulders over its surface, might have produced the "diluvial scratches." But portions of this rock are highly polished, and indicate a much longer continuance of the watery friction than is consistent with the notion of a deluge. The systematic and parallel arrangement of the long sloping ridges, composed of shale and sandstone, no better adapted to resist a sudden and overwhelming inundation than

---

\* The numerous proofs that this whole region was once submerged, early led to the theory of an ancient lake, far more extensive than any or all of the existing ones put together. Had the pass through the Highlands been closed up, and a barrier of sufficient height,† existed across the valley of the St. Lawrence, such a lake must have been the result. But these have not been rendered probable by any indications hitherto discovered; and there is no reason for presuming that they ever existed.

† See American Journal, Vol. xxvii. p. 329.

those portions which have been removed from the intermediate valleys, could hardly have resulted from any sudden irruption of water. The strata would have been indiscriminately torn up; and the ruins, instead of being finely pulverized, and beautifully distributed over the surface, to hide the "nakedness of the land," and prepare it for cultivation, would have been thrown together by the eddies of the currents into unsightly heaps; and this fair region, instead of being the "garden of the West," would have presented to view the uncouth surface of barren rocks, and would have offered, comparatively, few inducements for the laborious enterprise of the agriculturist.

But to return.—Suppose this dividing ridge to have attained an elevation above tide water. The southern slope would present to the waves the smooth surface of the strata; whereas their baseting edges would be exposed on the northern declivity. Deep notches would soon be worn into it from both sides, which would occasionally interlock, and sometimes meet; thereby cutting the ridge into a series of islands, with transverse passes between them. These islands now form the highest peaks of the range; and the passes correspond to the elevated valleys, in which the principal streams take their rise.

When a considerable elevation had been attained, small streamlets would collect; and at the places where they entered the sea, the waves and the tides would be more powerful in tearing up and removing the shaly rocks, than at any other points; and thereby a system of valleys of denudation, precisely similar to those we here witness, would be commenced. On the southern slope, where the streams flowed over the inclined planes of the strata, in the direction of their dip, they would meet few obstructions, and lakes would seldom be formed. Not so on the northern declivity. There, where the streams flowed over the edges of the strata in an opposite direction, each harder layer, being longer able to resist the denuding process, would, for a certain distance, form the bed of the stream; and the dip, being in the direction opposite to the current, a succession of pools of slack water would result. These phenomena may frequently be illustrated by the small streams on the northern slope of a hill, where some of the strata are composed of hard, close-grained graywacke; while those on the southern declivity of the same hill, present an opposite result.

The same thing occurs in many of the valleys, but on a vastly larger scale; the shale and sandstone being cut through and removed down to the surface of the mountain limestone, as before stated. In cases like this, the latter rock, at its northern outcrop, forms a barrier across the mouths of such valleys. The streams which flow into them, are obstructed at these points; and lakes of greater or less magnitude result. All of those whose outlets are situated on the line of bearing of the limestone strata, which extends from the Niagara to the Hudson rivers,\* as Canandaigua, Seneca, Cayuga, Skaneateles, and some of the smaller lakes, doubtless owe their origin to this peculiar feature in the dip and arrangement of the strata. Other valleys, also, in this range, were probably once occupied by lakes. In that of Bristol, the depth of the alluvium is unknown. In sinking wells, trunks of trees are met with at considerable depths; and in one instance, a frog is said to have been dug up, which, on being exposed to the vivifying influence of the sun, took advantage of his newly acquired freedom, and hopped off, with much apparent satisfaction.

Lake Erie is somewhat similarly situated, in as much as the floor of its basin, and the barrier at its outlet, are formed by the mountain limestone. But, instead of lying at right angles to the bearing of the strata, it occupies a basin at the junction of the shale and limestone, formed by the removal of the outcropping edges of the former. Its longitudinal direction, therefore, has a general coincidence with the line of bearing of the strata; and its northwestern shore, consequently, is formed by the mountain limestone, which, in that direction, attains an elevation above the surface of the lake, and underlies the peninsula in Upper Canada, included between Lakes Erie, Ontario, Simcoe and Huron.†

Before this limestone terrace had become sufficiently elevated to shut out the sea from the basins now occupied by these lakes, their shores were swept by its waves, and they differed in no material features, from the estuaries of rivers, or the bays which indent our sea coasts at the present day. It is highly probable, also, that a strong current set in through the Gulf of St. Lawrence, and found its exit through the valleys of the Mohawk and

---

\* Prof. Vanuxem, New York Geological Report, 1838, p. 272.

† Dr. Bigsby, American Journal, Vol. VIII. p. 78.

Hudson; forming for itself a channel through the Highlands, if that pass did not previously exist.

The large quantity of primitive boulders scattered over the surface, and distributed promiscuously through the diluvium, would seem to indicate some such movement. That they came from the north, has often been suggested; and the fact, that the nearest primitive rocks, in place, occur in that direction, renders the assumption highly probable. I have noticed one within the boundaries of this city, containing the Labradorite. It is doubtless identical with the Hypersthene rock in Essex county,\* or with a similar rock described by Dr. Bigsby, as occurring on the northeast coast of Lake Huron,† and probably came from one of those locations. That loose masses of rock have been frozen into cakes of ice, and widely distributed over the surface of the earth, seems to admit of no doubt, as the same phenomenon may be witnessed in all currents of the ocean which flow from high latitudes towards the equator.

But by whatever agent these boulders have been transported, whether by the buoyancy of congealed water, and dropped in a more southern latitude, when disencumbered of their icy bark, or, swept along by the unaided force of currents, tides and waves, they have left their "marks" engraven on the surface of the limestone rocks, in characters which bid fair to prove indelible, and by which we may obtain a clew to their early history.

The Niagara river takes a course at right angles to the general direction of Lake Erie, and, in its descent to Lake Ontario, cuts directly across the limestone terrace, which, at this point, exceeds thirty miles in breadth. The upper strata of this lime-rock, contain layers and strings of chert, which form a kind of network, and render them almost incapable of disintegration from ordinary causes. These strata form both the barrier at the outlet of Lake Erie, and the rapids, between Buffalo and Black Rock. Below the northern outcrop of these cherty layers, which may be regarded as forming a kind of step on the terrace, and upon those strata which terminate at the mountain ridge, lie the shallow valleys of the Tonnewanda and Chippewa creeks, one of which flows to the west, and the other to the east; both entering the Niagara between Black Rock and the Falls.

---

\* See New York Geological Reports, 1837 and 1838.

† American Journal of Science, Vol. VIII. p. 69.

The northern boundary of the terrace, as before stated, terminates by an abrupt precipice, rendered more rugged and forbidding in appearance, by the disintegration of the shale on which it rests; causing the harder strata to project from the bank, and when sufficiently undermined, to be precipitated to the plain below. This action goes on, till the talus covers the face of the shaly strata, and protects them from further disintegration. The mural precipice above might apparently remain for ages, without suffering material change. This escarpment is indented by numerous ravines which penetrate the bank to a greater or less distance. The streams which now occupy these indents, are mostly insignificant in size; while many, some of which extend farthest back from the general line, drain but a few hundred acres, and are only occupied by the water which oozes from their banks, except during heavy rains, and the thawing of the snow at the end of winter. When viewing this escarpment, it is difficult to resist the conclusion, that the terrace once extended much farther north, and has been undermined and broken down by the action of the surge.

Not unfrequently, persons who visit the falls of Niagara, and superficially examine the topography of the surrounding region, conclude, that the cataract was once located at Lewiston, seven miles below its present location. Full of this grand conception, and without taking into the account the causes which gave rise to these general topographical features, they first attempt to ascertain its perpendicular height at that time. Having settled this to their satisfaction, they often launch forth into a train of calculations, alike unprofitable and extravagant; first to determine their age, and then, the number of years they will occupy, in their backward course, before they will invade the rocky ramparts of Lake Erie.\* But, as in the onset, the origin of the cataract, one of the most important terms of the problem, is entirely omitted, their conclusions are wholly erroneous, and are entitled to as little consideration, as the "baseless fabric of a dream."

---

\* After all, perhaps those geologists who only view the falls in theory, are the most prolific in drawing such conclusions. A series of lakes, situated like this chain through the centre of North America, with rocky beds which shelve gently from the shore, might perhaps be drained in the course of ages, by the gradual wearing down of their outlets; but never so rapidly as to produce inundations, such as are assumed to have happened, at one time or other, over most parts of the earth; and which this hypothetical deluge, which is to inundate the fair valley of the St. Lawrence, some 30,000 years hence, is cited to illustrate.

In order to understand the origin, and to account rationally for the present location of this cataract, let us go back to the time when the process of elevation was going on, and the highest parts of this limestone ridge had just appeared above the surface at low water. It then became a partial barrier across the ancient gulf, and cut off the free communication between its southwestern extremity (now Lake Erie) and the northeastern section. Across the lowest points of the reef, a strong current would be thereby produced, alternately flowing in opposite directions, during the ebb and flow of the tide. As the reef became more elevated, the currents would gradually become more and more confined to those passes where the fewest obstructions existed. In process of time, some one of these gaining the ascendancy, the whole force of the conflicting currents would be concentrated at one point. The power of the waves and influx of the tide, operating from below, would be applied to the best possible advantage, in tearing up those strata which most impeded their course; while the current, combined with the receding tide, would carry off the fragments. In this manner the valley of the Niagara was doubtless formed; and circumstances, which will be detailed further on, render it highly probable, that the ledges above the cataract, which form the rapids, had the same origin.

That such a strait did exist, after Lake Erie became fresh, and before the deep gorge below the falls was excavated, is certain. The ancient banks may be traced on both sides of the gorge; and that portion of the ancient bed, from the brink of the precipice up to the level of the river above the rapids, contains a fresh water deposit, embracing shells of species identical with those now inhabiting the waters of Lake Erie.\* This deposit consists principally of gravel, containing fragments and boulders of primitive rocks, but chiefly made up of water-worn fragments of the limestone itself. At some places, at the depth of from two

---

\* The *Unios* appear to be a thick-shelled species, and consist of water-worn fragments. I have not met with a single whole valve, although recently I had a good opportunity for examination, where an excavation for a mill-race was in progress; and likewise on Goat Island, where the bank had been undermined and caved off. They are exceedingly friable, and will scarcely bear handling. Some of the small univalves, however, as *Melania*, *Planorbis*, *Paludina*, &c., and one minute bivalve, which I take to be a *Cyclas*, are not only abundant, but well preserved, and probably inhabited the locality. The *Unios* may have been brought down by the river current.

to four or six feet, it is underlaid by a very fine deposit of clay, horizontally stratified, containing fragments of limestone similar to the rock beneath. It appears to belong to the extensive clayey deposit, which covers large tracts on the limestone range, and in which I have never met with any fossil remains; although they may, and probably will hereafter, be detected.

The extent and power of these counter currents, which excavated the valley of the Niagara, and assisted in cutting down the ravine below the falls, remain to be determined, when the laws which govern the ebb and flow of tides shall be fully developed, and when the shape of this ancient gulf, at this stage of elevation, shall be approximately ascertained. It is well known, that the height and violence of tides are materially modified by the direction of prevailing winds, by oceanic currents, and by the shape of coasts and estuaries. At some places on the coast of England, as in the Bristol channel, the tide rises forty-two feet,\* and in the Bay of Fundy, to the enormous height of from sixty to one hundred feet.† As no land which is now less than 575 feet above tide water, had then emerged from the ocean—unless its rise was less rapid than this region, and the reverse is probably true of the primitive districts—this arm of the sea had ample communication with the Atlantic, through the Gulf of St. Lawrence, and the valley of the Hudson. At this stage, the primitive range in the north of this State, and those in the New England States, were but islands; and it is not improbable, when the relative levels shall be ascertained, that other passes will be found, at a less elevation above tide water than Lake Erie. Receiving the tidal wave, therefore, through these different channels, which would meet in the vicinity of Lake Ontario, an additional impulse would be communicated to it, and a tide would probably result, little inferior to that at either of the places above cited.

There is another phenomenon connected with tides, which ought not to be forgotten. If, as suggested, this strait received a powerful tide, it might, when rushing up the narrow gorge above Lewiston, have produced that kind of tidal wave, called the "Bore," which, says Lyell,‡ "is sometimes produced in a river, where a large body of water is made to rise suddenly, in conse-

---

\* Lyell's Geology, Vol. 1, p. 238.

† See Audubon's Birds of America, Vol. II, p. 448. Also, American Journal, Vol. xv, p. 132. Also, Rees's and the American Encyclopedias.

‡ Lyell's Geology, Vol. 1, p. 274.



quence of the contraction of the channel. This wave terminates abruptly on the inland side, because the quantity of water contained in it is so great, and its motion so rapid, that time is not allowed for the surface of the river to be immediately raised by means of transmitted pressure. A tide-wave thus rendered abrupt, has a close analogy, observes Mr. Whewell, to the waves which curl over and break on a shelving shore." This phenomenon takes place in the river Severn, which enters the Bristol channel, where the Bore, during spring tide, is sometimes nine feet high, and rushes up the channel with extraordinary rapidity.\* It also occurs in the Ganges, the Burrampooter, and the Hoogly rivers; sweeping off herds of cattle, or whatever else may be overtaken in its course, and occasions more or less interruption to the safe navigation of all these streams.†

At any rate, the tide in the vicinity of the Niagara must have been very considerable; and its power, combined with the dashing of the waves, seems to be the only rational cause which can be assigned for the excavation of the numerous ravines already noticed. In a paper by Mr. James Geddes, read before the Albany Institute,‡ the fact, that they owe their origin to other than existing causes, is clearly established.

When the elevation had so far advanced as to confine the current exclusively to the valley of the Niagara, and the channel below the present falls sufficiently deepened to receive and confine the tidal wave within its rocky walls, a power was brought into active operation which it is difficult fully to conceive without witnessing its effects on some of the iron-bound coasts of this continent. The basin of Mines, and its vicinity, at the head of the Bay of Fundy, would probably be a fit place to study the effect of causes which were once active here.

When we contemplate these powerful agents, which, in every country, have had so much to do in shaping the surface of the earth, and consider, that in the natural order of events they must have been active here; when we find the proofs of their visitation engraven in characters as enduring as the continent itself, we can hardly doubt that they played an important part in excavating the deep channel below the falls. And when we contem-

---

\* Lyell's *Geology*, Vol. 1, p. 274.

† Rennell, see *Philosophical Transactions of the Royal Society*, 1781.

‡ See *American Journal*, Vol. 11, p. 213.

plate them acting in concert with the river current, we cease to wonder that the chasm should have attained its present length and depth, and that the cataract should occupy a place at the distance of seven miles above its apparent natural position.

How much is due to each agent separately, can hardly be determined. We must bear in mind, however, that the fall was nothing at first; that as the elevation advanced, the river became more rapid; that finally, when the limestone was cut through and somewhat undermined by the disintegration of the shale below, and not till then, a distinct cataract could have been produced. Until then, the tides and dashing of the surf were probably most efficient in tearing up the strata from their rocky beds, and comminuting the fragments; while the river would guide the course of their operations, and remove the detrital matter from its bed.

What distance the cataract has receded since that time, is a problem equally difficult to solve; but there are some indications which will enable us to approximate to the truth. The rapids above the cataract, and the whirlpool below, are points where phenomena exist incompatible with the common theory. If it should be established, that the conformation of the whirlpool is such, that it could not have resulted on the theory of recession, this "endless saw" must relinquish its claim to four long miles of excavation for which it has received credit. And if the rapids above the cataract existed prior to its present location, we may presume that they are but the upper extremity of an ancient inclined plane, or rather, succession of ledges, which existed before the limestone strata were cut through.

Goat Island is situated on the brink of the precipice, and divides the water into two unequal sheets. It is based on the limestone ledges which form the rapids, and the highest part of its surface is on a level with the river above their commencement. Near the upper extremity of the island, the rocky bed rises just sufficiently above the surface of the river to divide the stream, and deflect the branches somewhat from the original course of the current. It is to this circumstance alone that the island owes its existence; for its lower extremity is covered with a tertiary deposit of gravel and clay, which can offer no adequate resistance to the boisterous current, which seems anxious and ready to sweep the whole island into the gulf below.

Wherever the strata come in sight on the island, they conform to those in the bed of the rapids, and are equally water-worn and denuded. A portion of rock, recently uncovered by the encroachment of the rapids upon the west bank of the island, presents the same features, and can only be distinguished from those which have buffeted the fury of the torrent from time immemorial, simply by the knowledge of the naked fact of their recent exposure. One of the principal ledges, also, which extends entirely across from the Canada shore, may be traced some distance into the island; and its water-worn and ragged masses, projecting above the soil, afford conclusive proof, that the conformation of the bed of the rapids, and the surface of the rock which underlies the tertiary on the island, was effected by the same agent and at the same time.

No rapids could then have existed at this place, for the island has since received a tertiary deposit of clay, horizontally stratified, which is overlaid by one of gravel containing fresh water shells. These two deposits, at the lower end of the island, between the cataracts, measure thirty three feet in thickness. I have already mentioned, that this clay resembles the numerous beds in this vicinity; they all probably belong to the same general deposit. Mr. Rogers thinks this deposit took place from the waters of a tranquil lake.\* The fact, however, of its containing gravel stones and water-worn fragments of the rock on which it rests, (as do all of these beds,) would seem to indicate a different origin. I suspect this clayey deposit may have been brought on by the overflowing of tides, after the rocky bed had become so much elevated as to be protected from the violence of the surge. The surface, where large tracts are overlaid by it, is marked by meandering swales, which strike the observer as fit channels to conduct the water back to its proper level at ebb tide, after having parted with a portion of its sedimentary matter. No proof surely could be more conclusive than these tertiary beds on Goat Island, that the *rapids* have not receded,—whatever may be the fact in regard to the cataract itself.

From the Falls to the Whirlpool, a distance of about three miles, I have observed no indications which have a direct bearing on the question of recession; but at this latter place, phe-

---

\* American Journal, Vol. xxvii, p. 330.

nomena are presented perfectly incompatible with that theory. To enable the reader more clearly to comprehend the features of this singular spot, and also of the Devil's Hole, one mile further down the river, the following wood cut is introduced.\*

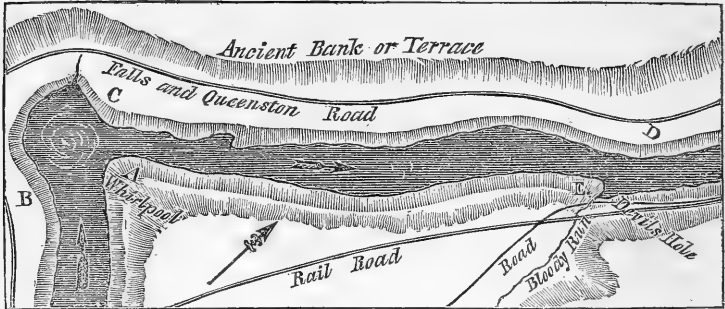

I wish to call attention, particularly, to the dry ravine which enters the Whirlpool from the northwest. It has a gradual ascent from the bed of the river to the level of the surrounding country, and disappears east of the road from the Falls to Queens-town. It is similar, in all respects, to those which indent the general line of the escarpments from Hamilton, U. C., to Lockport, N. Y.,† and was evidently produced by the same means. Had this ravine been excavated by a branch of the river, which discharged its waters into the basin of the whirlpool, we could surely trace its bed a greater distance than one mile; and instead of a gradual ascent, we ought to find the limestone ledge projecting over the whirlpool, as it does over the basin, into which the river now tumbles. It will also be observed, that the direction of this ravine is a continuation of the course of the river where it enters the whirlpool. It is manifestly impossible, therefore, by any position of the cataract, to bring the action of the river to bear upon its upper extremity, where it is wholly within the limestone ledge. If the cataract was placed across the river from A to C, the current would be drawn in that direction; if from A to B, it might undermine the bank where the ravine is situated, but the more violent its action, the steeper would have

\* Taken, (but somewhat corrected,) from a map of a contemplated ship canal around the Falls of Niagara, by Lieuts. T. F. Drayton and J. G. Reed, U. S. Army.

† American Journal, Vol. xi. See wood cut, p. 215. Also Vol. xiv. See map of Welland canal district, by William Hamilton Merritt.

been the escarpment. In either case, the ravine could not have been formed.

But let the reader suppose the river flowing nearly on a level with its banks; the high prominences, A, B, C, directing the course of its current, and the less elevated bank, near the ravine, flooded at high tide. Let him imagine such a tidal wave as the Bore, or even an ordinary flow of a few feet rise, meeting the current of the river at this place, and he will readily perceive, that both currents would be deflected towards the ravine, which, as the elevation advanced, would be left dry at its upper extremity, and new portions of its rocky bed exposed to the watery friction. When the bed of the river at the whirlpool had sunk below the limestone strata, we may suppose the inclined plane, to which I have alluded, and of which the present rapids formed the upper extremity, had attained its greatest extent. The more rapid disintegration of the shale would then undermine these harder strata, and the work of recession commence; but whether at, or above the whirlpool, I have no data on which to form an opinion; certainly not below, however.

There are other indications, further down the river, which strongly corroborate these views. The indent on the American side, called the Devil's Hole, is a notch, embracing about two acres; and to those who have not seen the place, its name, perhaps, may convey some idea of its gloomy and forbidding aspect. It is difficult to account for the excavation of this notch on any supposition but that of a force applied in the direction of the river from below. By inspecting the wood cut, it will be perceived, that it is but the continuation of the gorge; and this strikes the beholder with peculiar force when standing on the point E, and looking down the river. The high bank, also, on the opposite shore, marked D, occupies a position well calculated to deflect the tidal wave directly into this notch. Bloody Run, which is laid down as entering the river through this chasm, drains but a few hundred acres, and is so situated, that a branch of the river could never have flowed through its channel; were it not so, the thick bed of clay and gravel, which occupies the surface to within a few feet of the precipice, would be equally conclusive against the supposition. Its bed is perfectly dry, except during wet seasons of the year; and it cannot be supposed to have done much towards this gigantic work of excavation. The name

of this stream seems to be in very good keeping with that of the gorge, through which it enters the river, and was given in commemoration of a tragic scene once enacted at this place.\*

When the passes by which this inland sea communicated with the Atlantic, became contracted and shoaled, by the progressive elevation of the continent, it approximated to the condition of a lake. The same process which took place when this limestone reef emerged, was repeated, but in a new place. The tides and waves began to spend their force on obstructions at a lower level; and when the plain, on which Lewiston is situated, emerged, it is probable the change was nearly effected.

We there find indications of an ancient shore, composed of rounded beach gravel, elevated a few feet above the general level of the surrounding surface, and having a direction parallel to the present shore of Lake Ontario. It is generally supposed—and the geologist assigned to this district, in the survey now going on, favors the opinion†—that Lake Ontario once had a greater eleva-

\* The following brief account of that bloody exploit, as related by Farmer's-Brother, a celebrated Seneca Chief, who himself headed the attacking party, is extracted from Thatcher's Indian Biography, and may be interesting to some of the readers of this journal who have not seen that work. "There, with a party of Indians, he lay in ambush, patiently awaiting the approach of a guard that accompanied the English teams employed between the Falls of Niagara and the garrison," (Fort Niagara,) "which had there lately surrendered to Sir William Johnson. The place selected for that purpose is now known by the name of the Devil's Hole, and is three and a half miles below the famous cataract upon the American side of the strait. The mind can scarcely conceive a more dismal looking den. A large ravine, occasioned by the falling in of the perpendicular bank, made dark by the spreading branches of the birch and cedar, which had taken root below, and the low murmurings of the rapids in the chasm, added to the solemn thunder of the cataract itself, conspire to render the scene truly awful. The English party were not aware of the dreadful fate that awaited them. Unconscious of danger, the drivers were gaily whistling to their dull ox-teams. Farmer's-Brother and his band, on their arrival at this spot, rushed from the thicket that had concealed them, and commenced a horrid butchery. So unexpected was such an event, and so completely were the English disarmed of their presence of mind, that but a feeble resistance was made. The guard, the teamsters, the oxen and the waggons, were precipitated into the gulf. But two of them escaped; a Mr. Stedman, who lived at Schlosser, above the falls, being mounted on a fleet horse, made good his retreat; and one of the soldiers, who was caught on a projecting root of a cedar, which sustained him until assured, by the distant yell of the savages, that they had quitted the ground. It is the rivulet, pouring itself down this precipice, whose name is the only monument that records the massacre. It is said to have been literally colored with the blood of the vanquished."

† Mr. James Hall: see New York Geological Report, 1838, p. 310, and onward.

tion than at present, and was on a level with this ancient beach, and that, from some unexplained cause, it has subsided to its present level and dimensions.

I have long suspected some fallacy in this theory, and have anxiously awaited the result of accurate levelings. It may be deemed equally probable, and more consonant with the views here suggested, to suppose, that, after the principal tides were shut out from this inland sea, and the water had become nearly or quite fresh, but while it was on a level, or nearly so, with the Atlantic, the uplifting process became stationary, for an indefinite period; during which season of quiescence, this beach was thrown up. At some subsequent time, the disturbing force again became active, raising the basin of Lake Ontario, above the further influence of the ocean; and fixing the present levels and boundaries of this part of the continent. Should the statement of Mr. James Hall prove well founded, and actual admeasurement confirm the estimates of his assistant, Dr. George W. Boyd, this view of the subject will be clearly established; although these gentlemen do not seem to have drawn such an inference. Mr. Hall states the elevation of the ridge in Niagara county, at about 160 feet; and admits variations in its level, of a few feet.\* Dr. Boyd estimates its elevation in Wayne county at more than 200 feet.† If this diversity of level actually exists—as I have long suspected would prove to be the case—it fixes the elevation at a period subsequent to the formation of this beach. Its increased elevation, in approaching the primitive district, is what should be inferred, on the theory, that those districts were the original centers of elevation. And the variation of forty feet in about one hundred miles, is quite as much as ought to be expected from an elevation of but four hundred feet, which is the height of this ridge, or ancient beach, in Niagara county, above tide water.

---

\* Second New York Geological Report, p. 310.

† Ibid. p. 312.

ART. VI.—*On Electro-Magnetism, as a Moving Power*; by  
CHARLES G. PAGE, M. D., Washington City, D. C.

AFTER the first successful magnetization of soft iron by the galvanic current, and more especially on the announcement of Prof. Henry's signal experiment, the suggestion naturally occurred to every enquiring mind, cannot this immense attractive power, so easily developed and controlled, be rendered available as a mechanical agent? The first successful step towards the attainment of this object, of which we have any record, was made by Mr. William Sturgeon, a distinguished philosopher of England. The next original invention by which an independent motion was obtained from electro-magnets, was the oscillating apparatus of Prof. Henry, described in a previous No. of this Journal. The next invention of any note, was that of Dr. Ritchie, now very well known as Ritchie's revolving magnet. This ingenious and simple contrivance, will always be regarded as a superb philosophical apparatus. It does not exhibit that astonishing rapidity of rotation, as if its poles were changed by the use of solid conductors, but as an instrument is more pleasing, as it shows at the same time the magnetic rotation, the vivid sparks, and in the dark a beautiful optical illusion. Some time after the announcement of this instrument in this country, Mr. Davenport of Vermont published in this Journal a partial description of an electro-magnetic engine of considerable power. It appeared that Mr. Davenport had for a long time been occupied in the subject, and was not aware of what had been previously effected by others. Some time prior also to this period, some interesting experiments were described in this Journal, by Dr. Edmondson of Baltimore, and, indeed, this gentleman appears to have been the first in this country who produced a rotary electro-magnetic machine. Since the announcement of Mr. Davenport's invention, the innumerable experiments which have been performed in this country, in England, on the continent of Europe, and even in the East Indies, have all contributed to prove that the smallest engines which have been made, have had by far the greatest proportionate power. Since I first gave the subject any attention, I have had sixteen different models constructed, each involving distinct principles. From all these experiments the inference is still the same, viz.



*the fewer the magnets and the smaller their size, (with certain limits,) the greater the ratio of mechanical power obtained.* Such experience as this appears discouraging, but is by no means sufficient to prove the experiment infeasible. The numerous failures are such as have been incident to the prosecution of all inventions in their early stages. It is much to be regretted, that in our country the invention should be a subject of mercenary speculation, when in reality it has no value except as an experiment, and that the public have been so far misled, as to withdraw that countenance and encouragement which the experiment really merits. We can not but deplore, that such an interesting branch of science should be so traduced, and that the very name of electro-magnetism should be coupled with empiricism.

There can be no doubt in the mind of any one who may have seen an electro-magnetic engine, that it furnishes a mechanical power already applicable and useful to a certain extent, provided the maintenance of that power be not expensive and difficult. The application of this power cannot be expensive, *if the mechanical or working power of any number of magnets in a machine increase in the direct ratio of the aggregate attractive force*; that this rule does not hold in any of the plans of which, hitherto, we have had any description, I shall prove, when the *cause* comes to be considered. Yet in certain arrangements this law must obtain, and although the necessary construction be at present somewhat complicated, yet ultimately it doubtless will be simplified. At present, we have no means of computing the extent of magnetization which may be effected by a galvanic pair of given surface, say a single inch, freshly immersed. It must very far exceed that which we ordinarily recognize in our experiments. By great care, I have succeeded in producing an attractive force of over 800 pounds, by a galvanic pair having only ten square inches of zinc exposed; whereas with the usual arrangements, it required two or three square feet to produce the same power. This power, though so great for the means used, yet probably was not near the maximum procurable from the same zinc surface. It would seem, then, that if the above mentioned ratio exists in attainable forms of machines, the application of the power cannot be otherwise than cheap. The difficulty of maintaining a uniform power is by no means insurmountable. The faults hitherto have been, the wearing and alloying of the pole-changer

and springs, and subsidence of battery action, which are easily demonstrated to be remediable. It is not to be presumed that in the present age, or perhaps ever, we shall arrive at a power from electro-magnetism, which shall supplant the steam-engine, in its grander operations. Indeed, it is not essential that this should be the case, to render the invention even invaluable. Incalculable benefit would be conferred upon society, if a new and simple mechanical power could be procured, available from that of a single man to one or two horses. A multitude of mechanical operations are now carried on by animal or water power, for which a low steam power cannot well be used, from the fact that steam-engines below one horse power, are hardly worth the making, and are troublesome and expensive. A very natural question here arises; if one horse power can be obtained by electro-magnetism, why cannot two horse, or any extent of power, be made? Theoretically considered, it can be; and electro-magnetic powers can only be limited by the means used. But practically we have already been taught, that (unlike other powers, where the largest engines are the most simple and least expensive) electro-magnetic engines above a certain limit, increase in complication and expense in a much greater ratio than the power obtained. To ascertain this limit, the precise point where economy ceases, is now the great, and ought to be the only object of research.

There seems to be little doubt, from the data we already possess, that a power equivalent to one horse may be obtained with economy. Before proceeding to point out the obstacles in the way of the application of this power, the following general rules are offered as deduced from actual experiment.

*First.*—Whatever be the rate of passage of the galvanic current, the full magnetization of a bar of iron requires time in proportion to its hardness and *size*. Mr. Wheatstone has calculated the rate of electro-motion, in good conductors, to be 188,000 miles a second. Admitting that electricity, even in its lowest state of tension, passed at this rate, still the time required in giving a very large magnet its maximum charge, would be a perceptible item. Therefore a single impulse or discharge, as from a common electric battery, (be the quantity ever so great,) scarcely magnetizes. The necessary consequences of this law are, first, small magnets answer better than large; second, change of poles, to produce motion, must be dispensed with, if the introduction of repulsive

powers be not more than sufficient to compensate for the loss; third, the power of a machine does not increase with its velocity.

The *second* general rule is, that integrity of the conducting and magnetizing wires, is of the utmost consequence. By integrity, I mean not only entire absence of flaws, fractures, and imperfectly soldered joints, but a perfect molecular arrangement. Bending or twisting a wire, impairs its conducting power; and a wire which has once been wound upon a magnet, is not fit for the same purpose again.

*Third.*—It is well known that the repulsive power is not equal to the attractive, of the same magnet, be it even of the hardest steel. The difference between the two forces is still greater in electro-magnets, and for the same reason. There is also another cause which operates to diminish the repulsive forces of electro-magnets, which will be considered when treating of the influence of secondary currents.

*Fourth.*—Two electro-magnets, unequally charged, attract each other, even when similar poles are presented. The same is true of the steel magnets, but not to so great an extent.

*Fifth.*—Change of poles cannot be introduced in a machine, for the following reasons: 1. It requires time; and during this time, the magnets which change poles, are attracted and retained somewhat by those which do not change. 2. Similar poles will attract and produce back action; for, unless the magnets which change poles be favored by excess of battery, or superior conductors, they cannot receive near the same charge, as those which do not change: for, first, there is magnetism of an opposite character to be overcome; and secondly, two breaks in the galvanic circuit are necessary to produce change of poles. 3. Two magnets which have a statical repelling power, that is, a power which will merely keep them asunder when the machine is at rest, will attract each other when the machine is in motion. This singular fact is a consequence of secondary currents, shortly to be described.

The next law to be observed is, that the sum of the forces of any number of magnets charged by one battery, is in a diminishing ratio to the forces of one magnet charged by the same battery, provided the battery be not in excess. Hence there must be a great loss of power, when a number of magnets are charged

by the same battery. The secondary current has also an important bearing upon this case.

One of the greatest obstacles we have yet to encounter, in the prosecution of this subject, is the influence of secondary currents to diminish the power of a machine, just in proportion to the use of those which at present we consider the most obvious means of increasing the power. By secondary currents are here meant, those currents which flow in the conducting wires, either with or against the battery current, and are consequences of the development or cessation of magnetism, or of the approximation or recession of two charged magnets. These currents are found to obey the following laws:

The battery power remaining the same, the more coils surrounding the magnet, the greater the power of the secondary current.

After one coil has been wound upon a magnet, the addition of a second coil increases the power of the secondary current in a greater ratio than the power of the magnet. Hence, as it has been found, some machines have had greater power with two coils of wire on the magnets than with four or five; although actual experiment proves, that the real or statical power of the magnets is considerably greater when a large number of coils is used. According to Faraday's interesting discoveries, when magnetism is developed in a bar of iron inclosed within a helix, a secondary current flows in the helix contrary to the battery current. When the magnetism ceases, the secondary flows in the same direction as the battery current. The development of magnetism is equivalent to the determination or movement of magnetic forces towards the poles. The cessation of magnetic power is equivalent to the retreating of those forces. Now the approximation of two electro-magnets attracting each other, occasions an additional movement or accumulation towards the poles, and consequently develops a secondary current flowing against the battery current. The power of this current is in proportion to the velocity with which the magnets approach each other.

When two such magnets in proximity or contact are separated by mechanical force, a recession of accumulated forces takes place, and consequently a secondary is developed, flowing in the same direction as the battery current. Therefore, an independent motion of an electro-magnetic machine diminishes the influence of

the battery current in proportion to its velocity ; whereas the application of mechanical force to drive the machine against its own motion, contributes to the magnetizing power of the battery. The same rule applies to the motion of repelling poles.

When two repelling electro-magnets are made to approach each other, a recession of the magnetic forces takes place, and consequently a secondary current is developed flowing in the direction of the battery current. While the forces are thus kept in retirement, if the two magnets be made to recede, they will again be determined towards the poles, and consequently the secondary will flow against the battery current. By taking advantage of these laws, I was led to the invention of a new instrument (Magnetic Electric Multiplier, described in the last number of this Journal,) in which, the secondary current may be so applied as to diminish or accelerate the velocity of the revolving bar.

It will now be readily seen, that two electro-magnets, with a statical repelling power sufficient to keep them asunder, would cease to repel when the machine is in motion. The attractive forces constitute the paramount motive power, and when the velocity of the machine exceeds that which the repulsive powers alone would give it, they are of no value whatever, unless they operate in conjunction with attractive forces ; but even where this is the case, the secondary current arising from the velocity of the machine, must occasion so great a disparity between the similar poles of the magnets which change and those which do not change, that attraction, in lieu of repulsion, must take place.

I have thus endeavored to point out the most important of those difficulties in the way of the application of this power, which necessarily arise from the connexion of galvanism and magnetism. There are many other hindrances entirely of a mechanical nature, which perseverance will doubtless overcome.

ART. VII.—*Magnetic Electrometer and Electrotome, to be used with flat spirals*; by CHARLES G. PAGE, M. D., Washington City, D. C.

THE figure represents a simple instrument, designed chiefly to aid the operator in exhibiting the magneto-electric properties of flat spirals. Though the flat spiral as a magnetic electrical instrument is inferior to the compound electro-magnet, described in the last number of this Journal, yet the phenomena are more interesting, as they are strictly magneto-electric, produced without the presence or coöperation of ferruginous bodies. The object of the instrument, as its name (electrotome) implies, is to break the circuit; and as it accomplishes this by changing the direction of the galvanic current, it is also a self-acting electrometer.

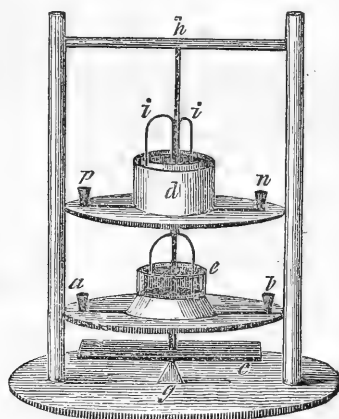

A rotating electro-magnet would effect the same object; but the introduction of an electro-magnet or a coiled wire, in any part of the circuit, would detract from the value of the spiral. (*g*) is a thin base board of mahogany, which, when the instrument is in use, is to rest upon the spiral coil or the box containing it. At the centre of the base (*g*) is a pivot sustaining the magnetic bar of steel (*c*) and its axis, the extremity of which plays freely in the centre of the cross piece (*h*.) Between the upright pillars are secured two circular pieces of mahogany (*a b*) (*p n*) to serve as supports for the mercury cells (*d* and *e*.) The circular box (*d*) contains two concentric mercury cells, insulated from each other,

and connected with the poles of a battery by the separate wires and cups (*p n.*) The centre of this box is open to admit the shaft of the magnet, as is also the centre of the box (*e.*) This box is made of two glass cylindrical sections, cemented into a groove of a turned cup or base of wood. It contains two cells for mercury nearly semicircular, and insulated from each other precisely as the cells for the Ritchie magnet. These cells are connected with the extremities of the spiral by the separate wires and cups (*a b.*) The two wires (*i i*) are well insulated by a winding of varnished silk, and secured in their positions on the shaft by silk thread. The upper extremities of these wires dip into the concentric cells of (*d,*) and the lower into the cells of box (*e.*) The base board is made thin, and the pivot (*g*) short, to allow the magnet to come as near as possible to the spiral. Place the instrument upon the spiral, make the connexions as above directed, and the magnet immediately commences a rapid rotation by the influence of the spiral. The instrument should always be placed without the centre of the spiral, and in such a manner, that the insulating pieces between the cells of (*e*) should be in the direction of a radius of the spiral.

ART. VIII.—*Observations on the Vascular System of Ferns, and Notice of a monstrous flower of Orchis spectabilis*; by J. W. BAILEY, Professor of Chemistry, Mineralogy and Geology, at the U. S. Military Academy, West Point.

### I. *On the Vascular System of Ferns.*

It is a question of much interest in vegetable anatomy, whether spiral vessels exist in ferns; for if they do, ferns present a remarkable deviation from the usual structure of flowerless plants. It is well known, that the presence or absence of these vessels has been considered so invariably connected with the presence or absence of flowers, as to have given rise to the division of the vegetable kingdom into the two great classes Vasculares or Flowering, and Cellulares or Flowerless Plants. Ferns are by all writers placed in the last class, but it will be seen by the following quotations, that there exists much uncertainty with regard to their having spiral vessels.

Link, (Elemens de Botanique, T. I, p. 132,) as quoted by Hugo Mohl in his elaborate treatise "De Structura Caudicis Filicum Arborearum,"\* states the wood to be "almost wholly made up of large spiral vessels." Decandolle, (Organographie, T. I, p. 232,) as quoted by Mohl, mentions that they contain many annular ducts (vasa scalariformia) without alluding to spiral vessels.

Lindley, (Int. to Bot., 1st edit., p. 22,) speaking of spiral vessels, says, that "in flowerless plants they are for the most part altogether absent; the only exceptions being in Ferns and Lycopodiaceæ," and adds, "in these they no doubt exist; Mr. Griffiths has succeeded in unrolling them in *Lycopodium denticulatum*."

Mohl, in the treatise above referred to, in which he describes and figures the *vasa scalariformia*, says, (p. 48,) "Num in junioribus plantis et in junioribus partibus adularum harum plantarum vera vasa spiralia occurrant exponere nequeo, quum has partes inquirendi occasio defuerit;" and again, in a note on page 51 of the same treatise, he says:

"Schultzius quidem (Flora, 1828, Tom. I, p. 154) commemorat propria vasa inesse, ceterum accuratiori eorum descriptione omissâ; equidem vero in nulla earum formationem inveni propriis vasis adnumerandum."

When distinguished observers disagree so much in their statements, it often happens that their accounts can be reconciled by the discovery of some fact not observed by either, which will explain the apparent contradictions. I hope that the knowledge of the point of structure which I am about to describe, will have this bearing upon the present question; for it shows, that those who maintain the existence of spiral vessels in ferns, may actually have obtained, what, when not carefully examined, might easily be mistaken for spiral vessels; while those who deny the existence of spiral vessels, may have observed the same organs without attempting to uncoil them, or if they attempted they may have failed, owing to the age of the plant or some other cause.

The fact to which I would invite the attention of botanists is this, viz. *The ducts of ferns* (Annular ducts of Lindley, Vasa scalariformia of Decandolle and Mohl) *can be uncoiled spirally*

---

\* Published in the splendid work, *Icones Plantarum Cryptogamicarum*, quas in itinere annis 1817—20 per Braziliam collegit et descripsit Carol. Frideric. Philip. de Martius. Monachii, 1828—34.



with great ease when the plant is young, but with more difficulty in the adult plant. The uncoiled duct, when examined by a low magnifying power, has all the appearance of a common spiral vessel; but when highly magnified, it shows the real structure to be as represented in Fig. 4, Plate I. It will be seen, that this differs very much from the structure of a true spiral vessel, which shows merely one or more continuous, slender, round fibres, entirely destitute of any marks; while the uncoiled ducts of ferns show, as in the figure, a flat ribbon marked with parallel rows of short bars.

To obtain these ducts separate from each other, so as to allow the state in which they exist in the plants to be seen, I macerated in water for several weeks the bundles of vessels from the petioles of young and tender, though large fronds of *Onoclea sensibilis*, *Osmunda cinnamomea*, &c. until by the decay of the connecting parts, the vessels could be easily separated from each other by placing a portion on glass, in a drop of water, and forcing them apart with the points of fine needles. The vessels, as prepared in this manner, present the appearance of long cylindrical (Fig. 2, Plate I,) or prismatic (Fig. 3, Plate I,) tubes, terminating at each end in very elongated cones. These tubes vary much in length and diameter, some being several inches long and as much as one twenty-fifth to one twentieth of a line in diameter, while others are very minute and short. The sides of these tubes are marked with a great number of short parallel bars, placed in rows one above another, and the length of the bars in the same vertical row is often seen gradually to diminish, (Fig. 2,) so that the bars are finally reduced to mere points.

These bars are so placed as to incline slightly, often almost imperceptibly, upwards from left to right in all the ferns I have examined. The end of one bar is placed close to the end of one in the next row, so that the bars form broken spiral lines around the cylinder, and as the membrane of the vessel appears to be thinnest between the bars, it follows, that when a force is applied to tear this membrane, the laceration takes place in a spiral direction, and the vessel when thus torn, appears as in Fig. 4, Plate I. Vessels torn and uncoiled in this manner have, I presume, been mistaken by Link and others for true spiral vessels. This laceration and uncoiling can be effected with so much ease in tender shoots of *Onoclea sensibilis*, *Adiantum pedatum*, *Polypodium*

*connectile*, and particularly in *Osmunda cinnamomea*, that if the petiole of the frond be snapped across and gently separated, hundreds of uncoiled ducts will be seen to connect the two fragments, as in Fig. 5, Plate I. These may often be drawn out to the length of two or three inches without breaking. When broken, they exhibit the curious peristaltic motion which has been noticed by Malpighi and others in true spiral vessels. This is evidently a mechanical effect, caused by the elongated and untwisted coil resuming its twisted state.

I have found the vessels above described, and have uncoiled them, in every species of fern which I have examined, among which are *Aspidium marginale*, *A. acrostichoides*, *Asplenium ebeneum*, *Onoclea sensibilis*, *Adiantum pedatum*, *Pteris aquilina*, *Osmunda cinnamomea*, *O. regalis*, *Polypodium connectile*, *P. vulgare*, *Botrychium virginicum*, and others. From the drawings given by Mohl, (Table xxxi, Fig. 1 to 3, *m m*, Table xxxv, Fig. 1,) it is evident, that the structure of the vessels in the arborescent ferns is similar, although it does not appear that any attempts have been made to uncoil them.

In all the ferns which I have examined, I have sought in vain for any thing approaching more nearly to true spiral vessels than the lacerated ducts above described.

As these ducts have precisely the structure which would result from a compound spiral vessel, in which the spiral threads should be broken into short bars, I have carefully examined many young ferns, to determine if in the young state the bars may not be continuous, and thus form a true spiral vessel. But I have found little to support this view, except the appearance of very small ducts when so torn as to include only a single spiral line of bars, in which case it is often impossible to see whether the bars are connected or not.

I hence infer, that spiral vessels do not exist in ferns, and that the ducts when torn spirally have been mistaken for them.

In connection with the above observations, I examined the young stem of *Equisetum sylvaticum*, in which I distinctly and repeatedly found small vessels which could be uncoiled spirally, and which presented no appearance of the bars seen in ferns, but which certainly appeared to be true spiral vessels. I did not detect them, however, in *E. hyemale*, or in *E. palustre*.

I have not yet examined the Lycopodiaceæ in a young state.

II. Notice of a Monstrous Flower of *Orchis spectabilis*.

Although no doubt is at present felt with regard to the normal structure of the Orchideæ, yet the instances in which this structure is reverted to in monstrous flowers, are interesting and worthy, I think, of being recorded. An instance of this kind in *Orchis latifolia*, is described by M. Achille Richard, in the "Memoires de la Soc. d'Hist. Nat.," of Paris, in which the flowers were perfectly triandrous, with no trace of irregularity in any part of the floral envelopes.

I myself found a fine example in the case of a monstrous flower of our beautiful *Orchis spectabilis*. The plant on which it occurred was a very luxuriant one from the Crow's Nest, West Point, supporting six or seven flowers, of which all but one had the ordinary structure. That one, however, had three stamens perfectly formed, and each presenting *precisely* the same appearance as the one usually developed. All the other parts of the flower were perfectly regular, and the ovarium had the three ordinary placentæ. For a sketch of this flower see Fig. 6, Plate I.

EXPLANATION OF PLATE I.

Fig. 1. Conical terminations of ducts in ferns. The ducts terminate at *each* end in such cones.

Fig. 2. Cylindrical portion of a duct, showing the bars gradually diminishing to points.

Fig. 3. Prismatic portion of a duct. This form is probably caused by the pressure of surrounding parts.

Fig. 4. A duct of ferns torn in a spiral direction between the bars and uncoiled. In this state, ducts have probably been mistaken for spiral vessels.

Fig. 5. Two portions of the bundle of fibres in ferns, broken apart and gently separated, showing several torn ducts spirally twisted, still connecting the parts.

Fig. 6. A monstrous flower of *Orchis spectabilis*, showing a return to the normal structure of Orchideæ, having three perfect anthers, and the rest of the flower in the ordinary state. *a, a, a*, three anthers not differing in any respect from the one usually developed, and having a very dilated stigma in front of them. *b, b, b*, Sepals. *c, c, d*, Petals and lip. *e*, Spur. *f*, Ovarium.

ART. IX.—On Fossil Infusoria, discovered in Peat-earth, at West Point, N. Y., with some notices of American species of *Diatomæ*; by J. W. BAILEY, Prof. Chem., Mineral. and Geol. at the U. S. Mil. Acad., West Point.

THROUGH the kindness of my distinguished friend Dr. Torrey, I received some months since a portion of the fossil Infusoria, of the tribe Bacillariæ, recently discovered by Ehrenberg, constituting whole strata in Germany, &c. The specimen I received, came originally from Ehrenberg himself, and was brought to this country by Prof. Daubeny of Oxford.

Having by means of this specimen become acquainted with the form of these singular creatures, I was led to search for the living species of this family in various situations in this vicinity. I soon found that they were exceedingly abundant, occurring not only in small streams and stagnant pools, but also nestling in the wet moss on moist rocks.

The situation, however, in which I found them to be most abundant was in the bunches of *Conferva*, *Zygnema*, and *Batrachospermum* which constitute the green slimy matter known vulgarly by the name of *Frog-spittle*, so abundant in bogs and slow running brooks. They were accompanied by great numbers of the *Diatomæ*, particularly *Diatoma flocculosum* and *Fragillaria pectinalis*. By burning off the vegetable matter from a bunch of the *Confervæ* and examining the ashes with a good microscope, I found them chiefly composed of the siliceous shells of various loricated Infusoria, and what was to me before unknown, I found that the *Diatomæ* were also unchanged by fire or acids, and consequently like the Bacillariæ composed of silica.\*

The imperishable nature of the Bacillariæ and *Diatomæ*, led me to suppose that large numbers must be buried in the mud at the bottoms of the bogs, streams, &c., where the living specimens occur, but I was not prepared for the discovery which I shortly made of a deposit eight or ten inches thick and probably several

---

\* Since making this observation I find that the same discovery had been previously made by De Brébisson; see extract from Meffén's Report given at the end of this article.

*hundred square yards in extent, which is wholly made up of the siliceous shells of the Bacillariæ, &c. in a fossil state.*

This deposit is about a foot below the surface of a small peat-bog, immediately at the foot of the southern escarpment of the hill on which the celebrated Fort Putnam stands. In draining this bog, a large ditch was dug, and among the matter thrown out, my attention was attracted by a very light, white or clay colored substance, which when examined closely in the sun-shine, showed minute glimmering linear particles. On submitting it to observation, by means of a good microscope, I found it to be almost entirely composed of fossil Infusoria, with occasionally a few fragments of a Diatoma or Fragillaria.

I have since examined many specimens, taken from different and distant parts of the same bog, and have invariably found the same siliceous bodies, and in the same abundance.

There can be no doubt that in this place there are several tons of the shells of beings so minute as to be barely visible as brilliant specks, when carefully observed in a strong light by the naked eye. Hundreds of years must have elapsed before such an accumulation could have been made.

The forms most abundant in this peat-earth are represented on Plate 2. Fig. 1, represents one of the Bacillariæ, which is apparently identical with fossil specimens from Ehrenberg. Fig. 2, represents a boat-shaped shell, which like the preceding is marked with parallel lines of almost inconceivable fineness. Fig. 3, shows a smooth siliceous body whose nature is to me unknown. Fig. 4, is a rough siliceous body of whose nature I am also ignorant. With these occur great quantities of exceedingly small rings, discs, and spheres, see Fig. 11, Plate 2.

All these forms together compose a white or clay colored mass, which when dry feels very light, does not effervesce or dissolve in acids, and is not fused by the blow-pipe. I have no doubt that this substance will be found abundantly in many peat-bogs, and I hope in the next number of this Journal to see the announcement of its discovery in many localities.\* From its white color,

---

\* Since writing the above, I received from my scientific friend, O. Mason, Esq., President of the Providence Franklin Society, a letter from which I take the liberty to extract the following. He says, "your microscopic examinations of the white substance occasionally found at the bottom of peat-bogs have afforded a satisfactory and very curious solution of a phenomenon which has often occupied my mind. I could

it may in some cases have been confounded with marl, from which its action with acids would distinguish it. To examine for the Infusoria, diffuse a small portion in a drop of water, and examine with a microscope of high power. The very convenient Raspail Microscope is well suited for the purpose, but to see the fine lines on these shells most distinctly, a small glass sphere made according to the method of Torre of Naples, should be used with the Raspail fixtures.\*

As I have not had the good fortune to obtain Ehrenberg's papers on Recent and Fossil Infusoria, I am unable to give the names of the species occurring at West Point. I have, however, made sketches of the principal forms occurring in the peat-earth, which I hope will serve to make these singular beings more generally known and perhaps also enable those who have Ehrenberg's papers, to identify our species. All the Infusoria figured on Plate 2, occur abundantly in company with the Closteria, and several other forms, in a living state, in the waters near the deposit of fossils. Fig. 5, represents the species which appears *most* abundant as a *recent* species, and *least* abundant as a *fossil*.

As the species of Algæ known as the Diatomæ, have also a siliceous shell and occur abundantly in our ditches, &c. in a recent state, and occasionally in the peat-earth in a fossil state, and as this obscure but beautiful tribe appears to have been wholly neg-

---

not even conjecture the origin of this sedimentary accumulation, which generally occurs under circumstances which afford no clew to its source. \* \* \* I have forgotten all the localities whence the specimens were obtained, which were put into my hand by various individuals some years since, some of whom supposed it to be magnesia and others porcelain earth."

\* I make these spheres by drawing into a thread a portion of green glass (flint glass will not answer, as the lead reduces,) and then snapping off a portion, about half a line or a line in length, I lay it upon a fragment of charcoal and very carefully direct upon it, the flame of a blow-pipe, observing to cease to blow the moment that the bit of glass has assumed the spherical form, (otherwise ashes adhere, and the glass becomes full of flaws.) The spheres are then easily set in lead, thus: Make a conical depression in a piece of sheet lead and perforate the apex of the cone with a hole somewhat less in diameter than the glass to be set. The glass is then to be forced into the hole so as to project through slightly. I have frequently made, and set in five minutes, spheres in this manner, which would magnify from one hundred, to four or five hundred times the diameter of the object. Such glasses are much superior to any usually kept for sale in this country. I presume that these glasses would have been more used, had they been tried with the proper arrangements for light. With the beautiful fixtures of the Raspail Microscope they leave little to be wished for, either with regard to power or the distinctness of vision.

lected by American botanists, (but one species, *D. flocculosum*, being credited to our Flora,) I have made sketches of several species, which occur abundantly about West Point.

I have found abundantly in this vicinity, *Diatoma flocculosum*, Fig. 12, Plate 2, another species, *D. tenue*, having the articulations six to eight times as long as the diameter, Fig. 13, Plate 2, *Diatoma crystallinum?* Fig. 14, Plate 2, *Fragillaria pectinalis*, Fig. 15, Plate 2, and *Meridion vernale?* of Agardh, Fig. 16, Plate 2. My specimens of the latter, found in Washington's valley, agree precisely with specimens sent to Dr. Torrey, by Dr. Binders, and marked *M. vernale*, Agardh, but Agardh's description, does not suit them well. Perhaps this may be the *M. circulare* of Agardh.

I have also found, adhering to specimens of Algæ, collected near Providence, by my friend D. C. Cushing, a great quantity of *Meloseira nummuloides*, Agardh. This is another species of the tribe Diatomæ. It appears then, that this tribe is quite abundant in this country, and a monograph of the species occurring in the United States, is much to be desired.

In connection with the above, the following extracts from Meyen's Report of the Progress of Vegetable Physiology,\* during the year 1836, will prove interesting. I met with it several weeks after I made the observations above noticed.

"Mohl confesses, that after many years' observation he still remains quite in doubt as to the place which the *Bacillariæ* should occupy; that however their increasing by separation, does not justify us in classing them as animals.

"I may also mention that Link, Unger and Morren, have of late remarked, that these doubtful creatures which are known under the name of *Bacillariæ*, ought to be arranged with vegetables; according to this, there would remain no other botanist, with the exception of Corda, that had paid any considerable attention to vegetable anatomy, who did not consider the *Bacillariæ* to be plants.

"From this we may judge of the contradictions on this subject which are found in the reports edited by Wiegmann and myself, on the progress of zoology and physiological botany for the year 1835,†—as these crea-

\* Wiegmann's *Archiv für Naturgeschichte*, 1837, Part iii. Translated in Lond. and Ed. Phil. Mag., Oct. 1837, page 381.

† Wiegmann's *Archiv*.

tures are at times mentioned as plants, at times as animals, and indeed under quite different denominations.\*

"Morren, in the highly important memoir on the *Closteriæ*,† has very fully treated the question, whether they should be arranged with animals or vegetables; he succeeded by employing very high magnifying powers, in showing that those red and very movable little points discovered by Ehrenberg at the ends of these beings, were nothing else than minute vesicles which afterwards change into new individuals. It was these movable, and as it were, oscillating points, which were considered as organs of motion, and appeared to justify the placing of the *Closteriæ* among animals, which, however, at present, after Morren's discovery, falls to the ground. Besides the occurrence of these self-moving propagula in the interior of the *Closteriæ*, Morren has observed a formation of fruit by conjugation, quite similar to the mode of formation of the fruit in the *Conjugatæ*,‡ and besides this there also takes place an increase of the *Closteriæ* by separation.

"The siliceous envelop which surrounds the *Closteriæ*, as well as all other *Bacillariæ*, is regarded by Morren as a formation analogous to the so called *cuticula* of plants, a fact which is capable of confirmation only in certain relations; for in the perfect plants this fine plate of silica lies in the substance of the *cuticula*, and is only separated from this by the destruction of the organic parts. Besides this siliceous envelop, Morren supposes the existence of two other distinct membranes, which form the cuticles of the *Closteriæ*, and inclose the green substance; he however remarks, that they only become evident upon the metamorphosis of the plant. I consider the inner pellicle to be the analogue of the inner envelop which is found in the members of *Confervæ* when their spores are ripened, or they begin to increase in any other manner, as for instance, by excrescence and separation. Morren thinks it possible to explain the motion of the *Closteriæ* by the action of opposite electricities. The author also gives a very complete description, accompanied by drawings, of the very manifold forms which the *Closteriæ* exhibit at different periods; and by this he shows, how—at least six of the new species of the genus *Closterium*, described by Ehrenberg, belong to one and the same species.

"De Brébisson§ also made observations on the enigmatical *Diatomæ*, in order to decide the question, whether they should be classed with ani-

\* I am sorry to say, that these contradictions must also occur in this year's report, as I do not think Ehrenberg's view as to the animal nature of the *Bacillariæ* weakened by the reasons here stated.—*Wiegmann*.

† *Sur les Clostériés*, *Ann. des Scienc. Nat.*, Vol. I, p. 274.

‡ The same observation had been made by Corda.—Also by Ehrenberg in 1834.—*Wiegmann*.

§ Observations sur les Diatomées. L'Institut de 1836, p. 378. *Ann. des Scienc. Nat.*, 1836, II, p. 248.



mals or vegetables. On burning a great number of *Fragillaria pectinialis*, an animal smell was noticed. Such a smell would, however, be a very indefinite character, for various other Algæ produce a similar odor on their being burnt to a coal. After the burning of the *Fragillaria pectinialis*, and various other beings of the same kind, Brébisson found siliceous envelops surrounding them in a very perfect state, and precisely similar to those exhibited by the fossil *Diatomæ*, discovered by C. Fischer in the peat-bog near Franzensbad, and which led to those beautiful observations that Ehrenberg made known on this subject in the course of last year.\*

“The results of those latter observations belong properly to geognosy; but we must add this one remark, that under the fossil Infusoria hitherto discovered, only those beings are to be understood, which botanists, as has been previously shown, receive as plants. The occurrence in a fossil slate of these minute microscopical plants, is caused by the hard siliceous envelop, which resists all destroying influences. Kützing’s discovery, that the envelop of the *Bacillariæ* consists of silica, which was mentioned in our first year’s report, has, by this circumstance, been rendered more important. If we observe the same minute plants in the living state, it often happens, that amongst them some dead ones occur, which exhibit that perfectly transparent and colorless siliceous envelop; it is therefore proved, that a great mass of such siliceous envelops might also be produced by the decomposition of the plants, or in the moist way, and also that the mountain masses, which consist more or less of such siliceous envelops, might not always be regarded as being produced by the action of heat at the bottom of the sea.† Brébisson tries to bring the *Diatomæ* into two divisions, viz. the proper *Diatomæ*, which exhibit a siliceous envelop, and the *Desmidiæ*, which are without a siliceous coating, and entirely reducible to carbon. In the more perfect plants, the epidermis of which is penetrated by a siliceous envelop, it would at least be improper to make such divisions; in this case, however, they may be of some use.

“In a recent memoir, Mohl has again declared himself against the animal nature of the *Bacillariæ*. ‘I admit,’ says he, ‘that the doubt which was raised respecting their vegetable nature is not yet removed; their animal nature, however, has been as little proved, and we find evident transitions from them to vegetables.’”—Lond. and Ed. Phil. Mag., Oct. 1837, p. 385—390.

\* Vide on Fossil Infusoria, Wiegmann’s Archiv, 1836, p. 333. A translation of Ehrenberg’s two papers on this subject is given entire and with engravings in the Scientific Memoirs, Vol. I, p. 400.—W. F. I have not had an opportunity to see either of these works.—J. W. B.

† Ehrenberg’s opinion is, that these masses owe their origin to the action of volcanic heat on the bottom of the sea. Vide Scientific Memoirs, Vol. I, p. 400.

With regard to the question concerning the animal or vegetable nature of the *Bacillariæ*, I can add nothing new to the testimony of those who support their animal nature. I have often witnessed the motions of several species of *Bacillariæ*, and would no more think of referring them to the action of electricity, than I would the more active, but apparently not more voluntary movements of *Vibrio*, or *Rotatoria*. I have seen them advance, and recede, vibrate to the right and left, push against obstacles, and in case they could not pass them, retreat and go round them. It must be a very curious electric arrangement, that can produce such actions as these.

NOTE.—I have taken considerable pains to distribute specimens of the Fossil Infusoria, &c., above referred to, but those who have not received specimens, and are interested in these matters, may obtain them from Prof. Silliman, to whom I have sent a large supply, from Dr. J. R. Chilton, New York, from O. Mason, Esq., Providence, R. I., and from myself at West Point, N. Y.

#### EXPLANATION OF PLATE II.

Fig. 1. One of the fossil Infusoria found at West Point, which appears identical with specimens from Ehrenberg.

Fig. 2. Another species, which is also very abundant in the peat-earth.—N. B. The fine parallel transverse lines are marks upon the shell, which are easily seen with a high magnifying power. The figures represent these objects as magnified about three hundred and fifty times in length.

Fig. 3. A smooth round siliceous body, apparently solid and without any marks. Very abundant in the peat-earth.

Fig. 4. A round solid siliceous body, having numerous asperities. Less abundant than the preceding.

Fig. 5. Siliceous shell of a common species of Infusoria.

Figs. 7, 8, and 9. Siliceous shells of small Infusoria. The motions of the living species of Figs. 7 and 8, are more active than those of any of this tribe that I have witnessed. The motions of the species represented by Fig. 5, are also very evident.

Fig. 10. A portion of peat-earth diffused in a drop of water, and moderately magnified (about fifty times.) This shows imperfectly, the immense number, and variety of forms, which exist in the peat-earth.

Fig. 12. *Diatoma flocculosum*. Very common in brooks, &c., among *Conservæ*.

Fig. 12 a. an articulation of the same more highly magnified.

Fig. 13. *Diatoma tenue*? Found with the preceding species.

Fig. 13 a. An articulation of the same more highly magnified.

Fig. 14. *Diatoma crystallinum*? Straight, smooth, siliceous tubes, occurring in great quantities in small streams, near West Point, closely resembling foreign specimens of *D. crystallinum*.

Fig. 15. *Fragillaria pectinalis*. *a, b*, specimens differing in the width of the articulations. *c*, articulations highly magnified.

Fig. 16. *Meridion vernale*? from Washington's valley, near West Point. *a*, articulations highly magnified.

ART. X.—*Description of some Experiments made with the Voltaic Battery; by ANDREW CROSSE, Esq. of Broomfield, near Taunton, for the purpose of producing Crystals; in the process of which Experiments certain Insects constantly appeared. Communicated in a letter dated Dec. 27, 1837, addressed to the Secretary of the London Electrical Society. Read Jan. 20, 1838.*

From the Transactions of the Electrical Society of London.

*My dear Sir*—I trust that the gentlemen who compose the “Electrical Society” will not imagine that because I have so long delayed answering their request, to furnish the Society through you, as its organ, with a full account of my electrical experiments, in which a certain insect made its unexpected appearance, that such delay has been occasioned by any desire of withholding what I have to state, from the Society in particular, or the public at large. I am delighted to find that at last, late, though not the less called for, a body of scientific gentlemen have linked themselves together for the sake of exploring and making public those mysteries, which hitherto, under a variety of names, and ascribed to all causes but the true one, have eluded the grasp of men of research, and served to perplex, perhaps, rather than to afford sufficient data to theorize upon. It is true that much has been done in the course of a few years, and that which has been done only affords the strongest reason for believing that vastly more remains to be done. It would be presumptuous in me to enumerate the services of a Davy, a Faraday, and many other great men at home, or a Volta and an Ampère, with a host of others abroad. These distinguished men have laid the foundations, on which their successors ought to endeavor to erect a building worthy of the scale in which it has been commenced. Electricity is no longer the paltry confined science which it was once fancied to be, making its appearance only from the friction of glass or wax, employed in childish purposes, serving as a trick for the school-boy, or a nostrum for the quack. But it is, even now, though in its infancy, proved to be most intimately connected with all operations in chemistry, with magnetism, with light and caloric; apparently a property belonging to all matter, perhaps ranging through all space, from sun to sun, from planet to planet, and not improbably the secondary cause of every change in the animal, mineral, vegetable,

and gaseous systems. It is to determine whether this be or not the case, as far as human faculties can determine, to ascertain what rank in the tree of science electricity is to hold; to endeavor to find out to what useful purposes it might be applied, that I conceive is the object of your Society, and I shall at all times be ready and willing, as a member, to contribute my quota of information to its support, knowing well, that however little it might be, it will be as kindly received as it is humbly offered. It is most displeasing to my feelings to glance at myself as an individual, but I have met with so much virulence and abuse, so much calumny and misrepresentation, in consequence of the experiments which I am about to detail, and which it seems in this *nineteenth century* a crime to have made, that I must state, not for the sake of myself (for I utterly scorn all such misrepresentations,) but for the sake of truth and the science which I follow, that I am neither an "Atheist," nor a "Materialist," nor a "self imagined creator," but a humble and lowly reverencer of that Great Being, whose laws my accusers seem wholly to have lost sight of. More than this, it is my conviction, that science is only valuable as a mean to a greater end. I can assure you, sir, that I attach no particular value to any experiment that I have made, and that my feelings and habits are much more of a retiring than an obtruding character; and I care not if what I have done be entirely overthrown, if truth be elicited. The following is a plain and correct account of the experiments alluded to.

In the course of my endeavors to form artificial minerals by a long continued electric action on fluids holding in solution such substances as were necessary to my purpose, I had recourse to every variety of contrivance which I could think of, so that, on the one hand, I might be enabled to keep up a never-failing electrical current of greater or less intensity or quantity, or both, as the case seemed to require; and on the other hand, that the solutions made use of should be exposed to the electric action in the manner best calculated to effect the object in view. Amongst other contrivances, I constructed a wooden frame, of about two feet in height, consisting of four legs proceeding from a shelf at the bottom, supporting another at the top, and containing a third in the middle. Each of these shelves was about seven inches square. The upper one was pierced with an aperture, in which was fixed a funnel of Wedgwood ware, within which rested a

quart basin on a circular piece of mahogany placed within the funnel. When this basin was filled with a fluid, a strip of flannel wetted with the same, was suspended over the edge of the basin and inside the funnel which, acting as a syphon, conveyed the fluid out of the basin, through the funnel, in successive drops. The middle shelf of the frame was likewise pierced with an aperture, in which was fixed a smaller funnel of glass, which supported a piece of somewhat porous red oxide of iron from Vesuvius, immediately under the dropping of the upper funnel. The stone was kept constantly electrified by means of two platina wires on either side of it, connected with the poles of a Voltaic battery of nineteen pairs of five-inch zinc and copper single plates, in two porcelain troughs, the cells of which were filled at first with water and  $\frac{1}{500}$  of hydrochloric acid, but afterwards with water alone. I may here state, that in all my subsequent experiments relative to these insects, I filled the cells of the batteries employed with nothing but common water. The lower shelf merely supported a wide-mouthed bottle, to receive the drops as they fell from the second funnel. When the basin was nearly emptied, the fluid was poured back again from the bottle below into the basin above, without disturbing the position of the stone. It was by mere chance that I selected this volcanic substance, choosing it from its partial porosity; nor do I believe that it had the slightest effect in the production of the insects to be described. The fluid with which I filled the basin was made as follows.

I reduced a piece of black flint to powder, having first exposed it to a red heat and quenched it in water to make it friable. Of this powder I took two ounces, and mixed them intensely with six ounces of carbonate of potassa, exposed them to a strong heat for fifteen minutes in a black lead crucible in an air furnace, and then poured the fused compound on an iron plate, reduced it to powder while still warm, poured boiling water on it, and kept it boiling for some minutes in a sand bath. The greater part of the soluble glass thus fused, was taken up by the water, together with a portion of alumina from the crucible. I should have used one of silver, but had none sufficiently large. To a portion of the silicate of potassa thus fused, I added some boiling water to dilute it, and then slowly added hydrochloric acid to supersaturation. A strange remark was made on this part of the experiment, at the meeting of the British Association at Liverpool, it

being then gravely stated, that it was impossible to add an acid to a silicate of potassa without precipitating the silica! This, of course, must be the case, unless the solution be diluted with water. My object in subjecting this fluid to a long-continued electric action, through the intervention of a porous stone, was to form, if possible, crystals of silica at one of the poles of the battery, but I failed in accomplishing this by those means. On the fourteenth\* day from the commencement of the experiment, I observed, through a lens, a few small whitish excrescences or nipples projecting from about the middle of the electrified stone, and nearly under the dropping of the fluid above. On the eighteenth\* day, these projections enlarged, and seven or eight filaments, each of them longer than the excrescence from which it grew, made their appearance on each of the nipples. On the twenty second\* day, these appearances were more elevated and distinct, and on the twenty sixth\* day, each figure assumed the form of a perfect insect, standing erect on a few bristles which formed its tail. Till this period I had no notion that these appearances were any other than an incipient mineral formation; but it was not until the twenty eighth day, when I plainly perceived these little creatures move their legs, that I felt any surprise, and I must own that when this took place, I was not a little astonished. I endeavored to detach, with the point of a needle, one or two of them from its position on the stone, but they immediately died, and I was obliged to wait patiently for a few days longer, when they separated themselves from the stone, and moved about at pleasure, although they had been for some time after their birth apparently averse to motion. In the course of a few weeks, about a hundred of them made their appearance on the stone. I observed that at first each of them fixed itself for a considerable time in one spot, appearing, as far as I could judge, to feed by suction; but when a ray of light from the sun was directed upon it, it seemed disturbed, and removed itself to the shaded part of the stone. Out of about a hundred insects, not above five or six were born on the south side of the stone. I examined some of them with the microscope, and observed that the smaller ones appeared to have only six legs, but the larger ones eight. It would be superfluous to attempt a description of

---

\* Denoted by the figs. 14, 18, 22, and 26.

these little mites, when so excellent a one has been transmitted from Paris. It seems that they are of the genus *Acarus*, but of a species not hitherto observed. I have had three separate formations of similar insects at different times, from fresh portions of the same fluid, with the same apparatus. As I considered the result of this experiment rather extraordinary, I made some of my friends acquainted with it, amongst whom were some highly scientific gentlemen, and they plainly perceived the insect in various states. I likewise transmitted some of them to one of our most distinguished physiologists in London, and the opinion of this gentleman, as well as of other eminent persons to whom he showed them, coincided with that of the gentlemen of the Academie des Sciences, as to their genus and species. *I have never ventured an opinion as to the cause of their birth*, and for a very good reason—I was unable to form one. The most simple solution of the problem which occurred to me, was, that they arose from ova deposited by insects floating in the atmosphere, and that they might possibly be hatched by the electric action. Still, I could not imagine that an ovum could shoot out filaments, and that those filaments would become bristles; and moreover, I could not detect, on the closest examination, any remains of a shell. Again, we have no right to assume that electric action is necessary to vitality, until such fact shall have been most distinctly proved. I next imagined, as others have done, that they might have originated from the water, and consequently made a close examination of several hundred vessels, filled with the same water as that which held in solution the silicate of potassa, in the same room, which vessels constituted the cells of a large Voltaic battery, used without acid. In none of these vessels could I perceive the trace of an insect of that description. I likewise closely examined the crevices and most dusty parts of the room with no better success. In the course of some months, indeed, these insects so increased, that when they were strong enough to leave their moistened birth-place, they issued out in different directions, I suppose, in quest of food; but they generally huddled together under a card or piece of paper in their neighborhood, as if to avoid light and disturbance. In the course of my experiments upon other matters, I filled a glass basin with a concentrated solution of silicate of potassa without acid, in the middle of which I placed a piece of brick, used in this neighborhood for

domestic purposes, and consisting mostly of silica. Two wires of platina connected either end of the brick with the poles of a Voltaic battery of sixty three pairs of plates, each about two inches square. After many months' action, silica in a gelatinous state formed in some quantity round the bottom of the brick, and as the solution evaporated, I replaced it by fresh additions, so that the outside of the glass basin, being constantly wet by repeated overflowings, was, of course, constantly electrified. On this outside, as well as on the edge of the fluid within, I one day perceived the well known whitish excrescence, with its projecting filaments. In the course of time, they increased in number, and as they successively burst into life, the whole table on which the apparatus stood, at last was covered with similar insects, which hid themselves wherever they could find a shelter. Some of them were of different sizes, there being a considerable difference in this respect between the larger and the smaller; and they were plainly perceptible to the naked eye, as they nimbly crawled from one spot to another. I closely examined the table with a lens, but could perceive no such excrescence as that which marks their incipient state, on any part of it. While these effects were taking place in my electrical room, similar formations were making their appearance in another room, distant from the former. I had here placed on a table three Voltaic batteries, unconnected with each other. The first consisted of twenty pairs of two inch plates, between the poles of which I placed a glass cylinder, filled with a concentrated solution of silicate of potassa, in which was suspended a piece of clay slate by two platina wires connected with either pole of the battery. A piece of paper was placed on the top of the cylinder, to keep out the dust. After many months' action, gelatinous silica in various forms was electrically attracted to the slate, which it coated in rather a singular manner, unnecessary here to describe. In the course of time, I observed similar insects, in their incipient state, forming around the edge of the fluid within the jar, which, when perfect, crawled about the inner surface of the paper with great activity. The second battery consisted of twenty pairs of cylinders, each equal to a four inch plate. Between the poles of this, I interposed a series of seven glass cylinders, filled with the following concentrated solutions:—1. Nitrate of copper: 2. Sub-carbonate of potassa: 3. Sulphate of copper: 4. Green sulphate of iron: 5.



Sulphate of zinc: 6. Water acidified with a minute portion of hydrochloric acid: 7. Water poured on powdered metallic arsenic, resting on a copper cup, connected with the positive pole of the battery. All these cylinders were electrically united together by arcs of sheet copper, so that the same electric current passed through the whole of them.

After many months' action, and consequent formation of certain crystalline matters, which it is not my object here to notice, I observed similar excrescences with those before described at the edge of the fluid in every one of the cylinders, excepting the two which contained the carbonate of potassa, and the metallic arsenic; and in due time a host of insects made their appearance. It was curious to observe the crystallized nitrate and sulphate of copper, which formed by slow evaporation at the edge of the respective solutions, dotted here and there with these hairy excrescences. At the foot of each of the cylinders, I had placed a paper ticket upon the table, and on lifting them up, I found a little colony of insects under each, but no appearance whatever of their having been born under their respective papers, or on any part of the table. The third battery consisted of twenty pairs of cylinders, each equal to a three inch plate. Between the poles of this I interposed likewise a series of six glass cylinders, filled with various solutions, in only one of which I obtained the insect. This contained a concentrated solution of silicate of potassa. A bent iron wire, one fifth of an inch in diameter, in the form of an inverted syphon, was plunged some inches into this solution, and connected it with the positive pole, whilst a small coil of fine silver wire joined it with the negative.

After some months' electrical action, gelatinous silica enveloped both wires, but in much greater quantity at the positive pole; and in about eight months from the commencement of the experiment, on examining these two wires very minutely, by means of a lens, having removed them from the solution for that purpose, I plainly perceived one of these incipient insects upon the gelatinous silica on the silver wire, and about half an inch below the surface of the fluid, when replaced in its original position. In the course of time, more insects made their appearance, till, at last, I counted at once three on the negative and twelve on the positive wire. Some of them were formed on the naked part of the wires, that is, on that part which was partially bare of gelatinous silica: but they were

mostly imbedded more or less in the silica, with eight or ten filaments projecting from each beyond the silica. It was perfectly impossible to mistake them, after having made one's self master of their different appearances; and an occasional motion in the filaments of those that had been the longest formed was very perceptible, and observed by many of my visitors, without my having previously noticed the fact to them. Most of these productions took place from half to three quarters of an inch under the surface of the fluid; which, as it evaporated very slowly, I kept to the same level by adding fresh portions. As some of these insects were formed on the inverted part of the syphon-shaped wire, I cannot imagine how they contrived to arrive at the surface, and to extricate themselves from the fluid: yet this they did repeatedly; their old places were vacated, and others were born in new ones. Whether they were in an imperfect state (except just at the commencement of their formation), or in a perfect one, they had all the distinguishing characteristic of bristles projecting from their bodies, which occasioned the French *savans* to remark that they resembled a microscopic porcupine. I must not omit to state, that the room in which these three batteries were acting was kept almost constantly darkened. It was not my intention to make known these observations until I myself should be better informed about the matter. Chance led to the publication of an erroneous account of them, which I was under the necessity of explaining. It is so difficult to arrive at the truth, that mankind would do better to lend their assistance to explore what may be worth investigating, than to endeavor to crush in its bud that which might otherwise expand into a flower. In giving this account, I have merely stated those circumstances regarding the appearance of insects, which I have noticed during my investigations into the formation of mineral matters; I have never studied physiology, and am not aware under what circumstances the birth of this class of insects is usually developed. In my first experiment I had made use of flannel, wood, and a volcanic stone; in the last, none of these substances were present. I never, for a moment, entertained the idea that the electric fluid had animated the organic remains of insects, or fossil eggs, previously existing in the stone or the silica; and have formed no visionary theory which I would travel out of my way to support. I have since repeated these latter experiments in a third room, in which there are now two

batteries at work. One consisting of eleven pairs of cylinders, made of four inch plates, between the poles of which is placed a glass cylinder, filled with silicate of potassa, in which is suspended a piece of slate between two wires of platina, as before, and covered loosely with paper. Here, again, is another crop of insects formed. The other battery consists of twenty pairs of cylinders, the electric current of which is passed through six different solutions in glass cylinders, in three of which only is the insect formed, viz. 1st, in nitrate of copper; 2d, in sulphate of copper, in each of which the insect is only produced at the edge of the fluid, as far as I can make out; and 3d, by the old apparatus of coiled silver and iron wire in silicate of potassa, as before. There are now forming on the bottom of this positively electrified wire similar insects; at the distance of fully two inches below the surface of the fluid. On examining these, I have lately noticed a peculiar quality they possess whilst in an incipient state. After being kept some minutes out of the solution, they contract their filaments, so as, in some cases, wholly, and in others partially, to disappear. I at first thought they were destroyed; but, on examining the same spots, on the next day, they were as perceptible as before. In this respect, they seem not unlike the zoophytes, which adhere to the rocks on the sea-shore, and which contract on the approach of a finger. I may likewise remark, that I have not been able to detect their eyes, even when viewed under a powerful microscope, although I once fancied I perceived them. The extreme heat of summer and cold of winter do not appear favorable to their production, which succeeds best, I think, in spring and autumn. As in the above account I have occasionally made use of the word "formation," I beg that it might be understood that I do not mean *creation*, or any thing approaching to it. I am not aware that I have any thing more to add, except the few remarks I shall conclude with.

1st. I have not observed a formation of the insect, except on a moist and electrified surface, or under an electrified fluid. By this *I do not mean to assert that electricity has any thing to do with their birth*, as I have not made a sufficient number of experiments to prove or disprove it; and besides, I have not taken those necessary precautions which present themselves even to an unscientific view. These precautions are not so easy to observe as may at first sight appear. It is, however, my intention to repeat

these experiments, by passing a stream of electricity through cylinders filled with various fluids under a glass receiver inverted over mercury; the greatest possible care being taken to shut out extraneous matter. Should there be those who blame me for not having done this before, to such I answer that, independent of a host of other hindrances, which it is not in my power to set aside, I have been closely pursuing a long train of experiments on the formation of crystalline matters by the electric agency, and now different modifications of the Voltaic battery; in which I am so interested, that none but the ardent can conceive what is not in my power to describe.

2dly. These insects do not appear to have originated from others similar to themselves, as they are formed in all cases with access of moisture, and in some cases two inches below the surface of the fluid in which they are born; and if a full grown and perfect insect be let fall into any fluid, it is infallibly drowned.

3dly. I believe they live for many weeks: occasionally I have found them dead in groups, apparently from want of food.

4thly. It has been frequently suggested to me to repeat these experiments without using the electric agency; but this would be by no means satisfactory, let the event be what it would. It is well known that saline matters are easily crystallized without subjecting them to the electric action; but it by no means follows that, because artificial electricity is not applied, such crystals are formed without the electric influence. I have made so many experiments on electrical crystallization, that I am firmly convinced in my own mind, that electric attraction is the cause of the formation of every crystal, whether artificial electricity be applied or not. I am, however, well aware of the difficulty of getting at the truth in these matters, and of separating cause from effect. It has often occurred to me, how it is that such numbers of animalcules are produced in flour and water, in pepper and water? also, the insects which infest fruit trees after a blight? Does not a chemical change take place in the water, and likewise in the sap of the tree *previous* to the appearance of these insects, and is or is not every chemical change produced by electric agency? In making these observations I seek to mislead no one. The book of nature is opened wide to our view by the Almighty power, and we must endeavor, as far as our feeble faculties will permit, to make a good use of it; always remembering, that

however the timid may shrink from investigation, the more completely the secrets of nature are laid bare, the more effectually will the power of that Great Being be manifested, who seems to have ordained, that

“Order is Heaven's first law.”

I beg to remain, in the mean time, my dear Sir,

Yours, very sincerely,

ANDREW CROSSE.

Broomfield, Dec. 27, 1837.

P. S. Since writing the above account, I have obtained the insects on a bare platina wire plunged into fluo-silicic acid, *one inch below* the surface of the fluid at the negative pole of a small battery of two inch plates in cells filled with water. This is a somewhat singular fluid for these insects to breed in, who seem to have a flinty taste, although they are by no means confined to siliceous fluids. This fluo-silicic acid was procured from London some time since, and consequently made of London water; so that the idea of their being natives of the Broomfield water is quite set aside by this result. The apparatus was arranged as follows: Fig. 7, a glass basin (a pint one) partly filled with fluo-silicic acid to the level 1. 2, a small porous pan, made of the same materials as a garden pot, partly filled with the same acid to the level 2, with an earthen cover, 3, placed upon it, to keep out the light, dust, &c. 4, a platina wire connected with the positive pole of the battery, with the other end plunged into the acid in the pan, and twisted round a piece of common quartz; on which quartz, after many months' action, are forming singularly beautiful and perfectly formed crystals of a transparent substance, not yet analyzed, as they are still growing. These crystals are of the modification of the cube, and are of twelve or fourteen sides. The platina wire passes under the cover of the pan. 5, a platina wire connected with the negative pole of the same battery, with the other end dipping into the basin, an inch or two below the fluid; and, as well as the other, twisted round a piece of quartz. By this arrangement it is evident that the electric fluid enters the porous pan by the wire 4, percolates the pan, and passes out by the wire 5. It is now upwards of six or eight months (I cannot at this moment put my hand on the memorandum of the date) since this apparatus has been in action, and though I have occasionally

lifted out the wires to examine them by a lens, yet it was not till the other day that I perceived any insect, and there are now three of the same insects, in their incipient state, appearing on the naked platina wire at the bottom of the quartz *in the glass basin at the negative pole*. These insects are very perceptible and may be represented thus (magnified): fig. 8, 1 the platina wire, 2 the quartz, 3 the incipient insects. It should be observed that the glass basin, fig. 7, has always been loosely covered with paper. The incipient appearance of the insect has already been described. The filaments which project are in course of time seen to move, before the perfect insect detaches itself from its birth-place.

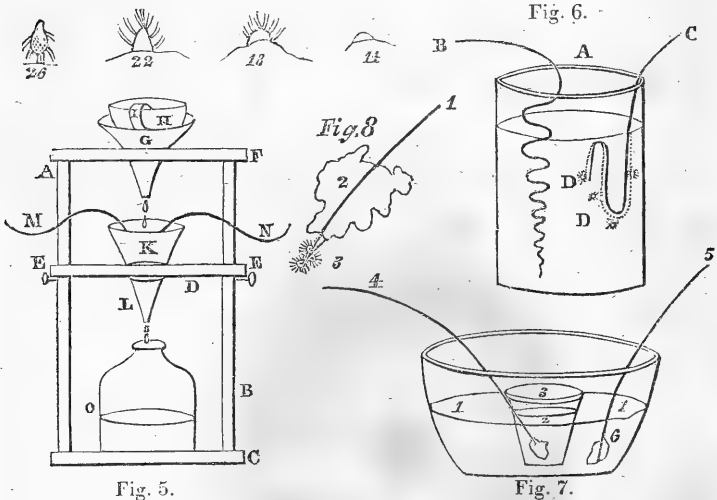

Fig. 5, front view of the filtering apparatus, by the use of which, the insect described made its first appearance. (A, B,) two of the four uprights or legs issuing from the base (c,) supporting a movable shelf (d;) which shelf is kept in its place by four pins (E) passing through the four uprights, and may be raised or lowered at pleasure. (F,) the top shelf, which has an aperture cut in it to receive the Wedgwood ware funnel (G.) (H,) a quart basin standing on an unseen support within the funnel (G,) which support is a circular piece of wood with holes cut in it to allow the free passage of the fluid between the basin and funnel. This basin is filled with the fluid required, which is conveyed out of it by the strip of flannel (I,) hanging over the outside of the basin, and inside the funnel, and which, consequently, falls in successive drops through the funnel (G) upon the stone (K,) which is supported by the glass funnel (L,) kept constantly electrified by the two platina wires (M, N,) resting on the opposite sides of it, and connected with the opposite poles of a voltaic battery. (O,) a wide mouthed bottle standing on the base (c,) to receive the fluid as it falls from the second funnel (L.) From this bottle,

when required, it is poured back again into the basin (н) without disturbing the stone (к.)

Fig. 6, (A,) a glass cylindrical vessel, containing about a quarter of a pint, filled with a concentrated solution of silicate of potash. (B,) a fine silver wire formed into a coil, which is immersed into the fluid in the cylinder, the other end being connected with the negative pole of the battery. (C,) an iron wire about one fifth of an inch in diameter, bent somewhat in the form of an inverted syphon, immersed in the same vessel, and connected with the positive pole of the battery. (D, D) insects in their incipient state making their appearance, some on the gelatinous silica which partially covers the wire, and some on the naked wire itself. These insects appear magnified.

---

ART. XI.—*Notice of Danburite, a new Mineral Species*; by CHARLES UPHAM SHEPARD, M. D., Professor of Chemistry in the Medical College of the State of South Carolina.

THE mineral here described, I found upwards of two years ago, while engaged in the geological survey of Connecticut. It was collected in the town of Danbury near the manufactory of Col. WHITE, and occurred in small masses of a delicate bluish white and highly crystalline feldspar, found among fragments of dolomite, coming from a bed in place near the mills. The feldspar is extremely feñid, when rubbed or broken: in which respect it resembles the same mineral found in thin veins of dolomite at a locality a few miles distant, in the town of Brookfield,—a circumstance which leaves little room to doubt that the specimens at Danbury, though found detached, were nevertheless derived from the dolomite.

The mineral believed to be new is observed disseminated in small quantity through the feldspar (with which is likewise associated a small quantity of quartz) in fissures and cavities having the shape apparently of oblique prisms. Owing to the partial decomposition of the mineral (a change to which it appears to be particularly liable) these cavities are sometimes entirely empty. The longest of them noticed was above an inch in one direction, by one fifth of an inch in another.

Whether the mineral will be found in any considerable quantity, I am unable to say. The specimens collected, have been barely sufficient to afford the following notice.

*Mineralogical Description.*

Primary form. Oblique rhombic prism.

Cleavage parallel with P indicated obscurely by fissures.

Lustre vitreous, in a high degree. Color shades of honey yellow. Streak white; transparent. (The decomposing variety is nearly white, translucent and very fissile.)

Hardness = 7.5. Sp. Gr. = 2.83.

*Chemical Description.*

When heated alone before the blow-pipe, it phosphoresces and fuses slowly without intumescence into a white blebby, transparent glass. With borax, it melts with effervescence into a transparent globule. When heated in a glass tube, it emits moisture. In the condition of an impalpable powder, it is taken up by hydro-chloric acid after long digestion.

By the requisite trials, it was found to contain neither fluoric, boric, nor phosphoric acid. By heating, it lost 8 p. c. in weight. By ignition with twice its weight of anhydrous carbonate of soda, it fused into a white mass, which formed a colorless solution with dilute hydro-chloric acid. After the separation of the silica, which weighed 56 p. c., the solution was precipitated by ammonia, and the precipitate treated with carbonate of ammonia solution in large excess, which after frequent agitation and some time standing was partially evaporated; a pale yellow pellicle invested the sides of the capsule, which after drying weighed 0.85 p. c. It was treated with hydro-chloric acid, and the solution obtained afforded when tasted no impression of sweetness. Its yellowish color and easy solubility after ignition in hydro-chloric acid proved it not to be zirconia; while the absence of sweetness showed that it was not glucina. It seems most probable therefore, that it is yttria.

The portion of the precipitate by ammonia not taken up by the carbonate of ammonia, was treated with a solution of potassa. It was instantly dissolved, and on being precipitated with hydrochlorate of ammonia, washed and ignited, it amounted to 1.7 p. c.

The clear hydro-chloric solution from which the alumina and yttria? had been separated was precipitated by oxalate of ammonia, and the precipitate was washed and ignited. The residuum gave 28.33 p. c. of lime.



The solution from which the oxalate of lime had been thrown down was treated with ammonia and phosphate of soda, without having its transparency effected, whereby the absence of magnesia and lithia in the mineral was apparent. After several hours standing, chloride of platina was added, which immediately gave rise to the fine granular precipitate of the double salt of platino-chloride of potassium.

Whether the mineral contains soda as well as potassa, I am not at present able to say.

The following therefore is a summary of what I have been able to infer respecting the chemical constitution of the mineral under consideration :

Silica,	-	-	-	-	56.00
Lime,	-	-	-	-	28.33
Alumina,	-	-	-	-	1.70
Yttria?	-	-	-	-	0.85
Potassa (perhaps with soda) and loss,					5.12
Water,	-	-	-	-	8.00

100.

The above result favors the idea of the following atomic arrangement : viz.

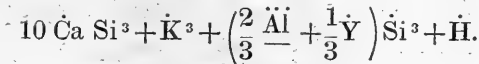

ART. XII.—*On Certain Cavities in Quartz, &c., in a letter to the Editor, from Dr. WASHINGTON L. ATLEE, dated Lancaster, Penn., Dec. 9, 1837.*

*Dear Sir*—WITHIN our city and its vicinity I have picked up several anomalous specimens of quartz, bearing the impressions of the different faces and angles of crystals, that afterwards became detached. In most of these specimens these impressions are deep, giving a cellular aspect to the whole mass. In some, they are tabular and evidently rhombic, or portions of rhombs, having their various angles and inclined faces accurately defined. In others, the indentations are principally pyramidal and cuneiform, with here and there a tabular rhombic impression. In one large and beautiful specimen, the cells are much larger, and more uni-

formly rhombic, than in any other that I have seen. The general figure of this specimen is oblong. It is compressed upon two opposite surfaces, and possesses additional interest by having two translucent crystallized surfaces capping the one end. These faces incline at an angle of about  $120^\circ$ , are 8 inches long, and  $3\frac{3}{4}$  wide, having a ragged periphery, as if broken, and constituting two of the planes of an hexagonal prism. Another smaller specimen has two sides of the prism and two sides of the pyramid extending across the centre of the mass; while a third is completely surrounded by innumerable cells, with acicular crystals of actynolite pervading one end.

In order to ascertain the particular angles of these cavities, several casts were made for me by my friend Dr. E. Parry. Taking these as correct models of the crystals that preoccupied these cavities, it will be easy to ascertain their exact figure. The following diagrams will represent the angles of several of the casts, viz.

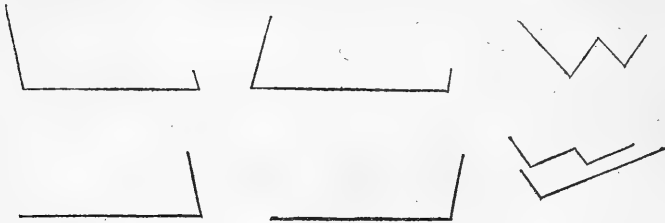

These angular and tabular impressions vary in size from the smallest pyramidal point and rhombic table, to rhombic cavities of three inches parallel diameter, and two inches in depth. And you will perceive that the above diagrams are all portions of rhombic figures.

A geological inquiry naturally arises as to the cause of the peculiar cellular structure of these specimens. Before inquiring into the particular agents which prepared the quartz to receive these impressions, and caused the dispersion of the crystals that produced them, it will be necessary to examine into the character of the solids, which, at one time, were encased by these peculiar cavities. Your attention has been called above to the rhombic form of the casts. Now there are no mineralogical specimens, of a rhombic character, occurring in our vicinity, that so exactly correspond with these casts as those of calcareous spar. This is

not only proved by goniometrical measurement, but also by placing a crystal of this spar into one of these depressions; the faces and angles of both come into exact apposition. This will be apparent to you by making a drawing of a few crystals indiscriminately taken up, viz.

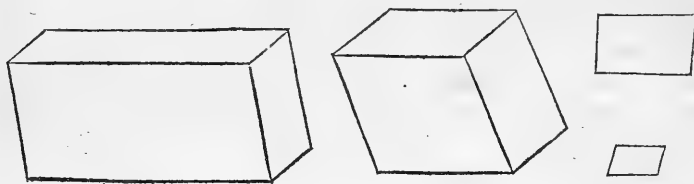

This form of carbonate of lime is of very frequent occurrence in our neighborhood, and crystals, varying in size, are aggregated together in masses corresponding to the cellular character of these specimens. Still, in no specimen, have I been able to trace within these cavities any of the remains of carbonate of lime. In other specimens of cellular quartz, occurring in our vicinity, where the cavities are formed by the disintegration of cubic and amorphous pyrites, the remains of the sulphuret are quite evident. Would it not, however, be fair to infer, from the exact correspondence of the former with the latter, even though no portion of the former remained, that the crystals of calcareous spar caused these cavities? Assuming this inference as correct, we can now pursue the inquiry further.

In investigating the cause of this phenomenon, there are two agents, water and heat, to which I shall confine my remarks; and as fluidity must have been essential to formations of such peculiar character, it will be necessary first to ascertain what natural operation could have contributed to it. We have only to notice the frequent occurrence of siliceous stalactites, the large beds of porcelain clay formed by the disintegration and decomposition of granite, animal and vegetable petrifications, the formation of agates and other minerals in the cavities of basaltic and trappean rocks, the constitution of sandstone, and many other instances, to be convinced of the fact that water frequently holds silex in solution or suspension, and conducts it, by percolation, to faults, dislocations, or crevices, where, becoming again precipitated, it gradually consolidates into some regular mineralogical form, or moulds itself to the particular contour and around the

projecting points of the cavity. The action of water, therefore, is capable of reducing quartz to a fluid and plastic state.

The occurrence of calcareous spar is most frequent in veins, cavities, or fissures, associated with quartz and other minerals. Its formation is likewise dependent upon the filtration of water, holding carbonate of lime in solution, which assumes its crystalline character from the slow percolation or evaporation of the water. Water, therefore, saturated with siliceous particles, in its progress through the earth, will get access to cavities lined with calcareous spar, and here gradually precipitate them. These particles will regularly accumulate, and as the water which conveyed them there filters out, they will condense more and more, and ultimately consolidate around the projections and within the angular sinuosities of the uneven surface of this mass of aggregated crystals. The quartz, thus becoming plastic, will mould itself to the spar, and this afterwards becoming dissipated by agents incapable of acting on the quartz, will leave its impressions accurately defined, and communicate to these specimens their peculiar character.

The question regarding the separation of the carbonate of lime from the quartz next arises; and the agent most likely to accomplish this without impairing the integrity of the quartz or forming a new and insoluble compound in the cavities, I conceive is water. Although water itself is not a good solvent of carbonate of lime, yet, when charged with carbonic acid, its power is much increased. Now, it is well known that there are many local sources of carbonic acid gas, and even in our own county, it is frequently found collected in large quantities in the bottoms of wells. That this gas, always generating by some subterranean process, combines readily with water in its vicinity, is evidenced by the frequent occurrence of carbonated springs: and as the absorbent power of the water is increased in a direct ratio with the pressure, so is its solvent power augmented in proportion to the accumulation of carbonic acid. Carbonic acid gas, therefore, confined within cavities beneath the surface of the earth, must necessarily be exposed to considerable pressure, and under these circumstances will be copiously absorbed by water in contact with it. Water, thus impregnated, being conveyed to the mass of crystals imbedded within the quartz, will effectually dissolve it and wash it out from the cavities it formed, without in the least affecting the conformation of the quartz.

It is in this way that I conceive the production of these cellular specimens may depend upon the agency of water ; but, as their formation may be attributed, perhaps with equal propriety, to the action of heat, I am disposed to carry the investigation a little further.

Nearly all modern geologists and chemists have given their consent to the existence of central heat, as indicated by the increase of temperature as we descend into the earth, by the heat of the water of the Artesian wells, by the occurrence of thermal springs; the existence of active volcanoes, and other familiar facts. That this central heat is very intense, may be inferred from the fused condition of volcanic productions, and yet it is questionable whether these productions are exposed to the maximum of heat. The volume and chemical character of lava would indicate volcanic heat to be equally as great, if not much greater than that of the compound blowpipe, and yet we have seen, from the experiments of yourself and Dr. Hare, that the power of the latter will fuse silix with ease and rapidity, and Lavoisier effected this with oxygen gas on burning charcoal. Now, as veins or beds of quartz are usually situated in primitive rocks, it must necessarily have been exposed to the most powerful action of central heat in order to occupy its present situation.\* If, therefore, the cavities of these veins and fissures were pre-occupied and lined by crystals of calcareous spar, we can easily conceive how the injection of this siliceous fluid would cover and fill the angular points and depressions of the rhombic crystals, and by subsequent and gradual refrigeration the consolidation of the quartz would be effected, and one as it were be dove-tailed into the other. The heat, also, necessary to the fluidity of the quartz, would be more than sufficient to expel the carbonic acid from the spar, and as this would not affect its crystalline conformation before the quartz would solidify, the cellular peculiarity of the latter would not of course in any wise be modified. After these parts had sufficiently cooled, water gaining access to them, and coming in contact with the decarbonated lime, would cause it to *slacken*, thus producing perfect disintegration ; and by the continuation of the supply of water, the hydrate of lime thus formed would be washed out of the cavities in the quartz. So that the same heat which rendered the quartz plastic enough to assume this form, prepared the cal-

\* The igneous origin of these veins may, perhaps, be too positively inferred, as it is conceivable that they could be effected by infiltration.

careous spar for its disintegration by reducing it to *quicklime*, between which and water a new chemical combination occurs, which effects its final dissipation, and leaves the specimen as we find it, free from any traces of carbonate of lime, except the mere correspondence of the crystals of the latter with the cavities of the former.

The crystallized hexagonal surfaces of two of the specimens can be explained by either the agency of heat or water, as crystallization from solution can be artificially effected by evaporation, and afterwards can be again liquefied by heat, and re-crystallized by gradual cooling. Yet the specimen containing actynolite would indicate an igneous origin.

Whether the formation of these specimens can be attributed to either of the above causes, or to both, or to neither of them, and at what particular geological period they may have occurred my knowledge is too limited positively to determine. Their consideration, too, may be more curious than useful, yet as they have not received any attention from the authors in my possession, I have taken it for granted that the specimens are rare, and that their history might be a slight contribution to science. These motives have induced me to forward you an account of them, with my hasty views of their production, believing, too, that if they possessed real interest my communication would not be unwelcome, and that if they do not, no harm could result.

P. S. There is a communication on Spontaneous Combustion in Vol. xxxiii of your Journal, by Dr. James Mease, and among other instances is one taken from Hazard's Register of Pennsylvania, of a piece of wood taking fire in the store of Mr. Adam Reigart of our city. This statement differs from that made to me by Mr. Reigart and his clerk, Mr. G. H. Whitaker. The wood was *chestnut*, quite solid, about eight inches long, and three or four wide, and cut smooth with a penknife. Two days before the burned wood was observed, they had *washed* the shelf and handled the wood with *wet* hands. When first noticed *it was not then on fire*, but the most of it had been reduced to ashes. The unconsumed portion was ragged and perforated,\* and what is remarkable, not in the least *charred*, while the *paint* on the shelf on which it lay was destroyed as by fire. Mr. Whitaker still had a portion of the wood and ashes, which he presented to me.

---

\* Probably the combustion only took place at the points which had previously been wet.

ART. XIII.—*On the Atmospheric Origin of the Aurora and its Connexion with the Crystallization of Snow*; by B. F. JOSLIN, M. D., of the city of New York, and late Professor of Natural Philosophy, &c. in Union College, Schenectady.

New York, 122 Bleeker street, Aug. 17th, 1836.

TO PROF. SILLIMAN.

*Dear Sir,*—There appears to be increasing evidence of an intimate connexion between the aurora and atmospheric vapor, a connexion which has not been wholly overlooked by recent observers. Recent epochs may have been more favorable to its exhibition in the middle latitudes. In the two brief notices of the aurora in the Transactions of the British Association, which met in August, 1837, this is the most prominent feature. In one, Dr. Traill describes the contemporaneous exhibition of stationary cirri and auroral streamers, and, in the other, Mr. Herapath attempts to refer the aurora to the precipitation of aqueous vapor. Still earlier, in your own respectable Journal, in a notice of my theory, published in 1836, there was an implied acknowledgment of the existence of some kind of auroral vapor, and even of its magnetic properties.

In March, 1836, there were published Observations on fifty six Auroras, seen by me at Schenectady, N. Y., within the five preceding years, and some new views as to the connexion between this meteor and clouds, rain and snow.\*

The author desires to avail himself of the wider circulation of the Journal of Science to communicate to the public some of the principal results, to add others in confirmation of the same views, and to correct a misapprehension which may prevail in relation to the elevation which he assigns to this meteor.† The small elevation which he is supposed to have assigned it is the only objection which he has seen made to his views.

---

\* Vide Appendix No. 2, to the Report of the Regents of the University of the State of New York, and the same in a pamphlet of sixty nine pages, entitled "Meteorological Observations and Essays."

† For the sake of convenience, the term meteor will be used in its more comprehensive sense.

Below is a passage from the paper above referred to, and relates to its different classes of facts, propositions and speculations. It may show that the author has not confounded their different degrees of evidence.

'The present article not having been commenced with reference to any comprehensive theory, presents some miscellaneous facts, which are thrown into the common stock for the use of others. Even among the relevant facts, there are, undoubtedly, interesting relations yet to be traced. 2d. The article contains some generalizations, whose results, whilst they may suggest to others a more correct theory, cannot be thereby invalidated. 3d. There are inferences of another class which may be modified, but probably not overthrown by the progress of discovery. For example, that the aurora is an electrical phenomenon; that it is intimately connected with the elements of clouds, and with these elements only when they are generated in air intensely cold as well as nearly saturated; and that cirrus clouds of a certain class are intimately connected with auroral action, and that both these phenomena, and also coronæ, do, for some reason or other, require a cold adequate to the crystallization of aqueous vapor, are propositions which will not lose all their interest nor any of their truth, even if the discovery should be made that the elements of clouds are essentially globular or vesicular, and that the vapor is not yet crystallized at the time of the phenomenon. It may be necessary to remark, that we have not intimated that all snow is not crystallized. On this subject crude notions have prevailed. 4th. As to the views which belong to a more hypothetical class, the author will cheerfully renounce them when a more plausible theory shall appear, as they are designed to facilitate, not to limit, investigation. This theory may contain much that is novel, valuable and true, without being in the highest sense *the* truth.'

The individual facts on which the generalizations are founded, cannot be here repeated. Of the second class, or the generalizations, are the following

*Propositions,*

*Which may be regarded as approximately and generally true,* in relation to mean results, though not universally, or in relation to each particular instance.



Proposition 1st, in relation to the *relative time of greatest depression of temperature before different meteors.*

The greatest daily depression or decrement of temperature takes place between one and two days previous to the aurora borealis, auroral clouds and halos.\*

Proposition 2d. *Relative order of the thermometric and barometric changes before different meteors.*

Previous to the clouds and halos, the temperature changes either earlier than the pressure or nearly at the same time; previous to the aurora, the pressure changes more than one fifth of a day before the temperature.\*

Proposition 3d. *Length of time before the storm† when its indications appear in case of different meteors.*

When the snow or rain is preceded by an aurora borealis or by luminous columns, the thermometer begins to fall and the barometer to rise between three and five days before the storm; and when the storm is preceded by auroral clouds or halos the same indications are presented between three and three and a half days before it.

Proposition 4th. *Increase of pressure before rain or snow not preceded by these meteors.*

Previous to a thunder shower, or a rain or snow not preceded by an aurora borealis, a halo, or auroral clouds or luminous columns, the increase of atmospheric pressure for several successive days is less general, but when it does occur, it commences either earlier or later than when the storm is preceded by either of those meteors; more generally between five and a half and six days before the shower or storm.

Proposition 5th. *Time from different meteors to snow or rain.*

The snow or rain descends sooner after a halo than after an auroral cirrus cloud, earlier after this than after a vertical lunar column, and earlier after a lunar column than after an aurora borealis.

Proposition 6th. *Theoretical inference in relation to the nature of these meteors.*

---

\* These propositions now stand nearly as they were corrected in the list of errata in many Nos.

† I use the term storm from the want of a better one equally brief, to signify the descent of rain, snow, or hail.

As they are all preceded by a depression of atmospheric temperature below the mean, and by an augmentation of pressure greater than that which precedes the fall of snow or rain at times when none of these meteors have recently appeared, there is additional evidence of the similarity of their origin.

Proposition 7th. *Theoretical inference in relation to their altitude.*

We may infer from the last two propositions that a magnetic cirrous cloud is higher than a halo, but lower than a lunar column, and the latter lower than the aurora borealis.

Proposition 8th. *Practical inference with regard to the prognostication of storms.*

The foregoing propositions which relate to pressure and temperature may suggest a rule for predicting storms much earlier than by other methods; inasmuch as these changes, and especially that of the barometer, take place even more generally than those opposite changes which often occur within the twenty four hours immediately preceding the storm, and which have been observed by others, and generally regarded as among the surest indications.'

The above propositions are deduced from tables here omitted, and are founded upon the observation of forty auroras, twenty two auroral clouds, seen in the day time, seventeen halos, and four luminous columns. The propositions in relation to the last and more rare phenomenon, the author considered as entitled to less confidence on account of the small number observed. Yet the optical theory which he gave of it in which he attributes it to a mixture of horizontal, specularly-reflecting, crystalline plates, with masses which are more amorphous and which produce a reflection virtually radiant, he considers as complete and satisfactory, and corroborated by his observations on the crystals which subsequently descended. The author has observed the aurora in connexion with the above and other meteorological phenomena of the same, the preceding and the succeeding days, and endeavored to trace their respective and relative changes, and as far as the subject admitted, by the statistical and numerical method. This is a fertile field, and comparatively unoccupied.

In the 3d, or class of inferences, he has endeavored to show a *connexion between the aurora borealis and the crystallization of snow.*

The following is a summary.

'That crystals of snow more minute and simple than those which occasion halos, and usually too minute to produce sensible opacity, are always present in the atmosphere, above the region of ordinary clouds, during the time of this meteor, we are induced to believe from a comparison of the results of the foregoing observations. Several of these results are believed to be new. The following are some of the circumstances which have a bearing upon this question.

1st. Those seasons of the year and those hours of the night when it most frequently occurs, are favorable both to the presence and congelation of aqueous vapor in the atmosphere.

2d. The clearness of the sky, which at such times is usually either general or total.

3d. The usual northerly breeze at the earth's surface, and the northeasterly breeze in the high region of the meteor.

4th. The usual depression of the temperature, at those heights at which thermometrical observations are made.

5th. The clouds which usually succeed the meteor immediately or on the same evening, and which often present the appearance of being continuous and identical with the auroral matter.

6th. The snow that in weather sufficiently cold, almost universally follows the meteor, after such an interval as the simple crystals might be expected to require for aggregation in more complicated groups and descent to the earth's surface.

7th. The rain that almost universally succeeds it, after about the same interval, whenever the temperature of the lower atmospheric strata is sufficient to melt falling snow.

8th. The co-existence of halos with regular crystals, the connexion between halos and auroral clouds, and between auroral clouds and vertical lunar columns, and the analogy between auroral clouds and the aurora borealis.

9th. The pinnate appearance of composite auroral clouds, which appear (so to speak) like large crystals.'

From this point, the author, not finding any former theory of the aurora not liable to great objections, has ventured into the regions of speculation, and in relation to the intimate nature of the phenomenon, and under the 4th head, of views of a more hypothetic class, has ventured to inquire whether atmospheric crystallizations may not occasion the development of auroral

light, and the crystals be, under some circumstances, magnetic; and in relation to the 9th remark, has inquired, 'May not this expression be used as something more than a figure of speech? What is so likely to produce this structure, so regular, and yet so complicated, as the polarity of component crystals, whether this polarity is or is not magnetic? May not the ponderable material of the colonnade of an aurora borealis consist of similar groups of crystals, formed either from the vapor of water, or from some lighter, less condensible and more magnetizable vapor in the upper regions, which crystallizes at the same time, and under similar meteorological influences with the former?' Has not the crystalline character of the higher clouds, if it exists, been generally overlooked by meteorologists; and when they have represented all clouds as being masses of condensed vapor, and snow as resulting from its subsequent congelation, have they not overlooked the universally crystalline character of snow, forgotten the small height which is necessary for crystallization, and suffered their imaginations to be influenced by their own temperate climes and moderate elevations?

In advancing a step farther in the attempt at an explanation of the intimate nature of the phenomenon, and especially as connected with aqueous crystals, the author has ventured with diffidence upon a topic still more recondite and obscure, but has found some support in analogies drawn from the electrical light seen during the crystallization of water, from the induction of crystals, and the magnetism developed by changes of temperature in many crystalline substances ordinarily unmagnetic. That iron, probably from its magnetic properties, has a peculiar relation to the crystals of hoar frost, he has been led to suspect, from their tendency to assume a position at right angles to the edges of a magnet and of a tinned vessel, at temperatures between zero and  $-12^{\circ}$ .

'In experiments with the solar microscope, I have been struck with the analogy between the polarity of crystals and that of magnets, a polarity evinced by the rotation of the smaller groups, in their approach to the larger and more complicated ones. The extent of rotation produced in one group by another never exceeded  $180^{\circ}$ . I have also detected a still more interesting analogy in the influence which a large group exerts upon the formation of smaller ones at a considerable distance. There was a real *induction*. This was evident from the fact that a large nucleus

spread more rapidly than a small one, advancing like a wave, overtaking and absorbing those waves which had begun to spread from a smaller nucleus. This induction, or the influence of a crystalline mass, in disposing particles and small crystals which are in its vicinity, but at some visible distance from it, to unite *with each other*, was still more evident from observing on the screen the existence and motions of scattered clusters composing a darkly dotted border or penumbra, skirting the darker image of the general crystalline mass already formed, and regularly advancing before it across the screen. Perhaps we should hardly be justified in calling such phenomena magnetic; yet it would be easy to show that these and many other phenomena exhibited by microscopic crystals, are regulated by laws strikingly analogous to those of magnetic induction.'

The above phenomena may be shown with great distinctness in tincture of camphor, sufficiently diluted to make the process slow.

If the electricity of crystallizing water is ever connected with magnetism, it must be during the perfect crystallization in the elevated regions of auroral action, where the circumstances are favorable to the perfection both of the process and the products. The rarity of the vapor there is favorable to a regular aggregation of the molecules, and the cold is intense. During crystallization, the temperature of the crystal might rise to  $32^{\circ}$ , by the evolution of latent heat, and soon afterwards sinking perhaps  $100^{\circ}$ , to the original temperature of the vapor. For such immense and instantaneous changes, a less elevation in the air is requisite in the higher latitudes; and there, it appears from observation, that the aurora itself is less elevated. It is unnecessary to cite the numerous authorities which exist, to prove the occasional lowness of the aurora in high latitudes. Mr. Trevelyan observed, that in Faroe and the Shetland islands, it was often seen not more than forty or fifty feet above the sea, and learned, that in both countries it is frequently heard. One person had perceived in it, when red, an electrical smell.\*

In our latitude, the aurora is usually at great heights. On this subject the author's views seem to have been misapprehended. Some of the intimate connections which he has proved to exist,

---

\* Edinb. Philos. Jour. vii, 182.

as well as others which he has believed to exist, between the aurora and a certain class of clouds seen in the day time, do not imply an usual identity of location. He had stated, that the aurora is usually higher than clouds, even than cirrous clouds, which are often many miles above other clouds, and many miles above the highest mountains. It by no means follows, that its origin is above crystals of the invisible kind. That the latter may be forming and descending for many hours, and in some instances a day, before they attain such a number, magnitude and complexity, as to form visible haze, is evident from the phenomena of halos and vertical solar and lunar columns in a clear sky. But these crystals, in their nascent state, must have had a still earlier and higher existence. Should it then be thought surprising, that minute crystals, in a region far above halos, should require a day longer for their aggregation and descent?

It is not my present purpose to discuss at length the question as to the intimate nature of the aurora; but I am of opinion that in some region, usually high, a crystallization takes place on the evening of an aurora, and that the latter originates in the atmosphere. In the publication above referred to, I have ventured to speak of such a thing as "atmospheric magnetism," and to regard it as the direct cause of the needle's disturbance, and as located in a kind of auroral vapor; although it was the prevalent opinion of philosophers, that the aurora, so far as it was magnetic, was connected with changes in tellurian magnetism alone, that is, the magnetism of the solid earth. The variations of the needle were thought to afford evidence of variations in the latter; and this view was thought to be corroborated by some simultaneous disturbances of the needle in distant parts of the globe. Numerous facts might be cited, in corroboration of the atmospheric location. Let one at present suffice. During the brilliant and extensive red aurora of Jan. 25, 1837, I observed at Schenectady, N. Y., a variation of the needle of  $1\frac{1}{2}^{\circ}$  in eighteen minutes, of  $2\frac{1}{4}^{\circ}$  in two hours, and  $2\frac{1}{2}^{\circ}$  during the night. At New Haven, the variations were, at one hour, still more rapid, that is,  $45'$  in two minutes; but the whole extent observed was only  $1^{\circ}$ . About thirty miles north of New Haven, no change whatever could be detected; whilst at Annapolis, the needle varied to the astonishing amount of  $10^{\circ}$  during the night.\* Are not these facts wholly

---

\* See this Journal, Vol. xxxii, p. 180.

irreconcilable with the idea, that the needle was disturbed by a general change in the magnetism of the earth? According to Capt. Back, auroral beams sometimes seem to attract each other. Does not this seem like atmospheric magnetism?

There appears to be no reason to believe that the aurora is at an invariable elevation. Calculations founded on observed altitudes, have given results varying from a few miles to several hundred. This discrepancy may be explained, partly by an actual difference of height, and partly by mistakes as to the identity of arches when several have been presented to different observers. In the latter case, a mistake will usually lead to an exaggeration, rather than to an underrating of the elevation. Suppose two observers, near the same meridian, but in different latitudes, to take the altitudes of two arches situated north of their respective observers, and at so small an elevation, that the southern arch is below the horizon of the northern observer, and the northern arch below the horizon of the southern observer. Only one being seen by each, they are liable to be presumed identical; and the great altitude of the northern as compared with the southern arch, would lead the mathematician to refer the imaginary arch—considered as one—to an elevation greater than the actual elevation of either of the real arches. There is evidence that the above case is more than a supposable one, and that similar mistakes have actually occurred. The opposite error, an exaggeration of the parallax, would, from the nature of the case, more rarely occur. I have stated the first in a plain way, that those who are little conversant with the subject may not be deterred from examining the physical evidence of a theory of the aurora, by a caveat supposed to have been entered by the exact sciences. There are facts quite as conclusive as a great parallax: such as the numerous instances where individuals at moderate distances cannot recognize the same phases, and some of them not even the existence of the aurora seen by the others. In such cases, it may fail to be measured, simply because it is too low.

The views which I have taken of the aurora, whilst they do not require us to discredit those numerous proofs, both physical and mathematical, of its occasional situation in the inferior atmospheric strata, at the same time, allow, or even require us to refer it in most instances to elevations above (and in the lower latitudes far above) the regions of the highest proper clouds, and

many times as high as ordinary clouds. Physical considerations have induced me to refer its origin to the earth's atmosphere. The height of this is well known never to have been determined, so far as respects those rarer portions which reflect no sensible light.

Those who reflect, that there is a depression of about  $1^{\circ}$  for every 300 feet of elevation, will find little difficulty in admitting the existence of crystals of snow above us in summer. The following facts have a bearing on this, as well as on the connection between the aurora, snow, and magnetism. "On the 16th of August, 1836, I observed, at Schenectady, an aurora, at 10 P. M., chiefly obscured by clouds, and a faint aurora with three or four short streamers extending to the height of  $\gamma$  Ursæ Majoris, at 2h. 10m. next morning. The sky was clear, and remarkably so during the forenoon. At 7 A. M., the magnetic intensity was high and remarkably variable; the time required for 100 oscillations of a suspended needle being 270 seconds at 7 o'clock, and 280 ten minutes later. Rain commenced at 9 P. M. of the 18th, about two days after the first appearance. Quantity during the night, .32 inch. On this day, the 18th, an aëronaut, Mr. Lauriat, who ascended from New York over Long Island, encountered what was called by the papers "a pretty severe snow storm in the upper regions; and when he touched terra firma, his clothes were frozen stiff."\* The crystals may have been minute. The following is from another paper, and may perhaps refer to the same ascension. "In Mr. Lauriat's last ascension from New York, he ascended about five miles, and proceeded over a hundred miles. He passed through clouds of sleet, which covered his balloon with icy particles. But what was more interesting, he discovered that when he was at the greatest altitude, the needle of a compass which he had with him did not have the least tendency to exhibit polar attraction, but wavered about at all points of the compass."† May we not conclude, that the atmospheric magnets at the height of five miles acted more powerfully than the earth? Even at the surface, I have inferred, from many hundred observations, that the magnetic intensity is more affected by the forma-

---

\* New York Commer. Adver. of August 19, 1836.

† Middlebury Free Press of Nov. 29, quoting the Boston Herald—date not given.



tion of the higher clouds, and other obvious crystallizations, than by any periodical diurnal changes.

The following facts have also an interesting bearing on the theory. At Fort Enterprise, where Lieut. Hood found the aurora in one instance to be only  $2\frac{1}{2}$  miles high, he was, in two instances, surprised to see a discharge of snow, in small flakes, from a clear sky, at times when the aurora was active near the zenith.\* These facts, with existing theories, were then extremely puzzling; but they are in exact accordance with the above theory. The short interval before the snow, and the diminutive flakes, are what might be expected in case of an extremely low aurora. Lieut. Hood's measurements and observations will not be disputed.

As early as 1820, (April 3,) my interest in the subject of the connection between the aurora and apparent clouds, was excited by a beautiful white arch, like a roll of wool, which on that evening was seen to detach itself from the summit of an aurora of the ordinary character, and in the rapidity of its motion toward the zenith, in the distinctness of its texture as it approached it, in the resemblance of this texture to that of a fleecy cloud, and in other circumstances, seems to have been unlike any arch in an elevated region.

Subsequently, an interesting class of objects of a more decidedly nepheological character, but still intermediate between the aurora borealis and ordinary clouds, has presented itself in polarized, linear cirri, or magnetic or auroral clouds. The linear cirri, when of great extent, and in other respects of a regular character, have generally been either in or near the magnetic meridian, or nearly at right angles to it. In hundreds of instances, these positions are within a degree or two of them. These can hardly have been accidental coincidences, and they have had no constant relation with wind. In epochs marked by auroras, these have been more marked. They are occasionally composite, consisting of an arch with rays, like streamers. Whence the polarity of these clouds? They open an interesting field, and establish a curious analogy between the aurora and the phenomena of the lower regions. Although the N. and S. delicate lines correspond with auroral streamers, in their coincidence with the meri-

---

\* See appendix to Franklin's Journey to the Polar Seas,

dian, yet the author has not confounded them, but has shown that the former differ from the latter in the absence of the dip.

But the analogy is not restricted to position. It was soon detected in the concomitant phenomena. I have shown, by tabular views, that the thermometer usually begins to fall, and the barometer to rise, several days before each, and rain or snow to descend within one, two, or three days after them. In the cases subsequently presented, in which the number of hours between the aurora and storm has been carefully noted, I have usually found that the time has been about thirty six hours, and that there is a curious exception in the case of two auroras on two or three consecutive nights, in which case, the rain or snow is less likely to descend, or is deferred till nearly the usual time after the last. The same is true of the polarized clouds, and of halos; in both of which, vapor, which had unquestionably been precipitated, is redissolved, or otherwise disposed of, during the time and under the influence of the circumstances preparatory to or attendant on the second exhibition.

This interference of one aurora with the results of its predecessor, opens a curious field of investigation, discloses a new analogy between this and meteors of a confessedly aqueous origin, and refers to a general law the observed exceptions to the descent of precipitated vapor which so generally takes place after an aurora. In almost every instance in which this has been deferred, there have been traces of auroral action on the succeeding night, though sometimes masked by the moon. The following rule has had few exceptions, viz. If the evening of the day after an aurora is totally clear, no storm follows on the second day; and conversely, if no storm is to follow, this evening is totally or nearly clear. This general clearness is itself one of the usual attendants of auroral action; and I have for many years observed, that the morning following an aurora is, in this respect, remarkable, as compared with other mornings. In this fact, and in the unusual clearness of the night of the meteor—with the exception of some peculiar, transient clouds—we have proof of the influence of an aurora, or the circumstances which precede and attend it, in effecting the resolution or disappearance of visible vapor or precipitations.

This enables us to explain or generalize the fact of the non-appearance of the storm, of which the first of two consecutive

auroras would have been the precursor. As tending to elucidate this new and interesting field of inquiry, I will state the results of observations on thirty two auroras observed at Schenectady, N. Y., between Oct. 5, 1830, and Nov. 3, 1833—the tables being prepared for these alone, although the results of subsequent observations are, I am persuaded, not less striking. My observations are made at 9 A. M. and 9 P. M. The proportions of sky clear at the times of observation, are set down in tenths. About one day before an aurora, the sky usually begins to increase in clearness. In the following results, reference was had only to clearness as compared with the corresponding hour of the preceding day, and only to mean results. During the 24 hours preceding the morning of the day on the evening of which the aurora occurred, the sum of the increments of clearness was to that of the decrements as two to one.\* During the 24 hours immediately preceding the aurora, the increments are to the decrements as six to one. Similar results would be obtained by taking the number of instances in which the clearness increased or diminished in case of different auroras, instead of the amount of tenths, as above. Within the two days preceding an aurora, and on some part of the night of it, we observe all the circumstances preparatory to and connected with crystallizations in the high regions, developing themselves; such as increasing atmospheric pressure, increase of cold, and the disappearance of clouds. On the other hand, during the day or two succeeding it, are developed all those circumstances which attend a more advanced stage and lower descent of the products, whether crystalline or melted; such as a diminution of atmospheric pressure and clearness, and an elevation of the temperature and dew point. The latter changes, occupying less time, are more rapid than the former, and hence appear more striking. For example, during the 24 hours succeeding an aurora, the decrements of clearness are to the increments as 37 to 1. But this high ratio requires in reality to be further increased, in conformity with the principles above established. For, the principal increase of clearness which occurred,

---

\* The sum of the tenths which respectively express the amount by which the sky became clearer on the respective days immediately preceding the different auroras, is called, in expressing the mean results, the sum of the increments during the 24 hours immediately preceding *the* aurora. A similar expression is used for other epochs and for the decrements.

was in a single instance, and that on the occasion of two consecutive auroras, the latter tending to prolong and increase the clearness. This instance being omitted—as it should be—the decrements of clearness during the 24 hours succeeding the aurora are to the increments, as 112 to 1, the increment having been in one instance one tenth, and the whole decrement in thirty instances, 112 tenths. On none of the eight instances in which there were auroras on two consecutive nights, had the cloudiness increased on the evening of the second, as compared with that of the first. The mean decrement of clearness for the remaining 24 instances, was .46. Hence, to give a popular statement, approximately true—the evening of an aurora is, on an average, twice as clear as the succeeding evening, unless another aurora occurs on the latter; in which case, the sky continues equally clear. As the forenoon succeeding an aurora is in general unusually clear, this great decrement of clearness usually takes place in a few hours, whilst the increments had required several days.

The following table, (abstracted from those on which the nine propositions are founded,) shows the mean temperatures at 9 P. M. of the days of the different meteors, and on the evenings one and two days previous; also the mean number of days previous, when the changes of pressure and temperature commenced.\*

Names of the meteors.	Number of observations on each kind.	Temperature two days previous.	Temperature one day previous.	Temperature at the time.	Time before when the barometer began to rise.	Time before when the thermometer began to fall.
Aurora Borealis,	40	44.9°	44.1°	42.5°	2.16	1.95
Polarized clouds,	22	40.5°	37.2°	35.2°	1.90	2.12
Halos,	17	33.8°	29.6°	28.9°	2.09	2.30
Vertical beams,	4	23.5°	16.7°	14.5°	3.00	1.87

The number of vertical beams is so small, as to forbid confidence in mean results as to elapsed time. In the case of the other meteors, we see a pretty near correspondence as to the times when the thermometric and barometric changes commen-

\* Certain errors which, through the inadvertence of an assistant, had crept into the tables, are here corrected.

ced before them all; and find, in the relative temperatures required for them, a corroboration of the conclusion drawn from the time of the succeeding storm in relation to their relative heights in the air.

The absolute temperature is, for the seasons of their occurrence, low for all, and of itself affords evidence of the existence of crystals. From semi-monthly observations for five years, on two springs at Schenectady, I have inferred, that the mean temperature of the earth there is  $48.8^{\circ}$ ; and this accords nearly with the mean temperature of the air in that vicinity for the last ten years. Should we make allowance for the daily mean, and for the mean seasons of the year in which the aurora occurs, we should have a still more just and striking view of the cold usually required for its production. The barometer rises and the thermometer falls before an aurora, and the mean length of time is about two days; and consequently these changes commence about four days before the storm, or about three and a half days when there are not two auroras in succession.

This affords one of the earliest and surest prognostics of the storm, and is more to be relied on than even the subsequent depression of the barometer, which, in modern times at least, seems solely to have attracted attention. It would be curious, (though it is perhaps improbable, and I have not seen the original,) if this early ascent of the barometer were that alluded to in the long since banished rule of Pascal. Though this patriarch of this branch of science may, as is alledged, have fallen into a grave error in regard to this, yet there will be revived a certain modification of his rule, that the barometer rises before a storm; and perhaps he may be acquitted of the error and prove to be the original discoverer.

That the changes of pressure and temperature commence before the aurora, accords with the above theory. They are to be regarded as among the causes rather than the effects of the aurora. Yet that they continue a little beyond the time of it, I have long since observed, and expressed it by the rule, that the barometer is usually rising, and the thermometer falling, on the evening of an aurora.

Within a few years, an interesting confirmation of the above theory, so far, at least, as to the fact of a connexion between atmospheric vapor and magnetism, has been presented in many in-

stances, at different times, in a peculiar deep blue, but not linear, cloud, resting on the horizon in the north, in the day time; its center of gravity being exactly, or almost exactly, in the magnetic meridian. Whenever the cloud was of this deep blue color, its direction was taken by the compass; and to avoid any bias from preconceived theory, a point judged to be the centre of gravity was selected, previous to the use of the needle. The variation from the meridian rarely exceeded a fraction of a degree; the correspondence in direction being more exact than that of the position of most polarized clouds. Had the writer been influenced by love of theory, he might have wished the latter and more explicable phenomenon to be the more regular of the two. He would invite the attention of more northern observers to this somewhat mysterious phenomenon, should the return of auroral epochs reproduce it. To those less favorably situated, he may appear to have drawn upon his imagination. Did time and space permit, he might give more particulars. He hopes occasionally to resume this and kindred subjects, so far as his present residence in a latitude less favored by auroral exhibitions, and his more exclusive devotion to professional duties will allow.

ART. XIV.—*Letters on Atlantic Steam Navigation.*

By JUNIUS SMITH.

LETTER I.

London, 30th July, 1838:

TO BENJAMIN SILLIMAN, ESQ.

*Dear Sir*—Perceiving from your daily and periodical journals, that Atlantic steam navigation is attracting public attention in the United States, and having been in some measure instrumental in forming and maturing the plan here, perhaps the following remarks may not be altogether uninteresting at the present moment.

I do not mean to advocate the abandonment of the use of sails, whilst I shall endeavor to show that it is not a philosophical method of propelling a ship. It will be sufficient if I show that the application of steam power is both safer and more philosophical than the power of wind in navigation.

If you direct your attention to a sailing ship, you will find that she has three masts; that these masts are vertical levers; and of

consequence, the direct tendency of these levers, when the power of wind is applied to their sails, is to upset, instead of to propel the ship. Hence we find, practically, that when the wind increases at sea, the shipmaster's first care is to take in the top-sails, which is nothing more than shortening the levers upon which the power of wind acts. A ship going by the wind is capsized when the power acting upon the levers is greater than the resistance.

When a ship with her sails set is taken aback, she is hurried stern first into the depths of the ocean from the same cause, and not much time given to think about it, unless the levers are shortened in time, by taking in the sails, as a change in the position of the ship sufficiently quick, brings the acting power to bear in a different direction.

If the resisting power of the ship is sufficient to sustain her position on the water, and the levers are forced beyond their strength, then the ship is dismasted, and left, a helpless thing, to the mercy of the storm. The power always acts upon vertical levers, and daily practice, in sailing ships, shows the danger. In a steam ship, as such, the power is applied to a combination of short levers, acting horizontally upon the body of the ship, and in a direction the reverse of the power of wind upon sails, always propelling the ship forward, and never losing power by a collateral motion.

The paddle-wheels of the *British Queen* are 30 feet in diameter, of course about 93 feet in circumference. The floats are about three feet asunder, which will give thirty one sets of floats to each wheel. There are three floats in a cycloidal position in each set, nine and a half feet in the clear in length from one side of the wheel to the other, and one foot in breadth. Hence you will perceive that each set of floats has a superficial area of twenty eight and a half square feet, equal to 873 square feet for each wheel, and 1746 for both. The midship section of the *British Queen* presents a resistance of 550 square feet to be overcome by 1746 feet of the floats.

The mean speed of the wheels may be taken at sixteen revolutions per minute, and at that rate would run 29,760 yards per hour, equal to seventeen miles. If we deduct one fifth, the usual allowance, from the velocity of the periphery, to reduce it to the mean velocity of the wheel, we then have thirteen and a half

miles per hour for the true speed of the ship by steam power. The distance from Portsmouth to New York is 3000 miles; and supposing the ship to run thirteen miles an hour, she would make the passage from port to port in nine and three quarters days. But we must not overlook the fact that the resistance of the water will increase as the square of the velocity of the ship; and therefore it may happen that the same power acting against an increased resistance, will not be found adequate to maintain the full speed which the calculation indicates. But I apprehend it cannot fall much short in velocity, and therefore cannot much exceed in the time required to perform the voyage.

Each set of floats is sustained by three radii, fifteen feet in length from the centre of the wheel to the periphery. But if we count these three radii as one lever of fifteen feet in length, then we have, by the combination of thirty one sets of levers, two equal to  $232\frac{1}{2}$  feet in length, acting horizontally upon the body of the ship, without the slightest tendency to throw her from an even keel. The danger of the ship's capsizing, of being taken aback, or of being dismasted, is entirely obviated, and the violence of the winds can have little other effect than that of disturbing the surface upon which she floats.

P. S. The President, of the same tonnage as the British Queen, is now building for the New York line, and will be followed by the Great Britain and the United States.

#### LETTER II.

London, Sept. 5, 1838.

Having shown, in my letter of 31st July, that the navigation of a ship by steam power is more philosophical than by sails, because the power is applied to short levers, acting in a direction opposite to that of the power of wind upon sails, and always in a line horizontal to the body of the ship, and that therefore the danger of the ship's being capsized, or taken aback, or stranded, or dismasted, or strained by perpendicular levers, is entirely obviated; I proceed to suggest a few things relative to the practical results of sailing ships and steam ships.

Notwithstanding all that has been said and written upon the impracticability of navigating the Atlantic by steam ships, recent experiments have confounded the theoretically wise, and placed the affair upon a footing which no assaults can shake. Driven



from their first position, these scientific champions have encamped upon another, confident that their position is impregnable. They indeed admit, because they cannot now deny, that it is *practicable* to navigate the Atlantic by steam ships; but they contend that the ships will not pay a profit to the proprietors. This is a question worthy of a minute and careful investigation. A fair and impartial inquiry may place the matter in so clear a point of view, that the plainest understanding will comprehend it. No doubt those who possess the most practical information on the subject, have nursed it for their own benefit, whilst those who are not confined to narrow thought and selfish views, and who would give some light to the understanding of others, have it not themselves to give.

*Whatever article of produce or manufacture can be exported or imported in a sailing ship, at a remunerating freight, can be exported or imported in a steam ship at a greater or equal profit, independently of passengers.* To elucidate this proposition, which I am aware the public mind is scarcely prepared to credit, it is necessary to go into some details of the working power of steam and sailing ships.

It will be borne in mind, that in constructing a steam ship for commercial purposes, independently of passengers, the expense will be much less, and the capacity for stowage much greater, than when both objects are combined.

If we build a steam ship of 2500 tons measurement, her capacity for stowing, exclusive of engines and fuel, will not be less than 1600 tons register,\* equal to 2400 tons of measurement goods, of 40 cubic feet to the ton. A sailing ship of 400 tons register, upon the same scale of capacity, would take 600 tons of measurement goods.

For the sake of calculation, I will take the ports of New Orleans and Liverpool for the points of the ship's destination. I do not specify New Orleans as a more desirable port than any other in the United States for steam navigation, although I believe the commerce between that port and Europe may be carried on with singular facility and profit, especially as the Western Islands, Bermuda and Jamaica, offer natural stations for depôts of coal, and its vicinity to the Mexican territories opens a wide field for the combination of South American commerce with that of the Uni-

---

\* By a recent act of Parliament, the engine and coal rooms are deducted from the gross measurement, and the remainder is the legal register tonnage.

ted States and Great Britain; but by taking the extreme point of the United States, for the purpose of showing the advantages of steam navigation over sailing ships, it follows that all intermediate ports from New Orleans to Quebec, present at least equal relative advantages.

The following calculations, founded as far as practicable upon acknowledged data, will lead to a general result substantially correct, at all events sufficiently so to show the relative working power of steam and sailing ships.

A steam ship of 2500 tons, as mentioned above, deducting her engine and coal rooms, will leave her register tonnage 1600, and supposing her capacity for stowing to equal that of a sailing ship, she will carry 2400 tons of measurement goods.

A bale of New Orleans compressed cotton averages 20 cubic feet measurement, and 400 pounds weight; consequently, the ship would take two bales to a ton, equal to 4800 bales, for her entire cargo. If we assume one penny per pound freight, with five per cent. primage, it would be thirty five shillings a bale, or £8400 gross freight. Allowing the ship 73 days out and home, she would complete five voyages per annum, and bring home 24,000 bales of cotton, making a homeward freight of £42,000. If we suppose the ship to make only one quarter of a freight out, and I see no reason why she should not make a whole freight, that would give £2100 out, equal to £10,500 per annum, grossing, out and home, £52,500.

Let us examine, upon the same data, the working power of a sailing ship of 400 tons register, and see how many it will require to perform the same labor, and earn the same freight.

She will carry 600 tons of measurement goods, or 1200 bales of cotton, allowing her the same capacity for stowing as the steamer, and allowing her to complete two and a half voyages a year, which is as much as she can do, she will then bring home 3000 bales of cotton. It would therefore require eight ships, of 400 tons each, to carry the same quantity of cotton in twelve months as one steam ship, and to make the same freight out and home of £52,500. The relative power being the same, it makes no difference in the result, whether the ships carry more or less.

Seeing the work that one steam ship will perform, and having ascertained the number of sailing ships of equal tonnage capacity combined, required to perform the same, the only remaining material point now to consider, is the relative expense of navigation.

If it should appear that the expense of navigating one steam ship of 2500 tons is less than the expense of navigating eight sailing ships of 400 tons each, then I apprehend the proposition may be considered as proved; and it follows that it is more profitable to the ship owner to employ steam than sailing ships, independently of passengers.

NOTE.—New Orleans will probably cease to be a port of export and import of any importance within a few years. The great city of the west must be at the head waters of the Mississippi for foreign steam navigation. All the commerce will be carried on in steam ships, and they may as well go up the river for their freights, as the freights come down the river to them.

## EXPENSE OF NAVIGATION.

<i>Eight Sailing Ships of 400 Tons each.</i>			<i>One Steam Ship, of 1600 Tons Register.</i>		
<i>One Sailing Ship 12 Months.</i>			<i>One Steam Ship 12 Months.</i>		
	£	s. d.		£	s. d.
1 master, at 10l. per mo.	120	0 0	1 master, at 20l. per mo.	240	0 0
1 mate, " 5 "	60	0 0	1 mate, " 10 "	120	0 0
1 2d do. " 4 "	48	0 0	1 2d do. " 8 "	96	0 0
1 steward, " 3 "	36	0 0	1 3d do. " 6 "	72	0 0
1 cook, " 2 10 "	30	0 0	25 seamen, " 2 10 "	750	0 0
1 carpenter, " 4 "	48	0 0	1 engineer, " 20 "	240	0 0
14 men, " 2 10 "	420	0 0	1 2d do. " 10 "	120	0 0
			1 3d do. " 8 "	96	0 0
20 men for one ship,	£762	0 0	12 firemen, " 3 "	432	0 0
8 ships,		8	1 cook, " 2 10 "	30	0 0
			1 steward, " 3 "	36	0 0
160 men's wages, for 8			1 carpenter, " 4 "	48	0 0
ships, is	£6096	0 0			
Victualing 160 men, at			47 men's wages,	£2280	0 0
10s. each per week, is,			Victualing 47 men, at 10s.		
per annum,	£4160	0 0	ea. per week, per annum,	1922	0 0
<i>Port Charges at Liverpool.</i>			1200 tons of coal each voy-		
Pilotage out and in, £20 0 0			age—5 voyages per ann-		
Light & dock dues, 35 0 0			num, at 12s. per ton at		
			Liverpool, and 30s. at N.		
For one ship, - £55 0 0			Orleans—6000 tons coal,	6300	0 0
or for 8 ships, £440, which			average 21s. per ton,		
for two and a half voy-			<i>Port Charges at Liverpool.</i>		
ages per annum, is - £1100 0 0			Pilotage out and in, £22 0 0		
<i>Port Charges at N. Orleans.</i>			Light & dock dues, 140 0 0		
Pilotage in and out, \$100				£162 0 0	
Levee fees, - 50			For one voyage, or		
Towage up the river, 300			for five voyages, -	£810	0 0
Do. down do. 125			<i>Port Charges at N. Orleans.</i>		
	\$575		Pilotage out and in, £25 0 0		
Or £129 7s. 6d. for one ship,			Levee fees, - 12 0 0		
and for 8 ships is £1035,			(No towage req'd.)	£37 0 0	
which for two and a half			For one voyage, or for five		
voyages per annum, is £2587 10 0			voyages, - - -	185	0 0
Total for 8 ships, £13,943 10 0				£10,797 0 0	
Gross charges upon eight sailing ships,	£13,943	10 0			
Gross charges upon one steam ship, -	10,797	0 0			
			Difference, £3,146 10 0		

Thus it appears that one steam ship of 1600 tons register will perform the work of eight sailing ships of 400 tons each register in the freight of goods only between New Orleans and Liverpool, at less expense by £3146 10s. per annum. The petty expenses, such as reporting the ship at the custom-house, advertising, and the like, will always be in favor of the steam ships; but in showing the relative working power of the two classes of ships, it is not necessary to enumerate trifles. It will however be apparent to every candid inquirer, that if a steam ship can not only be supported by carrying goods at the same rate of freight as a sailing ship, but make a larger profit; that when the collateral advantages of passengers, speed, and certainty of time, are taken into consideration, the preponderance in favor of the steam is strikingly obvious.

Mercantile men will see, that as the time occupied by a steam ship in performing a voyage is not half that of a sailing ship, the sea risk is diminished in the same proportion, and consequently the premium of insurance will not be more than half the amount charged upon sailing ships.

The sooner the shipper can get his goods to market, the better for him; and if he can do it in half the time by a steam ship, that would be required by a sailing ship, it follows, as an inevitable consequence, that one half the capital would carry on the same amount of business in a steam ship, as would be required in sailing ships; because he could make two shipments or two importations, or both, in a steam ship, when he could make but one in a sailing ship. The whole commercial capital employed in foreign trade, upon the general introduction of steam navigation, will be doubled in its powers of carrying on commerce, and twice the amount of business done upon the present capital, or the same business upon half the capital.

If I have succeeded in establishing the proposition with which I commenced, then we may give rein, and allow the imagination to reach forward a few years, when sailing ships will become as rare as steam ships are now, and when the ocean will be covered with paddle-wheels instead of canvass.

Astronomers make the circumference of this earth 24,000 miles: steam navigators make it only 12,000. And although the breasts of men will still rage, and the sources of war remain, yet the nations of the earth will approximate, and a more subdued state of

society lessen the calamities of war, and throw around its horrors something of humanity.

Civilization and intercourse go hand in hand. The light of science and the revelations of truth, blending their rays, and beaming upon barbarism, will soften down its character, and hasten the advent of more glorious times.

#### MISCELLANIES.

1. *Report on the Shooting Stars of the 9th and 10th of August, 1838*; by EDWARD C. HERRICK.

It was expected that an unusual display of shooting stars would be witnessed on or about the night of the 9th of August, 1838.\* The arrival of this period was awaited with no ordinary interest, inasmuch as there was reason to hope that observations might then be made, which would remove some of the uncertainties which had hitherto rested upon the origin of this beautiful phenomenon. In this part of the country, observers were unfortunately deprived, by unfavorable weather, of any satisfactory view of the heavens during the season of the expected visitation. The accounts of observations which I have hitherto received from distant places, where the sky was clear, although not in every particular so complete as could be wished, are yet amply sufficient to show that the meteoric shower of August did not disappoint the expectations of those who looked for its recurrence during the present year.

##### I. *Observations made at New Haven.*

In order to obtain a thorough knowledge of the phases of this meteoric shower, it seemed necessary to observe on the nights of the 8th and 11th, as well as on those of the 9th and 10th. Accordingly, on the evening of the 8th, I kept a look out, and saw in half an hour, ending at 9h. 15m. *five* meteors, one of them more brilliant than Venus, with a splendid train. This number is not much above the average. At later periods of the night, the view was so much interrupted by clouds, that no regular observation was kept up. During the night of the 9th, the sky was entirely overcast. On the evening of the 10th, at the end of twilight, the sky was clear. Being myself occupied at that hour, Mr. *M. D. Bagg* kindly offered his assistance. Taking his station at 9h. and directing his attention towards the S. at an elevation of  $80^{\circ}$ , he saw in an hour 28 meteors: a lad, standing by, counted, during the same period, in the North,

\* See this Journal, Vol. 33, p. 402.

26. The moon rose at 9h. 42m. and, consequently, had thus far interfered very little. Between 10h. and 11h. Mr. B. counted in the same region, 20 meteors, which, considering the presence of the moon, is evidently an increase on the hour previous. Soon after 11h., as we were arranging for the night, clouds rapidly overspread the heavens, and frustrated all further observations. The entire night of the 11th was overcast and stormy. The evening of the 12th was beautifully clear, and even at this late date, it was evident, from a quarter of an hour's observation, that shooting stars were much more numerous than common. I regret that I could not conveniently watch throughout that night. Mr. E. Fitch informed me that in one hour, somewhere between 9h. and 11h. of that evening, he counted about 25 of these meteors.

## II. *Observations made at other places.*

1. At *Middletown, Ct.* watch was kept by Prof. *A. W. Smith*, and Messrs. *Knox* and *Rice*, of the Wesleyan University. During the whole night of the 9th, clouds covered the sky. On the night of the 10th, the sky was still cloudy, and afforded no opportunity for regular observation, but the observers were convinced that the meteors were more numerous than usual. No observations were attempted on the night of the 11th or 12th.

2. From *Geneva, N. Y.* Mr. *Azariah Smith, Jr.* writes, that on the evening of the 9th, about 9 P. M. the sky was partially clear in the North, and that on going abroad to observe, he "saw half a dozen meteors shoot across the open space in about the same number of minutes; after which, through the night, clouds covered the heavens. Of these meteors, all but one passed from the East to the West, and that one came from the zenith. Two were peculiarly bright and left long trains in their rear." No observations on the nights of 10th or 11th.

3. At *Buffalo, N. Y.* observations were made by Mr. *R. W. Haskins* and Dr. *C. H. Raymond*. On the morning of the 8th, from 1h. to 3h. 30m. they saw *fifteen* meteors, which is, of course, nothing unusual. "The morning of the 9th was densely clouded, with rain falling copiously." On the morning of the 10th, observations were commenced at 1h. A. M. "The state of the heavens was unfavorable. The moon, approaching the meridian, was so luminous as to obscure every star in her vicinity, save those of the first magnitude; the whole South, from this body to the horizon, covered with clouds, which were rapidly extending themselves over the other portions of the sky. At 2h. 30m. there was no clear sky to be seen. During this hour and a half, and under many disadvantages, forty meteors were counted" by the two observers. Mr. Haskins continues, "The appearances this morning, when taken in connection with all the adverse circumstances under which they were viewed, I am inclined to think were somewhat peculiar. Had there been

clear sky, absence of moon, and observers enough to have scanned every part of the heavens, it seems probable that meteors in considerable profusion might have been counted. Of those seen, the greater part left visible trains behind them, and many of them were seen through a haze which obscured all the smaller stars. As to a point of radiation: there are some facts connected with these observations that *may* indicate such a point; but they may, just as well, in our present state of knowledge, be wholly disconnected with the phenomenon, and certainly can not now be offered as proof on this point. The lines of flight of most of these meteors, if extended back, would cross near the tail of *Camelopardalis*, and this is the point, ( $55^{\circ}$  R. A.  $60^{\circ}$  N. D.) which Mr. Schaeffer points out as the centre of radiation of the August shower of 1837. As a coincidence, this is perhaps worth mentioning, but certainly as nothing more at present." No observations on the night of the 10th or 11th.

4. At *Hudson, Ohio*, very good arrangements for observation were instituted by Professor *Loomis*, but they were almost entirely defeated by clouds. The report which he has published in the *Cleveland Observer* of Aug. 16, 1838, concludes thus:—"On the whole, then, although the total number of meteors seen here was small, on account of the very unfavorable state of the weather, the observations lend some support to the theory that meteors are unusually numerous about the 9th or 10th of August." No observations on the night of 10th or 11th.

5. At *Barren Hill*, about 12 miles N. of *Philadelphia, Pa.* observations were made on the night of the 8th by Mr. *Geo. C. Schaeffer*, who reports as follows: "The house from which I observed was in a valley, over which the smoke from the fire in New Jersey spread a mist like a curtain, which, illuminated by a full moon, formed a very unfavorable medium through which to observe. My view was limited to a small portion of the heavens, so that I could not have seen more than one fifth or sixth of the entire number visible in a clear and moonless night. Between 11h. 30m. and 12h. 30m. I saw about 20. From various estimates, I think they appeared [to a single observer] at the rate of 15 or 20 an hour. I watched very closely for the radiant point, and found it near where I placed it in August last, [see this Journal, Vol. 33, p. 134,] but, to my very great surprise, there was a constant and regular progression of this point. In this I am not mistaken, as I devoted my whole attention to determine it. Between 11 and 12, it was about  $1\frac{1}{2}^{\circ}$  from  $\epsilon$  Cassiopeiæ, in a line from it to the North Polar Star; it passed near the star first named, inclining downwards, and at 3h. it was  $1\frac{1}{2}^{\circ}$  or  $2^{\circ}$  on the other side of it." No observations on the night of 9th, 10th, or 11th.

6. At *Norfolk, Va.* observations were made on the evening of the 10th, by Messrs. *J. D. Dana*, *H. Eld*, Jr. and *J. W. E. Reid*. Mr. D. writes: "Between 8h. 55m. and 10h. P. M. we observed *thirty six*, which obviously far exceeds the usual number at that hour. They appeared to

radiate from Cassiopeia, but it was not very easy to determine satisfactorily, the radiant point. The sky, within  $25^\circ$  of the horizon, was obscured by a thick haze, which prevented our seeing any meteors below that altitude." At a later hour, the clouds and the moon rendered it unadvisable to resume the watch. No observations on the night of 9th or 11th.

7. At *Society Hill, S. C.* Mr. *William A. Sparks* watched, at intervals, on the night of the 9th and morning of the 10th. On the 9th, at evening, the sky was clear, and the number of meteors appeared somewhat unusual. "About 3h. A. M." (10th) writes Mr. S. "I was awakened by my servant, who informed me that 'he had seen five stars fall since he first got up.' I rose immediately and went out, and although the moon was shining with brilliancy, in mid-heaven, I saw at intervals of from two to five minutes, quite a number shooting in all directions. At 3h. 35m. one remarkably bright, which I noticed more particularly, took its origin in the vicinity of the belt of Orion, shot about  $30^\circ$  toward the N. nearly parallel to the horizon, and almost eclipsed the splendor of Venus, which was just then emerging from the East. At 3h. 45m. the sky became entirely overcast with cumulo-stratus clouds, which prevented further observation. On this occasion, I counted *twenty four* meteors." Mr. S. states, that on the nights of the 8th and 10th the displays were much inferior to that of the night of the 9th.

8. At *Wilmington Island, near Savannah, Ga.* Mr. *Thomas R. Dutton* made observations, which are far more extensive and satisfactory than any which have hitherto reached me. The following table contains a synopsis of the results.

Date.	Time of Observation.		Number.	No. per hour.	Remarks.
1838.					
Aug. 9.	9 30 P. M.	to 11 30 P. M.	19	9.5	{ Moon rises at 9h. 25m. four days past full.
" "	11 30 P. M.	to 0 25 A. M. (10th)	13	14.18	
" 10.	0 25 A. M.	to 1 25 A. M.	14	14.	
" "	4 10 A. M.	to 4 20 A. M.	9	54.	
" "	9 30 P. M.	to 10 45 P. M.	17	13.6	{ Moon rises at 10h. five days past full.
" "	11 20 P. M.	to 0 20 A. M. (11th)	24	24.	
" 11.	0 30 A. M.	to 1 30 A. M.	26	26.	
" "	3 A. M.	to 4 A. M.	55	55.	

The following extracts are taken from the remarks which Mr. Dutton subjoins. "You will, I think, agree with me, that the present year presents, at this place, a recurrence of the meteoric shower of August last. In regard to *number*, two circumstances are to be considered: 1st, that there was but one observer; and 2d, that the moon was more than half



full. It is generally admitted, that it requires, at least, three observers to note all, and that the full moon obscures two thirds or three fourths of those which would be visible in its absence. In the present case, we may safely say, that one half were rendered invisible by the light of the moon. On the night of the 10th, one observer saw 140, in 5h. 15m. [and 122 of them in 4h. 15m.] Three observers would have seen 420 during the same time, [and in the absence of the moon, 840.] On the night of Nov. 12, 1837, four observers saw at New Haven, 223 in five hours; the moon at that time obscuring, perhaps, one fourth more than in the present case.

“On the night of the 9th, the *centre of radiation* appeared to be near a point in R. A.  $35^{\circ}$  N. D.  $69^{\circ}$ . The more extended observations of the following night led me to place it somewhere between this point and  $\epsilon$  Cassiopeiæ. I have more confidence in this conclusion, as on the night of the 10th, the meteors were more abundant, and several large ones started from near the radiating point. I can say with certainty that this point lay somewhere within the triangle formed by the three stars  $\epsilon$ ,  $\iota$ , and  $\psi$  Cassiopeiæ. From this point radiated at least three fourths of all the meteors seen on the nights of the 9th and 10th. Of the meteors thus radiating two thirds had trains. It was remarkable that of all those which had trains, there was but *one* which did not move from the radiating point. As this point was during most of the time of observation somewhere between  $20^{\circ}$  and  $60^{\circ}$  above the horizon, and as the meteors generally made their appearance at more than  $30^{\circ}$  from this point, we should conclude that but few would be observed to fall directly towards the horizon. This was the case during the two nights. About fifteen were seen to descend towards the north; the remainder either rose, passing near the zenith, or moved towards the south in lines nearly parallel to the horizon. The *field of view* during the nights of 9th and 10th, was the northern and northwestern part of the heavens, including on the right the constellation Cassiopeia and extending  $10^{\circ}$  or  $15^{\circ}$  south of the zenith. From 3h. to 4h. on the morning of the 11th, I hardly noticed one which did not come from the radiating point. None of the meteors seen on previous nights (between July 28th and August 6th inclusive) seemed to have a common centre of radiation. As to *magnitudes*, it may be observed that the meteors were of two very distinct classes;—one composed of such meteors as are visible upon every clear night. This class contained one fourth of the whole number seen, and were distinguished by their small size, (not exceeding stars of the third magnitude,) by their unconformable directions, and their greater velocity. The other class, containing the remaining three fourths, were all as large as stars of the second magnitude, and half them were equal in size to Venus as she now appears as the morning star. Of this class, but *one* had a direction which could be called unconformable, and at least two thirds of them had trains. Most of the

trains vanished as soon as the meteors which they followed, but in some cases they remained for one or two seconds, and were occasionally  $15^{\circ}$  or  $20^{\circ}$  long. The *velocity* of those meteors which were conformable was much less than that of those meteors which were unconformable, and much less also than that of those which are commonly seen. Those whose course was longest were visible from one and a half to two seconds. The *color* of these meteors was remarkably uniform, and was a reddish yellow, or flame color. In some cases the train was of a deeper color than its attendant meteor."

No facts concerning the appearance of this meteoric shower have yet been received from abroad. If the weather was favorable, observations were doubtless made in many parts of Europe. Especially may we expect a full report from M. *Quetelet*, of Brussels, who has done more than any one in Europe towards directing public attention to the subject of the occurrence of a meteoric shower in August.

#### *Remarks on the preceding statements.*

Before we can determine whether the exhibition of last August was unusual, it is necessary to know the average number of shooting stars visible at other times. Numerous observations made in conjunction with my fellow-laborer, Mr. *A. B. Haile*, and occasionally with other friends, furnish some materials for the determination of this question. These were made chiefly in the fall, winter and spring months, but the results will probably apply without much error to the summer season. According to these observations, if the light of the sun and moon be absent, the average number of meteors visible at the most abundant season of the night, viz. from 3 to 6 A. M., is about *fifty* per hour; and from 6 to 10 P. M. about *twenty five* per hour. Of these a single observer would probably detect one fourth or one fifth part. Much difference however exists in the fertility of the different quarters of the sky at different hours, and many more observations must be made, before exact data on this part of the subject can be obtained. In the present state of our knowledge it seems not improper to multiply by *four*, the number seen by an individual, in order to obtain the whole number visible at the place during the period of his observation. What proportion of these meteors is concealed by the light of the moon at its different stages, cannot be fixed with minute accuracy. If we assume, that in the present instance one half were rendered invisible by the moonlight, it will doubtless be considered a liberal allowance. Looking at the foregoing accounts with these principles in view, it is evident that *the number of meteors seen in this country about the 10th of August, 1838, was from three to eight times beyond the average.* To specify a single instance;—Mr. T. R. Dutton, near Savannah, saw between 3h. and 4h. A. M. of the 11th, *fifty five* meteors.

Multiplying this number by *four*, and the resulting quantity by *two*, we obtain for the entire number which might have been seen at that place, had the moon been absent, 440, or about nine times the average. It is unnecessary here to reduce the other reports in this way, as any one who chooses can do it for himself.

The observations on the position of the radiant point of this shower are not altogether satisfactory, and it will probably be advisable to wait for the better opportunity of determining this point which the meteoric shower of August 1839 will present, rather than to attempt to reconcile the accounts which have been already made public. Enough is known to prove that this radiant (as seen in this latitude) lies fifty degrees north of the point towards which the earth is at the time tending. This fact may perhaps intimate that the meteoric zone does not lie in the plane of the ecliptic.

Neither can we yet decide on what day between the 8th and 12th of August the shower arrives at its maximum. The determination of this and other important features of the phenomenon must be postponed to the coming year.

We are probably still unacquainted with all those periods of the year at which shooting stars occur in unusual numbers. It cannot be concealed, that on the night of the *sixth of December, 1798*, *Brandes* alone saw these meteors at the rate of 100 an hour for four hours. This display must have been nearly or quite equal to any August or November shower which has been witnessed since 1833. It is a highly interesting question, whether shooting stars do not now occur in unusual numbers on or about this day of the year, and it is earnestly to be hoped that none of our observers will suffer this period of the present year to pass without the most attentive inspection of the heavens:

To the facts heretofore adduced in this Journal (Vol. xxxiii, p. 176—180; 354—364; 401, and Vol. xxxiv, p. 180—182) in proof of the occurrence of a meteoric shower in August, I add the following testimony, which although not of the most satisfactory character, seems to merit quotation.

1. In Miss Harriet Martineau's *Retrospect of Western Travel*, (Amer. ed. 2 vols. 12mo. N. Y. 1838,) Vol. 2, p. 87, is the annexed account, pertaining to the evening of August 8, 1835:—"While the bright glow was still lingering in the valley, and the sky was beginning to melt from crimson to the pale seagreen of evening, I saw something sailing in the air like a glistening golden balloon. \* \* \* It burst in a broad flash and shower of green fire. It was the most splendid meteor I ever saw. \* \* \* I saw an unusual number of falling-stars before we reached home."

2. In Capt. J. E. Alexander's *Transatlantic Sketches*, (Amer. ed. Svo. Philad. 1833,) p. 102, in an account of the tremendous hurricane which

visited the West Indies on the night of Wednesday, August 10, 1831, occurs the following. “ \* \* Those who were driven into the fields, so far from being able to stand on their legs, could not even sit up, the wind was so violent as to throw them on their faces. The lightning flashed tremendously in their eyes and appeared to strike the ground only a few yards from them; but such was the roar of the wind, that the thunder could not be heard. *Innumerable fire-balls were seen to fall from the clouds.*”

The account of this hurricane which is copied from a Bridgetown (Barbadoes) paper into Lieut. Col. Reid’s “*Attempt to develop the Law of Storms, &c.*” 8vo. London, 1838, gives the following additional particulars. “About 3 A. M. (Aug. 11) the wind occasionally abated. \* \* \* The lightning also having ceased for a few moments only at a time, the blackness in which the town was enveloped was inexpressibly awful. Fiery meteors were presently seen falling from the heavens; one in particular, of a globular form and a deep red hue, was observed by the writer to descend perpendicularly from a vast height. It evidently fell by its specific gravity, and was not shot or propelled by an extraneous force. On approaching the earth with accelerated motion it assumed a dazzling whiteness and an elongated form, and dashing to the ground in Beckwith-Square, opposite the stores of Messrs. H. D. Grierson & Co., it splashed around in the same manner as melted metal would have done, and was instantly extinct. In shape and size it appeared much like a common barrel-shade (a glass cylinder put over candles in the tropics); its brilliancy and the spattering of its particles on meeting the earth gave it the resemblance of a body of quicksilver of equal bulk.” p. 29.

New Haven, September, 1838.

2. *Observations made at Yale College on the Eclipse of the Sun of September 18, 1838.*—Communicated by Professor OLMSTED.

I was prevented, by peculiar circumstances, from making any preparations for viewing the interesting eclipse of September 18th, having returned home from a journey only on the day of its occurrence. I found, however, that there was less reason for regret, as two young gentlemen of our senior class, *H. L. Smith* and *E. P. Mason*, had been very assiduous in making preparations for viewing the eclipse, having the necessary instruments all in readiness, and the time well regulated. Indeed, each of them was furnished with a good telescope of his own making, the former a Gregorian of three feet focus,\* the latter a Newtonian of seven feet.

---

\* Messrs. H. L. Smith and F. Bradley have recently constructed a large telescope, of which they have furnished me the following memorandum: The reflector has a focal length of about fourteen feet and is one foot in diameter, of the Herschelian construction. The stand and adjustments are not yet completed, nor

Both accompanied me in the College Observatory, while I made use of our large Achromatic of ten feet focus.

The weather was remarkably fine. For some time previous, the atmosphere was cloudy, with some rain, and the prospects were very discouraging; yet only an hour or two before the eclipse came on, the clouds broke away, and presented a sky as clear and serene as could possibly be desired. Indeed, we were great gainers by the previous state of the atmosphere, the sky being washed clean of all vapors, while yet the sun had not shone long enough to disturb the tranquillity of the medium, by ascending and descending currents. Hence, there was a peculiar sharpness in the line presented by the solar disk.

Each of the three observers kept separate notes, but the observations of the commencement of the eclipse differed scarcely at all from each other, and none of them from the mean of the whole more than one fifth of a second. The average of the three gave the following results, expressed in mean time:

Beginning of the eclipse,	3h. 21m. 14.47s.*
End,	5h. 52m. 17s.

The profile of the moon projected on the sun's disk, as seen through the large Refractor (Clarke's Telescope) with a power of 180, presented a very irregular outline. One mountain in particular, (*Mons D'Alémbert?*) near the centre of the margin, swelled out with striking prominence, having the rounded figure of an obtuse cone.

The darkness was not such as to make any of the stars visible to the naked eye; but a solemn, bronzy veil was thrown over the face of nature. The changes in the Barometer and Hygrometer, were inconsiderable; and the Thermometer suffered less reduction than it probably would have done had not the sun a short time previous emerged from a cloudy atmosphere. No change worthy of note was observed in the magnetic intensity.

Mr. Mason had attached to his telescope a divided object-glass micrometer, by means of which he made multiplied observations on the solar cusps, an account of which I am happy to subjoin in his own words,

---

is the telescope in an advantageous position for making delicate observations. The tube is a twelve-sided prism, strengthened internally by iron rings. The following objects have already been seen, and the results will afford some idea of its power. The nebula in Hercules between  $\eta$  and  $\zeta$  resolved into an immense number of small stars:—the annular nebula in Lyra very bright and distinct:—*Debilissima* inter 4 et 5  $\epsilon$  Lyrae, easily seen by direct vision:—small star near  $\alpha$  Lyrae very bright and distinct:— $\epsilon$  Bootis, 4 and 5  $\epsilon$  Lyrae of course easily separated:— $\sigma$  Coronæ Borealis,  $\pi$  Aquilæ, and the star south following  $\mu$  Bootis very distinctly double:— $\zeta$  Orionis triple:—companion of Rigel very bright, even when the stars of the belt had disappeared in the morning light.

\* It will be seen that this is 42.47 seconds later than the time given in the American Almanac.

deeming it unnecessary to add any remarks of my own, farther than to express my entire confidence in the accuracy of his determinations.

*Micrometric Measurements taken by E. P. Mason.*

During the progress of the eclipse, frequent measures were taken of the distances of the cusps, and the corresponding instants of observation were accurately noted. The instrument with which these were obtained was an achromatic object-glass micrometer, of Dollond's construction, attached to a 7 ft. Reflector, the value of whose scale had been determined by frequent comparisons with an accurate sextant in terrestrial measures, and by observations on stars of the Ast. Soc. Catalogue. The following are the distances obtained :

Time of Observation.			Distance of Cusps.		Time of Observation.			Distance of Cusps.			
h.	m.	s.	'	"	h.	m.	s.	'	"		
3	26	6.8	10	23.43	4	14	15.0	28	33.16		
"	27	49.1	12	1.63	"	15	12.9	28	44.39		
"	29	51.2	13	37.14	"	16	37.7	28	53.88		
"	30	58.0	14	28.11	"	17	36.6	29	5.53		
"	31	42.9	14	57.48	"	31	36.3	29	8.68		
"	32	43.7	15	35.92	nearest approach					19	13.59
"	35	5.4	17	2.18	"	51	41.9	29	16.77		
"	38	19.2	18	36.72	"	53	18.8	29	24.40		
"	42	2.2	20	23.52	"	55	44.2	29	23.38		
"	43	18.5	20	57.98	"	58	39.5	29	13.26		
"	44	26.9	21	20.87	5	0	49.7	29	4.88		
"	47	53.9	22	36.54	"	1	38.6	28	55.63		
"	48	35.7	22	54.58	"	2	28.0	28	53.51		
"	50	37.9	23	32.79	"	3	16.4	28	43.51		
"	52	44.6	24	12.57	"	4	10.8	28	41.66		
"	54	16.8	24	38.56	"	7	55.3	28	6.79		
"	55	6.2	24	52.99	"	8	34.2	28	2.44		
"	55	48.1	25	2.61	"	9	26.0	27	53.38		
"	58	33.6	25	46.78	"	11	24.3	27	29.23		
"	59	18.0	25	59.69	"	12	18.7	27	19.43		
"	59	52.9	26	6.48	"	13	40.4	26	56.76		
4	1	55.0	26	27.62	"	14	39.3	26	50.70		
"	8	6.0	27	46.16	"	16	42.1	26	16.15		
"	9	13.9	27	57.91	"	18	18.8	25	57.65		
"	10	11.7	28	1.93	"	19	56.1	25	37.30		
"	12	21.3	28	22.52							

A mean of 4 measures, in a direction about  $15^\circ$  or  $20^\circ$  inclined to the horizon, and 20m. previous to the instant of first contact, gave for the sun's diameter  $31' 53.7''$ . These were, however, taken amidst the hurry of preparation for the eclipse, and were too few in number to be a standard for the subsequent measures. The following horizontal diameters may be considered more determinate, and will serve to show the confidence which may be placed in the measures of the cusps :

8h. 15m.	-	-	-	-	31' 54.08"
" "	-	-	-	-	" 53.20"
" "	-	-	-	-	" 55.19"
" 20m.	-	-	-	-	" 55.56"
" "	-	-	-	-	" 55.64"
" "	-	-	-	-	" 55.00"
" "	-	-	-	-	" 54.82"
" 27m.	-	-	-	-	" 54.95"

the mean of which is 31' 54.81". It should, however, be remarked, that a more perfect judgment can be formed of the exactness of contact of sharply terminated points, such as were the cusps during the eclipse, than can be the case with edges or limbs, as tremulous as that of the sun, where an alternate overlapping and recession leaves something to estimation. On this account, an attempt to obtain several measures of greatest distance of limbs was relinquished, both because greater inaccuracy was apprehended from the above source, and the measures of the cusps afforded a more advantageous method of arriving at the same results.

The maximum distance of the cusps, which may be obtained by interpolation from those nearest in point of time, will give the observed diameter of the moon, free, it is believed, from the effects of irradiation. The minimum distance will be a greatly magnified measure of the error of the moon's assumed latitude, the ratio of increase of the distance of the cusps at that point to the corresponding difference of the latitude being about as 25.7 : 1.\*

At 5h. 20m. the measures of distance were relinquished, as the sun's proximity to the horizon would soon render any further observation of this kind of little value.

At the end of the eclipse, the sun was scarcely 3 degrees above the horizon, and the extreme undulation of his limb rendered much accuracy in the time of the observation impossible; and being, therefore, deemed of little importance, it was not carefully noted, and may possibly be in error.

The sidereal clock, from which the above determinations of time were taken and reduced, had been compared frequently during the months of August and September with transits of stars, and the deviations of the transit instrument, the value of the divisions of its level, and the irregularities of the clock's rate, carefully registered and applied. From a comparison of these observations, it appears, that the error of observation

---

\* The moon's latitude, as assumed for the calculation of the eclipse in the American Almanac, is by the observation of the nearest approach of cusps, 10.05" too large; a determination which, if the calculated semidiameters of the sun and moon be correct, is in error by only one nineteenth part of the error of observation.

in the transit of a single wire is seldom over .3 of a second; and the mean of the 5 wires of the instrument would, therefore, render the probable error certainly less than .1 of a second. The error arising from irregularity of the clock's rate is rendered of comparatively little moment by the fortunate coincidence, nearly, of the transit of Antares with the middle of the eclipse. The only remaining error of importance, that of the imperfection of vision, in noticing the first moment of ingress, may be presumed to be very small, from the circumstance that the observations were entirely independent, at two different clocks, in separate apartments, and the coincidence of results was not mutually known till some minutes afterwards, thereby preventing the otherwise natural result of catching the first glimpse by contagion. The agreement of the times of commencement to less than .2 of a second, under such circumstances, goes far to prove their accuracy. The clocks were compared by coincident beats immediately before and after the ingress.

The distances of the cusps are uncorrected for difference of refraction, which, in the last measures, is of considerable amount. If any of them should be found discordant with the others, from error in counting from the clock, or in registering, they will easily be discovered in the calculation, and corrected, if the mistake is evident, or otherwise entirely rejected.

3. *Supposed new mineral at Bolton, Mass.*—The following angles were obtained with the reflective goniometer, from a small crystal of a green mineral, sparingly disseminated in massive Scapolite, at the Bolton lime quarry. It occurs in small isolated prismatic individuals, imperfectly crystalline, or in divergent groups of slender flattened prisms, more or less perfect. The mineral has been considered Gadolinite, and by Prof. SHEPARD, who early observed it at the above locality, as Allanite, to which it is closely allied, if not identical with it.

The primary is an oblique rhomboidal prism,  $M : T = 113^\circ 45'$  and  $66^\circ 15'$ ,  $M : \bar{e}$  (replacement of *obtuse* lateral edge) =  $149^\circ$ ,  $T : \bar{e} = 144^\circ 45'$ ,  $M : \bar{e}$  (replacement of *acute* lateral edge) =  $128^\circ 45'$ ,  $T : \bar{e} = 117^\circ 30'$ ,  $\bar{e} : \bar{e} = 97^\circ 45'$  and  $82^\circ 15'$ . The crystals are flattened parallel with  $\bar{e}$ , and slightly resemble some varieties of green hornblende. *M* is bright, *T* much less so;  $\bar{e}$  is deeply channeled. No cleavage apparent. *H.* = 5.75. *G.* as found by Prof. S. 3—3.25, the former obtained with a fragment weighing 1.2 grains; the latter, with 2 centigrammes, or about one third of a grain. *Lustre*, resinous; *streak*, greyish or greenish white. *Color*, grass green—blackish green; translucent—subtranslucent; brittle.

A black variety occurs in the Petalite of the same quarry, which, in lustre and color, much resembles Allanite. The above angles and other characters seem, however, to indicate that this mineral is a distinct species. If it should prove, however, on further examination, identical



with Allanite, the above angles, as they were taken with the reflective goniometer, should be substituted for those usually given, which were obtained with the common goniometer.

I have not observed any terminal planes, but infer the probable obliquity of the primary, from the direction of a seam of carbonate of lime, which intersected the crystal. If we can place any dependence on this kind of evidence, the crystal is oblique from an *obtuse* edge.

The scapolite in which the mineral is found, contains, also, exceedingly minute zircons, scarcely  $\frac{1}{40}$  inch long, and also very small prisms of rutile. The zircons are square prisms, having the lateral edges truncated, and pyramidally terminated at each extremity; a narrow intermediary plane replaces the edge between a pyramidal plane, and one truncating a lateral edge. They are described in Naumann's System of Crystallographic Notation, as follows:  $\infty P \infty . \infty P . P . 2P 2$ . J. D. DANA.

July, 1838.

4. *New locality of Crichtonite.*—This mineral is found in the north part of Litchfield, Ct. about two miles from the village. The locality is upon the east side of the road, leading from the Wolcottville turnpike to Torrington, on the land of Mr. John A. Woodruff. It occurs crystallized in short hexagonal prisms, with the alternate angles replaced by single planes, inclining upon the base, at an angle of  $121^{\circ}$ , and upon the lateral planes, at an angle of  $134^{\circ}$ . The largest of the crystals are about three quarters of an inch in length, and two and one quarter inches in diameter. It is found imbedded in fragments of rock composed of quartz and mica slate. The prevailing rock is mica slate, from which these probably have been detached.

The mica slate also contains an abundance of staurotide. A common form of the crystals is that of the primary form, with the obtuse angles replaced. Some of them are four inches in length.

Y. C. Aug. 1838.

T. S. GOLD, A. B.

5. *Stilbite, Chabasie, and other minerals, at Stonington, Ct.*—Stilbite has been found within cavities in gneiss on the Stonington rail road, two miles and a quarter from that village. It is imperfectly crystallized, being composed chiefly of implanted globules, with occasional botryoidal masses, which, when broken, present the stellated structure common in this species. It is of a wax-yellow color, and subresinous lustre. Some specimens are of a light yellow color.

*Chabasie.*—In connection with the above, were found very minute crystals of Chabasie, of a light red color. But in a ledge on the rail road, a quarter of a mile further from its termination at Stonington, were found in rather more abundance, aggregated crystals of a deep carnation red color. The crystals are very obtuse rhombohedra, from one fifth to

one tenth of an inch in diameter. Owing to the brittleness of these minerals and the great hardness of the rocks in which they are imbedded, none but small fragments can be obtained, unless expensive excavations are made.

Associated with the above mentioned minerals are also found small traces of the following :

1. Zeolite, in small masses, whose fracture presents stellated radiations of a pink color. Their size varies from one fifth to half an inch in diameter.

2. Calcareous Spar, (with the last mentioned Chabasie) in hexagonal prisms ; and at the other ledge, in compact masses.

3. Scapolite, of an imperfectly crystalline structure, and light green color, partly decomposed.

4. Spheue, in two or three minute black crystals.

5. Apatite, in small crystals, of a bluish green color.

6. Magnetic Iron, in small masses.

In a ledge on the rail road, three miles and three quarters from the village of Stonington, are several veins of quartz, partly compact and in part composed of interlocking crystals. In two of these, which were from half an inch to an inch and a half in thickness, was found a layer of Fluor. It is generally about one fifth of an inch in thickness, varying, however, from one third to one tenth of an inch. The colors are light green and dark purple.

Traces of the same mineral were found in other veins at the same ledge.

At this place were also found thin veins of calcareous spar, dolomite, and serpentine.

W. W. RODMAN, A. B.

*Yale College, Aug. 1838.*

6. *Cricktonite, in R. I.*—It is found in the town of Westerly, R. I. in a ledge of gneiss, which has been quarried for building stone, on land owned by Mr. Nathan F. Dixon. It is situated one fourth of a mile north of the 6th mile stone, on the Stonington rail road. The mineral, in imperfect crystals, is disseminated through a mass of semi-crystallized quartz, which is two or three feet in length, and about one foot in width and breadth.

W. W. R.

7. *A Flora of North America: containing abridged descriptions of all the known indigenous and naturalized plants, growing north of Mexico; arranged according to the Natural System:* By JOHN TORREY and ASA GRAY. Vol. I, Pt. 1, pp. 184 Svo. G. & C. Carvill & Co. N. York, 1838.

Here is the first number, and the earnest of a work, which has been long and anxiously desired by the botanists of the United States; and which will, doubtless, be cordially greeted by the cultivators of botanical science, throughout the world. The plants of North America have

always been regarded with a lively interest. They have, at various times, attracted hither a number of botanists from the old world, who have reaped a rich harvest of discovery in our forests, on our mountains and prairies, and along the margins of our almost interminable rivers. A few of our own countrymen have also rendered important aid in making known the character and extent of our vegetable treasures. Their labors, however, have been, for the most part, restricted to the production of *partial* or *local Floras*, highly interesting, indeed, so far as they extended, and furnishing valuable materials for a more comprehensive work; but still, they were severally limited in their scope, and, of necessity, incomplete in their contents. The materials thus existing in detached masses, and scattered through numerous volumes, awaited the plastic operation of some master hand, to reduce them into one consistent body, and give to all the parts their appropriate "form and pressure." It was exceedingly important, that whoever might undertake to prepare a North American Flora, should be thoroughly acquainted with the labors of preceding botanists; and, by consulting their collections, as far as practicable, be competent to detect their errors, adjust their discrepancies, and determine their various synonyms. We consider it, therefore, a subject of felicitation, that the work has fallen into the present hands, as being confessedly those among the best qualified for the task, in our country; and we rely with confidence upon their receiving the zealous cooperation and encouragement of every lover of the Science of Plants. We cannot for a moment doubt, that every American botanist will eagerly avail himself of the occasion to possess a complete Flora of our widely extended continent; and we should fondly hope, that every liberal cultivator of science in our land, would be happy in the opportunity to patronize so commendable an effort to enhance the national reputation.

The authors of this Flora have, of course, adopted the *natural system*, as being the only one consistent with a truly scientific arrangement of plants; and they have availed themselves of the latest discoveries, in order to exhibit the details according to the most approved method, in the present state of the science.

By issuing the work in *parts*, or numbers, some advantages will be secured, which would otherwise be unattainable. The *natural families* being complete, even in those detached numbers, the botanists in various parts of our country will have leisure to examine and verify the particulars of each, during the course of the publication; and thus may suggest, in due time for an *Appendix*, (which must ever accompany works on a progressive science,) such corrections, modifications, or additions, as their opportunities or discoveries shall enable them to make. In this way, much valuable aid may be furnished to the authors, and the Flora rendered more perfect and comprehensive, without occasioning any material delay in its final completion.

The characters of the orders, tribes and genera, are well defined; and the specific descriptions, though abridged, are sufficiently full to be clear and satisfactory. They are, moreover, frequently accompanied with notes and detailed remarks, (especially the less known, or newly discovered species,) which seem to supply all the information that can reasonably be desired, in the Flora of so extensive a region.

The additions derived from the recent discoveries of Mr. NUTTALL, during his journey to the western coast of this continent, are highly important; and are here published, for the first time, from the original manuscript, furnished by that distinguished and indefatigable naturalist.

It appears, by a notice affixed to the number just published, that the work will be issued in nine parts, three parts to make a volume, and the whole forming three closely printed octavos, of about 550 pages each. The succeeding numbers will appear with as much dispatch as is consistent with their faithful execution.

Such being the character and plan of the forthcoming *Flora of North America*, we conclude our brief and hasty notice with a reiterated expression of the hope, that the worthy and accomplished authors may be adequately encouraged to persevere in their most laudable undertaking, and thereby be enabled to bring it to a successful and speedy completion.

August 16, 1838.

W. D.

8. *Redfield's Law of Storms*:—*Notice of Col. Reid's Work on Hurricanes*.—It is well known to the readers of this Journal, that our valued friend and correspondent, Mr. William C. Redfield, now of New York, has for a long course of years zealously prosecuted the study of various topics of Meteorology, and especially that of the phenomena of the storms of the Atlantic coast. To the latter subject his attention was directed as early as 1821, by the memorable hurricane which passed over our State with destructive violence, in September of that year. An investigation of its phases at different places, brought him to the highly interesting conclusion, that this storm was a progressive whirlwind, whose path could be traced from the West Indies to the Province of New Brunswick. In order to determine if the other storms were of this character, Mr. R. pursued the very judicious method of "mapping out on a chart, all the facts in relation to the storm, which he could collect, in their true time and location," (see this Journal for July, 1835,) and his labors were rewarded with the very important discovery, that *the violent storms of the Northern hemisphere are whirlwinds on a grand scale, each revolving or gyrating from right to left, originating within the tropics, advancing Westerly at first, in a line curving to the North, turning near the latitude of 30° N. and thence pursuing a Northeasterly course*. This view of the matter, although often advanced previously by Mr. R. among his acquaintances, (as many of us can testify,) was not made public until 1831, when it ap-

peared in a paper received in 1830, and published in the 20th Vol. of this Journal.

The numerous investigations of the phenomena of hurricanes, as observed at different points of their path, which Mr. R. has since made, have only added new confirmation of his early opinions. Several of his papers, embracing some of the results of these labors, have at various times appeared in this Journal, and in other periodical works. That which was published in 1835, was accompanied with a chart, showing the tracks of eleven different gales or storms. His explanation of the barometric indications observed during the access, progress, and departure of these storms, appears to us original, ingenious, and true; and his directions to navigators, concerning the measures which they should adopt, to extricate themselves from their destructive grasp, are surely of the highest practical importance. In an article published in this Journal in 1833, Mr. R. announced the conclusion, from data which he had collected, that the storms of the Southern hemisphere pursue a counter direction, and gyrate in the contrary way from those of the Northern: a difference which he considers due to their dependence on the earth's rotation.

These doctrines, (of which the foregoing is but an imperfect statement,) being so unlike those which had, for a long time held universal sway, were received by most, with great hesitation, and by some, with determined opposition. There were, however, those among us, who had watched the movements of the barometer, and the changes of the wind, during these storms, and were satisfied of the truth of the new system. Within a year or two, the attention of philosophers in foreign countries has been turned to this subject, and recent occurrences indicate that the laws of storms, which Mr. Redfield has unfolded, will soon be universally acknowledged. The preceding remarks are elicited by the perusal of an elaborate work, published the present year in London, by Lieut. Col. W. Reid, of the Royal Engineers, entitled "*An attempt to develop the Law of Storms, by means of facts arranged according to place and time, and hence to point out a cause for the variable winds, with the view to practical use in Navigation, illustrated by [9] charts and wood cuts,*" pp. 436, R. 8vo. The author states, that his attention was first drawn to the subject, by the Barbadoes hurricane of August, 1831, when he was induced to search every where, in the hope of learning the causes and mode of action of these storms. "The first paper," says Col. R. "I met with, which appeared to convey any just opinion on the nature of hurricanes, was one published in the American Journal of Science, by Mr. W. C. Redfield, of New York." Embracing with ready zeal, the views advanced in that paper, Col. Reid has prosecuted the study of his subject, with good judgment and praiseworthy industry. In the volume before us, he has presented the most convincing demonstration of the truth of Mr. Redfield's doctrines, and by the aid of numerous and excellent charts and diagrams,

he has set forth the subject with great clearness and beauty. His exhibition of the storms of the Southern hemisphere is full and satisfactory, and entirely accordant with Mr. R.'s published statements. As Americans, we can not but feel much gratified with the frankness with which he attributes to our countryman the credit of establishing the true system, on a subject of such interest and magnitude. The skill and research with which the work is executed, and the candor with which he ascribes honor where honor is due, are creditable alike to the head and heart of its author. The volume deserves attentive study; as the matters of which it treats, and the results which it presents, are not only interesting to the theoretical philosopher, but also of immense importance to all who expose their lives or their fortunes to the perils of the ocean.

9. *Observations on the genus Unio, together with descriptions of new genera and species in the families Naiades, Colimacea, Lymnæana, Melaniana, and Peristomiana, with numerous colored plates:* by ISAAC LEA, Member Amer. Philos. Soc. etc. Vol. II, quarto, pp. 152. Philadelphia—(constituting Trans. of Amer. Phil. Soc. Vol. VI, Part I.)

The present volume consists of several papers read before the American Philosophical Society, from Dec. 19, 1834, to July 21, 1837; and embracing descriptions of the following new species of shells, to the names of which we annex their *habitats* :

<i>Unio arctor</i> , Ohio river.	<i>Unio jejunus</i> , S. Car.
“ <i>solidus</i> , “	“ <i>pumilus</i> , N. Car.
“ <i>Rangianus</i> , “	“ <i>Roanokensis</i> , “
“ <i>graniferus</i> , Ohio.	“ <i>Hopetonensis</i> , Georgia.
“ <i>Dorfeuillianus</i> , “	“ <i>lugubris</i> , “
“ <i>coccineus</i> , “	“ <i>folliculatus</i> , “
“ <i>pulcher</i> , Tennessee.	“ <i>Lecontianus</i> , “
“ <i>obscurus</i> , “	“ <i>spinosus</i> , “
“ <i>interruptus</i> , “	“ <i>splendidus</i> , “
“ <i>Cumberlandicus</i> , “	“ <i>dolabraformis</i> , “
“ <i>simus</i> , “	“ <i>Jayensis</i> , Florida.
“ <i>notatus</i> , “	“ <i>Claibornensis</i> , Ala.
“ <i>Barnesianus</i> , “	“ <i>turgidus</i> , Louisiana.
“ <i>Zeiglerianus</i> , “	“ <i>Hydianus</i> , “
“ <i>creperus</i> , “	“ <i>Fisherianus</i> , Maryland.
“ <i>glaber</i> , “	“ <i>Novi-Eboraci</i> , New York.
“ <i>gibber</i> , “	“ <i>Tappanianus</i> , Penn.
“ <i>Vanuxemensis</i> , “	“ <i>Tampicoensis</i> , Mexico.
“ <i>Muhlfeldianus</i> , “	“ <i>carbonarius</i> , “
“ <i>Menkianus</i> , “	“ <i>pliciferus</i> , “
“ <i>venustus</i> , Potosi, Mo.	“ <i>Medellinus</i> , “
“ <i>Vaughanianus</i> , S. Car.	“ <i>Brownianus</i> , Amazon river.

- Unio Bengalensis*, Bengal.      *Unio discus*, India.  
 “ *lamellatus*, “      “ *contradens*, Unknown.  
*Margaritana Holstonia*, Tenn.      *Margaritana fabula*, Tenn.  
 “ *deltoidea*, “      “ *arcula*, Georgia.  
*Anodonta ovata*, Ohio.      *Anodonta Newtoniensis*, Penn.  
 “ *salmonia*, “      “ *subcylindracea*, N. York.  
 “ *Wardiana*, “      “ *cylindracea*, Mexico.  
 “ *Buchanensis*, “      “ *angulata*, W. of Rock. Mts.  
 “ *decora*, “      “ *Oregonensis*, “  
 “ *pavonia*, “      “ *Nuttalliana*, “  
 “ *Pepiniana*, “      “ *Wahlamatensis*, “  
 “ *gigantea*, Fort Gibson.      “ *exilis*, Unknown.  
*Iridina caelestis*, Africa.  
*Helix Mitchelliana*, Ohio.  
 “ *Wardiana*, “  
 “ *Vancouverensis*, W. Rocky Mts.  
 “ *Nuttalliana*, “  
 “ *Columbiana*, “  
 “ *Townsendiana*, “  
 “ *Oregonensis*, “  
 “ *Californiensis*, Upper California.  
 “ *Nickliniana*, “  
 “ *magnifica*, New Granada.  
*Carocolla Hydiana*, Porto Cabello, S. A.  
*Polygyra Dorfeuilliana*, Tenn.  
 “ *Troostiana*, “  
*Bulimus lacteus*, Colombia, S. A.  
 “ *Pealianus*, “  
 “ *Colombianus*, “  
 “ *corneus*, “  
 “ *glandiformis*, New Granada.  
 “ *parvus*, Carthagena, S. A.  
 “ *virgo*, “  
*Succinea aperta*, W. of Rocky Mts.  
*Megaspira\** *Ruschenbergiana*, Brazil.  
*Cyclostoma maculata*, Manilla.  
 “ *Popayana*, New Granada.  
*Planorbis lens*, Ohio.  
*Physa aurca*, Virginia.  
*Lymnea solida*, W. of the Rocky Mts.  
 “ *apicina*, “

\* A new genus allied to *Bulimus*, *Pupa*, and *Auricula*. The name alludes to *μεγας* magnus, and *σπειρα* spira.

- Melania inflata*, Virginia.  
 “ *plicata*, Bengal?  
 “ *plicifera*, W. of the Rocky Mts.  
 “ *Troostiana*, Tenn.  
 -*Paludina pallida*, Ohio.  
 “ *Nickliniana*, Virginia.  
 “ *sinistrosa*, East Indies.  
 “ *nuclea*, W. of the Rocky Mts.  
 “ *Nuttalliana*, “  
 “ *virens*, “  
*Ampullaria Pealiana*, Colombia, S. A.

The volume includes, likewise, a series of very interesting observations upon the anatomical structure of the *Naiades*, illustrated by plates; from which we perceive that Mr. LEA is convinced that these animals are not *androgynous*, as has heretofore been believed in Europe, but, on the contrary, have the sexes in different individuals. He notices, under these remarks, with suitable commendation, the ingenious memoir of Dr. KIRTLAND, of Ohio, on the same subject.\* The work is concluded by a very valuable synopsis of *Naiades*, in which the embarrassing synonymy of this family is cleared up with the author's usual address. It contains, according to this review, 323 recent species, as admitted, (*rank and file*,) 29 unknown to the author or doubtful, (*missing*,) and 22 fossil, (*dead*.) Of the subgenus *Unio*, there are 235 species in a recent state, and 20 which he has not been able to admit as certain. Of fossil species 21. Of the subgenus *Margaritana*, there are 20 admitted species and 2 unknown. Of the subgenus *Dipsas*, 2 recent species. Of *Anodonta*, 58 admitted, 7 unknown, and 1 fossil, which is doubtful. Of *Iridina*, 2 recent species: and of *Spatha*, 6 recent species. C. U. S.

10. *North American Herpetology; or a Description of the Reptiles inhabiting the United States*; by JOHN EDWARDS HOLBROOK, M. D., Professor of Anatomy in the Medical College of the State of South Carolina, Member of the Royal Medical Society of Edinburgh, &c. &c. Vol. I, quarto. Philad. 1836. pp. 120; and Vol. II. 1838. pp. 125. With colored engravings.

This is a second great work on natural history from the Philadelphia press, concerning which we have long owed a notice to the scientific public. Its merits are, however, of so high an order, as to stand in very little need of commendation, and the volumes before us give the best assurance that the remaining ones will be executed with equal ability. To distant subscribers, it may be of some consequence to be informed of the progress which Dr. HOLBROOK has made in his undertaking—a task, to

\* See this Journal, Vol. XXVI.



the undertaking of which, it is well known that he was encouraged by the late Baron CUVIER, an individual who well knew into what channels to direct the attention of his friends and pupils.

The author remarks in the preface of his first volume, "In no department of American Zoology is there so much confusion as in Herpetology. This is to be traced partly to the earlier naturalists, partly to the practice of describing from specimens preserved in alcohol, or from prepared skins. I have endeavored to avoid error in this respect, by describing, in every instance from the living animal, and often after a comparison of many individuals."

The first volume contains an extremely lucid essay on the organization of Reptiles, and descriptions of the following species: *Testudo Polyphemus*, *Emys hieroglyphica*, *E. megacephala*, *E. Troostii*, *E. Muhlenbergii*, *Ameiva sex-lineata*, *Anolis Carolinensis*, *Scincus lateralis*, *Bufo Americanus*, *B. clamosus*, *Engystoma Carolinense*, *Scaphiopus solitarius*, *Rana halecina*, *R. palustris*, *R. sylvatica*, *R. ornata*, *Hyla versicolor*, *H. squirella*, *Coluber flagelliformis*, *C. Alleghaniensis*, *C. quadrivittatus*, *C. erythrogrammus*, *C. abacurus*.

The second volume contains the following species: *Emys Oregonensis*, *E. terrapin*, *E. picta*, *E. guttata*, *E. serrata*, *E. rubriventris*, *E. reticulata*, *E. floridana*, *E. mobilensis*, *Salamandra dorsalis*, *S. symmetrica*, *S. gutto-lineata*, *Trigonocephalus piscivorus*, *T. contortrix*, *Crotalus miliarius*, *C. adamanteus*, *C. durissus*, *Elaps fulvus*, *Coluber erythrogaster*, *C. fasciatus*, *Heterodon platirhinos*, *Scincus erythrocephalus*, *Heterodon niger*, *Coluber guttatus*, *C. taxispilotus*, *C. punctatus*, *C. æstivus*, *C. elapsoides*.

We regret to learn that the first volume is nearly or quite out of print. It is to be hoped, however, that a second impression will soon be supplied. From the preface of the second volume we perceive, that drawings are ready for the third volume; which will probably be followed by two others before the subject will be exhausted.

11. *Second Part to SHEPARD'S Descriptive Mineralogy*, is now preparing for the press, and will shortly be published by *Wiley & Putnam*, of New York, and *Grigg & Elliot*, of Philadelphia. It is intended to embrace a view of the progress of the science since 1835, the year in which the first part of the work was printed.

12. *Blowpipe mouth for Oxygen and Hydrogen*.—In the late edition of Dr. Turner's Chemistry, much credit is given to Prof. Daniell, of London, for the invention of a new jet to the compound blowpipe, which is calculated greatly to increase the safety of that apparatus. Mr. Daniell has also given an engraving and description of the same, in the *Philosophical Magazine*, Vol. II, p. 57, 3d series. The jet, about 5 inches in length, is composed of two concentric tubes, each terminated by plati-

num; the gases pass through, one within the inner tube, and the other along the space between the two; so that no mixture or communication can take place until they arrive at the outlet. There is another advantage attending this arrangement, viz. that either of the gases can be made to surround the other, at pleasure; and any quantity of the gases can be employed, and large masses of platinum can be melted. This jet was contrived by Professor Webster, of Cambridge, Mass. in 1824, who sent a drawing and model of it to Mr. Newman, the well known maker of philosophical instruments, in London, by whom a jet was made and sent over, which Dr. W. has continued to use in his lectures and on all occasions, ever since, with perfect safety. A jet, on the same principle, was previously devised by Dr. W. and figured in his *Manual of Chemistry*, edit. 1 and 2. This was wholly of brass, and made by Dwelle, of Boston. An improvement was made by introducing one of the gases into the end of the central tube, instead of the side.

13. *Analysis of the Mineral Waters of Avon.* By Samuel Salisbury, Jr. M. D. 1838.—The sulphureous waters of Avon, Livingston County, N. Y. have long been known and were used even by the aborigines, in cutaneous disorders. Of late, they have been much frequented by the throng of valetudinarians, who resort to similar places for health and pleasure; and in many diseases they have proved to be of the most decided utility.

Dr. Salisbury, who is a resident physician at Avon, has devoted himself to studying the chemical constitution and medicinal qualities of these springs. He finds their temperature not above  $45^{\circ}$  to  $47^{\circ}$ , which is about the usual temperature of wells and springs in that climate. The chemical constitution of the "lower spring," as it is called, from its position, "is by weight in 8000 parts of water, hydro-sulphuric acid, 493; carbonic acid, 1.36; nitrogen and oxygen, .272; chlorine, .73; sulphuric acid, 10.116; carbonate of lime, 4.08; lime, 3.86; soda, .84; magnesia, 2.31; specific gravity, 10.018.

Arranged so as to form the compounds existing in this water, and calculated for 10,000 parts by weight, are—

Carbonate of lime,	- - - -	5.02
united to carbonic acid,	- - - -	<u>1.70</u> —6.72
Chloride of calcium,	- - - -	1.44
Sulphate of lime,	- - - -	9.83
“ magnesia,	- - - -	8.49
“ soda,	- - - -	<u>2.35</u>
		28.83

In a volume of 10,000 parts, are—

Hydro-sulphuric acid,	- - - -	434
Nitrogen,	- - - -	235
Oxygen,	- - - -	<u>25</u>
		694

*Note.*—The chlorine is assigned to calcium, as the chloride of calcium is oftener found in those waters which contain but little saline matter. There remains .006 sulphuric acid, apparently in excess, which is accounted for by the difficulty of separating, accurately, magnesia from the other earthy salts. The quantity of carbonate of lime considerably exceeds the equivalent quantity of carbonic acid, necessary to render it soluble in pure water, and this fact affords a probable explanation of the character this water exhibits, when tested by colored papers.”

The “upper spring” seems not to differ essentially from the lower. In sensible properties, it bears a close resemblance to it: but there is a peculiar sweetness of taste, which distinguishes it. The deposit around it is mostly of a dark blue color, while that of the lower spring is white. It rises about sixty rods east of the other, and is at an elevation considerably above it. The bed of sand, through which this water oozes, is about twenty feet, and the rock about thirty feet below the surface of the ground. One gallon from this spring, according to Prof. Hadley, of the institution of Fairfield, Herkimer County, New York, was found to contain the following substances, and nearly in the following proportions, viz.

Carbonic acid, - - - -	5.6	cubic inches.
Hydro-sulphuric acid, - - -	12.	“
Sulphate of lime, - - - -	84.	grains.
“ magnesia, - - - -	10.	“
“ soda, - - - -	16.	“
Carbonate of lime, - - - -	8.	“
Chloride of sodium, - - - -	18.4	“

And a small quantity of other matter.

There are other springs in the neighborhood, but their qualities are essentially the same as those quoted. The geology of the vicinity is said to be bituminous shale, upon transition limestone. Iodine and bromine have not yet been detected in the constitution of these waters; but it is probable that no very accurate examinations have been made, with a view to their discovery; although Dr. Francis observes, that an analysis of these waters, which he caused to be made in 1832, did not afford satisfactory evidence of their containing iodine.

14. *A Treatise on Gems, in reference to their practical and scientific value. A useful guide for the Jeweller, Lapidary, Artist, Amateur, Mineralogist, and Chemist; accompanied by a description of the most interesting American gems, and ornamental and architectural materials.* By Dr. Lewis Feuchtwanger. New York, 1838.—The title of this work embraces a very correct idea of its contents. Dr. Feuchtwanger has collected a great amount of information, drawn from many sources, in addition to his own experience, both in regard to the scientific character, commercial value, history, and antiquity, not only of the gems, properly so

called, but of all substances, natural or artificial, which it has pleased the fancy of mankind to esteem as objects of personal ornament, and which are usually known by the name of precious stones. He gives a minute account of the preparation of pastes, or imitations of real gems, of the method of cutting and polishing all gems, and of the forms most suitable to enhance their natural beauty. The history of the diamond, the prince of gems, and by many esteemed a better standard of value than silver or gold, is drawn with much care, and is particularly interesting, viewed either as a scientific or practical account.

This book, taken in connection with that of Prof. N. F. Moore, of Columbia College, viz. "Ancient Mineralogy, or an Inquiry concerning the Mineral substances mentioned by the Ancients, &c." and noticed in this Journal, (Vol. 28, p. 188,) affords a very complete view of the history and antiquity of those gems and minerals which were known in the early periods of society.

Dr. F. has endeavored to Americanize his book, by giving an account of all the principal American localities of precious stones, and ornamental and architectural materials; with the hope of calling more attention to our internal resources of this nature. At the conclusion of the present treatise, it is announced that Dr. F. is to publish a "MINERALOGICAL TEXT BOOK, for the use of schools, seminaries, and private students. This latter work is intended not to be strictly philosophical, as it is a plain text book for the younger student, who wishes to be informed of the elementary principles, and how to collect, and to classify the minerals coming under his observation."

15. *Extreme heat at Cumberland, Md., communicated by the Editor's request.* TO PROF. SILLIMAN—*Dear Sir:* In the afternoon of Saturday, the 28th of July, the thermometer in the piazza of Black's Hotel, in Cumberland, Md.,\* about two o'clock, was at  $102^{\circ}$  of Fahr.; it gradually rose to  $104^{\circ}$ ; from about 3 to 4 o'clock it fluctuated from  $102^{\circ}$  to  $106^{\circ}$ ,—and at about 4 o'clock it rose to  $107^{\circ}$ , and then to  $108^{\circ}$ , where it remained at 5 o'clock. One of the gentlemen then removed it from its position against one of the pillars of the piazza in the shade, to one in the direct rays of the sun,—it almost immediately rose to  $120^{\circ}$ , the highest graduation of the tube, filled it entirely, and the ball was soon after burst. At Hancock, about 30 miles below, on the Potomac, at the same hour, the thermometer varied from  $107^{\circ}$  to  $109^{\circ}$ . You are yourself familiar with the position at Black's; it looks, I think, nearly north.

With great respect, your friend and servant,

B. B. HOWELL.

New York; Aug. 4, 1838.

---

\* Lat.  $38^{\circ} 58'$  N. Long.  $77^{\circ} 33'$  W.

16. *Evidences of diluvial currents—petrifications—metallic models of shells.* To Prof. SILLIMAN & SON: Gent.,—Herewith I send you specimens of the surface rock in this vicinity. The large slab, containing chert, was taken from the village of Black Rock, about four miles north of this city. The grooves at this locality, as determined by Mr. Haskins and myself, range, allowing for variation, N. 28° 12' E.

You will perceive, that wherever a nodule of chert projects above the surface, a ridge of the softer limestone has been protected, in some measure, from friction, which invariably, at this locality, as well as at the Black Rock quarry, one and a half miles distant, point in a southerly direction. Some parts of the surface rock, where this slab was procured, present this phenomenon much more perfectly; the nodules of chert often having a semi-circular depression worn into the rock on their northern sides, opposite to the projecting ridge. I regret that such a specimen could not be procured, as the strata on which they occur are from one foot to one and a half feet in thickness.

Can proof be more conclusive, that these marks and scratches were produced by gravel stones and boulders, swept over the surface of the rocks by currents, tides, or waves, which flowed from the north?

I also send a smaller slab, somewhat polished. It was procured about half a mile further north, but as no marks appear on the surface, we could not determine precisely the course from which the water flowed.

At Black Rock quarry, where a large surface has been uncovered for the purpose of procuring materials to construct the breakwater, outside of Buffalo harbor, the grooves range N. 15° 32' E. The friction there has been equally powerful; but as the rock consists almost entirely of chert, the ridges pointing towards the south are less prominent.

I also put into the box a piece of weathered chert, from which the carbonate of lime has been decomposed. The workmen here sometimes call this "chawed stone." I add also some madreporites, and metallic casts of two species of terebratulites, of which I have been able to procure but single specimens.

Hoping that the box and its contents will prove acceptable, I remain, yours truly, &c.

GEO. E. HAYES.

The box was highly acceptable, especially as the proofs of powerful and lasting diluvial action are decisive on the slab of limestone, as well as on the pieces which we have recently seen at Buffalo, in the possession of Mr. Haskins and Dr. Hayes.—EDITORS.

17. *The American Almanac, and Repository of Useful Knowledge,* for the year 1839. Boston, Chas. Bowen. Vol. 10.—This valuable work, for the ensuing year, has been forwarded to us by its Editor, Mr. J. E. Worcester. To it is appended a general index of the last ten volumes,

which will render the valuable statistical information contained in them, very available. The astronomical department is still under the conduct of Mr. Paine, and is, as usual, able and accurate.

18. *Green Feldspar and Galena.*—The green feldspar of Beverly, mentioned in our last, was discovered by Prof. Webster, not by Dr. Cornelius, as stated, together with zircon, and described in the Boston Jour. of Philos. Vol. 1st. A vein of Galena has just been discovered at Dédham, Mass.

19. *Fossil Fishes in the red sandstone of New Jersey.*—Professor Gale, of the New York University, has found fossil fishes in the sandstone of New Jersey, near its western margin in Morris County. The existence of these fossils seems to have been long known to persons residing in the vicinity. The principal specimen obtained by Prof. Gale, appears to be a species of the *Palæoniscus*, of Agassiz, and is probably identical with one of the *Palæonisci*, found at Middletown, in the state of Connecticut.

20. *United States South Sea Surveying and Exploring Expedition.*—The squadron entrusted with the execution of this important national enterprise, sailed from Hampton Roads, Norfolk, Va. on the evening of Saturday, August 18, 1838. The results of this noble undertaking will, we doubt not, prove of the greatest value to the cause of science and to the nautical and commercial interests of the nation, and highly creditable both to the members of the expedition, and to the government which sends it forth. The officers of the various vessels, and the members of the scientific corps which accompanies them, are gentlemen of ample qualifications for the arduous and honorable duties assigned to them; and the auspices under which the expedition is finally dispatched, are highly propitious. The enterprise has excited a deep interest in the mind of the nation, and all embarked in it depart with the kindest wishes of their countrymen, for their prosperity, and for their safe return, in due time, to their kindred and their homes.

We annex an account of the vessels constituting the squadron, with a list of the officers and of the gentlemen of the scientific corps.

The *Vincennes*, is a first-class sloop of war, of 650 tons, commanded by *Charles Wilkes, Esq. Commander in Chief of the Expedition.* A light spar deck has been put on this ship, which gives her the appearance and some of the conveniences of a small frigate. Her battery is reduced to 8 guns, and she carries about 150 men. The *Peacock*, commanded by *William L. Hudson, Esq.* is a second-class sloop of war, of 600 tons, and of the same construction. She carries 130 men and 8 guns. The store-ship *Relief*, commanded by *A. K. Long, Esq.* is of 450 tons burthen,

and carries 75 men and 6 guns. The brig *Porpoise*, commanded by Lieut. *Cadwallader Ringgold*, is of 200 tons burthen, and carries 65 men and 4 guns. The schooner *Sea Gull*, commanded by passed midshipman *J. W. E. Reid*, is of 110 tons, and carries 15 men. The schooner *Flying Fish*, commanded by passed midshipman *Samuel R. Knox*, is of 90 tons, and carries 12 men.

The following is a list of the officers, &c.

VINCENNES.—Charles Wilkes, Esq. Commander in Chief; Thomas T. Craven, 1st Lieutenant; Overton Carr, Flag do.; Robert E. Johnson, 2d do.; James Alden, 3d do.; William Lewis Maury, 4th do.; James H. North, Master; Edward Gilchrist, Fleet Surgeon; R. R. Waldron, Purser and Special Agent; J. L. Elliot, Chaplain; John L. Fox, and John T. Whittier, Assistant Surgeons; George M. Totten, William Reynolds, William May, and Joseph P. Sanford, Passed Midshipmen; George W. Clark, Midshipman; Samuel Elliott, Acting Midshipman; William Smith, Boatswain; W. G. Bright, Gunner; William M. Loughton, Carpenter; S. V. Hawkins, Sail Maker; Benjamin Vanderford, Pilot; R. P. Robinson, Purser's Clerk.

*Scientific Corps*.—Charles Pickering and J. P. Couthouy, Naturalists; Joseph Drayton, Artist; J. Brackenridge, Assistant Botanist; J. G. Brown, Repairer of Instruments.

PEACOCK.—William L. Hudson, Commanding; Samuel P. Lee, 1st Lieut.; William M. Walker, 2d do.; Geo. F. Emmons, 3d do.; Oliver H. Perry, 4th do.; Thomas A. Budd, Master; J. Frederick Sickels, Surgeon; William Speiden, Purser; Silas Holmes, Assistant Surgeon; James B. Lewis, Passed Midshipman; Hunn Gansevoort, do.; Henry Eld, Jr. do.; George W. Harrison, do.; Wilkes Henry, Midshipman; Wm. H. Hudson, do.; Thomas G. Bell, Acting Boatswain; John D. Anderson, Acting Gunner; James Dibble, Acting Carpenter; — Freeman, Sail Maker; William H. Insley, Purser's Clerk.

*Scientific Corps*.—James D. Dana, Mineralogist and Geologist; Titian R. Peale, Naturalist; Horatio E. Hale, Philologist; Francis L. Davenport, Interpreter.

RELIEF.—A. K. Long, Commanding; Robert F. Pinckney, Lieut.; A. L. Case, do.; Joseph H. Underwood, do.; James C. Palmer, Acting Surgeon; George T. Sinclair, Acting Master; Alonzo B. Davis, Passed Midshipman; Thomas W. Cummings, do.; James L. Blair, Midshipman; James B. Harrison, Captain's Clerk.

*Scientific Corps*.—William Rich, Botanist; Alfred T. Agate, Artist.

PORPOISE.—Cadwallader Ringgold, Commanding; M. G. L. Claiborne, 1st Lieut.; H. J. Hartsein, 2d do.; John B. Dale, 3d do.; Charles T. B. Guillon, Assistant Surgeon; Augustus S. Baldwin, Acting Master; Simon F. Blunt, Passed Midshipman; George Colvocoressis, do.; T. W. Waldron, Clerk; Oliver Nelson, Acting Boatswain; Amos

Chick, Acting Carpenter ; John Jones, Acting Sail Maker ; William H. Morse, Purser's Clerk.

SCHOONER FLYING FISH.—Samuel R. Knox, Passed Midshipman ; George W. Hammersley, do. ; Richard Ellis, Acting Master's Mate.

SCHOONER SEA GULL.—James W. E. Reid, Passed Midshipman ; F. A. Bacon, Passed Midshipman ; Isaac Percival, Pilot.

21. *Annals of Natural History, or Magazine of Zoology, Botany, and Geology.* Conducted by Sir William Jardine, Bart., P. J. Selby, Esq., Dr. Johnston, Sir W. J. Hooker, Regius Prof. of Botany, Glasgow, and Richard Taylor, F. L. S.—In Vol. 32 of this Journal we noticed, among other new Journals, the Magazine of Zoology, Botany, and Geology, conducted by the three first names in the above list ; and our readers have since then been often reminded of it, by our frequent quotations from its pages. The companion to the Botanical Magazine has also become somewhat familiar to us, on this side the Atlantic, while the name of its conductor is here, as in the whole scientific world, inseparably associated with modern botanical science. It was with regret that we learnt, that neither of these valuable Journals could be sustained singly, from the want of sufficient encouragement to meet the expenses of publication. It is, therefore, we presume, with a view to mutual support, as well as concentration of talent and effort, that their editors have seen fit to unite them under a new name, and to alter the time of publication from six to twelve times a year. They have, likewise, associated with themselves Richard Taylor, Esq. under secretary of the Linnæan Society. We have not yet seen this new form of our former acquaintances, but there can be no doubt that it will sustain the same high position in its own departments, as each of the Journals of which it is composed did, previous to their union ; and it would seem strange if it should not rise above it.

Presuming that our readers would be glad of early information on this point, we copy the contents of the first number, which was issued in March, from an advertisement which has reached us before the work itself. The price is 2s. 6d. per number.

*Contents.*—I. On a new Oscillatoria, the coloring substance of Glaslough Lake, Ireland. By JAMES L. DRUMMOND, M. D.—II. On the germination of *Limnanthemum lacunosum*. By Dr. GRISEBACH.—III. Contributions to the Natural History of Ireland. By WILLIAM THOMPSON, Esq.—IV. On some new species of *Quadrupeds*, and *Shells*. By J. E. GRAY, Esq.—V. On the Echinodermata. By L'AGASSIZ.—VI. On the Scottish Mollusca Nudibranchia. By GEORGE JOHNSTON, M. D.—VII. Letters from Botanical Travellers: Mr. Cuming, Manilla ; Dr. Schomburgh, Berbice ; Gardner, Brazil.—*Bibliographical notices* :—Agassiz, Poissons d'Eau douce d'Europe ; Plantes Cryptogames de France, par H. J. Desmazières ; Das System der Pilze von L. Nees von Esen-



beck und A. Henry.—*Societies* :—Proceedings of the Linnæan Society ; Royal Society of Edinburgh ; Entomological Society ; Botanical Society ; Zoological Society.—*Miscellaneous*.

22. *Analysis of Gmelinite or Hydrolite* ; by A. CONNELL, Esq., F. R. S. E., &c. (Jameson's Journal, No. 48, p. 360.)—Mr. Connell finds that 17.67 grs. of this mineral from the County of Antrim, in Ireland, are composed exclusive of water of

Silica,	-	-	-	-	8.581
Alumina,	-	-	-	-	3.19
Lime,	-	-	-	-	1.084
Soda,	-	-	-	-	.682
Potash,	-	-	-	-	.069
Oxide of iron,	-	-	-	-	.02
					13.626

To determine the quantity of water, a portion of the crystals was ignited in a platinum crucible, and charcoal fire, when the loss of weight amounted to 21.66 per cent. We have thus, in 100 parts of the mineral,

Oxygen contained.					
Silica,	-	-	48.56		
Alumina,	-	-	18.05	8.430	3
Lime,	-	-	6.13	1.721	} 1
Soda,	-	-	3.85	.984	
Potash,	-	-	.39	.066	
Oxide of iron,	-	-	.11		
Water,	-	-	21.66	19.253	7
					98.75

It sufficiently appears, both from the analysis of Vauquelin\* and from that here detailed, that this mineral is nearly allied to chabasite, in a chemical point of view, as according to Mr. Haidinger,† it is crystallographically ; and it is not impossible that if analysis applicable to different localities were repeated and sufficiently extended, the chemical formula for chabasite might be found to embrace gmelinite. It does not, however, apply to the above analysis, and still less to those of Vauquelin.

\* Edinb. Jour. Science, II, 262.

		Montecchio Maggiore.	Castel.
Silica,	-	50.00	50.00
Alumina,	-	20.00	20.00
Lime,	-	4.50	4.25
Soda,	-	4.50	4.25
Water,	-	21.00	21.00
		100.00	98.50

† Mohs's Mineralogy, fig. 195.

The formula indicated by the above result is,  $(\text{CNK})\text{S}^3 + 3\text{Al S}^2 + 7\text{Aq}$ ; and it may be noticed, that while this formula indicates one atom of silica and one atom of water, *more* than that for chabasite, the formula which analysis of levyne, a mineral also nearly allied to chabasite in a chemical view, suggested, shewed one atom of silica and one atom of water, *less* than in chabasite;\* and that in gmelinite, bisilicate of alumina is associated with tersilicate of lime and alkalis; in chabasite with bisilicate; and in levyne with silicate of these bases, as appears from the formulæ :

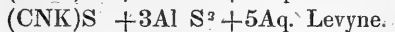
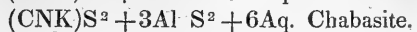
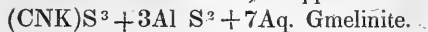

Mr. Connell continues to remark, I have much less expectation that the chabasite formula will ever be found to embrace levyne, because the proportion of silica and that of alumina, actually found in the latter mineral, differs in a marked manner, and in opposite directions from those in chabasite; while in gmelinite, the difference is much less considerable, although still excluding the chabasite formula.

23. Prof. OWEN on the *Fossil Animals collected by Mr. CHARLES DARWIN*, (from the Zoology of the voyage of H. M. S. Beagle during the years 1832 to 1836. Part first. Fossil Mammalia.)—"It is remarkable that all the fossils collected by Mr. Darwin belong to herbivorous species of mammalia, generally of a large size. The greater part are referable to the order which Cuvier has called Edentata, and belong to that subdivision of the order (*Dasypodidæ*) which is characterized by having perfect and sometimes complex molar teeth, and an external osseous and tessulated coat of mail. The megatherium is the giant of this tribe, which at the present day is exclusively represented by South American species, the largest (*Dasypus Gigas*, Cuv.) not exceeding the size of a hog. The hiatus between the living species and the megatherium is filled up by a series of armadillo-like animals, indicated more or less satisfactorily by Mr. Darwin's fossils, some of which species were as large as an ox, others about the size of the American Tapir. The rest of the collection belongs, with the exception of some small Rodents, to the extensive and heterogeneous order Pachydermata; it includes the remains of a mastodon, of a horse, and of two large and singular aberrant forms, one of which connects the Pachydermatous with the Ruminant order; the other, with which the descriptions in the following pages commence, manifests a close affinity to the Rodent order."

The first fossil animal mentioned by Professor Owen is named *Toxodon Platensis*, which he describes as a gigantic extinct mammiferous animal, referable to the order Pachydermata, but with affinities to the

\* Lond. and Edinb. Phil. Jour., V, 40.

Rodentia, Edentata, and herbivorous Cetacea. From the dimensions of the cranium, it would appear that the *Toxodon Platensis* must have been as large as the colossal megatherium. The next extinct fossil animal described is named *Macrauchenia Patagonica*, which is a mammiferous quadruped, referable to the order Pachydermata, but with affinities to the Ruminantia, and especially to the Camelidæ. This is a very beautiful piece of investigation, and proves the singular address and skill of our author,—for, furnished only with a few bones of the trunk and extremities, without a fragment of tooth or of cranium, to serve as a guide to the animal's position in the zoological scale, he has been able to refer it to its place in the system.—*Edinb. New Phil. Jour. for April, 1838.*

24. *Presentation of the Wollaston Medal.*—The Wollaston Medal for the last year has been presented to *Prof. Richard Owen* by the Geological Society of London, on which occasion the President, Mr. Whewell, expressed himself in the following terms :

“Mr. Owen,—I have peculiar pleasure in presenting you with this medal, awarded to you by this Society, for your services to fossil zoology in general, and in particular for the description of the fossil mammalia collected by Mr. Darwin. I trust it will be a satisfaction to you to receive this our testimony of the success with which you have cultivated that great science of comparative zoology, to which you have devoted your powers. I trust it will add to your satisfaction, to consider, that the subject which we more peculiarly wish to mark on this occasion,—the study of fossil zoology, is one to which the resources of your science were applied, while the subject was yet new, by that great man, John Hunter, whose museum and whose reputation are so worthily assigned to your care. I trust also that this medal, thus awarded to you, at the outset, if I may so say, of an enlarged series of investigations, will convey to you the assurance, that in your progress in such researches, you carry with you our strong interest in your endeavors, and our high esteem of your powers and your objects; and will convince you, that in all your successes, you may reckon upon our most cordial sympathy in the pleasure which your discoveries give.”—*Ed. New Phil. Jour. April, 1838.*

25. *On the Rapidity of Motion in Railway Cars which is consistent with safety.*—*Mr. Sang*, F. R. S. E. &c. &c. of Edinburgh, in a late number of Jameson's Journal gives as the results of his observations on the Liverpool and Manchester Railway, that a speed much greater than the present twenty five miles per hour, may be used with safety. The question is, whether with a velocity of three or four times the usual rates, the engineer can preserve perfect command of the powerful locomotives required. Mr. Sang remarks, that “with the velocity of twenty five miles an hour, even when exposed to the current of air, there was not

the slightest approach to any feeling that would lead me to suppose that four or five times the velocity would disable the engineer from directing and managing the train. Such was the result of my own observations, and it was fully borne out by the experience of the men. I may cite two instances of common occurrence. When the train arrives at the foot of one of the inclines, the banking engine follows to assist it up. Now one would be apt to imagine, that for the purpose of attaching the new engine, the train would stop, or that if it did not, there would be a concussion when the banking engine comes in contact. So completely however are these powerful engines under the control of their directors, and so well are they managed, that a passenger in the train who is not aware of what is going on from ocular perception, is altogether unconscious of any change. I frequently watched this operation, but on no occasion could I perceive the slightest shock, even when situated only one or two carriages from the end of the train.

“On one occasion the banking engine had got before us on the incline ; as the hooking of it on in such a situation was a much severer test of the skill with which matters are managed, I attended closely to the operation ; we were going fully twenty five miles an hour. The banking engine gradually slackened its rate and allowed the train to gain upon it, until it could be hooked on,—that done, more steam was given and we proceeded with its assistance, yet not the slightest shock was felt in the train. These facts are sufficient to show, that much greater rapidity is practicable so far as the power of managing the apparatus is concerned. As to velocity itself, I made some observations. Twenty five miles an hour is not so very rapid ; over and again I saw bees not merely keep pace with us but fly round and across the coach, and that not by help of any current of air which might be supposed generated, but at several feet distance from the train. At times two specimens of the *Libellula grandis* kept up with us over half a mile ; while the smaller birds, such as the linnet, were unable to cope with the steam. One I almost caught, which while flying with all its might, remained opposite to the window for a few seconds. If a rail road be regarded only as a means of communication between two distant towns, I should have no hesitation in saying that a rate even of one hundred miles per hour could be maintained with perfect safety to the passengers ; but it is different if passengers have to be let out at stations along the line, for then the trouble and expense of stopping the trains comes to be considered. An average of about three minutes is consumed by each stop, including the slackening and regaining of speed before and after stops.”

26. *On the Gases contained in the Blood, and on Respiration*; by M. G. MAGNUS.—M. Magnus remarks that it remains a question whether carbonic acid is formed in the lungs by the oxidizement of a part of the

carbon in the blood by the action of the air, or whether venous blood, when it reaches the organs of respiration, contains carbonic acid ready formed, which is merely separated from it.

M. Magnus passed hydrogen gas through a solution of potash to deprive the gas of any carbonic acid which it might contain, and when it gave no precipitate with lime water he passed it into the blood of a healthy man; the gas afterwards made to go through lime water gave a plentiful precipitate of carbonate of lime. Azotic gas similarly employed produced a like effect; and M. Magnus concludes, from these experiments, that carbonic acid exists ready formed in the blood, and consequently that it is not formed in the lungs. Carbonic acid was also separated from blood by means of the air-pump.

By using Liebig's apparatus M. Magnus found that blood contained about one fifth of its volume of carbonic acid gas, and when it had been kept twenty four hours, without emitting any bad smell, the quantity was larger. The results were confirmed by employing atmospheric air instead of hydrogen gas.

M. Magnus then ascertained the nature and proportions of all the gaseous contents of the blood. He found that one hundred volumes of the arterial blood of a horse yielded

Carbonic acid gas,	-	-	-	4.32 vols.
Oxygen,	-	-	-	1.52 "
Azote,	-	-	-	2. "
Total,				7.84 vols.

The venous blood of the same horse, drawn four days afterwards, gave

Carbonic acid gas,	-	-	-	4.29 vols.
Oxygen,	-	-	-	1.12 "
Azote,	-	-	-	.54 "
Total,				5.95 vols.

The arterial blood of the calf contains more, and the venous blood less oxygen, than that of the horse.

M. Magnus observes, that these experiments, and others which we have not copied, appear to show that the gases contained in the blood of the animals, amount to about one eighth or one tenth of the quantity employed. He admits however that the experiments are not absolutely precise, because they were not all continued the same length of time, &c. But he observes, that as the proportions between the oxygen and carbonic acid are invariably the same, these results may be regarded as satisfactory.

With regard to the theory of respiration, all experimentalists agree as to the reciprocal proportions between the carbonic acid expired and of the oxygen absorbed; while however some of them are of opinion that those quantities are always equal, as must happen if the oxygen gas were

employed merely in the formation of carbonic acid in the lungs, there are chemists whose results show that more oxygen is inspired than carbonic acid expired. Messrs. Allen and Pepys observed that this was constantly the case when the same air was repeatedly respired.

M. Magnus adds, that this fact, so inexplicable by other theories, is an immediate consequence of the hypothesis founded on the law, that a liquid holding a gas in solution parts with it when it comes in contact with another gas.

Another circumstance noticed by Messrs. Allen and Pepys is as inexplicable as the preceding, namely, that by the respiration of oxygen, or by a mixture of oxygen and hydrogen, azotic gas is constantly expired, the volume of which is proportional to the bulk of the animal; this proves that it cannot at all be attributed to the air.

It now remains to be shown that the carbonic acid extracted from the blood is in sufficient quantity to account for the whole of that which the lungs expire. The results obtained on this subject are discordant; those of Messrs. Allen and Pepys evidently exceed what they should be; for Berzelius has shown, that if correct, it would require six pounds and a quarter of solid nourishment in twenty four hours to produce the quantity of carbon consumed.

Taking, then the results obtained by Davy as a mean of those of Lavoisier, Allen and Pepys, although perhaps a little too high, we shall have thirteen cubic inches as the quantity of carbonic acid gas expired by a man. If it be further admitted, that at each pulsation of the heart an ounce of blood arrives at the lungs, seventy five pulsations in a minute would convey five pounds of blood in the same time. This is the minimum quantity which can be admitted; for it is very probable that five pounds of blood pass through these organs every minute: these five pounds produce thirteen cubic inches. It has been already mentioned that the blood contains at least one fifth of its volume of carbonic acid; and as a pound is equal to twenty five cubic inches, each pound of blood would contain at least five cubic inches of carbonic acid. It will be observed that no circumstance opposes the proposed theory, hence the experiments prove, that the quantity of carbonic acid contained in venous blood, is more than sufficient to furnish the quantity expired.—*Journal de Chimie Médicale, Nov. 1837.—Lond. and Ed. Phil. Mag. March, 1838.*

27. *Eighth Meeting of the British Association for the Advancement of Science.*—The eighth meeting of this Institution was held at Newcastle during the week from August 20 to August 26, 1838, Sir John F. W. Herschel presiding. The number of members was larger than at any former meeting. The Report of the doings of this meeting occupies 200 columns of the London Athenæum, and contains a large amount of scientific information, some of which we intend to transfer to the pages of our next number.

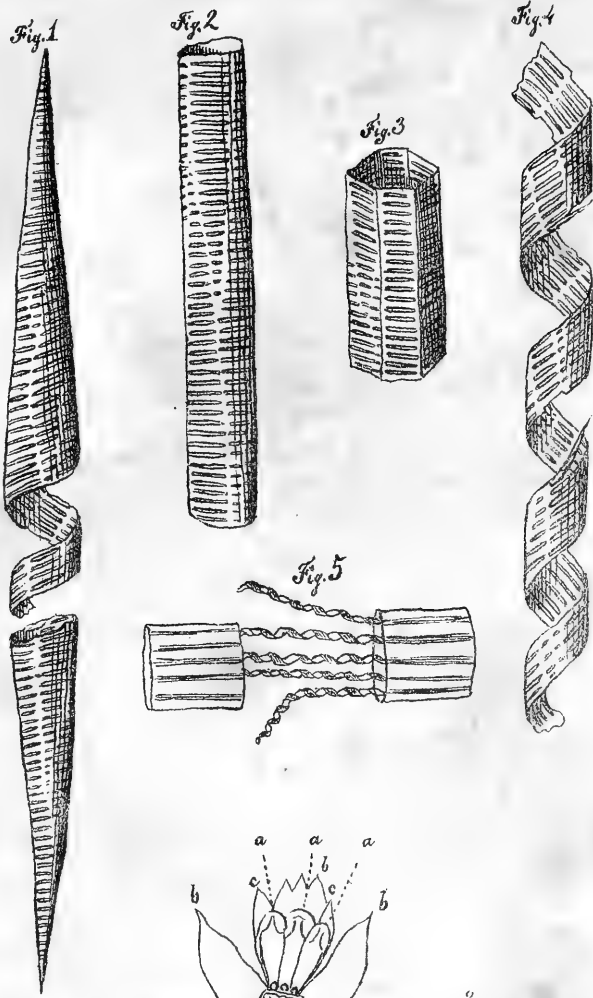

Fig. 1. Conical terminations of ducts in Ferns  
 Fig. 2. Cylindrical duct  
 Fig. 3. Prismatic duct  
 Fig. 4. Duct torn between the bars and uncoiled  
 Fig. 5. Two portions of the bundle of vessels, connected by torn ducts.

Fig. 6. Anconstrous flower of *Orchis spectabilis*  
 a. a. a. Three perfect anthers  
 b. b. b. Sepals  
 c. c. d. Petals and Lip  
 e. Spur  
 f. Corium

From nature and on stone by J. W. Bailey





Fossil Infusoria &c. found at West Point, N.Y.

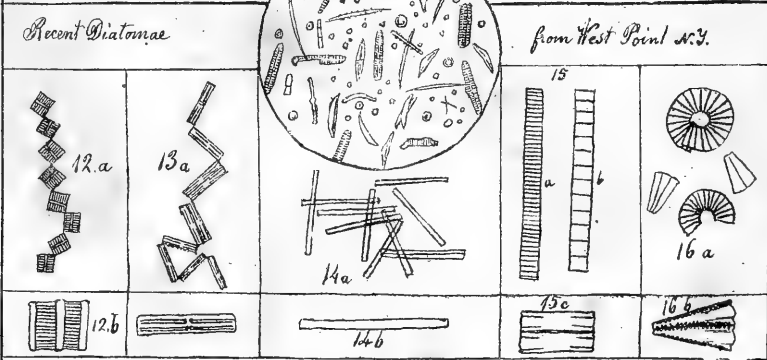
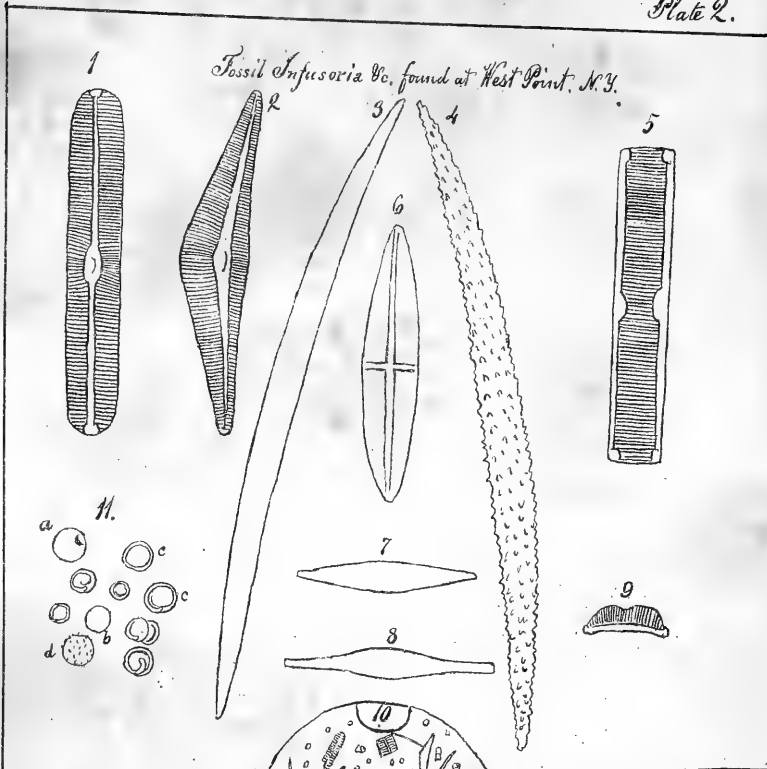

Recent Diatomae from West Point N.Y.

Fig. 1, 2, 5, 6, 7, 8, 9 Siliceous shells of Infusoria found in Peat earth at West Point;  
 Fig. 3, Smooth round siliceous body,  
 Fig. 4, Rough " siliceous body,  
 Fig. 10 Appearance presented by a portion of the Peat earth diffused in water and magnified moderately,  
 Fig. 11 Spheres, (a) Disks, (b) Rings (c) &c, found very abundant in the peat earth,  
 From nature and on stone by J. W. Bailey.

Explanation of the figures  
 Fig. 12, *Diatoma flocculosum*  
 Fig. 13, *Diatoma torus*?  
 Fig. 14, *Diatoma crystallinum*?  
 Fig. 15 *Fragillaria pectinalis*  
 Fig. 16 *Meridion vernale*?

The figures marked (b) are sketches of single articulations greatly magnified,



THE  
AMERICAN  
JOURNAL OF SCIENCE, &c.

---

ART. I.—*On the Courses of Hurricanes; with notices of the Tyfoons of the China Sea, and other Storms*; by W. C. REDFIELD, Memb. of Conn. Acad. of Arts and Sciences, Corr. Memb. of U. S. Naval Lyceum, the Albany Institute, &c.

[Written for the London Nautical Magazine.]

IN a communication published in the Nautical Magazine for April, 1836, I attempted to correct some errors which had obtained currency in nautical books, relating to the supposed erratic character and progress of the hurricanes of the Atlantic. These corrections were accompanied by a summary statement of the results which my inquiries on this subject had appeared to establish. These results were first published in 1831, but have been further generalized and supported in subsequent papers. Their striking uniformity has been considered as indicating the operation of a general law, controlling the action and progress of these violent storms. The incipient essay now referred to, was illustrated by a chart containing delineations of the routes of two of these storms.\* To my communication in the Nautical Magazine was likewise appended a chart, on which were delineated the routes and daily progress of some ten or twelve of these gales,

---

\* Silliman's Journal for April, 1831, Vol. XX, p. 17—51. See also Vol. XXI, p. 191—193; Blunt's Am. Coast Pilot, 12th edition, July, 1833, p. 626—629; Silliman's Journal, Vol. XXV, p. 114—135; Vol. XXVIII, p. 310—318; XXXI, p. 115—130; XXXIII, p. 50—65 & 261—265; Jour. Franklin Inst. Vol. XIX, Feb. 1837, p. 112—127; Am. Coast Pilot 13th edit.; Jameson's Edinb. Jour. Feb.—April; 1838.

The writer had never contemplated the publication of any of the observations which he had incidentally been led to make upon storms, till within a few weeks of the time when the earliest of the above papers was sent to the press; when he was induced by the suggestions of his friend Prof. Olmsted, to attempt a

which had been remarkable for their violence, and which were selected as illustrations of the general course and whirlwind character of many other storms, relating to which similar information had been obtained.

The favorable attention with which these statements have generally been received, together with the spirit and professional zeal with which the subject has been discussed in the pages of the Nautical Magazine, have seemed to invite a more detailed exhibition of the numerous facts which have claimed attention in the progress of my inquiries. Being informed, however, that Lieut. Col. Reid, of the Royal Engineers, had engaged in the investigation, with the design of publishing a more full exhibition of the facts than had yet been offered, I most willingly awaited the issue; being fully persuaded, that whatever doubts or difficulties might remain with those who had not thoroughly examined the subject, would not fail to be dispelled by his enterprising and judicious labors. The highly valuable work of Col. Reid, on the law of storms, is now before me; and I cannot but express my commendation of the talent and research by which he has so ably and satisfactorily exhibited the true natural system of hurricanes, and my acknowledgments, also, for the honorable and very flattering manner in which he has noticed my previous labors.

The mass of evidence and the numerous illustrations exhibited by Col. Reid, have happily left but little for me to attempt on the present occasion; and I proceed, Mr. Editor, to notice in a brief manner some few of the topics which your anonymous correspondent, under the signature of "Stormy Jack," has discussed in your pages; and whom, as the subject has now become more generally interesting, your readers will hope to meet under his own proper signature.

This writer appears, at an earlier period, to have assumed the hypothesis that the hurricanes of the inter-tropical latitudes originate in the *variables* or calm latitudes, which border upon the exterior limit of the trade winds. But in the reports of Lieut. James of H. M. Steam Packet *Spey*, and in other accounts,

---

statement of his observations; and it is owing chiefly, perhaps, to this cause, that several redundancies, and some suggestions on collateral points, require to be expunged from that paper. This explanation is thought to be due to those readers who are now referred to the first named communication in Silliman's Journal for 1831, but need not be applied to the conclusions or opinions which have been advanced in the subsequent papers.

he thinks he finds evidence of a northerly or variable course, in the Barbadoes hurricane of 26th July, 1837; and also of a variable or northeastern course, in the Antigua hurricane of August 2d, 1837; or at least of a lateral movement or oscillation, in the course of these hurricanes.\* He also suggests that hurricanes may alternately dilate and contract during their course.

The inquiries of Col. Reid, aided by his excellent charts and delineations, appear to have done much towards settling these questions, so far at least as relates to the particular storms referred to by your correspondent; and it may be observed, that in tracing the course or track of a storm, we must be governed by its regular geographical developments or progress, rather than by any inductions from the directions and changes of the wind at a given place, grounded on the known whirlwind character of these storms. It is true that these inductions, if carefully made, will commonly harmonize, with wonderful accuracy, with the actual course or path of the storm; but there are various sources of error, which may at times mislead us in our deductions, when made from a limited number of observations; some of which may here be cursorily noticed.

1. The reported observations are not always correct as to the *point of compass* from which the wind blows, and the changes which it exhibits, during the storm. This is not unfrequently the case with the reports of unpractised observers; or with observations made in the gloom of night; or in the tumultuous crisis of the hurricane, when the whole energies of the seaman are directed to his more immediate duties, and the preservation of his ship; and when in the darkness and turmoil of the storm, the swinging of the ship may sometimes be mistaken and reported for the irregular veering of the wind. Verbal or typographical errors, will also have sometimes occurred in the reports which are under consideration; and in some localities, an important difference between the magnetic and the true points of direction, is frequently confounded, or unnoticed.

2. The inductions in question are usually made on the theory of an exact circle in the course of the winds, which in large storms, and for practical purposes, is, in most cases, sufficiently accurate. But it sometimes happens, that the higher portions of the storm, overrun the inferior portions, and reach the surface in

---

\* See Nautical Magazine for January, 1838, pp. 35—40.

advance of the main storm ; thus presenting the wind, for a few hours, in a direction not accordant with that exhibited by the main body of the storm. It may also be added, that in the most violent of these storms, it is at least probable, if not certain, that the course of the surface wind is spirally inward, approximating gradually towards the center of the storm.

3. At stations within the tropics, the changes of wind during the passage of the hurricane, are sometimes known to *exceed* those which pertain to the passage of a regular circuit of wind ; these changes sometimes running through the entire circuit of the compass, and even more. Again, they have been known to shift *back and forward*, in alternate and fitful changes, when near the crisis of the storm. These phenomena, so far from disproving the rotative character of these gales, only prove something more, and afford at least probable evidence, in support of one or both of the following positions, viz. 1. That high land, and other obstructions, often produce sudden and fitful gusts and changes in these violent winds. 2. That, in accordance with our observations of minor vortices, the axis of rotation is often impelled, excentrically, around a smaller circuit, in the interior of the advancing storm.

4. In the northern intertropical latitudes, the recession or departure of the southeastern limb of the storm, appears to be followed, not unfrequently, by strong squalls or gusts from southeast, this being the true course of the general trade wind that determines the track of the storm. These gusts or squalls, if taken for the regular action of the hurricane, may occasion erroneous deductions in regard to the course of the storm.

5. In the latitudes near the exterior limits of the trade winds, the change which here occurs in the course of the storm, produces apparent irregularities or anomalies in the series of changes presented by the wind. Owing to this cause I was misled to some small extent in my estimate of the path of the first August hurricane of 1830, as delineated on my first published chart, with an irregular deflection of the curve on the coast of South Carolina, which was predicated, in part, on the wind setting in at northeast at Charleston, and veering to southeast as the storm became more severe.

6. At stations apparently within the regular track of the storm, there will sometimes be an absence of violent wind ; or, the vio-

lence will pertain to only one of the phases which the storm presents, in its regular course over such locality. This may usually be accounted for, by the interposition of land within the course of the immediate circuit which the wind is found to pursue; and this result is perhaps most obviously exhibited in the South Atlantic or in the Southern Ocean, near the Cape of Good Hope, where the barometric column, not unfrequently, subsides and commences rising, before the full violence of the gale takes effect. The barometer, however, appears always to indicate the true extent and path of these whirlwind storms; and I have found no good grounds to infer, that a hurricane contracts in the width of its path, while sweeping upon the surface of an open sea.

7. Another source of apparent irregularity in the changes of wind in these storms, arises from the interposition of one storm upon the path of another, in their passage through the temperate latitudes. Col. Reid has shown something like this in the hurricane which overtook the *Castries*, August 24th, 1837, which was evidently impinging upon the path of the great hurricane which had previously swept along the American coast. That of the *Castries* appears to have pursued a course similar to the hurricane of October 1st, 1830, as delineated on my first published chart; thus advancing, by a shorter course, into the path of the larger hurricane, and probably with a greater progressive velocity. Col. Reid justly urges the influence of these causes in producing the irregular winds of the higher latitudes. Of the influence of such interposition in apparently arresting or modifying the regular development of a storm while in progress, I have for many years been convinced; but it is due to Mr. Espy, of Philadelphia, to mention, that, so far as I know, he was the first to publish the suggestion.\*

In tracing out the path of hurricanes, we justly discard all theory; and as the information obtained of their course and extent is necessarily limited, and is acquired at different and uncertain periods, our delineations are, therefore, necessarily subject to minor errors and to subsequent corrections. Such corrections, I have ever found to be in favor of the uniform rotation and regular course of progression, which have formerly been described. It is probable, therefore, that the narrowed track, and somewhat

---

\* Journal of the Franklin Institute, Vol. xviii, October, 1836, p. 239.

deflected courses, near the windward islands, of the Barbadoes hurricane of July 26, and of the Antigua hurricane of August 2d, 1837, as laid down by Col. Reid, will ultimately prove to have been more symmetrical;\* and that the westerly recurvation of the track of the latter storm, across the shores of Georgia and Florida, to meet the case of the gale at Pensacola, will give place to a regular continuation of the track in a northeasterly direction. Was the gale at Pensacola, on the 7th or 8th of August, an offset from the Antigua hurricane? or will it not prove to have been another storm?

Although I deem it probable, Mr. Editor, that your correspondent will find occasion to abandon his former views of the supposed lateral motion of the main body of the hurricane, as well as its alternate contraction and dilatation, yet these views appear to be sometimes applicable, or, at least, partially so, to the *axis* or *nucleus* of the great whirling stratum which constitutes the hurricane. In the columnar whirlwinds, or water-spouts, also, these contractions and dilatations of the diminished portion which sweeps upon the earth's surface, are often made sufficiently evident. The suggestions of your correspondent, therefore, are very far from being unsuited to the inquiry, and it is hoped that he will continue to bestow his attention on such facts relating to these storms, as may aid us in gaining further light upon the subject. For his commendations of my imperfect labors, he is desired to accept my acknowledgments. In the further progress of the investigation, it is believed that he will find reason to abandon all reliance upon 'rarefactions' or 'local disruptions,' in the great aerial ocean, as causes of the origin or progress of these great storms.

#### *Hurricanes of 1838.*

Two hurricanes of the present season, (1838,) appear to invite our investigation;—that of the middle of June, in the North Atlantic, and also that which swept the American coast, from Florida to Newfoundland, in the early part of September. Those who have zeal for the undertaking, will find the inquiry both interesting and instructive.

#### *New Jersey Tornado of 1835.*

At the late meeting of the British Association, when Col. Reid's paper on storms was under discussion, Prof. Bache of Philadel-

---

\* Reid on the Law of Storms, Charts V. and VI.



phia, very properly referred to the opposing theory of Mr. Espy, of that city, and stated, also, that in his own survey of the track of the water-spout, or tornado, which passed across the State of New Jersey in June, 1837, he had made observations which appeared to accord with Mr. Espy's theory of storms; and that he had found no evidence of a whirling motion at the surface of the ground, such as Col. Reid had ascribed to water-spouts and hurricanes. This view of the case Prof. Bache had also supported in an able paper on the phenomena of that tornado. I deem it proper to state here, that having also examined the track of the New Jersey tornado, within a few days of its occurrence, and having twice repeated the examination, at later periods, I have observed on each occasion, numerous facts which appear to demonstrate the *whirling* character of this tornado, as well as the *inward* tendency of the vortex at the surface of the ground; and further, that the direction of this rotation was *towards the left*, as in the North Atlantic hurricanes;—a result which I had not previously expected, as it appeared probable that the direction of rotation, in these small whirlwinds, must be entirely accidental. This leads me to notice the only point, perhaps, on which my inquiries have led to a result differing from that obtained by Col. Reid; for in many cases of this sort, since examined, I have found the course of rotation to be uniformly towards the left.

Perhaps I should add further, that having also examined with some care, the reports of the meteorological committees at Philadelphia, made through Mr. Espy, their chairman, and also the meteorological essays of this gentleman, I have not been able to find evidence which disproved the rotation of a violent storm, or that established a course of wind from all sides of a storm directly towards its centre, in accordance with his theory; but, on the contrary, an analysis of the evidence which Mr. E. has adduced, together with the additional facts which I have been able to obtain, has appeared to contravene his conclusions. A valuable statement of facts relating to the snow storm which visited Pennsylvania and other states on the 17th and 18th of March last, drawn up by Mr. Espy, has recently been published by the Philadelphia committees.\* Should the facts contained in this paper be adduced in favor of Mr. Espy's theory, I would only say, that in

---

\* See Journal of the Franklin Institute, Vol. xxii, 1838, pp. 161—175.

this, as in some of the former cases, the field of action of the whirlwind storm will have been in part mistaken. I would also remark, that the points at issue, do not relate to the common and often irregular winds, which, in different localities, accompany a general fall of rain or snow; or which sometimes attend the progress of a whirlwind storm, exterior to its limits.

*Test of Mr. Espy's Theory.*

The truth or error of Mr. Espy's theory may be ascertained by a very simple test. The hurricanes in the West Indies are known to move towards the W. N. W., nearly. Now, if this theory be true, at those islands which are in the centre of the storm's path, and where the gale is of the greatest duration, the wind will set in at about W. N. W., or exactly opposite to the course of the storm, and when its centre has passed over, will shift suddenly to E. S. E., and continue violent in this quarter till the storm is over. But if the gale be a whirlwind, as the facts seem to show, the wind at such places will set in at about N. N. E., and in the middle of the gale will shift nearly to S. S. W.,—the wind varying from these points, and veering more gradually, on either side, in proportion to the distance from the centre of the storm's track. That this corresponds, mainly, to the facts of the case, will hardly be doubted by those who institute the inquiry.

The same test may also be applied to these storms as they move in a N. E. direction along the shores of the United States; where, according to Mr. Espy's views, the gale, on the centre of its path, should blow, for the first part of its duration, from about N. E.; and in the second half, from nearly S. W.\* But all our inquiries serve to show, that the gale is violent at N. E. only on the northern portion of the track of the tempest, and that the usual changes from this direction, are not sudden, and to an opposite point of the compass; but, instead thereof, we observe a gradual veering, by the north, to the northwest.

---

\* Some storms, as Mr. Espy has also acknowledged, are interrupted in their development by the near approach of another storm. Care must be taken, therefore, not to mistake the N. E. wind of a storm whose northwestern limb is thus intercepted by a bordering storm, and which hence is sometimes followed by the natural current of air from the S. W. quarter, for the changes that pertain to the centre of the gale. This error is easily avoided by extending the field of inquiry, and by a due attention to the indications of the barometer.

*Tyfoons of the China Sea.*

It can hardly be doubted that the general course which is pursued by hurricanes, is the same as that of the general mass of atmosphere or winds by which they are surrounded, and of which they form an integral portion. It becomes, therefore, a point of some importance in meteorology, to ascertain the true course of the hurricanes or tyfoons of the Asiatic seas. Should this course prove to be in conformity with the existing monsoons, this would be in accordance, it is believed, with the analogies in the tropical latitudes of the Atlantic; at least, if we have regard to the entire stratum of winds which lies below the common height of the clouds. But if the general course pursued by these storms, be the very same with those of the corresponding latitudes of the Atlantic, in which there are no monsoons, it may serve to show that the westerly monsoons, which are opposed to the course of the regular trade winds, consist only of a misplaced or minor stratum of current, which forms a thin layer of surface wind, less general than that of the regular trades, and which is therefore inefficient in opposing the progress of a great hurricane;—the latter being impelled by the stronger and more general current of the regular trade wind; which is supposed to overlie, at all times, the stratum of misplaced current which forms the westerly monsoon.

These remarks will apply equally to the monsoons of both north and south latitude. Col. Reid has been fortunate in obtaining full evidence of the opposite recurvation of a hurricane in south latitude, in open sea, and during the prevalence of the northwest monsoon; a result which can hardly be too highly valued. This storm, however, (Culloden's hurricane, of March, 1809,) was encountered to the southward of the limits of the northwest monsoon in the Indian ocean; but the hurricane of the Albion, noticed by Col. Reid, was exposed to the full influence of this monsoon. It becomes important, therefore, to ascertain its path, in order that the influence of the monsoon upon its course may be duly appreciated; and we hope that its path may yet be ascertained.

In regard to the northern hemisphere, Col. Reid has given us notices of several hurricanes or tyfoons in the Asiatic seas, with no indications of a course different from those in the North Atlantic. The following generalization, grounded on independent

evidence, was published by the writer in 1833.\* "The tyfoons and storms of the China sea and eastern coast of Asia, appear to be similar in character to the hurricanes of the West Indies and the storms of this coast, [United States,] when prevailing in the same latitudes." This remark was made with special reference to both the rotative and progressive directions of these storms. One of the tyfoons noticed by Col. Reid, that of the *Raleigh*, which visited Canton, on the 5th and 6th of August, 1835, has been adduced, however, by the correspondent of the *Nautical Magazine*, as holding its course towards the southwest.† As this typhoon had previously attracted my attention, it will now be made the subject of our examination.

### *Raleigh's Typhoon of 1835.*

The facts which have been chiefly relied on for establishing a southwestern course for this gale, are contained in the report of H. M. S. *Raleigh*, which was overset and disabled in this gale, in the China Sea, when under bare poles: which report I have as follows:

"*H. M. Brig Raleigh*. Aug. 1, 1835.—Working out of Macao Roads.—At noon, east end of Grand Ladrone, E.  $\frac{1}{2}$  S.—Aug. 2d, at noon, S. E. end of Formosa N. 85 E., 340 miles: fine weather all day.—Aug. 3d, at noon, S. end of Formosa N. 82 $\frac{1}{2}$  E., 252 miles. Fine weather all day.—Aug. 4th, 10h. 20m. a. m. close reefed topsails and courses:—12h. 30m. p. m.—barometer fell from noon  $1\frac{5}{16}$ : took in mainsail and foresail;—at 1h. 30m. got all snug; vessel going through the water between 3 and 4 knots; barometer 29.40, falling;—at 7h. 30m. wind veered to N. N. E. and typhoon commenced;—at 8 p. m. barometer 29.36, falling;—8h. 30m. typhoon increasing;—10 p. m. close reefed fore trysail and set it;—typhoon veering to E. N. E. with a heavy sea;—at midnight typhoon increasing; barom. 29.04, falling.

"*Aug. 5th.*—3 a. m. typhoon veering round to E. S. E., still increasing in violence;—6h. 30m. barometer 28.25;—8 a. m. typhoon increasing;—9h. 30m. a. m., if possible blowing heavier, *ship went over*:—In this awful situation ship lay for about 20 minutes;—9h. 50m. lower masts went by the board and ship righted with seven feet water in her hold; barometer did not fall lower;—at noon typhoon moderated a little;—at 6 p. m. typhoon more moderate, with a heavy sea;—midnight, strong gusts of wind with heavy sea from south."—*Abridged from Canton Register of March 14, 1837.*

See also the log of the *Raleigh*, as it appears in Col. Reid's work, which contains a sketch, showing the position of the *Raleigh*, as

\* *American Coast Pilot*, 12th edition, p. 629.

† See *Nautical Magazine* for May, 1837, pp. 303—306.

given in the log, and illustrating the direction of the wind. Col. Reid has also given the position of a schooner, which encountered the typhoon in lat. 18° 2' N., lon. 115° 50' E., of which I had previously received no account. I will now submit such evidence as I possess, in addition to the account furnished by the Raleigh; adding, also, a sketch and figure illustrating the course and progress of the typhoon; and which was prepared and stereotyped some months since, in reference to furnishing an account of this hurricane.

At *Macao*, where the typhoon was experienced on the 5th and 6th, many houses were greatly damaged; also, many lives were lost in the inner harbor, and some vessels driven on shore. The direction and changes of the wind at *Macao* are not stated; but we are favored with the following valuable table of the state of the barometer during the period of the storm.

"August 5th.		h. m.	Barom.	h. m.	Barom.
h. m.	Barom.	0 45 a. m.	28.30	6 45 a. m.	29.12
1 00 a. m.	29.47	1 20 " ( <i>lowest</i> )	28.05	7 45 "	29.20
2 30 p. m.	29.28	1 25 "	28.08	8 15 "	29.21
5 00 "	29.20	1 45 "	28.20	8 45 "	29.23
7 20 "	29.12	1 55 "	28.30	9 30 "	29.27
9 00 "	29.08	2 00 "	28.37	10 25 "	29.30
10 20 "	28.95	2 25 "	28.56	11 00 "	29.34
10 45 "	28.90	2 45 "	28.68	2 00 p. m.	29.42,
11 05 "	28.85	3 10 "	28.75	and continued rising to	
11 30 "	28.75	3 40 "	28.83	29.65, at which point it	
11 53 "	28.65	4 10 "	28.90	usually stands during	
<i>August 6th.</i>		4 45 "	28.97	fine weather."*— <i>Canton Register</i> , Aug. 15.	
0 15 a. m.	28.50	5 15 "	29.02		
0 30 "	28.40	6 00 "	29.08		

This table affords in itself good evidence of the passage of the centre of the vortex near to *Macao*.

At *Canton*, (60 miles north of *Macao*,) the typhoon began on the evening of the 5th, after three or four days of very hot weather, with northerly winds, and continued throughout the night and the next day. Its violence was greatest about two o'clock on the morning of the sixth. The following is an account of the state of the barometer and winds at *Canton*:

\* This relates to "fine weather" of the S. W. monsoon; the mean of the barometer for July and August being, at *Canton*, 0.40 in. lower than for December and January, in the N. E. monsoon. This barometer at *Macao* appears to stand about 0.15 or 0.20 inch lower in its adjustment than that used at *Canton* for the reports in the *Canton Register*, the mean of which for five years is 30.027. Many, if not most of the common ship barometers, stand too low in their adjustment.

## August 4th.

9 a. m. barom. 29.79 Wind N. W. Fine weather.  
 4 p. m. " 29.70 " N. by W. Moderate breeze.

## August 5th.

9 a. m. " 29.62 Wind N. and N. W. Fair Weather.  
 4 p. m. " 29.54 " unsettled—Rain and fresh breeze.  
 12 p. m. " 29.37 " N. blowing hard and in heavy gusts.

## August 6th.

5 a. m. " 29.34 Wind N. E. blowing hard with heavy rain.  
 9 a. m. " 29.51 " S. E. " " "  
 11 a. m. " 29.58 " S. E. blowing hard,—moderating.  
 5 p. m. " 29.70 " S. E. " "  
 11 p. m. " 29.85 " S. E. " "

## August 7th.

8 a. m. " 29.94 Wind S. E. Cloudy.—*Compiled from the Canton Register.*

On Wednesday the 5th inst. a Typhoon swept over the city of Canton. It began in the evening and continued throughout the night and the next day, blowing its best about 2 o'clock in the morning. The damage done by the Typhoon at Canton is small, but not so at Kumsingmoon, Macao, and elsewhere on the coast.—*Canton Paper.*

The American ship *Levant*, Capt. Dumaresq, which arrived on the 7th of August, the day after the gale, came in with royals set, from Gaspar Island, in fourteen days, having had light winds all the way up the China sea, and *did not feel the typhoon.* This important fact is stated in the Canton Register of August 11th.

Extract from a private letter from on board the ship *Lady Hayes*, which left Macao Roads a day or two before the storm, and returned to Kumsingmoon, after the gale.

"Early on the morning of the 5th, we observed indications of bad weather. At 10 a. m. the wind freshened a little from the same quarter it had been for the last twenty four hours, viz. *north*; so we thought it best to turn her head back again to look for shelter, fancying ourselves to be about thirty five miles off the land. We carried a press of sail until noon, when we found we had too great a distance to run before we could get into shelter, and expecting it would get so thick that we could not see our way; so we turned her head to sea, and clapped on as much sail as she could stagger under, *steering S. E. by E.* The wind being then at north, we were desirous of getting as far off the land as possible, expecting the wind round to the eastward, there being a most *tremendous swell* from that quarter. At 4 p. m. it was blowing in severe gusts, and we shipping a good deal of water, and the ship becoming unmanageable. About 8h. 30m. *the wind began to veer to the west*, but continued to blow as hard as ever, till midnight, when it *drew round to south*, and moderated a little. It continued to blow hard from that quarter until noon of the 6th, when it moderated fast, and we began bending other sails in room of those that were split. When the gale commenced, which we consider

it did at 1 p. m. on the 5th, we were about twenty miles east of the Lema ; where we were when it ended, it is hard to say, as we saw nothing till the morning of the 7th, when we made Mondego Island. We hardly think we could have had the gale so heavy as those inside ; and what is most extraordinary, the wind with them veered to the eastward round to south ; but with us it veered to the westward round to the south. It was fortunate for us that it veered to the westward ; for had it veered to eastward, we should most likely have been driven on shore among the islands, as we could not have been more than fifty miles off the land [?] at 8 p. m. on the 6th."—*Abridged from the Canton Register of August 18th.*

On the reduced chart which is given herewith, the tracks of the Lady Hayes and the Levant are laid down by estimate, from the printed accounts. The small dotted circle B, surrounded by the storm arrows, is supposed to indicate the position of the centre of the storm at the time the Raleigh was overset ; and the position of the latter should be marked somewhat nearer this circle, according to the lat. and long. of the Raleigh on the 5th, which Col. Reid has given in her log. The course of the storm appears to have been N. 72° W., and its centre is supposed to have been opposite the Raleigh, about 8h. 20m. a. m. on the 5th ; but this cannot be ascertained with precision, as the indications of the barometer do not appear to have been closely watched and recorded during this terrific period of the storm.

Having shown the rotatory character of these tempests, I consider the depression of the barometer which attends them, as being due to the rotative action ; and the point of greatest depression, as indicating the true centre or axis of the storm.

From the evidence now before us, we arrive at the following facts :

1. That the *Raleigh* met a gale which set in with the wind at N., veering round by the E. to S. E. and South.

2. That at the harbors and roads "inside," (Macao, Kumsingmoon, &c.) as well as at *Canton*, the gale occurred at a later period ; and the wind also set in at North, and veered to E. and S. E., in a manner similar to that reported by the *Raleigh*.

3. That with the ship *Lady Hayes*, off the islands near Macao, the wind also set in at North ; but the ship steering S. E. by E. under a press of sail, (and doubtless falling off with the heavy sea from eastward,) the wind, towards the middle of the gale, began to veer towards the West ; whence it drew round to South, towards the close of the gale.

4. That the violence of the wind was apparently greater with the *Raleigh*, than with the *Lady Hayes*.

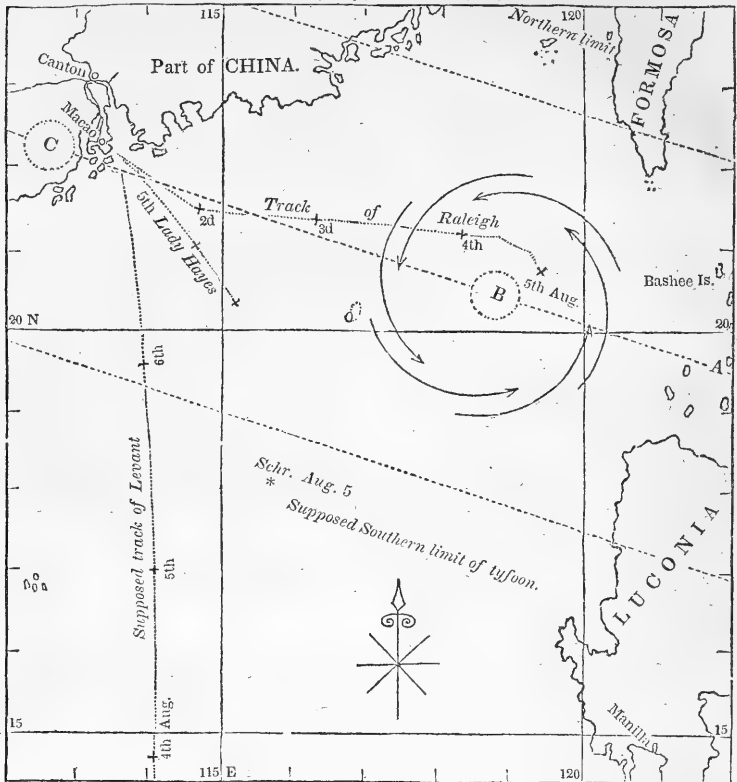

5. That the gale was experienced by an English schooner, Aug. 5th, in lat.  $18^{\circ} 2' N.$  lon.  $115^{\circ} 50' E.$ ; but the *Levant*, arriving on the 7th, in her course through the China sea, did not encounter the gale.

6. That the fall and rise of the barometer at Macao, and with the *Raleigh*, and the strength and changes of wind with the latter, were such as are often exhibited near the centre of a hurricane; and that the minimum depression of the barometer occurred about seventeen hours later at Macao, than with the *Raleigh*.

These facts seem to establish the following conclusions:

1. That the Typhoon advanced in a westerly direction.
2. Negatively;—that it did not pass through the China sea, from N. E. to S. W., nor on the opposite of this course.



3. That it was a *progressive whirlwind storm*; turning to the *left*, around its axis of rotation.

4. That its centre of rotation passed to the *northward* of the *Lady Hayes*; and to the *southward* of the *Raleigh* and of *Canton*, and the anchorages near *Macao*; and nearly on the line A, B, C, as marked on our chart.

5. That the rate of its progress was about *seventeen nautical miles per hour*.

6. That the extent or diameter of the violent part of the gale, as deduced from its duration and rate of progress, was about four hundred nautical miles, or equal to six or seven degrees of latitude.

7. That the latter induction agrees with the geographical evidence which has been obtained of the visitation of the storm.

The progress of the typhoon being taken at 17 miles per hour, it follows that the excess of velocity of the wind at E. with the *Raleigh*, over that of the wind at W. with the *Lady Hayes*, supposing the rotation to have been in a circle, would be more than thirty miles an hour; allowing nothing, however, for difference of retardation of the surface wind, and not taking into the account the additional retardation which the west wind of the *Lady Hayes* must have been subject to, in its recurving course over the land. If a circle be drawn on the chart around each of the points B and C, with a radius equal to 3 or  $3\frac{1}{2}$  degrees of latitude, these circles will comprise, somewhat nearly, the field of action of the storm, at the two periods of 9 a. m. of the 5th, and 2 a. m. on the 6th of August.

The progressive velocity and course of this typhoon, is nearly the same as that of the *Trinidad hurricane* of June, 1831; and the rate of progression also corresponds nearly to that of the *Antigua hurricane* of August 12th, 1835. See tracks Nos. I, and V, on my chart of the courses of hurricanes, in the April No. of the *Nautical Magazine*, 1836.\*

This examination of the case before us, appears to show that the direction of rotation, and the course of progression of this typhoon, while crossing the *China sea*, agree with those of the hurricanes of the *West Indies*; and that *its course was not controlled, or materially influenced, by the existing southwest monsoon*.

---

\* For this chart, see also *Silliman's Journal*, Vol. XXXI, or *Reid on the Law of Storms*, Chart III.

*Methods for Escaping its Violence.*

The professional readers of the Nautical Magazine will naturally inquire for the best method by which the Raleigh might have avoided the heart of the typhoon, had its true character, and probable course, been known. To this I answer, that the Raleigh being bound to the Bashee islands, and having sea room, and the gale having set in from N. or N. N. E., which showed that the ship was then not far from the centre of its path, its greatest severity could have been avoided by either of the following methods :

*First*, by tacking to the N. W., upon the wind, and, as the latter veered eastward, hauling up for Formosa and the Bashee islands, so far and as fast as the veering of the gale in this direction might allow.

*Second*, by standing away to W. S. W. with a view of saving time as well as distance, in the escape, and keeping off more to the southward, as the wind should veer to the westward ; and when the barometer began to rise, by bearing away, under the heel of the storm, for her point of destination.

The advantage of the first method would consist in having to run a shorter distance off her course, in order to avoid the centre of the gale. Its disadvantages consist in being too much headed off at the outset, and perhaps, in getting too far northward to make the best of the S. W. monsoon, after the gale should have terminated. The advantages of the second method would consist, in running off more rapidly, with a fair wind and sea ; in getting under the southern semi-circuit of the gale, where, owing to the course of the wind being counter to the progress of the storm, it becomes less violent ; in having almost throughout, a fair, instead of a head wind ; and, finally, in being left by the storm to the windward of the point of destination, as regards the existing monsoon. The disadvantage, if any, of this method would consist in the greater extent of the rout ; but as this would be accomplished under far more favorable circumstances, and probably in much less time than the northern, it can hardly be counted as an objection. It would, however, have been necessary to avoid the *Paracels*, in shaping the southern course.

The second method for avoiding the heart of this storm, therefore, would appear to have been preferable. But had the ship fallen under the more northern portion of the gale, toward the dot-

ted line which crosses Formosa, thus taking the wind first at N. E., or E. N. E., she should have kept to the wind, with her head to the northward. But if her position had been nearer the dotted line which crosses Luconia, taking the wind first at N. W., she should first have brought the wind on her starboard quarter, and subsequently have bore away, as the wind veered by the west.

Some further notices of tyfoons may now be added, to show that the results just noticed, are not peculiar to this storm alone, and that other tyfoons of the China sea pursue a similar course, and exhibit the same rotative action.

*Canton Tyfoon of Aug. 3d, 1832.*

At *Macao* the wind set in from the north, and reached its greatest height about 1 p. m.; continuing with the same violence till 5 p. m., when it veered suddenly to the southward, but with diminished strength. When the fury of the gale was exhausted, the quicksilver rose at the rate of three tenths per half hour. *Barometer Aug. 2d, 8 a. m. 29.68;—8 p. m. 29.34;—Aug. 3d, 8 a. m. 29.34;—5 p. m. 27.88.* Other land barometers differently adjusted, fell to 27.96 and 28.05.

At *Cap-shuy-moon* the gale began at N. and N. W., between which points it blew with tremendous violence; shifting, towards the conclusion, to S. E. whence it blew more moderately. The *barometer*, in the early part, fell to 28.20.

The American ship *Don Quixote* left on the day before the tyfoon; and returned on the 5th with loss of mainmast.

Since the tyfoon, the British brig *John Biggar*, from Manilla, has come in dismasted. The Spanish brig *Veloz*, also from Manilla, has arrived with loss of mainmast.

A letter from the commander of the Dutch ship *Fair Armenian*, which foundered about thirty miles westward of the Grand Ladrone, says:—"On the evening of the 2d inst. we made the Grand Ladrone, and on the morning of the 3d it came on a tyfoon blowing off the land; this about noon increased to a tremendous height and dismasted us; unshipped and broke our rudder, and carried away a great part of the bulwarks. The gale was at its height about 4 or 5 p. m., and after dark gradually moderated."

The *Edmonston*, *Caledonia*, *Esperança* and *Italy* have come in without damage. The *Caledonia* on the 3d, when in lat. 17° N., lon. 113° 50' E. experienced a strong gale from W. veering to S. W. and S., with a heavy and confused sea. The *barometer* fell to 28.50. The *Edmonston*, on the same day, when within seventy miles of the land, felt the same weather, which brought her under bare poles for four hours.

At *Bocca Tigris*, the weight of the tyfoon, which in *Canton and Whampao* ranged from N. to N. E., was felt about 4 or 5 p. m.; the *barometer* standing at 29.10. About 6 p. m. the quicksilver rose and the gale began to abate.

At *Canton*, Aug. 3d. Blowing hard at N. and N. E. with violent gusts; *barometer* 29.15; and for the most part rain. Aug. 4th. First part blowing hard, wind S. E. *barom.* 29.70;—middle and latter part strong breezes and fine weather.—*Canton papers of August, 1832.*

*Extract from the journal of an American shipmaster bound to Canton.* "Aug. 2d, 1832, (nautical time,) *lat.*  $18^{\circ} 34' N.$ , *lon.*  $114^{\circ} E.$ ; *barom.* 29.56. First part light and baffling winds from *E. to N. E. and N.* and hazy:—middle part the same:—At 4 a. m. *calm*, *barom.* 29.59:—At 4.30 a. m. a breeze sprung up from *W. N. W.*;—made all sail by the wind. Latter part and end, strong *W. N. W.* wind and rough head sea. Took in the royals, flying jib, and fore and mizen top gallant sails. *Barometer at noon* 29.40. The weather, however, looks very fine, and the breeze is steady at *W. N. W.* *lat.*  $19^{\circ} 54' N.$ , *lon.*  $113^{\circ} 50' E.$

*Aug. 3d* commences with a strong steady breeze at *W. N. W.* and hazy weather, *barometer* falling fast. At 2 p. m. down to 28.98, but not the least unfavorable appearance in the clouds, sea, or weather. [The ship was at this time running into the path of the gale, from its southern side.] I must acknowledge that the rapid fall of the mercury, within the last ten hours, has alarmed me not a little, and we are now preparing for the worst of weather.—At 4 p. m. *barom.* 29.25 and the wind freshening; single reefed topsails. The old tars who have seen sail carried on this ship through thick and thin in the stormy regions of the southern ocean, now look at each other with amazement at such preparation for apparently nothing. Towards evening the weather begins to look unfavorable; the sun went down in a body of clouds, deeply tinged with red; not the rich and variegated tints that give rise to pleasurable sensations to all who look upon them, but the fierce, glaring, angry red that creates distress in the bosom, particularly of a mariner. After sunset the moon (at the 2d quarter) could be seen at intervals through the clouds that are driving from the *N. E.* at the rate of twenty knots, and the lightning shooting up from every point of the compass. At 8 p. m. *barom.* 29.15. Took in all sail but the close reefed fore and main topsails and fore-topmast staysail; the wind still steady at *W. N. W.* Sounded in 45 fathoms, the *Grand Ladrone* bearing *W. N. W.* 38 miles. At 10 p. m. the wind suddenly shifted to *W. N. W.* [*N. N. W.?*] in a squall.—Heavy rain and distant thunder until 5 a. m.:—Had continued shifts of wind all round the compass. At 7 a. m. a steady gale very severe, from about *N. W.* and constant rain:—hove to under the reefed main topsail:—At 8 a. m. *barom.* 29.!!—Latter part and end, the real, genuine, unadulterated Chinese *Tyfoong*; a steady roar and constant rain; took in the main topsail.

*Aug. 4th.* (P. M. of 3d.) The first quarter of this day extremely severe gale and thick weather.—At 2.30 p. m. *barom.* 28.88; shortly after which it began to rise:—at 6 p. m. 29.05;—at 8 p. m. 29.08, and moderating.—During the night, hard gale from *W. to W. S. W.* and torrents of rain.—At 4 a. m. wind *S. W. to S. S. W.* and hazy:—made sail and by 6 a. m. had royal and studding sails set. During the day passed a number of wrecks, and when we arrived, (5th,) found that the hurricane had been very severe and caused immense destruction."—*New York Journal of Commerce.*

#### *Canton Typhoon of Sept. 23d, 1831.*

The American ship *Galen*, from the Sandwich Islands, bound to Canton, encountered bad weather off the Bashee Islands on the 21st of September, and on the 23d near the Lema Islands, lost her mizen mast, fore and main topmasts, &c.

The British barque *Agnes*, from Singapore, also lost her foremast on the 23d, and was obliged to cut away the remaining masts. She was at anchor on the 27th, about nine miles southward of the Grand Ladrone.

H. C. ship *Hertfordshire* and Danish ship *Norden*, arrived on the 25th [from the southward] and experienced no bad weather; the latter reports that on the 24th a very violent swell was running down from the north-eastward, but the barometer indicated no change, and neither of these vessels were aware of the tempest till their arrival at Macao.

At *Canton* early in the morning of the 23d September commenced a *hard northerly gale*, which continued without intermission for twenty four hours. The tide rose to a great height and much damage was sustained; an official return to the authorities at Canton, states, that after it was past, *one thousand four hundred and five* dead bodies were picked up along the coast. The gale was far more severely felt at *Macao* and *Kum-sing-moon*, where it is described as having been truly dreadful.—*Canton papers*.

The narrative of Capt. Lynn, of H. C. S. Duke of Buccleugh, appended to his Star tables for 1822, contains accounts of *four* several tyfoons which were encountered by the convoy under H. M. S. *Swift*, Capt. Hayward, which left Macao Roads on the 15th of June, 1797, bound homeward by the eastern passage. The first of these storms occurred on the 19th June, in lat.  $22^{\circ} 9' N.$ , lon.  $117^{\circ} 3' E.$  The wind set in at N., and veered to N. E. by N.; but owing, probably, to the course of the ship, veered back to N., and subsequently by N. W. and W. to S. Barometer, 29.

The second was met on the 2d July, in lat.  $19^{\circ} 4' N.$ , lon.  $124^{\circ} 18' E.$ , and ended on the 3d. The wind set in at N. E., and veered by N. and W., as on the 19th of June; the ship having been kept before the wind, probably as before. Barom. 28.77. The *Swift* is supposed to have foundered in this storm.

The third typhoon was encountered on the 8th July, in lat.  $16^{\circ} 54' N.$ , lon.  $126^{\circ} 9' E.$  Barometer, at lowest, 28.40. This gale commenced at N. N. E.; but the ship running to the southward, as before, the wind again veered to N. and N. N. W., and thence shifting, after a lull, to S. S. W.

A fourth typhoon was encountered on the 17th July, lat.  $16^{\circ} 54' N.$ , long.  $126^{\circ} 9' E.$ , in which the wind set in at the same point as before, and veered also in the same manner. Barometer, 28.55.

These and other facts had been the basis of my inductions, in relation to the tyfoons of China and the storms of the North Pacific; and the voyages of Cook and others upon the coasts of Japan and China, and the journals of whale ships in the Northern Pacific, had afforded good evidence that the same system of storms prevailed in the North Pacific as in the North Atlantic

From a comparison of the foregoing accounts, it appears that those ships suffered most severely, which fell under the *northern* semi-circle of the storm. This result, probably, would not follow in the higher latitudes, where the storm has recurved to the northward and commenced its easterly course.

*Hurricanes of the Asiatic Seas.*

It is generally believed that the hurricanes of the Indian seas occur only or chiefly at the change of the monsoons; but this opinion appears to be of doubtful accuracy.

From the valuable meteorological journal which appears monthly in the Canton Register, I have compiled the following statement of the periods of change in the N. E. and S. W. monsoons at that place :

Vernal change from N. E. to S. W.	Autumnal change, from S. W. to N. E.
1830. From 20th to 28th of April.	From 5th to 12th of October.
1831. " 7th to 17th "	" 1st to 14th "
1832. " 4th to 7th "	on 25th September.
1833. " 9th to 14th "	" 9th to 30th "
1834. " 3d of April to 8th of May.	" 19th to 30th "
1835. " 8th to 21st of April.	" 10th to 24th "*.

The American ship *Parachute*, at Boston from Calcutta, experienced a very heavy gale to the northward of  $18^{\circ}$  N. lat. in the Bay of Bengal, on the 23d, 24th, and 25th of August, 1831. Spoke the *Nandi* from Bengal to Liverpool, dismasted in the gale.—*London shipping lists.*

*Bombay, June 24th, 1837.*—One of the severest gales that has occurred here for the last forty eight years, commenced on the evening of the 14th inst. On the morning of the 15th the scene of destruction was displayed. The roaring of the wind and thunder was truly awful; large palmira trees, six feet in diameter and seventy feet in height, were torn up by the roots, and many houses completely unroofed.

The accounts of hurricanes in the Asiatic seas, given us by Col. Reid, are also more common to the regular monsoons than to the periods of change.

*Typhoon at Manilla and Hurricane at Balasore, Oct. 1831.*

The following account of a typhoon in the China sea in 1831, is interesting insomuch as it affords probable grounds for connecting the hurricane at Manilla, Oct. 23–24, with that of Oct. 31, at Balasore, on the shores of the Bay of Bengal.

*Extract from the private journal of Wm. F. Griswold, Esq., Master of the ship Panama, on a voyage to Canton, October, 1831.*

---

\* From these and like statements of the changes of the monsoons at other points, some useful inductions might be obtained.

*October 23d, (Nautical time,) lat. 9° 17' N., lon. 117° 16' E.* Wind came out at southward and continued until 10 p. m., then died away and commenced from the northward, with a heavy head sea.—Forenoon breeze from N. W. and clear weather. *Lat. 9° 45' N., lon. 117° 25' E.*

*Oct. 24th.*—Pleasant breezes from N. W. and hazy, steady weather. A sea rolling from the northward. I suppose there has been a gale in the China sea which has not yet reached us.—Evening wind rapidly increasing and barometer falling from 29.75 to 29.40. Midnight reefed topsails.—9 a. m. double reefed do.—barometer 29.20. Ends with tremendous gale from the westward and heavy sea—barometer 29.10. *Lat. 11° 51' N. lon. 118° 20' E.*

*Oct. 25th.*—Heavy gale from W. S. W.—barometer 29.05. Gale hauling to the southward. Evening more moderate. Made a little sail. Wind at 7 p. m. from southwestward; at 11 p. m. from southward. In the morning at 5 o'clock the wind came out at S. E. (barometer at 29.10) and blew a perfect hurricane. Hove to under mizen staysail;—barometer at 1 p. m. 29.05—4 p. m. 29.00—7 a. m. 29.10—8 a. m. 29.20. I believe this fall of the barometer to be, in this latitude, very remarkable.

This gale was on the 24th and 25th October, civil time, and from its peculiar features and double fall of the barometer, there appears something like the falling in of two hurricanes on the same track. It was, doubtless, in whole or in part, the same hurricane that visited Manilla on the night of the 23d of October, and which is noticed by Col. Reid. The irregularities of the storm *may* have been caused by its passage over the Philippine Islands, the Panama being then off the Strait of Mindora, and about 210 miles from Manilla. I have deemed it not improbable, that this storm was the same that visited the Bay of Bengal on the 31st of the same month, and was so destructive at Balasore, and on the neighboring coast. The course from the Panama's position to Balasore is about N. 73° W., and the distance, say 1920 miles, which would give a rate of progression of 11½ nautical miles per hour; which coincides with other storms which have formerly been examined. It is important to ascertain if this storm crossed the Burman Empire, immediately previous to its appearance in the Bay of Bengal.

*Panama's Hurricane in Indian Ocean, January, 1832.*

In order to add to the stock of available facts for tracing the storms of South Latitude, I add the following account of a hurricane in the Indian Ocean, on the 25th of January, 1832.

*“January 25th, (nautical time,) Lat. 20° 14' S. Lon. 80° 36' E.* Strong breezes and squally, with every appearance of a gale; barometer at noon 29.57, having fallen from 29.80. At 1 p. m. barom. 29.50;—

at 4 p. m. 29.45;—at 8 p. m. 29.50;—at midnight 29.30: reefed, &c. and brought the ship to. During the night, heavy and increasing gale from *E. S. E. to E.* At 4 a. m. barom. 29.00;—at 6 a. m. 28.90;—at 8 a. m. 28.80;—at 10 a. m. 28.70;—at noon 28.60.—Tremendous gale and dangerous sea. *Lat. 20° 14' S., Lon. 76° 47' E.*

“Jan. 26. Blowing a tremendous hurricane. Lost the fore-topsail and foresail and scud under the fore-topmast stay-sail, which split, and the ship broached to, lying on her beam-ends in the trough of the sea. Night came on gloomy and dark, the hurricane increasing. At 10 p. m. the wind began to abate, hauling eastward, and finally to *E. N. E.*: ended with pleasant weather. Barometer at 1 p. m. 28.55;—at 2 p. m. 28.50;—at 4 p. m. 28.45, (lowest);—at 8 p. m. 28.50;—at 9 p. m. 28.60;—at 10 p. m. 28.70;—at 11 p. m. 28.80;—at midnight 28.90;—at 1 a. m. 29.00;—at 2 a. m. 29.10;—at 3 a. m. 29.20;—at 4 a. m. 29.30;—at 6 a. m. 29.40;—at 8 a. m. 29.50;—at 10 a. m. 29.55;—at noon 29.60: *Lat. 21° 46' S., lon. 75° 59' E.*”—*Journal of Wm. Frederick Griswold, Esq., Master of Ship Panama, from Canton, bound to New York.*

As no change of wind is specified at the commencement of this storm, it would appear to have begun in the direction of the south-east trade, the latter being a fair wind for the ship, which appears to have been under the southern semi-circle of the storm; and the progress of the storm towards the southwest, nearly in the course of the ship, doubtless protracted its duration. The direction and veering of the wind in this storm, is in perfect accordance with the facts and inductions adduced by Col. Reid, relating to the Culloden's storm of March, 1809; the direction of rotation being *towards the right*, as in other storms in south latitude. This hurricane of the Panama, is one of the storms on which my own inductions for southern latitudes had been founded.

#### *Natural System of Winds and Storms.*

It will be found difficult to reconcile with the received theory of winds, the facts which have claimed our attention while pursuing this inquiry. To me it appears, that the courses of the great storms may be considered to indicate with entire certainty, the great law of circulation in our atmosphere; and that the long cherished theory which is founded upon calorific rarefaction, must give place to a more natural system of winds and storms; founded, mainly, upon the more simple conditions of the great law of gravitation.

#### *Storms of Europe.*

The courses and developments of the storms which pass over the island of Great Britain, are believed to be more complex than on the shores of the United States. It is not improbable, that the



course of many European storms is in a southeastern direction. A comparison of marine reports has shown me, that while a storm was blowing at W., or W. S. W., in the English channel, it was blowing S. E. at Elsineur; at N. E. on the east coast of Scotland; and at N. and N. W. in the Irish channel; thus exhibiting, plainly, a rotation to the left. The great storm of Nov. 29, 1836, appeared in the north of Germany after it left the shores of England, and other British storms have also exhibited an easterly progress. But it is on careful investigations, hereafter to be made, that we must rely for a proper development of the system of European storms.

New York, October 20, 1838.

---

ART. II.—*On the Meteor of May 18th, 1838, and on Shooting Stars in general*; by ELIAS LOOMIS, Professor of Mathematics and Natural Philosophy in Western Reserve College, Ohio.

ON the evening of May 18th, 1838, a very remarkable meteor was seen throughout most of the northern part of the United States, and a considerable district of Upper Canada. It attracted general attention from its size, brilliancy, train, length of path, and slowness of apparent motion. Observers, almost without exception, pronounced it the most remarkable meteor they ever saw. Having obtained observations at four or five different places, and learned the general phenomena of the meteor, I inserted a brief notice of it in the Cleveland papers, and concluded with requesting information from any one who observed it. Above twenty letters were received in answer to this invitation; and as considerable information has been obtained through other channels, the observations are as numerous as could be desired. Their accuracy will be considered hereafter. The result is, that the meteor was noticed throughout all the north of Ohio; at Detroit and Ann Arbor, in Michigan; at various places in the State of New York; at two stations in New Hampshire; and in various parts of Canada. The evidence that all saw the *same* meteor is as follows: 1. All saw a meteor at the same instant. Throughout Ohio, the time was that of early candle-lighting. The brightest stars were just becoming visible. In New Hampshire, the time was a little after eight o'clock. The phenomenon, as

near as can be ascertained, appeared every where at the same absolute instant. 2. The meteor was every where seen in the same place. Not in the same direction as referred to the points of the compass, but occupying the same absolute position as referred to the earth's surface. That is, the appearances are perfectly explained by supposing a single meteor of great size, elevated about thirty miles above the earth's surface, to have described a nearly horizontal path of more than two hundred miles. Such a supposition will satisfy all the observations within the limits of the unavoidable errors of observation. 3. The meteor was every where of remarkable size. It was of such splendor as is very seldom seen. 4. It exhibited a train, besides several peculiarities so extraordinary, as to identify it without danger of mistake. It broke into several fragments which fell behind the main body and followed at some interval. This will be considered more fully hereafter. These four facts combined, prove conclusively that it was indeed the *same* meteor seen by the different observers. The evidence is the same in kind, and well nigh the same in degree, as that which assures us that it is one moon which is seen in the northern and southern hemispheres. Assuming, then, that all the observations were made upon a single object, I proceed to determine as accurately as possible the height and course of the meteor. At Hanover, N. H., the meteor was observed by Professor Hubbard. When first noticed, it bore S.  $80^{\circ}$  W. elevated above the horizon  $9^{\circ} 38'$ ; it disappeared N.  $69^{\circ}$  W. at an elevation of  $3^{\circ} 24'$ . These numbers were obtained by measurement from the remembered position of the meteor, and were communicated to me by Professor Young. At Clinton, in New York, the meteor was observed by Professor Catlin, of Hamilton College. It first appeared S.  $13^{\circ} 25'$  W., elevated  $4^{\circ} 30'$ ; it disappeared N.  $67^{\circ}$  W., elevated  $8^{\circ}$ . At an intermediate point it bore N.  $87^{\circ} 30'$  W., elevated  $12^{\circ} 36'$ . At Buffalo, N. Y., the meteor was observed by Mr. R. W. Haskins. He first saw it a little south of east, and it disappeared a little east of north. Its greatest altitude was  $27^{\circ}$ . At Hudson, Ohio, the meteor was observed by Professor Barrows. It was first seen N.  $83^{\circ}$  E., elevated  $7^{\circ}$ ; and disappeared N.  $35^{\circ}$  E., elevated  $6^{\circ}$ . In Aurora, a town adjoining Hudson, the meteor was observed by Mr. E. Brown. He first saw it due east, elevated about  $8^{\circ}$ ; and it disappeared N.  $30^{\circ}$  E., elevated  $8^{\circ}$ . At Ann Arbor, Michigan, the

meteor was seen by Messrs J. and L. Chandler, to move nearly parallel with the horizon, at an elevation of three degrees, according to one, and of four degrees, according to the other. It was seen in the N. E. quarter, but the precise direction could not be given, as the estimate was made when they had no opportunity of returning to the spot of observation. The preceding observations are the most precise of any I have been able to obtain. They were all made by the aid of instruments, and the chief error therefore to be apprehended, is that arising from the difficulty of exactly remembering the apparent position of the meteor. It is believed, however, that in the above observations, this error is small. In this first comparison, I neglect entirely such observations as give mere *estimates* of elevation by the eye; for it is a remarkable fact, that almost every one over-estimates angular elevation near the horizon. I have made the computation from the above data, and find the perpendicular elevation of beginning 28.5 miles. The place where it then stood in the zenith was in Lycoming county, Penn., Lat.  $41^{\circ} 16'$ , Long.  $1^{\circ}$  west from Washington. At its explosion, its height was 32.1 miles, and the place where it then stood in the zenith was in Upper Canada, Lat.  $44^{\circ} 7'$ , Long.  $2^{\circ}$  west. At an intermediate point, its height was 34.8 miles, and it was then vertical over Monroe county, N. Y., Lat.  $43^{\circ} 0'$ , Long.  $0^{\circ} 46'$  west. The length of path then was 218 miles, and its mean course N.  $13\frac{1}{2}^{\circ}$  W., passing vertically over Rochester in the State of New York. In this computation I have aimed to make the positive equal to the negative errors, and the sum of the errors, disregarding their signs, a minimum. The beginning, as I have here assigned it, rests upon the observations at Clinton, Hudson, and Aurora. It appears not to have been seen so early in its course either at Hanover, Buffalo, or Ann Arbor. The middle point of its path, near Rochester, appears to have been observed at all the stations. The observations at Hudson and Aurora having been made near each other, I consider as one observation, and take their mean. It is impossible perfectly to satisfy the observations. The result I have above given, makes the errors of the observations as follows: Hanover  $+ 3^{\circ} 45'$ ; Clinton  $- 2^{\circ} 54'$ ; Buffalo  $- 2'$ ; Hudson  $- 5'$ ; Ann Arbor  $- 44'$ . The positive are equal to the negative errors, and I am unable to assign the meteor a position which shall diminish the sum of the errors. The errors at Buffalo, Hud-

son, and Ann Arbor, are quite within the limits of the unavoidable errors of such observations. Those at Hanover and Clinton seem somewhat large, yet when it is remembered, that these measurements were not taken till more than a month after the meteor appeared, I think we must admit the possibility of errors of this magnitude. The assigned termination of the meteor's flight, rests upon the observations of Hanover, Clinton, Hudson, and Ann Arbor. The errors of the observations appear to be, Hanover  $+27'$ ; Clinton  $+2'$ ; Hudson  $+54'$ ; Ann Arbor  $-1^{\circ} 24'$ ; all of which are quite admissible.

The observations at Clinton make the meteor's first appearance S.  $13^{\circ} 25'$  W. I think it probable there is some mistake here, or if not, we must suppose the meteor to have been seen at Clinton much earlier than at any other station. At all events, it is impossible with this single observation to trace the meteor with confidence farther south than I have done.

It will be observed, that the three points in the meteor's path which I have above given, do not lie in a straight line. The middle point is more distant from the surface of the earth than either of the extremes by 2.7 miles, and allowing for the convexity of the earth, the total curvature in a vertical plane is about six miles. But the projection of the meteor's path upon a horizontal plane, deviates still more from a straight line. The curvature here amounts to forty one miles, the convexity being turned towards the east. We may suppose a part of this irregularity to arise from the errors of the observations, yet I think it well nigh certain, that the path was actually crooked.

Having thus deduced the meteor's path from the best observations, I proceed to inquire how these results accord with the remaining observations. A meteor was seen at Raymond, in the eastern part of New Hampshire, a little past 8 o'clock, on the evening of the 18th. It bore nearly west, at an elevation of from 5 to  $10^{\circ}$ , moved north westerly, descending rapidly towards the horizon. This description accords as nearly as could be expected with the position I have assigned the meteor. At Mount Upton, Chenango county, N. Y., "soon after sunset, on the evening of the 18th, a very brilliant meteor started from that part of the heavens which declines a little to the west or southwest from the point over head, and pursued its course about due N. W., disappearing behind the hills in that direction." According to my results, the meteor could not have been elevated much above fif-

teen degrees at this place, and if this observation were to be implicitly relied upon, we must infer that the meteor was higher than I have supposed, or that its path was farther to the east than I have assigned it. The language of the observation, however, is very vague, and I think it highly probable, that the observer never saw the meteor so high as his language would naturally imply, but inferred from its final direction that it must have originated in that quarter. At Carroll, Chautauque county, N. Y., a meteor was seen about dusk on the evening of the 18th. It appeared first in the east, elevated 25 or 30 degrees above the horizon, and disappeared in the north perhaps about  $5^{\circ}$  above the horizon. All this accords sufficiently well with my results. In one of the Canadian papers, the meteor is noticed as having been seen in various places, but the observations are too vague to be of the least value. I have received a vast number of observations from the counties of Ashtabula, Trumbull, Geauga, Portage, Cuyahoga, and Huron, all in the northeastern part of Ohio. The observations agree about as well as could be expected, if they had all been made from precisely the same station, with the exception that the most eastern observations assign the meteor somewhat the greatest altitude. The altitudes are almost without exception given too great, and commonly twice too great. The great variety of observations made in the vicinity of Hudson, although somewhat loose, must satisfy any one that the meteor was very distant and at a considerable elevation. No one can believe that a hundred different meteors, all of them of the most extraordinary kind, and characterized by the very same peculiarities, should appear at the same absolute instant, within a limited district, and all moving in such directions, and exhibiting such appearances as would be presented by one large, remote, and elevated meteor, while only a single meteor appeared to any one of the numerous observers. The case seems too plain for further argument.

I have now, as appears to me, assigned such a position to the meteor as reconciles all the observations within the limits of unavoidable error. This determination is liable to some uncertainty; yet I believe the uncertainty is not so great as materially to affect any theoretical conclusions to be deduced.

Let us now inquire for the velocity of the meteor, as referred to the earth's surface. The length of path seen at Hanover was 201 miles. The time of observation was estimated at eleven

seconds. This estimate is probably too great, yet it gives the velocity of the meteor 18 miles per second. At Clinton, the path observed was at least 218 miles, and the time was estimated at five seconds, making a velocity of 43 miles per second. The path observed at Buffalo was probably 112 miles, and the time was estimated from 4 to 5 seconds, which gives a velocity of 25 miles per second. At Hudson and Aurora, the path seen was about 218 miles, and the time estimated from 6 to 7 seconds, giving a velocity of 33 miles per second. These are the observations I think most to be relied upon; and the average velocity resulting from them, is 30 miles per second.

Let us now form some estimate of the magnitude of the meteor. Its diameter at Hanover was estimated at one fourth that of the moon, and its least distance was 281 miles. Its absolute diameter then was .65 mile. At Clinton, the meteor appeared very much elongated in the horizontal direction, and was followed by two smaller portions at intervals of less than a degree each. The breadth of the head was estimated at eight minutes, and its distance was 118 miles, which makes the absolute breadth .27 mile. The length of the principal portion was about one degree, that is, nearly two miles. The two smaller portions which followed in the rear, were about a tenth of a mile in diameter. At Buffalo, also, the meteor appeared elongated, its horizontal diameter being four or five times the vertical. Its least diameter was estimated at half that of the moon, and its distance being about 66 miles, its absolute breadth must have been .29 mile. Its length was four or five times this amount. At Hudson, its diameter was estimated at one third that of the moon, and being distant 226 miles, its absolute diameter was .66 mile. The observations made in other places agree substantially with the above, and from them we may infer, that the absolute diameter of the meteor was about three quarters of a mile. At the more distant stations, the meteor appeared nearly circular, but from the nearest points of observation, it appeared decidedly elongated. Almost all the observers noticed a falling off of various portions from the main body, which, lagging behind, formed a species of train. Several of these smaller portions formed a considerable fraction, perhaps one tenth part, of the main body itself.

This meteor must have consisted of matter exceedingly rare, and of very feeble cohesion. During nearly its entire route, new portions of matter were continually detaching themselves from

the main body, and this finally divided into a large number of fragments. We have, perhaps, no means of forming any precise estimate of its density, yet it is doubtful whether it exceeded that of atmospheric air. The light was, without doubt, produced by combustion. The meteor, by rapid motion through the upper regions of the air, generated heat sufficient to set itself on fire, and it was probably entirely consumed in the space of ten seconds. Nothing is learned to have fallen to the earth from the meteor, as would probably have been the case if its density had not been exceedingly feeble. Moreover, the appearances were those of a body entirely consumed by combustion. But a body, three quarters of a mile in diameter, entirely consumed in ten seconds, must be supposed exceedingly combustible and of very feeble density.

One of the points respecting which I solicited information, in my communication through the Cleveland papers, was, whether any noise attended the meteor. To this question most observers replied decidedly in the negative. Two persons only represent that they heard a noise. One observer in Ohio, states that his attention was attracted by the light, and a whizzing noise resembling the burning of a slow match of powder; and an observer in the State of New York, states the same fact. Now it would be altogether superfluous to give reasons for doubting the fact as thus stated, yet it is demonstrable that if such a noise was heard, it did not proceed from the meteor. At its nearest approach, the meteor was one hundred and sixty two miles distant from the first observer, and seventy six miles from the second. At the latter place, then, supposing, for simplicity, sound to travel at the same rate in rarefied as in dense air, the sound, if any, should have been heard about six minutes after the disappearance of the meteor, and at the former place more than twelve minutes. There was little opportunity therefore for one's attention to be attracted to the meteor by a whizzing noise proceeding from it. The noise alledged existed doubtless solely in the imagination. I by no means pronounce it impossible that sound may have come from the meteor; but if a report did follow, it would come after so long an interval, that few would think of attributing it to the meteor.

Let us now compare the direction of the meteor's path with that of the earth in its orbit. The point in space towards which the earth is moving is of course in the ecliptic, and nearly  $90^{\circ}$  west of the sun. At the time in question, it was about eight

o'clock in the evening where the meteor was vertical. The point then towards which the earth's motion was directed, had passed by nearly two hours the inferior meridian. The line of direction was inclined to the horizon about  $52^{\circ}$ , and its azimuth was somewhat east of north. The meteor's course was nearly north and parallel with the horizon. Its velocity was thirty miles per second; that of the earth 19 miles. The directions of the earth and meteor were inclined to each other about  $64^{\circ}$ , and the meteor's velocity of thirty miles was its velocity relatively to the earth. It is then simply a mathematical question to determine what must have been the absolute direction and velocity of the meteor's motion, in order that, combined with the earth's motion, it may give the above resultant. The velocity I find to be about forty miles per second. A part of this velocity, less however than seven miles, was due to the earth's attraction. We must then admit that a small collection of exceedingly rare matter, revolving about the sun in an orbit which at one point coincided nearly with that of the earth, but moving with about double the velocity, plunged into the earth's atmosphere, took fire, and exhibited the splendid phenomenon of May 18. That no portion of this body escaped from the earth's atmosphere and continued its solitary route, we cannot positively affirm; although the appearances seem to favor the supposition that the body was quite consumed in our atmosphere.

For the curvature of the meteor's path we can perhaps give only a hypothetical explanation. When a ball is moving with great velocity through the air, if one side be of such a form as to experience greater resistance than the opposite, it will be relatively retarded, and the path of the body will deviate towards that side. Now as it is highly improbable that the opposite sides of the meteor should be perfectly symmetrical, it might be expected to deviate more or less from a straight line. Moreover, the progress of the meteor was marked by combustion, which may be supposed to have been attended by a copious evolution of gas. Now if this gas should be evolved upon one side of the meteor more abundantly than on the other, it would become a moving force, which by reaction would cause the meteor to deviate to the opposite side. As these two causes appear to me highly probable, and adequate to account for the phenomenon, I think it superfluous to search for others. The earth's attraction would hardly produce the hundredth part of the deviation from a straight line



observed in a vertical plane, and no part of that observed in a horizontal plane.

The meteor whose phenomena I have thus attempted to analyze, although certainly very remarkable, was not unlike some others on record. In the London Philosophical Transactions for 1759, is an account of a meteor which appeared in Great Britain, Nov. 26, 1758. It moved in a direction N. W. by N., describing a path of about 400 miles. It shot obliquely downwards, being from 90 to 100 miles high at its origin, and from 26 to 32 at its termination. Its velocity was computed at 30 miles per second. Its diameter was estimated at certainly not less than half a mile, and probably greater. Its path deviated sensibly from a straight line, and a report, like a clap of thunder, was heard from it several minutes after the meteor disappeared. In the Philosophical Transactions for 1784, are several notices of a meteor seen in England, August 18, 1783. Its direction was nearly S. S. E. Its path was computed to have been at least 1000 miles in length, sensibly crooked, though nearly parallel with the surface of the earth, and elevated more than 50 miles. Its diameter was about half a mile, and velocity *not less than twenty miles per second*. A number of minutes after the meteor's disappearance, there was heard a rumbling noise like that of distant thunder. Both of these meteors broke into several fragments, which falling behind, formed a peculiar train. They appear to have been quite similar to the meteor of May 18th, and as the fact of a rumbling noise succeeding their appearance seems to be well attested in both cases, it is a little remarkable that nothing of the kind was noticed in the late meteor. It is doubtful, however, whether any observer watched long enough to be able to decide that no such report succeeded.

It may be useful to give here a summary of our knowledge respecting common shooting stars, that we may decide whether all these meteors are to be ranked in the same class. In the year 1798, Benzenberg and Brandes undertook in concert a series of observations on shooting stars near Göttingen, in Germany. They first took stations five and a half English miles from each other, at which they observed simultaneously several nights. After three nights' watching, finding their stations too near each other, they removed one of them to the distance of nine and a third English miles. On comparing their observations, they found twenty-two which had probably been seen at both stations, and of which they were able to compute the height for at least a part

of the course. The sum of the heights of 17 meteors at their disappearance was 973 English miles. The sum of the heights of 4 meteors at their origin was 199 miles; sum of the lengths of their paths, 162 miles. In 1823, Brandes, being then Professor at Breslau, resumed his observations in concert with a number of others, about twenty in all. A summary of their observations is given in Vol. xxviii of this Journal. The sum of the heights of 54 meteors at their disappearance was, according to these observations, 2761 miles. Sum of the heights of 45 meteors at origin, 2998 miles. Sum of 37 paths was 1619 miles.

In December, 1834, Mr. A. C. Twining and myself undertook a similar series of observations. We were not so successful as we expected to be; yet among the meteors observed, there were four whose paths we were able to compute. The sum of their heights at origin was 296 miles; at termination, 216 miles, and the sum of their paths, 142 miles. Finally, in Vol. xxvi of this Journal, Mr. Twining has given for one meteor the height of origin 73 miles, of termination 29.5 miles, length of path 55 miles. We have then, as the result of all these observations, the sum of the heights of 76 meteors at termination, 3975 miles, being an average height of 52 English miles. The sum of the heights of 54 meteors at origin is 3566 miles, giving an average of 66 miles. The sum of the paths of 46 meteors is 1977 miles, being an average of 43 miles. The average velocity of 13 meteors whose duration was estimated with some care, is 22 miles per second, and the velocities range from 11 miles to 36 miles per second. The size of shooting stars is very various, yet it appears that not unfrequently they have a diameter of a hundred feet.

From the preceding statements I think it will appear that the meteor of May 18th did not differ essentially from the ordinary shooting stars, with the exception of its magnitude. It appeared at about the same height, moved with a velocity no greater than is known sometimes to belong to common shooting stars, and exhibited the usual phenomena of combustion. I see then no reason for separating this meteor from the class of ordinary shooting stars, any more than a large hail-stone should be considered a phenomenon of a different kind from a small one. Shooting stars are well known to be celestial bodies, that is, to have an origin foreign from the earth; and it is no more strange that they should sometimes have a diameter of one mile, than that they should appear with a diameter of a hundred feet, or even of a single foot.

ART. III.—*Account of a Storm in New Hampshire, in a letter addressed to Prof. O. P. Hubbard, of Dartmouth College, and dated, Newport, Aug. 20th, 1838; by Rev. JOHN WOODS.*

*Dear Sir,*—IN yours of the 6th inst., you request me to forward you an account of a powerful tornado which occurred in Warner, some years since. The record which I made of it at the time, is not in a condition to be sent abroad; but by the aid of it, the newspaper accounts of the day, which I have preserved, and my own recollection, I can furnish a pretty correct narrative, which it will not be necessary you should return.

The event occurred about half past five o'clock, Saturday evening, September 9th, 1821. The wind, I suppose, was a proper whirlwind, precisely such as occasion water-spouts at sea. A very intelligent woman in Warner, who, at the distance of two or three miles, observed its progress, compared its appearance to a tin trumpet, the small end downward, also to a great elephant's trunk let down out of heaven, and moving majestically along. She remarked, that its appearance and motion gave her a strong impression of life. When it had reached the easterly part of the town, she said the lower end appeared to be taken up from the earth, and to bend around in a serpentine form, until it passed behind a black cloud and disappeared. Its course was south-easterly. It was attended with but little rain in some parts of its course, more in others. The rain, or what appeared like it, was in my opinion taken from bodies of water which it passed over. It was said, that it lowered the water in a small pond in Warner, about three feet. To people near Sunapee lake, in New London, I was told, it appeared as if the lake was rushing up towards heaven. The appearance of the cloud to beholders at a little distance, was awfully terrific. It commenced its desolating progress east of Grantham mountain, in Croydon. In Wardell, beside other buildings, it demolished a dwelling house, and carried a child who was asleep upon a bed, into Sunapee lake.\* In New London and Sutton it did considerable damage, but met with few dwelling houses and destroyed no lives. From Sut-

---

\* Mrs. Sarah J. Hale, editor of the *Lady's Book*, a native of this town, (Newport,) and then a resident here, I believe, has published a little poem on this fact, which I think you may be able to find among some of her writings.

ton it passed over the southwest branch or spur of Kearsarge mountain, with a gore of land belonging to Warner, called Kearsarge gore. At the foot of this mountain, it entirely demolished five barns, unroofed another, and utterly destroyed two dwelling houses and so rent another as to render it irreparable.

The houses wholly destroyed belonged to two brothers, Robert and Daniel Savary. They contained fourteen persons. In the house of the latter were three aged parents, seventy years old, I should think, or upwards. The old gentleman, as he saw the cloud coming, went into a chamber to close a window, and was there when the wind struck the house. He was carried four or five rods, dashed upon the rock, and instantly killed. A part of his brain was left upon the rock where he fell. His wife was very badly wounded, and it was thought would not recover. A child of Daniel Savary, in the same house, was also killed. In the house of Robert Savary, several were much wounded and bruised, but no lives lost. The houses and barns and other buildings at this place were not only levelled with the foundation, but the materials and contents were dashed in ten thousand pieces, and scattered in every direction. Carts, wagons, sleighs, ploughs, and sleds which were new and strong, (one ox-sled, I recollect, was entirely new,) were carried to a considerable distance—from twenty to sixty rods—and so broken and shattered as to be fit only for fuel. Stone walls were levelled, and rocks weighing two, three, or four hundred pounds, were turned out of their beds, apparently by the bare force of the wind. Large logs, also, two feet or more in diameter, which were bedded into the ground, and were fifty or sixty feet long, were not sufficiently weighty to retain their location. In one instance I recollect to have seen one large log lying upon another in such a condition, that it was thought by good judges, that ten yoke of oxen could not have moved the lower one from its bed; but both were removed by the wind several feet. An elm tree near where old Mr. Savary fell, which was one foot at least in diameter, and too strongly rooted to yield, was twisted like a withe to the ground, and lay prostrate across the path like a wilted weed. Not an apple or forest tree was left standing. One barn was seen to be taken up whole, with its contents of hay, grain, &c. After being carried several rods, it came to pieces, and flew like feathers in every direction.

From the neighborhood of the Savarys, it passed over another spur of the mountain, and fell with great violence on the buildings of Peter Flanders and Joseph True. Their houses, which were but a few rods distant, one in Warner, the other in Salisbury, were utterly demolished. In Mr. F.'s house were nine persons, two of whom were instantly killed. Mr. F. and wife were very badly wounded, but at length recovered. In Mr. T.'s house were seven, all of whom were most wonderfully preserved, except that two children, ten or twelve years old, were badly burnt by hot bricks, the oven having been heated and the bread then in it; one of whom lingered several weeks in extreme suffering and then died. The father and mother of Mrs. T., who lived about half a mile distant, were visiting there. They had just left the tea table. Mr. T. and his father-in-law went out at the door and saw the cloud, but thought at first they were so under the hill it would pass harmless over them. But they were soon convinced that its track was marked with desolation. Mr. T. just gave an alarm to his family, then ran under the end of his shop which happened to stand beyond the violence of the wind so as not to be demolished. His father-in-law, (Jones,) stood his ground until the wind struck the barn, a few rods to the northwest of him, and he saw the fragments of it flying thick in the air over his head. He then threw himself flat upon the ground by a heavy pile of wood. Instantly a rafter fell endwise close by him, entering the ground a foot or two in depth, and immediately a beam grazed down upon the rafter and lay at its feet. He and Mrs. T. were entirely unharmed. In a moment they saw, instead of a new and strong and very comfortable dwelling house, a perfect desolation. Not even a sill remained upon its foundation. Even the cellar stairs, and the hearths, which were of tile or brick eight inches square, were taken up and removed. The bricks of the chimney lay scattered along, partly covering Mrs. T., and covering to a considerable depth two of the children. Mrs. T. was soon taken up with but little injury. The shrieks and cries of the two children, under a weight of hot bricks, next pierced the heart of their father. In removing them, he burnt his hands to the bone. They were at length taken out alive, but in a state of great suffering, one of whom, as I have mentioned, after a few weeks, died. All were now found but the babe, about one year old. Supposing it to be under the bricks, Mr.

T. renewed his labor ; but soon it was heard to cry in the direction of the wind. Such as could run, ran in search of it, and soon found it lying safe upon the ground beneath a sleigh bottom, ten or fifteen rods from where the house had stood. The newspaper says one hundred rods, but this is incorrect. When the wind came, the sleigh was in the barn, six or eight rods north or northwesterly from the house. The two last mentioned houses were one story, well built, and well furnished dwellings. Their materials were not merely separated, but broken, splintered, reduced to kindling wood, and scattered like the chaff of the summer thrashing floors. It was the same with furniture, beds, bedding, bureaus, chairs, tables, and the like. A loom was, to appearance, carried whole about forty rods, and then dashed in pieces. The width of the desolation here was about twenty or twenty five rods. On the higher grounds over which it passed it was forty, fifty, or sixty rods. The deeper the valley, the narrower and *more violent* was the current. From the last mentioned neighborhood it passed on to the east part of Warner, but met with no other dwelling houses, and did but little damage, except to fences and forests. The appearance of the ground where it passed, was as if a mighty torrent had swept over it, up hill as well as down. Near the boundary, between Warner and Boscawen, the desolation ceased. It was taken up from the earth, but spruce floor boards, which were taken from New London, were borne upon its bosom and dropped in the Shaker village in Canterbury, a distance of about thirty miles. In following its track in Kearsarge gore, I came to a considerable stream of water, across which had been a bridge, covered with large oak logs, split in the middle, instead of planks. These half logs were scattered in every direction, some carried, I should think, ten rods in the direction from which the wind came,—others sixty rods in the direction it went, and others were dropped near the margin at the right and left. You will see by this, they were carried along by the whirl of the wind until they reached the circumference, and then fell to the ground.

Hundreds of people came from a distance of ten or twenty miles to view the scene of desolation. There were men of sound judgment from Concord, who gave it as their opinion, that it would have thrown down the massy walls of the State prison.

One remarkable fact is, that the same day, and about the same time in the day, two other similar whirlwinds were experienced, which moved in nearly parallel lines, one passing through Warwick, Massachusetts, and the other about the same distance to the northeast. They were both less violent; but one of them at least, the one through Warwick, did considerable damage. The particulars of the other I never had.

---

ART. IV.—*Notes on American Geology*; by T. A. CONRAD.

*Observations on characteristic Fossils, and upon a fall of Temperature in different geological epochs.*

It has sometimes been objected, that the value of organic remains, as a basis on which to build the superstructure of geological science, is lessened by the fact that certain species range throughout different formations; but these are far from being so numerous as is generally supposed. An instance never occurs in this country, where the species of one formation are continued into an upper one in such numbers as to cause the least perplexity or dispute regarding its geological age. All the various eras are admirably recorded, each by its peculiar group of animal or vegetable remains; and to him who has carefully studied them, they are quite as intelligible as if the hand of nature had arranged them in a cabinet for his use. The few species of a lower, discovered among those of an upper group, are not always to be regarded as contemporary with the latter, as some of them are clearly accidental. Every sedimentary stratum must have been derived from a rock previously formed, and of the first sedimentary rocks, originating in the destruction of primary masses, we, of course, take it for granted that such forms of animal and vegetable life originated in the ocean in which those sedimentary strata were deposited. But when these, disintegrated in their turn, have been, at a more recent period, swept by currents into other seas, we may expect to find occasionally, some few of the species which originally existed, carried with the debris, and thus mingled with a group very different from that with which they originated. It is true, that in the present state of our knowledge of

palæontology, we cannot say with absolute certainty, in every instance, which species originated with any given stratum above the first sedimentary rock ; but generally, shells, corals and plants, which have been continued from one epoch to another, were diminished greatly in numbers, as if the diminished temperature had been unsuited to their organization. I do not conceive it necessary, as M. Agassiz supposes, to infer that in every grand geological epoch, the fall of temperature was so great as to destroy every species existing at the time, but that some were, like the human frame, more capable of resisting the influence of cold than others. Among living testacea we find some species of a particular genus confined to the tropical seas, whilst others range from the tropics to the 42° of north latitude. The *Lucina divaricata* is a remarkable instance of this ability to endure great changes of temperature : originating, as it did, in the Eocene period, it lived in both those of the older and newer Pliocene, and now exists on the coasts of Europe and America, and inhabits the seas of the West Indies, and has been found as far north as Rhode Island.

We consider those fossils which most abound, when neither broken nor water-worn, to characterize the formation in which they occur, and such as are very rare, to be non-characteristic, or accidental, as they may have been introduced with the debris of rocks of an earlier date. Thus we find fragments of *Isotelus gigas* and *Calymene Blumenbachii* in the limestone shale at Rochester, N. Y., which rock has evidently been derived from the shales of the Trenton limestone formation, and thus fragments of the trilobites of the latter period were swept into the sea, where the shales at Rochester were in process of deposition ; and it is worthy of notice, that the current must have been very gentle, judging not only from the fine materials of the shale, but because it has carried only the lightest animal remains, as the thin crusts of trilobites, and rarely any of the small shells which abound in the Trenton shales. Another formation illustrates this fact in a still more satisfactory manner. At Upper Marlborough and Piscataway, in Maryland, a deposit of the Eocene period occurs, composed of the detritus of green sand, a material originating in the cretaceous epoch. One fossil of the latter formation, (*Gryphæa vomer*,\*) is not uncommon among the Eocene fossils.

---

\* *Ostrea lateralis*, Wilson.



This is at the same time the lightest and most indestructible of the cretaceous shells, and therefore the one most likely to be carried unbroken with the detritus of the green sand.

It is very evident that a change of the mean temperature of the crust of the globe has exerted a marked agency in the destruction of one group of animal life and the creation of another; and it may be owing to this cause, that the higher the organization, the more limited in the geological series are the fossil remains. Thus the *polyparia* have a higher range than the testacea, and the latter than the trilobites, whilst the *Eurypterus* is still more limited. The polyp, *Cyathophyllum ceratites* dates its existence with the lower portion of the Trenton series, or lower transition, and extends throughout all the calcareous formations above, even into the mountain or carboniferous limestone; but the *Eurypterus* is limited to a very insignificant portion of a single formation.

The fall of temperature has not, as some geologists supposed, taken place gradually since the creation of the globe; but every phenomenon in palæontology goes to prove the existence of a certain mean temperature during a long period, and a sudden diminution of heat at particular epochs.\* The change of groups of marine animals was not produced or accompanied by any convulsion, powerful enough to cause a violent rush of the oceanic waters, as the fossils of one period rest upon and even intermingle with those of an earlier date, as if both had lived and died on or near the spots where they are now found. The theory of periodical refrigeration alone can explain the sudden extinction of whole races of animals and vegetables. On the supposition that such change had resulted from uplifts, which to be reconciled with the facts, would necessarily have been sudden, a violent movement of the waters would have torn up the surface after such uplift, which has not been the case; besides, the uplifts would have been each extensive as the globe itself; an hypothesis at variance with all the phenomena which palæontology and the relative position of strata present to our daily observation. Uplifts in great numbers have taken place, and many of them were no doubt gradual, as must necessarily have been the case where they resulted from crystallization of the earth's crust: others have been sudden, produced by volcanic agency, giving rise to debacles, of which we

---

\* Agassiz, Edinburgh New Philosophical Journal, April, 1838.

find ample record in breccias, conglomerates, and coarse sandstones. But these formations record only the oscillations of the crust at particular periods, not marking the limits of any grand geological era, in which we recognize the fossilized remains of a peculiar group of marine plants and animals; and it is only by the study of such groups, that we are enabled to form a system of classification in strata, applicable to every region of the globe. The student of geology who has mastered all the rocks and fossils of England and Wales, limited as the sphere of observation may seem, will seldom be at a loss to recognize a fossiliferous formation as an old acquaintance, whether he may travel in China or Peru.

The fall of temperature (so happily illustrated by the genius of Agassiz) which occurred at the commencement of the "Diluvial epoch" is so well supported by all the known facts, that we feel no hesitation in applying the theory to all the inferior grand formations; indeed it gives us a clew to their obscure history, without which we should study them, hopeless of penetrating their mysteries, and believing their origin inaccessible to human investigation. The phenomena of the "diluvial epoch" have long attracted peculiar attention, from the many curious and highly interesting facts which they embrace, and the great difficulty of reconciling them with existing hypotheses. Enormous angular masses, transported perhaps a hundred miles from the parent rock, and reposing on sand or gravel which even a mill stream would have swept away, bid defiance to the mighty currents which so long flourished in the imaginations of certain geologists. Whence came these floods, and whither did they go? Such gigantic movements would soon have restored the equilibrium of the waters; and truly they should have been busy during their short reign on earth, to grind down mountains into sand, roll into smoothness myriads of siliceous pebbles, plough deep trenches in the solid rocks, and polish their surfaces with sand.

The boulders rest usually on sand, gravel, or the natural soil, which would necessarily have been swept away, had currents transported these huge fragments, leaving them in every instance reposing on indurated strata. The hypothesis of ice-floes bringing them from the north, floating on the waters of an ocean, and depositing them where they are now found, has been supported by some of the geologists of the present day; but this was in di-

rect opposition to another theory of these same geologists, that a higher mean temperature prevailed over the northern regions at that period, than now reigns in temperate climes. This would not have been the case, all other things being equal, if the northern half of the continent had been nearly all formed by the ocean, notwithstanding the mean temperature is greatly modified in the same parallel of latitude, by the presence or absence of large bodies of water, rising with the former and falling with the latter physical condition of the globe. Whence then this immense body of ice, which has scattered boulders over so vast a tract of country, appearing too at an epoch subsequent to the extinction of the *mastodon* and other mammalia, which evidently lived in this region and enjoyed an equatorial climate anterior to the icy period? Nothing can reconcile this apparent contradiction, but the admission of a fall of temperature far below that which prevails in our day, freezing the enormous lakes of that period, and converting them into immense glaciers, which probably continued undiminished during a long series of years. At the same time, elevations and depressions of the earth's surface were in progress, giving various degrees of inclination to the frozen surfaces of the lakes, down which boulders, sand and gravel would be impelled to great distances from the points of their origin. This in some cases might result from gravity alone; but in others, during the close of the epoch, when the temperature had risen, and avalanches began to descend from the mountain tops, and from numerous less elevated places, there occurred, on a vast scale, the same phenomena which now are familiar to the traveller among the Alps. Land slides, like that of one of the hills bordering the Saco river in New Hampshire, and avalanches of mud, filled with detritus of all sizes, some angular, as torn from the surface of the rocks, others having been rolled in the beds of torrents, would be propelled for many miles over the frozen lakes; and when the ice disappeared, sand, gravel, pebbles and boulders would lie promiscuously together. That a considerable elevation of land has occurred in some regions subsequent to one of the newest tertiary depositions, is certain, from the occurrence of shells of recent species two hundred feet above the level of the sea.

M. Agassiz attributes the polished surfaces of the rocks in Switzerland to the agency of ice, and the "diluvial scratches," as they

have been termed, to sand and pebbles which moving bodies of ice carried in their resistless course. In the same manner I would account for the polished surface of the rocks in Western New York. Running water, carrying sand, gravel, pebbles and boulders, to which cause this smooth appearance has been generally attributed, would not be likely to polish the surfaces of rocks; and moreover, where are those circular cavities, hollowed out by whirlpools, the invariable record of bodies of water moving with the velocity attributed to diluvial floods? I doubt whether any can be found on the polished surfaces of the rocks of the Alpine regions, or on the vast horizontal floors of Western New York. I never observed them in any place where evidence of ancient water-falls or rapids was not perfectly conclusive; and they are confined to valleys and the banks of existing streams. The scratches and grooves, Mr. Hall informs us, on the rocks bordering the Genesee river, have a direction N. N. E. and S. S. W., and they therefore probably follow the dip of the stratum, down which the ice moved. Nothing is more certain, than that the surface of the earth has risen unequally, or that two distant points have been uplifted at the same period, one rising to a greater height than the other, while the intermediate space was either stationary or depressed. If a glacier had previously occupied this area, the uplifts would have produced a synclinal line in the ice, and pebbles and boulders thus brought from opposite directions. Mr. Hall has noticed this phenomenon, but attributes it to the agency of opposing currents. He observes, "the presence, in the same locality, of boulders from the north with those from the south, proves that oppositè forces have prevailed either at the same or at different periods."\*

While granite boulders have been removed to surprising distances from the rocks in situ, those of transition limestone and sandstone seem never to have been far removed from the parent mass, a fact which harmonizes with the theory of refrigeration. The vast thickness of granite, and its corresponding uplift from the force of crystallization, has protruded its naked summits through the overlying strata, and from these peaks, rising to a great altitude, replete with parallel fissures, and split and rent by the upheaving power, large masses would necessarily fall, and

---

\* Geological Reports, 1838, p. 308.

when coming in contact with the surface of a glacier, however slightly inclined from the horizon, many of the boulders might of course traverse the extreme limit of the slope, and without losing their angular form; but the limestone fragments being imbedded in the bottom of the glacier would be only affected in position by contraction and expansion of the ice, and the more extensive movements caused by its breaking up in melting, which would have ample power to wear down the angles of these fragmentary rocks.

Occasionally I have seen the upper portions of limestones and sandstones broken up, a distance of several feet from the surface, but the fragments remain *in situ*. Now who can imagine such an appearance to result from a current of water? Floods, however violent, do not tear up the solid rocks in this manner, and if they did, how could these fragments have withstood their force and remained unmoved from their original position? Indeed, I think it impossible to account for this breaking up of the rocks to a distance of many feet below the surface, except by the agency of intense cold, freezing the water which filled the fissures, and thus forcing the rocks into tabular fragments, and disturbing their position by the lateral and upward pressure.

#### *Remarks on the Transition or Silurian System.*

The rocks constituting the Transition or Silurian system, have been much neglected by geologists, and yet in consequence of their embracing the remains of the first created beings, and affording us an insight into the earliest physical condition of the globe, they have peculiar attractions both for the reason and imagination: indeed, the facts are colored to the eye of inexperience with all the exaggeration of romance. If we only content ourselves patiently to investigate the organic remains, the more they are carefully studied do they gain in interest, and prove to be as readily classified as any of the later formations, notwithstanding their inclined position and disturbed stratification. Without such knowledge, every step will be embarrassed, and years of labor may be unprofitably devoted to the subject. An instance of error on the large scale may be observed in the second annual report of the geological exploration of Pennsylvania, where the graywacke of the Hudson river is confounded with a rock, somewhat similar, it is true, in mineral character, which abounds in

Oswego county and forms the banks of Salmon river. Not a single species of shells or plants is common to both. The former is highly inclined, and on its edges rests unconformably the calciferous sandrock of Eaton, then follows the sparry limerock of the same author, with some fossils peculiar to it; above that the limestones and shales of the Trenton series, several hundred feet thick, and then the Salmon river sandstone follows in the ascending order. This shows the great danger of error in endeavoring to identify strata over large areas, if we neglect to appeal to the evidence afforded by palæontology, and rely too exclusively upon the ever varying mineral composition of rocks, which it is obvious may present similar features in groups of widely different age.

The present grand undulations or inclined planes of the surface of the United States, considered in reference to their broader outlines, are owing to the position which the transition have been compelled to assume, by the unequal rise of primary chains. This has arisen from its vast aggregate thickness and enormous uninterrupted extent. Beginning, as it does, on the border of the Arctic sea, it extends, in some parts of its range, unbroken by granite peaks, quite to the center of Alabama, while it extends east and west, from the Appalachian chain to Engineer cantonment on the Missouri river. It, therefore, on a rough estimate, will be two thousand four hundred miles north and south by one thousand four hundred in extent east and west.

The upheaving force, acting over so vast an area, has only next the mountain chains greatly disturbed and inclined the strata, leaving the mass nearly horizontal to the eye, but rising and falling in enormously extended, slightly inclined planes and undulations. It is to the re-entering angles or synclinal lines of the planes that we owe the course of many of our large rivers. East of Little Falls on the Mohawk, that river runs many miles in a depression caused by the gentle dip of the strata on the north bank, and their gentle rise on the south. The St. Lawrence flows in a profound synclinal line, as may be seen by reference to Mr. Emmons' section in the New York geological reports for this year. Dr. Hildreth informs us, that the formations in Ohio dip towards the center of the valley of the Ohio river, and as they reappear at higher levels in Kentucky, there can be no doubt a synclinal line has determined the original course of that river.

These same formations extend through Indiana and Illinois to the Mississippi river, with a gentle southwest inclination; but as we ascend the Missouri, we find the strata rise with the elevation of the land, or slightly dipping to the east. Thus the Mississippi flows in a grand depression formed by the rise of the Appalachian chain on the east, and the Rocky Mountains on the west, a synclinal line, that for the enormous tract of country it occupies, and the vast extent of the two inclined planes of which it is the point of greatest depression, has no equal on the globe. To this fortunate geological feature of the country, we owe the gigantic scale of the rivers, sweeping thousands of miles through level and fertile regions, and offering to industry and enterprise sources of national wealth and prosperity, far surpassing any in the records of history.

The immense tract of country which lies between the Mississippi and the Rocky Mountains, owes its eastward inclination to the uplift of that chain, which has risen in the secondary and tertiary eras to a much greater elevation than the Appalachian range, and consequently raising the cretaceous formations, which abound high up the Missouri, to a much higher level than they attain on the Atlantic coast. This was caused solely by the rise of the Rocky Mountains, and not assisted by a depression along the eastern coast, as Elie de Beaumont supposes, because the occurrence of three tertiary deposits along that line proves, that so far from a depression having there taken place, the land has actually been upheaved, at the same time that the tertiary rose on the shore of the Pacific. This proves that the Appalachian and Rocky Mountain chains rose simultaneously to a certain degree in the upper tertiary era, and therefore it is not to a *see-saw* motion of the earth's crust that I would attribute the greater elevation of the cretaceous strata towards the Rocky Mountains, but to a more rapid uplift of that chain than has taken place in the Appalachian range. The greatest elevation of the latter during the upper tertiary period seems to have been between two hundred and three hundred feet, and this only in the northern part of the United States, as in the middle and southern States, this newest tertiary, which gives the maximum of elevation we have stated, does not attain more than ten or fifteen feet above the level of the sea. On the coast of California, Mr. Nuttall found shells of recent species two hundred feet above the sea. These

are so much more remote from the axis of elevation than the tertiary shells of New York, that the uplift of the Rocky Mountains must have been far greater during the upper tertiary period than was any part of the Atlantic chain.

I know not what reason can be given for considering the whole of the transition as one group, as Mr. Rogers has done, when with very few exceptions the inhabitants of the seas have been destroyed and new creatures succeeded at five distinct epochs, and one of these groups is no more to be compared with another, than is the oolite with the green sand formation; yet each of these belongs to a different group in all the systems of geology hitherto published. The term, lower secondary, applied by the same geologist to the transition system, is equally objectionable, as it has scarcely a single feature in common with what has hitherto been termed secondary by all other geologists, and constitutes an order, not a single series of strata linked together by palæontological affinities. The term, lower secondary, would be far more appropriately given to the strata comprising the magnesian limestone, lias, oolite, &c. as upper secondary has been generally used to designate the cretaceous group.

#### *Organic Remains of the Transition.*

No remains of reptiles, nor any impressions of the feet of birds or of reptiles, have been found in any of the trilobite rocks of the United States; but fucoids or marine plants abound in the sandstones, many of which have a digitate or trilobed form, and by the aid of the imagination could be readily converted into *ornithichnites*, or reptile trails. I am far from an intention to discredit the science established by Professor Hitchcock, as his descriptions apply to more recent strata than the transition, and which I have never studied, and his arguments are too ingenious for me to doubt; but I must be permitted to challenge his *ornithichnite*, of which even he is doubtful, in the graywacke of the Hudson river,\* one of the oldest transition rocks in New York, deposited at a period so early that scarcely any small islands dotted the boundless waste of waters, and they consisted of naked primary rocks, bearing neither herb nor animal life.

---

\* Mr. Hitchcock has nowhere maintained the existence of an *ornithichnite* in the graywacke of Hudson valley; he found an impression there, having some slight resemblance to the footmarks of the Connecticut valley, and he called this tetrapodichnite, expressing at the same time strong doubts whether it were a real footmark.—EDITORS.



Remains of fish and their coprolites are occasionally found in the middle and upper portions of the transition, but the most distinguishing feature in the palæontology of the system, are the trilobites in nearly all the strata; the vast proportion of Brachiopods among the testacea, consisting chiefly of the genera *Orthis*, *Detthyris*, and *Strophomena* or *LEPTÆNA*, in the limestones; gigantic quadrangular fucoids in the sandstones, and small linear leaf-like fucoids in the slates. These latter first appeared in the lower slates, where other organic remains are very rare, but occasionally trilobites and shells of the genus *Strophomena* have been found, a fact which induces me to believe that these two orders were twin-born of the primeval seas, and that they were preceded by vegetable life. Mr. Phillips, in his investigation of the English equivalents, has been led to a different conclusion; but England is a limited theatre for the display of the order of succession, which sinks into insignificance in comparison with the colossal development of the transition in North America. Mr. Phillips observes, "the classes of mollusca are more ancient than those of *zoophyta*, if we trust our present knowledge, and both older than marine or land plants."\* We have, it is true, as yet no knowledge of *zoophyta* in the lower slates, and therefore the *testacea* may be more ancient than they, but marine plants are older than either.

Among the brachiopodous bivalves, the genus *Strophomena* of Rafinesque is the most characteristic of the trilobite system. *Producta* has as yet been found only in the upper term, or pyritiferous rocks of Eaton, where the species are very few and rare. In the mountain limestone above, *Strophomena* is hardly known, but it is crowded with *Producta* of many species. The latter genus, therefore, eminently characterizes the carboniferous system, with which it ceased to exist. Not a single species of *Terebratula* occurs in the Silurian system of this country, nor have I seen one from the carboniferous; the shells hitherto classed in that genus being referrible to *Orthis*.

Throughout the transition, we very rarely find any evidence of fresh-water streams or lakes; which is doubtless owing to the very small proportion of dry land in those periods. The first trace of them in New York is in the red sandstone at Medina,

---

\* Treatise on Geology, p. 289.

in Orleans county. They seem to have existed in a small lake, in a basin of some primary island, which was finally drained off by no violent current into the sea. This lake probably occurred in Canada, since Mr. Hall has clearly proved that the current came from the north, bringing with it fine sand, and running over a bed of marine shells, (*Lingula cuneata*,) which were moored by their long peduncles in the sand, and therefore all range in one direction, nearly north and south, reminding one of boats riding at anchor in a strong tide.

I am unacquainted with any other trace of ancient fresh-water shells in the transition, except in the carboniferous system, where Unios are not uncommon; but it is remarkable that we do not find any which existed after this period, when there was so great an extent of dry land, especially in the tertiary epochs, except those which Dr. Hildreth discovered in Ohio. These consist of ferruginous casts of Unios, approximating in their forms to existing species of that region, and have every appearance of being of no older date than the upper tertiary; but it would be wrong to give a decided opinion of their age without further investigation of their relative position and analogy to existing types. Fresh-water shells, found in the calcareous deposits of modern lakes, and even where the water has disappeared, and the basins filled up with sand, covered by the soil and original forests of the country, all correspond with recent species living in the waters of the vicinity; and these marls, and even the monuments of filled up lakes, are common throughout the state of New York.

One of the most interesting features of the transition is derived from the ripple marks, which are generally most conspicuous on the sandstones, but occur also on the slates; one of the most beautiful examples of this action of the waters in shoal places upon the unconsolidated materials of rocks, may be seen at the slate quarry on the Delaware river above Easton. The stratum dips at a considerable angle. Such appearances are common in Europe, and have been noticed in New York, Pennsylvania, Virginia, and Ohio. They are records of the ancient condition of the globe, not easily misinterpreted. If there was scarcely any dry land at that period, it follows that the universal ocean was very shallow, its bed even, and the currents, except during the oscillations of the crust, by no means violent; hence, in their course over incoherent sand, they left their impress upon it so dis-

tinctly, that it is very easy to estimate the comparative force of currents on different strata by the larger or smaller undulations they have left behind. One can form an idea of the extent of one of these ancient floors of the ocean, when he sees the ripple marks, the same rock in mineral composition, and the same organic remains in Germany or Wales that he finds in New York; and can imagine how mighty a revolution the crust of the globe must have undergone to gain the vast depth of the Atlantic and the elevation of the Andes.

While on the subject of the transition, it may be useful to inquire into the relative position of a sandstone which seems at present little understood. It appears on the Hudson, near Newburg, and passes under the Palisadoes, reappears in New Jersey and Pennsylvania, following the course of the Delaware a distance of many miles, and disappears near Trenton, in New Jersey, where it rests unconformably upon gneiss. The color of this rock is generally red, very often with pale waved and concentric stripes; organic remains are very rare, one or two species of fucoids being all that I could find, and they differ from those of any other formation. This sandstone has sometimes been confounded with that of Western New York, a gross error, arising from its general resemblance to the latter. Mr. M'Clure regards it as a distinct formation, but terms it old red sandstone. It appears to me to be intimately connected with the Hudson river slaty graywacke, probably one passing into the other; but at all events it alternates with Eaton's calciferous sandrock near Easton, a character which identifies it at once with the Potsdam and Essex sandstone, described by Professor Emmons as occurring in the northeastern section of New York. In all cases it rests upon primary rocks and is the oldest of the fossiliferous formations, being under the calciferous sandrock, and occupying the same position in the geological series as the Cambrian system of Wales, described by Mr. Sedgwick. The copper mines of Flemington, in New Jersey, belong to this formation. The harder layers make excellent building stone, and of this rock the Penitentiary near Trenton is constructed. In New York it is one of the most common materials for door steps and basements, and it is occasionally used as a building material in Philadelphia, where it is brought down the Schuylkill river.

*Remarks by the Editors.*

In relation to the difference of opinion between Mr. Conrad and Prof. Henry D. Rogers, we take leave to state, that having been occasionally in communication on geological subjects with the last named gentleman, and knowing his opinions in the present case, we presume our much respected correspondent, Mr. Conrad, (with whose able communications this Journal has been, from time to time, enriched,) will be gratified to know the grounds on which Professor Rogers differs from him. Should that gentleman choose to give his own explanations, this Journal is, of course, open to his communications, and should Mr. Conrad wish it, to his rejoinder; but in the mean time, the public confidence in both gentlemen will be increased by being informed, that the peculiar opinions of each are sustained by appropriate and important reasons; and it is, moreover, very desirable, that our geologists should understand each other.

We proceed then to state, that Professor Rogers, as we have understood from himself, has examined, with considerable care, the localities designated by Professor Eaton, where the "graywacke of the Hudson" is said to be highly inclined, and to have the "calciferous sandrock" resting unconformably on its edges; and that he has left these places fully satisfied, that the strata, supposed to belong to two formations of distinct epochs, are, in reality, but adjacent beds of one great formation, differing in mineral character, and seeming, at first glance, to meet unconformably, in consequence of the numerous local irregularities of dip, so common to this rock on the Hudson. In other words, he regards the calciferous sandrock of Eaton, (the first formation of his report,) as every where lower in geological order, than this so called graywacke, which has been traced uninterrupted from the Hudson, through New York, New Jersey, Pennsylvania, and the States further South as far as Tennessee, every where occupying the *third* place in the ascending series.

He supposes he has evidence to show, that a geological section, corresponding with a line drawn from the mouth of the Susquehanna river, a little east of north, through Pennsylvania and New York, to the country of primary rocks, north of Utica, would represent the entire series of thirteen formations, described

in his report as occurring in exactly the same order, whether they are traced from the uppermost, (the anthracite coal formation,) southward, towards tide water, or northward, to the end of the section in New York; and in no instance, in either half of the line, was evidence observed of any want of conformity between adjacent strata. Such a section, where it crossed the Kittatinny Valley, would display the calciferous sandrock of Eaton, *underlying conformably* the metalliferous limerock of the same author, and this in turn underlying conformably the graywacke of the Hudson, while near its northern extremity it would exhibit the calciferous sandrock in conformable position below the limestone of Trenton Falls, and this again in similar relation, passing under the foundation of the Salmon river. That such is the state of things, Professor Rogers appears to feel satisfied from a careful study of the country around both the southern and northern ends of this supposed section. He therefore regards the so named graywacke of the Hudson as the same with the gray sandstone formation of Oswego county. He considers the argument based on the want of identity in the fossils as inconclusive, until it shall appear that a large number of species from each formation have been compared, and this because he places more confidence in conclusions drawn from following the rocks themselves over wide areas of country, (the only mode by which their true order of superposition can be first established,) than in inferences based upon the organic remains, the *true significance* of which can never be known until large groups of species are studied, and until the order of superposition of the strata, the very matter under discussion, shall have been previously settled by independent explorations.

ART. V.—*Magneto-Electric and Electro-Magnetic Apparatus and Experiments*; by CHARLES G. PAGE, M. D., Washington City.

FROM the splendor of the sparks, and the extreme intensity of shocks obtained from magnetic electrical instruments where the galvanic battery is used as a source of the magnetic power, the hope has been entertained by many, that such instruments, would prove valuable in a high degree as sources of electrolytic power. The present infantile state of the science, shows clearly the futility of such a hope, and points directly to an arrangement which will place in the hands of the operator an instrument surpassing entirely the great galvanic battery in value and power. Such an instrument is the magneto-electric machine. The instrument described in the last April\* number of this Journal demonstrates, by careful experiment with Faraday's volta-electrometer, that the electrolytic power of the current from the combined armatures is just double that of one. The avenue, then, to an indefinite power, is too obvious to escape notice. Increase the number of pairs of magnets, extend the series of armatures upon the same shaft, or in any way in which they may be brought to bear on the same terminal pole, and I hazard nothing in the assertion, that for the same prime cord, and contained in the same space, a magneto-electric instrument can be made of equal power to a galvanic battery of one thousand pairs of plates. It is evident, that there will not be that rapid diminution with the extension of the series which obtains in the galvanic arrangement, for in the magneto-electric machine the whole route of the current is through solid conductors, and in the galvanic battery, through a great extent of liquid and numerous soldered and imperfect joints. Nothing but the want of means has restrained me from erecting a magneto-electric machine, which I feel confident would rival the largest galvanic battery in existence. The arch of light would be obtained by disposing one set of armatures at right angles to the other, so that while one gave a diminishing current, the other would afford a current increasing in the same ratio; while one set was in the *neutral plane*, the other would be at the point of strongest action.

---

\* Vol. xxxiv, p. 163.

Having asserted thus much of the magneto-electric machine, it will be necessary to allude briefly to the objections to machines for electrolytic uses, where the galvanic battery is the *primum mobile*.

*First.*—The opposing currents produced by making and breaking the battery circuit cannot be separated, or rather cannot be united to form one current. In the magneto-electric machine, the alternating currents are made to flow in the same direction by the *pole changer*, or more properly in this connection, the *unitrep*. As it is desirable that every distinct and useful apparatus should have an appropriate name, I have selected the term *Unitrep*, as short, and descriptive of the use of this part of the magneto-electric machine. This important addition to the machine appears to be beyond simplification, consisting merely of two nearly half cylindrical pieces of metal, rivetted or secured in any manner to the circumference of a small disc of wood or ivory, and insulated from each other. Its use, as the name *Unitrep* implies, is to convert, or turn contrary currents into one common channel.

*Secondly.*—In the *galvanic* magneto-electrical machines, electro-chemical effects can be obtained (to any considerable degree) only by distinct impulses, occurring at each rupture of the circuit. These impulses or secondary currents closely resemble a common electrical discharge, and are of too short duration to allow the particles of the substances to be decomposed to assume definite polar arrangement. Nor can the circuit be broken rapidly to any advantage; for in the first place, the full magnetization of the iron requires appreciable time, and, secondly, the flowing of the secondary through a completed circuit, weakens itself by re-magnetizing the bar: (this will be spoken of in future.) In the *pure* magneto-electric machine, water is decomposed far more rapidly by the continuous current than by breaking the circuit, by the primitive than the secondary current. The secondary furnishes the most powerful shocks, but the primitive possesses the greatest decomposing power.

*Compound Electro-Magnet and Electrotome for Shocks,  
Sparks, &c.*

In the late numbers of Sturgeon's Annals, I notice that Mr. Bachoffner has introduced the bundle of wires as superior to the

solid bar for reaction upon the *coil wires*. Mr. Bachoffner probably used this compound arrangement before myself, as I made the discovery February 14th, 1838. Mr. Bachoffner remarks, "that it is necessary to insulate the wires of the bundle, and that it is difficult to understand their action, as the magnetic power is not so great as that of a solid bar." In every experiment hitherto tried, I have invariably found the magnetic power to be greater than that of a solid bar of the same weight. I have never found it necessary to insulate the wires to insure their operation, although I would not say that a very careful insulation might not improve their operation. For I apprehend that in the development and return of magnetic forces, electrical currents are excited in the body of the magnet at right angles to its axis, as well as in the wires surrounding the magnet. In this case the exterior portion of the magnet would act as a *closed circuit* upon the interior.

By a closed circuit is meant a *FLOWING* secondary current, which has the effect to re-magnetize the bar after the primitive battery current has ceased to act. That the operation of these *secondary closed circuits* has never yet been considered in the construction of machines, will appear from the following facts and practical observations:

*First.*—Enclosing a compound\* electro-magnet in a tube of metal, almost entirely prevents the formation of secondary currents in the exterior wires, although by this arrangement the magnetic power is not perceptibly affected, with the exception, that its development requires *more time*.† The short and complete right angle currents in the metallic casing have a greater magnetizing power than the secondary of an extended and oblique coil of wire. Hence, after the battery-current ceases, the chief portion of the secondary will flow in this short circuit, and the magnetism of the bar be prolonged to a perceptible degree, and if it were possible to break this *closed circuit* immediately after the battery circuit, a secondary and *tertiary* current would be observed from the coil of wire. This *tertiary* circuit I have perceived in another way.

---

\* Or a common single magnet.

† The increase of time necessary to effect the full development of magnetism, is due to the formation of the initial secondary flowing against the battery current.



*Secondly.*—Insulate the metallic casing from the magnet, and divide it throughout its length, so that the secondaries cannot pass, and the coil wire will now exhibit the full power of the secondary.

*Thirdly.*—Surround an electro-magnet with an entire metallic casing, *exterior* to the coil wires, and the secondary of the wires will be depreciated as before. Split the casing as before, and the secondary will again have full power.

*Fourthly.*—Brass rings or straps surrounding the poles of magnets or armatures for magneto-electric experiments, detract from their value by the action of *closed circuits*.

*Fifthly.*—The brass cheeks which are frequently used upon the armatures of magneto-electric machines for supporting the coil wires, materially impair the power of such machines. These cheeks should in all cases be made of wood, ivory, or some non-conducting substance.

*Sixthly.*—A metallic casing which entirely envelops a U magnet or armature, cannot convey closed circuits, as each half of the casing would transmit currents in opposite directions. Consequently, (as I have proved by repeated experiments,) the secondary of the coiled wire is not in the least impaired by this arrangement.

The following experiments were tried with a view to ascertain if electrical currents were excited in the body of the magnet itself. A hollow magnet was wound and tried; the secondary current was not so great as that from a solid bar of the same diameter. Singular as it might at first sight appear, the insertion or filling up of this hollow magnet with a rod of soft iron or a bundle of iron wires, did not in the least exalt the force of the secondary. This result accords exactly with that of a similar experiment by Mr. Bachoffner. I then rolled upon a cylinder of wood a piece of sheet iron, not permitting its edges to meet. It was then surrounded with three layers of coiled wire and tried, and the augmentation of the secondary was greater than that produced by the entire hollow magnet, which was of much thicker metal. But when the cylinder of wood was withdrawn, and its place supplied with a bundle of fine iron wires, the secondary was increased to a very great degree, and the whole appeared to be equally powerful with a compound magnet of the same size. It should be observed particularly, that when the

hollow magnet was *entire*, the insertion of an iron rod or bundle of wires produced no effect. From these experiments I think the existence of secondary currents flowing in the body of the magnet may be very plausibly inferred. If actually determined, the fact would prove important, and is well worth pursuing. I soldered two wires to the edges of the enclosed sheet of iron, and connected them with a galvanoscope, but could not perceive any effect upon the needle. But as the instrument was by no means delicate, the experiment may be regarded as valueless. Having no opportunities at present of pursuing the investigation, I hope that the subject may receive due attention from those who may be interested.

The following striking experiments afford still further illustration of the action of closed secondary circuits.

*Experiment 1st.*—Place a straight electro-magnet upon a large flat spiral of copper, in the direction of a radius of the spiral. When the spiral is connected with the battery, the magnet becomes charged, and a secondary current in its wires is the consequence. Break the battery connexion with the spiral, and examine by the common tests the power of the secondary from the magnet. Again, break the circuit from mercury covered with oil, and the secondary from the magnet will now be found stronger than in the first case. When the circuit is broken over clean mercury, the secondary flowing through the heated vapor and air, acts as a closed circuit to prolong the magnetism of the spiral, and thus prevent a sudden and entire influence upon the magnet. When the mercury is covered with oil the secondary is arrested, and the magnetism suddenly ceasing, exerts its whole influence upon the magnet, or rather the magnetism of the bar ceases with that of the spiral. The same phenomenon is well illustrated by the electro-magnet alone, where the fine wire is independent of the large.

*Experiment 2d.*—The reciprocal action of the closed circuit of the magnet itself upon the secondary of the spiral is more remarkable. Break the battery connexion with the spiral over clean mercury, when the ends of the wire on the magnet are disjoined, and observe the spark; join now the ends of the magnet wire, and on breaking the battery circuit the spark from the spiral will be diminished. The manner in which the closed circuit operates here, will be more easily understood from,

*Experiment 3d.*—Bring one extremity of the magnet used in the foregoing experiment in contact with one pole of the magnet of a common magneto-electric machine. As this disguises a portion of the magnetism, the amount of electricity developed by the revolution of the armature will of course be diminished. While working the machine the magnetic state of the electro-magnet will vary with the approximation and recession of the armature, and a current of electricity in its wires will be the consequence. When the current from the armature is broken or not suffered to flow at all, the current from the electro-magnet will be much stronger than when the circuit from the armature is constantly complete. When the armature is leaving the magnet, the flowing current or *closed circuit* magnetizes the armature and consequently disguises more of the power of the inducing magnet, than when the armature leaves without the closing of the circuit. The consequence is a detraction of magnetic power from the electro-magnet. Also, breaking the circuit from the armature under oil, increases the current from the electro-magnet.

*Experiment 4th.*—Join the ends of the wire coiled on one leg of the curved armature of a common magneto-electric machine, and allow the coil from the other leg to be connected with the break piece, as usual. As long as the circuit of the first coil is closed, the second coil will furnish scarcely any electricity; but when the circuit of the first coil is opened, the second furnishes nearly as much electricity as the combined current from both coils. This singular fact first called my attention to the great advantage of short, straight armatures, for the magneto-electric machine. Obviously, the best arrangement for straight armatures, would be that wherein they revolved between the ends of the magnetic poles, the axis or shaft being parallel to the legs of the magnets. The points gained by this plan would be, a more uniform and powerful current, and an exact division by the Uniprep of the semicircular routes through which the alternating currents are developed. In the machine described in Vol. xxxiv, p. 164, of this Journal, and in all others where the axis of motion is perpendicular to the plane of the magnet, if the two routes in which the opposite currents are developed be represented by two arcs of a circle drawn through the two neutral points, that are towards the bend of the magnet will be much the longer,

and represents a feebler current than the shorter arc. The only objection to this arrangement is the extra room it requires.

Figure 1.

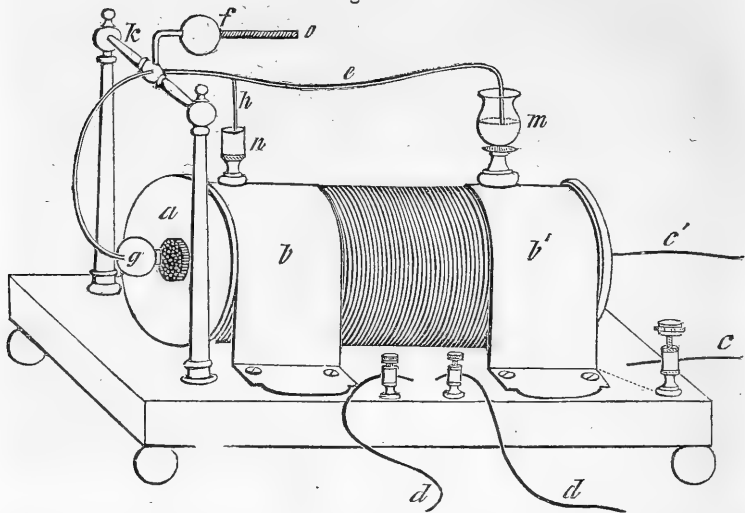

Figure 1, represents a new form of apparatus, consisting of a compound electro-magnet and electrotope; completed April, 1838. *a*, is an ivory cheek or head, through the center of which appear the extremities of the wires composing the magnet. *b*, *b'*, two brass straps confining the magnet to the base board. *c*, *c'*, the battery connexion for the large wires, which are terminally soldered to the cups with the binding screws, the soldered connexion being underneath the base board. *d*, *d*, are the fine wire terminations, the solderings being out of sight, underneath the base board. The movable part of the apparatus, *e*, *f*, *g*, *h*, *k*, is the electrotope. *e*, is a stout copper wire, passing through the shaft *k*. One extremity of this wire dips into the mercury cup, (*m*,) the top of which is of glass for exhibiting the spark; the base of brass is soldered to the brass strap *b'*. At the other extremity of *e*, is a small ball of iron, (*g*,) which, being attracted by the magnet, gives motion to the electrotope. It is proper to remark here, that the sphere of iron, *g*, is not attracted by the magnet with the same force as would be a piece of iron of ovoid form, or what would prove still better, a cylindrical piece, the length of whose axis was considerably greater than its diameter.

*h*, is a short piece of copper wire soldered to *e*, and descending into the mercury cup *n*, which is soldered to the brass strap *b*. The brass ball *f*, is movable on the projecting screw *o*, and serves as a regulator to the vibrations of the electrotome. The circuit traversed by the galvanic current is as follows. From the cup *c*, by the dotted line to the brass strap *b'*, thence through *m*, *e*, *h*, *n*, *b*, to one of the large wire terminations. The other termination of the large wires surrounding the magnet, is soldered to a cup connected with *c'*. When the galvanic circuit is completed, the magnet attracts the ball *g*, and raises *e* from *m*, producing a bright spark at *m*, and a powerful shock from *d*, *d*; *e*, then falls by its own weight, re-establishes the connexion, and thus the vibration continues. On the side of the ball *g*, towards the pole of the magnet, is fastened a piece of brass, or other non-magnetic substance, to prevent the adhesion of the ball to the magnet. The tips of the wires *h*, *m*, should be tinned before use. In all cases, tinning, or covering with soft solder the extremities of wires for connexions, and dipping them into mercury, will be found a much more preferable mode of amalgamating, than the usual practice of dipping them into nitrate of mercury, as they preserve their brightness a greater length of time.

### *Circular Galvanometers.*

Figures 2 and 3, represent two new forms of galvanometers, which are found to possess some advantages over other forms in common use. The whole appearance of this instrument, (though a trivial consideration,) is somewhat in its favor for purposes of general exhibition to a class. *a*, fig. 2, is the magnetic needle suspended by its centre on a fine point. The needle is made of watch spring, and bent into a form concentric with the coil *c*. The distance between the poles of the needle is about one sixteenth of an inch more than the width of the coil. The coil *c*, of insulated copper wire, is fastened by strong cement to the pillar *d*. *p*, *n*, are the terminations of the coil passing into the mercury cups on the stand. The coil is made of a number of strands of wire in lieu of a continuous wire. Galvanometer coils are usually made of too fine wire, and of a single wire of too great a length. M. Pouillet, in his late investigation of the general law of the intensity of currents, has shown that *derivation* made upon a primitive current from an elementary battery, strengthens

Figures 2 and 3.

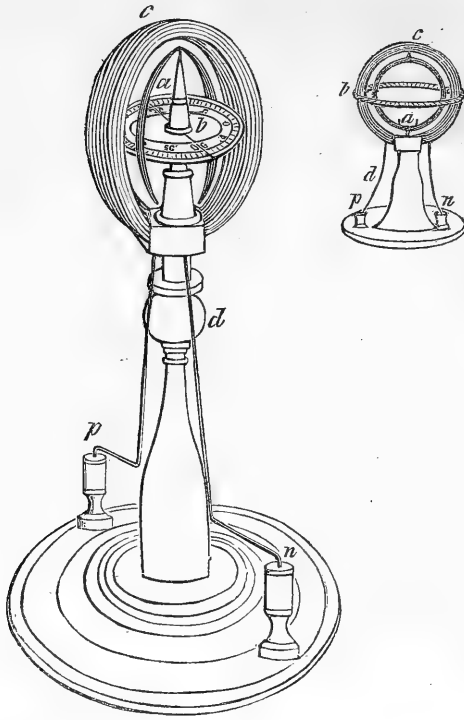
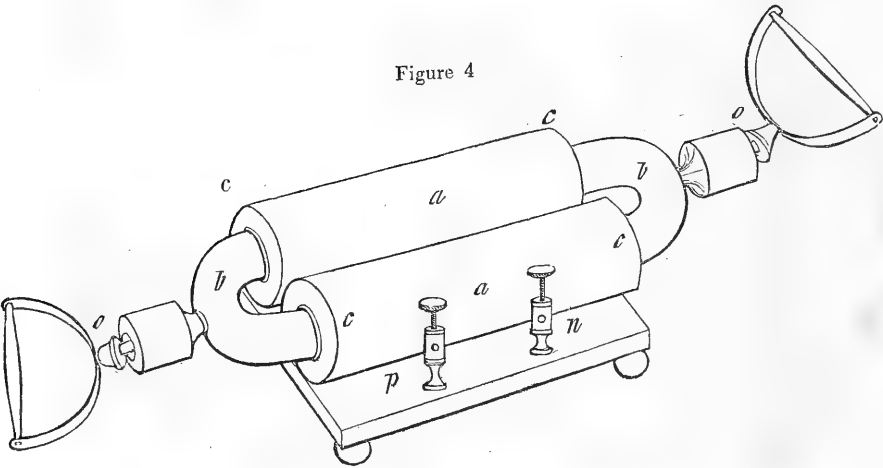

Figure 4



that primitive current. By derivation is meant, the addition of another wire to any portion of the primitive circuit. The simple solution of the fact is, that derivation, or the addition of another wire, increases the conducting power of the circuit. Professor J. Henry's discovery of the method of increasing the power of the electro-magnet by winding upon it several short coils of wire, is a most striking practical illustration of this law. M. Pouillet has also arrived at the conclusion, that the intensity of the current produced by a single element, is in an inverse proportion to the real length of the circuit. The adoption of the several strands in the galvanometer seems therefore to be plainly indicated, and experiment fully warrants it. *b*, fig. 2, is a graduated circle of ivory for marking the deviations of the needle. Since the construction of the instrument, fig. 2, I have adopted the plan represented in fig. 3, which is much to be preferred on account of its simplicity of construction, and the perfect steadiness of the needle. *c*, is the coil cemented upon the stand *d*; *b*, a graduated zone surrounding the coil. *p* and *n*, the wire terminations. *a*, the circular needle of watch spring, with a very delicate upper bearing at *c*, and a slender pivot at *a*, resting upon an agate centre cemented to the coil. As this needle is not liable to any mechanical displacement, it may come very near the coil *c*. The portion of the circle between the two lines at *a*, which bears the pivot, is of brass.

*Double Helix for Inducing Magnetism.*

Figure 4, represents an apparatus contrived January 11th, 1838, for exhibiting the magnetic forces of the centre of the helix. *a, a*, are the two helices of five layers of wire, protected by brass casings, (split on the under side,) and by ivory heads, *c, c, c, c*. *b, b*, are two curved bars of soft iron which slide readily into the helices. *o, o*, the handles for pulling, furnished with ball and socket joints at *o, o*, to prevent the magnets being twisted or wrenched. The wire terminations of the helices pass through the openings in the brass casings, underneath the base board, and are soldered to the screw cups *p, n*, for battery connexions. The attractive force manifested by this arrangement in the centre of the helices, is much greater than when an armature is applied at the extremities. A small apparatus of this kind will resist the strength of two stout men pulling by the handles. This makes a very pretty

arrangement for a reciprocating electro-magnetic engine, there being no change of poles, as the motion is effected by an arrangement shown in the two next figures. This form of engine will be described in a future article.

*Revolving Armature.*

Figure 5, represents an instrument invented in February, 1838, for exhibiting motion by magnetism without change of poles.

Figure 5.

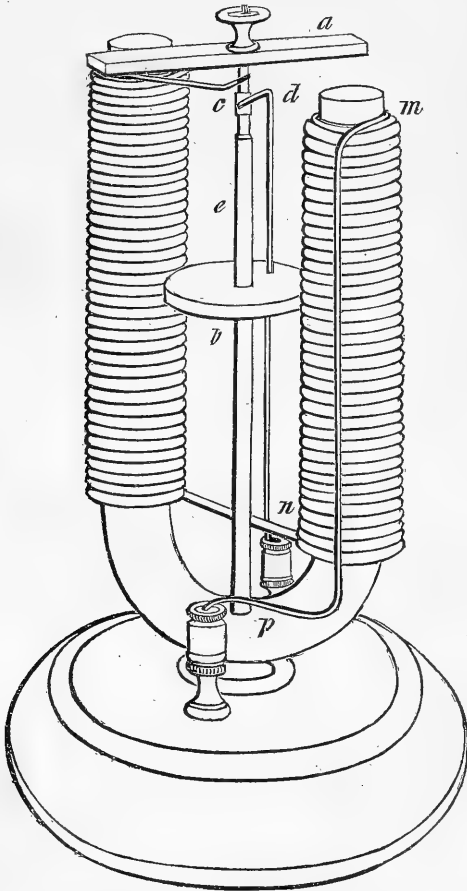

This instrument was the foundation of a series of experiments, made with reference to the mechanical application of magnetism, which will be published with drawings in a future communica-



tion. *m*, is the electro-magnet. *a*, the armature of soft iron. *e*, is an upright stem of brass, to receive and make the bearings of the shaft of the armature. *b*, is a disc of wood or ivory to brace the upright stem *e*. *c*, is one termination of the magnet coil, serving as a conducting spring. *d*, is the other conducting spring passing through the disc *b*, into the cup *n*, for battery connexion. The other termination of the magnet wires passes into the cup *p*. At *c*, *d*, firmly fixed to the shaft, is a cylindrical piece of silver, which may be technically called the *cut-off*, or electro-tome. The spring *c*, plays upon the whole portion of the *cut-off*. The spring *d*, plays upon the dissected part, whose metallic divisions are so arranged that they shall come into contact with the spring *d*, when the armature is a little inclined from right angles to the plane of the magnet, and leave spring *d*, before the armature arrives at equilibrium. This armature revolves much faster than would a magnet changing its poles. Besides the advantage of greater simplicity, the *revolving armature* possesses advantages which cannot be gained by change of poles, or by revolving magnets, where the power is only cut off without a change of poles. Suppose another electro-magnet to be placed at right angles to the magnet *m*, in the figure, and the cut-off so arranged that the two magnets shall be charged in succession by the revolution of the armature. The velocity of the armature will thus be nearly doubled without the addition of more battery, for the points of action are doubled, and only one magnet charged at a time. This same plan admits of enlargement on any scale, only with the alteration of the mode of revolution. If electro-magnetism should ever be introduced for small powers, such as turning lathes, &c. it probably will be effected by either the revolving or vibrating armature machines.

#### *Reciprocating Armature Engine.*

Figure 6, represents an electro-magnetic engine with vibrating or reciprocating armatures. *a*, *a*, are the electro-magnets, firmly secured to the base board and the wooden table *t*. *b*, *b*, are the armatures of soft iron connected with the shaft (*d*) by stout brass arms. The balance beam, connecting rods, and balance wheel, represented in the figure, require no particular description. The *cut-off* by which the magnets are alternately charged, is on the shaft of the balance wheel at *m*. It is simple in construction,

made of silver, and similar to the one described for the revolving armature. There are three conducting springs tipped with silver, one playing upon the whole portion, and two upon the dissected portion of the *cut-off*. The connexions of the magnet

Figure 6.

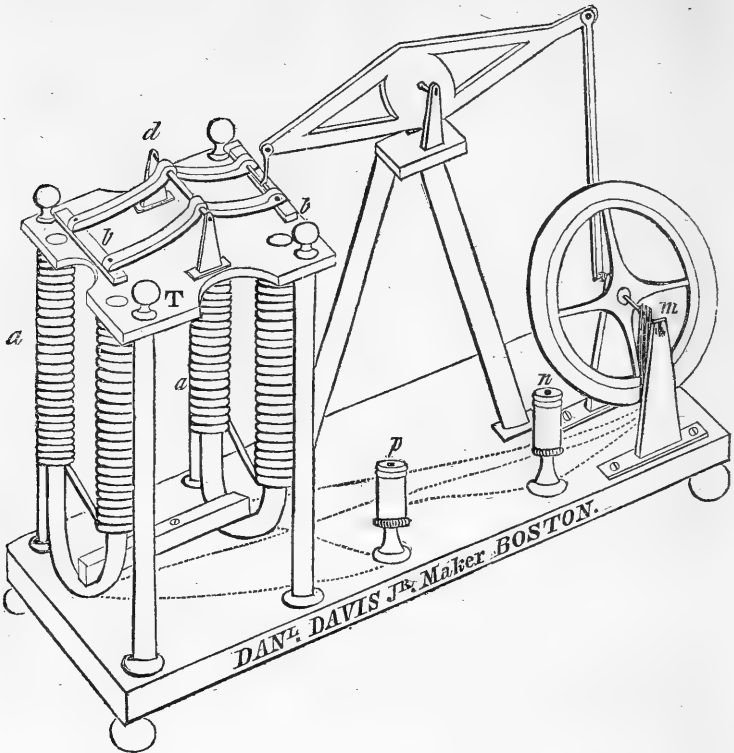

wires with the springs and cups *p*, *n*, for battery connexion, are made under the base boards, and are marked by the dotted lines. Several of these engines have been made by Mr. Daniel Davis, Jr., philosophical instrument maker, of Boston; and are beautiful working models. As a proof that electro-magnetism is susceptible of useful application where only a small power is wanted, a small engine was made by Mr. Davis in the month of July last, by the aid of which, an individual gains fifteen dollars per day by the simple operation of drilling the steel plates for gas burners. I think this may be considered the first instance in which

the mechanical application of electro-magnetism has been turned to profitable account. This engine is to undergo considerable alteration and improvement, when a description and drawing of it will be published.

That much remains yet to be determined concerning the most advantageous form and size of magnets and armatures, will appear from the following observations made during last October, while on a visit in Boston.

First: it is possible to present a piece of *soft iron* to the most powerful magnet in such a manner that it will not be attracted in the least by the magnet.

*Experiment.*—Drill a hole in the center of the pole of an electro or permanent magnet, to admit a small sliding rod of brass. To one end of this sliding rod, fasten a small disc of soft iron. The diameter of the disc must be less than that of the pole of the magnet, and the thickness or axis of the disc, must be considerably less than its own diameter. Put the sliding rod in its place, and if the disc of soft iron be exactly parallel to the face of the magnetic pole, it will not be attracted by it, be the magnet never so strong. If the disc is in the least inclined from parallelism, it will be attracted by the magnet. The experiment will appear more satisfactory if varied in the following manner. Place the disc of soft iron, with its sliding rod, in a frame, and place the magnet on a rest, so that its position can be varied; the same results will follow as before. Again: put the disc, without its sliding rod, on the center of a large magnetic pole, and it will slip down to the edge of the pole, and there adhere. Again: sprinkle iron filings on a piece of paper laid over the end of a bar magnet; the filings will cluster over the pole around a vacant space at its center. Again: drill out the disc of iron so as to make a ring, whose width is greater than its thickness, and present it to the magnet in the same manner as the disc, and the ring will be attracted by the magnet. It appears from this, that the disc, though magnetized by induction is polarized in a radial direction, and the forces counteract, or disguise each other's influence upon the magnetic pole. When the diameter of the disc is greater than that of the magnetic pole, there cannot be this counterpoise of forces. When the disc is inclined to the face of the magnetic pole, it becomes polarized in the direction of an oblique line, joining that part of the disc in contact with the

magnet, and that point most remote from the point of contact. These experiments throw some light upon a fact which, though long since known, does not seem to have been understood; viz. an armature which entirely subtends the poles of a U magnet, will not sustain so great a weight as one which covers only about one third of each pole. If the surface of the armature be flat, it will not be held so firmly as if spherical, presenting much fewer points. If the armature be flat and broad, that portion over the pole may be considered in the light of the soft iron disc. Numerous holes in an armature do not sensibly interfere with its adhesion. A piece of soft iron was first suspended from a single pole, with just as much weight as it would hold. It then had several large holes drilled through it, taking away a large portion of its substance, and was again tried; the induced magnetic power appeared to be as great as through the entire piece. This doubtless would not be true to any extent, although the properties of the armature are not perceptibly affected by a hole through its center, yet if a steel, or soft iron rod, be passed through this hole, its inductibility will be greatly impaired. This fact should be particularly observed in the construction of magneto-electric, and electro-magnetic machines, where a steel, or iron shaft, is often allowed to pass through an armature or magnet. If, while the armature is suspended by one end to a single pole, a piece of soft steel is drawn through the hole in its center, the steel becomes properly and permanently polarized; but if, while the armature is thus in contact with the magnet, the steel rod be passed half its length through the hole, and examined in that situation, both its extremities will be found to be similar poles.

In the management of electro-magnetic engines, it is worth observing here, that a greater power is always obtained by using a compound, instead of a single battery, provided the series does not exceed two. As the elementary battery has always been considered as possessing the greatest dynamic, or magnetic power, this species of battery has been preferred for application to electro-magnetic machines. I have invariably found that two pairs of plates, arranged as a compound series, connected with an electro-magnetic engine, or any apparatus for electro-magnetic rotations, produce a velocity nearly double that given by the same surface used as an elementary battery. If the series extend beyond two, the magnetizing power diminishes, although the sparks

at the break pieces are brighter. In all cases where motion is produced by the galvanic current, it must meet with considerable resistance, either from secondary currents or from the breaks in the circuit. The compound current probably has a greater velocity than an elementary current, and meets with less resistance from opposing secondaries and passing breaks.

*Vibrating Armature.*

Figure 7, represents a vibrating armature, to be used as an electrotome, in connexion with an apparatus affording sparks or shocks. *b*, is a small electro-magnet, (of the actual size given in

Figure 7.

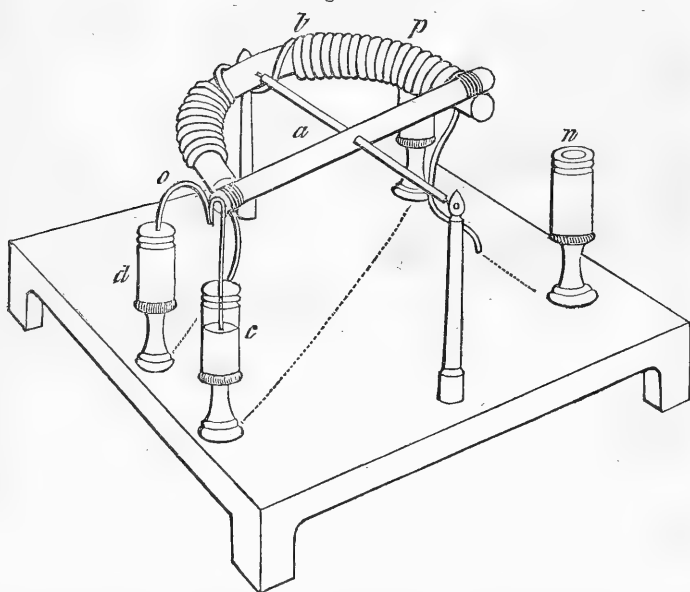

the figure,) and covered with only a single coil of wire, so as not to detract much from the power of the instrument with which it is used. *a*, a slender iron wire for an armature, suspended on a delicate shaft. *o*, is a connecting wire of copper fixed to one end of the armature, joining the mercury in the two cups *d* and *c*. *p* and *n*, are the terminal cups for connexions. The connexions between the cups and the ends of the magnet wire, are made under the base board, and marked by the dotted lines. The cup *c*, is of glass, or very thin ivory, to exhibit the illumination from

the spark. When the battery circuit is complete through the instrument, the end *o*, of the armature is raised by the magnet, the connexion is broken at *c*, and the end *o*, falls by its weight, again rises, thus giving a rapid succession of sparks at *c*. The extremities of the armature are wound with a little sewing silk, or thread, to prevent their retention by the magnet.

Washington, November 13th, 1838.

ART. VI.—*Description of some new Shells*; by BENJAMIN TAPPAN,  
Steubenville, Ohio.

PROF. SILLIMAN,—I send for publication in the Journal of Science the following descriptions of some shells found in Ohio, which are believed to be new.

“UNIO SAYII, *Ward*. Plate III. Fig. 1.

Shell sub-rhomboidal, inequilateral, transverse, compressed; valves thin, beaks slightly prominent and *divergingly* wrinkled; cardinal teeth oblique, *single* in the right and *double* in the left valve; lateral teeth *slightly* curved; nacre white.

Hab. Walnut creek and Ohio canal, near Circleville. W. H. Price. My cabinet; cabinets of Dr. Kirtland, R. Buchanan, Esq., B. Tappan, A. Binney, Esq., Dr. Gould, Dr. Jay, Col. Totten, &c., &c.

Diam. 1. Length 1.60. Breadth 2.80.

Shell inequilateral, transverse, sub-rhomboidal, compressed; posterior and superior margins rectilinear, basal margin curved, anterior margin regularly rounded. Valves thin, translucent. Beaks slightly prominent, incurved and *divergingly* wrinkled, placed near the anterior margin. Umbonal slope sub-carinate, carina somewhat elevated. Ligament long, narrow, nearly straight and partially concealed. Epidermis pale yellow, inclining to cupreous on the umbos; glabrous, with indistinct capillary rays of a lighter color extending over the whole disk; lines of growth black, and very distinct; two faintly impressed lines diverging from under the points of the beaks and extending to the posterior basal margin. Cardinal teeth very oblique, not prominent, single in the right and double in the left valve, slightly crenate; lateral teeth lamellar, slightly curved. Anterior cicatrices distinct, poste-

rior confluent, dorsal situated horizontally across the cavity of the beaks and distinct; cavity of the beaks shallow and rounded; nacre white, slightly iridescent over the entire surface of the valve, with faintly impressed striæ or rays diverging from the cavity of the beaks, and extending to the basal margin. Inhabitant unknown."

The above description is by Doct. Charles J. Ward, of Roscoe, Ohio.

"*PALUDINA HETEROSTROPHA*, *Kirtland*. Plate III. Fig. 2.

Sinistral, aperture more than half the length of the shell.

Shell sub-globose, ovate; spire depressed, apex generally truncate; whorls five; aperture ovate, with its superior extremity curved towards the body whorl, within bluish white; epidermis greenish horn color, usually coated with ferruginous clay. Length three quarters of an inch.

This shell frequently occurs in Mill and Yellow creeks, tributaries of the Mahoning river. I formerly considered it a mere variety of the *P. decisa* of Say; but on further examination find it to be specifically distinct. It never attains more than half the length of that species; its spire is never depressed, and it is always heterostrophal."

I am indebted to Doct. J. P. Kirtland for the foregoing description.

*PHYSA SAYII*, *nobis*. Plate III. Fig. 3.

Shell sinistral, ovate; color brownish yellow, or chestnut; whorls five; the first large, the others small, terminating in an acute dark brown apex; aperture large, four fifths of the length of the shell; translucent; length one inch, breadth seven tenths of an inch.

I first found this shell, May, 1837, in a small lake called Lake Pipin, which is situated about fifty rods from the Cuyahoga river, in Franklin township, Portage county, Ohio, (the same locality where was found the *Anodonta Pipiniana* of Lea.) All the shells of this species hitherto found were dead, although much time was spent in examining for live ones in May, 1837, and in June, 1838. A few only were found, and are in the cabinets of Mrs. Say, Doct. Kirtland, Doct. Ward, and myself.

The shell here published as the *Unio Sayii*, in honor of the first American conchologist, has been supposed by Mr. Lea to be "a middle aged *camptodon* of Say," and by Mr. Conrad and some others, to be the *declivis* of Say. Without entering into a minute comparison here, let those who have the *Unios camptodon* and *declivis* of Say and this shell, compare them with each other, and they will be compelled to agree that they are three distinct and well marked species. Those who have not the shells to compare, will arrive at the same conclusion, by a careful comparison of the drawings of the *declivis*, plate 35, of the American Conchology; of the *camptodon*, plate 42, of the same work; and the drawing, No. 1, herewith given: all by the same accurate and skillful hand. In general, the western conchologists adopt Mr. Lea's classification and nomenclature of the Naiades, with perhaps but one exception, the *mytiloides*, which they are not able to find in Rafinesque's MONOGRAPH. But in dissenting from his opinion in this instance, and calling the *Unio Sayii* a new and undescribed shell, the opinion of Dr. Ward is supported by all those conchologists; nor does it seem probable to them that Mr. Lea would have called it a *camptodon*, or Mr. Conrad and others a *declivis*, if they had carefully examined many specimens.

---

ART. VII.—*On the employment of Uvularia perfoliata as a remedy for Poisoned Wounds*; by BENJAMIN HORNER COATES, M. D., Senior physician to the Pennsylvania Hospital.

Read before the Philadelphia Academy of Natural Sciences, Aug. 14, 1838, as a communication, not intended for their Journal.

WHILE at Pottsville, in July, 1838, I was called upon to visit a girl about five years of age, alleged to have been bitten by a rattlesnake, but as it afterwards appeared, probably by a copper-head, (*Trigonocephalus contortrix*.) When I saw the patient, three hours had elapsed; but the parent, an intelligent man, stated that the pain produced by the bite had greatly abated under the application of a plant obtained from the forest, and applied bruised and moistened with salted vinegar. Although crushed, the plant appeared on inspection, to be the *Uvularia perfoliata*; and its identity was afterwards verified by fresh specimens obtained for me by a



gentleman attached to the Delaware coal company, but who has forbidden me to use his name. No other remedy of a nature calculated to diminish pain appeared to have been employed, unless a tight and hard ligature above the knee be considered such. This, however, appeared to me rather to increase than diminish the sufferings of the wounded individual. I apprehend, further, that the pain produced by the bite of a copper-head does not in general, terminate in so short a period as three hours, and that the amount of pain relieved exceeded that usually experienced from the application of cold and wet substances, as mud, &c. to envenomed stings. Under these circumstances, the case seemed to possess a certain weight in favor of the real usefulness of this antidote. The details of the narrative will be appended to the present notice.

The gentleman already alluded to, had known it to be previously employed in two cases with apparent success; in the first of which, it was applied by an old Indian to the bite of a rattlesnake near the shoulder of a boy.

I observe in the Medical Flora of Prof. Rafinesque, that the different species of *Uvularia*, particularly the *perfoliata* and *grandiflora*, are set down as "said to be equal to *Hieracium nervosum* [venosum] in bites of rattlesnakes;" and to the *Hieracium* he elsewhere (p. 228) gives a high character. I am ignorant from what sources Mr. Rafinesque derives his information relative to the powers of the *Uvularia*, unless it is from the following passages in Schœpf, p. 40: "*vis*,—maturans, aperiens: *usus*,—radix aquâ contusa ad vulnera Caudisonæ, aliaque vulnera et ulcera. Herbæ decoctum ad inflammationem oris, laryngis, tonsillarum." From its affinities, it may be reasonably supposed to possess active properties; Dr. Lindley placing it with *Veratrum*, *Helonias* and *Colchicum*, and Dr. Torrey, near *Medeola* and *Trillium*. When chewed, it afforded but little mucilage, with a bitterish taste, and produced a strong sialagogue effect, with a scarcely perceptible nausea.

Upon summing up this evidence I am induced to believe, that a certain degree of probability attaches to the ascription of remedial virtues to this plant in cases of envenomed wounds. If we add together the observations at Pottsville, the statements of Professor Rafinesque, and the botanical analogies, I can hardly feel willing to pass them by as unworthy of attention. We may further sug-

gest the expediency of making trials of analogous plants so widely diffused among us, and so easy to obtain in larger quantities, as *Veratrum viride*, and *Helonias lutea* and *dioica*.

Case.—Mount Carbon, July 22: 2, P. M. Called to visit S. B., five years old, said to have been bitten by a rattlesnake. Dr. Wetherill politely accompanied me. According to her father, she was walking with him three hours previously, picking whortleberries, when the father trod on a snake, which immediately bit the child. On being questioned, the persons present acknowledged that the serpent in question was less than three feet long, that they had not heard it rattle, and that they had not killed it, and therefore had no opportunity of examining its appearance. As the effects of the bite were violent, it was presumed that it was inflicted by a copper-head, (*Trigonocephalus contortrix*, of Dr. Holbrook,) which was the only snake known in the vicinity likely to combine the above conditions.

A company who walked to the spot two days after, found the body of a copper-head in a state of decay, which might easily be attained in such an interval. It had been, notwithstanding the above statements, killed by a blow across the back, and was furnishing a repast to a number of large black beetles, observed to gnaw the bodies of snakes.

A strip of white ash bark was bound firmly round the limb above the knee; and at some subsequent period, a quantity of *Uvularia perfoliata*, bruised with vinegar and salt, was applied round the vicinity of the bite. Under this treatment the wound, at first intensely painful, became quite free from pain unless touched. It continued to feel numb.

The limb was enormously distended with an œdematous swelling, extending as high as the ligature; masses of effused blood were visible, deeply seated in the top of the foot and in several parts of the leg, particularly at the middle of the fore part. The skin was white, shining, and cold. One puncture only was visible, situated about two inches above the instep, and surrounded by a dark red circle. I could only explain the appearance of a single puncture by supposing, that the snake struck the child while disordered in its movements by the pressure of the parent's foot.

A cup was sent for, but when obtained proved too large to adhere to the limb. Suction was made forcibly by the bowl of a tobacco-pipe for half an hour; at the end of which time, several

drops of blood had issued from the puncture, a little diluted with a serous fluid; and other blood had been effused from the indentation produced by the pipe, which was marked by a circular ecchymosis. We then discontinued the suction, fearing to disorganize the skin by its longer employment. Three doses of a strong and caustic aqua ammoniæ, amounting in all to about twenty drops, were given to the child, with milk; a paste of the same liquid with wheat flour, was applied over and around the wound, to the extent of about one and a quarter inches square. The ligature and *Uvularia* were continued.

At 4, P. M., the swelling was a little increased. No pain, however, was experienced when the part was not touched. The numbness was considerably increased, and the color much yellower. A slight increase of the frequency and volume of the pulse had taken place.

Continued applications. Gave five drops more of aqua ammoniæ.

6, P. M. Dr. Halberstadt met me at the house. Numbness and soreness abated. Color much more yellow; less redness; skin more opaque; swelling slightly increased. Coldness nearly as great. Omit ligature. Purge in the evening with salts.

9, P. M. Parents had continued the ligature through terror. Swelling, distress and restlessness increased.

Apprehended mortification. Ligature to be removed peremptorily.

23d. Ligature had been removed last evening. Patient had rested well. Cathartic had operated. Swelling diminished below the knee, but extended much nearer the body, beyond the mark of the ligature, to the terror of the parents. No fever. Ammoniacal paste had blistered smartly. Considered better. Poultice the blister with bread and milk. Continue *Uvularia* to uncovered parts. Sweat limb with hot vinegar steam.

Evening. Dr. Halberstadt informs me that the swelling did not visibly diminish, till the child was freely purged.

Wednesday, 25th: 5, A. M. Child runs about freely. No pain. Little inconvenience. Swelling greatly abated. Yellow color intense.

29th. Saw Dr. Halberstadt in Philadelphia. Child well.

With regard to the mortality of the bite of our venomous serpents, and the possibility of recovery from them by the unassisted

powers of nature, the facts which have occurred or been communicated to me, tend strongly to prove the correctness of the position, that death rarely, if ever, takes place from the direct effects of the bite in human adults. Thus, that which is ascertained by Fontana with so much labor in regard to the viper, and rendered so probable by Russell, as to the cobra de capello and other celebrated Indian serpents, seems likely to be also established in regard to our rattlesnakes. This would hardly have been expected from a comparison made by the last named author, who states that a rattlesnake in London killed a dog in two minutes; while the shortest period of time in which Dr. R. was able to produce that effect by his strongest cobras, was thirteen minutes, or a period six and a half times as long. Of our ten or twelve venomous serpents, it seems generally conceded, that the most powerful are the different species of *Crotalus*. Of these, Dr. McConnell, of Mauch Chunk, communicated to me eleven years since, that he had then attended no less than *seventeen* bites; not one of which had proved fatal. Since that period, the *Crotali* have become less numerous in the vicinity, from the increase of population. Dr. M'C. has however, within his momentary recollection, seen three or four more, and has never seen a death. Similar results were met with at Pottsville, by Dr. Halberstadt; and the popular recollections I heard came to the same account, with the exception of one statement, of which I did not learn the details, that a man had some time previously died in two minutes, of a bite. Most probably, in this last case, the poison was instilled into a vein. I observe, that Mr. Daudin alledges that this venom is extremely formidable in the south, but that its terrors are singularly exaggerated in the north. That the exaggeration may also be found in another latitude, may be alledged upon the authority of our distinguished countryman, Dr. Holbrook; as whose opinion I am authorized to state, that the poison of the rattlesnake is mortal to animals of the size of its prey; but very rarely, if ever, to man. To observations so extensive as those of the gentlemen I have named, the addition of two more cases could only be worth making, from a desire to enlarge as far as possible the number of cases from which inferences are to be drawn. I have seen two such out of Philadelphia,\* and both recovered.

---

\* After the above had been read to the Academy, William Hembel, Esq., favored me with a communication of so much interest, that, coming as it did from two

From these facts, it will be easy to explain the doubtful reputation of various remedies for the bites of our venomous serpents. Those enumerated by Daudin, seem to have been nearly all lost sight of by medical men and naturalists, with the exception of the *Hieracium venosum*. Perhaps most of our "snake roots," the *Aristolochia serpentaria*, *Polygala senega*, *Cimicifuga racemosa*, owe their cognomen to a similar source. Still, it was thought a duty to medical science to preserve and compare the apparent fact of the agency of a medicinal plant, to extend science and facilitate future inquiries. The appropriate method of treatment would seem to be nearly that pointed out by Fontana; viz. a moderately tight ligature, and suction, with some force and for a prolonged period. It must be conceded that the venom, unless removed by suction, is gradually absorbed into the general system; and that the real object of the ligature is not the impracticable purpose of preventing this, but that of allowing time enough for the gradual introduction of the poison by the capillaries, and its progressive removal by the emunctories. Finally, as two hours were found by Fontana to be sufficient with the viper, conjecture or analogy would probably allow us to consider our precautions against the rattlesnake as sufficient in six or seven hours. It will probably be still right for us to make further trial of antidotes; nor can any circumstance render useless, such varying treatment as the incidents of the case may call for in the mind of a discerning practitioner.

---

---

*ART. VIII.—An Account of the Proceedings of the Eighth Meeting of the British Association for the Advancement of Science.*

THE eighth meeting of this noble institution was held at Newcastle, during the week from the 20th to the 26th of August, 1838. The attendance was unusually large, and the interest excited was in no degree inferior to that exhibited on former occasions.

---

such high authorities, it appeared to form too valuable an addition to the statements in the text to justify omission. Mr. Hembel and the late Professor Benjamin Smith Barton, made inquiries of a considerable number of Indian chiefs of repute, whether the bite of the rattlesnake was ever mortal among the natives. The reply was uniform, "that it was never mortal, because they had antidotes." The comments already made are perhaps sufficient.

The London *Athenæum*, (Nos. 565—568,) contains a copious and excellent Report of the doings of the meeting. It is impossible, in the limits within which other claims upon our pages compel us to bring this article, to give more than a condensed summary of that Report. We shall of course be obliged to pass with a bare mention, many of the papers, and to abridge others more than we could wish. We shall endeavor to lay before our readers those topics which fall more particularly within the province of this Journal.

The financial concerns of the Association are highly prosperous. On the 31st of July, 1838, its property amounted to £6812 18s. 1d., viz. in books, £1000 7s. 6d., and in stocks and cash on hand, £5812 10s. 7d. During the year, £932 2s. 2d. were expended for the prosecution of various scientific investigations.

As heretofore, the meeting was distributed into independent sections, holding distinct daily sessions.

The next meeting of the Association will be held at Birmingham, during the month of August, 1839.

#### Section A. *Mathematical and Physical Science.*

It was reported to the section,

1. That the Committee appointed to represent to the Government the importance of reducing the *Greenwich Observations on the Moon*, had waited on the Chancellor of the Exchequer, and that the sum of £2000 had been appropriated for that purpose, which was placed at the disposal of the Astronomer Royal, who had undertaken to superintend the reductions.

2. That the reduction of the Stars, intended to form the *enlarged Catalogue of the Royal Astronomical Society*, was in progress;—and (3) also the reduction of the Stars in the *Histoire Céleste*.

4. That arrangements had been made and approved for the establishment of an *Observatory at Liverpool*, and would be carried into effect as soon as the necessary power could be obtained from Parliament.

#### *Lieut. Col. Reid on Redfield's Law of Storms.*

Lieut. Col. Reid, R. E. then read "A Report explaining the Progress made towards developing the Law of Storms, and a

Statement of what seems desirable should be farther done to advance our knowledge of the subject."

Col. Reid commenced by stating that he had long been convinced that the operations of the Deity in the workings of his providential care over his creatures, were governed by fixed laws, designed by incomprehensible wisdom, arranged by supreme power, and tending to the most benevolent ends. However irregular the tempest or the tornado might appear to the inobservant, yet our own day had seen some of the phenomena reduced to rule; and he doubted not soon to convince the Section that we were on the eve of advancing some steps farther towards this most desirable end. His attention had been first directed to the subject in 1831. He arrived on military service, at Barbadoes, just after the desolating hurricane of that year, which, in the short space of seven hours, destroyed 1477 persons on that island alone. He had been for two years and a half daily employed as an engineer officer amidst the ruined buildings, and was thus naturally led to the consideration of the phenomena of hurricanes. The first explanation which to him seemed reasonable, he found in a pamphlet by William C. Redfield, of New York, extracted from the *American Journal of Science*, a work much less known in this country than its value and great merits deserved. The northeast storms on the coast of America had attracted the attention of Franklin. He had been prevented, by one of these storms, from observing an eclipse of the moon at Philadelphia, which he was soon after astonished to find had been seen in Boston, although that town lay to the northeast of Philadelphia. This was a circumstance not to be lost on such an inquiring mind as Franklin's: he ascertained, upon inquiry, that the same northeast storm had not reached Boston for some hours after it had blown at Philadelphia; and that, although the wind blew from the northeast, yet the progress of the entire storm was from the southwest. He died, however, before he had made any further progress in this investigation.\* Col. Capper, of the East India Company's service, after having studied meteorological subjects for twenty years, in the Madras territory, published a work, in 1801, upon winds and monsoons, giving brief statements of their fatal effects, from Orme's *History of Hindustan*. In this

---

\* Franklin died in 1790, forty six years after he made this discovery.—Eds.

work he states his belief that hurricanes will be found to be great whirlwinds; and says, "it would not perhaps be a matter of great difficulty to ascertain the situation of a ship in a whirlwind, by observing the strength and changes of the wind. If the changes are *sudden*, and the wind violent, in all probability the ship must be near the center of the vortex of the whirlwind; whereas, if the wind blows a great length of time from the same point, and the changes are gradual, it may reasonably be supposed that the ship is near the extremity of it." In this conjecture respecting the nature of hurricanes, Col. Reid conceived Col. Capper to be decidedly right, and the conclusion he drew from it has stood the test of close examination. Mr. Redfield, following up the observation of Franklin, and though probably unacquainted with the views or opinions of Capper, ascertained that while the northeast storms were blowing on the shores of America, the wind was with equal violence blowing a southwest storm in the Atlantic. Tracking Franklin's storms from the southward, he found, throughout their course, that the wind on opposite sides of the shore over which the storm prevailed, blew in opposite directions, and that in fact, *the entire storm was a progressive whirlwind, and that all these whirlwinds revolved constantly in the same direction.* In a No. of the American Journal of Science, (for 1831,) Col. Reid found collected together many records of the same storms, and a chart on a very small scale, showing the progress of one. Strongly impressed with the conviction that Mr. Redfield's views were correct, he determined to verify them by making charts on a large scale, and laying down on them the different reports of the directions of the wind at points given in the American Journal of Science: and the more exactly this was done, the nearer was the approximation to the tracks of a progressive whirlwind.\* He then exhibited to the Section a volume,† containing eight charts on a large scale, of which the

---

\* Having, in consequence of our frequent intercourse with Mr. Redfield, been acquainted with the progress of his inquiries and discoveries, we may here state that the course adopted by Col. Reid, of plotting on a large chart, the various reports of a storm, had been employed many years previous; by Mr. R., and indeed led him to his most important conclusions. We may also mention that we are sure that Mr. R. has not to this day, seen Col. Capper's book, and that he was not aware of its existence until just before the reception of Col. Reid's work.—EDS.

† See a notice of this work, p. 183 of this volume.—EDS.



first and second chart contained the result of this part of the examination; and he explained how the arrows showing the direction of the wind at the several stations were all on the right hand side of the several circles flying from the south, while at the stations at the left hand, or towards the east of the chart, they were all coming from the north. After tracing a variety of storms in north latitudes, and being impressed with the regularity with which they appear to pass to the North Pole, and always revolved in the same direction, viz. opposite to the hands of a watch, or from the east round by the north, west, south and east,—he was led to conclude, that in accordance with the order of nature, storms in south latitudes would be found to revolve in a contrary direction to that which they take in the northern hemisphere. He earnestly sought for facts, to ascertain if this were the case, and had obtained much information confirmatory of the truth of the conjecture, before he was aware that Mr. Redfield had formed the same opinion. The general phenomena of these storms will be understood, if the storm, as a great whirlwind, be represented by a circle, whose center is made to progress along a curve, which generally approaches the parabolic, the circles expanding as they advance from the point at which the storm begins to be felt. He pointed out how his views were illustrated by the disastrous storm of 1809, experienced by the East India fleet, under the convoy of the *Culloden* line-of-battle ship, and the *Terpsichore* frigate, and four British men-of-war, which left the Cape of Good Hope, about the same time, intending to cruise about the Mauritius. Some of these vessels scudded and ran in the storm for days; some by lying-to, got almost immediately out of it, while others, by taking a wrong direction went into the heart of it, foundered, and were never heard of more; others, by sailing across the calm space, met the same storm in different parts of its progress and the wind blowing in opposite directions, and considered and spoke of it as two storms, which they encountered; while others, by cruising about within the bend of the curve, but, beyond the circle of the great whirl, escaped the storm altogether, which had been for days raging on all sides of them. This led him to draw the very important practical conclusion as to how a ship should act when she encountered a gale, so as to escape from it. By watching the mode of veering of the wind, the portion of a storm into which a ship is fall-

ing, may be ascertained; if the ship be then so manœuvred as that the wind shall veer aft instead of ahead, and the vessel is made to come up, instead of being allowed to break off, she will run out of the storm altogether; but, if the contrary course be taken, either through chance or ignorance, she goes right into

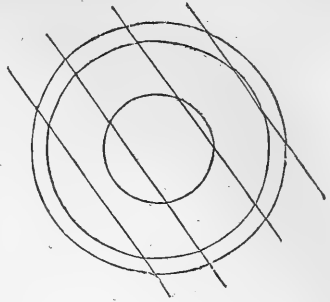

the whirl, and runs a great risk of being suddenly taken aback, but most assuredly will meet the opposite wind in passing out through the whirl. To accomplish her object, he showed, by a diagram,\* (as is above represented,) that it was necessary the ship should be laid on opposite tacks, on opposite sides of a storm, as may be understood by drawing a number of concentric circles to represent the whirl of the hurricane, and then different lines across these, to represent the course of ships entering into, or going through the storm; but to attempt the full explanation of even this, would extend much beyond our limits.

The apparent accordance of the force of storms with the law of magnetic intensity, as exhibited by Major Sabine's report, is remarkable. It had been frequently remarked that no storms occur at St. Helena. He had therefore felt much curiosity to know the degree of magnetic intensity there, and was not a little struck at finding it the lowest yet ascertained on the globe. Major Sabine's Isodynamic lines, to express less than unity, are only marked there, and they appear as it were to mark the true Pacific Ocean of the world. The lines of greatest intensity, on the contrary, seem to correspond with the localities of typhoons and hurricanes; for we find the meridian of the American magnetic pole passing not far from the Caribbean sea, and that of the Siberian pole through the China sea.

Prof. A. D. Bache, of Philadelphia, stated that he rose to thank Col. Reid, for the very handsome manner in which he had brought forward the theory of his countryman, Mr. Redfield.

---

\* A diagram similar to this, but in some respects more full and explicit, together with a discussion of the methods of escaping a storm, was given by Mr. Redfield in Vol. xxxi, p. 117, of this Journal.—EDS.

Having done this justice to one of his countrymen, Prof. B. remarked, that he was sure Col. Reid would follow it up by an examination of a rival theory of storms, by Mr. James P. Espy of Philadelphia. In this theory, the wind was supposed to blow in all directions towards the center of the storm; and a large collection of observations had been brought by Mr. Espy to form this point, especially those at his command from various quarters of the United States, as Chairman of the Committee of Meteorology of the American Philosophical Society, and the Franklin Institute. This theory, Prof. B. further remarked, was entirely in accordance with observations which he had made upon the track of a storm, popularly called a *tornado*, which passed over a portion of the State of New Jersey, in June, 1835. He had surveyed, by compass, different parts of this track, and found the objects thrown down by the storm directed towards a center. He had found no evidence of a whirling motion at the surface of the ground.

Sir J. F. W. Herschel, (the President of the Section,) having resigned the chair to Mr. Baily, addressed the audience, and hailed this communication of Col. Reid, as one of happy omen for the progress of science in this important branch; and congratulated the meeting that the subject had fallen into the hands of those who had already made such progress in its elucidation, and from whom it was likely to receive so complete a sifting. He did not rise at present to add any thing to the stock of information already given, but, as having received from Mr. Redfield his papers on this subject, he could not neglect the opportunity of publicly expressing his thanks, and of stating the great pleasure he had derived from their perusal. And here he found an anecdote of Franklin frequently pressed on his recollection. A blunt seafaring man had demanded from Franklin, or in his presence, what had been done for the advantage or security of sailors by any landsman. At least, replied Franklin, you must admit that a landsman had discovered the most useful *art of navigation*. It was not only at sea that the practical value of this splendid discovery respecting hurricanes would develop itself in enabling the sailor to escape its violence, instead of running ignorantly into the very jaws of destruction, by attempting to run away; but even on land, it would suggest invaluable hints for the securing of life and property. One or two circumstances connected

with Col. Reid's charts, particularly impressed him : the first was the curious parabolic shape of the courses denoting the progress of these storms, so well calculated to give unfailing directions as to the nature and course of a storm, when accidentally encountered at sea ; as the sailor had only to consider the parts of these curves in which he was placed, and the veering of the wind, and he had almost placed before him a chart of the hurricane. He next threw out the suggestion for Col. Reid's consideration, whether the Gulf-Stream would not perhaps give a clue to the direction of these curves, as so large a body of comparatively warm water must most materially tend to heat the air above it, and thus occasion disturbances of atmospheric equilibrium. Col. Reid had stated that he had no theory : in this no doubt he was judicious as an observer ; but yet, in the present assembly, a theory, if it served no better purpose, helped memory, suggested views, and was even useful by affording matter for controversy, which might produce brilliant results, by the very collision of intellect. In the second place, he remarked, that in the southern hemisphere, the oscillations of the barometer, which were in an opposite direction to those of the northern, afforded a strong confirmation of the correctness of Col. Reid's views. These revolving hurricanes reminded him, that on discharging a great gun unshotted, the mouth of which had been previously greased, a beautiful ring of smoke is formed, which passes to a considerable distance with much permanence, but constantly enlarging in diameter : upon attending closely to this, every part of the ring will be found to be in rapid revolving motion, thus exhibiting to the eye a hurricane in miniature, performing its evolutions. As to Mr. Espy's theory, though he considered it ingenious, yet he did not see how it was tenable against the indications of the barometer ; for, unquestionably, if a large body of air were to set on every side inwards, towards a central ascending column, the necessary effect would be an increase of weight of the entire barometric column : but there was even stronger evidence against it ; for if the air acquired any thing of a gyratory motion, on the principle of the *vis viva*, the rapidity of gyrations should increase enormously as we approach the center of the column ; just as we see the opera dancers, in the pirouette, increase the rapidity of the evolution as they diminish the circuit ; and so we find in the indications of the facts detailed by Col. Reid, regarding the hurri-

cane,—as the circles of its gyrations open and extend, the storm is progressing towards spending its fury, and disappearing. Although it did not bear directly on the question now under discussion, yet he could not help saying, that there are circumstances connected with the *spots on the sun*, which forcibly impressed his mind with the idea of *tornadoes in the solar atmosphere*, which, by scattering and opening out the luminous superficial matters, laid bare the opaque and dark mass beneath. It had at all times been a question with astronomers, how the spots were formed, supposing the luminous matter of the sun to be a merely superficial and uniformly spread stratum; but something like violent hurricanes being supposed to take place in the solar atmosphere, the difficulty is much diminished, if it did not entirely disappear; and in truth the appearance of the spots within the last year or two, was such as farther to induce the supposition of something in the solar atmosphere very like our trade-winds, for whereas, most usually, the spots have been scattered not very regularly over each hemisphere, they have latterly appeared more in lines following each other in succession, and having apparently an inclination towards the sun's equator on each side. If decided indications of any thing like trade-winds should, by this or other circumstances connected with the spots, be detected, the other conclusions would be much strengthened.

*Herschel's Astronomical Observations at the Cape of Good Hope.* These were reported under the following heads. 1. *Reduced Observations of 1232 Nebulæ and clusters of Stars, made in the years 1834, 5, 6, 7, 8, at the Cape of Good Hope with the 20-foot Reflector.* 2. *Reduced Observations of 1192 Double Stars of the Southern Hemisphere, made as above.* The observations in these two papers form parts of two catalogues of southern nebulæ and double stars respectively, which comprise the chief results of his astronomical observations at the Cape. They are complete only as far as the first nine hours of R. A. In the other hours, only a few of the objects which occur are added, being the results of a partial and very incomplete reduction of the observations in those hours. Sir. J. thought that when all the observations are reduced for the catalogues, the number of objects contained in them will be nearly doubled. The *first* catalogue contains all the numerous nebulæ and clusters comprised in the two Magellanic clouds. Each reduced observation expresses the

mean R. A. and North Polar distance of the object for the beginning of 1830, together with a description, in abbreviated language, of its appearance and physical peculiarities, as to size, brightness, condensation, &c. The observations of double stars in the *second* catalogue, express the mean place for the epoch above named,—the angle of position of the stars with the meridian, as micrometrically measured at the time of observation,—the estimated distance, and the magnitude assigned to each star, with a column of remarks, in which are noted peculiarities of color, &c.

3. *Micrometrical Measures of 407 principal Double Stars of the Southern Hemisphere, made at the Cape of Good Hope. with a 7-foot Achromatic Equatorial Telescope.* These measures were taken with the same achromatic and micrometer, and are arranged in precisely the same manner as the former similar observations made by Sir J., and printed in the *Trans. of Royal Astron. Society.* Among the principal double stars in this paper occur,  $\alpha$  Centauri,  $\alpha$  Crucis,  $\gamma$  Centauri,  $\gamma$  Lupi,  $\mu$  Lupi,  $\pi$  Lupi,  $\beta$  Hydræ,  $\varepsilon$  Chameleontis,  $\gamma$  Piscis volantis,  $\gamma$  Coronæ Australis, &c. These measures afford unequivocal evidence of rotation in some of these double stars, particularly in  $\alpha$  Centauri,  $\beta$  Hydræ,  $\gamma$  Coronæ, and  $\pi$  Lupi. In  $\alpha$  Centauri, the decrease of distance, even within the short period of observation, is remarkable; and Sir J. remarked, that on examining the catalogues of the Astron. Soc., and that of Capt. Johnston, and the Paramatta Catalogue, in all which, the places of the two stars are given separately, he finds this diminution of distance fully borne out and regularly progressive; from which he concludes that in 15 or 20 years from this time, the stars may be expected to appear in contact, or to be actually occulted one by the other, as has recently been observed to happen to  $\gamma$  Virginis.

4. *A list of the Approximate Places of 15 Planetary and Annular Nebulæ of the Southern Hemisphere, discovered with the 20-foot Reflector; with Drawings illustrative of the Appearance and structure of 3 principal Nebulæ in the Southern Hemisphere.* These are arranged in order of R. A. and numbered. Among these, several are somewhat elongated, and offer the appearance of being double. No. 7 is of a fine blue color, and being particularly well-defined, has exactly the aspect of a blue planet. No. 4 is a very bright and considerably large elliptic disc of uniform light, on which, but excentric, is placed a pretty large star. Several are very small; No. 15 is not more than 3"

or 4" in diameter. Many of them occur in crowded parts of the milky way, with not fewer than 80 or 100 stars in the field of view at once. The drawings are copies of much more elaborate originals, and merely selected from a greater collection, illustrating three of the most singularly constituted nebulæ in the S. Hemisphere, viz.  $\theta$  Orionis,  $\eta$  Argûs and 30 Doradûs. Sir J. explained how, by means of a small achromatic collimator placed inside his great sweeping telescope, he was able to obtain nearly the same precision as was to be had in fixed observations; although from the ropes and wooden frame with which it was mounted, it was subjected to great hygrometric and pyrometric changes of form and position. These changes, by affecting alike the cross of the collimator, and the object, were readily detected and corrected.—Dr. *Robinson*, spoke in praise of the accuracy of the positions given in Sir J. Herschel's catalogues; and in favor of the application of reflecting telescopes to divided instruments. Notwithstanding the great increase in late years, of the size of achromatics, it seemed improbable that they would ever reach a magnitude which could not be easily overmatched by reflection. Something to this effect had been done in Ireland. In his own observatory was a reflector of 15 inches aperture, applied to an equatorial of cast iron, which gave polar distances with a probable error of about 6 seconds, and right ascensions to the ultimate reading of the hour circle verniers. The artist who executed this, had since made a reflecting transit of six inches aperture, which performed well, and its collimator was not affected by reversion. Sir J. Herschel remarked that the only change in a nebula, which he had yet noticed, was in that of Orion. A small transverse strip, which, when he first figured that nebula, was straight, had become curved, and showed a knotty appearance, which certainly it did not possess before.

*Remarkable Phenomena of Halley's Comet.*—Sir J. Herschel related the following. One of the most interesting series of observations, I had to make at the Cape of Good Hope, was that of Halley's Comet. This comet is the great glory of modern calculation. To see the predicted return of such a body now verified for the second time, true to a single day,—nay, to a few hours—of his appointed time, after an absence of 75 or 76 years, during which it has been subjected to the unceasing perturbations of all the planets, and especially persecuted by Jupiter and Saturn,

those great stumbling blocks of comets, is really superb. However, what I have now to relate, refers to a very singular and instructive fact in its physical history. I saw the comet for the first time after its perihelion passage, on the night of January 25. Mr. Maclear saw it on the 24th. From this time we of course observed it regularly. Its appearance at first, was that of a round, well-defined disc, having near its center, a very small bright object exactly like a small comet, and surrounded by a faint nebula. This nebula, in two or three more nights, was absorbed into the disc, and disappeared entirely. Meanwhile the disc itself dilated with extraordinary rapidity, and by measuring its diameter at every favorable opportunity, and laying down the measures by a projected curve, I found the curve to be very nearly a straight line, indicating a uniform rate of increase; and by tracing back this line to its intersection with its axis, I was led, at the time, to this very singular conclusion,—viz. that on the 21st of January, at 2 h. p. m. the disc must have been a point,—or ought to have no magnitude at all! In other words, at that precise epoch some very remarkable change in the physical condition of the comet, must have commenced. Well! all this was speculation. But here comes the matter of fact I refer to, and which, observe, was communicated to me no longer ago than last month by the venerable Olbers, whom I visited in my passage through Bremen, and who was so good as to show me a letter he had just received from M. Boguslawski, Professor of Astronomy at Breslau, in which he states, that he had actually procured an observation of that comet on the night of the 21st of January. Well then, how *did* it appear?—why, as a star of the sixth magnitude,—a bright concentrated point, which showed no disc, with a magnifying power of 140! And that it actually *was* the comet, and no star, he satisfied himself, by turning his telescope on that point where he had seen it. It was gone! Moreover, he had taken care to secure, by actual observation, the place of the star he observed; that place agreed to exact precision with his computation; in short, *that star was the comet*. Now, I think this observation every way remarkable. First, it is remarkable for the fact, that M. Boguslawski was *able* to observe it at all on the 21st. This could not have been done, had he not been able to direct his telescope point-blank on the spot, by calculation, since it would have been impossible in any other way to have known



it from a star. And, in fact, it was this very thing which caused Maclear and myself to miss procuring earlier observations. I am sure that I must often have swept, with a night-glass, over the very spot where it stood in the mornings before sunrise. And never was astonishment greater than mine, at seeing it riding high in the sky, broadly visible to the naked eye, when pointed out to me by Mr. Maclear, who saw it with no less amazement on the 24th. The next remarkable feature, is the enormously rapid rate of dilatation of the disc, and the absorption into it of all trace of the surrounding nebula. Another, is the interior cometic nucleus. All these phenomena, while they contradict every other hypothesis that has ever been advanced, so far as I can see, are quite in accordance with a theory on the subject, which I suggested on the occasion of some observations on Biela's comet,—a theory which sets out from the analogy of the precipitation of mists and dews from a state of transparent vapor on the abstraction of heat. It appears to me, that the nucleus and grosser parts of the comet, must have been entirely evaporated during its perihelion, and re-precipitated during its recess from the sun, as it came into a colder region; and that the first moment of this precipitation was precisely that I have pointed out as the limit of the existence of the disc,—viz. on the 21st of January, 1836, at 2 P. M., or perhaps an hour or two later.

Rev. W. Whewell's *Account of a Level line measured from the Bristol Channel to the English Channel, during the years 1837-8, by Mr. Bunt, under the direction of a Committee of the British Association*, was read, the result of which is, that in July, 1838, the sea level at Portishead, (near Bristol,) was found to be ten inches higher than that at Axmouth; according to which, the mean level at Wick Rocks is 3.8 inches higher than at Portishead.

Prof. A. D. Bache, of Philadelphia, then communicated a "*Note on the effect of Deflected Currents of Air on the quantity of Rain collected by a Rain-gauge*," the more remarkable phenomena noticed in it being represented by diagrams. Prof. Phillips's first Report on the quantity of rain collected at different heights, induced Prof. B. to begin a series of observations near the end of 1833. Philadelphia, from the extent of the plain on which it stands, was thought a good locality for this purpose. At first, gauges were placed at three different heights. One station was

the top of a shot-tower 162 feet high; another was near the ground within the enclosure about the tower; and the intermediate one was the roof of the University. His attention was however ultimately fixed upon the fact that the effect of eddy winds upon the observed phenomena, was by no means a secondary one in amount, and that no law could be deduced, until this disturbing action was prevented. Prof. B. proceeded to make experiments on the effects upon the rain-gauges of the currents of air deflected by the tower, placing gauges at each angle. The results are given in a table, from which it appears that—1. The quantities of rain collected at the different angles of the tower were very different. In one extreme case the quantity collected at the S. E. angle was  $2\frac{1}{3}$  times that at the N. W. angle. 2. In general, the gauges to leeward received more rain than those to windward. Prof. Stevelly considered the fact that less rain was caught in elevated gauges than in those near the earth, to be due to the greater perpendicularity with which the rain falls near the ground, and not to a continued enlargement of the drops, during their descent, by new accessions of condensed moisture.

Dr. Daubeny read a paper on *the Climate of North America*. He began by observing, that although the general fact was admitted that the E. portions of the New World had a lower temperature than the W. portions of the Old, yet much remains to be done before the relative climate of these two portions of the globe can be regarded as in any degree determined. Most of the North American observations were not sufficiently accurate. In Canada, Mr. McCord's observations at Montreal were the best; and in the U. S., those made in N. Y., and published by the Regents of the University of that State. These results are however defective, in not giving the intensity of solar radiation, which probably affects the distribution of plants and animals in a manner quite distinct from its accompanying temperature. Hence, though many plants which grow in this country are killed by the winters of comparatively southern latitudes in America; yet others, which require the warmth of a wall or of a southern aspect here, are found in comparatively high latitudes in the New World. Sir D. Brewster called attention to the important fact, clearly established by the observations recorded in the neighborhood of New York, and those of Hansteen and Erman in Siberia, that two points of maximum cold existed in these

regions, very generally agreeing in position with the centers of maximum magnetic intensities; and like them, too, the maximum of North America indicated a decidedly higher degree of cold than that which characterized the Siberian pole. Also, that the lines of equal mean temperature, as they surrounded these poles, had such a relation to the lines of equal magnetic intensity, as to point out clearly some yet unknown connexion between these two classes of phenomena. Prof. Bache, of Philadelphia, made some remarks on the importance of connecting the observations making in the U. S. with any which the Association might institute in the British Colonies in North America. Considerable progress had, within a few years, been made in America in the science of Meteorology. The abstracts of the reports of Meteorological observations from the academies of the State of New York, and the deductions made from them by Sir D. Brewster, had been a great stimulus to increased activity in that department. The recommendations of Sir John Herschel, had not only been adopted by individuals, but had led to the formation of societies for the cultivation of meteorology. He hazarded nothing in promising the hearty concurrence of meteorologists in the United States in any extensive plan which the British Association should sanction.

A paper from Prof. Powell followed, *On some points connected with the Theory of Light.*

Mr. Dent then read a paper *On the Construction of a portable Mercurial Pendulum, accompanied by Experiments.* The cistern is made entirely of cast-iron: the adoption of which metal permitted the cistern to be turned perfectly cylindrical within and without, and of thus simplifying the elements of calculation for the height of a perfect cylinder of mercury requisite for compensating the effects of variable temperature on the rod, an advantage which glass did not allow. The homogeneity of the material also facilitates the reductions for temperature, by equalizing this throughout, and also permits the bearings to be diminished in number, and simplified in construction, when compared with the usual mercurial pendulum having glass cisterns. The suspending rod passes through a hollow screw, and is secured by a pin going through both. The hollow screw passes through the axis of the cistern, and the cistern is constructed to move round this screw, which admits of shortening or lengthening the pen-

dulum for alteration in time. The edge of the cap belonging to the cistern is graduated, which subdivides the threads of the screw on the cistern, it being turned round for alteration in time. There is an aperture on the top of the jar, which allows of mercury being added or removed without unscrewing the cap of the cistern. This aperture is closed by a screw, which, as well as that on the cap, has a leathern collar to render the joints perfectly air-tight.

Prof. Whewell made a "*Report on the Discussions of Tides*, performed under his direction, by means of the grant of money made for the purpose by the Association." Prof. W. remarked, that he had adopted the method of curves, first systematically employed by Sir J. Herschel, which consists in laying down a number of points expressing the results of individual observations, and then getting rid of the irregularities which these involve, by drawing, not a line *joining* the points, which would be a broken line, but by striking with a bold but firm hand, a line *among* the points, so as to come as near as possible to the whole assemblage of them. In this manner the heights and lunitidal intervals were laid down as ordinates, and curves were drawn. This method of curves depends upon the fact, that the eye generalizes the relations of space more rapidly and surely than the intellect can generalize phenomena in any other way.

Mr. Russell, of Edinburgh, brought up the "*Report of the Committee* (consisting of Sir John Robison and himself) *on Waves*." This report was a continuation of that of last year, recently published. These researches are of great value and interest, but it is scarcely possible to condense the account. We give merely some remarks on the best forms for ships. One part of his subject was the relation which the translation-wave bore to the phenomena of resistance of fluids. He had previously ascertained that the displacement of a fluid by a vessel took place, not in the body of the current, but solely by the generation of waves. Now, the manner in which they were generated appeared to throw light upon the subject of the resistance of fluids; because they wished to have exactly the same transference for particles of matter which was required for transference of waves. They wished to remove the particles of fluid from a state of rest, and admit the vessel to pass through, and then allow them to return to their former places, just as in the wave the particles were

first elevated above the surface, and then permitted to subside. Now they found that whenever the displacement took place, as in the wave, they had the phenomena of least resistance. So that in forming a floating vessel with this wave-line disposed on alternate sides of the keel, so as to give such motion to the particles as to displace nothing more than was necessary, nor for a greater distance than was necessary to allow the vessel to pass, they obtained the solid of least resistance. Since that time, a variety of experiments on large vessels had been performed; steam-vessels were now constructing on this form; and it was a remarkable fact, that the fastest vessel on the Thames was one to which this form had been given. It was scarcely credible, that a vessel should move at the rate of fifteen miles an hour, and not raise a spray,—not raise anything like that high mass of water which was always found at the bows of vessels going at speed, but enter the water perfectly smooth, and leave it smooth, and as much at rest in the direction of the displacement as it was before the floating solid passed. This phenomenon had invariably accompanied all the vessels formed on this line.

*On some Preparations of the Eye*, by Dr. W. Clay Wallace. Sir D. Brewster exhibited a series of beautiful preparations of the eye, made by Dr. W. Clay Wallace, an able oculist in New York, calculated to establish some important points in the theory of vision. As no paper accompanied these preparations, Sir D. Brewster explained to the meeting their general nature and importance. Dr. Wallace, he stated, considers that he has discovered the apparatus by which the eye is adjusted to different distances. This adjustment is, he conceives, effected in two ways,—in eyes, which have *spherical lenses*, it is produced by a *falciform*, or hook-shaped muscle attached only to one side of the lens, which by its construction brings the crystalline lens nearer the retina. In this case, it is obvious that the lens will have a slight motion of rotation, and that the diameter, which was in the axis of vision previous to the contraction of the muscle, will be moved out of that axis after the adjustment, so that at different distances of the lens from the retina, different diameters of it will be placed in the axis of vision. As the diameters of a sphere are all equal and similar, Dr. Wallace considered that vision would be equally perfect along the different diameters of the lens, brought by rotation into the axis of vision. Sir D. however, remarked, that

he had never found among his numerous examinations of the lenses of fishes, any which are perfectly spherical, as they were all either *oblate* or *prolate* spheroids, so that along the different diameters of the solid lens, the vision would not be similarly performed. But, independent of this circumstance, he stated that in every solid lens there was only one line or axis in which vision could be perfectly distinct, namely, the axis of the optical figure, or series of *positive* and *negative* luminous sectors, which are seen by the analysis of polarized light. Along every other diameter, the optical action of the lens is not symmetrical. When the lens is not *spherical* but *lenticular*, as in the human eye and in the eyes of most quadrupeds, Dr. W. considers that the apparatus for adjustment is the ciliary processes, to which this office had been previously ascribed, though not on the same scientific grounds as those by him discovered. One of the most important results of Dr. W.'s dissections, is the discovery of *fibres in the retina*. These fibres may be rendered distinctly visible. They diverge from the base of the optic nerve, and surround the *foramen ovale* of Sömmering at the extremity of the eye. Sir J. Herschel had supposed such fibres to be requisite in the explanation of the theory of vision, and it is therefore doubly interesting to find that they have been actually discovered. Sir D. concluded by expressing a hope that British anatomists would turn their attention to this subject.

Sir D. Brewster then communicated his researches on "*A New Kind of Polarity in Homogeneous Light.*" At the last meeting, said he, I gave an account of a *new property of light*, which did not admit of any explanation. Since that time, I have had occasion to repeat and vary the experiments; and having found the same property exhibited in a series of analogous though different phenomena, I have no hesitation in considering this property of light as indicating *a new species of polarity* in the simple elements of light, whether polarized or unpolarized. After detailing the experiments, he says, hence I conclude that the different sides of the rays of homogeneous light have different properties when they are separated by prismatic refraction or by the diffraction of grooved surfaces or gratings;—that is, *these rays have polarity*. When light is rendered as homogeneous as possible by absorption, or when it is emitted in the most homogeneous state by certain colored flames, it exhibits none of the indications of

polarity above mentioned. The reason of this is, that the more or less refrangible sides of the rays lie in every direction, but as soon as these sides are arranged in the same direction by prismatic refraction or by diffraction, the light displays the same properties as if it had originally formed part of a spectrum. Some discussion among the members, on points connected with this subject, ensued.

Sir Wm. R. Hamilton then made a communication respecting the *propagation of light in vacuo*; and subsequently, on the *propagation of light in crystals*. The object of these papers was to advance the state of our knowledge respecting the law which regulates the attractions or repulsions of the particles of the ether on each other.

Sir J. Herschel offered a *Note on the Structure of the Vitreous Humor of the Eye of a Shark*. The result is, that the vitreous humor, (so called,) of this fish is no jelly, but simply a clear liquid, inclosed in some close cellular structure of transparent membranous bags, which, by their obstruction to the free movements of the contained liquid, imitate the gelatinous state.

Mr. Ball, of C. C. Cambridge, read a paper "*On the meaning of the Arithmetical Symbols for Zero and Unity, when used in General Symbolical Algebra.*"

A communication was read from Prof. Forbes, "*On Subterranean Temperature; and notice of a Brine Spring emitting Carbonic Acid Gas.*" Observations had been made and were now in progress, on the temperature of the earth at various distances beneath the surface, in the vicinity of Edinburgh, the results of which he intended to lay before the next meeting of the Association. The *brine spring* is about a mile from Kissingen, Bavaria. It has 3 per cent of salt, and rises in a bore 325 Bavarian feet deep in red sandstone; but it is understood that the water flows at about 200 feet in depth. Its temperature is never less than 65°,—the mean temperature of springs near, being only 50° to 52°. It discharges carbonic acid gas in volumes almost unexampled, keeping the water,—in a shaft of eight feet diameter,—in a state resembling turbulent ebullition. The enormous supply of gas has led to its use in gas baths, for which purpose it is carried off by a tube connected with a huge inverted funnel, which rests upon the water. It contains scarcely a trace of nitrogen. It is conducted into chambers properly prepared and thence into baths,

in which it lies by its weight, and is used as water would be. But the most remarkable feature still remains. About five or six times a day the discharge of gas suddenly stops; in a few seconds the surface of the well is calm. The flow of water, amounting to 40 *cubic feet per minute*, also stops, or rather, becomes *negative*, for the water recedes in the shaft even when the pumps, commonly used to extract the brine, do not work, and the water subsides during 15 or 20 minutes. It then flows again, the water appearing first and suddenly, the gas gradually increasing in quantity, till, after three quarters of an hour, the shaft is full as at first. The state of greatest discharge continues with little variation since the bore was made in 1822. Within a short distance is a bore 554 Bavarian feet deep, which exhibits somewhat similar phenomena. Altogether, Prof. F. considers that the salt spring at Kissingen is the most singular phenomenon of its kind in Europe except the Geysers.

Mr. Russell gave a description of a "*Substitute for the Mountain Barometer in Measuring Heights*," by Sir John Robison. Mr. R. said, that all persons who had used the mountain barometer, when measuring heights, would admit that it was a very cumbersome instrument, put out of order by very slight accidents, and only to be used by persons well skilled in observing. The principle of Sir J. Robison's contrivance is simple, and such that the most ignorant person might be intrusted with the preparatory manipulation of it, and might be sent up mountains when the philosopher could not leave his study, and bring back the air to be experimented upon; and, since he could not go to the air with his barometer, to cause it to come to him. It consisted of a wooden box, containing simply a thermometer and a number of tubes, of a bore something wider than those of self-registering thermometers, open at one end, and blown into bulbs at the other; also a small vessel of quicksilver. All that the person who went up the mountain had to do, was to note the thermometer, and immerse the open end of one of the tubes into the mercury at each station, and then bring down the whole. The examiner then places each bulbed tube, into the stem of which a considerable quantity of mercury will, of course, be found to have entered, under the receiver of an air pump, either along with a barometer, or with a well-made gauge: and on pushing the exhaustion until the mercury stood within the bulbed tube as it did upon the moun-



tain, making certain simple allowances for temperature, the height at which the barometer would have stood at the station on the hill can be deduced; and thence, by the usual calculation, the height of the station. The stem of the instrument is previously graduated, so that bare inspection shows the density of the air at the elevated station.

Sir D. Brewster communicated the following papers: "On a new phenomenon of Color in certain specimens of Fluor-Spar."—"On an Ocular Parallax in Vision, and on the law of visible direction."—"An account of certain new phenomena of Diffraction."—"An account of an analogous series of new phenomena of Diffraction when produced by a transparent diffracting body."—"On the combined action of grooved metallic and transparent surfaces upon Light." These valuable papers called forth from Sir J. Herschel the highest praise. "There is extreme difficulty," said he, "in following with sufficient rapidity for discussion, such an absolute torrent of new matter. Indeed, the discoveries of Sir D. Brewster, whether viewed in relation to the intervals at which they succeed each other, or the instruction they convey, equally fill us with delight and astonishment."

A paper *on the Helm Wind of Crossfell*, was read by Rev. J. Watson.

Dr. Smith read a paper *on the Variations in the quantity of Rain which falls in different parts of the Earth*. The causes of these variations are, the author imagines, to be ascribed to the physical differences of the vicinity of each place, and in the track of the most rainy winds; and he found this opinion confirmed by a long average of Westerly and Easterly winds at London, compared with six other places.

Prof. Wheatstone read a paper *on Binocular Vision, and on the Stereoscope, an instrument for illustrating its phenomena*. The instrument is so named, from its property of presenting to the mind the perfect resemblances of solid objects. A short explanation of the principles of the instrument was offered by Prof. W. Sir D. Brewster feared that the members could scarcely judge from the very brief and modest account given by Prof. W. of the principle and of the instrument devised for illustrating it, of its extreme beauty and generality. He considered it one of the most valuable optical papers which had been presented to the Section. He observed, that when taken in conjunction with the

law of visible direction in monocular vision, it explains all those phenomena of vision by which philosophers had been so long perplexed; and that vision in three dimensions received the most complete explanation from Prof. W.'s researches. Sir J. Herschel characterized Prof. W.'s discovery as one of the most curious and beautiful for its simplicity, in the entire range of experimental optics.

Rev. Charles Graves read a paper on a *General Geometric Method*.

Sir T. M. Brisbane reported the result of an experiment to determine the difference of longitude between London and Edinburgh. Having observed the surprising accuracy with which the difference of longitude of London and Paris had been obtained by Mr. Dent's chronometers, he applied to him, and he very liberally placed at his disposal twelve of his valuable chronometers. With these, the differences of longitude of London, Edinburgh and Makerstoun, were taken; and by a mean of all the observations taken in going to the latter station and in returning, they were found to differ only by five one-hundredths of a second.

A letter from the Astronomer Royal, G. B. Airy, was read, on *the means of correcting the local magnetic action of the Compass in iron Steam-Ships*. By an apparatus of his invention, the local deviations were almost wholly corrected. The description will probably be given hereafter.

Prof. Lloyd read a paper entitled, "*Recalculation of the observations of the Magnetic Dip and Intensity in Ireland, with additional elements.*" It is found that the annual decrease of the dip at Dublin is 2'.38. The recent and more complete observations of Sabine at London, make the annual decrease there 2'.40. Major Sabine spoke in reference to the *Report on the Variations in the Magnetic Intensity*, printed in the last volume. He adverted to the observations of Profs. Bache and Courtenay, made in New York and the adjoining States, and which Prof. B. is now engaged in connecting with Europe. Until this comparison is complete, these observations determine the value of the magnetic force at the stations at which they are made, relatively to each other, but not relatively to other parts of the globe. It was for this reason that they were not available for Sabine's Report, which had for its object the general distribution of the magnetic

force over the earth's surface. The American observations were made with needles inclosed in a vacuum apparatus, which Prof. B. had devised, with the view of avoiding some of the anomalies occasionally experienced by other observers. They were made with extreme care, and were remarkable for minute attention to all those circumstances which conduce to the accuracy of the results.

The secretary read Mr. Snow Harris's *Report of Meteorological Observations made at Plymouth*. Mr. E. Hodgkinson gave several observations made the last year *on temperature in deep mines* in Cheshire and Lancashire, a full report of which he hoped to offer at the next meeting. Mr. Russell described an apparatus for showing the *connexion of magnetism with the wind*, invented by Mr. Watt.

Section B. *Chemistry and Mineralogy.*

Dr. Thomas Thomson *on Native Diarseniate of Lead*. During the meeting of the Association at Liverpool, a collection of minerals from Alston Moor was exposed for sale. Among them was one labelled, "Vanadate of lead from Caldbeck Fell." It was in botryoidal concretions on quartz. Several of these nodules, had, under the microscope, the aspect of cylinders. *Color*, honey-yellow, like that of arseniate of lead, but lighter and much less translucent. *Lustre*, resinous, and more brilliant than that of vanadate of lead. Does not scratch calcareous spar, but scratches gypsum with great ease. *Gravity*, 7.272; that of vanadate of lead is only 6.663. Before the blowpipe on platinum foil, it melts into a transparent globule, which on cooling, assumes nearly its original appearance. On charcoal, it gives out abundant arsenical fumes, and leaves globules of metallic lead. Two analyses by Mr. Stenhouse gave,

Chlorine,	-	-	-	-	-	2.46
Lead,	-	-	-	-	-	7.10
Arsenic acid,	-	-	-	-	-	18.20
Protoxide of lead,	-	-	-	-	-	70.14
Peroxide of iron,	-	-	-	-	-	1.20
Volatile matter,	-	-	-	-	-	1.00
						100.10

Mr. Scanlan communicated observations on the *Constitution of the Commercial Carbonate of Ammonia*. The results of his

investigations are, that this substance is not a homogeneous salt, a true sesquicarbonate, as Mr. Phillips considered it, but a mechanical mixture of carbonate and bicarbonate. Mr. S. also read a paper on *the blackening of Nitrate of Silver by Light*. Experiments which he has made result in the conclusion previously asserted by Dr. J. Davy and by Mr. Fergusson, (although contradictory to the statements of most books of chemistry,) that pure nitrate of silver, is not blackened by continued exposure to sunlight, unless organic matter is present.

Mr. Thomas Richardson presented an examination of two specimens of *Sphene*, one from Arendahl in Norway, and the other from an unknown locality.

Mr. Thomas Exley read a paper on the *specific gravities of Nitrogen, Oxygen and Chlorine, and of the Vapors of Carbon, Sulphur, Arsenic and Phosphorus*. By experiment and calculation, he finds the following to be the true gravities of these substances, viz. N. = .9722, O. = 1.1111, H. = .0694, Cl. = 2.5, C. = .8333, S. = 2.2222, Ars. = 5.2777, Ph. = 2.2222. Mr. E. concluded by suggesting an opinion that there is another elementary body, yet undiscovered, having both an exceedingly small sphere of repulsion, and an exceedingly small atomic weight, or absolute force. This substance, he conceives, gives rise to the miasmata of marshes, to infectious effluvia and other concomitant exhalations; chlorine, acids and other substances, owe their disinfecting qualities to their power of absorbing this substance into their atmospheres. If its existence should be ascertained, *Microgen* might be deemed an appropriate name.

Dr. T. Thomson read a paper on *Diabetic Sugar*. This sugar has been commonly considered as isomeric with starch sugar. *Taste*, sweet; *color*, snow-white; *gravity*, after fusion 1.56 at 65°: melts at 239°; 100 parts of water dissolve 108 parts of it. Boiling water dissolves any quantity. Soluble in alcohol. It crystallizes, but so irregularly that the shape of the crystals has not been ascertained. After being dried in vacuo over sulphuric acid, it loses an additional atom of water if it be exposed to a heat of 212°, without losing weight. Analysis of it gave,

Carbon,	37.23, or 12 atoms = 9.	= 38.09
Hydrogen,	7.07, or 13 " = 1.625	= 6.88
Oxygen,	55.70, or 13 " = 13.	= 55.03
	100.00	23.625    100.00

By Dr. Prout's analysis, starch sugar is  $C^{12}H^{14}O^{14}$ , or it contains an atom of water more than diabetic sugar.

Mr. Robert Mallet read a communication on *a new case of the decoloration of recent solutions of Caustic Potassa of commerce, and on the nature of the coloring matter*. The author stated, that the caustic potassa of commerce, was well known to be a very impure compound, containing besides potassa, sulphate of potassa, chlorides of potassium and iron, peroxide and carbonate of iron, silicic acid, charcoal, and generally lime. He had also in one case found a trace of cobalt, and in several protoxide of lead, probably from the vessels used in its preparation. The color of recent solutions of this potassa in water freed from air by boiling, is apple-green, and occasionally, purplish-green, which, whether exposed to air or not, or in dark or light, gradually disappears, leaving the solution colorless. A red precipitate of peroxide and carbonate of iron is produced on solution; but, after a time, the green solution in losing color, deposits a second in very small quantity, which Mr. M. has found, by analysis, to consist of,

Sesquichloride of iron, . . . . . 15.7

Sesquioxide of iron, . . . . . 83.2

The decoloration of the solutions of common caustic potassa was effected by violet-colored light in 30 hours, and by red in 200 hours.

Mr. H. Pattinson gave an account of a new process, by him discovered, for the *extraction of Silver from Lead*. By this process, the details of which are too extensive for insertion here, a large amount of both lead and silver wasted by the methods now employed, would be saved.

Dr. Golding Bird communicated "Observations on some of the *Products of the action of nitric acid on Alcohol*." Numerous experiments are related in this paper, and the following are some of the author's conclusions. 1. During the action of nitric acid on alcohol, no oxalic acid is formed as long as nitrous ether alone distils over. 2. Aldehyd is not produced, in any appreciable quantity, until oxalic acid appears in the retort, and the production of nitrous ether nearly ceases. 3. During the preparation of nitrous ether in the cold, acetic acid is abundantly produced, and appears to replace the oxalhydric acid formed when heat is employed.

Dr. B. also communicated a paper "On the possibility of *obtaining by Voltaic action, crystalline metals*, intermediate between the Poles or Electrodes," and exhibited a mass of plaster of Paris (upon which he had operated) containing little veins of copper disseminated through it in every direction, which presented a marked resemblance to those met with on the large scale in nature.

Prof. Johnston described a *compound of sulphate of lime*, deposited from a high-pressure boiler, containing half an atom of water, and in this particular differing from any other composition of the kind.

Mr. Phillips stated that the *Blue Pigment* submitted last year by Dr. Traill, was Prussian blue largely diluted, and rendered pale by ferrocyanide of antimony.

Prof. Graham read a *Note on the Constitution of Salts*. He wished to draw attention to a distinction in saline combinations which is too often overlooked, and confusion thereby occasioned. The orders of monobasic, bibasic, and tribasic salts, of which the phosphates proved types, have lately been greatly enlarged by the discoveries of Liebig and Dumas respecting vegetable acids, and the distinctive characters of these orders are well understood. The best proof that an acid is bibasic or tribasic is its combining at once with two bases which are isomorphous, or belong to the same natural family,—as phosphoric acid does with soda and ammonia in microcosmic salt, and tartaric acid with potassa and soda in Rochelle salt. Water and magnesia, water and barytes, water and oxide of lead, are also constantly associated as bases in bibasic and tribasic salts, but never in true double salts, or combinations of two or more salts with each other, with which salts of the preceding orders are often confounded. But it is too generally supposed that a metallic oxide cannot exist in a saline combination, except in the capacity of base, although in most of those bodies which are at present termed *sub-salts*, the whole or a portion of the metallic oxide is certainly not basic, but is attached to a really neutral salt, in a capacity similar to that of constitutional water, or water of crystallization. The test of the non-basic character of water or a metallic oxide in a compound, is the absence of a parallel combination containing an oxide of the potash class.

A paper by Dr. Andrews, was read, on *the influence of Voltaic combination on Chemical action*. He endeavored to show that the proper tendency of a voltaic circle is to diminish the chemical action of the solution on the electro-positive metal, from the consideration, that in ordinary solution, the electricities thus developed have only an indefinitely small portion of liquid to traverse; while in voltaic solution their reunion can be effected, only by passing across a column of variable extent, and composed of an imperfectly conducting substance.

Mr. Robert Mallet read his report of the experiments instituted at the command and with the funds of the Association, "*On the action of Sea and River Water, whether clear or foul, and at various temperatures, upon Iron, both cast and wrought,*" and made by himself and Prof E. Davy, of Dublin. The report is comprised under four principal sections, viz. 1. A brief summary of the actual state of our chemical knowledge of the reactions of air and water on iron. 2. A statement of the nature and extent of the experiments on the action of water on iron, which have been made on the great scale for the use of the engineer as well as chemist. 3. A refutation of the method proposed by J. B. Hartley, of preserving iron by brass. 4. A new method, founded on electro-chemical agencies, for the protection of wrought and cast iron; with a statement of various desiderata upon the subject.

A paper was presented, by Mr. Robert Addams, *On the construction of Apparatus for solidifying Carbonic Acid Gas in contact with the liquid form of the Acid, at different temperatures*. Mr. A. adverted to the original production of liquid carbonic acid by Dr. Faraday, in 1823, and also to the solidification of the acid by Mr. Thilorier, and then exhibited three kinds of instruments which he (Mr. A.) had employed for the reduction of the gas into the liquid and solid forms. The first mode was mechanical, in which powerful hydraulic pumps were used to force gas from one vessel into a second, by filling the first with water, saline solutions, oil or mercury; and in this apparatus a *gauge of observation* is attached, in order to see when the vessel is filled. The second kind of apparatus is a modification of that invented and used by Thilorier. The third includes the mechanical and the chemical methods, by which is saved much of the acid formed in the generator; whereas by the arrangement of Thilorier's plan, two parts in three rush into the atmosphere and are lost. With this set of

instruments are used two gauges of observation,—one to show when the generator is filled with water by the pumps, and consequently all the free carbonic acid forced into the receiver; and the other to determine the quantity of liquid acid in the receiver. A table of the elastic force or tension of the gas, over the liquid carbonic acid was shown for each ten degrees of the thermometer, from 0° to 150°. The following are some of the results:

Degrees.	Ib. per square inch.	Atmospheres of 15 lbs. each.
0	279.9	18.06
10	300	20
30	398.1	26.54
32	413.4	27.56
50	520.05	34.67
100	934.8	62.32
150	1495.65	99.71

Mr. A. intends to examine the pressure at higher temperatures, up to that of boiling water and above; and he asserted his belief that it may be profitably employed as an agent of motion,—a substitute for steam,—not directly, as had been already tried by Mr. Brunel,—but indirectly, and as a means to circulate or reciprocate other fluids. The solidification of the acid was shown, and the freezing of pounds of mercury in a few minutes, by the cooling influence which the solid acid exercises in passing again to the gaseous state.

Dr. T. Thomson communicated a paper on the *foreign substances contained in Iron*. These are carbon, manganese, silicon, and phosphorus in very minute quantities.

Prof. Johnston read a paper on some *exceptions to the law of Isomorphism*, showing that substances crystallizing in the same form were not always composed of the same formulæ.

Dr. R. D. Thomson and Mr. T. Richardson presented a communication on *the decomposition produced by the action of Emulsion on Amygdalin*.

A paper was offered by Mr. Exley, on *Chemical combinations produced in virtue of the presence of bodies which remain to continue the process*. It has been observed, said Mr. E., that in many instances, powerful chemical affinities have been brought into activity by the presence of certain bodies which remain insulated. This Berzelius attributes to a peculiar force, which he calls *catalytic force*. Several reasons are adduced to show that this force is



but one species of the general effects which usually occur in chemical actions, all of which are modifications of universal gravity arising from circumstances.

Mr. William Herapath gave a paper on *a new process for tanning*. He assumed that the great cause of obstruction to rapid tanning, is, that the weakened ooze is retained by the capillary attraction of the fibres and blood-vessels so long, that when it shall have passed out by exosmosis, it will have produced the same effect upon the soluble gelatin as is produced by maceration. Hydraulic pressure was too expensive, and he accordingly thought of employing pressure by the roller.

*On the application of gas obtained by Water to the manufacture of Iron*, by Mr. J. S. Dawes. The mode is as follows. Jets of steam are made to pass through red hot cast-iron pipes, filled with small coke or charcoal; decomposition immediately takes place; the base of the carbon of the coke combines with the oxygen base of the steam, forming, at first, carbonic acid, but by passing this over a further portion of red hot carbon, it is converted into carbonic oxide, sensible heat at the same time becoming latent on combining with the hydrogen base, producing hydrogen gas, which, together with the oxide before mentioned, is applied to the furnace by means of a jet inserted within the blast-pipe tuyere, the pressure of the gas, of course, being equal to that upon the blast.

A description, by Prof. Miller, was next read, of an *improvement in the construction of the Reflective Goniometer, by which it is rendered more portable*.

Dr. T. Thomson gave an account of *Galactin*, a substance which constitutes the principal ingredient in the sap of the Cow tree, or *Galactodendron utile* of South America. The sap, on standing, throws up a white matter, soluble in boiling alcohol, but deposited as that liquid cools. When well washed and dried in vacuo, over sulphuric acid, it constitutes *galactin*. It is yellow, translucent, and brittle, has a resinous aspect and is tasteless. It is insoluble in water, but soluble in alcohol and ether. Gravity, 0.969. It dissolves readily in oil of turpentine and olive oil. It is composed of 6 atoms carbon,  $4.5+6$  atoms hydrogen,  $.75+1$  atom oxygen, 1, = 6.25, being isomeric with Brazil wax.

The secretary, Prof. Miller, read a paper on Lieut. Morrison's instrument for measuring the electricity of the atmosphere, and

also a paper by Mr. J. C. Blackwell on the formation of crystals of silver by the contact of brass with nitrate of silver.—Prof. Johnston read a paper on the *Resin of Gamboge and its salts*. He also produced some specimens of resinous substances found in coal mines, and expressed his belief that this resin was an exudation from the trees of which the coal is composed.—Dr. Bird stated that he had formed chloride of copper by the voltaic action.—Mr. Maugham read a paper on *a new Compound of Carbon and Hydrogen*. When the electrodes of a voltaic battery are armed with charcoal points, by means of platinum wires, and then brought under water, so as to produce the spark in the ordinary way, neither hydrogen nor oxygen gases are evolved, but carbonic oxide passes off, and a compound, not previously noticed, remains in the water, consisting of carbon and hydrogen.—A letter from Prof. Hare, of Philadelphia, was read, on his mode of *fusing large masses of Platinum*. Mr. Maugham claimed this as his own discovery.\*

#### Section C. *Geology and Geography.*

Mr. Long presented a *Description of a Bone Cavern in the Mendip Hills*. The cavern is on the summit of one of the Mendip Hills, in a limestone rock. It was discovered in pursuing a fox, which fled there for shelter. It is entered by a perpendicular fissure, 30 feet deep. From a large chamber at the bottom of this fissure an arched way leads into another chamber, from which a passage leads up towards the surface, and this latter seems to have been the original entrance. The bones are generally found imbedded in soft mud, in hollows in the bottom of the cavern, but sometimes also in stalactite. The greater part of the bones are those of the ox, horse, deer, fox, boar, &c. But the most interesting circumstance connected with this deposit is, the existence of human bones, which are found beneath the others. Nine skulls were also obtained. Many of the bones are in so decayed a state, that they crumbled to dust on being handled. It is worthy of remark that none of the bones belong to extinct species. Prof. Sedgwick observed, that no human bones had yet been found in any of the old caverns, unless under circumstances which clearly showed their recent introduction; and

---

\* See Dr. Hare's paper in the present No.—EDS.

this cavern did not militate against the received theory of the formation of osseous breccias. It may have been a place of ancient sepulture, the bodies being let down through a stratum of clay and gravel.

The next communication was *on the Newcastle coal field*, by Mr. John Buddle. This coal field occupies a tract in the counties of Northumberland and Durham of about 700 square miles. Mr. B.'s very valuable essay was fully illustrated by a profusion of accurate and highly-finished drawings, plans and sections.

A paper was received from Prof. Von Baer, of St. Petersburg, entitled "*Recent Intelligence respecting the frozen ground in Siberia.*" Additional experiments on the temperatures during the year at different depths have recently been commenced at Yakutsk, details of which we shall have hereafter.

Mr. Lyell, the President of the Section, read a paper *on vertical lines of Flint, traversing horizontal strata of Chalk, near Norwich.*

Mr. Webb read a short notice of *Lunar Volcanoes*. He had for some time examined the moon with an excellent five-foot achromatic, and had found that several volcanic vents existed not laid down in Schröter's lunar map; and also, that several vents, which had been so laid down, were now much enlarged in dimensions. On the whole, however, he considered that the moon and the earth were similar in this respect, viz. that volcanic action was now less violent than it had been in by gone periods.

The secretary read *a brief account of a Mandingo, native of Nyani-marú, on the River Gambia*, by Capt. Washington, R. N. This man, after many adventures, is now in England. As already observed by Goldberry and Laing, of the Mandingos generally, he resembles in his features the Hindoos more than the blacks of Africa in general. His features are regular and open, his person well-formed, full six feet in height, his nose Roman, with the nostrils rather flattened, not thick lips, beautiful teeth, hair woolly, color a good clear black, not jet. With the aid of Mr. Renouard, a vocabulary of about 2000 words and phrases in the Mandingo language had been gathered from this native, besides itineraries in various parts of his country; and when we consider how extensively spread is this language, perhaps the most so of any of the 36 families of languages into which authors have divided the 115 languages of Africa, and that hith-

erto a vocabulary of about 400 words is all that we possessed of it, it will be admitted that this native of Gambia has not been an unprofitable subject of geographical inquiry.

Next was read a *Sketch of the recent Russian Expeditions to Novaia Semlia*, by Prof. Von Baer.

Lieut. Col. Don J. Velasquez de Leon gave a short account of a map of Mexico recently made by order of the Government.

Capt. Washington, R. N. communicated an *account of the Recent Expeditions to the Antarctic seas*. This paper was illustrated by a South circumpolar chart on a large scale, showing the tracks of all former navigators to these seas, from Dirk Gherritz in 1599, to M. d'Urville in 1838; including those of Tasman in 1642, Cook in 1773, Bellingshausen in 1820, Weddell in 1822, Biscoe in 1831, and exhibiting a vast basin, nearly equal in extent to the Atlantic ocean, unexplored by any ship, British or foreign. The writer pointed out that the ice in these regions was far from stationary; that Bellingshausen had sailed through a large space within the parallel of  $60^{\circ}$ , where Biscoe found ice that he could not penetrate:—that where d'Urville had lately found barriers of field-ice, Weddell, in 1822, had advanced without difficulty to the lat. of  $74\frac{1}{4}^{\circ}$ , or within  $16^{\circ}$  of the pole; and that it was evident from the accounts of all former navigators, that there was no physical obstacle to reaching a high southern latitude, or, at any rate, to examining those spots which theory pointed out as the positions where the southern magnetic poles will probably be found. The paper also mentioned the expedition to the South Seas, which has just left this country fitted out by several merchants, but chiefly under the direction of that spirited individual, Mr. Enderby, whose orders were to proceed in search of southern land, and to attain as high a south latitude as possible.

Mr. Murchison gave an account of a *Geological map and sections of the border counties of England and Wales*.

Mr. Griffith gave an account of his *Geological map of Ireland*, and of two remarkable sections in the south of that country.

A paper *on the stratification of rocks*, by Mr. Liethart, of Newcastle, was next read.

A short paper by Mr. Trimmer was read *on the occurrence of marine shells over the remains of Terrestrial Mammalia in Cefn Cave, in Denbighshire*. The cave is in carboniferous limestone;

the bones of the rhinoceros, hyena, &c. are contained in marl beds and stalactite ; and over these the fragments of marine testacea, showing the irruption into this cave of a diluvial current.

Dr. Daubeny read a paper *on the Geology and Thermal Springs of North America*. The facts which he was about to detail, Dr. D. said he had become possessed of, partly from his own researches during a late visit, and partly through the kindness of the Messrs. Rogers, to whose labors in American geology he paid a just tribute of approbation. He then gave a short sketch of the different chains of mountains in the United States. He stated briefly, as the result of his examination of various *thermal springs* in the U. S., that they gush out in all instances along lines of fracture of the strata, a result similar to that which he had already established respecting the thermal waters of Europe. Dr. Buckland communicated the contents of a letter from Mr. Lea, stating that the quantity of coal in the valley of the Mississippi was vastly greater than has hitherto been supposed.

The next paper was *on the structure of Fossil Teeth*, by Mr. Owen. The internal organization of the teeth in the higher mammalia, as shown by magnified transverse sections, was first described. The curious modifications which this structure undergoes in the Megatherium, the Ichthyosaurus, and fossil fishes, were pointed out in detail, and illustrated by numerous magnified drawings. It is impossible here to give the details, but the general result of the investigations is a most important one to geologists, viz. that the different genera may be distinguished by the internal structure of their teeth alone ; and therefore, when other characters fail, or a complete tooth is unattainable, generic, nay, perhaps even specific identity, may be established by merely obtaining a thin slice of one of these fossil teeth. Prof. O. read before the Medical Section, the day previous, a paper *on the structure of teeth and the resemblance of ivory to bone, as illustrated by microscopical examination of the teeth of man, and of various existing and extinct animals*. This paper contains the results of extensive investigations, conducted with Prof. O.'s usual skill and thoroughness, on the internal structure of the teeth of various orders of animals.

Dr. Buckland communicated *an Account of Footsteps on Sandstone near Liverpool*. This interesting discovery was made in a quarry on the summit of the peninsula between the Dee and Mer-

sey, at a considerable depth from the surface, by two intelligent persons, Forrester and Horne, connected with the quarry, and an account of the circumstances was drawn up on the spot by Messrs. Cunningham and Dwyer. The specimens found were casts of the impression of the foot, and nothing could be more perfect and characteristic. There are two sets of footsteps; one set being those of an animal of which traces have been before observed, and which has been called *Cheirotherium*, from its hand-like foot: the other, those of smaller animals, which seem to have been land tortoises, similar to those which have been long known in the Dumfries quarries, and which are fully described in Dr. B.'s *Bridgewater Treatise*. A space of between 20 and 30 feet horizontal, is exposed in the quarry, on which these footsteps are distinctly seen, and where the animals do not appear to have been walking in the ordinary way, but to have been performing gambols. He stated also that from the appearance of the surface of the sandstone, covered with minute spherical elevations quite different from any ripple mark, it was manifest that a shower of rain had fallen, and its traces had been preserved upon this primeval surface!

Rev. G. Young presented a paper *on the antiquity of organic remains*, to which Prof. Sedgwick replied.

Dr. Buckland read a paper *on the application of small coal to economical purposes*. Mr. Oram had succeeded in agglutinating the small particles of coal into a firm mass by a process at once simple and cheap. There would even be economy in using this coal for many purposes, as it occupied one third less space, when packed, than coal in its ordinary state.

A letter was read from Mr. Fox, of Cornwall, stating the important fact, as a result of some new and most careful experiments, that *he had at length obtained, by voltaic action* upon mineral substances, *a mineral vein*, namely, carbonate of zinc, in its natural position between two layers of earthy matter.

Mr. D. Milne read a paper *on the Berwick and North Durham Coal-field*. It is a basin, 15 miles in diameter, and has 15 seams of coal, of the average thickness of 2 or 3 feet.

Major Jervis gave an account of the progress and present state of the *trigonometrical survey in British India*. Capt. Washington then gave an account of the government surveys of Austria, England, France, Saxony, Tuscany, &c.

Capt. W. Allen, R. N. read a paper *on a new construction of a map of the western portion of Central Africa, showing the possibility of the river Tchadda being the outlet of the lake Tchad.*

Capt. Beaufort, R. N. communicated a notice *on the position of the city of Cuzco, in Peru*, by J. B. Pentland, Esq.

Lieut. Col. Chesney, R. A. communicated a letter *on the recent ascent of the river Euphrates*, by Lieut. Lynch.

*Geological excursion.* Two steam boats were provided for an excursion to Tynemouth and Cullercoats. At 7 A. M. of Friday, about 200 gentlemen left the quay. After breakfast, at Tynemouth, many gentlemen and ladies from the vicinity, joined the party, which then proceeded under Tynemouth Castle rock along the shore to Cullercoats; Mr. Hutton and Prof. Sedgwick acting as leaders, and explaining as they advanced, every object of interest which presented itself. The party halted repeatedly, while Prof. S. directed attention to some singular phenomena there exhibited. A more picturesque scene can hardly be imagined than the Professor mounted on the beetling cliff, overhanging the vast ocean, with the listening hundreds assembled around him. After viewing the magnesian limestone, and associated red sandstones, the wonders of the 90-fathom dike, and the marl-slate beds at Whitley quarries, with their fossil fish, which had been opened up for the occasion, the party returned to Newcastle, much instructed and highly delighted.

On Saturday, the time was so limited, that instead of reading the remaining papers, their authors briefly stated the most important topics which they contained.

#### Section D. *Zoology and Botany.*

The secretary read a paper, *on a species of fish having four eyes, found on the coast of Surinam*, by W. H. Clarke and John Mortimer. There appeared to be some uncertainty as to the correctness of the account, and it was proposed that the matter should receive farther examination.

Mr. Babington read a paper *on the Botany of the Channel Islands*. Mr. B. stated that 20 species of plants were found on these Islands not yet noticed in England.

Mr. J. E. Gray read a short description of *a British Shell, supposed to be new.*

Rev. Mr. Wailes exhibited a specimen of the rare insect *Psali-dognathus Friendii*, concerning which some discussion followed.

Mr. Gray read a paper *on the formation of angular lines on the shells of certain Mollusca*.

A paper was read *on the wild Cattle of Chillingham Park*, by J. Hindmarsh. There are in this herd, 25 bulls, 40 cows, and 15 steers of various ages. They are beautifully shaped; have short legs, straight backs, horns of a very fine texture, thin skin, so that some of the bulls appear of a cream color. They have a peculiar cry, more like that of a wild beast than that of ordinary cattle. The eyes, eye-lashes, and tips of the horns alone are black, the muzzle is brown, and the inside of the ears red or brown, and all the rest of the animal white. The author was inclined to consider these animals the survivors of the Caledonian cattle, which undoubtedly extended through the northern provinces of England; and that, under the protection of the owners at Chillingham, they had escaped the general destruction dependent on the advance of civilization.

Next was read a paper on the production of *Vanilla in Europe*, by Prof. Morren, of Liege.

Dr. Parnell read a paper on some *new and rare specimens of British Fishes*, viz. *Gadus cimbrius*, *Pagellus acarine*, *Raia chagrinea*, *R. intermedia*, *R. clavata*, *Cottus scorpicus*, *Platessa limandoides*, *P. pala*, *Mugil chelo*, *Trigla gurnardus*.

The next paper was by Mr. J. Hancock, *on the Falco Islandicus* of authors. Mr. H. stated that under this name were confounded two distinct species. For the Iceland species he retained the name of *F. Islandicus*; the other he named, from the country in which it is most abundant, *F. Grænländicus*.

Col. Sykes read a paper on *a rare animal from South America*. It was described by Azara, and called *Canis jubatus*. It differed from the dog tribe in its nocturnal and solitary habits; its tail was thicker, more bushy, head flatter, eyes smaller, nose sharper, and the whole animal more bulky than the dog tribe. If it differed from the dog, it differed more from the fox and wolf, and he proposed to refer it to the genus *Hyæna*.

The next paper was *on Vegetable Monstrosities*, by Rev. W. Hincks. These he distributed into five classes. 1. Cases of coherence and adherence of parts not usually united, or of separation of those which are ordinarily connected. 2. Anomalies depend-



ing on the comparative development of parts of one circle. 3. Anomalous transformations of organs. 4. Monstrous exuberances of growth, by which the number of parts is altered independently of transformation, the number of circles of parts is increased or the axis irregularly extended. 5. Anomalous abortions or suppressions of parts usually present in the species.

Mr. T. P. Teale read a paper on the *Gemmiferous bodies and Vermiform Filaments of Actiniæ*. He stated that as great differences of opinion existed among zoologists, as to the nature of the gemmiform bodies and vermiform appendages of Actiniæ, he had undertaken their investigation. Some general remarks on the structure of the Actiniæ were premised, the author pointing out, by means of a large diagram, the various directions of the muscular septa, some lining the cavity and supporting the stomach of the animal, whilst others, more delicate, terminate in a mesentery, supporting the *gemmiferous bodies* (about 200 in number) or what has been erroneously called the *ovary*. The vermiform filaments are attached by a delicate mesentery to the internal body of each gemmiferous body. Many more valuable and curious details are given, for which we have no room.

A paper was read by Capt. J. E. Cook, R. N., on the genera *Pinus* and *Abies*, not less than 70 species of which had lately been introduced into England.

Mr. Hope read a paper entitled "Remarks on the modern classification of Insects."

Mr. G. B. Sowerby laid before the Section specimens of *Encrinus moniliformis*, displaying various monstrosities of form.

A paper was read by Mr. Arthur Strickland on the *Ardea alba*, a bird which is unquestionably an occasional visiter in England.

Prof. Ehrenberg addressed the meeting in French, and exhibited the first volume of his great work on microscopic forms of life. He submitted to the inspection of the members a bottle of the material collected in quantity in the vicinity of lake Lett-naggsjön, in Sweden, which the inhabitants call Bergmehl, or mountain meal. This earth, which resembles fine flour, has long been celebrated for its nutritious qualities, and was found to be entirely composed of the shells of microscopic animalcules. Prof. Jones engaged in an oral discussion with Prof. E. concerning the structure of the polygastric infusoria.

Rev. L. Jenyns exhibited a series of specimens of the square-tailed shrew, (*Sorex tetragonurus*, Herm.) and also a specimen of the chestnut shrew, (*S. castaneus*, Jen.) which was, in his opinion, a distinct species.

Mr. Gray made some observations *on the boring of Pholades*. The action of these animals in boring rocks he was inclined to consider mechanical.

Sir Wm. Jardine read the report drawn up at the request of the Association *on the present state of our knowledge of the Salmonidæ of Scotland*.

Mr. Allis, of York, read a paper *on the Toes of the African Ostrich, and the number of phalanges in the toes of other birds*. Mr. A. had not been able to find the rudiments of a third toe, alleged to exist in the Ostrich. He further stated, that Cuvier had erroneously given the number of phalanges of the toes of the following birds. In the Cassowary, which had 3 toes, the real numbers are 3, 4, and 5. In the Ostrich 4 and 5. The Caprimulgus has the outer and middle toe, having 4 phalanges each. The Swift has only 3 phalanges, except in the hallux. The Humming-bird has the full number of phalanges in all its toes.

Dr. Charlton showed a specimen of *Tetrao Rakkelhan* of Temminck, and endeavored to substantiate the old theory, that this bird is nothing but a hybrid between the hen capercaillie and blackcock.

Dr. Handyside, of Edinburgh, presented a paper *on the Sternoptixineæ, a family of osseous fishes*, including a minute description of a new species, the *Sternoptix caelebes*.

The next paper was *on the distribution of the terrestrial Pulmonifera in Europe*, by Edward Forbes.

A notice of *the annual appearance of some of the Lestris tribe (Arctic Gulls) on the coast of Durham*, was communicated by Edward Backhouse, Esq., of Sunderland.

Mr. Owen stated some of the results of his investigations made in procuring materials for his *report on the Marsupiata*. The report was drawn up under three heads. 1. The zoology of the Marsupiata. 2. Their relation to other Mammalia, and 3. The peculiarities of their reproductive economy. He concluded with some geological account of the bones of these animals.

Mr. Yarrell gave a description of a new species of Smelt, caught in the bay of Rothsay, which he denominates *Osmerus Hebridicus*.

Rev. F. W. Hope read a paper on *Noxious Insects occurring in 1838*. These were a beetle (*Anthonomus pomonus*) which attacked the blossoms of apple trees; an aphid, which has injured apple trees, hop plants, and wheat; and the *Tipula Tritici* (or rather *Cecidomyia Tritici*), a small dipterous insect, whose attacks on wheat while blossoming, for many years past, are well known.

Section E. *Medical Science.*

A paper was read by Mr. T. M. Greenhow, on the beneficial action of mercury rapidly introduced, in certain cases of Neuralgia.

Mr. R. M. Glover read a paper on the functions of the rete mucosum and pigmentum nigrum in the dark races, and particularly in the Negro; with observations on a paper on the same subject, by Sir Everard Home.

In the next paper, Dr. John Reid gave an account of an *experimental investigation of the functions of the Eighth Pair of Nerves*.

A paper, by Mr. N. Farr, on the law of recovery and mortality in *Cholera Spasmodica*, was read by Dr. R. D. Thomson. From the tables which Mr. F. has prepared, may be deduced the solutions of the following problems. 1. The mean duration of the disease. 2. The mean future duration of the disease at any period. 3. The probability of dying at any period of the disease.

Mr. James Blake then read a paper on the action of various substances on the animal economy, when injected into the Veins, in which were detailed experiments with various substances and their effect on the vascular system, measured by an ingenious instrument, which the author called a Hæmadynamometer, an instrument by which he was enabled to detect the pressure of the blood in the arterial system, by means of a column of mercury, contained in a bent glass tube, which could be connected with the arteries, and which was attached to a graduated scale.

Dr. Yelloly (the chairman) showed a model of an improved acoustic instrument, to assist in cases of partial deafness. A report upon its value may be expected at the next meeting.

Dr. Reid gave a brief notice of his researches on the quantity of air required for respiration.

Dr. Inglis read a paper containing *phrenological remarks on the skull of Eugene Aram*.

Dr. Granville exhibited an *improved Stethoscope*, a ball-and-socket joint being attached to the ear-piece, which thus becomes movable with the cylinder at any angle which may be required.

Dr. Rees read a paper *on the chemical nature of the Liquor Amnii*.

Dr. R. D. Thomson read a paper *on the modus operandi of Nitrate of Silver as a caustic and therapeutic agent*.

Mr. Greenhow read a brief *memoir on fractures*, for the purpose of introducing a model of a new sling fracture bed, applicable to every fracture in the lower extremity, but peculiarly adapted to the treatment of compound fractures of the femur.

Dr. Bowring communicated some *observations on Plague and Quarantine made during his residence in the East*. The results of his observation had produced in his mind a strong conviction of the non-contagiousness of the plague. Quarantine restrictions are consequently altogether useless vexations.

Mr. Goodsir read a paper *on the origin and subsequent development of the human teeth*.

A paper by Dr. Spittal was read, entitled "Experiments and Observations on the cause of the Sounds of Respiration."

Dr. A. T. Thomson read a paper *on the medicinal and poisonous properties of some of the Iodides*. The principal preparation whose action was detailed, was the iodide of arsenic. The action of this medicine in very minute doses, from  $\frac{1}{8}$  to  $\frac{1}{3}$  of a grain, was peculiarly serviceable in *Lepra vulgaris* and chronic impetigo. A case of numerous tumors resembling carcinoma was found to yield to its continued action, and it was found equally successful in a more decided case of incipient carcinoma.

#### Section F. *Statistics.*

The first paper read was a Report from Mr. J. Stephens, superintendent of police, *On the State of Crime in Newcastle, during the last ten months*. This was simply such a return as is usually made from police offices.

Mr. G. R. Porter read a *statistical View of the recent progress and present amount of mining industry in France*. This is an elaborate Report, and comprises the mining operations in coal, iron, lead, silver, antimony, copper, and manganese.

Col. Sykes read a very minute and detailed account of the *Statistics of Vitality in Cadiz*. He submitted an immense mass of valuable tables and returns, which will probably be published.

Afterwards were read *Statistical Illustrations of the Principal Universities of Great Britain and Ireland*, by Rev. H. L. Jones. The best authorities were employed in the preparation of this document. The college revenues were minutely detailed, and the results may be thus stated:—

	Oxford.	Cambridge.	Dublin.
Heads of houses	24	17	1
Income	£18,350	£12,650	£2,000
Fellows	557	431	25
Income	£116,560	£90,330	£25,400
Scholarships	339	793	70
Income	£6,030	£13,390	£2,100
College-officers	199	179	10
Income	£15,650	£17,750	£20,000
Benefices	455	311	31
Incumbents	430	280	31
Income	£136,500	£93,300	£9,300
Rent of Rooms	£11,730	£15,860	£2,000
College Revenues	£152,670	£133,268	£31,500

Other tables were constructed, giving the number of members, and their ranks, also the *stimulating forces*, that is, the amount of pecuniary advantage offered for exertion.

Mr. W. Cargill offered a paper on the *Educational, Criminal and other Statistics of Newcastle*.

Mr. L. Hindmarsh made a communication on the *State of Agriculture and Agricultural Laborers in the north division of the county of Northumberland*. On the whole, the agricultural statistics of this district are of a gratifying character. They present a soil well cultivated, under the vicissitudes and difficulties of a very variable climate; and a peasantry who, in their general intelligence and moral habits, are a credit to themselves, an honor to the country, and an example worthy of imitation.

Dr. W. C. Taylor read an *Account of the changes in the population of New Zealand*, communicated by Saxe Bannister, Esq. late Attorney general for New South Wales. The New Zealand group consists of the N. and S. islands, Stewart's island, and some smaller isles; the extent of these is 95,000 square miles. The population was classed under the following heads,—natives, white residents, white visitors and mixed races. The probable number of natives is 130,000. The white residents are about 2,000. As

many as 1000 British and American sailors have been seen at the Northern island at one time. There was no estimate of the mixed race, which is greatly on the increase; but the total population is decreasing, from a variety of causes, and chiefly from the introduction of European diseases. The natives are a noble race of men, capable of attaining a high degree of civilization, but in Mr. B.'s opinion, there was no doubt of their being addicted to cannibalism.

Mr. Rawson read a report *on the Fires of London*. The total number of alarms of fire attended by the Lond. Fire Engine Establishment during five years up to the end of 1837, was 3,359, or 672 on the yearly average: of these, 343, or 68 per annum, were false alarms, and 540, or 108 per annum, were fires in chimneys. Thus, the number of alarms was 13 per week, and of actual fires, 4 in every three days. Some of the false alarms had arisen from displays of the *Aurora Borealis*. Of the 2,476 fires, the premises were wholly consumed in 145 cases; seriously damaged in 632; slightly damaged in 1699. An analysis was given of the presumed causes of total destruction, and it was observed that the number of fatal fires had greatly increased. The winter months do not show so large a preponderance of fires as might be expected. December presents the largest average, but the next in order is May. On comparing the number of fires occurring on each day of the week, it appears that there is a slight excess on Friday, and a decided falling off on Saturday. In relation to hours, the number of fires is at the minimum, from 5 to 9 A. M., when it begins slightly to increase until 5 P. M., at which hour the rate of increase becomes considerable, and continues until 10 or 11 P. M., when the number is at the maximum; from this time it gradually declines until the dawn. The number of wilful fires in the five years, was 31, or 6 per annum, which is as 1 in 64 to the number of fires of which the causes were discovered.

Rev. J. M'Alister gave a *Statistical notice of the Asylum for the Blind*, recently established at Newcastle.—Mr. Heywood, announced that he had received the last *Annual Reports of the Regents of the University of the State of New York*, from the Rev. Dr. Potter, with an explanatory letter,—which was read.—Next was read Mr. Rawson's abstract of the *second Report of the Railway Commissioners for Ireland*.—Statistical tables were exhibited of the *nine principal collieries in the county of Dur-*

ham, prepared by Mr. W. L. Wharton.—Next was read Mr. Wilson's account of the *Darton collieries "Accident Club,"*—a kind of mutual relief association.—Mr. Felkin, of Nottingham, read an abstract of the *Annual Report of the overseers of the township of Hyde*, in Cheshire.—Mr. W. R. Charlton submitted *Statistical notices from the parish of Billingham.*—Mr. Hare offered an *Outline of subjects for statistical inquiries.*—Mr. P. M'Dowall presented *statistical tables of Ramsbottom*, near Bury in Lancashire.—Mr. Kingsley read a paper giving a tabulated *view of the Criminal Statistics of Ireland.*

Section G. *Mechanical Science.*

A paper was read on a *new Day and Night Telegraph*, by Mr. Joseph Garnett; and a paper on *Isometrical Drawing*, by Mr. Thomas Sopwith.

Mr. Sopwith also gave a description of an *improved method of constructing large Secretaires and Writing Tables.* The principle is, that by opening a single lock, all the drawers, closets and partitions are opened. These are so disposed, that a person may reach every thing contained in it, without stirring from his seat. The president, (Mr. Chas. Babbage,) and many others, expressed their admiration of the arrangements, and of the convenience which such a table must be to every person engaged in an extensive correspondence, or having many sets of papers on various subjects.

Mr. G. W. Hall on the power of *economising and regulating heat for domestic purposes.*—Mr. John S. Russell gave some further notices on the *resistance of water.*—Mr. P. Nicholson communicated an essay on *the principles of oblique bridges.*—Mr. W. Greener submitted *remarks on the material and mechanical construction of steam boilers.* He considered the accidents which happen to steam boilers to be mainly due to defect in the material; and he detailed several experiments made on slips of iron cut from plates of different quality. He found that slips cut latitudinally from a plate, bore less by 30 per cent. than slips of the same dimensions cut longitudinally.

Sir John Robinson spoke on the *use of coal-gas for cooking.* Mr. Strutt, of Derby, stated some years since, that coal-gas would probably be found, by the lower classes, the cheapest fuel for cooking. The whole apparatus, (which might be considered the

converse of the Davy Safety Lamp,) consisted in fixing a piece of wire-gauze at the extremity of a gas-pipe of about 6 inches diameter. Bulk for bulk, gas costs more than coal, but the former was more economical and convenient for occasional use and the smaller operations in cooking.—Mr. Evans gave account of a *new rotatory steam-engine*, invented by S. Rowley.—Dr. Lardner stated the reasons which had prevented the making of the experiments for the *Report on Railway constants*.—Mr. J. Price communicated an *improved method of constructing Railways*. The method consists in fixing rails on a continuous stone base, a groove having been made in the stone to receive a flange or projection of the lower side of the rail. The stones and rails are to break joint with each other, and the chair by which the rails are to be secured, is to be made fast to the rail by a bolt not riveted, but slipped in. The chair is to be sunk until the top is level with the top of the stone, and fastened to it by two small wooden pins. Any sinking of the road is to be obviated by driving wedges of wood underneath the stone, until it is raised to the required height. The chairs are to be fixed at about 4 feet apart, and to weigh, if of malleable iron, 14 pounds, but if of cast iron, 20 pounds: the rail to weigh 50 pounds per yard.

Mr. T. Motley presented a paper *on the construction of a railway with cast-iron sleepers as a substitute for stone blocks, and with continuous timber bearing*. The cast-iron sleepers, which are wedge-shaped and hollow, having all their sides inclined inwards towards the under side, are to be laid transversely, and the timber is to pass longitudinally through the center, and to be secured by wedges of iron and wood. The sleepers are to be six inches apart, and the timber of such a thickness as to prevent any perceptible deflexion between the rails. The road is to be ballasted up to the top of the sleeper, and the timber to stand out sufficiently, and to have any approved rail laid upon it.

Mr. Hall described a *machine for raising water by an hydraulic belt*. Mr. Samuda gave an account of *Cliff's dry gas-meter*. Mr. T. Sopwith described his method of constructing *geological models*. Mr. S. also described an *improved levelling stave*, for subterraneous as well as surface levelling. The mode of reading the figures of the stave itself instead of the sliding vane, as adopted by most engineers and surveyors, is used in Mr. S.'s improved



staves; the figures being engraved on copper plate, on an enlarged scale. Mr. T. Motley gave an account of a *suspension bridge over the Avon, Tiverton*. The peculiar feature of this bridge is, that each chain is attached to the roadway, and the suspending bars are carried up through each chain above it. The length of the bridge is 230 feet, the breadth 141, and the cost, including the towers and land abutments, under 2,400*l*.

Prof. Willis described his instrument called the *Odontograph*, designed for enabling workmen to find at once the centres from which the two portions of the tooth are to be struck, so that the teeth may work truly together.

Mr. Lang described some improvements in *Ship Building*, and exhibited models illustrating the safety keel, which had been introduced with great success.

Count Augustus Breunner communicated a paper *on the use of wire ropes in deep mines*. About seven years ago, ropes composed of twisted iron wire, were introduced into the silver mines of the Hartz mountains, as a substitute for the flat ropes previously in use. Since that time they have been adopted in most of the mines of Hungary and Austria, to the almost total exclusion of flat and round ropes made of hemp. These iron ropes are as strong as a hempen rope of four times the weight. One has been in use upwards of two years without any perceptible wear, whereas a flat rope performing similar work, would not have lasted more than a single year. The diameter of the largest rope in common use in the deepest mines of Austria, is one inch and a half. This rope is composed of iron wires, each *two* lines in diameter; *five* of these are braided together into strands, and *three* of these strands are twisted tightly into a rope. Great care is requisite in making the rope, that the ends of the wires be set deep in the interior of the rope, and that no two ends meet in the same part. The strength of these ropes is little less than that of a solid iron bar of the same diameter. The usual weight lifted is 1000 pounds. The rope on leaving the shaft, must be received on a cylinder of not less than eight feet diameter, and be kept well coated with tar. There is a saving of about one third of the power in one case mentioned, for *four* horses with a *wire* rope, are doing the same work as *six* horses with a *flat* rope.

Mr. Babbage called attention to some specimens of a new method of wood engraving, by Mr. G. Woone.

Dr. Lardner addressed the meeting on *Steam Navigation and on a self-recording Steam-Journal*. Dr. L. said that it was a matter of no real importance how far any opinion which he might have formerly expressed on extended navigation was right or wrong, except so far as it had been made a personal question. He had, indeed, expressed a discouraging opinion as to the probability of ever maintaining an unbroken intercourse by steam navigation between Great Britain and New York, but he had never declared that it was a physical impossibility. He confessed that the success of the *Great Western* had shaken his former opinions, and should the same success continue throughout the entire year, he would be the first to come forward and acknowledge himself completely in error. He then gave an account of his instrument, termed a *steam-journal*, by which he proposes to register every five minutes, the following varying phenomena, on which the efficiency and performance of steam engines depends:—the pressure of the steam between the slides and the steam valve—the pressure in the boiler—the vacuum and the quantity of water in the boilers—the saltness of the water in the boilers,—the velocity of the paddle-wheels—the draft of the vessel—the trim of the vessel—the rate of the vessel,—the course of the vessel,—the apparent force and direction of the wind. All these, excepting the course of the vessel, it is intended to register by self-acting mechanism.

Mr. J. S. Russell followed with an essay on the same general subject, and insisted on the propriety of making steamboats sharp. Iron boilers, with copper tubes, appeared to him the best.

Mr. Fairbairne described *machinery for riveting boiler plates*, by which the work is done better and much more speedily than in the usual methods.—Mr. B. Green gave an account of the construction of *timber viaducts*.—Prof. Willis described a method recently introduced by Mr. Hawthorn, of working the valves of a locomotive without the usual eccentrics.—Mr. J. T. Hawkins described several methods of filtering water.—Several communications were offered which could not be read for want of time, viz. Mr. Reed, *on an improved safety hook and bow for coal-pits*: Mr. Glynn, *on the waterworks of Newcastle*: Mr. Wake, *on a new paddle-wheel*: Sir C. Monteith, *on a new tram-road*; *on an improved kitchen grate*: Mr. Fourness, *on coal mine ventilation*: Mr. Dobson, *on a method of making bricks of every required color*.

Various appropriations were voted for the prosecution of scientific investigation, viz.

To the Physical Section, - - -	£2263.10
Chemical " - - -	150.00
Geological " - - -	325.00
Zoological and Botanical, - - -	6.00
Medical, - - -	100.00
Statistical, - - -	300.00
Mechanical, - - -	598.00
	<hr/>
	£3742.10

The principal recommendations not involving grants of money were—that Prof. A. D. Bache should be requested to report on the meteorology of the United States:—that Prof. Johnston should report on the connexion of Geology and Chemistry:—that the Council should prepare a general report on the progress of Geology:—that J. E. Gray, Esq. should prepare a report on British molluscous animals and their shells:—that P. J. Selby, Esq. should prepare a report on British Ornithology:—that Dr. Forbes should report on the Pulmoniferous mollusca of Great Britain; and that Prof. Faraday, aided by a Committee, should report on the specific gravity of steam. In addition to these, many resolutions were passed, involving applications to the government and other public bodies; and various scientific researches were also recommended.

ART. IX.—*On Cupellation, an easy, an accurate, and new method*; by W. W. MATHER, Mining Engineer, and Geologist.

TO PROF. SILLIMAN.

*Dear Sir*—My duties as mining engineer, metallurgist, and geologist, have frequently rendered it necessary to assay lead and other ores for silver and gold. As I could not procure a good cupelling furnace with muffles, &c., and as it was frequently desirable to ascertain on the spot, whether certain ores contained the precious metals, I have thought of other means of cupellation, and have succeeded in one which can be applied at any place where a candle, a common mouth blowpipe, and a slip of mica can be procured. It is a method which I have employed for

about two years with perfect success, and I have no hesitation in recommending it to the public. As it is a matter of public interest to simplify all such operations, I have thought it proper to send you a description of my method of cupellation.

If the ore to be examined for silver or gold, be a lead ore, it is to be reduced to the metallic state by the ordinary methods. A small piece of the lead, of the size of a duck shot or larger, is to be placed on a thin slip of mica, and then melted by the blowpipe flame of a candle or lamp. As the heat increases above the melting temperature of the lead, the globule will become perfectly brilliant, and finally a peculiar flickering, brilliant surface will shew itself, caused by the oxidation of the metal and the fusion of the oxide of lead. The oxide of lead melts at the temperature at which this appearance is developed, and spreads itself on the mica. It soon ceases to *spread*, and collects around the globule of melted lead, which is continually diminishing in magnitude, in consequence of the oxidation of the metal in the oxidizing blowpipe flame. When the globule of melted lead is nearly buried in the mass of the surrounding oxide, the slip of mica should be permitted to cool. The globule of lead should then be removed by forceps, or other means, to another place on the slip of mica, where the same oxidizing process is to be repeated successively. Finally, when the globule shall have been reduced to the size of a small grain of sand, it should be placed on a fresh, clean slip of mica, and again heated in the same manner. If the lead contains the least trace of silver, it is easily made manifest in this way, because, the silver when once free of lead, (which continues to oxidize to the last,) remains unchanged, as a brilliant white globule, which can be frequently seen distinctly with the naked eye, and when too small for this, by examination with the magnifier. If the oxidation of one globule of the lead does not give decisive indications of silver, a satisfactory conclusion as to the lead being argentiferous or not, may be obtained by oxidizing five to ten such globules down to a very small size, and then uniting these by fusion on a slip of mica, and continuing the oxidation to its ultimate limit. A person accustomed to blowpipe manipulation, can determine in a few minutes, if silver be present in any lead which may be suspected to contain it. With the table blowpipe, or the hydrostatic blowpipe, an ounce of lead may be cupelled in a very short time, and the relative quantity of silver determined, if it be appreciable.

If the ore to be examined be not an ore of lead, some of the ore is to be melted in a clean crucible which has never been used, and lead free of silver and gold added, and stirred and mixed with the fused ore. The fusion of the ore should be so perfect as to permit the lead to settle to the bottom of the melted ore. The lead, in consequence of its affinity for the precious metals, unites with them if present, and forms an alloy. The lead, cupelled as above, will show the silver or gold, or an alloy of them, if either, or both of them were present.

If the globule obtained by the cupelling operation be suspected to be an alloy of silver and gold, it is examined in the usual way, and the metals separated qualitatively, or quantitatively, as circumstances may require.

Albany, Oct. 2d, 1838.

---

ART. X.—*Meteoric Observations made at Cambridge, Mass. ;*  
by Prof. J. LOVERING.

THE science of meteorology, although it has received of late a large share of public attention, still remains in an unsettled and crude state. The rigorous demonstrations of mathematics, which have been called in to elucidate and develop the other sciences, have failed in any important degree to reach and establish this. A disposition to speculate, a disinclination to keep up steady observations, has been felt as a constant impediment to the growth of this department of science. It is not till very recently, that any regular and systematic plan of observations has been adopted: and yet we might have supposed that the mighty impulse given to astronomy by the establishment of fixed observatories, would have suggested similar means for the advancement of other sciences equally dependent upon constant observations. Instead of complaining, however, that we did not have them sooner, perhaps we ought rather to rejoice that such means are now in operation, and that a mass of observations is continually sent forth from these established retreats, which must soon give a more finished character to the complicated and difficult science of meteorology.

A good proportion of this attention has been received by that class of transient and luminous appearances, either in or very near

to our atmosphere, comprehended under the general term of meteors. The appalling spectacle of falling stars, presented on the morning of the 13th November, 1833, has confirmed this awakening interest to the phenomena that are daily taking place in our atmosphere. This shower, for such it literally was, seems to have been quite unparalleled, if we make allowance for the exaggerated accounts which we read in the poets, of marvels and strange lights in the heavens. And what particularly needs notice, is the vast extent of country to which this sight was offered, suggesting the idea that the earth in its revolution, had encroached upon a nest of meteors. I have never been able to fall in with the opinion, that this shower has been repeated on the same morning in succeeding years. I do not think that the appearances noticed on those mornings were of an unusual character, and far less that they can claim any comparison with the exhibition of 1833. The hypothesis more recently advanced, that there are two or three favored seasons of the year, although better supported by the facts than the other, I do not think can yet be maintained. My own observations, and the facts mentioned by those who have arrived at a different opinion, have led me to the conclusion, that meteoric appearances are much more common every night than has been imagined: that, independently of the clearness of the atmosphere, no season of the year is especially provided: that about the same average number can be seen every fair night: that very few appear before midnight, and that much the largest number is seen during the two hours before sunrise.

Notwithstanding the zeal of observers in different places, many more observations are still needed, made every night in the year, and from midnight till morning, before any satisfactory result can be reached. The labor of such observations is painful, and must therefore be shared with many. I think, however, that a single night's uninterrupted watch is worth far more than the same extent of observations distributed over several evenings, as it saves the necessity of taking an average, which must always be uncertain: for although, generally speaking, the meteors fall much more abundantly in the morning, from four till six, than at an earlier hour; still, the relative proportions for each hour are not so accurately fixed, that we may conclude from a single hour's observation, the number that has fallen during the night. With these remarks, I give the result of some observations that were

made at Cambridge, on and near the 13th of November last. Eight members of the senior class, Messrs. Hale, Hurd, Adams, Longfellow, Chase, Channing, Morison, and Parker, undertook the labor of watching. Their stations were taken together out in an open field: the heavens were divided into quarters, and two observers stationed at each quarter. All of the observers were out the whole time, from midnight till morning. A condensed table of the meteors seen by them is contained below.

## November 12th, 1838.

Hours of observation.	Quarters in which the meteors were first seen.				Sum.
	S. E.	S. W.	N. E.	N. W.	
From 12 till 1 A. M.	6	2	1	2	11
" 1 — 2 "	4	9	4	10	27
" 2 — 3 "	18	10	8	11	47
" 3 — 4 "	13	16	10	14	53
" 4 — 5 "	12	18	8	10	48
" 5 — 6 "	2	7	—	4	13
Total,	55	62	31	51	199

NOTE.—After 5 o'clock there were only two observers.

## November 13th.

Hours of observation.	Quarters in which the meteors were first seen.				Sum.
	S. E.	S. W.	N. E.	N. W.	
From 12 till 1 A. M.	6	7	3	8	24
" 1 — 2 "	12	11	6	8	37
" 2 — 3 "	7	7	1	9	24
" 3 — 4 "	11	5	4	6	26
" 4 — 5 "	7	7	3	3	20
Total,	43	37	17	34	131

## November 14th.

Hours of observation.	Quarters in which the meteors were first seen.				Sum.
	S. E.	S. W.	N. E.	N. W.	
From 1 till 2 A. M.	6	3	2	1	12
" 2 — 3 "	16	22	13	15	66
" 3 — 4 "	23	21	25	11	80
" 4 — 5 "	14	18	15	16	63
" 5 — 5h. 20m. "	3	8	0	1	12
Total,	62	72	55	44	233

An attempt was made to watch again on the morning of November 23d, but the clouds partially prevented. The observations this morning were not commenced till 1h. 20m. At half

past two it became cloudy, and at three the sky was almost entirely obscured.

Hours of observation.	Quarters in which the meteors were first seen.				Sum.
	S. E.	S. W.	N. W.	N. E.	
From 1 till 2 A. M.	2	5	8	5	20
“ 2 — 3 “	10	6	5	4	25
“ 3 — 3½ “	2	—	—	3	5
Total,	14	11	13	12	50

It is now to be remarked that the state of the atmosphere was not peculiarly favorable, on any one of the nights of observation. It was occasionally hazy, and floating clouds were continually obscuring some part of the firmament. It was thought, however, that the morning of the 13th was as favorable in this respect as either of the other mornings, and yet it happened that a smaller number was seen then than before or after. It was particularly noticed that the meteors of the 13th were inferior in splendor to some observed on the other mornings. For many of them had tails and trains, and shone with the brilliancy of Sirius.

Now it is clear that no conclusion is to be drawn from this or any other single set of observations. They are only valuable in connexion with all others made at the same or any other time. We still want a continued series, extending through every day of the year, and reaching from midnight till sunrise. Without these data, we are not prepared for the question whether one period or any number of periods is particularly supplied with meteors; nor are we competent to investigate the cause of these phenomena. A longer series of observations has been made in Germany than elsewhere, and, as far as they go, they seem to indicate an equal and uniform distribution of meteors throughout the year. No hypothesis can be received which aims simply to account for what are considered by some periodic showers; since no one can deny that meteors are seen every clear night in great abundance; and no theory is complete or exhausts the subject, which leaves these unexplained.

The members of the Senior class whose names I have given above, and by whom the observations at Cambridge were made, deserve an honorable mention for the zeal and fidelity with which they have discharged their trust. The notes which I have before me permit me to see from what point of the heavens each meteor first became visible, and in what direction it afterwards moved. I have carefully examined to discover, if possible, some common



source or other circumstance which could lead to a generalization. The observations made at the same season of the year in other places have appeared to indicate a remote connexion with the constellation Leo. I find on looking with this view at my observations that a larger number of meteors emanated from this part of the heavens than any other, although the constellation Leo is so large that this fact will hardly lead to any inference. But what particularly struck me was the fact that so large a proportion of the meteors *radiated* to Leo. I find that the directions of more than two thirds, if traced back, converge to this part of the ecliptic. It is but fair to remark, however, that the remainder are exceedingly anomalous and deviate widely from the mark. It is a point to be carefully taken notice of by future observers, whether there be any general radiating point, whether it is fixed if there be one, in regard to the horizon, as it would be if connected with the earth's magnetic axis, or whether it partakes of the apparent diurnal motion of the stars: and especially whether it be the same at all seasons of the year. The connexion in so great a proportion of cases between the November meteors and the constellation Leo, has suggested the idea that the meteors have only an *apparent* motion; for the earth itself, at that time moving towards Leo, would give every foreign body which it should meet the appearance of coming from Leo. If a cloud of nebulous matter beset the path of the earth so as to be traversed by it, the denser parts might be condensed into different nuclei and the earth's atmosphere grinding by them might possibly set them on fire. The appearances under such circumstances would resemble those actually witnessed in a great number of instances, and we should also be able to account for the great abundance of meteors seen two hours before sunrise; as at that time we ourselves are facing the point to which the earth is moving, and must take directly into the atmosphere around us the encountered cloud. Till midnight we should have the earth between us and the vapor, and could only see the small quantity that escaped, being taken up in front and passed off at the sides of the earth. If every one of the observations made at Cambridge had indicated one radiating point without any exception, I should not consider them alone as sufficient foundation for any theory. As it is, what I have said will only bear to be thrown out as a suggestion, and will serve to fix attention more strongly on this part of the subject. It is desirable that observers at other seasons

of the year should notice whether the radiating point shifts with the direction of the earth's motion, as it will do if the motion of the meteors is only apparent and proceeds from our own motion in revolution. I have enlarged these remarks much beyond my intention: my only object has been to do a part, however humble, in settling one of the many questions involved in meteorology.

Cambridge, December 6, 1838.

ART. XI.—*Notice from Dr. ROBERT HARE, Professor of Chemistry, &c., respecting the fusion of platina, also respecting a new Ether, and a series of gaseous compounds formed with the elements of water.*

TO PROF. SILLIMAN.

Philadelphia, Dec. 15th, 1838.

*My Dear Friend,*—I send you for the Journal a brief notice of some results, observations, and inferences, which are nearly in the same language in which they were communicated to the Chemical Section of the British Association for the Advancement of Science.

I have by improvements in my process for fusing platina, succeeded in reducing twenty five ounces\* of that metal to a state so liquid, that the containing cavity not being sufficiently capacious, about two ounces overflowed it, leaving a mass of twenty three ounces. I repeat that I see no difficulty in extending the power of my apparatus to the fusion of much larger masses.

When nitric acid or sulphuric acid with a nitrate is employed to generate ether, there must be an excess of two atoms of oxygen for each atom of the hyponitrous acid which enters into combination. This excess involves not only the consumption of a large proportion of alcohol, but also gives rise to several acids and to some volatile and acrid liquids.

It occurred to me that for the production of pure hyponitrous ether a hyponitrite should be used. The result has fully realized my expectations.

By subjecting hyponitrite of potassa or soda to alcohol and diluted sulphuric acid, I have obtained a species of ether which

\* Troy-weight. The actual quantity fused was 12,250 grs.; the lump remaining weighed 10,937 grs.

differs from that usually known as nitrous or nitric ether in being sweeter to the taste, more bland to the smell, and more volatile. It boils below  $65^{\circ}$  of F., and produces by its spontaneous evaporation a temperature of  $0 - 15^{\circ}$  F. On contact with the finger or tongue it hisses as water does with red hot iron. After being made to boil, if allowed to stand for some time at a temperature below its boiling point, ebullition may be renewed in it apparently at a temperature lower than that at which it had ceased. Possibly this apparent ebullition arises from the partial resolution of the liquid into an aeriform ethereal fluid, which escapes, both during the distillation of the liquid ether and after it has ceased, at a temperature below freezing. This aeriform product has been found partially condensible by pressure, into a yellow liquid, the vapor of which, when allowed to enter the mouth or nose, produced an impression like that of the liquid ether. I conjecture that it consists of nitric oxide, so united to a portion of the ether as to prevent the wonted reaction of this gas with atmospheric oxygen. Hence it does not produce red fumes on being mingled with air.

Towards the end of the ordinary process for the evolution of the sweet spirits of nitre, a volatile acrid liquid is created which affects the eyes and nose like mustard, or horse radish.

When the new ether as it first condenses is distilled from quicklime, this earth becomes imbued with an essential oil which it yields to hydric ether. This oil may be afterwards isolated by the spontaneous evaporation of its solvent. It has a mixed odor, partly agreeable, partly unpleasant. From the affinity of its odor and that of common nitrous ether, I infer that it is one of the impurities which exist in that compound.

The new ether is obtained in the highest degree of purity, though in less quantity, by introducing the materials into a strong well ground stoppered bottle, refrigerated by snow and salt. After some time the ether will form a supernatant stratum, which may be separated by decomposition. Any acid, having a stronger affinity for the alkaline base than the hyponitrous acid, will answer to generate this ether. Acetic acid not only extricates but appears to combine with it, forming apparently a hyponitro-acetic ether.

I observed some years ago that when olefiant gas is inflamed with an inadequate supply of oxygen, carbon is deposited, while the resulting gas occupies double the space of the mixture before

explosion. Of this I conceive I have discovered the explanation. By a great number of experiments, performed with the aid of my barometer gauge Eudiometer, I have ascertained that if during the explosion of the gaseous elements of water any gaseous or volatile inflammable matter be present, instead of condensing there will be a permanent gas formed by the union of the nascent water with the inflammable matter. Thus two volumes of oxygen, with four of hydrogen, and one of olefiant gas, give six volumes of permanent gas, which burns and smells like light carburetted hydrogen. The same quantity of the pure hydrogen and oxygen with half a volume of hydric ether gives on the average the same residue. One volume of the new hyponitrous ether under like circumstances produced five volumes of gas.

An analogous product is obtained when the same aqueous elements are inflamed in the presence of an essential oil. With oil of turpentine a gas was obtained weighing per hundred cubic inches  $16\frac{5}{10}$  grs., which is nearly the gravity of light carburetted hydrogen. The gas obtained from olefiant gas, or from ether, weighed on the average, per the same bulk  $13\frac{5}{10}$  grs. The olefiant gas which I used weighed per hundred cubic inches only  $30\frac{5}{10}$  grs. Of course if per se expanded into six volumes it could have weighed only one sixth of that weight, or little over five grains per hundred cubic inches. There can therefore be no doubt that the gas obtained by the means in question, is chiefly constituted of water, or of its elements in the same proportion  $H^2O$ .

With a volume of the new ether, six volumes of the mixture of hydrogen and oxygen give on the average about five residual volumes. The gas created in either of the modes above mentioned does not contain carbonic acid, and when generated from olefiant gas appears by analysis to yield the same quantity of carbon and hydrogen as that gas affords before expansion.

These facts point out a source of error in experiments, for analyzing gaseous mixtures by ignition with oxygen or hydrogen, in which the consequent condensation is appealed to as a basis for an estimate. It appears that the resulting water may form new products with certain volatilizable substances which may be present.

From the account of the proceedings of the Section, published in the Atheneum, it appears, that after my letter, in which the facts above mentioned were stated, was read, a Mr. Maugham,

who is employed to exhibit the hydro-oxygen microscope at the Adelaide Gallery, London, asserted that I had accomplished the fusion, of which mention has been above made, by means of a blowpipe of his contrivance, which I had purchased while in London.

The opinion which I am obliged to entertain of an individual capable of this groundless assertion, would cause me to consider him unworthy of notice, had not his misstatement been made before an assemblage which I most highly esteem, and had he not been honored by a premium for his pretended invention by a respectable British Society:

The blowpipe which is thus falsely alleged to have been used by me, differs immaterially from one of which I published an engraving and description in the American Journal of Science for 1820, vol. II, p. 298, being a modification of that originally contrived by me and republished in Tilloch's Philosophical Magazine, vol. XIV, for 1802.

Between the instruments described in these publications, or in the Franklin Journal, and that employed by Maugham, the only difference worthy of notice is, that the latter is near the apex bent so as to form an acute angle, and is thus rendered suitable for directing the flame upon a revolving cylinder of lime.

Although I purchased of Newman a blowpipe bent as described, with an apparatus attached for holding and turning a cylinder of lime, *I have never made any use of it*, having for the purpose of subjecting lime to the flame, found my modification above referred to as described in this Journal, preferable. It only required the jet pipe to be directed upwards in an angle of about forty five degrees with the axis of the lime cylinder.

I do not consider the form of my blowpipe employed by Mr. M. as qualified for the fusion of any metal.

It is remarkable that an apparatus of gasometers employed by Maugham at the Adelaide Gallery for the supply of the gases for the blowpipe differs but little from the apparatus proposed for the same purpose in my communication above adverted to, and published nearly twenty years ago.

However the process by which I have lately extended the power of the hydro-oxygen blowpipe may differ from those to which I had previously resorted, it differs still more from that modification which Maugham has claimed as his own.

ART. XII.—*Letters on Steam Navigation*; by JUNIUS SMITH, Esq. :—with a *Letter to the Editors*, from Mr. HENRY SMITH, of New York.

## LETTER I.

TO MR. HENRY SMITH.

*My Dear Sir*—Since I wrote to you respecting masts for steam ships, I have, on more mature deliberation, satisfied myself that they are better without any masts at all. It may be expedient in the present stage of Atlantic steam navigation, to construct what may be called a deck mast, that can be thrown up upon a hinge, or bolt axis, in case it should be wanted. I do not doubt that more power is lost by the resistance of masts and rigging in steam ships, than is gained by the use of sails. I am aware that it will be said that the sails relieve the engines; but upon the same principle, the resistance occasioned by the masts and rigging, distress the engines in proportion to the degree of resistance and the time of its continuance. The truth is, as I apprehend it, the engines, if properly constructed, will perform their duty just as well without the aid of sails as with it. Every one at all accustomed to the seas, must be aware that a steam ship running off at the rate of ten knots an hour, would so far keep ahead of an ordinary breeze, that sails would have no effect in propelling, whilst the resistance of the masts and rigging would have a constant and a considerable effect in retarding her.

In crossing the Atlantic one way and the other for twelve months, how few days out of the three hundred and sixty five would a ship have so strong a wind, and that a fair one, as to enable her to run ten knots an hour under canvas? And if the wind is not strong enough and fair enough to do that, sails can be of little or no use. If, as is contended, the use of sails does relieve the engines, all that can be meant by that is, that you can lessen your steam power and reduce the consumption of fuel. But I think that advantage will be more than counterbalanced by the constantly increased resistance arising from the use of masts and rigging.

Your ob'dt serv't,

JUNIUS SMITH.

London, Sept. 19, 1838.

## LETTER II.

*Dear Sir*—In my last letter I took the liberty to dismast steam ships generally, and thus to save the expense of masts, sails, rigging and top hamper in the first place, and in the second, the constant disbursements necessary to keep them in working condition. My main object, however, was to show that masts in steam ships are worse than useless, because the resistance being constant, and the advantage only occasional, the loss by resistance exceeds the gain by such power. But I do not suppose the view I have taken of several particulars relating to Atlantic steam navigation, will receive, at present, the countenance of the public; because the erroneous opinions generally entertained are both so deeply rooted and so agreeable to the minds of many, who fear their craft is in danger that they do not choose to have them corrected, but rather feel a secret delight in any thing which has the slightest tendency to strengthen and confirm them. The bursting of a boiler, an accidental fire, the wreck of a ship, or the loss of a crew, are events hailed with triumph by the class of persons of whom I am speaking.

But if the hints that I have thrown out lead the public mind from that general mode of thinking to which the novelty of Atlantic steam navigation has given birth, to a more close investigation of the subject, we shall soon see our enemies disarmed and uniting with us in carrying out a system of navigation which meets the wants and promotes the welfare of mankind.

It is with the view of showing the subject in its largest dimensions and most important results, that I venture a few remarks upon *steam ships of war*.

It may seem premature, perhaps officious, to speak of the power of the sword, to measure the force of nations, and to weigh in our hydrostatic scales the fortunes of empires. But the thing throws itself upon us in such bold relief, that it seems impossible to conceal it. We are compelled, whether we will or not, to trace the outlines, to bring the subject under review, and to anticipate the mighty effects of steam power upon the destinies of nations.

*Whatever nation, England, France, or America—and I think that it will be one of the three—has the largest and greatest number of steam ships of war, will command the ocean.* Nothing can prevent it. In estimating the relative force of antagonist fleets, the inquiry will not be, how many frigates, or how many

line of battle ships were engaged? but, how many *steam ships*? It will be felt at once that the power of the fleet depends upon the latter. Those who were spectators of the last continental war, will remember that notwithstanding every effort was made and enormous expense incurred by the transport board to meet the urgent demands of the army, yet such were the delays arising from head winds, tempestuous weather, detentions in port, and long passages, that the sufferings of the army were sometimes appalling and its operations crippled.

In war, the facility of transportation is tantamount to victory. If a fleet of twenty steam ships can transport an army of twenty five thousand men to the American coast in fifteen days, and to the continental ports in a time less in proportion to the distance, the army can land when and where it pleases. There is no detention in port, no delay in the passage, no hovering upon the coast, with light and baffling winds, and thus affording time for the enemy to collect the means of defence; but the steamers push at once into port, and are in possession of their object before the enemy can be aware of his danger.

The transportation of the munitions of war and the victualling stores is scarcely less important than that of the army itself. The great magazines will always be at home, whence daily supplies will be drawn with the same ease and regularity as if they were in the vicinity of the camp. The celerity of communication and its absolute certainty supersede the necessity of accumulating stores in a foreign country before they are wanted.

But the greatest triumph of steam power will be seen in those tremendous naval engagements which hereafter will settle and establish the sovereignty of the seas. Such is the locomotive power of a steam ship, that she can place herself in any position in reference to the enemy, can run down from the leeward or windward upon the bows or stern of a sailing man of war, and with broadside after broadside, riddle her fore and aft, annihilate the crew, and leave in her scattered wrecks an undeniable evidence of the irresistible power of a steam ship.

I know it will be said that the paddle-wheels of a steam ship are liable to be shot away, and thus disabled, she may become herself a prey to the enemy. But is she as liable to be disabled as a sailing ship? Suppose a shot were to pass through a paddle-wheel, it is not destroyed, and may not be materially injured;



but if it were utterly destroyed, the ship is not disabled. She can work with one wheel. You must therefore destroy both wheels before she is disabled.

How is it with a sailing ship? Dismast her, and her power is gone. She is a lost ship. The argument therefore regarding the danger of being disabled is vastly in favor of the steamer. She has no masts. And you must imagine her rash enough to expose herself unnecessarily to the enemy, and that too in such a manner as to give him an opportunity of carrying away both paddle-wheels, whilst his own masts are unscathed and entire, before she is disabled;—not a very likely thing, when we consider that the steam ship, by virtue of her locomotive power can always approach the enemy or claw off, when a sailing ship cannot do either. The power of sails is perfectly useless, and the sailing ships go into battle like so many dismasted ships, the sport and playthings of the lively steamer.

If a steamer man of war has occasion to board her enemy, she manœuvres not, waits not the favor of a wind, but darts upon her prey at any point she pleases, and her combatants march over the bridge of her own deck into the camp of the enemy.

The boilers of a steam ship of war ought to be below the loaded water line, and therefore perfectly secure from the effects of shot. The resistance of the water would effectually prevent the shot from penetrating, whilst the even keel of the steamer would give her a point blank shot at her enemy.

Think for a moment of a sailing ship of war, no matter how many guns, chasing a steamer, no matter how few, the longer she chases the further she is off, until, if it were possible to sail on an uninterrupted circle, the steamer in the very act of running away would overtake her pursuer. Reverse this picture, and fancy you see the steamer bearing down upon the seventy four under full sail. Can the latter quicken her speed? Can she fly in the eye of the wind? Can she escape before it? Has she the slightest chance of evading the combat? Can there be a doubt as to the result? When we consider steam power in time of war carried out into all its multiform ramifications, what merchantman can escape capture? What harbor afford shelter? What village resist plunder? What city destruction? What country invasion? Steam power alone can cope with steam power, and therefore the relative naval force of nations can be measured by no other scale.

Hence we see all the maritime nations upon earth reduced to the *same level*, and the work of destruction, upon a large scale, must begin afresh. All the existing navies of the earth are not worth a pepper corn. They will neither augment, nor diminish the power of a nation in any future maritime warfare. We may just stand upon their ruins, and witness kingdoms, empires, and republics, all starting anew in the career of naval achievements, and pressing forward towards those grand results which wait upon superiority.

Nothing but a steam power navy, in the present advanced state of steam navigation, can protect itself, much more a nation from insult. It would seem therefore preposterous and absurd, for any nation to exhaust its resources upon so useless and lumbering a thing as a sailing ship of war. The apathy with which this great subject is regarded in high places, if indeed it be regarded at all, is quite surprising. But the time is hastening on when its power will be *felt*.

England, in all the spreadings of her vast empire, her universal commerce, great in arms, great in peace; England, first in moral excellence, in mechanics, in manufactures, in literature, in the arts, in opulence, in every thing which exalts and adorns a nation, and I may be permitted, after a residence of more than thirty years in her metropolis, to say, all this and a thousand times more. England, with all this radiance encircling her crown, is at this moment more exposed than any other nation to the ruthless hand of the invader. It is not enough that she has strength to *crush* invasion, she wants the *power* to *prevent* it. That she can never have without a steam navy.

Your ob't serv't,

JUNIUS SMITH.

London, Oct. 19th, 1838.

*Remarks by the Senior Editor.*—It being obvious that certain objections to the views of Mr. Smith would present themselves to many readers, a letter, dated Dec. 3d, was addressed to his correspondent in New York, to which the following is an answer.

LETTER III.

TO PROF. SILLIMAN.

*Dear Sir*—In reply to your queries I try to answer each in its order, commencing with “What for instance will the sparless,

sailless ship do when in mid-ocean her machinery gives way, (perhaps the main axis of the wheels of motion,) or should her boilers burst, how will she get on then, and what will become of, it may be, two hundred or three hundred people or more, rolling about in the sea, when, their steam paddles being idle, they have consumed their provisions and do not speak any vessel?"

Answer. I do not understand Mr. Smith as doing away with the use of masts entirely, but only so arranging them upon a bolt axis or otherwise, that they can be unshipped or rigged at pleasure. The basis of his argument as I understand it is, that the great resistance which they meet in adverse winds, counterbalances the use of them, and therefore in doing away with the top hamper, they could be easily rigged so as to lie upon deck, to be used in case of need. If so rigged, the case you contemplate of "breaking the main axis of wheels of motion, or bursting of boiler," must be provided for by resorting to the movable masts. Steamers might have two or more engines detached from each other, as is the case with the *British Queen*, so that in the event of the bursting of one boiler or injury to one engine, the other would remain in full operation, and a case would hardly occur when both engines would be disabled at the same time.

The next question, "How are the great warlike steam navies to be supplied with fuel? Even if the countries have wood, that will last but a little while, as coal cannot be obtained in every maritime country, and if it could, enough could not be carried for a long cruise?"

Answer. Here again I understand that the plan of Mr. Smith for steam ships of war, is more one of defense than of aggression, and his argument seems based upon this position. I do not think he contemplated that steam ships of war would be sent on long cruises, but to be relied upon more as a means of defense.

The *British Queen* is one of our line of ships, and we have some expectation that she will arrive in January, yet she may not be here before February. It would afford me great pleasure to introduce you to the ship whenever she does arrive, and I shall not fail to inform you of it.

With much respect, dear sir, yours very truly,

HENRY SMITH.

New York, Dec. 12th, 1838.

VOL. XXXV.—No. 2. 43

ART. XIII.—*On a New and Effectual Method of Preserving Specimens of Organic Nature, and of obviating the Blanching Influences of Light, and the Depredations of Insects;—most Advantageously Applicable to the Formation and Unlimited Preservation of a Hortus Siccus, or Museum of Dried Plants*; by JOHN L. RIDDELL, M. D., Professor of Chemistry and Materia Medica, in the Medical College of Louisiana.

“Corpora non agunt nisi sint soluta.”

It is conceded, I believe, that light exerts an influence in chemical changes, by modifying or exacting the inherent electrical energies of material particles. This influence has been observed times innumerable by every one, in the blanching or fading of organic colors. Few, I apprehend, could be found, who would be willing, upon the first proposal, to believe in the possibility of easily and completely averting this fading power of light, and of conferring immutability upon the organic tints which are considered as most delicate and evanescent.

The possibility of so doing may perhaps be made theoretically to appear, thus:—The particles of an absolutely solid body can suffer no change, because they are *inter se* immovable. A withering leaf, exposed to air and light, fades and decays, because there is moisture present. Liquid water fills myriads of its insensible pores and intercellular spaces. The leaf may be dry externally,—nay, it may be apparently dry within; yet it is really imbued with more or less of water. This water may give fluidity to the fading coloring matter, either by immediate solution, or by becoming impregnated with acid substances. But it is chiefly by absorbing, and thus giving liquidity to oxygen gas from common air, that it contributes to change. Besides, it is favorable to chemical action, by standing ready to dissolve and remove some or all of the eliminated products. Water, moreover, may exert an indirect agency in hastening organic changes, by favoring the existence of insects and animalcules. Light renders the chemical affinities concerned more active, and thereby soon accomplishes changes which time and other circumstances would accomplish without it. Those conditions only, on which the power of assuming the liquid state depends, are essential. Remove them, and no change can occur.

My plan consists in wholly abstracting the moisture from the specimen to be preserved, having previously inclosed it in some material impervious to air or moisture, in order that the condition of absolute dryness may be perpetually maintained. The desiccative substance which I make use of, is unslacked lime; and though other agents might be used, this seems to answer in all cases so perfectly well, as to leave nothing to be desired. Pure quick lime, it is well known, will absorb near one third its weight of water in the process of slacking, yielding a powder apparently as free from moisture as at first.

I will first explain the manner in which botanical specimens are to be framed for constant exposure on the walls of a museum or lecture room.

Take a specimen, recently dried in the usual way, between folds of bibulous paper, in order that every shade of color may be natural and fresh as life; procure a pane of glass of sufficient size, and a plate of tin, zinc, copper, or sheet lead,\* half an inch longer and half an inch broader than the pane of glass; bend this around the edges so that it will embrace the glass; remove the latter, and place in the shallow cavity a thin layer of cotton batting; upon this, sift a thin stratum of the powder of quick lime; over this another layer of batting; upon this a sheet of tissue paper, and on the tissue paper, the specimen and label. Over all, place the clean pane of glass; press it gently down, and carefully turn over it the edges of the metallic plates. Secure the junction of the glass and metal with a ceroid or resinous cement, as bees' wax, shellac, or sealing wax: or what is more convenient, and seems to answer well, fill the crevices with stiff glazier's putty, and when that gets dry, pass over it with thick Japan varnish, of which two or three successive coats may be used. If the back be of sheet tin, zinc, copper, or thick sheet lead, a ring may be soldered to one end, for the purpose of hanging up without further preparation. But if very thin sheet lead be used, it may require to be first protected by a back of binder's board and some kind of frame.

With a view of subjecting theory to the test of experiment, I enclosed in this manner a dried specimen of *Lycopodium apodum*, and also attached a part of the same specimen by means of stick-

---

\* The sheet lead which lines tea boxes answers very well.

ing wax to the outer surface of the glass. It was exposed to air and sunshine in a high and sheltered situation. After the lapse of two or three days, the outer specimen had obviously begun to lose its color, and was inclining to yellow, while the enclosed specimen, equally exposed to light, still retained its vivid green and apparent freshness. The outer specimen continued to fade until it became nearly decolorized; but the enclosed one suffered not the slightest change in appearance.

It is not essential that the specimen should be dried previously to being thus enclosed. By increasing the quantity of lime to three or four times the weight of the substance to be desiccated, a specimen just plucked may be carefully arranged beneath the glass—it may be then subjected for a couple of days to a few pounds of pressure, may be sealed up and never afterwards removed. The degree of perfection with which the most delicate tints of flowers can thus be preserved, is incapable of being surpassed. In the space of two or three days, the specimen generally becomes more thoroughly dry than it is practicable to render it by bibulous paper.

Upon carefully surrounding fresh specimens of *Asclepias Drakeana*\* and *Rosa Gallica*, with fine powder of quick lime, in a close tin box, complete desiccation was accomplished in a single day; and I was agreeably surprised in finding, that the lime had not in the least modified any of the colors. The flowers were taken out of their natural shape and color, but stiff and brittle from dryness. It is sometimes rather difficult, however, to remove all the lime from some portions of the flowers. Probably it would be best to fill the interior of deep flowers with fine clean sand, before burying them in the powder of lime. In this way, fruits, fungi, insects, small fish, and even reptiles, may be effectually embalmed.

In common herbals the flower is rudely crushed; the important organs from which generic characters are drawn, are deformed, displaced, and often incorporated into a seemingly homogeneous mass; and the fine colors, if they do not become even completely faded, are never preserved for any great length of time without deterioration. Large specimens exhibiting the stem, branches, leaves, and mode of inflorescence, may well enough be kept in

---

\* Undescribed. Flowers yellow and crimson. Louisiana.

an herbal after the usual manner, with the precautions I shall soon point out; but for the preservation of most flowers and floral organs, I would recommend a plan like the following:—

Throw into a jar which can be closely covered, samples of different flowers as they come to hand; immediately sift upon them finely pulverized quick lime, so as to bury them. Again and again throw in other flowers, covering them in the same way, until the jar is full. It may be well enough, for reasons already explained, to fill the cup of the flowers with fine writing sand, before covering them with lime. At any time the lime and flowers may be gently poured out, and the flowers, now perfectly dry, carefully picked up with little forceps. These flowers may be attached to twigs of trees or branches of sea fan or coral, and be enclosed with a few small lumps of quick lime in a sealed glass jar, in such a way that they can be conveniently inspected. Flint glass phials will answer very well for such as are small. A much neater method is to enclose them in the same way in a shallow box lined with metal, and covered with plate glass. In none of these arrangements, if the sealing be perfect and the lime good, will the flowers be noticed to fade from the influence of light.

The same principles may be applied in defending a common herbal from the depredation of insects and from further change by fading. In order to explain a method of effecting these desiderata, I will here introduce the plan which I am now about putting into practice myself. I procure those large tin boxes in which French silks are imported to this city. Any desirable number of them of similar size, can be bought here for a dollar a piece. They are near four feet long, by three feet broad and two feet high. A part of one side must be handsomely cut out for a door. This door may be made either of tin plate, or of a large pane of thick crown glass framed and sealed in metal. It must be attached to the box by hinges; its inner surface near the margin must present a continuous band of gum elastic; around the margin must be eight or ten fastenings, in order to close the opening completely, by pressing the opposing surfaces of metal upon the gum elastic. The door place might be rendered more substantial, by soldering around it such brass strips as are used in fastening down stair carpets; and corresponding strips might also be soldered upon the door itself. These boxes may be painted, and arranged on a series of handsome shelves. Besides containing

the folios of botanical specimens, they must each contain a vessel partly filled with unslacked lime, which will always maintain when the door is kept shut, an inclosed atmosphere of such extreme dryness that *no living thing can exist there*, and no chemical change go on.

I am of opinion, that as botanists are in the habit of mutually interchanging specimens, they would find it greatly to their advantage to adopt a somewhat similar mode of enveloping the packages to be sent. The length of the tin or zinc boxes should be about twenty two inches, the breadth near thirteen, and the thickness from one to six inches. The opening for the cover may then be twenty one by twelve inches; and the cover, besides having six or eight nut and screw fastenings, may be cemented on by bees' wax or sealing wax. On each side the specimens next the metal, may be placed thin layers of powdered quick lime in cotton batting. In this way, no damage would be likely to occur to specimens in transportation. These boxes, having no other use, might be considered as belonging to the fraternity of botanists, rather than to individuals.

In conclusion, I cannot but anticipate that the mode of forming collections or museums of plants, by inclosing handsome specimens behind glass, will hereafter contribute greatly to the diffusion and improvement of botanical science. It is not my design, at this time, to set forth in detail the various excellences and advantages of such a method. To the reflecting reader they must be already obvious. The same principles may be beautifully applied in preserving bouquets of natural flowers, beneath glass bells, as mantel ornaments. The same plan cannot fail of answering admirably in preserving collections of insects. Even miniatures, larger paintings, documents, in short, almost any substance, whether of organic or inorganic nature, may be thus saved from the merciless hand of time.

New Orleans, November 26, 1838.



ART. XIV.—*Electro-Magnetic Engine, constructed by the late A. W. CAMPBELL, of New Orleans,—communicated by Prof. RIDDELL.*

THIS engine, now in my possession, was the result of two or three years of study and numerous experimental trials. Mr. Campbell was a teacher by profession. His opportunities for acquiring a knowledge of natural science were very limited, but his zeal and singleness of purpose are seldom exceeded. He died in January, 1838, leaving his design not quite finished.

His engine differs in some respects from those constructed by others. It consists essentially of two large and solid electro-magnets, of soft iron, in the form of the letter U, coated with coils of copper strips one inch broad by half a line in thickness. These copper coils are insulated by being wound with strips of paper. The electro-magnets weigh, each, about one hundred pounds, and are arranged horizontally, the opposing poles being about eight inches apart. Between them plays the keeper of soft

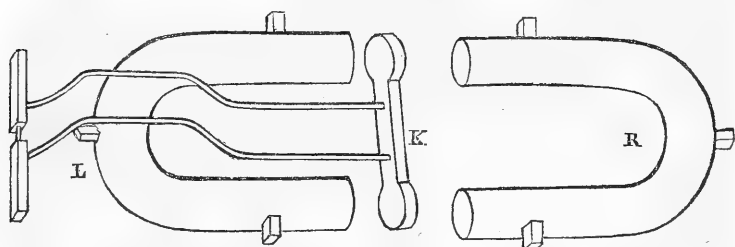

iron, K, after the manner of a piston of a steam engine. When the magnet, R, is connected with an active pair of galvanic plates, K is attracted by its poles. A reversed current of the galvanic fluid from a smaller pair of plates, is then sent around the magnet, sufficient in quantity to destroy its magnetism the moment after the connection with the large galvanic pair is broken. At this instant the magnet L is made to attract the keeper; the connection is then broken, and the current reversed as before; and thus a returning horizontal motion is given to the keeper and its appurtenances. The connections are broken and reversed by the dipping of amalgamated slips of copper into mercury.

New Orleans, November, 1838.

ART. XV.—*Miscellaneous Notices in Opelousas, Attakapas, &c.* ;  
by Prof. W. M. CARPENTER.

Jackson, Lou., Nov. 8th, 1838.

TO PROF. SILLIMAN.

*Dear Sir*—I promised, some time since, to give you something on the prairie formation of the Opelousas and Attakapas country ; but after an examination during two summers, I have not been able to find much that is worth reporting. The formation on which the prairies rest, is nearly the same as that extending east of the Mississippi River, and across the southern states to the Carolinas and Georgia. The age is evidently the same, and the only apparent difference is in the color of some of the layers, those on the east of the Mississippi being derived from the Alleghany Mountains, and all those west of the the river, having the deep ferruginous tinge peculiar to the sediment brought down from the Rocky Mountains. I observed layers of this kind as far west as the borders of Texas, wherever wells were sunk to any depth. The superior layer, or that upon which the prairies immediately rest, is a whitish clay containing ferruginous gravel and rough calcareous concretions ; it is perfectly impermeable to water, and this may, in some degree, account for the absence of permanent vegetation ; the soil lying upon this, being very thin and holding all the water during wet spells, and on account of its small depth, drying very rapidly and thoroughly under the influence of the sun, at other times, becomes subject to great extremes of saturation and drought. This may be one reason why the vegetation of these prairies is almost entirely of a transient nature ; thus, in wet seasons, those plants are seen in abundance, which prefer wet localities, but these always disappear at the approach of drought. No plants are permanent except some hardy species of thorn trees, which bear these extremes, and even these are stunted. The drought is most injurious, for when a spot is shaded, trees grow to a large size. On all these prairies there are ponds, which, on account of the impervious nature of the clay, contain water at all seasons. They are often situated on the highest part of the prairie. They are surrounded by the *Zizania*, *Thalia dealbata*, *Cyperus articulatus*, and many other marsh plants. These ponds seem to be

gradually filling up with vegetable matter, and are no doubt rich in fossils of the mastodon, and perhaps other animals. During the last summer I visited three localities, at which remains of the mastodon have been found, and obtained some pieces. At one place, a mile distant from the village of Opelousas, an entire skull was disinterred, but it crumbled on exposure to the air, and nothing remained except the teeth; it must have been very large. It was discovered in excavating, in very dry weather, in order to deepen one of these marshy ponds for the use of stock. At about six feet from the surface, they came to the head and some of the vertebræ, and then to a few ribs, all of which were in the natural position, indicating the erect posture. Unfortunately, rain drove them from the search, and on account of the increased depth of the pond it has never been dug since.\*

A few days since, I visited a somewhat curious deposit of bituminized wood in this parish, (East Feliciana,) the bituminization being very perfect and very recent. It is at Port Hudson, on the Mississippi River. The following is a description of the place. The village is situated on a bluff, sixty or seventy feet high. This bluff reposes, as this whole country does, on a thick bed of blue aluminous clay, which forms the beds of most of our water courses, and wears very slowly by the action of water. At that place, the upper surface of the clay is considerably below high water. The bluff has been long falling in from being undermined by springs, which run out above the blue clay, and by the action of the current of the Mississippi; but the blue clay does not wear away near as fast, and for this reason it extends some distance beyond the base of the bluff. It seems that upon this shelf, the Mississippi has made a considerable deposit, of the common kind, containing a great many fragments, and sometimes entire logs; after this deposit took place, a considerable mass of earth must have fallen, covering the former one. The remarkably low water, together with the removal of the superincumbent earth to form a new landing place, has exposed the formation. The smaller logs are often entirely bituminized, and changed into a glossy black coal, in which no trace of fibre can be perceived; still the formation must be very recent, for in the most perfectly bituminized pieces there are frequent marks of the axe, looking as though

---

\* In the low lands bordering on the Calcasin River and Sabine, there are numerous springs of petroleum.

it was done but yesterday. The limbs are very much flattened, but otherwise, their external appearance is the same as usual in the species, which can easily be determined, being oak, walnut, hickory, &c. The larger logs and fragments have undergone the transformation in various degrees, some being of a soft and spongy texture. Many are in the state of perfect coal at one end, or on one side, and have undergone no change except softening at the other.

ART. XVI.—*On the Liquefaction and Solidification of Carbonic Acid*;\* by J. K. MITCHELL, M. D.

IN the year 1823, public attention was strongly drawn to the subject of the liquefaction by pressure of the, so called, permanent gases, by Mr., now Sir Michael Faraday.† Among the aerial fluids, carbonic acid was distinguished as requiring a force of 36 atmospheres at 32° F. to coerce it into the liquid state. His ingenious and hazardous experiments were conducted in glass tubes; and he depended on the accumulation of newly generated gas for the necessary pressure.

Mr. Brunel,‡ in a subsequent endeavor to apply compressed gases to mechanical purposes, produced a pint and a half of liquid carbonic acid, which, even at high temperatures, he confined in a series of small brass tubes not above the  $\frac{1}{8}$  of an inch in the thickness of their walls.

This interesting subject was not again publicly agitated, until the appearance in December, 1835, of a report on the liquefaction of carbonic acid on a comparatively large scale. In the last number for that year of the *Annales de Chimie et de Physique*, M. Thilorier described the properties of liquid carbonic acid in detail. According to him, this liquid demands for its existence as such at 32° F., a pressure, as stated by Sir M. Faraday, of 36 atmospheres. Its specific gravity is at the same temperature 0.830, at —4° F.—0.900, and at 86°—0.600. It is therefore enlarged by heat 3.407 times as much as its own or any other gas, when carried from 32° to 86°. From —4° to 32°, its expansion is almost exactly equal to that of the gases.§

\* From the Journal of the Franklin Institute.

† Philos. Trans. Lond.

‡ Quart. Journ. Vol. xli.

§ See at page 301 of this number, a notice of Mr. Robert Addams' experiments on this subject, and that of Dr. Torrey, in our miscellany.—EDS.

M. Thilorier found also that the expansive force is altered by heat so as to amount at  $86^{\circ}$  to 73 atmospheres, and at  $-4^{\circ}$  to 26 atmospheres. The density of the gas when resting over the liquid at  $86^{\circ}$ , is stated at 130 times the density of that which is compressed by the force of one atmosphere. Its pressure is therefore at  $86^{\circ}$  not much more than one half of that which its density would indicate.

When liquid, the carbonic acid is, on the same authority, immiscible with water and the fat oils, but is readily united with ether, alcohol, naphtha, oil of turpentine and carburet of sulphur. Although potassium decomposes it, lead, iron, copper, and the other easily oxidized metals, do not act on it.\*

The thermometric temperature observed in the jet by Thilorier, appears to be erroneously stated; for, as the *solid* is, at its formation, not below  $-90^{\circ}$ , and as the act of solidification of any vapor or liquid keeps the temperature, for the time, at the highest point compatible with the existence of the particular solid under observation, it follows that the jet of carbonic acid cannot fall below its freezing point. Immediately after its production, the carbonic snow begins to grow colder, and may be made to reach  $-109^{\circ}$  in the air,  $-136^{\circ}$  under an exhausted receiver. When moistened with ether, it can be depressed to  $-146^{\circ}$ . Professor Hare's ether acts much more effectually than sulphuric ether.†

At the immediately subsequent sitting of the Academy of Sciences, Thilorier announced the important fact that he had solidified carbonic acid. This he effected by suffering the liquid to escape into a bottle, or box, where, by the sudden gasefaction of a part, the remainder was frozen by the extreme cold thus produced. The solid is white, light, evaporable, and excessively cold. Because, surrounded by an atmosphere of gas which is constantly escaping from it, a fragment of it touched lightly by the finger, glides rapidly as over a plane surface.

Its evaporation is so complete as to leave no other trace of moisture than that which is caused by the coldness and consequent atmospheric humectation.

---

\* Among the most remarkable of the phenomena observed by Thilorier, was the intense cold produced by the sudden liberation of the liquid and its conversion into gas. A jet of it depressed the thermometer to  $-130^{\circ}$  F., and when sulphuric ether had been previously mixed with the liquefied gas, the refrigerating effects were more marked both on mercury and the sensations.

† See Dr. Hare's account of his Ether, at page 328, in this number.—EDS.

The force of its gasefaction is alleged to be equal to, but not so sudden as, that of gunpowder.

The temperature at which the solidification took place was presumed to be about  $-148^{\circ}$  F.; although the experiments before the committee of the Academy shewed  $-124^{\circ}$ .

Such is, in substance, the account by M. Thilorier of his novel and curious discovery, reported in the *Annales de Chimie*. No description of the method of procedure, or of the apparatus used, is annexed; and we are left to conjecture, and to the imperfect description of travellers, for any farther knowledge of either.

Having repeated the experiments of Thilorier, I deem it not useless to subjoin a draught of the instrument with which, aided by the suggestions of an intelligent pupil in France, and the assistance of friends here, I was enabled successfully to repeat most of the experiments of Thilorier, and to verify some, and correct other, of his results.

The apparatus consists of a generator of cast iron, A, supported by a wooden stand, B, a receiver, F, also of cast iron, connected to the generator by a brass tube, and fastened firmly to it by the stirrup screw, K; H, I, J, are stop-cocks, G, the nozzle of a pipe, L, a glass level-gauge, and S, M, R, a pressure-gauge.

The generator is 20 inches long and 6 inches in diameter exteriorly. Its cavity is 16 inches deep, and 3 inches, nearly, in diameter, so that it will hold about 4 pints. The walls are, of course, about  $1\frac{1}{2}$  inches in thickness. At the top, an aperture of two inches in diameter is closed by a strong wrought iron screw, the shoulder of which is let in about a quarter of an inch. The collar is of block tin, turned to the size of the shoulder of the screw. There is a hole in the head of the screw E for the reception of a long, strong iron bar.

The copper cup, N,  $1\frac{3}{4}$  inches wide, and 9 inches long, holds about 12 fluid ounces. There is a little handle at the top, and a copper wire at the bottom, which makes the whole length a little less than that of the cavity of the generator. This cup is used to introduce the sulphuric acid.

The brass tube between the generator and receiver is divided into two parts of equal length, which admit of being united by means of a conical juncture, kept tight by the stirrup and screw, K, K. Each of these portions of the tube may be closed or opened at pleasure by a stop cock. One is placed at I, another

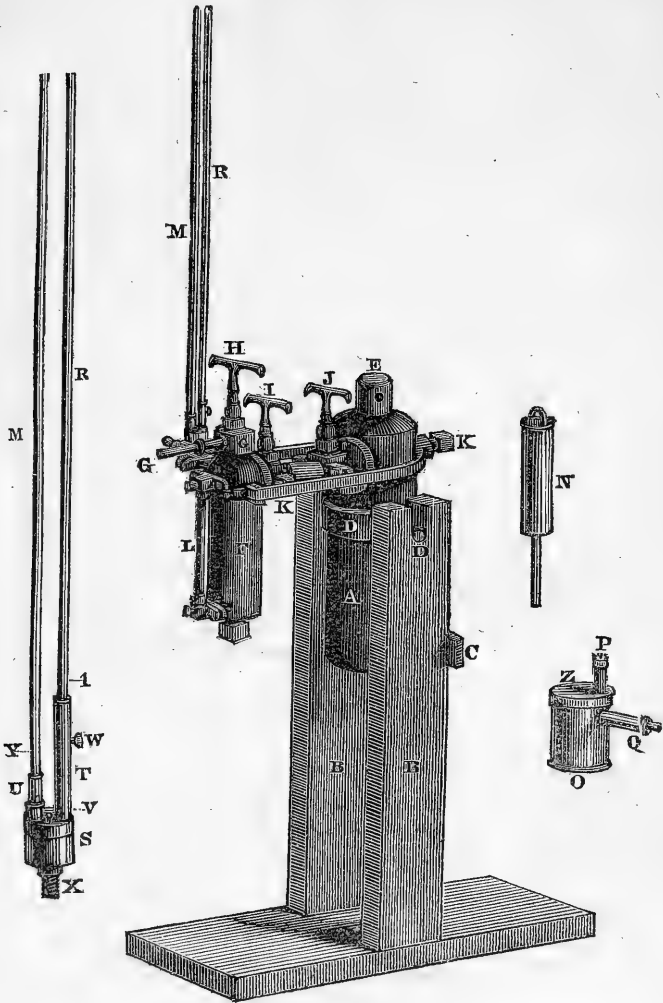

at J; so that when the receiver is being separated from the generator, the contents of both may be retained. The stop-cocks in common use are inadequate to resist the pressure, and therefore a screw stop-cock is indispensable. It is made to close a small aperture by means of a conical point, and having a double cone, it closes an outlet also when the cock is completely open, so as to prevent the escape of gas by the sides of the screw.

The receiver, F, is of the capacity of about a pint. The pipe, G, G, turned at a right angle at G, descends so as almost to touch the bottom of the cavity in F. The stop-cock H, G, is similar to I and J. L is a glass tube connected at each end to a socket of brass, which communicates with the interior of F. It is the gauge for observing the level of the liquid in F.

The gauge for measuring the pressure is peculiar. Into a wrought iron box, S, are inserted, by screws, two sockets, T and U. The former descends almost to the bottom of the box, which is nearly filled with mercury. Through the axis of the screw, X, a small tube passes into the cavity of S, and is continued to the top of it, so as to rise above the mercury. Two strong barometer tubes, R and M, are cemented\* into U and W, and hermetically sealed at the upper ends. These tubes are carefully graduated. In one of them, U, a short cylinder of mercury is made to stand at Y at the commencement of the experiment. The other, socket and all, is full of air, as no mercury is introduced into it. A very fine screw at W, enables the operator to regulate the quantity of air in T.

The tin cup, O, used to collect the solid acid, is covered by a lid, Z, perforated by a pipe, P, whose top is full of small holes. The handle Q, is hollow, so as to fit the end of the pipe of the receiver at G. To secure the hand of the operator from the cold produced by the experiment, the handle is carefully wrapped up in some kind of cloth.

The apparatus is prepared for use by removing the screw E, and placing  $1\frac{3}{4}$  lbs. of bicarbonate of soda in the generator, A,

\* The cement used was made of shell lac 3 or 4 parts, white or crude turpentine 1 part, melted at as low a temperature as possible, so as not to make bubbles in the mixture. This cement is very strong, but liable, without great care in the regulation of the heat, to have capillary tubes in it from the vaporization of the turpentine. This defect may be completely corrected by cutting away, when cold, the external mass of cement, and putting on a little common cap cement, which melts at a much lower temperature and closes the tubes.



to which 24 fluid ounces of water are to be added. After making these into a thin paste by stirring, 9 fluid ounces of common sulphuric acid are to be poured into the copper cup, N, and that is to be let down by a crook of wire into the generator. After the screw, E, has been firmly applied, and the stop-cock, J, closed, the contents of the generator are to be brought into admixture by moving it round to a horizontal position on the swivel D, which is supported by the wooden frame, B, B. There is a check bar at C. This motion is to be repeated several times. In about ten minutes the whole of the carbonic acid is liberated, and exists in A, chiefly in a liquid state.

The next step in the process is to attach, by means of the stirrup and screw, K, K, the receiver, F, *previously cooled by ice*. The keys, I and J, may then be opened slowly, and instantly the liquid carbonic acid is perceptible in the gauge, L. At the end of ten minutes, the communication with the generator may be cut off—when about eight fluid ounces of liquid acid at 32° F. will be found in the receiver.

By letting this liquid into the box, O, through the pipe, G, a large part of it is instantly expanded into gas, which escapes through the tube, P. The coldness consequent on the enormous expansion, freezes another part of the liquid, which falls to the bottom of O. About one drachm of solid matter is thus formed for each ounce of liquid.

The porosity and volatile character of the solid render its specific gravity of difficult ascertainment. When recently formed, it is about the weight of carbonate of magnesia, and when strongly compressed by the fingers, its density is nearly doubled. Solid carbonic acid is of a perfect whiteness, and of a soft and spongy texture, very like slightly moistened and aggregated snow. It evaporates rapidly, becoming thereby colder and colder, but the coldness produced seems to steadily lessen the evaporation, so that the mass may be kept for some time. A quantity weighing 346 grains lost from 3 to 4 grains per minute at first, but did not entirely disappear for three hours and a half. The natural temperature was from 76° to 79°. The solid is most easily kept when compressed and rolled up in cotton or wool. Its temperature when newly formed is not exactly ascertainable, because it is immediately lowered by evaporation. Thilorier seems to have entertained the opinion, that the greatest degree of cold was created

at the time of the formation of the solid. In my experiments, a constant decrease of temperature was observed, which was accelerated by a current of air, or any other means of augmenting evaporation. At its formation, the carbonic snow depresses the thermometer to about  $-85^{\circ}$ . If it be confined in wool or raw cotton, its cooling influence is retarded; if it be exposed to the air, especially when in motion, the thermometer descends much more rapidly; and under the receiver of an air pump, the effect is at its maximum. The greatest cold produced by the solid carbonic acid in the air was  $-109^{\circ}$ , under an exhausted receiver  $-136^{\circ}$ , the natural temperature being at  $+86^{\circ}$ .

The admixture of sulphuric ether so as to produce the appearance of wet snow, increased the coldness, for the temperature then fell, under exhaustion, to  $-146^{\circ}$ ,\* a degree of cold which we were not able to exceed by means of any variation of the experiment. That result is most easily obtained by putting about two fluid drachms of ether into the iron receiver before charging it. A compound liquid may be thus formed which yields a snow in less quantity, but of a more facile refrigeration. Alcohol may replace ether in either mode, but with less decided effect. In the air, the alcoholic mixture fell to  $-106^{\circ}$ , and remained stationary. By blowing the breath on it, it fell to  $-110^{\circ}$ . Left to itself, it rose slowly to  $-106^{\circ}$ ; but on being placed under an exhausted receiver fell to  $-134^{\circ}$ .

Every attempt to wet the carbonic solid with water, failed, so that no estimate of its relative effects could be made.

The experiments resulting from the great coldness of the new solid, were very striking. Mercury placed in a cavity in it, and covered up with the same substance, was frozen in a few seconds. But the solidification of the mercury was almost instantly produced by pouring it into a paste made by the addition of a little ether. Frozen mercury is like lead, soft, and easily cut. It is ductile, malleable, and insonorous. Just as it is about to melt, it becomes brittle or "short," and breaks under the point of a knife. These facts may account for the discrepancies of authors on this subject. Frozen mercury sinks readily in liquid mercury.

---

\* As  $-146+32=178$ , the cold is nearly as far below the ice-point as  $212-32=180$  is above it.

At about  $-110^{\circ}$  liquid *sulphurous acid* is frozen, and the ice sinks in its own liquid, and at  $-130^{\circ}$  *alcohol* of .798, assumes a viscid and oily appearance, which by increase of cold, is augmented until at  $-146^{\circ}$  it is like melted wax. Alcohol of .820 froze readily.

At  $-146^{\circ}$  *sulphuric ether* is not in the slightest degree altered.

When a piece of solid carbonic acid is pressed against a living animal surface, it drives off the circulating fluids and produces a ghastly white spot. If held for 15 seconds it raises a blister, and if the application be continued for 2 minutes a deep white depression with an elevated margin is perceived; the part is killed, and a slough is in time the consequence. I have thus produced both blisters and sloughs, by means nearly as prompt as fire, but much less alarming to my patients.

The specific gravity of liquid carbonic acid may be estimated either by weighing a given measure of it in a tube, and deducting the weight of the tube, and of a superincumbent gas, or by means of very minute bulbs of glass as suggested by Sir M. Faraday. By the latter means I obtained the following results, which are compared with those of Thilorier.

Temp. Fahr.	Sp. Gr.	Temp. Fahr.	Thilorier.	Sp. Gr.
32°	.93	32°		.83
43°.5	.8825			
51°	.853			
74°	.7385			
86°		86°		.60

The specific gravity particularly at  $32^{\circ}$ , was examined repeatedly, and with different bulbs, and always found to be at, or very near, to .93. The difference never amounted to .005. The sp. gr. as given by Thilorier at  $32^{\circ}$  is 83. The anomalous expansion of the liquid as indicated by both sets of experiments is truly surprising. By mine 73.85 parts raised from  $32^{\circ}$  to  $74^{\circ}$ , or  $42^{\circ}$ , become 93 parts, and gain 19.15 parts, while the same bulk of the gases acquires in the same range of temperature only 6.46 parts, or the liquid is expanded very nearly three times as much as its own or any other gas. According to Thilorier, 60 parts gain 23 parts by an elevation of  $54^{\circ}$ , while the same bulk of air would under like circumstances be augmented only by 6.75 parts; or the liquid is nearly four times as expansive as the gases.

As below  $32^{\circ}$ , or at reduced pressures, the augmentation of temperature is productive of much less expansive influence, we may infer that under the weight of a few atmospheres, as when near to its freezing point, liquid carbonic acid is scarcely more dilatable by heat than water. Between  $-4^{\circ}$  and  $+32^{\circ}$ , its expansion is 0.053 while that of air is 0.069. These facts suggest the inquiry how far water at *very high temperature and pressure* may be obedient to the same expansive influence, and thus by suddenly filling the whole interior of boiler, sometimes cause explosions.

The pressure of carbonic acid gas, when placed over its liquid, is given by Thilorier at  $32^{\circ}$  and  $86^{\circ}$ , as 36 and 73 atmospheres respectively. By means of the gauge S, M, R,—I found the pressure as follows:

$32^{\circ}$	- - - - -	36 atmospheres.
$45^{\circ}$	- - - - -	45 do.
$66^{\circ}$	- - - - -	60 do.
$86^{\circ}$	- - - - -	72 do.

The principle of the gauge renders it capable of registering the pressure with great accuracy;—for as one tube, M, begins to mark the pressure from the commencement of an experiment, and the mercury in the other, R, does not reach a visible point until the first has shown a pressure of several atmospheres, the second tube is equivalent in effect to one of several times its length. The first determines the amount of pressure, at which the mercury reaches the initial point on the 2nd, and the 2nd, subsequently, exhibits the multipliers of that initial quality. Thus, if when the mercury is at five atmospheres in M, it is at the unit mark in R, the value of that unit will be five, and the numbers representative of the pressure on R, must be multiplied by five; or R is equal in effect to a tube five times its length. By these means very short tubes may be used to determine very high pressures. Inequalities in temperature, irregularities in the cement, and other causes, may vary the capacity of the socket T, W, but as M always signifies the unit for R, in each case, no error can arise from these causes. There must, of course, be a correction for the weight of the mercurial column in R, which is to be added to the product. Care must be taken to keep the temperature of the vessel which holds the liquid below that of the gauge and tubes, otherwise the liquid will be formed by condensation in

the latter. This actually happened in the attempt to ascertain the pressure at  $86^{\circ}$ , when the natural temperature was  $75^{\circ}$ . Bubbles of gas were seen ascending through a liquid in M, up to its surface at a few inches below the mercurial cylinder. This as far as relates to the tubes may be avoided by prolonging the socket of M, down into the mercury of the cup, so as to include a cylinder of common air between two cylinders of mercury, and prevent any carbonic gas from entering either the socket, or the glass tube. A correction for the weight of this column, must in such case be made.

When a glass tube, hermetically sealed at one end, and cemented into a brass socket and screw at the other, is attached to a charged receiver and cooled by snow or pounded ice, liquid carbonic acid may be collected in it. It is perfectly colorless and transparent, and the specific gravity bulbs, previously introduced, are seen to ascend or descend, as the temperature is altered. When the tube so charged is opened, the liquid becomes violently agitated, escapes rapidly, grows colder and colder, and finally the remainder is converted into a solid, more dense than the snow already described, but nearly white, and very porous. If the tube be exposed to a paste of carbonic snow and ether, the liquid is solidified into a mass which is not porous but which sinks in the liquid as the latter is formed again by the melting of the solid.

The analogy between liquid carbonic acid and water, is thus completed for we have liquid, vapor, snow, and ice, exhibited by both.

By the previous introduction of water, ether, alcohol, metals, oxides, or oils, &c. into such tubes, and then filling them with liquid carbonic acid, the resulting phenomena may be easily observed. Water being heavier rests below the new liquid, and does not appear to mingle with it even at the surface of contact, for when the latter is let off no bubbles appear in the water, and it is frozen at the top into solid ice.

When alcohol or ether is introduced, the new liquid falls through it in streams, as water would do, but soon renders it milky by mixture. The removal of the pressure causes a violent effervescence, and immediately the clear, colorless ether, or alcohol, is seen alone in the tube; no solid being formed. When alcohol holds shell-lac in solution, the acid causes its precipitation in light whitish flocculi, which are immediately re-dissolved

when the acid is suffered to fly off. Nothing remains but the brown lac-stained liquid.

Liquid carbonic acid did not appear to act on any of the metals or oxides, but the experiments on this point demand a further examination. Its inaction is probably owing to the want of the force of 'presence,' or of 'disposing affinity.'

When the liquid has been frozen in a tube of glass, the tube may be melted off by the blow pipe, and hermetically sealed. Such a tube will always retain the liquid, or gas, the former, if in sufficient quantity, at all temperatures, if not, the latter alone will be found in it at high temperatures. I have one such tube, which begins to show moisture at  $56^{\circ}$ , and exhibits a constantly elongated cylinder of liquid, as the coldness is increased. At  $32^{\circ}$  the cylinder is about half an inch in length.

Carbonic acid mechanically powerful as it is, is not applicable, perhaps, either to locomotion or projection; but though the reasons for this are most of them obvious, the Franklin Institute has appointed a committee to investigate and report on the subject, that the exact truth may be known, and the waste of time and talent likely otherwise to be experienced, be saved to the country.

ART. XVII.—*On a general Electro-Magnetic and Magneto-Electric Formula.*

Extracted from the *Journal of Chemistry*, by Erdmann and Schweigger Seidel, and forwarded for insertion in this *Journal*.

MR. SCHWEIGGER repeated on the 26th of July, 1834, before the Society of Physicians of Halle, several of the experiments which he had already performed in his public lectures in the University. He demonstrated by those experiments that a magnet turning around its axis, produces a greater accumulation of electricity than a couple of small disks of zinc and copper, of about the size of a half crown, (or half dollar,) and are wetted in a solution of muriate of soda. For whilst the current of this hydro-electric combination produced a constant deviation of the needle of  $30^{\circ}$  to  $40^{\circ}$ , they observed in turning the magnet, instantaneous deviations of  $160^{\circ}$  to  $170^{\circ}$ , and the magnet being continually turned, the needle finally stopped between  $60^{\circ}$  and  $70^{\circ}$ .

In those experiments Mr. Schweigger employed an electro-magnetic multiplier, formed of only six brass-wires, one twelfth of an inch in thickness, which we shall designate by AE, A'E', A''E'', &c., and of which each was folded, as shows in the fig. 1, the line ABCDE. By means of small grooves filled with mercury, the extremities of these wires can be placed in communication in two modes, and thus send the current at will either from the first wire AE into the second A'E'; from this into the third A''E'', &c.; or in causing to communicate on one part all the extremities A, A', A'', and on the other, the extremities E, E', E'', through the six wires at once. In this last disposition, when the multiplier forms but one circuit, the current produced by the rotation of a magnet, and conducted to the multiplier by conductors of a pretty large mass, (thick bands of copper,) causes the needle to deviate instantaneously  $80^{\circ}$  to  $90^{\circ}$ , and if the needle continues to be turned, stops finally between  $50^{\circ}$  to  $60^{\circ}$ . If, the multiplier remaining the same, two disks of zinc and copper, wetted with a saline solution, are used, the constant deviation of the needle is but  $10^{\circ}$  to  $15^{\circ}$ .

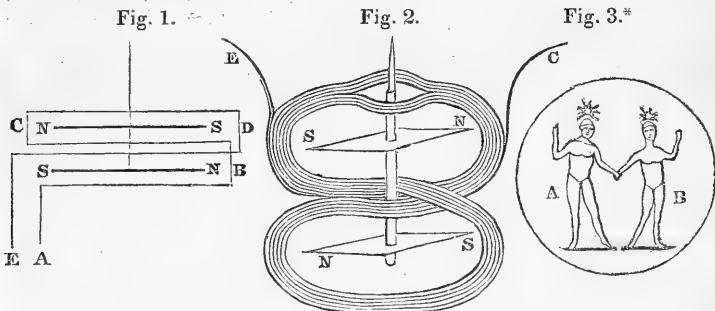

An ordinary multiplier, of which Mr. Faraday made use, composed of numerous turns, and formed with a wire, thin, and very long, folded as shown by fig. 2, (that which, according to the Journal of Chemistry and Physics, by Mr. Schweigger, 1825, Vol. III, is the best form which can be given to it,) produces a deviation of only  $10^{\circ}$  to  $15^{\circ}$ , by the current of the same magnet turning round its axis. By a proper combination of several magnets turning around their axes, this same multiplier (fig. 2,) shows an increase of the electric force, whilst the multiplier, which we described in the beginning of this note, and is destined

\* See J. S. C. Schweigger über Mythologie. Tab. I. Fig. 1.

to measure the quantity of electricity and not its tension, indicates, on the contrary, a decrease of strength.

Several variations of this experiment are easily deduced from the figure given above, (fig. 3,) which may be considered a general magneto-electric and electro-magnetic formula. In order to justify the idea of using the figure of man, we will request our readers to peruse what Mr. Pouillet says on the subject of the electro-magnetic figure of Mr. Ampere.\* The two stars on the head of those two figures are the symbol of the two electricities at the moment they unite, and the position of the same figures indicates the movement of the electric spark, as going from above downwards, and it is in *fact* thus that lightning (*foudre*) ordinarily moves. They know that this movement, from above downwards, of the electric spark produces magnetization all around it and in a plane perpendicular to its direction, and the whole passes exactly in the same manner as if the magnetism *were* conveyed by an austral pole, (that is to say, the pole of a magnetized needle directed to the north,) which is conducted in the same plane on the left, (from the west southward, towards the east, &c.,) and by a northern pole inseparable from it, which is conducted to the right, (from the east southward, to the west, &c.) It is thus that the figure A turning to the left, is the symbol of the austral magnetism, and the figure B turning to the right, that of the northern magnetism.

It is seen then that the direction of the spark or of the electric current, is indicated by the situation of these two figures, and that the movement of these same figures expresses the situation of the magnetic pole according to all the tangents, which, as indicated by this motion, are all comprehended in a plane perpendicular to the direction of the spark. All that is essential to electromagnetism being thus explained, our design is evidently a general symbol of the electro-magnetic phenomena, or a general formula, the application of which to all particular cases is very easy.

But this design is also a general magneto-electric formula. If, for example, the south pole of a magnet enter into an helix of copper wire, it produces evidently a separation of the magnetic fluid, since the northern magnetism is attracted and

---

\* Pouillet, *Elem. de Phys. exp.* Paris. 1832. Tom. I. P. 2. p. 242.



the southern magnetism repulsed. In taking this movement of the northern and southern magnetism for the commencement of revolutions in opposite directions of the two figures, they can be put in the helix in a corresponding manner, the situation of the figures which result from it will account then for the direction of the electric current.

If a southern pole, for example, is turned to the left around its axis, let us fancy the symbol of the southern magnetism introduced into the interior of the magnet in a situation corresponding to the direction of rotation: the electric current resulting from this, will be directed then from the head of the figure spoken of towards the feet. It is evident that the wire communicating to the southern pole, receives the northern magnetism at the place of contact, whether this contact is effected immediately or by the agency of the mercury. It will be seen that this wire will turn respectively to the right if the southern pole turns to the left, conformably to our symbol. And in effect, *is the essential point in this trial*, and departing hence, we can easily obtain a long series of varied and instructive experiments.

It is necessary to warn all those who intend to repeat them, to take all precautions to avoid thermo-electric currents, the multiplier described above being very subject to them. In effect, it can be easily demonstrated in experimenting in the manner indicated above, that the thermo-electric current is greater than an hydro-electric current produced by a single pair of zinc and copper disks, which are about equal in size to a crown, (or half dollar,) and are wetted with a solution of muriate of soda.

---

ART. XVIII.—*Fossil Encrinite*; by JOHN G. ANTHONY.

Cincinnati, September 11th, 1838.

TO PROF. SILLIMAN.

*Dear Sir*—ENCLOSED I send you a drawing of a specimen in my collection, which I found near this place in March last. The first specimen of this fossil was discovered by myself a year since, and consisted merely of the reticulated part, without any stem, and but a small portion of the fimbriæ. During the past winter more than seventy similar specimens were washed out by the rains from the rubbish of a quarry, and picked up,—

the present is decidedly the best specimen which has rewarded our search.

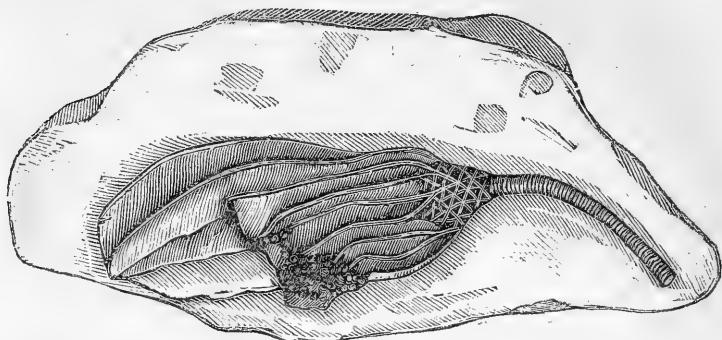

For want of any systematic work on the fossils of our strata, I cannot venture to say whether it is described or not. It is undoubtedly one of the encrinite family, probably an apiocrinite, and the present drawing is forwarded for publication in your Journal, with a view to enable some one better acquainted with the subject to determine its specific name.

The letter accompanying the notice of Dr. Warden's trilobite in your July number,\* is calculated to convey an erroneous impression that his species is entitled to priority. The statement made to me by Dr. W. was, that his sister received the specimen from some one, and had put it away with many others, without being aware of its true character, and that on his visit to Springfield about a month after he saw my specimen, he noticed this, and brought it away with him to Cincinnati. That Dr. W. was not aware of its existence previously, is evident, for he drew up the report alluded to in his letter, and therein says, "it is undoubtedly the shield of an undescribed trilobite furnished with feelers or tentaculæ; this is a very important fact to establish, as it will prove conclusively, that the trilobite family are properly considered analogous to the crabs," &c. &c. Throughout the report he makes no allusion to any other specimen as bearing any analogy with it, or conflicting in any degree with its claim to priority. As this claim was set forth in my communication to the Academy, and as he takes no notice of it in his report, it is evident, that at the time, the existence of his sister's specimen was unknown to him.

---

\* Vol. xxxiv, p. 379.

ART. XIX.—*Report on the Shooting Stars of December 7, 1838, with remarks on Shooting Stars in general.* By EDWARD C. HERRICK, Record. Sec. of the Conn. Acad. of Arts and Sciences.

At the conclusion of the Report on the meteors of last August, (p. 173 of this vol.) it was stated that on the night of Dec. 6, 1798, Brandes witnessed a remarkably large number of shooting stars.\* This fact was first communicated to me in April last, by Professor Loomis, of Western Reserve College. Believing that phenomena of this nature result from celestial causes more or less permanent, I at once entertained strong hopes and considerable expectation that a return of this display would *now* be seen on or about the same period of the year. I well knew that our knowledge of the true system of shooting stars was too imperfect to warrant the prediction, that a meteoric display which had been once observed, would ever after, in greater or less degree, be visible at the same season, *in all parts of the earth.* Yet the fact that since proper observations have been made, a season of meteoric abundance has been detected, about the 10th of August and the 13th of No-

---

\* The entire account of this display is given in the following extract, the original of which arrived to-day in a letter from Prof. Loomis. The work from which it is taken, is entitled, "Versuche die Entfernung, die Geschwindigkeit und die Bahnen der Sternschnuppen zu bestimmen: von J. J. Benzenberg und H. W. Brandes. Hamburg, 1800. 8vo."—"It will be proper here briefly to relate an observation which I [H. W. Brandes] had an opportunity to make, while on a journey from Göttingen to my native place. As I was travelling, on the evening of the 6th of December, 1798, from Harburg to Buxtehude in an open post-wagon, I had the gratification of seeing a larger number of shooting stars than I had ever before witnessed. I first noticed them soon after the close of evening twilight, and having no other business, I kept count of the number which appeared in the small segment of the heavens which I could with convenience survey from my seat. For the sake of greater accuracy, at the end of every hundred, I noted the time by my watch, which there was just light enough to enable me to do. They appeared in such numbers that for about four hours, I counted as many as 100 an hour. Occasionally they came at a much more rapid rate;—often 6 or 7 in a minute. After this, [about 10 P. M.] they were much less frequent, and during the whole night, I saw only 480, although I had counted in the four first hours alone, over 400. In order to be certain that no one portion of the sky was richer than the rest, I looked occasionally at other parts of the heavens, but found no difference. I may, therefore, safely say, that on this evening, many thousand shooting stars must have been visible above my horizon."—It does not appear that Brandes noticed at this time any point of radiation; or that he watched in subsequent years for a return of the display. The idea of a periodical shower of meteors had then probably never been advanced.

vember,\* added strength to my hopes. On the other hand, my confidence in the return of the display was somewhat shaken by the apparent absence of any other records of unusual meteoric appearances at this season. A *very extensive* search will probably bring some such to light, but if it should not, it will at least prove anew, how easily a phenomenon of this kind, when not specially watched, may pass unnoticed. However, the chance of a re-discovery of this long-lost shower, induced me to request several friends in various places, who had previously obliged me in a similar way, to keep up a vigilant watch at this season. Few returns have yet been received, and from some of the distant observers, they can not be expected under many months. The observations made in this city show conclusively that the number of meteors visible here about the 7th of December, 1838, was for several hours, from six to eight times beyond the average. Those detailed in the following table, were made here by Messrs. C. P. Bush, A. B. Haile, J. D. Whitney, B. Silliman, Jr., and myself. They comprise, with one exception, every favorable evening from the 4th to the 15th, inclusive.

I. *Observations on Shooting Stars made at New Haven, Conn.  
December, 1838.*

Date. 1838.	Time of observation.		No. of ob- servers.	Quarters of the sky observed.	No. of mete- ors seen.
Dec. 6	8h. 8m. to 9h. 8m.	P. M. =60min.	1	E.	23
" "	10h. 5m. to 11h. 5m.	P. M. =60 "	2	S. E. & N. N. W.	32 & 12m.
" 7	0h. 20m. to 1h. 5m.	A. M. =45 "	2	S. S. E. & N. W.	10 & 15m.
" "	4h. to 5h.	A. M. =60 "	1	E.	21m.
" "	8h. to 9h.	P. M. =60 "	2	E. & W.	62 & 31
" "	9h. to 10h.	P. M. =60 "	2	E. & W.	43 & 28
" "	10h. to 11h.	P. M. =60 "	1	N. E.	46m.
" 8	7h. 15m. to 8h.	P. M. =45 "	1	E.	15
" "	8h. to 9h.	P. M. =60 "	1	E.	25
" "	8h. 15m. to 9h.	P. M. =45 "	1	W.	19
" 11	8h. 45m. to 10h.	P. M. =75 "	1	E.	18
" 12	6h. to 7h.	P. M. =60 "	1	E.	6
" "	8h. to 9h.	P. M. =60 "	1	E.	12
" 13	0h. 45m. to 1h. 30m.	A. M. =45 "	1		10
" 15	6h. to 7h.	P. M. =60 "	1	E.	2
" "	6h. 25m. to 6h. 40m.	P. M. =15 "	1	W.	0
" "	8h. to 9h. 15m.	P. M. =75 "	2	E. & W.	3 & 4

\* The "meteoric shower" of November, 1838, came chiefly on the morning of the 14th. According to observations made at Middlebury, Vt., and published in "The People's Press," by Prof. A. C. Twining, meteors were visible that morning from 4h. to 6h. in the whole heavens, at the rate of 105 per hour; and for a short time the next morning, they were nearly as numerous.

During the above observations the sky was sufficiently clear. Where *m* is annexed to the number seen, allowance must be made for the presence of the moon  $5\frac{1}{2}$  or  $6\frac{1}{2}$  days past the full. This table shows, that a season of meteoric abundance extended from the 6th to the 11th (at least,) and that it came to its maximum early on the evening of the 7th. During the evenings of the 6th and 7th, shooting stars were so frequent and brilliant, that they attracted the attention of persons abroad in different parts of the city. Being then ignorant as to the period of the night at which the display of Dec. 6, 1798, occurred, and having fallen in rather too hastily with the common conclusion, that *meteors are always most abundant between midnight and morning*, my arrangements were made chiefly for a *morning* watch. The appearances were consequently not so well observed as they would have been, but for a reliance on this premature generalization. On the evening of the 6th, meteors were not much less numerous than on the evening of the 7th, and they *did not increase in number after midnight*.\* Professor Olmsted informs me that on the evening of the 7th, from  $6\frac{1}{2}$  to 8 p. m., he, with two of his sons, (F. A. Olmsted, and D. Olmsted, Jr.,) without very close attention, and in much less than the whole heavens, counted meteors at the rate of at least 100 an hour. He remarked that at 8 they were becoming less frequent. From 8 to 9, Mr. Haile and myself observed *ninety three*, and we probably saw not more than half the whole visible number; for, although a single observer can see large meteors throughout *half* the hemisphere, yet he can not detect all the smaller ones, (which are commonly the majority,) throughout more than an *eighth part* of the hemisphere. The meteors slightly diminished in number, as the evening advanced; but much to our regret, we were prevented, after about 11 p. m., by an overclouded sky, from determining the rate of diminution, or the general progress of the phenomenon. On the morning of the 8th, Mr. Haile watched from  $4\frac{1}{4}$ h. to  $5\frac{1}{4}$ h. (about a sixth of the hemisphere, in the N. W. being nearly clear,) and saw *five* meteors.

The meteors of the 6th and 7th were not unlike those of ordinary times:—many of them were large and splendid fire-balls,

---

\* The coincidence in this respect between the meteors of Dec. 6, 1798, and those of Dec. 6 and 7, 1838, is obvious.

and attended with trains. On both evenings, (before 11 p. m.) most of the meteors appeared, (as all the observers agreed,) to radiate from a spot not far from Cassiopeia; or perhaps, more nearly, from the vicinity of the cluster in the sword of Perseus. The radiant, however, could not well be fixed, within three or four degrees. So far as it could be determined, this spot was, up to midnight, either stationary among the stars, or moved westward almost as rapidly as they did. After midnight of the night of the 6th—7th, the meteors appeared not to present any common center of radiation.

## II. *Observations in other places.*

1. At *Middletown, Ct.*, on the evening of the 7th, Prof. A. W. Smith, with Messrs. Knox and Rice, saw in the eastern sky, between 10h. and 11h., *seventy eight* meteors: one of the observers being absent half an hour. They stood mostly on the east side of the University building, and but little more than half the sky was under review. Prof. S. saw 20 meteors between 8h. and 9h. Most appeared to radiate "from the zenith." The sky was overcast at 11h.

2. At *Geneva, N. Y.*, Mr. Azariah Smith, Jr. undertook observations in company with Mr. M. M. Bagg. Being occupied in the evening, their attention was directed chiefly to morning observations, but a clouded sky interfered on the mornings of both the 6th and 7th. Early on the evening of the 6th, Mr. S. in a short walk, noticed meteors at the rate of one per minute, but his engagements did not permit any observations until after 9, when the sky was partially cloudy, and not long after almost wholly overcast. From 9h. and 10h. he saw between and behind the floating clouds, only 3 or 4 meteors. Mr. S. remarks, "so far as can be determined by the few observations I made in these unfavorable circumstances, I should judge that the radiant point was near to, but S. of, Cassiopeia, and perhaps a few degrees E. of that.—I cannot entertain the least doubt but that there was an unusual display about the 6th and 7th inst., for on mornings and evenings previous, I saw nothing similar in kind or number to those of the evening of the 6th. I learn from some friends of mine, who knew nothing of the anticipations with regard to this phenomenon, that on being out during the evening of the 6th, they saw so many falling stars that they concluded to

sit up all night and see if there would not be a shower, but under the unfavorable circumstances their hearts failed them.”

3. At *Hudson, Ohio*, clouded skies prevented observation.

4. From *Savannah, Ga.*, Mr. T. R. Dutton writes: “The entire night of the 5th was rainy. On the night of the 6th I made occasional observations from my window, (without seeing more than 2 or 3 meteors,) between 11h. and 2h. 30m. when I went into the open air.\* From 2h. 30m. to 3, I saw 5 meteors, and from 3h. 15m. to 3h. 30m., none. The sky was partly covered with broken clouds, yet not enough so to obscure more than a third of the meteors visible; but soon after it was entirely overcast. On the evening of the 7th, I made occasional observations as before, until 2h. 55m., when I went into the open air. During 45 minutes I saw 11 meteors, 4 or 5 of which had trains. The sky was partly covered with thin cirrous clouds,—the western half, however, afforded a clear field of view. On the night of the 8th, I watched from 3h. 25m. to 3h. 55m. and saw eight meteors.”

#### *General Remarks.*

From the observations made here, it may safely be concluded that for four or five hours, on the evening of the 7th of December, 1838, shooting stars appeared at the rate of from 125 to 175 per hour. If we compare this with the average which I had previously fixed upon, for this season of the night, (viz. 25 per hour) it results, that on this occasion meteors were about *six* times as numerous as usual. If we adopt M. Quetelet's *general average*, of 16 per hour, the number was about *nine* times the mean. More extensive observations will doubtless change both these averages. No one can however doubt that the displays of the evenings of the 6th and 7th were quite unusual. For several days after this period, meteors were rather more numerous than usual, but by the 15th, the *meteoric season* appeared to be altogether over.

It is evident that the position of the *radiant* was at a great remove from that point in the heavens, towards which the earth was at the time tending; and it is worthy of notice, that in this respect, and partially in another, the December display resembles that of August. In the November “shower,” the radiant is very

---

\* Shooting stars *must always* be watched in the open air: observations through a window can not be trusted.

nearly in the ecliptic. The grand display of April 20, 1803,\* agreed with all the November displays, in this, that it appeared chiefly after midnight, but where the radiant then was, no man can tell us.

There are other seasons in the year at which meteors may possibly be found unusually numerous: some of these are,—Oct. 8—15, June 10—20, Jan. 2, Feb. 15, July 28, Sept. 11, Nov. 8. It is not worth while here to give the details of the various accounts from which these dates are taken. They are generally vague, and mostly reported by those who had no just ideas concerning the average number of meteors. Of this list, the two first appear the most worthy of attention. Observations should however be made at all these seasons, and indeed at all possible times; for it is alike important that we should ascertain those seasons in which meteors are uncommonly rare, and those in which they are uncommonly abundant.†

In order to obtain all the data necessary for the formation of a theory of shooting stars, we must have observations in various places and at various times, which will show us not only their numbers and their apparent motions, but also their *true* velocities, directions, and distances. This is a part of the subject which demands vastly more labor and skill, than the other. It is far from certain, that the results obtained by Benzenberg,‡ Brandes, Quetelet, and their associates, will apply with general accuracy to parts of the year, or of the night, different from those in which they were obtained, and it is therefore much to be desired, that similar connected observations should be made in all regions of the earth,

---

\* This shower ought to be re-discovered, and there can be little doubt that if diligent observation should be made at this season of the year, in all quarters of the globe, some evidence of its return might be detected.

† If any person who has the opportunity, will consult the *Ephemerides Societatis Meteorologicae Palatinae*, (5 tom. 4to. Mannheim., 1785?) and publish anew all the observations on luminous meteors contained in that valuable series, he will do a service to science. The work is inaccessible here, and seems to be nearly forgotten every where.

‡ This gentleman, a Professor at Düsseldorf on the Rhine, divides with Prof. Brandes of Leipsic, (who died in May, 1834,) the honor of having first made (viz. in Dec. 1798) definite observations on the distances, velocities and paths of shooting stars. The 1st livr. of the 3d series of Quetelet's *Corresp. Math. et Phys.* 8vo, Bruxelles, Août, 1837, (the only one I have seen,) contains a very interesting letter on this subject from Benzenberg; and also a valuable paper by Quetelet, giving the details of the simultaneous observations made by himself and his associates, on five nights, between 9 and 12, P. M., in June and July, 1824, together with three methods of calculation applicable to these observations.



both morning and evening. It may be found, that a constant difference exists in the directions and velocities of the meteors which occur during the August season, and of those of the displays which occur in November, December, and April.

Enough appears to be already known to establish the proposition, that shooting stars are small bodies of various sizes, materials and densities, revolving around the sun, and luminous in consequence of the heat excited by their casual passage through our atmosphere.\* They have not inappropriately been termed by M. Coquerel, *microscopic planets*. So far as we know, they have the same astronomical relations as the larger luminous meteors called *fire-balls*, *bolides*, *meteorites*, &c. They are encountered by the earth's atmosphere probably every hour in the year, but in much greater numbers at certain parts of the earth's orbit, than at others. The distribution of these bodies throughout the solar system can not yet be determined. The majority of them probably move in groups, and may be supposed to constitute one or more broad zones or rings, in some parts of which meteors are exceedingly numerous. When, at the return of certain periods,† the earth traverses these dense parts, great meteoric showers occur, like those of the years 686, 29, 25, B. C., and those of A. D. 532, 558, 750, 765, 901, 935, 1095, 1096, 1122, 1799, 1803, 1832, 1833. It may be supposed that in other years, the earth passes through a part where the meteors are less numerous, and then only a *sprinkling* of meteors is seen. Whether there are more zones than one, and if so, how they are situated, are problems which will probably long remain unsolved. Whether these meteors are the fragments of the supposed exploded planet, of which the four *asteroids* may have formed a part,‡ or whether they were originally independent bodies, will perhaps be determined at a much later day. These

---

\* This opinion is far from being new. It is found in substance in Plutarch's Life of Lysander, and although it has never been very generally received, yet it has always had some supporters. It was ably illustrated and defended by the celebrated Chladni; and it is maintained by many at the present day.

† The cycle of the November shower seems to be, without much doubt, 33 or 34 years: that of the April shower is perhaps about 27 years.

‡ This hypothesis, advanced by Prof. Wildt, is quoted with a partial approval by the distinguished Olbers, in a valuable paper on shooting stars in Schumacher's *Jahrbuch für 1837*. It is remarkable, that a very similar idea is found in De Mezeray's *Hist. de France*, (4to, Amst. 1755, tom. ii, p. 156,) in an account of the meteoric shower of 1096; his words are, "On vit durant plusieurs nuits pleuvoir des Etoiles, par intervalles, mais si dru et menu, qu'on eût dit que c' étoient des *bluettes* du débris des orbes celestes."

little bodies doubtless reflect the sun's light, but in consequence of their minuteness, they are rarely, if ever, seen in this way. There is however room to hope, that they may be occasionally detected by powerful telescopes, while moving in their celestial paths, across the sun's disk. The discovery by Pastorff, in this mode (Bib. Univ. de Genève, 1835, t. 58, p. 434) of two or more new asteroids, and the previous observations of Gautier and Messier, induce the belief, that similar investigations hereafter will reveal important results.

It has been conjectured, that shooting stars proceed from the luminous appearance, long known and little understood, called the *Zodiacal Light*. It may therefore not be irrelevant to advert to the fact, that the earth is in a situation more favorable for collision with this body, early in December, than in the middle of November.

An account of the progress of discovery concerning the meteoric season of August, together with some additional observations on the meteors of August 9—11, 1838, are postponed for want of room.

New Haven, December 24, 1838.

---

ART. XX.—*On the Meteoric Shower of November, 1838*; by DENISON OLMSTED, Professor of Natural Philosophy and Astronomy, in Yale College.

EFFICIENT arrangements were made at Yale College, by a number of young gentlemen of the senior class, in conjunction with myself, to watch the heavens on the night of the 12th and 13th November, with the view of ascertaining whether the meteoric shower which has occurred, to a greater or less extent, at this date, for several years past, would be repeated the present year. The night was unfavorable for observation; still, occasional glimpses of clear sky, were seen at different times of the night, sufficient to have recognized the phenomenon, had it occurred in a manner corresponding to the exhibitions of former years. Although a few meteors were seen, yet we adopted the conclusion, that, at this place, *there was no extraordinary appearance of shooting stars on the morning of the 13th November*. On the following morning, Nov. 14, shooting stars were more frequent; but we did not feel authorized from our observations, to pronounce

that the exhibition was so remarkable as to be properly denominated a "meteoric shower." I find, however, that some of my friends and correspondents abroad were more fortunate. The most decisive communications which I have seen on this subject, are from Professor A. C. Twining of Middlebury College, Vermont, and from Mr. E. Fitch, Professor of Mathematics in the United States Navy, who was then on a cruise in the Gulf of Mexico.

According to the statements of Professor Twining, published in a Middlebury paper, a vigilant watch was maintained by himself and nine of his pupils, from the 10th to the 15th of November. The results of their observations were as follows:

Nov. 10.—From 3 to 6 A. M., the whole number of shooting stars observed was 70, of which 40 were from the constellation Leo, within the bend of the sickle. Eight were attended with trains. The observations on the two following mornings presented nothing differing much from those of the 10th. The night of the 13th was cloudy, and no observations could be obtained.

Nov. 14th.—The morning was mostly clear from 4 to 6 o'clock, which was the period of observation. The phenomena differed remarkably from those of the preceding mornings, both as respects the number of falling stars, and their appearance. A large portion of the whole were attended by trains. The number was more than three times as great as on either of the previous mornings, being at the rate of 105 per hour. One meteor of remarkable size and splendor, shot from the common radiant, to the Great Bear, where it exploded, leaving a bright streak about two degrees long, which turned slowly to a vertical position, then expanded into a cloud which continued visible nine minutes, and moved in a westerly and descending direction about seven degrees before it became invisible. The flash of this meteor was seen by observers looking in the opposite direction, to illuminate the earth's surface like a faint flash of lightning. The spot where the explosion took place, was in Right Ascension  $182^{\circ}$ , and Declination  $46\frac{1}{2}^{\circ}$ . Of all the meteors observed on this occasion, nine out of ten had their courses in a direction from a common radiant, situated in the upper part of the bend of the sickle in Leo.

On the morning of the 15th, shooting stars were very frequent, but less so, on an average, than on the preceding morning, and far less regular with regard to a common source, or radiant.

By a letter from Professor Fitch, dated from the Gulf of Mexico, I learn that he watched for shooting stars on the morning of the 13th November, but considered the number and size of such as fell, as not above the average in that latitude. On the morning of the 14th, from 3 to 4, he counted 40 shooting stars; and from 4 to 5, he counted 45. He thinks the number obscured by clouds probably one fourth of the whole. The point of radiation was  $2^{\circ}$  E. S. E. of gamma Leonis. It will be seen that these statements agree remarkably well with those of Professor Twining, although probably the numbers reported by Mr. Fitch ought to be considerably increased, in consequence of there being at that station but a single observer.

The unusual frequency of the meteors seen on this occasion; the precision with which they conformed in their courses to what has heretofore been observed at the same date; the occasional brilliancy of individual meteors; the number and brightness of the attendant trains; and the time of the morning when the display reached its maximum; these circumstances afford, in connexion, conclusive evidence of the identity of this exhibition with those heretofore observed on this anniversary, although, according to anticipations expressed several times in this Journal, the phenomenon is repeated on a constantly diminishing scale.

As several of the most eminent astronomers of Europe, are now occupying themselves with the "Theory of Shooting Stars," (which some of our own astronomers have supposed beneath their attention,) we may hope that, before long, the difficulties which attend the explanation of the "origin of shooting stars" will be completely removed, and we shall know whether to regard them as atmospheric concretions, or as visitants from another sphere.

P. S.—*Extract of a Letter from Mr. WILLIS GAYLORD, dated Otisco, New York, Nov. 22, 1838.*—A brilliant flight of meteors was seen from this place on the morning of the 14th instant. The nights of the 12th and 13th were cloudy, rendering observation impracticable. My attention was called to the frequent occurrence of meteors a few minutes before 6 o'clock; and from that time until the moon and the opening day caused their disappearance, there was an almost continued succession of them. I have never, at any time, seen so many, in so small a space of time, except in the great meteoric shower of November, a few years since. The point of radiation was a few degrees S. E. of the zenith, and every meteor had the same direction, viz: southeast. The trains of some were brilliant, but in general they disappeared quickly, though some continued their flight across a quarter of the heavens.

ART. XXI.—*Communication respecting Fossil and Recent Infusoria made to the British Association at Newcastle.* By Prof. EHRENBERG.\*

To the Editors of the Annals of Natural History.

*Gentlemen,*—You will much oblige me by inserting the subjoined notice, which has been occasioned by the erroneous report in the Athenæum of the statement made by me at the late Meeting of the British Association in Newcastle, in the section of botany and zoölogy, which statements, so far as I can recollect, were to the following import :

For the purpose of physiological inquiries I have occupied myself with the investigation of microscopic organized beings, not only in Europe, but also upon several voyages for several years in other quarters of the globe. The results of my observations had been hitherto scattered in single memoirs, published in the Acts of the Royal Academy of Berlin. Within these few weeks, however, my large work on this subject has been completed,† which consists of a thick folio volume of text and 64 folio copper plates, in which I have endeavored to bring together the whole of our present knowledge of microscopic beings, with their history in as complete a state as possible. This book, which I had the pleasure of laying before the section, is not (as stated) the first volume of a work, but complete and entire in itself, and is now in the booksellers' hands. It contains drawings of all the 722 species observed by me up to 1835. It is however merely a first essay on this highly interesting and at present inexhaustible subject. I then in a few words directed the attention of the section to the importance of the observation of microscopic beings, as a highly influential zoölogico-botanical subject, and exhibited earths which were entirely formed of the shields of some Infusoria. I mentioned the eatable infusorial earth from Lillhagsjön in Sweden, from Finland, and from Kliecken near Dessau, where they occur in great natural layers; I stated that the greatest layer

---

\* From the Annals of Natural History, No. 3, p. 121, London.

† *Über Infusionsthierchen, mit einem Atlas von vier und sechzig Kupfertafeln.* Von Christian Gottfried Ehrenberg.

hitherto discovered was above 28 feet in thickness, near Lunenburg; that however similar layers have already been found in Africa, Asia, and the South Sea Islands. At the same time I noticed that I had succeeded in artificially preparing from still existing Infusoria very considerable quantities of earth. I exhibited a large glass full of such artificial siliceous earth, in which the microscope, however, still evidently and distinctly discovers all the forms of the Infusoria constituting it, pounds and tons of which earth may easily be prepared. I mentioned in few words the still existing controversy between botanists and zoölogists, both of whom would class in their catalogues these microscopic living forms; and I briefly noticed the reasons given in detail in my work for each opinion, deciding myself in favor of their being animals.

I also said a few words on the luminosity of the sea, which subject in part stands in immediate connection with these microscopic animals, it being regarded an act of animal life; and I invited attention to the fact that the luminosity in Infusoria and Annulata is an evident voluntary production of sparks, so that in the latter there originates a light apparently continuous and tranquil to the naked eye, from numerous microscopic sparks following each other in quick succession. The analogy with electrical phenomena is very close, and it is especially worthy of attention, that evidently the smallest animals give the largest sparks, in proportion to the size of their body, and consequently very probably produce the greatest electrical tension.

I then mentioned the curious formation of double gems in *Closterium* and in the *Confervæ conjugatæ*, which is figured in the plates of the family of the *Closterinæ*, and I concluded with a remark on the astonishing great fertility or capacity of increase of microscopic animals, according to which an imperceptible corpuscle can become in four days 170 billions, or as many single individual animalcules as contained in 2 cubic feet of the stone from the polishing slate of Bilin. This increase takes place by voluntary division; and this is the character which separates animals from plants. It is true, that the gemmation in plants, especially in very simple cells, is at times very similar to the division in animals, but this relates to the form, not the formation. A vegetable cell apparently capable of self division always became

one, or contemporaneously many exterior warts (gems) without any change in its interior. An animal which is capable of division first doubles the inner organs, and subsequently decreases exteriorly in size. Self division proceeds from the interior towards the exterior, from the center to the periphery; gemmation, which also occurs in animals, proceeds from the exterior towards the interior, and forms first a wart, which then gradually becomes organized.

A discussion now arose between Prof. Rymer Jones and me. Prof. Jones observed, that although he had himself taken great pains, yet he had never been able to see the structure described by me of the interior organization, viz. of the alimentary canal of the polygastric Infusoria, although he had found the external forms to be exactly the same. He had not been able to discover any trace of an alimentary canal, and in *Paramæcium Aurelia* and other species he had observed a circular motion of the inner cells which could not agree with the formation I had described. I answered him, that such discussions then only could lead to a result when they do not merge into general but enter into special cases. The mass of relations of organization, which after many years of observation have been gradually established, could not be brought into question by a single doubtful fact. The perfect organization of the wheel animalcules had been established beyond all question. With regard to *Paramæcium Aurelia*, this is one of those forms unfavorable to such observations; and it had been expressly observed by me that I myself had not been able to recognize the alimentary canal in all species of the various genera; but on the other hand it was quite evident in a very considerable number of species and genera. I stated that in my present work this subject had been treated of in detail, and that those forms in which the relations are perfectly evident have been purposely enumerated. Some of these forms I then exhibited in the drawings, and concluded with the remark that the circular motion observed by Prof. Jones had already been treated of by others, (for instance, Dr. Foeke,) and had naturally been frequently observed by myself. The great contractibility of the body of the animalcule was, to less practiced observers, frequently a cause of enigmatical phenomena, of which continued patient observation of the object would gradually bring the explanation. Thus, at times, the intestinal canal of the animalcule extends at the expense of the ventral

sacs so far, that it occupies the whole space of the body, and then the devoured substances, very similar to the ventral sacs, circulate in the whole body.

Yours, &c.

EHRENBERG.

London, Sept. 15, 1838.

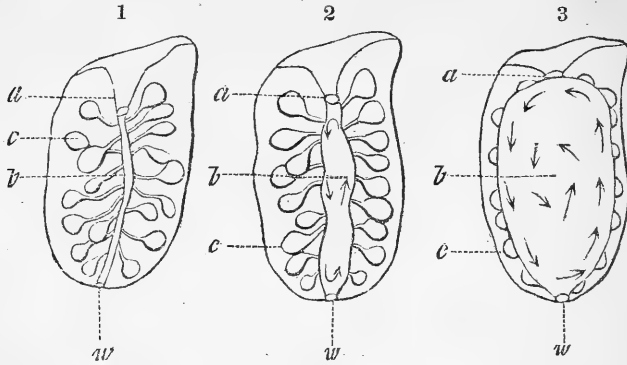

Ideal figures of *Loxodes Bursaria* in various states of the extension of the alimentary canal, and its inner circular motion, not of the ventral sacs, but of the contents of the sacs voided into the canal *a* the mouth, *b* the alimentary canal, *c* ventral sacs, *w* canal aperture.

#### MISCELLANIES.

1. *Dr. TORREY'S\* Experiments on the Condensation of Carbonic, Sulphurous, and Chloro-chromic Acid Gases.*—We have been, from time to time, informed by letters from Prof. John Torrey, of New York, of his progress in the condensation of gases, and we now take the liberty to give some few citations from his letters, although not intended for publication, satisfied that Dr. Mitchell, who has given us such fine results, will be glad to see them, and trusting that Dr. Torrey will pardon the use made of his private communications.

*March 5, 1837*—It is stated by Prof. T. that a few days before he had prepared several tubes of liquid carbonic acid at Princeton, New Jersey.

*April 11*—He writes again, that although he had been unable to get a mechanic to construct an apparatus for condensing carbonic acid, he had made many experiments on the subject in tubes of glass, and with entire success. He says, that only a single accident occurred, which however

\* See Dr. Mitchell's Experiments, p. 346. Also at p. 301, Mr. R. Addams's remarks on the same subject.—EDS.



did no serious injury. Having a fine quantity of the condensed liquid in a sealed tube, but wishing to aid the generation of carbonic acid by heat, he plunged one end of the tube into hot water in a tumbler, while the other end was enclosed in a freezing mixture, when it burst, shattering the tumbler, &c., but the water greatly abated the force of the blow. The explosion was caused by the formation of crystallized sulphate of ammonia, from the action of the sulphuric acid upon the carbonate of ammonia, (the materials used to afford the gas,) which sublimed and choked the tube, about half way up, so that the carbonic acid gas that was evolved had not the benefit of the refrigerating process above, and its elasticity was at least doubled by the heat, being equivalent to seventy six atmospheres (=1140 pounds on the square inch); the wonder is, therefore, that the courageous experimenter sustained no other inconvenience than from a little acid thrown in his face.

May 13, 1837—Dr. Torrey forwarded to me a strong tube containing a fine quantity of the liquid carbonic acid which spontaneously crystallizes in beautiful snowy crystals during freezing cold weather, while a portion remains fluid, and thus I have the pleasure of exhibiting to my chemical class the aeriform, the liquid, and the crystallized carbonic acid, all in the same tube. This day, Dec. 27, 1838, it is in that condition.

Dr. Torrey was early successful in condensing the sulphurous acid and the chloro-chromic acid. He mentions in a letter dated Nov. 9, 1835—

“The freezing of water by the latter, is a beautiful class experiment. Some ice-cold water is placed in a large watch glass or bottom of a flask; the tube containing the acid is cooled in a freezing mixture of snow and salt, (the temperature of which should be full 0° F.)—then with a small fine file rub off the extremity of the tube, so as to make the finest possible orifice; next seize the flask with a pair of forceps and invert it, or hold it obliquely downward over the glass of water. A fine stream of the acid will rush out, and falling on the water will congeal it into a spongy ice. It is unnecessary to say, that the experiment should be conducted under a hood to carry off the offensive smell of the sulphurous acid.”

With respect to chloro-chromic acid he confirms Dr. Thomson's statement, that perfectly dry phosphorus is not inflamed by it; it may be even melted in the liquid acid, but if moist in the slightest degree, it will burn with a loud explosion, requiring particular precautions.—SENIOR ED.

2. *Critical Interpretation of bara and asah, in a letter from Dr. NOAH WEBSTER to the Rev. William Buckland, Oxford, England.*

Rev. Sir—I am reading your treatise on Geology with great pleasure, and, I hope, not without instruction.

In the second chapter of your treatise on Geology, a part of the Bridge-water Collection, you have advanced the doctrine that the matter of this globe was created long before it was reduced to its present form or state,

for the residence of the present race of men. This doctrine supposes that the first verse in Genesis refers to the first creation of the matter of the globe, and of the celestial orbs; and that between that event and the creation of man, an indefinite period of long duration elapsed before the reduction of the earth to its present form.

Long before your treatise on Geology was written, and anterior to the modern discoveries of the remains of animals and plants in the different formations of the crust of the earth, I had conceived the same opinion. I could hardly express my opinions better than Bishop Gleig has expressed them in a note in page 32 of your book, Philadelphia edition.

My object now is merely to offer a few remarks on the Hebrew words *bara* and *asah*, which are used to express *creation* and *making*. I suppose that lexicographers and commentators have mistaken the primary signification of *bara*. Gesenius supposes the primary sense to be to *cut*, *cut out*, *to carve*, or *to form by cutting or carving*, from the notion of *breaking, cutting, or separating*, inherent in the radical syllable בר.

But this is probably a mistake, which shows how imperfectly the most eminent scholars understand the order in which the various uses of words are derived from a radical signification. If the primary sense were to *cut*, or *carve*, the sense of *being born* or *producing young*, could not be deduced from it. Yet Gesenius himself thus interprets the word, in Ezek. 21 : 30, 28 : 13; Ps. 104 : 30.

The primary sense of the word is probably *to separate* in some form or other, and *cutting* may be deduced from that sense. But in expressing *creation*, the sense is to *produce*, to *drive out*, or *send forth*. *Creation* was a *producing* to light or to existence in a visible form. Thus the apostle expresses the fact, as Macknight renders the original words, and as I should render them: "so that the things which are seen were not made of things which appeared;" that is of things previously formed and visible. Heb. 11 : 3. I am the more inclined to this opinion, because I believe the word *bara* is our English word *bear*, or of the same family, coinciding with the sense in which we use it for the production of infants and of births.

The word *asah* seems rather to denote the *act* or *process* of *shaping* and *fitting for use*, by giving due form to a thing. And I would suggest it as worthy of consideration, whether the sense of the passage, Gen. 11 : 3, in which both of these words are used, is not this—Because that in it he had rested from all his works which God *produced for formation*; created to be reduced to a form for use, or for its intended purposes.

For the great variety of uses or application of this Hebrew root, see the Introduction to my Quarto Dictionary.

These suggestions are offered with some diffidence, by

Your obedient servant,

N. WEBSTER.

New Haven, Connecticut, United States, Nov. 16, 1838.

3. *Notice of the Height of Mountains in North Carolina, from Prof. E. MITCHELL, of Chapel Hill University.* (Taken from the Raleigh Register of Nov. 3, 1835, and forwarded by Prof. M.)

The younger Michaux, on his way from the Valley of the Mississippi, in the fall of 1802, passed through the counties of Yancy and Burke, and in the small volume, containing an account of his travels, that was published soon after his return to Paris, the opinion is expressed, that in these counties, the Alleghany Mountains attain their greatest elevation. He mentions, in evidence that this belief is well founded, that his father found trees and plants growing upon them which he did not meet with again before reaching Canada.

The geology of these counties has some peculiar features. They were visited during the last summer, for the purpose of tracing the boundaries of their rock formations, and along with other collateral objects, provision was made for measuring the heights of their principal mountains, with their bearings and distances from each other. Prof. Mitchell in a letter to the editor, dated University of North Carolina, May 12, 1838, remarks that the results transmitted were obtained by himself. He adds—

“In their general accuracy I placed a confidence at the time which has been increased by the publication of the Report of the Surveys made by the engineers employed by the Charleston and Louisville Rail Road Company. For the height of Mount Washington I trusted to Worcester as the best authority within my reach. The difference in elevation between the northern and southern mountains is probably not considerable; in point of beauty there is in some instances a decided superiority on the side of the latter. Mount Washington, according to his measurement, is not so high as the highest peak of the Black Mountain.”

One barometer he observes was stationed at Morganton, and a record kept of its movements by Mr. Pearson of that place. This served as a standard. The observations made at the same time (nearly,) upon the tops of the mountains and at Morganton, furnished the data for calculating their elevations above that village, and the mean of ten observations, on successive days, gave what is probably a near approximation to the height of Morganton above the level of the sea—nine hundred and sixty eight feet. Deducting from this the descent to the bed of the Catawba, there remains only about eight hundred feet of fall between the ford leading over Linville and the sea.

North of the point where the James River leaves the mountains, the first high ridge of the Alleghanies is called the Blue Ridge. In North Carolina, this name is applied to the range that separates the eastern and western waters. This is commonly the first high mountain, but not always. The *Table Mountain*, which forms so fine and striking a feature in the scenery about Morganton, is not a part of the Blue Ridge, but a spur or outlier. It seems, when seen from Morganton, to be a round

tower, rising perpendicularly from the summit of the first range of the Alleghanias. It is, in fact, a narrow ridge, affording a very fine prospect of the fertile valley of the Catawba and its tributaries on the southeast and east, and of nature in her wildest dress where the Linville pours over the rocks along a deep ravine, wholly untenanted and uncultivated, and of a vast extent of mountain peaks and ranges on the northeast. Its top is two thousand four hundred and fifty three feet above Morganton, and a little more than fifteen miles distant in a right line.

The Grandfather, seventeen miles from the Table, and twenty eight from Morganton, has hitherto been generally supposed the highest mountain in North Carolina. But this proves to be a mistake, as may be seen in the following table. There is a mountain not far off called the Grandmother; from being crowned with the balsam of fir it is conjectured that the elevation may be twenty six hundred feet.

The *Roan Mountain* is fifteen miles from the Grandfather, and thirty five northwest from Morganton, lying directly over or beyond the Hawksbill. It touches the Tennessee line, but the highest peaks are in North Carolina. This is the easiest of access, the most beautiful, and will best repay the labor of ascending it of all our high mountains. With the exception of a body of rocks looking like the ruins of an old castle, near its southwestern extremity, the top of the Roan may be described as a vast meadow, without a tree to obstruct the prospect; where a person may gallop his horse for a mile or two, with Carolina at his feet on one side, and Tennessee on the other, and a green ocean of mountains raised into tremendous billows immediately about him. It is the elysium of a southern botanist, as a number of plants are found growing in this cold and humid atmosphere, which are not seen again till we have gone some hundreds of miles farther north. It is the pasture ground for the young horses of the whole country about it during the summer. We found the strawberry here in the greatest abundance and of the finest quality, in regard to both size and flavor, on the 30th of July.

The *Black Mountain* is a long ridge, at a medium distance of about thirty miles from Morganton. It has some peaks of greater elevation than any point that has hitherto been measured in North America, east of the Rocky Mountains, and is believed to be the highest mountain in the United States. The Black Mountain cost nearly a week's labor in fixing upon the peak to be measured and the measurement. For the sake of comparison the following heights are given. The first five are copied from Worcester's Gazetteer:

Mount Washington in New Hampshire, hitherto accounted the highest mountain in the United States—highest peak,	6,234
Mansfield Mountain, Vermont,	4,279
Saddle Mountain, Massachusetts,	4,000
Round Top, highest of the Catskills,	3,804

Peaks of Otter, Virginia,	3,955
Table Mountain, Burke, North Carolina,	3,421
Grandfather,	5,556
Yeates' Knob,	5,895
Black, at Thomas Young's,	5,946
Roan,	6,038
Highest peak of the Black,	6,476

There are other high mountains at no great distance from those that were measured, as the Bald Mountain in the western part of Yancy, and the White Top in Virginia, which are nearly if not quite as high as the Roan. In the southeastern part of Haywood county, near the South Carolina line, there is a tremendous pile, and between the counties of Haywood and Macon and the State of Tennessee, the Unikee Mountain swells to a great elevation. But these appear to the eye to be lower than the Black.

The Pilot Mountain, which has heretofore enjoyed great celebrity, is much lower than several others. The ascent of the Black Mountain is very difficult on account of the thick laurels which are so closely set, and their strong branches so interwoven, that a path cannot be forced by pushing them aside; and the hunters have no method of advancing, when they happen to fall in with the worst of them, but that of crawling along their tops. The bear, in passing up and down the mountain, finds it wisest to keep the ridges, and trampling down the young laurels as they spring up, breaking the limbs from the old ones and pushing them aside, he forms at last a sort of burrow above ground, through this bed of vegetation, along which he passes without difficulty. This is a bear trail. The top is covered with the balsam fir, from the dark and sombre shade of whose foliage it doubtless received the name of the Black Mountain. The growth of the tree is such on these high summits, that it is easy to climb to the top and taking hold of the highest branch look abroad upon the prospect. At the time of our visit, the mountain was enveloped in mist, which prevented our seeing more than a couple of hundred yards, and we were so uncomfortable from cold, that some of the company urged a return with the least possible delay, and this when it was clear weather, at a small distance below the ridge and the thermometer at 80°.

The temperature of a few wells and springs is subjoined. The finest iced water is a vapid drink, in comparison with the pure element that gushes from the sides of these western mountains.

Wells on Chapel Hill, Oct. 17,	59°
Well in Lincolnton, July 16,	61°
“ Morganton, July 16,	58°
Spring in Keller's Field,	58°
“ Daniel Moore's Globe Settlement,	57°
“ James Riddle's,	54°

Spring near the top of the Grandfather,	53°
“ Ascent of the Roan,	52°
“ North side of the Black Mountain,	50°
“ Another, same Mountain,	48°

4. *Fossil Shells and Bones.*—A correspondent writes from Wilmington Island, near Savannah, July 16, 1838,—Wilmington island is situated in the Savannah river eight miles from the sea, and would appear, though surrounded by salt water, to be a part of the delta of the river, were it not for the vast beds of shells (principally oysters) which are found upon it. These beds extend through all the islands in this vicinity, and although attributed by some to the aborigines, are evidently the deposits of the ocean, as they are found in layers of uniform thickness wherever they have not been disturbed. Under such circumstances they are found about three or four feet from the surface. You heard, I suppose, of the discovery of fossil bones made in this State last spring while digging the canal near Brunswick. I endeavored to lay hands on some of them, but found that they were to be sent to the Nat. Hist. Soc. of Boston. They were the only bones ever found in this State except those of the megatherium. They were at first supposed to belong to the mastodon. Dr. S., the gentleman with whom I reside, has in his possession some of the bones of the megatherium. T. R. D.

#### 5. *Auroral Arch in Vermont.*—*Eclipse.*

Burlington, Vermont, 20th November, 1838.

TO THE EDITORS.—*Gentlemen*—Again has the same region, described in your 33d Vol., p. 212, presented a similar phenomenon, and for the reasons there given, and with the view of obtaining a certain parallax in order to ascertain the distance of these wonderful phenomena, I shall describe this also to you.

On the evening of the 7th of September I was called out by a friend to look at a remarkable light. It extended to within 10° or 15° of the horizon at each extremity, passing between Alpha and Zeta Pegasi, leaving both stars just clear of its penumbra, between Beta Cygni and Beta Lyrae, enveloping both in its penumbra, and just N. of Arcturus. This was at 8h. 30m., and it continued nearly unchanged for five minutes. It then seemed disturbed on its N. edge, especially near Lyra, as if by a current moving westerly, and continually detaching small fragments, which, on their separation, immediately disappeared. At the same time, the portion between Lyra and Arcturus was greatly bent towards the south. In about 5m. more it entirely disappeared. If I can trust my recollection, it was brighter than those I saw last year. There was a very bright and active light in the north at the same time, and long afterwards, but exhibiting nothing else uncommon.

An attempt was made to obtain an observation of the late eclipse with the following result. Sun's center on the meridian by chronometer 11h. 53m. 53sec. Eclipse began by chronometer 3h. 12m. 50sec. Chronometer gaining 3.87 sec. per day. The end was involved in thick clouds.

Yours with high respect, JAMES DEAN.

6. *Geological Specimens from the East Indian Archipelago*; from JAS. T. DICKINSON, Miss. of the A. B. C. F. M.

Singapore, 20th March, 1838.

TO PROF. SILLIMAN.—*Dear Sir*—I send by a friend, Mr. Hope, a few geological specimens which I collected not long since during a voyage among the islands of the Indian Archipelago. The specimens are very small for convenience of transportation, and their value, if they have any, is derived only from the fact that they are from highly interesting islands, which, if I mistake not, are little known to geologists.

The Ternati specimens are most of them from the top of the mountain, 5060 feet high, and exhibit the trap rock in all stages of fusion. The mountain is a volcano, the crater of which was emitting smoke, but no flame, at the time we visited it.

The coal from Borneo was found *in situ* among the hills, and may probably be found in any quantity.

The rock of the island of Singapore is all red sandstone, so far as I know. In some places the sandstone has fragments of quartz imbedded in it.

The mountains of the Malay peninsula are granite, and so also are those of Cochin China. The islands east and south of Borneo are trap, and abound in volcanoes. Beginning, then, at the north and west, we have granite—next, proceeding towards the south and east, we find sandstone—and next, trap.

REMARK.—The specimens sent by Mr. D. fully sustain his opinions; and there are among them also very beautiful chalcedonies and agates from the hills and beach at Mindanao.—EDS.

7. *Resemblance to an Aurora*.—*Extract of a letter from GEORGE GIBBS, Esq., dated New York, Nov. 26, 1838.*—A druggist's store in Pearl street was burnt in the evening and while the air was filled with snow, (a slight fall took place during the night,) and a column of pale light shot up from the blaze as high as the zenith, (in appearance.) It was entirely distinct in color from the light of the fire or smoke, being stationary, higher, and slender like the mast of a vessel. It was to the south of where I stood and about a mile off, and was noticed by others at the time. I had no doubt of its being an artificial aurora. You will be able, perhaps, to explain it if not.

8. METEOROLOGICAL REGISTER FOR 1837,

Kept at Montreal, Lower Canada, in Lat. 45° 50' N. Long. 73° 22' W. by J. S. McCord, Corresponding Secretary of the Natural History Society, and Member of the Literary and Historical Society, Quebec, and Albany Institute, State of New York.

MONTHS.	WIND.													WEATHER.																						
	Number of days blowing.													Number of days each.																						
	N	NE	E	SE	S	SW	W	NW	Cr.	Cy.	Rn.	Shrs.	Fog.	Snow.	Rain	Snow	N	NE	E	SE	S	SW	W	NW	Cr.	Cy.	Rn.	Shrs.	Fog.	Snow.	Rain	Snow				
January	5.0	1.0	0.0	0.0	3.0	5.5	14.5	2.0	13.0	12.0	*.75	.5	1.25	4.0	..	21.55	5.0	1.0	0.0	0.0	3.0	5.5	14.5	2.0	13.0	12.0	*.75	.5	1.25	4.0	..	21.55				
February	29.830	15.78	6.0	3.0	0.0	0.0	6.5	6.0	6.0	16.5	.5	4.25	..	..	18.50	29.830	15.78	6.0	3.0	0.0	0.0	6.5	6.0	6.0	16.5	.5	4.25	..	..	18.50						
March	30.007	25.15	8.0	0.0	2.0	1.0	7.5	4.0	6.5	2.0	10.5	..	..	..	4.15	30.007	25.15	8.0	0.0	2.0	1.0	7.5	4.0	6.5	2.0	10.5	..	..	..	4.15						
April	29.739	40.40	3.0	2.5	0.5	0.5	3.0	2.5	11.5	6.5	14.0	11.25	..	1.50	4.25	29.739	40.40	3.0	2.5	0.5	0.5	3.0	2.5	11.5	6.5	14.0	11.25	..	1.50	4.25						
May	29.824	52.15	3.0	1.0	2.0	2.5	5.5	4.0	7.5	5.5	13.5	..	..	..	0.30	29.824	52.15	3.0	1.0	2.0	2.5	5.5	4.0	7.5	5.5	13.5	..	..	..	0.30						
June	29.705	65.55	8.5	2.0	1.0	2.0	3.0	6.5	6.0	1.0	10.0	14.5	..	..	2.00	29.705	65.55	8.5	2.0	1.0	2.0	3.0	6.5	6.0	1.0	10.0	14.5	..	..	2.00						
July	29.710	65.60	3.0	0.0	0.0	0.5	1.5	5.0	5.5	8.5	12.5	..	..	..	..	29.710	65.60	3.0	0.0	0.0	0.5	1.5	5.0	5.5	8.5	12.5	..	..	..	..						
August	29.792	65.15	7.0	0.0	1.5	0.0	1.0	10.5	11.0	0.0	15.75	11.25	..	..	..	29.792	65.15	7.0	0.0	1.5	0.0	1.0	10.5	11.0	0.0	15.75	11.25	..	..	..	..					
September	29.837	58.30	2.0	1.0	0.0	2.5	3.0	5.0	13.5	3.0	15.5	8.5	..	..	..	29.837	58.30	2.0	1.0	0.0	2.5	3.0	5.0	13.5	3.0	15.5	8.5	..	..	..	..					
October	30.026	43.20	4.0	1.5	0.5	0.5	1.0	4.0	3.5	5.0	8.5	7.0	..	..	..	30.026	43.20	4.0	1.5	0.5	0.5	1.0	4.0	3.5	5.0	8.5	7.0	..	..	..	..					
November	29.811	33.70	1.0	0.5	0.0	0.0	1.0	3.0	9.5	1.0	5.75	6.0	..	..	..	29.811	33.70	1.0	0.5	0.0	0.0	1.0	3.0	9.5	1.0	5.75	6.0	..	..	..	..					
December	29.882	20.95	6.0	1.0	0.0	1.5	2.5	4.0	9.0	1.0	10.25	12.25	..	..	..	29.882	20.95	6.0	1.0	0.0	1.5	2.5	4.0	9.0	1.0	10.25	12.25	..	..	..	..					
	29.823	41.22	56.5	13.5	7.5	11.0	38.5	60.0	101.5	38.5	135.25	132.75	34.25	9.50	2.25	13.00	16.90	64.50	29.823	41.22	56.5	13.5	7.5	11.0	38.5	60.0	101.5	38.5	135.25	132.75	34.25	9.50	2.25	13.00	16.90	64.50

Mean Pressure of the Year, corrected and reduced to 32° Fahrenheit

Mean Temperature of the Year, mean of Maxima and Minima by Register Thermometers

Maximum height of the Barometer during the year

Minimum

Range of Barometer

\* Drifting. † 20 days only observed. ‡ 16 days only observed. § 25 days only observed. || 24 days only observed.

Mean Pressure of the Year, corrected and reduced to 32° Fahrenheit . . . . . 29.823  
 Mean Temperature of the Year, mean of Maxima and Minima by Register Thermometers . . . . . 41.22  
 Maximum height of the Barometer during the year . . . . . 30.534 (mean of yearly Maximum . . . . . 30.287)  
 Minimum . . . . . 28.776 ( " Minimum . . . . . 29.313)  
 Range of Barometer . . . . . 1.758



Warmest day . . . . .	+90°
Coldest day . . . . .	—18
<hr/>	
Range of Thermometer . . . . .	108
Number of days Clear . . . . .	135.25
“ “ “ Cloudy . . . . .	132.75
“ “ “ Rain . . . . .	34.25
“ “ “ Showers . . . . .	9.50
“ “ “ Fog . . . . .	2.25
“ “ “ Snow . . . . .	13.00
<hr/>	
Number of days observed . . . . .	327.00
<hr/>	
Number of days of Westerly winds . . . . .	200.0
“ “ “ Easterly “ . . . . .	32.0
“ “ “ North “ . . . . .	56.5
“ “ “ South “ . . . . .	28.5
<hr/>	
Number of days observed . . . . .	327.0
<hr/>	
Mean Temperature, 1836 . . . . .	40.43
“ “ “ 1837 . . . . .	41.22

MONTHS.	BAROMETER.			THERMOMETER.		
	Max.	Min.	Range.	Max.	Min.	Range.
January . . .	30.212	28.776	1.436	+ 34	—18	52
February . . .	30.384	29.322	1.062	+ 38	—15	53
March . . .	30.484	29.268	1.216	+ 49	—13	62
April . . .	30.112	29.040	1.072	+ 60	+ 22	38
May . . .	30.118	29.334	.884	+ 80	+ 20	60
June . . .	30.100	29.278	.822	+ 90	+ 49	41
July . . .	30.159	29.501	.658	+ 90	+ 52	38
August . . .	30.242	29.431	.816	+ 80	+ 46	34
September . . .	30.332	29.455	.877	+ 81	+ 41	40
October . . .	30.370	29.450	.920	+ 68	+ 30	38
November . . .	30.400	28.700	1.700	+ 49	+ 2	47
December . . .	30.534	29.200	1.334	+ 45	—14	59
Means. . .	30.287	29.313				

SUDDEN FLUCTUATIONS IN THE BAROMETER, &c. 1837.				
Date.	Inches and parts.	Rise or fall.	In what time.	Remarks.
Feb. 11 . . .	.460	rise.	12 hours.	
Oct. 17 to 18.	.884	fall.	29 hours.	Wind S. and S. W.
20.	.540	fall.	12 hours.	“ S. E.
Nov. 23 . . .	.700	fall.	24 hours.	“ S. W.
Dec. 26 to 27.	1.018	rise.	24 hours.	“ W.
27 to 28.	.570	fall.	24 hours.	“ W.

Temperature of Well, Botanic Garden—31 feet deep.  
 Sept. 1835, to August, 1836 . . . . . 46° Fahrenheit.  
 Sept. 1836, to August, 1837 . . . . . 46.2 “

*Storms, Phenomena, &c.*

October 18th.—Wind and rain.—17th.—Wind S.—Shifted to S. W. on 18th.—Commenced to blow hard at 11 A. M. of the 18th. Barometer fell from 9 A. M. of 17th to 2 P. M. of 18th, .884—suddenly rose to 30.168 at 9 A. M. of the 19th.

- October 20th.—Wind and rain.—9 P. M. of the 19th, wind N. E.—Barometer 30.028 blowing fresh—Thermometer 37, falling. At half past 3 A. M. of 20th, wind shifted to S. E. and storm began.—Between 4 and 5 A. M. blew a gale, heavy rain in squalls—Barometer falling rapidly.—9 A. M. storm still raging—10, began to abate, and shortly after wind shifted to S. and gradually died away.—Fall of Barometer .540 in 12 hours—rain fallen half an inch.
- 25th.—Snow storm—from N. by W.—began 4 A. M.—snowed till 11 A. M. and then rained all day—heavy wind.
- November 4th to 5th.—Gale from N. W. with snow—began 8 A. M. of 4th.
- 14th.—Very brilliant Aurora—commenced at 6 P. M.—at half past 8 attained its greatest splendor—magnificent crimson pencils, darting from the zenith to E. and W.
- 16th.—Heavy snow storm from N. E.—commenced 3 P. M.—lasted till 7 P. M.
- 19th.—Steady rain, set in at 10 P. M. and continued without intermission during the 20th, 21st, to 9 P. M. 22d—at which period stopped, wind N. E.—blowing fresh—Barometer 28.878.
- 23d, 24th, 25th.—Heavy and continued gale from S. W.—Snow on 25th.
- November 30th to December 13th.—Extraordinary mild season—warm rains—navigation open—steamers plying to the 13th December inclusive.
- December 21st.—Coldest day—Thermometer varying from  $-14$  to  $-18$  according to situation.
- 26th.—Extraordinary rise and fall of Barometer—
- |                   |                   |
|-------------------|-------------------|
| 9 A. M. 26th, . . | 29.516            |
| 9 A. M. 27th, . . | 30.534 rise 1.018 |
| 9 A. M. 28th, . . | 29.964 fall .570  |

9. *Geological Surveys.*—Many engagements and duties have caused us to fall in arrears in regard to several valuable geological reports, particularly of New York, Maine, and Massachusetts;\* but without proffering a pledge we may not have it in our power to redeem, as soon as we could desire, we trust that we shall be able hereafter to gratify our own wishes by doing justice to able and faithful explorers in these different and responsible fields of science and economics.

10. *Dr. Mantell's Wonders of Geology.*—This fine work was mentioned fully in our July number. Although it was published in London only in March, the second thousand of copies was nearly sold in September, and a new edition is expected early in the present year, 1839.

Arrangements have been made with the author and publisher by which Mr. A. H. Maltby of New Haven will publish the new edition in this country as soon as it can cross the ocean, and by the author's approbation it will appear under the direction of Prof. Silliman with introductory remarks by him: paper, type and illustrations, identical with those of the London edition.

---

\* We now add those of Virginia, 1st and 2d reports, 1836 and 7 by Prof. W. B. Rogers, Phila. 1838, and of New Jersey, 2d ed. 1836.—Eds.

11. *Mr. Bakewell's Geology*.—Third American from the fifth English edition of 1838, revised and *improved* by the author: the American edition, by B. & W. Noyes, of New Haven: with an Appendix by Professor Silliman: 8vo. pp. 600.

Mr. Bakewell's excellent treatise is well known in this country, in consequence of the two American editions that have been already published; its plan therefore requires no explanation, and commendation would be quite superfluous in the case of a work already approved and extensively adopted at home and abroad. Mr. Bakewell has added a new chapter on the general removal and disappearance of the coal strata raised by faults above the surface of the ground. The former editions were particularly full and instructive on coal, and this chapter is a valuable addition.

The American editions, that of 1829, from the third English, and of 1833, from the fourth, were edited by Professor Silliman, with the author's privity and approbation, and by his request this third edition is passed over to the American public through the same editorial supervision; with a view of rendering the work more useful, an appendix will be added by the editor, containing a condensed summary of the ground before occupied, with such corrections of fact and theory as appear necessary. This reprint is executed in good style, and numerous typographical errors have been corrected.

12. *Elements of Geology*; by CHARLES LYELL, Esq., F. R. S., &c. &c., London, Aug. 1838, pp. 543, 1 Vol. large 12mo.—These elements are, as may be supposed, an abridgment of Mr. Lyell's large and well known work, the *Principles of Geology*. This is a new work, and very fully illustrated by figures, chiefly superior wood cuts, of great precision and beauty: there is one colored ideal section of part of the earth's crust, explaining the theory of the four great classes of rocks.

Those who are acquainted with the author's previous works, will expect, what they will find, a lucid and masterly exposition of the science. This work might well be styled, "Institutes of Geology."

It presents the elementary facts, perspicuously arranged and described, and the philosophy of the *science* is such as those familiar with its more profound discussions will readily appreciate. We understand that this work is in the press at Philadelphia, by Kay & Brother, and that it may be expected to appear early in the spring of the present year, 1839.

13. DR. LEWIS C. BECK'S *Manual of Chemistry*; 3d edition, with numerous wood cuts: New York—1838: pp. 482, large 12mo.—The order of this work is—Definition, Attraction, Heat, Light, Electricity, Galvanism, Magnetism and Electro-Magnetism, Elementary Bodies, Supporters  
VOL. XXXV.—No. 2. 49

of Combustion or Electro-Negative Bodies, Non-Metallic Combustibles or Electro-Positive Bodies, Metals, Organic Bodies, Vegetable and Animal, with an Appendix.

This order is probably the most unexceptionable. There is no perfect arrangement; none that will avoid inconvenient anticipations, or that will bring into one group all the members of the same subject. The best course is to anticipate as little as possible; to explain the nature of the materials which we must employ so far as to render our processes intelligible, and to revert, as far as necessary, so that either sooner or later, every thing will be explained. This course Dr. Beck has judiciously pursued, and his work is a perspicuous and condensed abstract of the science, and is well adapted to the object for which it was written.

14. *Notice of a Manual of Conchology according to the system laid down by LAMARCK, with the late improvements by De BLAINVILLE, for students; by THOMAS WYATT, M. A., in a letter to him from ISAAC LEA, Esq., dated Philadelphia, December 19, 1838.*—"Dear Sir—I have examined your 'Manual of Conchology,' formed from the works of Lamarck and Blainville, and consider it well adapted to the introduction of the student into the science of conchology. The plates, which are from the excellent work of Blainville, are generally very well done, and calculated to aid the tyro in obtaining a knowledge of the genera of this interesting branch of natural history.

"I sincerely wish you success in this work, which must have cost you much labor. Should it pass to another edition, I would advise the insertion of a plate with the various parts of shells, with proper definitions in the text. The name of each shell should also be upon the plates throughout."

Mr. Lea has, with good reason, commended the plates of this work, and it is no small advantage that they are printed on excellent paper, which will bear using both by the quiet student and the traveller. Officers of the navy and in the merchant service, will find this a very convenient, and we doubt not, useful manual, by which to direct their observations while collecting shells to enrich their own cabinet as well as those of public institutions and of private individuals.—EDS.

15. *Eulogiums on the late Dr. NATHANIEL BOWDITCH.*—The death of this distinguished man produced a strong impression on the public mind, and called forth many tributes of respect. Three eulogiums were pronounced, severally, by the Hon. Judge White, at Salem, and at Boston by Rev. Alexander Young, and by Hon. John Pickering, the latter before the American Academy, May 29, 1838. Mr. Young's discourse was, by particular request, revised for this Journal, and appeared in the October

number. This, therefore, has already spoken for itself in our pages, and has been received with warm interest and gratification by the public.

The eulogium of Judge White is a delightful composition, replete with eloquence and literary beauty, and warm with affectionate respect for the great philosopher whom it commemorates. Being the production of a townsman and cotemporary, like Mr. Young's, it presents graphic sketches of his life and character, both in the forming and mature stages, and does equal honor to the head and heart of the writer, and to his noble subject.

The eulogium of Mr. Pickering is a chaste, classical composition, altogether worthy of its author, (and this is no stinted praise.)

In unity with the character of the learned body before which it was delivered, and of which Dr. Bowditch was president, it presents, as its peculiar characteristics, a masterly analysis of the scientific labors of this eminent man. Performed in the midst of arduous and responsible business, and of numerous social engagements and duties, which touched his warm heart as much as science filled his clear intellect, his philosophical labors were enough to have absorbed a powerful mind, unshackled by common cares. It is remarkable, that the eulogist of this eminent man, by the manner in which he has executed his delicate task, bringing literature and science into beautiful harmony, should have evinced that Dr. Bowditch was not alone in reconciling conflicting duties. Every wise and good American must feel proud that his country has produced a subject of such deserved eulogy, and gifted minds and hearts to appreciate such talents, attainments, and virtues.

16. *The Science of Geology, from the Glasgow Treatises, with additions*; first American edition, Common School Treatises, No. I.—This little work of 72 pages, is neatly printed, with good illustrations on wood, and is issued at New Haven by B. & W. Noyes. It is well adapted to be useful in the education of young people, being judicious in selection, and perspicuous and attractive in style.

17. *Dr. Charles T. Jackson's Reports on the Geology of Maine.*—It has been impossible for us to notice in the present number Dr. Jackson's very valuable reports, being the second on the geology of Maine, and the second also on the geology of the public lands of Maine and Massachusetts.

These reports together occupy about 300 pages, with appropriate illustrations. They correspond with what we might expect from Dr. Jackson, being able and perspicuous, and eminently adapted to do honor to the State, and to promote its vital interests.

We trust that the good sense and patriotism of the government of Maine will carry out this noble work until it is entirely finished under Dr. Jack-

son's able and efficient management. No time for a full completion of this great labor can be so good as the present; an abandonment would be most unwise,—even a suspension highly injurious, and in point of economy, very improvident and wasteful.

18. *Catlinite\* or Indian Pipe Stone*.—Dr. Jackson, of Boston, has analyzed Mr. Catlin's pipe stone from *Coteau du Prairie*, which is not steatite, but a new compound very similar to agalmatolite, it being composed of in 100 grains:

Water,	-	-	-	-	-	-	-	8.4	grs.
Silica,	-	-	-	-	-	-	-	48.2	"
Alumina,	-	-	-	-	-	-	-	28.2	"
Magnesia,	-	-	-	-	-	-	-	6.0	"
Perox. iron,	-	-	-	-	-	-	-	5.0	"
Ox. manganese,	-	-	-	-	-	-	-	0.6	"
Carb. lime,	-	-	-	-	-	-	-	2.6	"
Loss, (probably magnesia,)	-	-	-	-	-	-	-	1	"

The carbonate of lime is not an essential ingredient, but is mixed in fine particles.

The Catlinite evidently exists in pseudo strata or tabular sheets, and overlaid by quartz rock, glazed, as if from the action of fire, while the surface is carved with bird tracks, called by the Indians the points or footsteps of the great spirit.

19. *Encke's Comet*.—The proximity of this body to the earth, during its return in the latter part of the present year, has rendered it an object of peculiar interest to astronomers. It was seen in England as early as the 21st of September, but as yet no foreign observations upon it have reached us. Unfortunately, an ephemeris of this comet was not obtained in this country until the middle of November, at which time it had passed the circle of perpetual apparition, and was visible but for an hour or two in the evening after sunset. It was first seen in this country on the 17th of November, and at a number of places simultaneously; at Yale College, New Haven, at the Wesleyan University of Middletown in this State, and at Philadelphia. It had then recently passed the point of its nearest approach to the earth, which was about 21 millions of miles, and was visible to the naked eye as a star of the 4.5 magnitude.

We have, as yet, heard of no regular series of observations upon the comet made in this country. But few days remained after its discovery before it should disappear in the evening twilight, and its proximity to

---

\* After Mr. Catlin, the celebrated traveller in the West, and the successful painter of Indians, their costume, the scenery of their country, &c. His Indian museum is a most interesting and unique collection:

the horizon promised little reward to any efforts that might be bestowed upon it. It was observed here with the 14 feet reflector of Mr. Smith, described in the last number of this Journal, and with particular reference to its size and actual appearance. There was no decided or clearly defined nucleus, but its degree of condensation towards the center, was about as much as in the kind of nebulae described by Sir J. Herschel as "suddenly much brighter in the middle." The nucleus was excentric, the coma being less extensive on the side opposite the sun than elsewhere. The greatest diameter of the coma was in this telescope fully 12'; its least not more than  $\frac{3}{4}$  as much, and in the direction of a line drawn towards the sun. The expected occultation of the star *i* Herculis, which was not visible in Europe, was observed here. It did not occult it, but preceded it when nearest by about 10 or 15 seconds of time. A small star of the 9th or 10th magnitude about 5' south preceding *i*, was almost centrally occulted, but before the nucleus had quite reached it, the comet was too low to be observed; the nucleus had approached within 30" of the star, and in a few minutes, would have either occulted it or passed very near it on the side next to *i* Herculis.

The Bibliothèque Universelle of Geneva gives an abstract of the Ephemeris of this comet, as calculated by M. Bremiker, under the direction of M. Encke. Its present return is peculiarly interesting on account of its near approach to Mercury, from which its nearest distance is not two millions of miles. The perturbations of the comet, arising from this so close proximity to the planet, will furnish data, from which the mass of Mercury, hitherto little more than conjectural, may be known to a great degree of exactness. The full advantage of these data for the calculation of the mass and density of Mercury, will not, however, be realized, until future returns of the comet have more completely fixed its elements.

It is somewhat remarkable, that since the return of Halley's comet, no other than this has been seen in any part of the world. E. P. M.

Yale College, December 29, 1838.

20. *Grave of Godfrey, the inventor of the Quadrant, and of Charles Thomson.*—It will be interesting to the friends of science to learn that the remains of Thomas Godfrey, the undoubted inventor of the Quadrant, have been rescued from oblivion and removed to the beautiful cemetery of Laurel Hill, near Philadelphia. Mr. Godfrey had been interred on the farm of his father, near Germantown; in the course of time, the family burial ground was crossed by a cart road, and the old soapstone monument of the father, bearing date 1705, was knocked regularly by a cart wheel every time it passed, and was thus much defaced. This emphatically exhibits the folly of interring on farms, which must pass, in this country, after a few generations, into other families.

Appreciating fully the discovery of Godfrey, and anxious to prevent a further desecration of the grave, the annalist of Philadelphia, John F. Watson, Esq., who resides in Germantown, has had the remains of Godfrey, of his father and mother, and of a small child, all disinterred with suitable care, and we are happy to add, that the managers of the Laurel Hill cemetery have erected a suitable tomb over the remains. The friends of science, when viewing this already celebrated spot, will not forget to visit the tombs of Godfrey, the inventor of the Quadrant, and of Charles Thomson, the first, and long the confidential Secretary of the Continental Congress, also to be found appropriately ornamented in the same cemetery. It is high time other attempts were made to perpetuate the memory of the great and good men of the Revolution.—*Com. by Mr. Smith of the Phila. Library.*

21. *Marble and Serpentine in Vermont.*—We have received some beautiful marble tablets from Vermont through Mr. Ilock Hills, agent of the *Black River Marble and Manufacturing Company.*

The quantity is stated to be inexhaustible.

The marble proper, is in the town of Plymouth, county of Windsor, twenty five miles west of Connecticut river.

Some of the pieces sent to us have a white basis, with a faint blush of red, and varied by clouds of a light chocolate color; the structure is *sub-crystalline*, almost compact, and the same is true of other pieces whose basis is black, but beautifully pictured by white spots, tinted in some parts with gray. The white is often elongated into figures, having considerable regularity, sometimes almost cylindrical, and suggesting, at a transient glance, the idea of imbedded encrinites, or other organic remains. It is scarcely necessary to remark, that this is not the fact; and, indeed, the geological character of the country from which the marble comes, is primary, and destitute of organic bodies.

The serpentines and serpentine marbles are from the neighboring town of Cavendish.

The color presents every shade of green, and becomes, by easy transitions, deep leek-green and almost black. A piece of the latter color, 12 inches by 10, now lies before us, and is so highly polished as to be a good mirror; it is, indeed, very beautiful. The lighter colored pieces have considerable resemblance to the Verd Antique of Milford, Connecticut.

We cannot doubt that these materials will prove important both to useful and ornamental architecture. The pieces before us are all very firm, and would indicate good quarries.

The serpentine graduates, we are informed, into soapstone of an excellent quality, and the distance of the quarries of serpentine and soapstone from the river is less than that of the marble. We observe in these serpentines magnetic oxide of iron and chromate of iron, both so characteristic of serpentine formations.



22. *Oil from White Fish.*

Madison, September 12, 1838.

TO PROF. SILLIMAN.—*Respected Sir*—The question has often been proposed to me, whether by some chemical or natural process, the oil contained in our “white” fish might not be extracted without material detriment to them as a manure. You are probably aware that in our vicinity we rely in a great measure upon these fish as a manure for the “worn out lands.” For this purpose, at least one hundred and fifty of our most active men are in the season engaged in taking them. The number taken yearly is, upon average, fifteen millions. It has been ascertained by repeated experiment, that these fish contain half a gill of pure oil apiece. By those who made the experiment, (who at the time consulted you upon the subject, viz. 1814 or '15,) the remnants, after the extraction, were applied, side by side, with fish just taken, and no material difference noticed in the crops. They at that time extracted from 7000 fish, value \$7, a barrel of oil, value at that time \$25; the process was very tedious and filthy. From these premises, sir, I wish to ask of you, whether the oil contained in these fish can be purified from the other matters. Does the principle of manure consist in the solid material parts of the substances used, or in a gas arising from the decomposition of such materials? Is the oil the principal source of manure, and if so, in what ratio? I have been induced to solicit your opinion in this matter from a conviction that a very large profit may be realized from a disposition of the fish in the manner suggested, provided any method can be devised for effectually separating the oil from the other parts.

Yours with great respect,

W. W. WILCOX, A. M.,

Prec. Lee's Academy.

Being unable to suggest any thing satisfactory in reply to the letter of Mr. Wilcox, we give it publicity, in the hope that it may elicit information from others.—Eds.

23. *Calcium*.—We learn from Prof. Robert Hare, that he has recently, by a new process, obtained calcium, the metal of lime, in considerable quantity. His process is new, and we will not presume on a private letter for any of the details of procedure, or of the properties of the metal, of which, we trust, the public may, ere long, receive a notice from Dr. Hare himself.

24. *N. Dunn's Chinese collection at Philadelphia, communicated*.—It would be difficult to name a subject that has puzzled the learned world so much and so long, as the accurate delineation of the character of that wonderful and unchanging people, the Chinese. The

English embassies added something to our knowledge of the heretofore little explored interior of the country, and some light was diffused respecting the condition of agriculture, the habits, and the manufactures of the country. The works of the missionaries have also tended to make us more familiar with some of their peculiarities; the best book, however, which has ever been written respecting China, is the recent work of Mr. J. F. Davis, who had long been a resident in China, and who accompanied the embassy of Lord Amherst to the capital city of Pekin. Mr. Davis has concentrated much real information in a small space, and has, with singular ability, developed the characteristics of the three hundred millions of people of this region; his volumes have been republished in Harper's Family Library, and it is to them, and to the recent *Fan-Qui in China*, in Waldie's Library, that we would direct the attention of the inquirer.

Another new effort to open a fruitful source of information to the student is about to be made public, and on this occasion it is our own country which is to be gratified by the industry, zeal, and discriminating judgment, of one of her native merchants. Europeans have never succeeded in transporting a perfect or even a very respectable collection of Chinese curiosities. Those impressions which would be received by a resident who had enjoyed the rare privilege of unrestrained intercourse with the better classes of Chinamen, have been denied to foreigners. It has been too much the custom of the natives and their visitors, mutually to despise each other, and for both to seek for little further communication than that which the nature of their commercial transactions demands. The consequence has been, that the articles exported have continued to be principally those only which European and American every-day life have required; while strangers have limited their purchases to the common articles made to suit a foreign demand and taste, and their intercourse to the classes of natives who are appointed by government to serve or to watch over them. A few streets of the "outside" city of Canton are generally visited, and the stores in the vicinity of "Hog-lane," a place frequented by foreign sailors, are ransacked for the well known manufactures of gew-gaws, successively carried off by every new comer, but possessing little novelty in any sea port. The interior of the city of Canton even is a sealed book; how much more then the interior of China itself. This being the case, it became an interesting problem, as the Chinamen refuse to admit us *in*, how it would be possible to bring *out* what it was so difficult to get a sight of; in other words, as foreigners were not permitted to inspect the workshops, the houses, private apartments, and manufactories of the empire, what was the next best thing that could

be done to enable those outside the walls, and at home, to become acquainted with the domestic affairs and tastes of these recluses. Certainly little could be expected from the natives, unless other methods than those heretofore practiced could be adopted.

Nathan Dunn, Esq., of Philadelphia, who had reflected much upon this subject, and who, in the course of the very successful prosecution of his business at Canton, had learned to respect the ingenuity, and when called forth, the intelligence of the numerous Chinese with whom he was daily in contact, happily conceived the idea of transporting to his native shores, *every thing* that was characteristic or rare, whether in the natural history, or the natural and artificial curiosities and manufactures, no matter how costly they might be. And now came efficiently to his aid those requisites that had been but too frequently wanting in the officers of the East India Company, or their agents, who had made the attempt to procure such a collection but had failed. Mr. Dunn, who, it will be admitted by every one on the spot, had conducted himself toward all classes in a manner to win their esteem and confidence, and to whose house and table were introduced so many of the most distinguished officers of government, either temporarily or permanently at Canton, soon discovered that it was in his power to obtain favors not usually granted to strangers. One after another he procured, either by purchase or as presents, those rare and costly articles constituting his collection: how many of these are *perfect novelties* even to thousands who have visited China, let those decide who may soon have an opportunity of doing so; if indeed, that opportunity is not already in their power, before this hasty notice passes through the press. For one, the writer is free to say that but for the insight thus obtained, he should have remained as ignorant of the subject as other travellers. It is with a view of imparting a portion of this satisfaction, that he ventures to put them on paper.

Without further preface, we shall proceed to notice very briefly some of the peculiar features of this novel exhibition, enumerating a very small portion of the contents of the three hundred cases from which it has been now for the first time unpacked. The following are the principal groups.

*The entrance saloon*, of China work, forms a vestibule, through the centre of which you enter the great saloon, one hundred and sixty feet in length, by sixty three in width, and twenty four feet in height, with a double colonnade; to the right and left of which are the numerous cases containing specimens of all that is rare, curious, or common, to be procured in the celestial empire. This screen is such as is common among the wealthy Chinese, in partitioning off a very

large saloon from the remainder of the great ground floor of their houses. It is richly gilt, and ornamented with Chinese paintings on silk, inserted in the pannels; and is mounted above with small square gilt apertures; in these latter are inserted paintings of boats and gorgeous flowers. The screen forms a beautiful termination to this end of the room; the full effect bursts upon the eye of the visitor after passing the folding door. Hours, nay, days and weeks, may be profitably employed in examining the details within this magnificent saloon, which brings the most populous nation of Asia at once before the view of the spectator.

*Accurate likenesses in clay.*—The visitor is first attracted by the accurate and characteristic whole size Chinese figures of various rank, from the mandarins to the coolies, from women of distinction, to those sculling their boats on the rivers. These are in number seventy or eighty, and were made by a very experienced artist in this line, from living subjects. The material of the faces and hands is a prepared substance, so well adapted to the operation of moulding, as to take the impression perfectly and retain it permanently; the faces are colored to nature, mounted with hair, &c., and each presents a speaking countenance in a style of art perfectly novel in this country or Europe. These figures are neatly arranged in groups, arrayed in their appropriate costumes, some of them extremely rich, while others exhibit the working and every-day dress of the lower orders.

The effect of this department is to exhibit to the spectator the inhabitants of China as they really exist. Great care was taken in procuring the likenesses, and about three years of the time of the proprietor were occupied in bringing them to perfection; his head carpenter, and other workmen about the factories, were pointed out to us, and many conspicuous characters of China street, &c. will be recognized at once by those who have been to Canton. Bearers of a sedan chair, itself a perfect specimen in all its parts of ornament and utility, are in the act of carrying a native gentleman, accompanied by his pipe-bearer and footman.

*Porcelain and earthen ware manufacture.*—In this department, endeavors have been successfully made to procure the best specimens of all the most expensive manufactures of the country, embracing several very ancient and highly esteemed articles. There are also those articles in common use for domestic purposes, to ornament grounds, fish-ponds, or used as flower stands, seats, &c. A very interesting fact will be developed by this section, showing that the art of porcelain manufacture has been on the retrograde for the last century or two; it will also serve to show, that many of the most ornamental

and beautiful specimens are rarely, if ever, exported. Formerly the emperors patronized the porcelain manufacture by very high premiums and extensive orders; the art has now dwindled to supplying commercial and domestic wants. There are here many hundred jars, vases, pipe-stands, and various services used by the Chinese, differing materially from those exported. The specimens of ware cracked on the surface by age, are interesting and costly. There must be several thousand pieces of fine China, including the thin egg-shell cup with its lettered inscriptions, octagon pipe-stands, three or four feet in height, inscribed landmarks, tile work, screens, &c. &c., in very numerous patterns; affording us "barbarians" new ideas on the subject of their manufactures, and probably new patterns for our artists.

*Agricultural and other instruments.*—We notice among the agricultural instruments the very crude plough, that is drawn by the buffalo with his simple yoke and rope traces; the harrow, differing very materially from that of our country, is one of the accompaniments. There are forks, rakes, hoes, axes, shovels, spades of wood faced with iron for the sake of economy, &c.; a complete set of carpenter's and joiner's, or cabinet maker's tools; of the superiority of these over our own, we cannot say much. There is a native shoemaker's shop complete; a blacksmith's anvil, his curious bellows, &c., comprising the complete accoutrements of the travelling smith: the entire shop of the ambulatory barber, his clumsy, short razor, cases, &c. &c. The musical instruments of the Chinese, also figure in full among the curiosities. Castings of iron of very great beauty, consisting of pots, kettles, and other cooking utensils of universal use, and which, unlike our own of the same metal, may be mended at pleasure as easily as our own tin vessels:

Here is a study of Chinese manufactures perfectly novel to an American, who will be surprised to find that the most simple operation which he has been taught to believe can be performed only by an instrument of a certain form, is equally well executed by another of a totally different figure; the flat-iron, for instance, is more like our chafing-dish than what we employ for smoothing linen. We are amused to see the New England *patent* mouse-trap, that has been used in China for ages. There are gongs, bells, metallic mirrors, and articles under this head which nothing short of a most copious descriptive catalogue would embrace.

*Models of boats.*—The models of boats form a striking feature of the scene; first, we have the gorgeous flower boat with its numerous decorations, various furnished apartments of comfort and luxury, and painted and adorned in the peculiar style of the Asiatics.

*Of the canal boat* there are three models of different sizes of such as are used in conveying the articles of their produce, teas, salt, grain, and manufactured articles, to and from the distant points of the extensive empire, and in loading and unloading foreign ships. They are remarkable for strength and durability.

*The man-of-war boat.*—These tidewaiters' boats, or cutters, are always cruising about with the police officers, to keep order among the numerous residents on the water, and to enforce the revenue laws.

*The san-pans*, or family boats, in which it is computed about 200,000 persons constantly reside on the waters before the city of Canton and its suburbs; they are kept as clean as a milk-pail, and contain entire families, who are born and live to the end of their days on the river. This great city of boats presents a remarkable aspect; through them it would be difficult to navigate, were it not that the fleet is arranged in streets, and at night lighted up. There are also other boats; each has been made by reducing the dimensions to the proper scale; in every particular, even to the employment of the same descriptions of wood, the oars, sculls, rudders, setting poles, cordage, &c., are fac-similes of those in actual use. We are not sure that a Chinese canal boat, of a thousand years ago, might not be advantageously transferred to our own recently introduced water ways.

*Bridges.*—There are four accurate models of granite bridges, from one to four arches; the workmanship of the originals is of great beauty and durability, and really in them we discover the perfect arch, the most approved piers of the present day, and yet their bridges are so ancient, that the date of their erection is almost, if not entirely, lost. Having no carriages, they are merely used for foot passengers, loaded coolies, and an occasional horse or buffalo.

*Summer houses.*—Four models of summer houses exhibit the peculiar taste of the Chinese; some are plain, and others very ornamental, with their scalloped roof, bells, gilding, painting, &c., and furnished with miniature chairs, tables, &c., models of real things, every part being complete for the luxuries of tea and the pipe. Tea is the universal beverage; this is sold from eight cents the pound up to many dollars, and is an article on which some of their citizens expend a very large income. The working man carries it in his rude tea-pot to the fields, and drinks it cold to quench his thirst, while the more wealthy sip it on every occasion of ceremony, business, or familiar intercourse.

*Paintings.*—The pictures and paintings are very numerous, and probably occupy the greatest surface in the collection. Many of them were presented by distinguished men of China, and many were painted

by the most celebrated artists of the principal inland cities, including the capital. They represent in the first place all those scenes which are characteristic of Chinese life in its detail, including a series showing every process of the tea manufacture, from the planting to the packing up. There are large and handsome views of Macao, Bocca Tigris, Whampoa, Canton, and Honan, with its remarkable temples, &c. The portraits will astonish those who have seen only the paltry daubs usually brought as specimens of the art in China. There is one of the high priest of the Honan temple, and others of distinguished men well known in Canton, worked with the minuteness of miniature painting. This department comprises also a variety of paintings on glass, an art much practiced by the natives; pictures of all the boats peculiar to the country; of rooms, their domestic arrangements; of all the costumes of people of rank; the furniture, lanterns, and, in short, of every variety of Chinese life, from the most degraded class to the emperor. The flowers embroidered on satin, &c., will attract the eye of female visitors.

*A Chinese room.*—At the east end, faced by a very superb alcove brought from China, is a Chinese room. The alcove itself consists of wood deeply carved out of solid blocks; the carving represents figures of men, animals, birds, flowers, &c. The cutting penetrates through the whole of each piece, and forms a net work, the front being painted and gilt in the Asiatic taste, with the rich colors for which the nation is so celebrated. The screen is a fac-simile of those put up in the houses of the wealthy, to form an ante-room in their large establishments. This vestibule will be decorated with furniture, such as chairs, tables, stands, stools, vases, maxims, scrolls, &c., and in every respect will represent a room as actually occupied by the rich. This screen work extends over the tops of the cases the entire length of the north side of the room, and its effect, as seen by the writer, is extremely gorgeous, reminding him of the representations made in old illuminated manuscripts, before the invention of printing in Europe. The colors, violet, blue, crimson, scarlet, &c., are those employed by the illuminators, and lead one to believe that *they* imitated the Chinese.

*Furniture, books, &c.*—In addition to the furniture contained in this beautiful pavilion, there will be also distributed in the saloon a variety of Chinese domestic articles and utensils. Two dark colored and extremely rich bookcases, which might serve to ornament any library, will display copious specimens of the books of the Chinese, in their peculiar and safe binding, so rarely seen in this country. Specimens of their blocks or stereotyped wood are also in the collec-

tion. The bookcases are made in excellent taste, of a dark wood susceptible of a beautiful polish, and in some respects they may be considered an improvement on our own. The chairs of different forms, large and capacious, made of wood resembling mahogany, with their appropriate cushions and footstools, are in a taste of refinement and comfort, which would have been creditable to some of our forefathers of New England, into whose parlors they might have been introduced without differing much from the fashion of fifty years since. The stools without backs exhibit their adaptation to a southern climate, in being partly composed of China ware, marble, and wood.

There are also tables, such as ornament the rooms of the wealthy, gilt, and richly carved and painted; stands, inlaid with marble or precious wood, such as are placed between every two chairs to hold the tea apparatus, or those various little ornaments or flower pots, of which the Chinese it will be seen, are so remarkably fond. There is also a common table, such as is in universal use, and has been for centuries, which will be recognized by our present generation as a facsimile of the favorite eight legged table of our great grandfathers, now thrust by modern fashion into the kitchen or garret. It folds up as those do, and the legs are turned in rings; this, like a thousand things in the saloon, proves that our common usages have been derived from China, where we are accustomed to believe they are centuries behind us. The vases and seats of porcelain are particularly rich and unique.

*Natural history.*—The brevity we have been obliged to use in the foregoing enumeration, has prevented the mention of much that would have interested the readers of this Journal, and we have to regret that the department of natural history must be also merely touched upon. It evinces the comprehensiveness of Mr. Dunn's plan to find, that even in this particular, nothing has been omitted which time, trouble, and expense could accomplish, and as one evidence among many, of the laborious nature of the occupation of bringing these things together, we may mention the care bestowed upon the numerous objects of science here concentrated.

A young gentleman of Philadelphia, well known there as an enthusiastic naturalist, Mr. William W. Wood, son of Mr. William Wood, made his way to Canton in search of objects of interest, in the reasonable expectation of bettering his condition. Mr. Dunn at once sought his aid to perfect his collection, and employed his valuable time for a very considerable period. He had a *carte blanche* to procure objects in natural history, yet some art and no little subterfuge



were necessary, to persuade the Chinamen to collect articles of a kind in which they take no interest; prejudice and national feelings were to be overcome before they could be induced to make the necessary excursions by land and water, to spots where no foreigner could penetrate. By industry, money, flattery, and kindness, he succeeded, however, in amassing a great variety of birds, fishes, reptiles, shells, &c., and a few animals. Of these, all have arrived in good condition with the exception of the insects; the butterflies, moths, &c., which when last seen in Canton were particularly rich and curious, have suffered most by the delay in unpacking, and by natural causes.

Mr. Wood was indefatigable for many months in completing the herpetology of China; the conchology is fully represented in many rich and rare specimens; and one of the rarest birds, the mandarin duck, with its very peculiar plumage, will be new to many: the China partridge and many beautiful song birds, add variety and interest to the whole.

The fishes were procured principally at the famous fishing stations at Macao, where Mr. Wood resided for several months for this express purpose; the specimens are very numerous and rare. There has also been procured a great number of very fine drawings of fish from life in the accurate style of the Chinese, and in fine colors. The stuffed specimens will be neatly and appropriately arranged to afford a study for the naturalist.

In the department of botany, attention has been paid to procuring accurate drawings of many plants and flowers. These will be exhibited in frames.

The *minerals* in this collection are few in number, and together with the primitive rocks of China, embrace some remarkably fine carbonates of copper, both nodular and radiated.

The *shells* include the well known species of the China sea and the Canton river; the former, however, are of remarkable size and beauty, while a multiplicity of specimens illustrates all their varieties.

The writer regrets his want of acquaintance with the science of mineralogy, which prevents his more than alluding to the specimens, said to be highly interesting.

*Miscellanies.*—The jos-houses, pagodas, articles of *virtu*, of ornament, of stone, of jade, of ivory, bamboo, wood, metal, rice, &c., are so numerous that we can only allude to them. A case of shoes in all their clumsy or ornamental variety, exhibit the form of the compressed female feet, and the clumsy shape of those of the male; another of caps fresh from their makers, with the button of office, and the cheaper kinds of the poor; theatrical dresses, known to be those of the very

ancient Chinese, spectacles, opium and other pipes, fans the compass in great variety, models of fruits, coins, exquisite specimens of carving in ivory, metal, stone, and bamboo, very numerous and grotesque carvings from roots of trees, in which they exhibit a peculiar taste, singular brushes, combs, beautiful vessels of odoriferous wood for their altars and temples, of which latter there are models; very numerous ornamental stands carved with good taste; huge cameos in stone of great cost; fine specimens of their lacquered ware, as well as their common ware; a silk embroidered saddle; a water wheel worked like our *modern* tread-mill; a fan for cleaning rice resembling our own; lanterns of every possible shape, size, and ornament, will be suspended from various points, with their rich and tasteful paintings; there is a model of their very singular coffin, which few would even guess was designed to contain the last relics of humanity.

Space is wanting to perfect this notice of a collection highly creditable to the taste and liberality of the proprietor, and valuable to our country. No where else can we see so complete an exhibition of this interesting nation.

25. *Prof. Agassiz and his works.*—By a letter from this eminent naturalist, dated Neuchâtel, Nov. 5, 1838, received Jan. 4, 1839, at the moment of closing the present No., we learn the following facts respecting his new works now in the course of execution. The work on *THE FRESH-WATER FISHES OF EUROPE*,\* with numerous plates, executed with all possible care, and that on the *ECHINODERMATA*,\* will be published in such time, that the first number of each may arrive in this country early in the present year, 1839. *The fresh water-fishes* will appear in livraisons, containing each about 20 plates. *The Echinodermata* in livraisons, with 5 plates each, containing also the explanatory text.

It is known to the geological world, that Prof. Agassiz has recently published some novel and interesting views respecting the movement of the Erratic Blocs of the Jura, and upon Glaciers Moraines and Erratic Blocs.† On this subject he remarks in his letter:

“You will greatly oblige me if you will communicate to me such facts within your knowledge as have reference to the phenomena of the transport of erratic blocs, and especially with respect to polished surfaces in any regions in the vicinity of New York (or elsewhere.)

“I have it in contemplation to publish, in the course of next year, the result of extensive researches into this subject, and shall be very happy to add observations made in countries remote from ‘my own.’”

We have only room earnestly to recommend the works and wishes of Professor Agassiz to our geologists, and his wishes especially to those charged with the geological surveys. His address in this country is to M. August Mayor; care of Meyerat Nagath, New York.—EDS.

\* For a notice of these works, see vol. 34, p. 212 of this Journal.

† Jameson's Journal, for Oct. 1837, and April, 1838, vol. 24, pp. 176 and 364.

## INDEX TO VOLUME XXXV.

### A.

- Actinæ, gemmiferous bodies and vermiform filaments of, 311.
- Addams, Robt., on solid carbonic acid, 301.
- Agassiz, Prof., his new works noticed, 400.
- Airy, G. B., on correcting local magnetic action, 296.
- Allis, Mr., of York, on toes of Ostrich, 312.
- Allen, W., Capt., R. N., map of central Africa, 309.
- American Almanac, Vol. X, notice of, 191.
- Ammonia, constitution of commercial carbonate of, 297.
- Analysis of Gmelinite or hydrolite, 195.  
Mineral waters of Avon, 188.
- Annals of Natural History, noticed, 194.
- Antarctic seas, account of expedition to, 306.
- Anthony, J. G., describes fossil encrinite, 359.
- Antigua, geology of, by Prof. Hovey, 75.
- Application of small coal to economical purposes, 308.
- Armature, engine, reciprocating, 263.  
Revolving, 262.  
Vibrating, 267.
- Arsenic, specific gravity of, vapor of, 298.
- Association, British, for advancement of science, abstract of their proceedings in 1838, 275.
- Astronomical observations by Sir J. F. W. Herschel, 283.
- Asylum for the blind, 316.
- Atlantic steam navigation, several letters on, 160, 162, 332, 333, 336.  
remarks of Dr. Lardner on, 320.
- Atlee, Dr. W. L., on certain cavities in quartz, 139.  
on spontaneous combustion, 144.
- Aurora, atmospheric origin of, 145.  
resemblance to, observed in New York, 381.  
connection of, with crystallization of snow, 145.
- Auroral arch in Vermont, 380.
- Avon, mineral waters of, 188.

### B.

- Babington, botany of Channel Islands, 309.
- Bache, Prof. A. D., mention of Mr. Es-  
py's theory of storms to British As-  
sociation, 286.  
to report on meteorology of the  
U. S. to the Brit. Assoc. in 1839, 321.  
amount of rain collected by a gauge  
as influenced by currents of air, 287.
- Backhouse, E., on the Lestris tribe, 312.
- Baer, Von, on frozen ground in Siberia, 305.  
on expedition to Novaia Sem-  
fra, 306.
- Bailey, Prof. J. W., on the vascular sys-  
tem of ferns, 113.  
monstrous flower of *Orchis spec-*  
*tabilis*, 117.  
fossil infusoria, 118.  
on American Diatomæ, 111.
- Bakewell's Geology, 3d. edition of, an-  
nounced, 385.
- Barometer, substitute for, in measuring  
heights, 294.
- Beaufort, on the position of Cuzco, 309.
- Beck, Dr. L. C., manual of chemistry, 385.
- Binocular vision, Prof. Wheatstone on,  
295.
- Bituminized wood, curious deposit of,  
in Louisiana, 345.
- Bird, Dr. G., on the products of nitric  
acid and alcohol, 299.
- Blake, Mr. James, on injecting veins,  
313.
- Blowpipe mouth for oxygen and hydro-  
gen, 187.
- Boilers for steam, how rivetted, 320.
- Bone cavern in Mendip Hills, 304.
- Botany, section of, in British Associa-  
tion, 309.
- Bowditch, Nathaniel, memoirs of his  
life, 1.  
Eulogiums on him noticed, 386.  
list of his scientific papers, 46.  
translation of La Place's Mé-  
canique Céleste, 17.
- Brandes's account of the meteors of Dec.  
6, 1798, 361.
- Brewster, Sir David, on new phenom-  
ena of color in fluor spar, 295.
- Bridge suspension, 319.

- Brewster, Sir David, on new kind of polarity in homogeneous light, 291.  
 on Dr. Wallace's preparations of the eye, 291.
- Brisbane on difference of longitude, 296.
- British Association for the advancement of science, abstract of, for 1838, 200, 275.  
 shells, supposed new, 309.
- Buckland, Rev. Dr., account of footsteps on sandstone near Liverpool, 307.  
 application of small coal to economical purposes, 308.  
 letter to him from Dr. N. Webster, 375.
- C.
- Calcium obtained by Dr. Hare, 391.
- Cambridge, meteoric observations at, 323.
- Campbell, A. W., electro-magnetic engine, 343.
- Canis jubatus, 310.
- Carbonic acid, liquefaction and solidification of, 301, 346, 374.  
 emitted by a brine spring, 293.
- Carbon, specific gravity of its vapor, 298.
- Carpenter, Prof. W. M., geological notices of Opelousas and Attakapas, 344.
- Catlinite, new mineral analyzed, 388.
- Cattle of Chillingham Park, 310.
- Caustic potassa of commerce—nature of its coloring matter, 299.
- Cavities in quartz, 139.
- Chemical combinations, 302.
- Chemistry, manual of, by Dr. Beck, 385.
- Chemistry and mineralogy before the British Association, 297.
- China sea, tyfoons of, 209.
- Chesney, Lt. Col., ascent of the Euphrates, 309.
- Charlton, Dr., on Tetrao Rakkelhan, 312.
- Chinese curiosities collected by Mr. Dunn, 391.
- Chlorine, specific gravity of, 298.
- Cholera spasmodica, 313.
- Circular galvanometers, 259.
- Climate of America, by Dr. Daubeny, 288.
- Coates, B. H., M. D., use of *Uvularia perfoliata* for poisoned wounds, 270.
- Coal gas for cooking, 317.
- Color, new phenomenon of, in fluor spar, 295.
- Combustion of wood, spontaneous, 144.
- Compound electro magnets, 253.
- Comet, Encke's, observed, 388.
- Conchology, manual of, noticed, 386.
- Condensation of gases by Dr. Torrey, 374.
- Connell, A., Esq., analysis of gadolinite, 195.
- Conrad, T. A., notes on American geology, 287.
- Cook, Capt. J. E., on the genus *Pinus*, *Abies*, &c., 311.
- Courses of hurricanes, 201.
- Crichtonite, new locality of, 179, 180.
- Critical interpretation of bara and asah, 375.
- Crosse's experiments with the voltaic battery, 125.
- Crystallization of snow as connected with the aurora, 145.
- Cupellation, an easy mode of, 321.
- Cursory remarks on East Florida, 47.
- D.
- Dana, J. D., on a supposed new mineral, 178.
- Danburite, a new mineral species, 137.
- Darwin, Mr. C., animals collected by him, remarked on by Prof. Owen, 195.
- Daubeny, Dr. Charles, on the climate of N. America, 288.  
 thermal springs of N. America, 307.
- Dawes, Mr. J. S., on manufacture of iron, 303.
- Dean, Prof. J., auroral arch in Vermont, and eclipse, 380.
- Dent, portable mercurial pendulum, 289.
- Deflected currents of air, their influence on the rain gauge, 287.
- Description of two new shells, 268.
- Diatomæ, notice of some American species, 118.
- Diabetic sugar, analysis of, 298.
- Dickinson, Rev. J. T., geological specimens from him noticed, 381.
- Difference of longitude between London and Edinburgh, 290.
- Diluvial currents, evidences of by Dr. Hayes, 191.
- Double helix for inducing magnetism, 261.  
 stars, micrometrical measures of, 407, 284.
- Dunn's Chinese collection, 391.
- E.
- Echinodermata, by Prof. L. Agassiz, 400.
- Eclipse of the sun observed at New Haven, Sept. 18th, 1838, 174.  
 observed in Vt. by Prof. Dean, 380.
- Editors, remarks by them on American geology, 250.  
 by senior, on Mr. Junius Smith's letters, 336.
- Ehrenberg, Prof. C. G., on fossil infusoria, 311, 371.
- Electro-magnetism as a moving power, 106.  
 magnetic apparatus and experiments, 252.  
 engine, 343.  
 formula, general, 356.

- Electrotome and electropeter described, 112.
- Employment of *Uvularia perfoliata*, 270.
- Encke's comet observed, 388.
- Encrinite, fossil, by J. G. Anthony, 359.
- Engine, electro-magnetic, 343.
- with reciprocating armature, 263.
- Erdmann and Schweigger's Journal, extract from, 356.
- Espy, his theory of storms tested, 208.
- Ether, on a new one by Dr. Hare, 329.
- Excursion, geological, 309.
- Exley, Mr. Thos., on specific gravity of gases, 298.
- on chemical combinations, 302.
- Experiments in magnetic electricity, 252.
- Exploring expedition to the South Seas, 192.
- Extreme heat at Cumberland, Md., 190.
- F.
- Falco Islandicus, 310.
- Ferns, vascular system of, by Prof. Bailey, 113.
- Feuchtwanger's treatise on gems, 189.
- Fish with four eyes, 309.
- British, 309.
- Fires in London, 316.
- Flora of North America, 180.
- Florida, East, notices of, 47.
- Fluor spar, new phenomenon of color in, 295.
- Forbes, notice of subterranean heat and of a brine spring emitting carbonic acid, 293.
- Fossil animals collected by Mr. Darwin, 196.
- Fossils, as characteristic of strata, 237.
- Fossil fish in red sandstone of New Jersey, 192.
- Encrinite, 359.
- Infusoria, 118, 311, 371.
- shells and bones at Savannah, 380.
- teeth, by Prof. Owen, 307.
- Fox, a mineral vein obtained by him by galvanism, 308.
- Fresh-water fish of Europe, by Agassiz, 400.
- Frozen ground of Siberia, 305.
- G.
- Galactin, Dr. Thomson on, 303.
- Gale, Dr. L. D., on fossil fish in red sandstone of New Jersey, 192.
- Galvanometers, circular, 259.
- Gamboge, resin of, 304.
- Gases in the blood, experiments on by M. Magnus, 198.
- Gaseous compounds formed by the elements of water, 328.
- Gases condensed by Dr. Torrey, 374.
- Gaylord, Mr. W., his note on the meteoric shower of Nov. 1838, 370.
- Gems, treatise on, 189.
- Geography and geology of British Association, 304.
- Geology, American, notes on by T. A. Conrad, 237.
- of Antigua, 75.
- Elements of, by Lyell, American edition announced, 385.
- new edition of Bakewell, 385.
- of St Croix, 64.
- of Florida, 60.
- of North America, 307.
- of Maine, 387.
- and topography of western New York, 86.
- Mantell, wonders of, 384.
- science of, from Glasgow treatises, 387.
- Geological excursion, 309.
- surveys, 384.
- specimens sent from the Indian Archipelago, 381.
- Gibbs, Geo., notice of false aurora, 381.
- Glover, on rete mucosum and pigmentum nigrum, 313.
- Gold, T. S., new locality of Crichtonite, 179.
- Godfrey, his grave discovered, 389.
- Gold, easy mode of cupelling for, 321.
- Goniometer, portable reflective, 303.
- Graves on a general geometric method, 296.
- Graves of Godfrey and Chas. Thomson discovered, 389.
- Gray, Asa, notice of Flora of North America, 180.
- Gray, J. E., angular lines on certain mollusca, 310.
- on the boring of the Pholades, 312.
- on a British shell, 309.
- Greenhow, on mercury in neuralgia, 313.
- Griffith, account of geological map of Ireland, 306.
- H.
- Halley's comet, remarkable phenomenon of, 285.
- Handyside, Dr., on *Sternoptixinæ*, 312.
- Hancock, J., *Falco Islandicus*, 310.
- Hare, Dr. Robt., on a new ether and gaseous compounds formed with the elements of water, 329.
- calcium obtained by him, 391.
- fusion of platina in mass, 328.
- refutation of Maugham's charge, 331.
- Harris, Mr. Snow, meteorological observations made at Plymouth, 297.
- Hayes, Geo. E., on diluvial currents, 191.
- on the geology and topography of western New York, 86.
- Helix, double, for inducing magnetism, 261.

- Herapath, Mr. Wm., on a new process for tanning, 303.
- Herpetology of North America, by Holbrook, 186.
- Herrick, E. C., on shooting stars of August 9th, 1838, 167.  
on shooting stars of Dec. 7th, 1838, 361.
- Herschel, Sir J., remarks on Mr. Redfield's law of storms, 281.  
astronomical observations at the Cape of Good Hope, 283.  
phenomenon of Halley's comet, 285.  
vitreous humor of shark's eye, 293.
- Hills, Hlock, his quarries of marble in Vermont, 390.
- Hincks, Rev. W., on vegetable monstrosities, 310.
- Hindmarsh, Mr. J., on the wild cattle of Chillingham Park, 310.
- Hitchcock, Prof. E., note to Mr. Conrad's remarks, 246.
- Holbrook, Dr. J. E., his American Herpetology, 186.
- Hope, Mr., classification of insects, 311.  
on noxious insects, 313.
- Hovey, Prof. S., on geology of St. Croix, 64.  
on geology of Antigua, 75.
- Howell, B. B., extreme heat at Cumberland, 190.
- Hubbard, Prof., O. P., letter addressed to him on a storm in New Hampshire, 233.
- Hurricanes, with notices of the tyfoons of the China sea, 201.  
206, 220, 221.
- I.
- Indian pipe stone analyzed, 388.
- Infusoria, fossil and recent, 118, 311, 371.
- Inducing magnetism, double helix for that purpose, 269.
- Insects, which appeared in Mr. Crosse's electro-magnetic experiments, 125.  
noxious, 313.  
their depredations obviated, 338.
- Interpretation of *bara* and *asah*, by Dr. Noah Webster, 375.
- Iron, new mode of manufacturing, 303.
- Isomorphism, exception to law of, 302.
- J.
- Jackson's report of geology of Maine, 387.  
his analysis of Indian pipe stone, 388.
- Jardine, on Salmonidæ of Scotland, 312.
- Jervis, Maj. J., survey of British India, 308.
- Jenyns, Rev. L., on the square-tailed shrew, 312.
- Johnston, Dr., on an exception to the law of Isomorphism, 302.  
resin of gamboge, 304.
- Joslin, Prof. B. F., on the aurora as connected with the crystallization of snow, 145.
- K.
- Kirwan, Dr. R., capture of his library, 26.
- L.
- Lagoons of Florida described, 54.
- Lardner, Dr., on navigation of the Atlantic by steam, 320.
- Lea, Isaac, observations on the genus *Unio*, 184.  
notice of Wyatt's manual of conchology, 386.
- Lead ores, easy mode of cupelling, 321.
- Leithart, on the stratification of rocks, 306.
- Level line measured, 287.
- Levelling stave, new, described, 318.
- Life and character of Dr. Bowditch, 1.
- Light, blanching effects of, obviated, 338.
- Lime, its power of absorbing moisture from plants, 338.
- Liquefaction and solidification of carbonic acid, 301, 346, 374.
- Lloyd, Prof., on magnetic dip and intensity, 296.
- Long, description of a bone cavern in Mendip hills, 304.
- Loomis, Prof. Elias, on meteor of May 18th, 1838, 223.
- Lunar volcanoes, notice of, 305.
- Lyell, Chas., on vertical lines of flint, 305.  
Elements of geology, noticed, 385.
- M.
- Magnetic action, (local,) mode of obviating, 296.  
dip and intensity in Ireland, 296.  
electrometer and electrotome, 112.
- Magneto-electrical experiments, 252.
- Magnus, on gases in the blood, 198.  
on respiration, 198.
- Mallet, Mr. R., on commercial potass, 299.
- Mandingo, account of a native, 305.
- Mantell's Wonders of geology, 384.
- Marble in Vermont described, 390.
- Mason, E. P., micrometric measurements taken by him, 176.
- Mathematical and physical section of British Association, 276.
- Mather, W. W., easy mode of cupellation, 321.
- Maugham, false claim to hydro-oxygen blowpipe, 304; refuted, 331.

- M<sup>r</sup>Alister, asylum for the blind, 316.  
 M<sup>r</sup>Cord, his meteorological register for 1837, 382.  
 Mécanique Céleste, translated by Bowditch, 317.  
 Mechanical science, 317.  
 Medical science, 313.  
 Memoir of Dr. Bowditch, 1.  
 Mendip hills, bone cavern in, 304.  
 Mercurial pendulum, portable, 289.  
 Meteoric observations made at Cambridge, 321.  
     of Dec. 7th, 1838, 361.  
     shower of Nov. 1838, 368.  
 Meteor of May 18th, 1838, 223.  
 Meteorological register kept at Montreal, L. C., for 1837, 382.  
 Miller, Prof., portable goniometer, 303.  
 Milne, D., on Berwick and North Durham coal fields, 308.  
 Mineral, new species, at Bolton, 178.  
     Catlinite, 388.  
     Danburite, 137.  
     diarsenate of lead, 297.  
 Mineralogy of the British Association, 297.  
     descriptive, second part of, announced by Prof. Shepard, 187.  
 Miscellaneous notices in Opelousas, Attakapas, &c., 344.  
 Mitchell, Prof. E., notice of high mountains in North Carolina, 377.  
     Prof. J. K., on liquefaction and solidification of carbonic acid, 346.  
 Mountains in North Carolina, height of, 377.  
 Moving power of electro-magnetism, 106.  
 Murchison's geological map of England and Wales, 306.
- N.
- Navigation of the Atlantic by steam, 160.  
     letters of Junius Smith on, 333.  
 Navigator, practical, by Bowditch, 11.  
 Navy of steam ships, 333.  
 Nebulæ, approximate places of, 284.  
 Newcastle coal fields, 305.  
 New Jersey tornado in 1835, 206.  
 New mineral species, notice of, by Prof. Shepard, 137.  
     supposed at Bolton, 178.  
     Catlinite, 388.  
     diarsenate of lead, 297.  
 New Zealand, changes of population in, 315.  
 Nitrate of silver, pure, not blackened by sun's direct rays, 298.  
 Nitrogen, specific gravity of, 298.  
 North Carolina, high mountains in, 377.  
     American herpetology, 186.  
 November shower of meteors, observations on, 361.  
 Noxious insects, 313.
- O.
- Observations on shooting stars of Dec. 7th, 1838, 361, 364.  
     on meteors of Nov, 1838, 368.  
     on vascular system of ferns, 113.  
 Odontograph, a new instrument, 319.  
 Oil from white fish, 391.  
 Olmsted, Prof. D., observations on the eclipse of the sun, Sept. 18th, 1838, 174.  
     meteoric shower of November, 1838, 368.  
 Opelousas and Attakapas, geological notice concerning, 344.  
 Orchis spectabilis, monstrous flower of, 117.  
 Ornithichnite, note on by Prof. Hitchcock, 246.  
 Ostrich toes, 312.  
 Owen, Prof., on the fossils collected by Mr. Darwin, 196.  
     structure of fossil teeth, 307.  
     Wollaston medal presented to, 197.  
 Oxygen, its specific gravity, 298.
- P.
- Page, Chas. G., on electro-magnetism as a moving power, 106.  
     electrometer and electro-tome, 112.  
     magneto-electric and electro-magnetic apparatus and experiments, 252.  
 Palmetto used as food in Florida, 59.  
 Paludina heterostropha described, 269.  
 Parnell, Dr., rare British fishes, 310.  
 Pattinson, H., new mode of extracting silver from lead, 299.  
 Pendulum, portable mercurial, 289.  
 Physa Sayii described, 269.  
 Phosphorus, specific gravity of its vapor, 298.  
 Pickering, Hon. John, notice of life of Dr. Bowditch, 386.  
 Plants, mode of preserving, 338.  
 Platina, fusion of, in quantity, 328.  
 Poisoned wounds treated with Uvularia, 270.  
 Proceedings of British Association in 1838, 275.  
 Preparations of the eye, by Dr. Wallace, 291.  
 Products of nitric acid and alcohol, 299.  
 Prout's analysis of starch sugar, 299.
- Q.
- Quartz, cavities in, 139.

## R.

- Railway cars, rapidity of motion in, 197.  
 Railways constructed with cast iron sleepers, 318.  
 Rain, on unequal quantities collected, by the gauge, 287.  
     quantity in different parts of the earth, 295.  
 Rawson, Mr., on fires in London, 316.  
 Raleigh's typhoon of 1835, 210.  
 Recalculation of observations on the magnetic dip and intensity in Ireland, 296.  
 Reciprocating armature engine, 263.  
 Redfield, W. C., law of storms, 182, 276.  
     on the courses of hurricanes and tyfoons of China sea, 201.  
 Reid, Col., on Mr. Redfield's law of storms, 276.  
     his work on storms noticed, 182.  
 Reports on shooting stars, 167, 223, 323, 361, 368.  
 Respiration, M. Magnus on, 198.  
 Riddell, Dr., new mode of preserving plants, 338.  
     on electro magnetic engine, 343.  
 Ripple marks in the transition, 248.  
 Robison, substitute for barometer, 294.  
 Rodman, W. W., on new localities of minerals, 179, 180.  
 Rogers, H. D., opinion on age of graywacke attacked, 243.  
     the same explained by editors, 250.  
 Russell on waves, 290.  
     substitute for mountain barometer, 294.

## S.

- Salisbury, Dr. S., his analysis of the mineral waters of Avon, 188.  
 Sandstone, footsteps on, near Liverpool, 367.  
     of New Jersey containing fossil fish, 192.  
     peculiar variety of, 249.  
 Sang, Mr., on rapidity of motion in railway cars, 197.  
 Scanlan on commercial carbonate of ammonia, 297.  
     nitrate silver not blackened by sun light, 298.  
 Schweigger Seidel, his general electric formula, 356.  
 Serpentine in Vermont, 390.  
 Shells, new species of, described by Judge Tappan, 268.  
     supposed new, 309.  
 Shepard, C. U., notice of a new mineral species, (danburite,) 137.

- Shepard, C. U., 2d part of mineralogy by him, 187.  
 Ships without masts, 332.  
 Shooting stars, 167, 223, 323, 361, 368.  
 Siberia, frozen ground of, 305.  
 Silurian and transition system, 243.  
 Smith, Henry, letter to Prof. Silliman, 336.  
     Junius, letters on steam navigation, 160, 332.  
     Dr., on variation in quantity of rain in different parts of the earth, 295.  
     H. L., account of his telescope, 174, note.  
 Sopwith's mode of constructing secretaires, 317.  
 Sowerby, on *Encrinus moniliformis*, 311.  
 Specific gravity of several elements, 298.  
 Spontaneous combustion of wood, 144.  
 Statistics, section of, in British Association, 314.  
 Statistical tables, 315.  
 Steam navigation, letters on, 160, 161, 332, 333.  
     boilers, new construction of, 318.  
 Stereoscope, instrument for illustrating binocular vision, 295.  
 Storms, Reid on the law of, 182.  
     considered before the British Association, 276.  
     Col. W. Reid's book on, 182.  
     natural system of, 222.  
     of Europe, 222.  
 Storm in New Hampshire in 1821, 233.  
 Strickland, Mr. A., on *Ardea alba*, 311.  
 St. John's river, remarks on, 48.  
 Sugar, (diabetic,) analysis of, 298.  
     of starch, 298.  
 Sulphur springs in Florida, 51.  
     vapor, specific gravity of, 298.  
 Surveying and exploring expedition to the South Seas, 192.  
 Substitute for the mountain barometer, 294.

## T.

- Tanning, new process for, 303.  
 Tappan, Judge, description of new shells, 268.  
 Taylor, W. C., change of population in New Zealand, 315.  
 Temperature of the interior of the earth, 293.  
     of deep mines, 297.  
     produced by evaporation of solid carbonic acid, 347, 353.  
     of wells and springs at different elevations from earth's surface, 379.  
     in different geological epochs, 240.



- Teale, T. P., on vermiform filaments of actiniæ, 311.
- Telescope, 14 ft. reflector, 174.
- Theory of Mr. Espy on storms, 208, 281.
- Thomson, Dr. T., analysis of diabetic sugar, 298.
- of diarsenate of lead, 297.
- foreign substances in iron, 302.
- on galactin, 303.
- Prof. R. D., of emulsin and amygdalin, 302.
- Charles, his grave found, 390.
- Tides, discussion of, by Whewell, 290.
- Tornado in New Jersey in 1835, 206.
- Torrey, Dr. John, notice of flora of N. America by him and Dr. Gray, 180.
- condensation of gases by, 374.
- Transition and silurian system of rocks, 243.
- organic remains of, 246.
- Treatise on gems, 189.
- Trimmer, occurrence of marine shells in Cefn Cave, 306.
- Tyfoons of the China sea, 209.
- at Balasore, 220.
- Canton, 217, 218.
- Manilla, 220.
- Raleigh's, 210.
- method of escaping, 211.
- U.
- Unio, new observations on, 184.
- Sayii described, 268.
- Uvularia perfoliata used in poisoned wounds, 270.
- V.
- Vanilla in Europe, 310.
- Vegetable monstrosities, 310.
- Vibrating armature, 267.
- Vitreous humor of shark's eye, 293.
- Volcanoes in the moon, 305.
- Voltaic battery, Crosse's experiments with, 125.
- W.
- Wailes, Rev. Mr., on rare insects, 310
- Washington, Capt., account of a Mandingo, 305.
- of recent expeditions to Antarctic seas, 306.
- Washington, Capt., account of trigonometrical surveys, 308.
- Wallace, Dr. W. Clay, preparations of the eye, 291.
- Waves, report of the committee on, 290.
- Webb, on lunar volcanoes, 305.
- Webster, Prof., discovery of green feldspar and galena, by, 192.
- claim to blowpipe mouth, 180.
- Dr. Noah, interpretation of *bara* and *asah*, 375.
- Western N. Y., geology and topography of, 86.
- Wheatstone on binocular vision, 295.
- Whewell, account of a level line, 287.
- report of discussion of tides, 290.
- Whiting, Major H., remarks on East Florida, 47.
- White, Judge, his eulogium on Dr. Bowditch, noticed, 386.
- Wilcox, W. W., letter from, respecting oil from white fish, 391.
- Wilmington island, fossils of, 380.
- Wire used as ropes, 319.
- Winds, natural system of, 222.
- Wollaston, medal presented to Prof. Owen, 197.
- Wonders of Geology, by Dr. Mantell, 384.
- Wood, spontaneous combustion of, 144.
- curiously flattened by pressure and bituminized, 335.
- Woods, Rev. John, on storm in New Hampshire, 233.
- Worcester, J. E., notice of the American almanac conducted by him, 191.
- Wyatt, Thos., manual of conchology by him noticed, 386.
- Y.
- Yarrell, Mr., on *Osmærus Hebridicus*, 312.
- Yelloly, on an acoustic instrument, 313.
- Young, Rev. Alex., memoir of Dr. Bowditch, 1.
- Young, Rev. G., antiquity of organic remains, 308.
- Z.
- Zoology, section of, in British Association, 309.



157

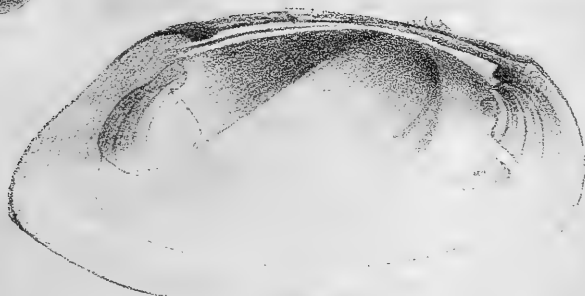
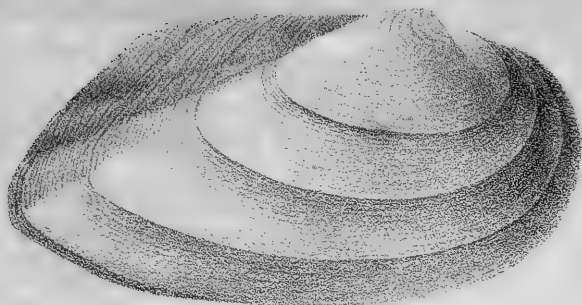

No. 1 *Unio Sayii* Ward

2 *Heterostropha* Kiriland

3 *Phya*<sup>5</sup> *Sayii* (Hab. Lake Pepin Ohio)

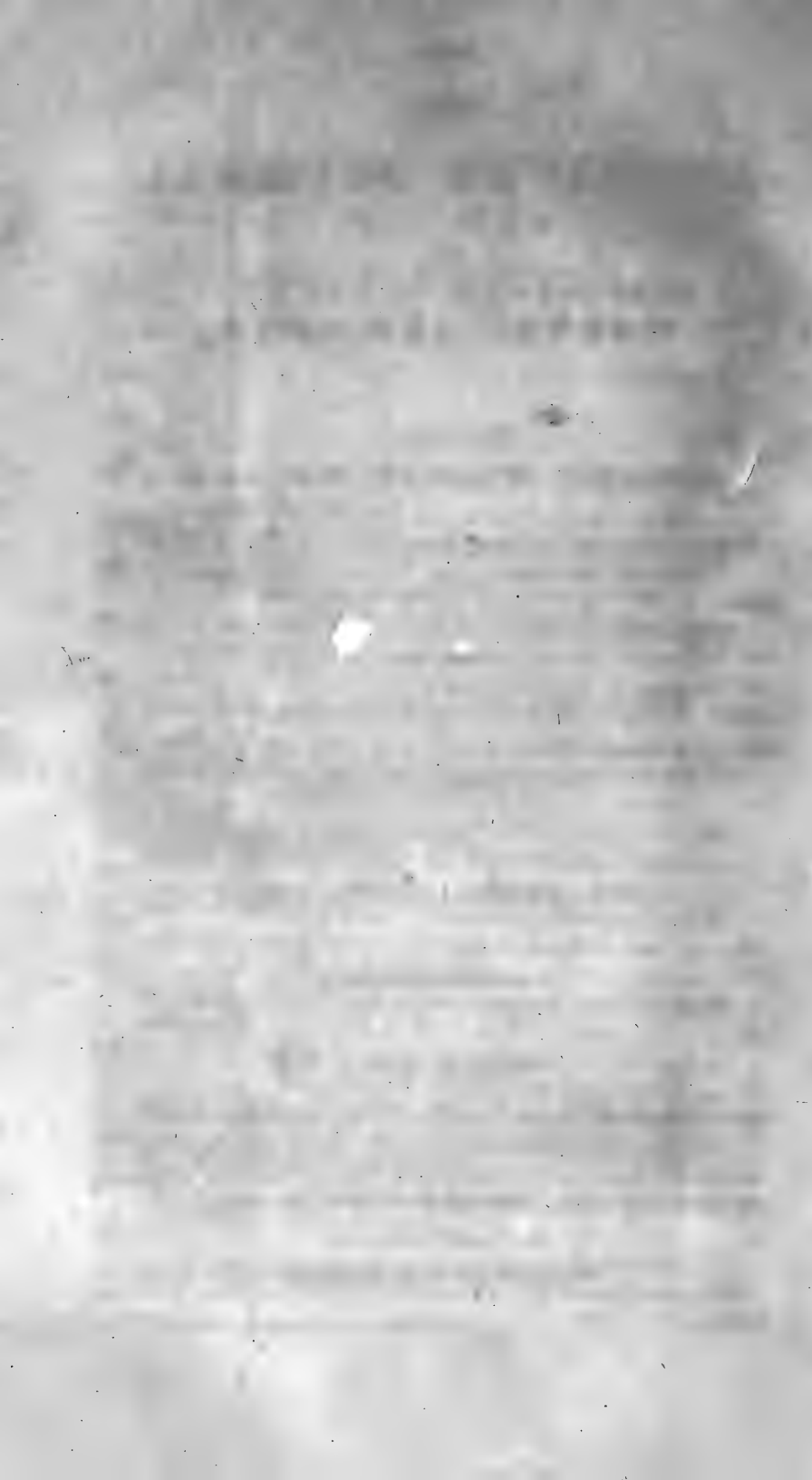

ACKNOWLEDGMENTS TO CORRESPONDENTS, FRIENDS  
AND STRANGERS.

*Remarks.*—This method of acknowledgment has been adopted, because it is not always practicable to write letters, where they might be reasonably expected; and still more difficult is it to prepare and insert in this Journal, notices of all the books and pamphlets which are kindly presented, even in cases, where such notices, critical or commendatory, would be appropriate; for it is often equally impossible to command the time requisite to frame them, or even to read the works; still, judicious remarks, from other hands, would usually find both acceptance and insertion.

In public, it is rarely proper to advert to personal concerns; to excuse, for instance, any apparent neglect of courtesy, by pleading the unintermitting pressure of labor, and the numerous calls of our fellow-men for information, advice, or assistance, in lines of duty, with which they presume us to be acquainted.

The apology, implied in this remark, is drawn from us, that we may not seem inattentive to the civilities of many respectable persons, authors, editors, publishers, and others, both at home and abroad. It is still our endeavor to reply to all letters which appear to require an answer; although, as a substitute, many acknowledgments are made in these pages, which may sometimes be, in part, retrospective.—*Eds.*

SCIENCE.

*Foreign.*

Remarks on the Mineralogy and Geology of Nova Scotia, by Abraham Gesner, Surgeon, Halifax, 1836. From Neville Parker, Esq.

Transactions of the Literary and Historical Society of Quebec, Vol. III, Part IV. From the Society.

Address of the Duke of Sussex, before the Royal Society, London, Nov. 30, 1837. From Wm. Vaughan, Esq., London.

Researches on Heat, by Prof. J. D. Forbes, Edinburgh. Third series. From the Author. Forwarded by the kindness of Mr. Vaughan.

The ninth Bridgewater Treatise, by Chas. Babbage, Esq. Second edition. London, J. Murray, Albermarle st., 1838. From the Author.

Icones Plantarum: figures and descriptions of new or rare plants, by Sir William Jackson Hooker, K. H. London, 1838. From the Author. Part IV.

Kongl.-Vetenskaps-Academiens Handlingar För Ar 1836. Stockholm, 1838. From Jac. Berzelius, K. V. A. Secret.

Arsberättelse om Framstegen i Fysik och Kemi, Mart. 1836, af Jac Berzelius. Stockholm, 1836. From the Author.

———— om Technologi, 1836, af G. E. Pasch. Stockholm, 1836. From Prof. Berzelius.

———— om Zoologiska Arbeten, 31 Mart. 1835 och 1836, af B. Fr. Fries. Stockholm, 1837. Prof. Berzelius.

———— om Botaniska Arbeten och upptäckter. För Ar 1835, af Joh. Em. Wikström. Stockholm, 1837. Prof. Berzelius.

———— om Hydraulikens, af P. Lagerhjelm. Stockholm, 1837. Prof. Berzelius.

Arsberättelse i Astronomien af S. A. Constrand. Den 31 Mart. 1836.

Elements of Geology, by Charles Lyell, Esq., F. R. S. London, 1838. From the Author.

The Fifth Annual Report of the Royal Cornwall Polytechnic Society, 1837. Falmouth. From the Society.

The Logs of the first voyage of the Great Western, Steam Ship. Bristol, 1838. Two copies. From Mr. S. Luckie.

Phillips' Introduction to Mineralogy, by Robert Allan. Fourth Edition. London, 1837.

#### *Domestic.*

Holbrook's North American Herpetology. Two vols. quarto—plates. Dobson, Philadelphia.

Treatise on Gems, by Dr. Lewis Feuchtwanger. New York, 1838. From the Author.

Transactions of the American Philosophical Society, Vol. VI, new series. Phila. 1838. Kay & Brother. From the Society.

The same, from Isaac Lea, Esq., containing his observations on the Genus Unio, with descriptions of new genera and species in the family Naiades, &c.

Report on the George's Creek Coal and Iron Company's lands, with a description and drawings of part of the Cumberland Coal Basin, 1836. From the Authors.

Olmsted's Natural Philosophy, 2d edititon, enlarged. 2 vols. 8vo., New Haven, 1838. From the Author.

American Almanac, Vol. X, Boston, 1839. From J. E. Worcester, Esq., Editor.

Analysis of the Mineral Waters of Avon, N. Y., 1838, several copies. From Dr. Salisbury.

On the influence of Caloric on the living Animal Body, by Robert Peter, M. D. From the Author.

Report of the Committee on Naval Affairs, on the Project of Dr. H. H. Sherwood, for determining Latitude and Longitude by the Variation and Dip of the Magnetic Needle. From Hon. N. P. Tallmadge—another from Hon. J. Davis.

The Cultivator, for 1838. From Hon. Judge Buel, Editor.

The Annual Report of the Water Commissioners, New York, 1838. From Mr. Redfield.

Catalogue of Plants found in the vicinity of Milwaukie, Wisconsin. From J. A. Lapham, Author.

Faith the life of Science—an Address before the *φ. B. K.* of Union College, by Taylor Lewis, Albany. From the Society.

Transactions of the American Philosophical Society, Phila. Historical and Literary, Vol. VII, Du Ponceau on Chinese Writing. From the Author.

Liquefaction and Solidification of Carbonic Acid, by and from J. K. Mitchell, M. D.

Report of Prof. Shepard on the Missouri Iron Mountains. Author.

First and Second Reports of the progress of the Geological Survey of the State of Virginia for the years 1836-7, by Prof. Wm. B. Rogers. From the Author.

Report on the Geological Survey of the State of New Jersey, second edition, by Prof. Henry D. Rogers. From the Author. Philad. 1836.

Catalogue of Philosophical and Chemical Apparatus for sale by Joseph Wightman, 33 Cornhill, Boston. From Mr. J. Wightman.

Mr. Pickering's Eulogy on Dr. Bowditch. Two copies, one for the Connecticut Academy. From Mr. Pickering. Boston, 1838.

Map of Florida. From Col. Whiting, Detroit.

Observations on the Le Motte Mines and Domaine in Missouri. Washington, 1838. From Forrest Shepherd.

Manual of Conchology, by Thos. Wyatt, M. A.—Many plates. Philad. 1838. From the Author.

Monography of the family Unionidae, or Naiades of Lamarck, by T. A. Conrad. Nos 8, 10, 11, two copies in exchange. From Mr. Dobson, publisher.

The Science of Geology, from the Glasgow Treatises, with additions. First American edition. New Haven, 1838. B. & W. Noyes. 3 copies, (two from the publishers, one from W. C. R.)

Prof. Shepard's Address before the Horticultural Society in New Haven. From the Author.

#### MISCELLANEOUS.

##### *Foreign.*

Annual Report of the Morrison Education Society, Canton, China, 1838. From Dr. Parker.

- Seventh Quarterly Report of the Ophthalmic Hospital at Canton,  
by Rev. P. Parker, M. D. From the Author.  
Medical Missionary Society in China. From Dr. Parker.  
Laborer's Friend, London, No. 71. From William Vaughan, Esq.  
Constitution and By Laws of the Sandwich Island Institute, 1838.  
Rev. J. Diell.  
Annual Report of the Canada Sunday School Union.

*Domestic.*

- Catalogue of Officers and Students of Wabash College.  
" " " Harvard Univer., 1838-9.  
S. F. Plimpton.  
Catalogue of the Collegiate Department of the University of  
Pennsylvania, Philad. Prof. Parkes.  
Catalogue of Columbia College, New York, from 1758 to 1836.  
Prof. Renwick.  
Catalogue of Dartmouth College for 1838-9. Hanover, N. H.  
Dr. Lord.  
Catalogue of New Hampshire Medical Institution, Dart. Coll., for  
1838. Prof. Hubbard.  
Catalogue of the Theological Department in Yale College, 1838.  
" of the Western Reserve College for 1838-9. From  
Prof. Loomis. Two copies.  
Thirteenth Annual Report of the Prison Discipline Society. Bos-  
ton, 1828.  
Annual Circular of the Medical College of Louisiana of 1839.  
Annual Commencement of Jefferson Medical College, Philadel-  
phia, for 1838-9.  
Present State and Condition of the Free People of Color of Phil-  
adelphia, 1838. J. Vaughan, Esq.  
Charter of the Electro-Magnetic Company.  
History of the Controversy in N. Y. University, by the Professors  
and Faculty. From Mr. Elliott.  
A Letter to the Chancellors of the University of the City of New  
York. From the Professors.  
Home Mission Society. 12th Annual Report. From the Soc.  
American Bible Society. 22d Annual Report.  
Letter to the Willard Association of Troy, N. Y., by and from  
Mrs. Willard.  
Report of the Executive Committee of the American Temper-  
ance Union, 1838, Philad. From Rev. J. Marsh.  
Refutation of Charges made by Dr. Caldwell against Prof. J. C.  
Cross. From the Author.  
Twenty second Report of the Directors of the Deaf and Dumb  
Asylum at Hartford, Conn. 1838.



Message from the Governor to the General Assembly of Pennsylvania. Harrisburg, 1838. From Gov. Ritner.

Sachem's Wood, a poem, by J. A. Hillhouse. Author.

Thos. Williams' Centennial Sermon, preached 1836. From Mr. Williams.

Christian Examiner and General Review, No. 87, July, 1838, containing a notice of Geological Surveys.

Medical Education, and Address before the Medical Society of Tennessee, by Dr. Yandell. From the Author.

Report of the First American Fair at Cincinnati, Ohio, with an Address by E. D. Mansfield. From Mr. Mansfield.

Internal Improvements in the State of N. York, by H. O'Reilly.

An Address before the Cuverian Society of Wesleyan University, Middletown, Conn., by Prof. William H. Allen. From the Author.

Report of F. R. Hassler, Superintendent of the fabrication of Standard Weights and Measures. Senate, No. 500. Two copies, from Mr. Hassler.

Report of F. R. Hassler, Superintendent of the Coast Survey, Senate, No. 79. From Mr. H. 2 copies.

#### SPECIMENS.

A box of Peat Earth. From Rev. H. Linsley, Stratford.

A small box of African Shells. From Dr. Savage, of Middletown.

A box of Minerals, casts of Ornithichnites, and Peat. From Prof. Hitchcock, Amherst, Mass.

A mass of Mineral Tar, from the bitumen lake, Trinidad. From Dr. Van Buren, Trinidad, by the hands of Dr. Hooker.

Botanical and other specimens, illustrative of the Natural History of Florida. From Col. Whiting.

A box of fresh water Shells, for the Yale Natural Hist. Society. From Mrs. L. W. Say, New York.

#### NEWSPAPERS.

##### *Domestic.*

Daily Buffalo Journal. No. 770. Contains Mr. J. S. Buckingham's verses on Niagara.

New York Sun. July 13th, 1838. "*Antiquities unearthed.*" C. J. Lynde.

The Country Advertiser. Petersburg, Va. Several Nos.

Elizabethtown Republican. Jan. 2, 1838.

Connecticut Common School Journal. Nos. 1 to 6. H. Barnard, Esq. Hartford.

Louisville Gazette. Eight Nos.; containing geological notices by J. W.

New York Common School Annual.

Daily Chronicle. Augusta, Ga. No. 170. J. H. Plant.

New York Transcript. Vol. 7. No. 111. Mr. Holebrook's system of education.

Several papers on the affairs of the New York University. From G. S. Silliman, Esq.

Albany Daily Advertiser. July 4th, 1838. Lines on 4th of July. From J. S. Buckingham, Esq. Eng.

Boston Patriot. August 25th, 1838. Eclipse of the sun.

Troy Daily Morning Mail. No. 319.

Genesee Farmer. Rochester, N. Y. No. 41, Vol. 8. W. Gaylord.

Boston Mercantile Journal. Vol. 6, No. 28. N. Capen.

Buffalo Commercial Advertiser. Aug. 1st. 1831. Contains a notice of this Journal.—Also Daily Journal, with notice of aurora of 13th of Sept. and following nights.

Buffalo Patriot and Commercial Advertiser. Nov. 28, 1838. With notice of Am. Journal. Vol. 35, No. 1.

Do. do do. do. Dec. 15. With a notice of diluvial scratches.

The same, of Dec. 24th. With extracts of proceeding of the French Academy.

The same, of Dec. 27th. With do. do. The above five all from Mr. R. W. Haskins.

Harrisburg Chronicle, of Dec. 5th, 1838. No. 55. Do. No. 59. The Keystone, of Dec. 7th. Pennsylvania Telegraph, extra, Dec. 6: all from Mr. N. Ellmaker; containing accounts of the recent proceedings at Harrisburg, with the proclamation of the governor of Pennsylvania.

The Temperance Herald. Providence. Dec. 6th, 1838.

Mississippi Free Trader, of Nov. 22d, 1838. Containing a letter on the properties of *Jussiaea grandiflora*, by and from Dr. Cartwright of Natchez.

Phil. National Intelligencer, Dec. 27th, 1828. Notice of working iron by anthracite coal. From J. W. Robinson.

Farmer's Register, with Dr. Armstrong's Agricultural Address. No. 9. 1838.

Christian Statesman. Washington. Dec. 21st, 1838. Meeting of the American Colonization Society. From R. Gurley.

Daily Courant. Hartford. Dec. 18th, 1838. Notice of Mr. J. A. Hillhouse's lecture. From Mr. H. Barnard.

Boston Independent Chronicle and Patriot. Jan. 5th, 1839. Extraordinary height of barometer.  $31\frac{1}{8}$  inches on Tuesday, Jan. 1st, 1839.

*Foreign.*

London Athenæum. Nos. 565-6-7-8. British Association of August, 1838. Received from Rev. Samuel Wood, Canterbury. England.

Montreal Morning Courier. Nov. 6th, 1838. Account of Lord Durham's departure from Canada.

London Morning Advertiser. Oct. 3d, 1838. With a notice of Mr. Richardson's geological lectures at Brighton. From Mr. Richardson.

The Publisher's Circular. Nos. 26 and 27. London. From Wiley & Putnam.

New books for sale by Wiley & Putnam.

AMERICAN INSTITUTION FOR THE CULTIVATION OF SCIENCE.

The following Circular was received too late for insertion in the body of our present number,—we accordingly, that no time may be lost, take this method of placing it before our readers :

BOSTON, NOVEMBER 1, 1838.

IN consequence of communications between members of the AMERICAN PHILOSOPHICAL SOCIETY, in Philadelphia, and gentlemen in Boston, a meeting was held in the latter place, of gentlemen belonging to Boston, Salem, and the University at Cambridge, at which the proceedings were as follows :

His excellency, Governor Everett, was requested to take the chair.

The Hon. Francis C. Gray was chosen Secretary.

The Chairman stated the objects of the meeting.

Dr. Warren offered and explained the three following resolutions, which were eloquently supported by the Hon. Judge Story and other gentlemen, and unanimously adopted.

1. *Resolved*, That it is expedient to form an Institution to be called the AMERICAN INSTITUTION FOR THE CULTIVATION OF SCIENCE, having for its object the advancement of physical science and literature, by assembling those interested in this object at stated periods, thus effecting an interchange of discoveries and improvements between the inhabitants of different parts of the country.

2. *Resolved*, That the organization of such an Association can best be accomplished by scientific and literary persons situated in a central part of the country, and that therefore we recommend that the American Philosophical Society, in Philadelphia, be invited to undertake this organization, with the understanding that the meetings be held successively in the different great cities of the Union.

3. *Resolved*, That as frequent meetings of those here assembled might not be practicable, a Committee of Correspondence be created, whose duty it shall be to call meetings when necessary, to communicate with the American Philosophical Society and other scientific associations, and to advance the object of this meeting by all means in their power.

*Committee.*

DR. WARREN,	HON. F. C. GRAY,
GOV. EVERETT,	DANIEL TREADWELL, Esq.,
HON. JUDGE STORY,	DR. HALE.
JOHN PICKERING, Esq.	

An account of the proceedings at this meeting is transmitted to you, with the hope of obtaining your concurrence, that of your scientific friends, and of scientific associations with which you are connected, in the prosecution of this object.

By order of the Committee of Correspondence.

JOHN C. WARREN, *Chairman.*

THE  
AMERICAN JOURNAL  
OF  
SCIENCE AND ARTS.

---

CONDUCTED BY

BENJAMIN SILLIMAN, M. D. LL. D.

Prof. Chem., Min., &c. in Yale Coll.; Cor. Mem. Soc. Arts, Man. and Com.; and For. Mem. Geol. Soc., London; Mem. Geol. Soc., Paris; Mem. Roy. Min. Soc., Dresden; Nat. Hist. Soc., Halle; Imp. Agric. Soc., Moscow; Hon. Mem. Lin. Soc., Paris; Nat. Hist. Soc., Belfast, Ire.; Phil. and Lit. Soc., Bristol, Eng.; Hon. Mem. Roy. Sussex Inst., Brighton, Eng.; Lit. and Hist. Soc., Quebec; Mem. of various Lit. and Scien. Soc. in America.

AIDED BY

BENJAMIN SILLIMAN, JR., A. B.

Assistant in the department of Chemistry, Mineralogy and Geology in Yale College; Sec. of the Yale Nat. Hist. Soc., Mem. of the Conn. Acad. of Arts and Sci.; Cor. Mem. of the Lyceum of Natural History, New York, &c.

---

VOL. XXXV.—No. 1.—OCTOBER, 1838.

FOR JULY, AUGUST, AND SEPTEMBER, 1838.

---

NEW HAVEN:

Sold by A. H. MALTBY and B. & W. NOYES.—Philadelphia, CAREY & HART and J. S. LITTELL.—Baltimore, Md., N. HICKMAN.—New York, G. & C. CARVILL & Co., No. 108 Broadway, and G. S. SILLIMAN, No. 45 William St.—Boston, C. C. LITTLE & Co.—London, JAMES S. HODSON, No. 112 Fleet St.—Paris, CHARLES DUPERRON, Rue Mabillon.

---

PRINTED BY B. L. HAMLEN.



THE  
**AMERICAN JOURNAL**  
OF  
**SCIENCE AND ARTS.**

---

CONDUCTED BY

**BENJAMIN SILLIMAN, M. D. LL. D.**

Prof. Chem., Min., &c. in Yale Coll.; Cor. Mem. Soc. Arts, Man. and Com.; and For. Mem. Geol. Soc., London; Mem. Geol. Soc., Paris; Mem. Roy. Min. Soc., Dresden; Nat. Hist. Soc., Halle; Imp. Agric. Soc., Moscow; Hon. Mem. Lin. Soc., Paris; Nat. Hist. Soc., Belfast, Ire.; Phil. and Lit. Soc., Bristol, Eng.; Hon. Mem. Roy. Sussex Inst., Brighton, Eng.; Lit. and Hist. Soc., Quebec; Mem. of various Lit. and Scien. Soc. in America.

AIDED BY

**BENJAMIN SILLIMAN, JR., A. B.**

Assistant in the department of Chemistry, Mineralogy and Geology in Yale College; Sec. of the Yale Nat. Hist. Soc., Mem. of the Conn. Acad. of Arts and Sci.; Cor. Mem. of the Lyceum of Natural History, New York, &c.

---

**VOL. XXXV.—No. 2.—JANUARY, 1839.**

**FOR OCTOBER, NOVEMBER, AND DECEMBER, 1838.**

**PUBLISHED AT NEW HAVEN ON 12th JANUARY, 1839.**

---

**NEW HAVEN:**

Sold by A. H. MALTBY and B. & W. NOYES.—*Philadelphia*, CAREY & HART and J. S. LITTELL.—*Baltimore, Md.*, N. HICKMAN.—*New York*, G. & C. CARVILL & Co., No. 108 Broadway, and G. S. SILLIMAN, No. 44 William St.—*Boston*, C. C. LITTLE & Co.—*London*, JAMES S. HODSON, No. 112 Fleet St.—*Paris*, CHARLES DUPERRON, Rue Mabillon.

---

**PRINTED BY B. L. HAMLEN.**







**THE AMERICAN JOURNAL, &c.—AGENTS.**

SACO,	MAINE,	Rufus Nichols.	BUFFALO,	O. G. Steele & Co.
PORTLAND,		Colman, Holden, & Co.	PENNSYLVANIA.	
	VERMONT.		PITTSBURGH,	John J. Kay & Co.
BRATTLEBORO,	G. H. Peck.		MARYLAND.	
	NEW HAMPSHIRE.		BALTIMORE,	N. Hickman.
Dart. Coll. HANOVER,		{ Prof. Oliver P. Hubbard.	DISTRICT OF COLUMBIA.	
	MASSACHUSETTS.		WASHINGTON,	Frank Taylor.
NEWBURYPORT,	Charles Whipple.		NORTH CAROLINA.	
NANTUCKET,	Dr. Nelson Isham.		CHAPEL-HILL,	Prof. F. Mitchell.
SALEM,	Henry Whipple.		SOUTH CAROLINA.	
NEW BEDFORD,	William C. Taber.		COLUMBIA,	B. D. Plant.
SPRINGFIELD,	G. & C. Merriam.		CHARLESTON,	John P. Beile.
NORTHAMPTON,	S. Butler & Sons.		VIRGINIA.	
AMHERST,	J. S. & C. Adams.		RICHMOND,	R. T. Smith & Co.
WORCESTER,	{ Dorr, Howland, & Co.		WHEELING,	J. Fisher & Sons.
	{ Clarendon Harris.		NORFOLK,	Richard Worthington.
LOWELL,	D. Bixby.		ILLINOIS.	
	RHODE ISLAND.		PEORIA,	Sil's W. Robbins.
PROVIDENCE,	B. Cranston & Co.		OHIO.	
	CONNECTICUT.		CINCINNATI,	E. D. Bradford.
HARTFORD,	Canfield & Robins.		COLUMBUS,	I. N. Whiting.
NORWICH,	Thomas Robinson.		GEORGIA.	
MIDDLETOWN,	Luke C. Lyman.		SAVANNAH,	Wm. T. Williams.
	NEW YORK.		AUGUSTA,	Th. I. Wray.
NEW YORK,	A. T. Goodrich.		COLUMBUS,	J. C. Plant & Co.
WEST POINT,	John DeWitt.		TENNESSEE.	
NEWBURGH,	H. P. Benham.		NASHVILLE,	Wm. A. Eichbaum.
ALBANY,	W. C. Little.		MEMPHIS,	Fowlkes & Pugh.
TROY,	Elias Gates.		ALABAMA.	
IHACA,	D. D. Spencer.		HUNTSVILLE,	Irby & Smith.
CANANDAIGUA,	Morse & Harvey.		MOBILE,	Woodruff, Fiske & McGuire.
AUBURN,	L. Briggs.		MISSISSIPPI.	
LITTLE FALLS,	Edward M. Griffing.		GRAND GULF,	Wm. M. Smyth.
ROCHESTER,	Hoyt, Porter & Co.		CANADA.	
			QUEBEC,	Samuel Neilson.
			MONTREAL,	Amour & Ramsay.

**TERMS.**

Six dollars per annum; published in four Quarterly numbers, making two volumes a year, of from eight to nine hundred pages for both volumes, which are fully illustrated by plates.

☐ Terms of credit to general agents, six months from the publication of No. 1, of each volume.

*The Editor will draw on the agents, semi-annually, i. e. on the publication of No. 2 of each Vol., payable, April 1, and October 1, in all cases, where payment is not otherwise provided for.*

Complete sets, now 35 vols., are furnished at a suitable discount.

The expense of this Journal being greater, and the patronage less than that of the literary journals, the price is necessarily one dollar more per annum.

**TO CORRESPONDENTS.**

This work is most safely and expeditiously transmitted to distant subscribers by mail. This No. contains 13 sheets; postage, under 100 miles, 20 cents, over 100 miles, 32½ cents.

The titles of communications and of their authors, to be fully given.

When extra copies are desired, the notice should be placed at the head of the MS.

Notice always to be sent of discontinuance, removals and deaths of subscribers.

Return proofs, not to be sealed, or inscribed with any thing except corrections.

Several communications for the present No., are necessarily deferred.

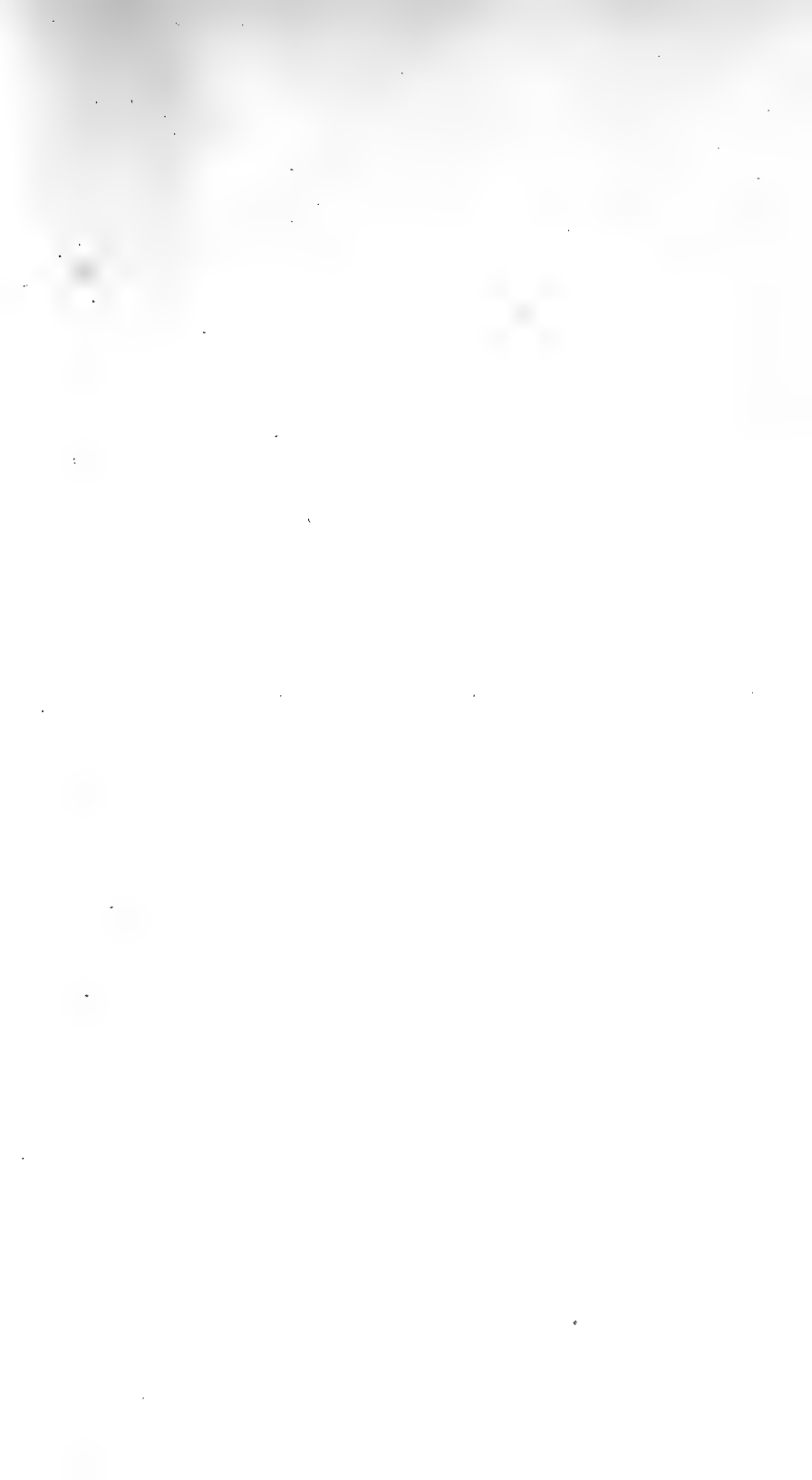



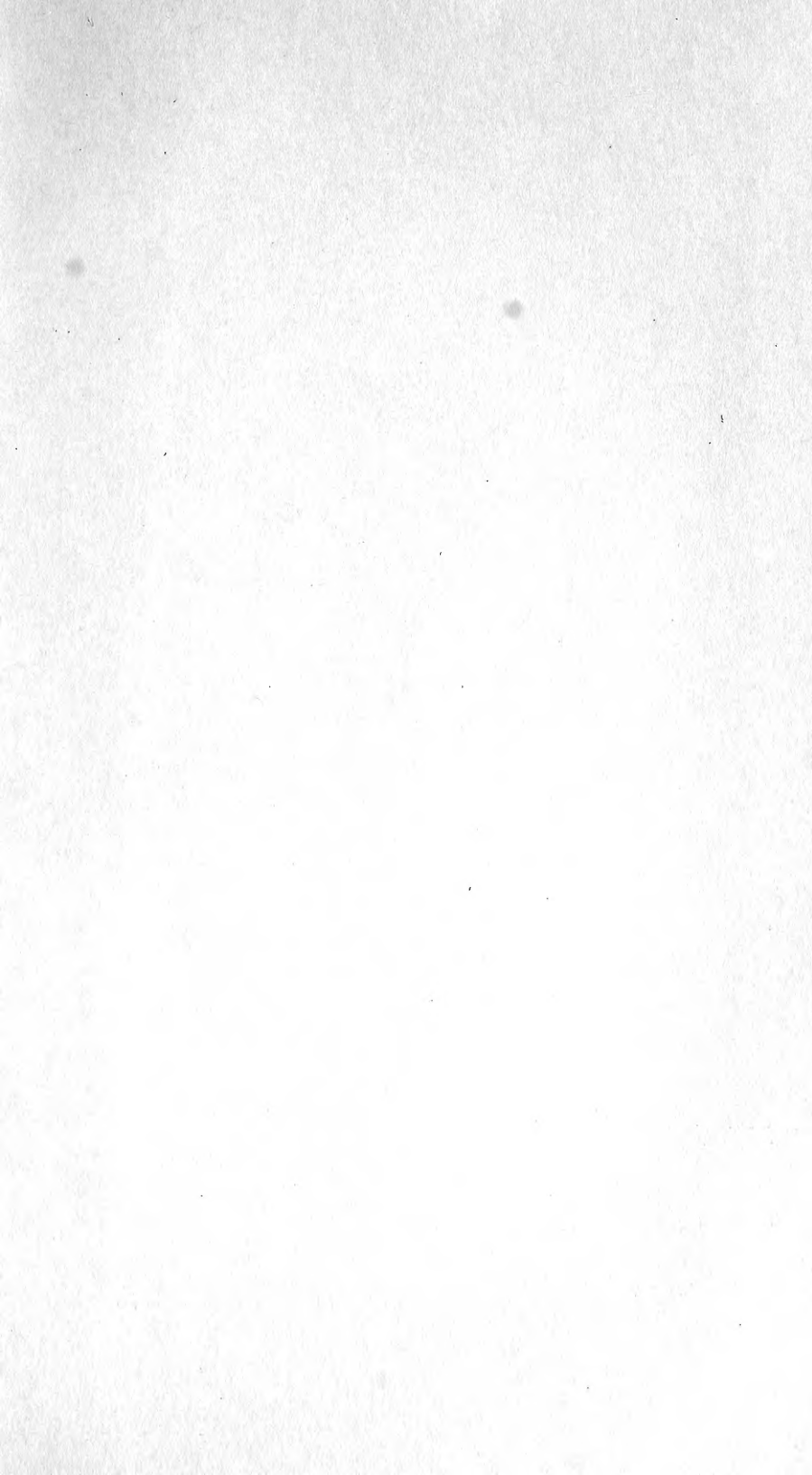



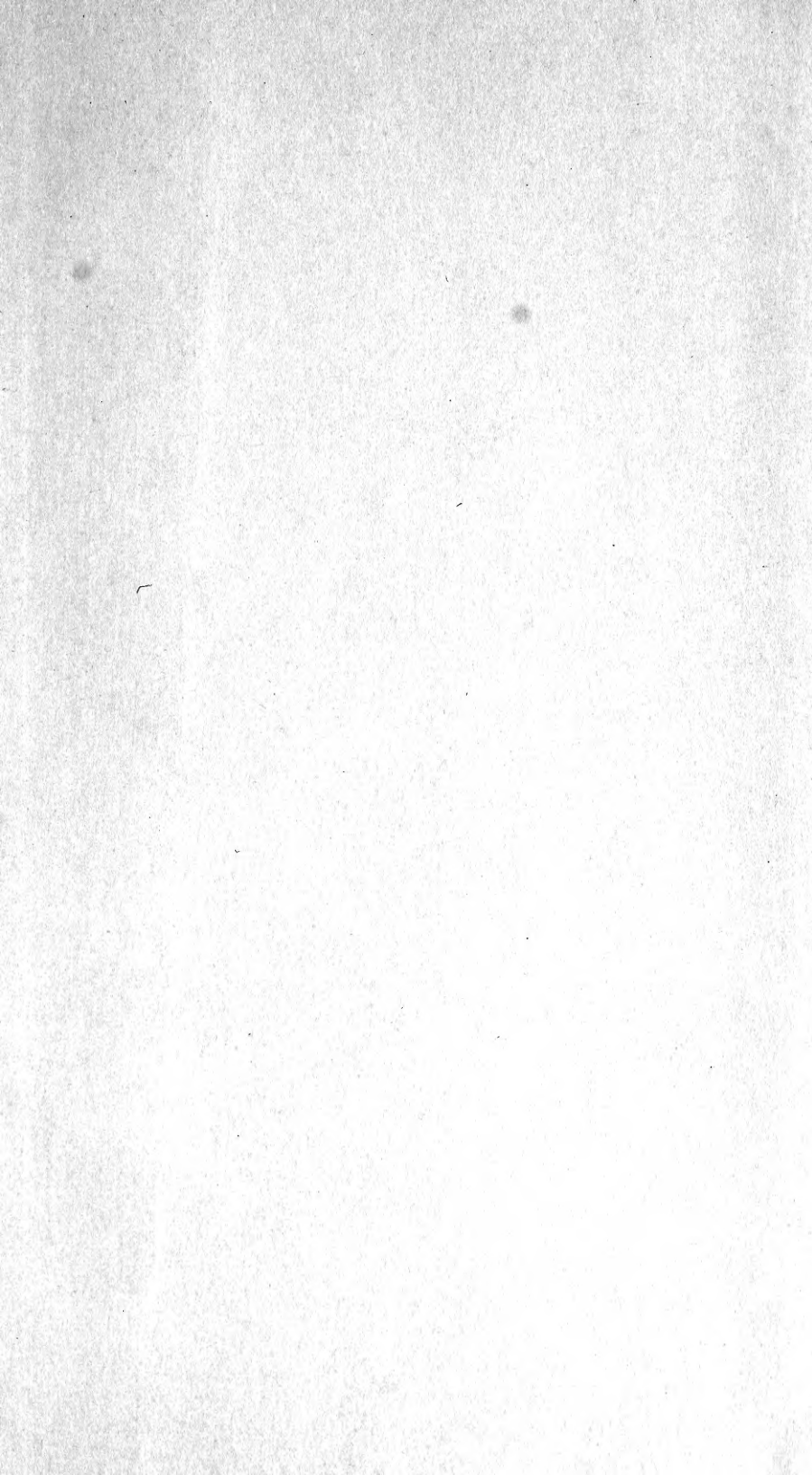

SMITHSONIAN INSTITUTION LIBRARIES



3 9088 01298 4357