







*Stalk*

THE  
**AMERICAN JOURNAL**  
OF  
**SCIENCE AND ARTS.**

CONDUCTED BY

**BENJAMIN SILLIMAN, M. D. LL. D.**

Prof. Chem., Min., &c. in Yale Coll.; Cor. Mem. Soc. Arts, Man. and Com., Cor. Mem. Met. Soc., and For. Mem. Geol. Soc., Hon. Mem. Br. and For. Abor. Protec. Soc., and of Scien. Soc., London; Mem. Geol. Soc., and Hon. Mem. Lin. and Statis. Socs., Paris; Mem. Roy. Min. Soc., Dresden; Nat. Hist. Soc., Halle; Hon. Mem. Agric. Soc., Bavaria; Imp. Agric. Soc., Moscow; Nat. Hist. Soc., Belfast, Ire.; Phil. and Lit. Soc., Bristol, Eng.; Hon. Mem. Roy. Sussex Inst., Brighton, Eng.; Cor. Mem. of the Nat. Hist. Soc., and of the Archæological Soc., Athens, Greece; Lit. and Hist. Soc., Quebec; Mem. of various Lit. and Scien. Soc. in the U. States.

AIDED BY

**BENJAMIN SILLIMAN, JR., A. B.**

Assistant in the department of Chemistry, Mineralogy and Geology in Yale College; Cor. Mem. of the Meteorological Soc., London; Sec. of the Yale Nat. Hist. Soc.; Mem. of the Conn. Acad. of Arts and Sci.; Cor. Mem. of the Lyceum of Natural History, New York; of the Boston Society of Natural History, &c.

*1859*  
VOL. XXXVIII.—~~APRIL~~, 1840.

NEW HAVEN:

Sold by A. H. MALBY and B. & W. NOYES.—*Philadelphia*, CAREY & HART and J. S. LITTELL.—*Baltimore, Md.*, N. HICKMAN.—*New York*, CARVILL & Co., No. 108 Broadway, and G. S. SILLIMAN, No. 44 William St.—*Boston*, C. C. LITTLE & Co.—*London*, JAMES S. HODSON, No. 112 Fleet St., and WILEY & PUTNAM, 35 Paternoster Row.—*Paris*, J. B. BAILLIÈRE, Libraire, Rue de L'Ecole-de-Médecine, No. 13 bis.—*Hamburgh*, Messrs. NESTLER & MELLE.

PRINTED BY B. L. HAMLIN.



202



## CONTENTS OF VOLUME XXXVIII.

### NUMBER I.

	Page.
ART. I. A letter to Prof. Faraday, on certain Theoretical Opinions; by Prof. R. HARE, M. D., - - -	1
II. Analysis of Sea Water as it exists in the English Channel near Brighton; by G. SCHWEITZER, M. D., -	12
III. On the Halo or Fringe which surrounds all Bodies; by Mrs. MARY GRIFFITH, - - -	22
IV. On the use of the Galvanic Battery in Blasting; by HAMILTON K. G. MORGAN, - - -	33
V. On the Tails of Comets; by WILLIAM MITCHELL, -	35
VI. A Gissi or Kissi Vocabulary; by Prof. J. W. GIBBS,	41
VII. A Vai or Vey Vocabulary; by the Same, - - -	43
VIII. A Mendi Vocabulary; by the Same, - - -	44
IX. Vegetable Organography and Physiology, or the Formation and Vital Functions of Plants; by HORACE GREEN, M. D., - - -	49
X. Practical Remarks on Gems, especially on some of those found in the United States; by THOMAS TABER, -	61
XI. On the Connexion between the theory of the Earth and the Secular Variations of the Magnetic Needle; by Prof. JOHN H. LATHROP, - - -	68
XII. Notices of Tornadoes, &c.; by Prof. R. HARE, M. D.,	73
XIII. On the Silurian System, with a Table of the Strata and Characteristic Fossils; by T. A. CONRAD, - - -	86
XIV. Abstract of the Proceedings of the Ninth Meeting of the British Association for the Advancement of Science,	93
XV. Account of a Journey to the Côteau des Prairies, with a description of the Red Pipe Stone quarry and Granite Boulders found there; by Mr. GEORGE CATLIN, -	138
XVI. Auroras and Sunset, - - -	146

171107

## MISCELLANIES.—DOMESTIC AND FOREIGN.

	Page.
1. Proceedings of the American Philosophical Society,	- 153
2. Proceedings of the Boston Society of Natural History,	- 193
3. Reports on the Shells and Minerals presented by Dr. Brinck- erhoff to the New York Lyceum of Natural History,	- 198
4. Further account of the Shooting Stars of Aug. 9 and 10, 1839,	203
5, 6. British Antarctic Expedition—Compound Electro-Magnet,	204
7, 8. Exchanges of American Shells and Insects—The Railway Magazine and Steam Navigation Journal,	- 205
9, 10. To remove Carbonic Acid Gas from Wells, &c.—The Katakekaumene, - - - - -	- 206

## NUMBER II.

ART. I. Contributions to Electricity and Magnetism. On Elec- tro-Dynamic Induction; by Prof. JOSEPH HENRY,	209
II. Analysis of a Chromic Iron Ore, first observed by R. C. Taylor, Esq., at Mahobal, near Gibara, Island of Cuba; by JAMES C. BOOTH and M. CAREY LEA,	- 243
III. Remarks upon some of the probable effects of a Re- sisting Medium; by Prof. THOMAS H. PERRY,	246
IV. Description and Analysis of a Meteoric mass, found in Tennessee, composed of Metallic Iron, Graphite, Hy- droxide of Iron and Pyrites; by Prof. G. TROOST, M. D.,	250
V. Notice of Tracks of Animals in Variegated Sandstone at Pölzig, between Ronneburg and Weissenfels; by Hr. Dr. B. COTTA, - - - - -	255
VI. Observations on the Aurora Borealis of Sept. 3, 1839; communicated by EDWARD C. HERRICK, - - -	260
VII. Abstracts of Meteorological Observations made at St. Johns, Newfoundland, and at Canton, in China: with some Notice of the Half Yearly Inequalities of At- mospheric Distribution, which appear in these Obser- vations; by W. C. REDFIELD, - - - - -	265
VIII. Abstract of a Meteorological Journal for the year 1839, kept at Marietta, Ohio, Lat. 39° 25' N., and Lon. 4° 28' W. of Washington City; by S. P. HILDRETH, M. D.,	273
IX. Description of a New Compensating Pendulum; by WILLIAM GWYNN JONES, - - - - -	274

	Page.
X. Some account of <b>ITHIEL TOWN'S</b> improvement in the construction and practical execution of Bridges, for Roads, Railroads, and Aqueducts, - - - - -	276
XI. Description of an Economical Apparatus for Solidifying Carbonic Acid, recently constructed at the Wesleyan University, Middletown, Conn.; by Prof. <b>JOHN JOHNSTON</b> , - - - - -	297
XII. Observations made at Canton, China, on the Shooting Stars of the 10th and 11th of August, 1839, in a letter from Rev. <b>PETER PARKER</b> , M. D. of Canton, to <b>E. C. HERRICK</b> , - - - - -	301
XIII. Remarks chiefly on the Synonymy of several North American Plants of the Orchis Tribe; by <b>ASA GRAY</b> , M. D., - - - - -	306
XIV. Account of the Capture and Death of a large Alligator,	313
XV. Synopsis of a Meteorological Journal, kept in the city of New York for the years 1838 and 1839, including also the mean results of the last seven years; by <b>W. C. REDFIELD</b> , - - - - -	323
XVI. Notice of a Manual of Chemistry; by Prof. <b>JOHN W. WEBSTER</b> , M. D., - - - - -	329
XVII. Engraving and Description of an Apparatus for the Decomposition and Recomposition of Water, employed in the Laboratory of the Medical Department of the University of Penn.; by Prof. <b>R. HARE</b> , M. D.,	336
XVIII. Improved Process for obtaining Potassium; by Prof. <b>ROBERT HARE</b> , M. D., - - - - -	338
XIX. Engraving and Description of a Rotary Multiplier, or one in which one or more Needles are made to revolve by a Galvanic Current; by Prof. <b>R. HARE</b> , M. D., - - -	339
XX. <i>Crania Americana</i> ; or a comparative view of the Skulls of various Aboriginal Nations of North and South America; to which is prefixed an Essay on the Varieties of the Human Species, illustrated by seventy eight plates and a colored map; by Prof. <b>SAMUEL GEORGE MORTON</b> , M. D., - - - - -	341

## MISCELLANIES.—DOMESTIC AND FOREIGN.

1. Aurora Borealis of September 3, 1839, - - - - -	376
2. Meteoric Observations in November and December, 1839,	377

	Page.
3, 4, 5. New Edition of Eaton's Manual of Botany—Experimental Researches in Electricity—A New Comet, . . . .	378
6, 7. Reports on the Fishes, Reptiles, and Birds of Massachusetts—Telescopes, . . . . .	379
8, 9. Interesting Minerals—Observations Meteorologiques et Magnetiques faites dans l'etendue de l'Empire de Russie redigees et publiees aux frais du Gouvernement, . . . .	380
10. On the geognostic position of the Zeuglodon, or Basilosaurus of Harlan, . . . . .	381
11. Professor Johnson's Analyses of Anthracite and Iron Ore, . . . .	382
12, 13. Parasite of the eggs of the Elm-tree Moth—Great Earthquakes in Burmah, . . . . .	385
14. Progress of the U. S. Exploring Expedition, . . . . .	387
15. The Twilight Bow, . . . . .	389
16. Lectures on Phrenology, . . . . .	390
17. Proceedings of the Boston Society of Natural History, . . . .	391
18. Proceedings of the American Philosophical Society, . . . .	396
19. Ehrenberg on Infusoria, . . . . .	404

## ERRATA.

P. 38, l. 30, for *connection*, read *correction*. P. 39, l. 35, for *these*, read *those*. P. 50, l. 17, for *extracting*, read *extorting*. P. 52, l. 27, for *found*, read *formed*. P. 92, 93, where *Gnathodon* occurs, the specific name should be in the masculine gender; as *Gnathodon flexuosus*, for *Gnathodon flexuosa*. P. 198, l. 19, for *crystals of crenic acid*, read *crystals supposed to be crenates*. P. 205, l. 38, for *C. S. Ward*, read *C. J. Ward*.

---

## NOTICE TO SUBSCRIBERS AND AGENTS.

The Editors will pay one dollar in cash for each Number of the American Journal of Science, named below. If preferred, they will credit them to the account of any subscriber at the rate at which recent numbers are charged; or they will give in exchange such other numbers as may be desired, and of which they have a supply. If any No. is sent by mail, the word RETURNED must be put on the envelope. The Nos. wanted are of

Vol.	V.	XI.	XIII.	XIV.	XVI.	XVII.	XXII.	XXVII.
Number	2.	1.	1, 2.	1, 2.	1, 2.	1, 2.	1, 2.	1, 2.
Entire No.	12.	24.	27, 28.	29, 30.	33, 34.	35, 36.	45, 46.	55, 56.

Our agents and friends are requested to make search for the above and forward them promptly to us.

New Haven, Oct. 1, 1839.

☞ Several complete sets, both bound and in Nos., are still on hand for sale.



THE  
AMERICAN  
JOURNAL OF SCIENCE, &c.

---

ART. I.—*A letter to Prof. Faraday, on certain Theoretical Opinions*; by R. HARE, M D., Professor of Chemistry in the University of Pennsylvania.\*

*Dear Sir*,—I have been indebted to your kindness for several pamphlets comprising your researches in electricity, which I have perused with the greatest degree of interest.

You must be too well aware of the height at which you stand, in the estimation of men of science, to doubt that I entertain with diffidence, any opinion in opposition to yours. I may say of you as in a former instance of Berzelius, that you occupy an elevation inaccessible to unjustifiable criticism. Under these circumstances, I hope that I may, from you, experience the candor and kindness which were displayed by the great Swedish chemist in his reply to my strictures on his nomenclature.

I am unable to reconcile the language which you hold in paragraph 1615, with the fundamental position taken in 1155. Agreeably to the latter, you believe ordinary induction to be the action of *contiguous* particles, consisting of a species of polarity, instead

---

\* *To the Editors of the American Journal of Science and Arts*,—GENTLEMEN: I avail myself of the medium of your Journal to address to the celebrated Faraday, a letter on the subject of certain hypothetical inferences which he has made from his late ingenious experimental researches.

R. H.

of being an action of either particles or masses at "*sensible distances*." Agreeably to the former, you conceive that "assuming that a perfect vacuum was to intervene in the course of the line of inductive action, it does not follow from this theory that the line of particles on opposite sides of such a vacuum would not act upon each other." Again, supposing "it possible for a positively electrified particle to be in the centre of a vacuum an inch in diameter, nothing in my present view forbids that the particle should act at a distance of half an inch on all the particles forming the disk of the inner superficies of the bounding sphere."

Laying these quotations before you for reconsideration, I beg leave to inquire how a positively excited particle, situated as above described, can react "inductrically" with any particles in the superficies of the surrounding sphere, if this species of reaction require that the particles between which it takes place be contiguous. Moreover if induction be not "an action either of particles or masses at *sensible distances*," how can a particle situated as above described, "*act at the distance of half an inch on all the particles forming the disk of the inner superficies of the bounding sphere?*" What is a sensible distance, if half an inch is not?

How can the force thus exercised obey the "well known law of the squares of the distances," if as you state (1375) the rarefaction of the air does not alter the intensity of the inductive action? In proportion as the air is rarefied, do not its particles become more remote?

Can the ponderable particles of a gas be deemed contiguous in the true sense of this word, under any circumstances? And it may be well here to observe, that admitting induction to arise from an affection of intervening ponderable atoms, it is difficult to conceive that the intensity of this affection will be inversely as their number as alleged by you. No such law holds good in the communication of heat. The air in contact with a surface at a constant elevation of temperature, such for instance as might be supported by boiling water, would not become hotter by being rarefied, and consequently could not become more efficacious in the conduction of heat from the heated surface to a colder one in its vicinity.

As soon as I commenced the perusal of your researches on this subject, it occurred to me that the passage of electricity through a vacuum, or a highly rarefied medium, as demonstrated by vari-



ous experiments, and especially those of Davy, was inconsistent with the idea that ponderable matter could be a necessary agent in the process of electrical induction. I therefore inferred that your efforts would be primarily directed to a re-examination of that question.

If induction, in acting through a vacuum, be propagated in right lines, may not the curvilinear direction which it pursues, when passing through "dielectrics," be ascribed to the modifying influence which they exert?

If, as you concede, electrified particles on opposite sides of a vacuum can act upon each other, wherefore is the received theory of the mode in which the excited surface of a Leyden jar induces in the opposite surface, a contrary state, objectionable?

As the theory which you have proposed, gives great importance to the idea of polarity, I regret that you have not defined the meaning which you attach to this word. As you designate that to which you refer, as a "species of polarity," it is presumable that you have conceived of several kinds with which ponderable atoms may be endowed. I find it difficult to conceive of any kind which may be capable of as many degrees of intensity as the known phenomena of electricity require; especially according to your opinion that the only difference between the fluid evolved by galvanic apparatus and that evolved by friction, is due to opposite extremes in quantity and intensity; the intensity of electrical excitement producible by the one, being almost infinitely greater than that which can be produced by the other. What state of the poles can constitute quantity—what other state intensity, the same matter being capable of either electricity, as is well known to be the fact? Would it not be well to consider how, consistently with any conceivable polarization, and without the assistance of some imponderable matter, any great difference of intensity in inductive power, can be created?

When by friction the surface is polarized so that particles are brought into a state of constraint from which they endeavor to return to their natural state, if nothing be superadded to them, it must be supposed that they have poles capable of existing in two different positions. In one of these positions, dissimilar poles coinciding, are neutralized; while in the other position, they are more remote, and consequently capable of acting upon other matter.

But I am unable to imagine any change which can admit of gradations of intensity, *increasing* with remoteness. I cannot figure to myself any reaction which increase of distance would not lessen. Much less can I conceive that such extremes of intensity can be thus created, as those of which you consider the existence as demonstrated. It may be suggested that the change of polarity produced in particles by electrical inductions, may arise from the forced approximation of reciprocally repellent poles, so that the intensity of the inductive force, and of their effort to return to their previous situation, may be susceptible of the gradation which your electrical doctrines require. But could the existence of such a repellent force be consistent with the mutual cohesion which appears almost universally to be a property of ponderable particles? I am aware that, agreeably to the ingenious hypothesis of Mossotti, repulsion is an inherent property of the particles which we call ponderable; but then he assumes the existence of an imponderable fluid to account for cohesion; and for the necessity of such a fluid to account for induction it is my ultimate object to contend. I would suggest that it can hardly be expedient to ascribe the phenomena of electricity to the polarization of ponderable particles, unless it can be shown that if admitted, it would be competent to produce all the known varieties of electric excitement, whether as to its nature or energy.

If I comprehend your theory, the opposite electrical state induced on one side of a coated pane, when the other is directly electrified, arises from an affection of the intervening vitreous particles, by which a certain polar state caused on one side of the pane, induces an opposite state on the other side. Each vitreous particle having its poles severally in opposite states, they are arranged as magnetized iron filings in lines; so that alternately opposite poles are presented in such a manner that all of one kind are exposed at one surface, and all of the other kind at the other surface. Agreeably to this or any other imaginable view of the subject, I cannot avoid considering it inevitable that each particle must have at least two poles. It seems to me that the idea of polarity requires that there shall be in any body possessing it, two opposite poles. Hence you correctly allege that agreeably to your views it is impossible to charge a portion of matter with one electric force without the other. (See par. 1177.) But if all this be true, how can there be a "positively excited particle?"

(See par. 1616.) Must not every particle be excited negatively, if it be excited positively? Must it not have a negative, as well as a positive pole?

I cannot agree with you in the idea that consistently with the theory which ascribes the phenomena of electricity to one fluid, there can ever be an isolated existence either of the positive or negative state. Agreeably to this theory, any excited space, whether minus or plus, must have an adjoining space relatively in a different state. Between the phenomena of positive and negative excitement there will be no other distinction than that arising from the direction in which the fluid will endeavor to move. If the excited space be positive, it must strive to flow outward; if negative, it will strive to flow inward. When sufficiently intense, the direction will be shown by the greater length of the spark, when passing from a small ball to a large one. It is always longer when the small ball is positive, and the large one negative, than when their positions are reversed.\*

But for any current it is no less necessary that the pressure should be on one side comparatively minus, than that on the other side, it should be comparatively plus; and this state of the forces must exist whether the current originates from a hiatus before, or from pressure behind. One current cannot differ essentially from another, however they may be produced.

In paragraph 1330, I have been struck with the following query, "What then is to separate the principle of these extremes, perfect conduction and perfect insulation, from each other; since the moment we leave the smallest degree of perfection at either extremity, we involve the element of perfection at the opposite ends?" Might not this query be made with as much reason in the case of motion and rest, between the extremes of which there is an infinity of gradations? If we are not to confound motion with rest, because in proportion as the former is retarded, it differs less from the latter; wherefore should we confound insulation with conduction, because in proportion as the one is less efficient, it becomes less remote from the other?

In any case of the intermixture of opposite qualities, may it not be said in the language which you employ "the moment we

---

\* See my Essay on the causes of the diversity in the length of the sparks, erroneously distinguished as positive and negative, in vol. v, American Philosophical Transactions.

leave the element of perfection at one extremity, we involve the element of perfection at the opposite." Might it not be said of light and darkness, or of opaqueness and translucency; in which case to resort to your language again, it might be added "especially as we have not in nature, a case of perfection at one extremity or the other." But if there be not in nature, any two bodies of which one possesses the property of perfectly resisting the passage of electricity, while the other is endowed with the faculty of permitting its passage without any resistance; does this affect the propriety of considering the qualities of *insulation* and conduction in the abstract, as perfectly distinct, and inferring that so far as matter may be endowed with the one property, it must be wanting in the other?

Have you ever known electricity to pass through a pane of sound glass? My knowledge and experience create an impression that a coated pane is never discharged through the glass unless it be cracked or perforated. That the property by which glass resists the passage of electricity, can be confounded with that which enables a metallic wire to permit of its transfer, agreeably to Wheatstone's experiments, with a velocity greater than that of the solar rays, is to my mind inconceivable.

You infer that the residual charge of a battery arises from the partial penetration of the glass by the opposite excitements. But if glass be penetrable by electricity, why does it not pass through it without a fracture or perforation?

According to your doctrine, induction consists "in a forced state of polarization in contiguous rows of the particles of the glass" (1300); and since this is propagated from one side to the other, it must of course exist equally at all depths. Yet the partial penetration suggested by you, supposes a collateral affection of the same kind, extending only to a limited depth. Is this consistent? Is it not more reasonable to suppose that the air in the vicinity of the coating gradually relinquishes to it a portion of free electricity, conveyed into it by what you call "*convection.*" The coating being equally in contact with the air and glass, it appears to me more easy to conceive that the air might be penetrated by the excitement, than the glass.

In paragraph 1300, I observe the following statement: "*When a Leyden Jar is charged, the particles of the glass are forced into this polarized and constrained condition by the electricity of*

*the charging apparatus. Discharge is the return of the particles to their natural state, from their state of tension, whenever the two electric forces are allowed to be disposed of in some other direction.*" As you have not previously mentioned any particular direction in which the forces are exercised during the prevalence of this constrained condition, I am at a loss as to what meaning I am to attach to the words "some other direction." The word *some*, would lead to the idea that there was an uncertainty respecting the direction in which the forces might be disposed of; whereas it appears to me that the only direction in which they can operate, must be the opposite of that by which they have been induced.

The electrified particles can only "return to their natural state" by retracing the path by which they departed from it. I would suggest that for the words "*to be disposed of in some other direction,*" it would be better to substitute the following, "*to compensate each other by an adequate communication.*"

Agreeably to the explanation of the phenomenon of coated electrics afforded in the paragraph above quoted (1300), by what process can it be conceived that the opposite polarization of the surfaces can be neutralized by conduction through a metallic wire? If I understand your hypothesis correctly, the process by which the polarization of one of the vitreous surfaces in a pane produces an opposite polarization in the other, is precisely the same as that by which the electricity applied to one end of the wire extends itself to the other end.

I cannot conceive how two processes severally producing results so diametrically opposite as insulation and conduction, can be the same. By the former, a derangement of the electric equilibrium may be permanently sustained, while by the other, all derangement is counteracted with a rapidity almost infinite. But if the opposite charges are dependent upon a polarity induced in contiguous atoms of the glass, which endures so long as no communication ensues between the surfaces; by what conceivable process can a perfect conductor cause a discharge to take place, with a velocity at least as great as that of the solar light? Is it conceivable that all the lines of "contra-induction" or depolarization can concentrate themselves upon the wire from each surface so as to produce therein an intensity of polarization proportioned to the concentration; and that the opposite forces

resulting from the polarization are thus reciprocally compensated? I must confess, such a concentration of such forces or states, is to me difficult to reconcile with the conception that it is at all to be ascribed to the action of rows of *contiguous ponderable particles*:

Does not your hypothesis require that the metallic particles, at opposite ends of the wire, shall in the first instance be subjected to the same polarization as the excited particles of the glass; and that the opposite polarizations, transmitted to some intervening point, should thus be mutually destroyed, the one by the other? But if discharge involves a return to the same state in vitreous particles, the same must be true in those of the metallic wire. Wherefore then are these dissipated, when the discharge is sufficiently powerful? Their dissipation must take place either while they are in the state of being polarized, or in that of returning to their natural state. But if it happen when in the first mentioned state, the conductor must be destroyed before the opposite polarization upon the surfaces can be neutralized by its intervention. But if not dissipated in the act of being polarized, is it reasonable to suppose that the metallic particles can be sundered by returning to their *natural state* of depolarization?

Supposing that ordinary electrical induction could be satisfactorily ascribed to the reaction of ponderable particles, it cannot, it seems to me, be pretended that magnetic and electro-magnetic induction is referable to this species of reaction. It will be admitted that the Faradian currents do not for their production require intervening ponderable atoms.

From a note subjoined to page 37 of your pamphlet, it appears that "on the question of the existence of one or more imponderable fluids as the cause of electrical phenomena, it has not been your intention to decide." I should be much gratified if any of the strictures in which I have been so bold as to indulge, should contribute to influence your ultimate decision.

It appears to me that there has been an undue disposition to burden the matter, usually regarded as such, with more duties than it can perform. Although it is only with the properties of matter that we have a direct acquaintance, and the existence of matter rests upon a theoretic inference that since we perceive properties, there must be material particles to which those properties belong; yet there is no conviction which the mass of man-

kind entertain with more firmness than that of the existence of matter in that ponderable form, in which it is instinctively recognized by people of common sense. Not perceiving that this conviction can only be supported as a theoretic deduction from our perception of the properties; there is a reluctance to admit the existence of other matter, which has not in its favor the same instinctive conception, although theoretically similar reasoning would apply. But if one kind of matter be admitted to exist because we perceive properties, the existence of which cannot be otherwise explained, are we not warranted, if we notice more properties than can reasonably be assigned to one kind of matter, to assume the existence of another kind of matter?

Independently of the considerations which have heretofore led some philosophers to suppose that we are surrounded by an ocean of electric matter, which by its redundancy or deficiency is capable of producing the phenomena of mechanical electricity, it has appeared to me inconceivable that the phenomena of galvanism and electro-magnetism, latterly brought into view, can be satisfactorily explained without supposing the agency of an intervening imponderable medium by whose subserviency the inductive influence of currents or magnets is propagated. If in that wonderful reciprocal reaction between masses and particles, to which I have alluded, the polarization of condensed or accumulated portions of intervening imponderable matter, can be brought in as a link to connect the otherwise imperfect chain of causes; it would appear to me a most important instrument in lifting the curtain which at present hides from our intellectual vision, this highly important mechanism of nature.

Having devised so many ingenious experiments tending to show that the received ideas of electrical induction are inadequate to explain the phenomena without supposing a modifying influence in intervening ponderable matter, should there prove to be cases in which the results cannot be satisfactorily explained by ascribing them to ponderable particles, I hope that you may be induced to review the whole ground, in order to determine whether the part to be assigned to contiguous ponderable particles, be not secondary to that performed by the imponderable principles by which they are surrounded.

But if galvanic phenomena be due to ponderable matter, evidently that matter must be in a state of combination. To

what other cause than an intense affinity between it and the metallic particles with which it is associated, can its confinement be ascribed consistently with your estimate of the enormous quantity which exists in metals? If "a grain of water, or a grain of zinc, contain as much of the electric fluid as would supply eight hundred thousand charges of a battery containing a coated surface of fifteen hundred square inches," how intense must be the attraction by which this matter is confined? In such cases may not the material cause of electricity be considered as latent agreeably to the suggestion of *Ørsted*, the founder of electro-magnetism. It is in combination with matter, and only capable of producing the appropriate effects of voltaic currents when in act of transfer from combination with one atom to another; this transfer being at once an effect and a cause of chemical decomposition, as you have demonstrated.

If polarization in any form, can be conceived to admit of the requisite gradations of intensity, which the phenomena seem to demand; would it not be more reasonable to suppose that it operates by means of an imponderable fluid existing throughout all space, however devoid of other matter? May not an electric current, so called, be a progressive polarization of rows of the electric particles, the polarity being produced at one end and destroyed at the other incessantly, as I understood you to suggest in the case of contiguous ponderable atoms.

When the electric particles within different wires are polarized in the same tangential direction, the opposite poles being in proximity, there will be attraction. When the currents of polarization move oppositely, similar poles coinciding, there will be repulsion. The phenomena require that the magnetized or polarized particles should be arranged as tangents to the circumference, not as radii to the axis. Moreover, the progressive movement must be propagated in spiral lines in order to account for rotary influence.

Between a wire which is the mean of a galvanic discharge and another not making a part of a circuit, the electric matter which intervenes may, by undergoing a polarization, become the medium of producing a progressive polarization in the second wire moving in a direction opposite to that in the inducing wire; or in other words an electrical current of the species called Faradian may be generated.



By progressive polarization in a wire, may not stationary polarization, or magnetism be created ; and reciprocally by magnetic polarity may not progressive polarization be excited ?

Might not the difficulty, above suggested, of the incompetency of any imaginable polarization to produce all the varieties of electrical excitement which facts require for explanation, be surmounted by supposing intensity to result from an accumulation of free electric polarized particles, and quantity from a still greater accumulation of such particles, polarized in a latent state or in chemical combination ?

There are it would seem many indications in favor of the idea that electric excitement may be due to a forced polarity, but in endeavoring to define the state thus designated, or to explain by means of it the diversities of electrical charges, currents and effects, I have always felt the incompetency of any hypothesis which I could imagine. How are we to explain the insensibility of a gold leaf electroscope, to a galvanized wire, or the indifference of a magnetic needle to the most intensely electrified surfaces ?

Possibly the Franklinian hypothesis may be combined with that above suggested, so that an electrical current may be constituted of an imponderable fluid in a state of polarization, the two electricities being the consequence of the position of the poles, or their presentation. Positive electricity may be the result of an accumulation of electric particles, presenting poles of one kind ; negative, from a like accumulation of the same matter with a presentation of the opposite poles, inducing of course an opposite polarity. The condensation of the electric matter, within ponderable matter, may vary in obedience to a property analogous to that which determines the capacity for heat, and the different influence of dialectrics upon the process of electrical induction may arise from this source of variation.

With the highest esteem, I am yours truly,

ROBERT HARE.

ART. II.—*Analysis of Sea Water as it exists in the English Channel near Brighton ; by G. SCHWEITZER, M. D.\**

BEING unaware of the existence of a correct analysis of sea-water as it exists in the British Channel, particularly with reference to the quantity of iodine and bromine it contains, I have undertaken at the request of several friends to analyze it. It is not my intention to enter into the minutiae of the process employed, particularly as I have on a former occasion, in a small pamphlet entitled "An Analysis of the Congress Spring of Saratoga in America," published in March, 1838, given a detailed account of the mode I adopt in analyzing mineral waters. The chief object I have in view in the present communication is, to explain the method I have employed in ascertaining the proportion of iodine and bromine contained in a given quantity of sea-water. But before I enter upon the subject, it may not be out of place to show how far tests act upon iodine when in connexion with an alkali, and in a solution also containing bromides and chlorides.

From experiment I have ascertained that a minute quantity of iodine in distilled water, equal to no more than 1,500,000th part of the whole, will be distinctly indicated when mixed with starch, dilute sulphuric acid, and chlorine.

For the production of such delicate reaction, I add to every 500 grains of fluid one drop of diluted sulphuric acid, a small quantity of paste of potato starch, and two drops of a weak solution of chlorine, consisting of one part of a saturated solution diluted with 20 to 25 times its volume of distilled water. The solution gives no indication of the presence of iodine in the fluid until a sufficient time has been allowed for the separation of the starch, when a decided pink hue will be visible on the surface of the precipitate if iodine be present. It has been supposed that the substitution of pink for blue in the iodide of starch produced, arises from the presence of bromine; but this I have ascertained is not correct, as it depends entirely on the minute quantity of the precipitate acted upon by free chlorine or bromine. The following experiment will prove this fact. In order to ascertain the

---

\* From the Lond. and Ed. Phil. Mag. for July, 1839; communicated by the Author.

delicacy of electrolytic tests of iodine, a current of electricity produced by voltaic induction was passed through a suitable glass tube, filled with 300 grains of distilled water containing  $\frac{1}{5000000}$ th part of its weight of iodide of potassium and a small quantity of starch, but no action was observed until a few drops of nitric acid were added, which assisting the electric current, developed, after a few brisk revolutions of the coils of the magnet, the blue color of the iodide of starch. Even a current of electricity from a single constant galvanic battery passed through the same glass tube, in which the proportion of iodide of potassium was only one millionth part of the weight of the water, indicated the presence of iodine by a pure blue speck of iodide of starch at the anode or negative extremity of the electric circuit. When iodide of potassium diluted in the same manner was properly treated with starch, sulphuric acid, and chlorine, the blue iodide of starch likewise became visible, but the smallest additional proportion of chlorine occasioned a pinkish sediment. The presence of chlorides and bromides, however, does not interfere with the action of the electric current upon traces of iodine; for a solution of salts containing, in 500 grains of water, 100 grains of chloride of sodium, 10 grains of bromide of sodium, and the five hundred thousandth part of iodide of potassium, gave a deposit of iodide of starch of a dark pinkish color. A concentrated solution of bromide of sodium, containing the millionth part of iodide of potassium, also gave by the action of the electric current a slightly pinkish deposit.

It is always necessary, when we wish to detect by means of chlorine minute quantities of an iodide, to employ the chlorine in a very diluted state, as when in excess it forms a soluble chloride of iodine which will not act on starch.

The sulphates and chlorides present in salt waters do not interfere with the delicacy of the starch test; on the contrary a concentrated solution of the chlorides will show the presence of one millionth part of iodide of potassium more distinctly than an equal volume of distilled water. This appears to arise from the iodide being a little soluble in pure water. I thought at first that a trace of an iodide might be contained in the common chloride of sodium, and thus cause a deeper tinge of blue color; but by employing a chloride of sodium prepared from pure hydrochloric acid and pure soda, I found the same degree of increased reaction.

The iodide of starch will likewise keep unchanged much longer in a solution of chlorides exposed to light and air than in pure water.

The bromides when present in large quantity interfere with the delicate reaction upon traces of iodine, but when the quantity of iodine is not too small the reaction is very distinct, as a small proportion of free bromine will, like chlorine, decompose the iodide, and produce the characteristic reaction.

After these experiments I tested fresh sea-water for iodine in the manner before described, but did not obtain the slightest indication of it. I now added one millionth part of the iodide of potassium, and the color produced by the test did not differ in the slightest degree from a solution of chlorides of the same specific gravity as sea-water, treated in the same manner, and from this I immediately inferred, that iodine, if present in sea-water, must be so in very minute quantity.

I took 73 pounds troy of sea-water, and boiled with a quantity of caustic potash, sufficient to precipitate the alkaline earth, and after filtration evaporated the fluid to four ounces. On testing a small quantity of this concentrated water, no iodine was to be detected, and it was found on adding a minute quantity of an iodide that the presence of bromides in comparatively large quantity interfered with the test. But although these results appeared to negative the presence of iodine, I felt convinced it must exist in sea-water, being present in so many sea plants and animals.

Sarphate, in his "*Commentatio de Iodio*," 1835, *Leiden* (a treatise which received the prize), states that he could detect no iodine in the sea-water near the Dutch coast. Professor Charles Daubeny likewise mentions, in his "*Memoir on the occurrence of iodine and bromine in certain mineral waters of South Britain, May, 1838*," that he could not detect iodine in the residuum of sea-water taken from the English Channel near Cowes, after having reduced ten gallons to less than half an ounce.

To proceed with my experiment, I freed three ounces as much as possible from the chlorides by crystallization, having first carefully neutralized the solution with hydrochloric acid. The residuum was then evaporated to dryness, ignited, and treated with anhydrous alcohol. The alcoholic fluid was afterwards evaporated, and the dry residue dissolved in a few drams of water,

when the before-mentioned test readily indicated a slight trace of iodine.

With respect to the quantity of iodine in sea-water, it is evidently very minute, 174 pounds troy not containing one grain. This is remarkable when we consider the comparatively large quantity of iodine and bromine present in sea plants and animals, hence we must conclude that these principles are concentrated by vital action.

Bromine, when present in fluids, is easily detected by chlorine, which produces a yellow color. If present in very minute quantity the fluid must first be concentrated. But when iodine is present we cannot apply this test, as bromides and iodides are both decomposed by it; and we cannot separate them, even by means of ether, as iodine is soluble in that menstruum, and also possesses greater coloring properties than bromine. From these causes this test is useless when iodine is present, and is only certain when we are previously assured of the absence of that substance.

The following process for the separation of iodine, chlorine, and bromine in fluids containing these substances in very small quantities has given me satisfactory results, as I had anticipated by previous experiment. The fluid while boiling was mixed with a sufficient proportion of caustic potash; my object in this was to decompose the earthy salts, and at the same time prevent the iodine and bromine from being dissipated by heat. The filtered fluid was then evaporated to dryness and ignited, and the resulting mass, after having been dissolved, concentrated, and neutralized with hydrochloric acid, was carefully mixed, drop by drop, with an ammoniacal solution of chloride of silver prepared by mixing one part of a saturated solution of recently precipitated chloride of silver in ammonia with one of liquid ammonia (sp. grav. 0.935) and two parts of water. If to a concentrated solution of chloride of sodium containing one thirtieth part of a bromide, we add a few drops of this ammoniacal solution of chloride of silver, the solution will remain clear; but if the most minute particle of an iodide be present, it will be rendered turbid.

To the fluid under examination I added gradually, drop by drop, the solution of ammoniacal chloride of silver, leaving time between each successive addition for the precipitate of iodide of

silver to subside. It is well when bromides are present to keep the vessel closed during the process, otherwise it is of no importance. The iodide of silver collected upon a small filter was first washed with a little diluted ammonia, and afterwards with a few drops of diluted hydrochloric acid to dissolve any earthy substance which the precipitate might contain, and ultimately with pure water.

The filter with the precipitate was dried and ignited. This experiment, repeatedly performed, yielded the most satisfactory results. It requires time, but this is more than balanced by its accuracy. Thus, for instance, I obtained by the analysis of the Congress spring of Saratoga, from 100,000 grs. of the water, 0.12164 gr. of iodide of silver, representing in 1000 grs. of the mineral water, 0.00067 gr. of iodine.

The ammoniacal fluid, separated from the iodide of silver, was carefully evaporated to expel the ammonia, whereby a small precipitate was obtained, consisting of bromide of silver, which was added to that subsequently obtained. This precipitate was formed by the solution of the chloride of silver, more of which was added than was required for the separation of the iodine. That this minute precipitate consisted of bromide of silver, was proved by heating it in a test tube with concentrated sulphuric acid, whereby it became of a delicate yellow color; whereas chloride of silver would have remained white, and iodide of silver would have obtained a brown color by parting with its iodine.

A small portion of the fluid may now be examined for bromine, and, when present, the following process may be adopted, which is the same I employed for the separation of bromine in sea-water and brine-springs, where the quantity of chlorides is comparatively very large. The concentrated solution freed from the iodine was introduced into a glass ball, having at its lower end a glass tube, and at its upper an aperture closed by a glass stopper. A concentrated aqueous solution of chlorine was added as long as any sensible yellowness was caused by its addition. The fluid was then agitated with pure ether; and after this had collected on the surface, carrying with it the bromine and chlorine, the water was allowed to flow off through the tube below, and by careful manipulation the ether could then be freed from the water, which was again treated with ether, lest any bromine

should still remain in it. The ether was directly introduced into a glass bottle, containing a solution of caustic potash fully sufficient to discolor the ether, when after evaporation and ignition it was dissolved in water, and carefully neutralized with hydrochloric acid. The concentrated solution was mixed with a few drops of an ammoniacal solution of chloride of silver prepared thus: one part of a concentrated solution of chloride of silver in ammonia, mixed with one part of ammonia and one part of water. A few drops of this mixture produced no turbidness in a solution of chloride of sodium, but indicated a very minute quantity of bromine. When no further turbidness was produced by an additional drop of this ammoniacal solution of the chloride of silver, the fluid under treatment, which was kept in an open vessel, was heated in a sand-bath until the ammonia was almost evaporated. A few drops of the test were again added, until it no longer produced turbidness, when the glass vessel was again placed in a sand-bath, until the fluid, after having been heated, gave no further indication of bromine; it was then tested again with chlorine. When the proportion of the chlorides to the bromides is not too large, scarcely a faint yellowness will be produced; if, however, it is, the bromine must again be separated by chlorine and ether, and the before-mentioned process repeated, when the last traces of bromine will be separated as bromide of silver, which is to be treated like the iodide of silver before it is weighed. In this manner I have been able to detect the smallest proportion of an iodide and bromide when accompanied by a great quantity of chlorides, and have also been enabled to separate them and to ascertain their respective quantities. Should the quantity of iodine be much larger than that of bromine, it would be requisite to evaporate a little of the ammonia; and although the addition of the ammoniacal solution of chloride of silver, employed as a test for iodine, no longer produces turbidness, it is still necessary to add another drop of the precipitating fluid, in order to ensure the separation of every trace of iodine. This is the more important, as the iodide of silver is not entirely insoluble in ammonia; and although the quantity dissolved might be exceedingly minute, still this repetition is necessary in an accurate analysis. The same precaution must be observed in the separation of bromine, as bromide of silver is to some extent soluble in ammonia, for it is obvious, that by the addition of the

ammoniacal precipitant for every portion of bromide of sodium or potassium, an equivalent of bromide of silver and chloride of sodium or potassium will be formed, and the corresponding quantity of ammonia, which kept the chloride of silver in solution, will be free and act upon the bromide of silver; but by observing the before-mentioned precaution, every error of that kind will be avoided. Should a fluid contain iodides and bromides without chlorides, and not in too small a proportion, a very good method of ascertaining their respective quantities is to precipitate them at once with nitrate of silver, and to heat the dry precipitate in an atmosphere of bromine. I have found, when iodide of silver is melted in an atmosphere of bromine, it is entirely changed into a bromide; and from the difference of the weight between the mixture of iodide and bromide of silver, and that of the whole bromide of silver, the respective quantities of iodine and bromine may be ascertained. Thus the quantity of iodine (or bromine) stands in proportion to the difference of the weight, as the atomic weight of iodine (or bromine) is to the difference of their atomic weights. Hence it would only be required for the quantity of iodine to multiply the given difference of the weight by 2.627, and for that of bromine to multiply it by 1.627. Professor H. Rose, of Berlin, applies a similar method for the separation of iodine from chlorine.—(Poggendorff's Ann. 1834, No. 37, pp. 583, 584.)

I may appear to have dwelt long upon this subject, but the importance into which brine-springs have arisen on account of their powerful components, iodine and bromine, has induced me to examine the matter closely, as it may be of consequence to the medical profession to know the exact quantity of these valuable substances.

I have briefly to add, that the quantity of chlorine in sea-water was ascertained by means of nitrate of silver, deducting from it that proportion of bromine which had been found according to the foregoing method. The quantity of sulphuric acid was found by chloride of barium, the water having previously been mixed with a little nitric acid. Another portion of the water was mixed with chloride of barium without the addition of an acid, when the difference of the weight between this and the former precipitate gave the amount of carbonate of barytes, from which the proportionate quantity of carbonic acid gas was computed;



its quantity was likewise ascertained after the distribution of the acids amongst the bases, when the surplus of the lime or of one of the other bases must have been united to carbonic acid. The quantity obtained by analysis was a little less than the last, owing to the carbonate of barytes not being entirely insoluble in water during lixiviation. Lime was separated by oxalate of ammonia, the water having been previously mixed with a proper quantity of chloride of ammonium. After the separation of lime, magnesia was precipitated by the addition of ammonia and phosphate of ammonia.

The precipitate was washed with water containing 10 per cent. of ammonia, whereby the solution of the precipitate was prevented. After the sea-water had been freed from the earthy chlorides and sulphates by hydrate of barytes and carbonate of ammonia, it was evaporated to dryness, and the residue heated to redness, and weighed. The alkaline chlorides were dissolved in water mixed with perchloride of platinum, and evaporated to dryness. The residue digested with spirits of wine containing 60 per cent. alcohol, left potassio-chloride of platinum, which was dried, weighed, and computed as chloride of potassium. The surplus of the total amount of the alkaline chlorides will give the precise quantity of the chloride of sodium.

The equivalent numbers have been computed according to the tables which H. Rose has affixed to his *Handbuch der Analytischen Chemie, Zweiter Band*.

I subjoin by way of comparison an analysis of the Mediterranean by Laurens. (*Journal de Pharmacie, xxi, 93.*)

	Sea-water of the British Channel.		Of the Mediterranean.
	Grains.		Grains.
Water, - - - - -	964·74372	- - -	959·26
Chloride of sodium, - -	27·05948	- - -	27·22
——— of potassium, -	0·76552	- - -	0·01
——— of magnesium, -	3·66658	- - -	6·14
Bromide of magnesium, -	0·02929		———
Sulphate of magnesia, -	2·29578	- - -	7·02
——— of lime, - - -	1·40662	- - -	0·15
Carbonate of lime, - -	0·03301	{ Carb. of lime } { and magnesia, }	0·20
	<hr/>		<hr/>
	1000·00000		1000·00

When these analyses are compared, it will be found that the Channel water contains 9 times as much lime as the Mediterranean, but this can be accounted for, as the water flows over a bed of chalk. The Mediterranean again has twice as much magnesia and sulphuric acid.

We also find that the English Channel contains in 1000 grains water, 35·25628 grains of anhydrous ingredients; which amount corresponds very nearly to 35 grains, or 35·1 grains, obtained from several experiments, when 1000 grains were evaporated in a platina crucible, mixed with a little chloride of ammonium, to prevent as much as possible the decomposition of the earthly chlorides, and the residue carefully ignited, in order to volatilize the chloride of ammonium, where, however, a dissipation of hydrochloric acid had taken place.

Sometimes I found faint traces of oxide of iron, when the concentrated water was mixed with sulphocyanuret of potassium, particularly after boisterous weather; I found the same in respect to organic matter. The sea-water taken on a fair and calm day, when very transparent, did not yield the slightest indication of extractive matter when evaporated and ignited. A small quantity of free carbonic acid gas has been likewise found; and also extremely minute traces of chloride of ammonium were detected, when about 5 pounds of sea-water were evaporated in a water-bath to nearly half an ounce, which, mixed with caustic soda, produced fumes close to a glass rod wetted with hydrochloric acid.

Sea-water has been likewise examined for silica, alumina, strontia, manganese, phosphoric acid, and nitric acid, none of which could be detected.

The sea-water used for the occasion was taken on the 3d of June, from the surface, six miles from the shore, at high water. The weather was fair, the sea calm and extremely transparent. Its specific weight was at 60° Fahr. 1·0274. Another portion obtained by a proper apparatus from the very bottom of the sea, 10 fathoms deep, was of the same specific gravity, and likewise that taken almost close to the shore. In the month of July, after a previous rainy day, the sea-water taken four miles from the shore, had at 60° Fahr. a specific gravity of 1·0274; at a distance of 2 miles, 1·0271; and close to the shore, 1·0268. It was examined several times in August, the weather being fair and warm, when

the specific gravity amounted to 1.0274. This appeared to be the greatest weight.

When weighed in fair weather in December, it was almost 1.0271; after rain I found it to be 1.0267. These variations will of course depend entirely on the state of the weather. If the atmosphere be bright, and no heavy rain has lately fallen, the water will have, even close to the shore, the same specific weight as out at sea, but after rain it is obvious that the sea-water close to the shore will be most diluted. It is therefore indispensable that the sea-water for examination should be taken at a distance of several miles, that its specific weight should be ascertained, and that the analysis should be performed from one and the same dip.

I cannot conclude this paper without drawing the attention of medical men to the importance which the brine-springs on the Continent have lately acquired, as, for instance, the springs near Kissingen, the Adelheids-quelle, near Heilbroun, and above all, the springs of Kreugnach, which have been found highly beneficial in scrofulous diseases when internally administered, their action being dependent entirely on the chlorides, iodides, and bromides they contain. Sea-water would afford similar advantages for bathing, and when evaporated to dryness, the residue might be kept in earthen vessels, and thus be conveyed to any distance; and as its constituents are very soluble, sea-water in perfection might be procured at any place. The evaporation of sea-water should be performed with care, and the ingredients kept by chemists. One great advantage would accrue from this method, viz., that sea-water could be had of any degree of concentration which the practitioner might deem necessary. At the baths of Kreugnach, for example, extraordinary effects have been produced when from 40 to 70 quarts of the mother liquor were added to the natural salt-water of that spring, and this mixture used for bathing.

German Spa, Brighton, June, 1839.

ART. III.—*On the Halo or Fringe which surrounds all Bodies ;*  
by Mrs. MARY GRIFFITH, of New York. (Communicated for  
this Journal.)

1. It is well known, that around and adhering to all surfaces there is a *halo* of demi-transparent light, seen only, however, when the object for experiment is in a certain position with regard to the eye and the light which falls on it. This halo is not dependent on any peculiarity of color or material, for it encompasses every object in nature, whether it belong to the animal, vegetable, or mineral kingdom ; whether it be square or round, black or white, opaque or transparent, solid or fluid.

2. If a small or large glass globe, either solid or filled with a fluid, be held near the eye, this halo will be seen on the circumference, and will always follow the curvature of the glass whichever way it may be turned.

3. Within this halo, at irregular intervals, are certain faintly marked lines, some of which are of a dark gray and others of a whiter shade than the main color of the halo itself. These lines are always of the same density and color, but not always at the same distance apart.

4. Whatever is the size, shape, color or opacity of the object, provided it be close to the eye, and that the other eye is shut, the diameter is always the same. But while looking at it, if the closed eye opens suddenly, the diameter will contract, its illumination will be brighter, and it will expand again as soon as the disengaged eye closes. Epinus discovered the same peculiarity in the diameter of a pin-hole.

5. This halo, therefore, is attached to all surfaces, and from its uniformity and constant presence it may be fairly inferred, that it belongs to the constitution of surfaces. It is not dependent either on the refraction or inflection of light, (which is supposed to proceed from the surface on which it rests,) but light is refracted through and across this halo, and also by transparent media when it passes through them. When the halo rests on an opaque substance, whether the surface be polished or not, all the rays of light which are to convey impressions of this opacity radiate from the halo alone. It is *sui generis*, and is independent of the quality or property of the body to which it adheres, and although it is only

the agent through which light is effective, yet it possesses a property which light has not, for it covers the surfaces of black colored bodies, whereas light is decomposed by them. It differs likewise from the magnetic and electric fluid, for with the same property of adhesiveness which they possess, it is *visible* and is not confined to a peculiar set of objects.

6. Light renders this halo perceptible, according to the same laws which allows us to perceive all other external objects; and we are not to infer that when it is not visible it does not exist.

7. This gauzy, misty nebula, when it encompasses lenses or small apertures, has hitherto been designated by the name of fringes. The phenomena of the interference of light and of the polarization of light, arise from the peculiar properties which this halo possesses.

8. Apparently it is only perceptible on the *edge* of those bodies which are close to the eye in experiment, but in reality it surrounds and covers every part of the surface. If a card be held edgewise, close to the eye, the halo, with its lines, will be found to occupy the whole extent of plane surface. It is as diaphanous, and as permeable to light when it extends over the whole surface, as it is on a round or sharp edge.

9. The lines within this halo are not the result of any refractive or inflective process of light between the eyelashes or among the humors of the eye. That the eyelashes do not in any way contribute to their formation can be satisfactorily proved, for on looking at the halo on the edge of a *bright* object, if we draw aside, with our finger, the upper or lower lid, the shadow of the eyelashes will be seen to move regularly across the *lines* without producing the least disturbance or alteration in their position. That they do not proceed from the difference in the refractive powers of the humor can also be proved, for they are seen when the halo is represented through a lens and is thrown on a screen. But there is still another proof that the different densities of the humors do not produce them. If we hold a steel needle or any bright object horizontally and close the eyelids so as only to admit a small cone of light, and then suddenly open them, we shall still perceive the lines within the halo, although the fluid which lubricates the conjunctiva, by the contraction of the lids, has accumulated in a ridge. We shall see the lines likewise very distinctly, although the aqueous humor is very perceptible and in

constant motion. That the conjunctival fluid is pushed together so as to form a ridge, can be proved by looking at the clear sky, or a candle, through a small pin-hole in a card. On closing the lids slowly and then suddenly opening them, this ridge will be seen on the enlarged diameter of the pin-hole.

10. I have stated in section 4th, that the halo is always of the same density and diameter at a certain point of view, and that on opening the closed eye it will suddenly contract, and that the light diverging from it, will be much brighter. This contraction and expansion is not confined to those halos which adhere to edges, or to a plane surface, for all narrow slits, all small circular holes, contract and expand under similar circumstances. -

11. Light falls on the halo precisely as it does on a bright brass ball. It is well known that if we breathe on the ball and pass the hand over it *horizontally*, the light from a self-luminous body will fall on it vertically. If the hand is passed over it vertically, the light will fall horizontally. This phenomenon does not arise from the presence of moisture, for the same thing occurs whether we breathe on the ball or not, although then not so perceptible. There are always inequalities even on the smoothest surface on which light would glance, but the peculiar feature of a beam of light is more clearly defined when the hand is passed over a moist surface; the ridges are then formed more distinctly.

12. The cause of the formation of the ridges must be very obvious; the hand in passing across the ball, cannot come in contact with every part of the surface; a number of elevations or ridges therefore will arise parallel to the motion of the hand, and it is across these ridges, at *right angles*, that light falls.

13. But on account of the sphericity of the ball, the beam of light will be of very narrow diameter, as it can only glance over a very circumscribed area, which area, however, is the prominent point of the ball.

14. The halo accompanies every one of the ridges following these elevations and depressions. It is always parallel to every plane or curved surface and edge, and the lines intersect each other at every angular point and around every curve or sphere without interfering.

15. If it be a *plane* surface on which we breathe, and the hand is passed over it *vertically*, the light will glance across the *whole mass* of ridges in a horizontal direction. A contrary ac-

tion will cause the beam of light to strike the mass of ridges vertically.

16. Therefore, if the object have a plane surface, the vertical lines within the halo will occupy the whole extent of vertical surface: I speak now of a square of glass, or any other object with a plane surface and standing in an erect position; the horizontal lines will occupy the whole of the horizontal surface and thus cross each other at right angles at every corner.

17. Consequently, if the *plane* surface of any object lies horizontally and the rays of light fall on it vertically, both the horizontal and vertical lines will be illuminated and the center of the plane will be the focus of illumination, the diameter of which will be greater than if the surface were spherical. But though the space of luminous contact will be of larger diameter than if the rays fell on a curve or sphere, yet the concentration will be less dense, and of course less powerful.

18. On a globular surface the action of the halo is the same, only that, from the sphericity of the globe, the lines can never cross at right angles.

19. Taking into consideration all the peculiarities and anomalies which these halos exhibit, it must lead to the conclusion, that rays of light which issue from a polished opaque or transparent surface, are not immediately reflected from that surface, *but from the halo itself*. It was the opinion of many excellent philosophers that light was not reflected from the surface of a body, but that it "acted at a distance," there being several phenomena incident to light which could not be accounted for on any other hypothesis. They never detected the agency of this nebula or halo, nor will the men of science at the present day be the first to investigate the proofs of the existence of so powerful an agent.

20. I observed that the lines of the halo intersect each other; the interstices between their intersections are foci whence reflected rays issue. Rays of light diverge from these interstitial foci in all directions, so that let us stand in what position we may, with regard to the object on which the halo rests, a pencil of rays always converges to the axis of our own eye.

21. This halo, therefore, is the medium through which light acts, both near and at a distance.

22. Besides being the true reflecting medium, it has the property of acting on another halo in a specific manner, either when near or at a distance.

23. It acts upon the surface of another halo—more perceptible when they are near together—in consequence of a singular and wonderful property which it possesses. *It is lenticular in the direction of its parallelism with the edge of the body on which it rests!* If we turn a piece of glass, steel, or pasteboard, edgewise, we shall find that the lines of the halo are parallel to this edge, as edge it may be called, for it presents no more extent of surface than if it were an edge of only a line in diameter. If we turn the edge so as to let it lie horizontally, still the line will be parallel to the edge, and the interstices will preserve their lenticular property—the halo, therefore, on every edge is always lenticular in the direction of its lines:

24. If we hold a card in each hand, one near the eye and the other at a little distance from it, and then move them in a horizontal direction, so near as to shut out the light between them, the halo on the one card will appear to swell out to meet the other.

25. On a superficial view of this phenomenon we might be led to adopt the explanation given of it by Mr. Melville. In the *Encyclopedia Perthensis* of 1816, page 412, fig. 9, plate 257, he has given his theory, with a diagram. When we become convinced of the fact, that the interstices between the lines of every halo are constituted like lenses—being lenticular according to the parallelism of the lines with the *edge* or surface of the body on which it rests—we shall no longer be at a loss for the true theory of the swelling out of the edges of bodies to meet one another.

26. What I mean by lenticularity according to the parallelism of the halo with the edges of bodies, is this:—If the shadow of an object near the eye, is thrown on an object a few inches distant from it, and we move either of them to the right or left, the shadow of the one nearest to the eye will rest on the other and move in a direction contrary to the one we give it.

27. Therefore, if a pin is held near the eye, and another is at a little distance from it, the shadow of the former will be plainly seen on the halo of the latter, moving contrarily to the motion we give them. Here it will be observed that the *lines* in both halos, and of course the pins themselves, are parallel, and in consequence of this parallelism the shadow, though it has *one* lenticular movement—which is a reverse movement—is seen in an *erect* position. But I must observe here that this applies only to the body, or shaft of the pin, as the *head*, for reasons hereafter to be explained, does not cast its shadow on the oblong lens of a halo.



28. This elongated lens does not, like a round one, give an inverted image of the pin; *it only reverses the movements*. If a slit is cut in a card with a sharp knife, and we look through it at a candle or at the clear sky, it will be perceived that the halo is present there also, and that its lines are parallel with the slit. On moving a pin between the eye and the slit, the shadow of the pin will be seen on it, but its movement will be the reverse of the true one. In this experiment, as in the preceding one, the shadow of the body of the pin is erect, and there is no representation of the head.

29. This contrary motion of object and shadow—this lenticularity—does not belong exclusively to the overlapping of halos and to narrow slits, for I have ascertained beyond a doubt, that this nebula or halo, which exists on the edges of *all* bodies, possesses this singular power likewise. Even on the edges of our fingers, and *between* the fingers, as may be ascertained by holding up our hand before a candle, and moving a pin between the eye and the finger, the halo there seen is an elongated lens, possessing *one* lenticular movement.

30. But there is a great difference between the halos attached to the edges and surfaces of bodies, and those belonging to small *circular* apertures. The circularity, by making the rays of light from all the foci of the interstices of the halo converge to one focus, and thence radiate, reverses both the image and the movements. This circular opening—a pin-hole for instance—is then a true lens, with anterior and posterior convex surfaces, the convexity of which gives the halo its lenticular or magnifying power.

31. In whatever manner the *lines* of this lenticular halo are produced—whether owing to refraction, reflexion, or whether it be *multiplication of outline*—the fact is certain that they *do* exist, and that the halo in which they are seen is a true lens. Turn a glass globe which way we will, this halo is always parallel to the edge of the surface, and yet the globe has no *edge*, nor in fact, is there an edge to any round body, such as a pin or a pencil, sharp as it appears when close to the eye.

32. The halo is of a certain depth, and always retains its diameter and character, for the *lines* are forever parallel and the interstices lenticular. Although we are *certain* from every variety of careful experiment, that the lines cross each other in every direction, yet after the manner of rays of light, only those lines are vis-

ible that follow the *edge or surface* of the body on which the halo rests. Such is the nature of this extraordinary power, that no confusion arises from this crossing of the *lines*, for as I have frequently observed, only those are seen which are parallel to the edge whether the object on which they rest is in a vertical or horizontal position.

33. It is not the external surface alone on which the halo rests; all the inner and outer circumferences of flat bodies, and of all round or irregularly shaped apertures, are edged and lined by this diaphanous, lenticular halo. There is no opening so small, nor any so large, that is not edged with it; but its peculiar character as a perfect lens, is to be found only when the aperture is of a certain diameter. Its own diameter being limited, it becomes necessary that the aperture shall be of such a size as to allow the halo to fill it up completely, which it could not do if the aperture were too large.

34. The rays that proceed from this halo, when it lines an aperture, converge to a focus nearer or farther from this aperture according to its size, and according to its distance from the eye. It is from this focus that an image of the sun—as it is called—is seen, which image is either thrown on the floor from the hole in the window shutter of a dark room, or on the ground under trees. The same spot of bright light is projected on the wall from the slats of a window blind, at sun-rise, or sun-set—that is, if the slats are near together, or if there be a crack in one of them. When the points of contact of these slats or cracks, are close to one another, the interstices between the points become lenses, and from these focal points the small dense circles of light are seen. In cutting a slit in a card, if we press the knife on it *unequally*—making a feebler incision every half inch—on looking through the slit we shall perceive that it is composed of circular halos, instead of a long line of misty light, as is always the case when the pressure of the knife is equal, and the slit is of the same diameter throughout.

35. It has frequently been asked, why the circular spots of light under trees have that perfect regularity of outline, when the opening between the leaves are generally angular. I have already said that they are not the representatives of the *apertures*, but of the condensation of light at each focal point. It is the divergent rays from this focus that throw the shadows of lenses, such as are

seen under the trees, and such as appear on a screen or wall, in a dark room, when the light comes from a small hole in the shutter.

36. We often see under trees, openings of large size and irregular shape; on examination it will be found that they proceed from the spaces between leaves that do not hang in dense masses like those in the centre. These open, irregular spots have their inner circumference edged with a rim of smoky light, thus making manifest the influence, or rather presence of the halo, for this dull light is the representative of it. If we could trace the small dense, circular spots to their origin, at the top of the tree, we should find that they proceeded from openings as large and irregular as those which are reflected from the thinly scattered leaves nearer the outer circumference of the tree. Before the light from an irregular opening at the *top* can reach the ground, it will be intersected by portions of innumerable leaves which lie in its course, until, at last, the aperture through which it makes its final passage is so small in size as nearly to admit of a continuity of halo. Therefore, let the outline of an aperture be what it may; provided it be not of so large a diameter as to prevent the microscopic, or lenticular action of the halo; the rays of light will converge to a point, the *central* rays of which will throw on the ground or floor, a dense round mass of light, such as is called an image of the sun, and the divergent rays will throw an inverted image or shadow on the screen or wall. That some of the dense light spots are of an oblong form is owing to the obliquity of the sun's rays, or to the oblique position of the apertures with regard to the rays.

37. The halos of two objects of slender diameter will be of double density when they overlap one another. This experiment can be made by bringing them together with their edges perfectly parallel. The halos of three or four pins when placed behind one another, will be so dense, that objects beyond them will appear very indistinct, whereas through *one* halo every thing is accurately seen, through *two* dimly, through five or six, not at all.

38. Light, like all other matter, is less permeable as it becomes more dense. When it is concentrated, the feebler rays which emanate, or are reflected from objects behind it, are lost in the intensity of the mass through which they seem to pass in order to reach our eye. The concentrated density of light is the *true*

cause of our not seeing objects through it. The *continued* action of light destroys *certain combinations* which develop colors, and thus decomposes them; but light has no such annihilating power as Newton assigned to it. It is the *opacity of accumulation* which hides colored bodies from our sight; light has no power to decompose or annihilate *instantly*; on the contrary, there are certain qualities in the *black* principle which annihilates light itself.

39. There is an experiment of painting the different colors on the periphery of a wheel, and it has become a settled question in optics that these colors all blend into a white mass as soon as the wheel is in rapid motion. It is known that the duration of impression, on the organs of vision, are very limited; we cannot wonder therefore, that the feeble rays of light which are to give an impression of the colored patches on the wheel, should fail in doing so. As the rapidity of motion prevents the duration of impression of the feebler rays of colored objects, nothing remains perceptible to vision but the dense mass of light from the whole circumference of the wheel.

40. If on one side of a card—as in the beautiful experiments of Dr. Paris—we paint a head, and on the other side a body, by making the card turn rapidly, the head appears to be attached to the body. The feeble rays proceeding from that edge or line of the circumference which passes before the eye at every half revolution, are lost in the mass of light which is reflected from the colored and white portions of the card. But if the card be made to turn *very* rapidly, even the figures are hidden, because, as has been observed, the duration of impression is very limited.

41. A pin-hole at a little distance appears very small, but the aperture increases as the distance decreases. It is only when the pin-hole is close to the eye, that the true magnifying or lenticular power of the halo is recognized. It will be then perceived that it completely occupies the whole opening, and that objects which are held between the eye and the pin-hole, will all be inverted, not only inverted both as to position and movement, but also possessing a much larger outline than the objects themselves. This aperture, therefore, is a lens whose magnifying power is according to the size of the aperture and its distance from the eye.

42. On looking through the halo as it fills up the pin-hole, we shall perceive that objects beyond it are very distinctly seen, and

they appear in their true place, though not always of their true size, for this depends on the diameter of the pin-hole. There is however another very important circumstance which contributes to the erect position of external objects—the *axis of the pin-hole and our eye are strictly parallel, and all the rays which pass through the centre of this axis carry an erect impression of the object whence they emanate.*

43. I observed above that when the pin-hole is near the eye, its lenticular property is apparent. If we hold a pin between the eye and the pin-hole, the pin will be inverted. The reason of this is obvious, for according to the 23d section, the halo is lenticular in the direction of its parallelism with the edge or surface of the body on which it rests. If the pin-hole were oblong, or if the aperture were a long slit instead of a round hole, the shadow of any slender object before the eye would remain the same as to position, but be reversed as to movements. But the pin-hole being a perfect lens—for it is completely filled by the halo—any shadow cast on its surface will be reversed both in position and movement. The character of these halos never varies; they act upon one another in a sensible manner and always produce the same results.

44. Should a doubt remain as to the lenticularity of this halo on the pin-hole, we have only to observe the figure which appears on its surface. On looking steadily at the pin-hole we shall perceive that the rays of light from a candle, and which are brought to a focus on the lens of our own eye, give to the cerebral organs of vision an exact representation of all specks, flaws, spots, and movements of fluids which actually exist within the eyeball. I say cerebral organs, because a true knowledge of vision must convince us that the figure which *appears* to be in the pin-hole cannot by any possibility be painted or impressed *there*, and if not *there*, certainly not on any part of the interior of the eyeball. The very circumstance of being able to see any part of the interior of our own eye should settle the question of the *seat of vision*, and prove that the eyeball and its internal apparatus are merely for the purpose of transmitting *rays of light* and not images; that the images which are the result of these rays, are impressed on the cerebral organs with the *first* touch of light on the elastic machinery of the eye, and never come to a focus on the retina or on any other part of the interior of the eyeball. But I have pursued this branch of the subject elsewhere.

45. The lenticular character of the halo is indisputable, and every experiment will the more fully establish the fact. *It is a true reflecting and magnifying medium, and it is entirely owing to this circumstance that a convex lens of glass possesses its magnifying power. The mere substance or material of glass is only necessary or accessory to the production of lenticular phenomena in consequence of its capability of curvature and extension.*

46. Therefore, beyond a certain point a halo cannot maintain its continuity, unless it have a solid or fluid medium on which it can expand and keep its particles in contact. Nor can its ultimate magnifying power be developed unless the material in which it rests is *convex*, for being *convex itself* it requires a continued extension of convex surface if greater magnifying power is required. An aperture which is of twice the diameter of the halo will have an open space in the center free from it. This center, therefore, is no lens, but if we put a convex glass in the aperture, the halo then has a conducting medium, and can spread itself, or rather connect itself with the halo on the glass, and thus exhibit all the powers of a lens.

47. It is the continuity of the halo throughout all the space of a small circular aperture which gives the aperture, or the convex glass within it, the character of a lens. In consequence of this continuity, lenses can be built up of many pieces, and of course there is no limit to their diameter. *Convexity being the sole requisite for a magnifying power*, it is immaterial whether the lens be of solid glass, or whether the two convex surfaces be of the thinnest glass, cemented at the circumference and the hollow space filled with a fluid. If the lens be built up of many pieces, the blocks should all run parallel with the axis of the glass and the central block should be of one piece throughout its axis, so that there may be no interruption of the rays of light through it. It is of no consequence how narrow the diameter of the block may be, for the rays which are to give impressions of external objects converge to a minute point on the apex of this block and pass in a *straight* line to the apex of the axis of our own eye: the present theory among philosophers is that the rays cross each other in the *centre* of the lens, but this is an error which will soon be corrected.

ART. IV.—*On the use of the Galvanic Battery in Blasting*; by  
HAMILTON K. G. MORGAN.

To the Editors of the Philosophical Magazine and Journal. (Lond)

Johnstone Castle, Wexford, May 24, 1839.

*Gentlemen*—I BEG to trespass on your time by this letter on the use of the galvanic battery, instead of the fuze in blasting.

The papers have given short descriptions of the experiments made at Chatham, but all the details were not given. I commenced my experiments on blocks of the old trees that were blown down by the late storm. I first prepared an igniting cartridge by joining two pieces of *clean* copper wire to the extremities of a steel wire taken from the scratch brush, such as is made use of by gun-makers; this steel wire is fastened to the copper wires by waxed silk; the length of steel wire to be deflagrated is one-fourth of an inch; a piece of very slight wood is spliced to both copper wires to protect the steel wire from any accident—it makes the whole strong and more convenient to be introduced into the small cartridge, which is either a quill or a small paper tube. They are filled with fine powder, and made air and water-tight, to prevent the powder from getting damp and rusting the steel wire; a second small piece of wood is then fastened to this small cartridge and the copper wires; one of the wires is bent over this piece of wood and brought up at an angle with the other upright wire. This is my exploding cartridge: it cannot be easily put out of order. The wires of the cartridge have only to be made bright before they are fastened, by twisting them round the positive and negative wires of the battery. I always place the cartridge deep in the hole made to receive the powder, in order that the pressure from the turnpeg may be taken off by the quantity of powder above it.

The wire I made use of is the common copper-bell wire. The battery is the old Wedgwood trough, with 4-inch plates, double coppers. I prevent the zinc plates from touching the copper by small pegs of wood passed through the four corners. Wooden troughs with movable divisions were tried, but not with any good result. A wooden trough with the plates in a frame of wood, with varnished paper between the copper, was tried, but the porcelain trough far surpassed them. My first experiment

was blasting single blocks ; the effect was much better than when the fuze was used, in consequence of the clay being more firmly driven round the wires than it would be round the larger surface of the fuze. 2ndly, I selected two large blocks nearly in line ; the first block was 43 feet from the battery ; the second block 113 feet from the battery, and the blocks consequently were 70 feet from each other. On dipping the plates, the explosions took place in quick succession ; the battery consisted of 30 pairs of 4-inch plates. 3rdly, I wished to try the effect of a simultaneous explosion of two blasts on a very large block firmly tied together by rivets. The positive wires of each cartridge were fastened to the positive connecting wire, and in like manner the negative wire. The effects of this simultaneous explosion were very good ; the exciting liquor being weak, the connecting wires were shortened to 98 feet. 4th, To amuse some friends, I exploded some powder in one of the ponds, depth 10 feet ; length of wire 210 feet ; 40 pairs of plates, with old exciting liquor :—the experiment succeeded to the delight of all ; a large eel was killed by the blow-up. I have no doubt but wild fowl will yet be killed by means of shells placed at low water on the banks where they feed ; and by means of long connecting wires, the shells can be made to explode simultaneously among the birds.

I find that 10 pairs of 4-inch plates free from oxide and charged with the following exciting liquor—water,  $6\frac{1}{2}$  quarts ; sulphuric acid of commerce,  $4\frac{1}{2}$  ounces ; nitrous acid,  $4\frac{1}{4}$  ounces ; will ignite powder with a wire 101 feet long. 20 pairs of plates ignited powder at the distance of 353 feet. I tried to repeat this experiment, but did not succeed, though the plates were only three times immersed in the acid, and only for about two seconds each time. I tried the same battery at 268 feet, and did not succeed. The plates were then well washed, and fresh exciting liquor made : the experiment again failed ; the plates were quite inactive. The next day I tried the same plates and the same exciting liquor, and succeeded at 268 feet. From this it seems impossible to say how many pairs of plates would be required to produce uniform effects at long distances. I suspect that the zinc plates do not act equally in producing the electricity, which causes this variation.

I should have liked very much to have tried the conducting properties of different sized wires, but had not an opportunity of getting them here.



Not having seen any notice of this novel and safe method of blasting in your excellent journal, induced me to send you these few remarks.

I believe I am the first in Ireland that applied the galvanic battery instead of the fuze in blasting.

---

ART. V.—*On the Tails of Comets*; by WILLIAM MITCHELL, of Nantucket, Mass.

THERE is perhaps no department of astronomical science, connected with the solar system, of a nature more interesting than that of Comets, and certainly no one which has so nearly defied the researches and the reasonings of the astronomer. Aside from these bodies, if such they may be called, the greater and the lesser lights have been subjected to rigorous weight and measure, and the solar system is emphatically the beaten way of the astronomer. Comets however have presented difficulties so insuperable, that in latter times the subject seems to have been nearly abandoned in despair; and armed as the present age may be against the horrors of superstition, a cometary appearance as imposing as that of 1680, or even of the less threatening aspect of that of 1744, would create no small degree of uneasiness in some hearts of the stoutest mould. When Dr. Olbers announced that a portion of the earth's orbit would be involved in the nebulous atmosphere of Biela's comet in 1832; one half at least of the civilized world quaked with fear. Notwithstanding the alluring promise held out to the modern student by the glories of sidereal astronomy, nothing can justify a neglect of phenomena which, by a close investigation, might result in contributing so much to the tranquillity of the world. Impressed forcibly in my youth by the beautiful appearance of the comet of 1807, and, at a riper age, with those of 1811, 1819, 1825, and 1835, visible to the naked eye, and with others, seen at various periods by telescopic aid, I have been led frequently to reflect on the probable nature and physical properties of these erratic objects, and especially on that distinguishing appendage which by common consent is denominated the *tail*. In looking over the history of comets, and noting the explanation of the trains (with which they are for the

most part attended) as given by many distinguished astronomers, at periods very remote from each other, I am constrained to acknowledge, high as the authority unquestionably is, that no one has afforded to my mind the slightest satisfaction. Notwithstanding the great number of writers on this subject and the diversity of opinions that have been promulgated, there appears to have been only two prevailing theories. The more ancient of these supposed the tails to be formed by the lighter parts being thrown off by the resistance of the ether through which the comet passed. The modern and the more generally prevailing theory is, that these particles are driven off by the impulsive force of the sun's rays. In each of these theories, the tails are supposed to consist of *matter*. With regard to the former theory, the simple fact that the tail precedes the comet in its course through a portion of its elliptical journey, is a sufficient refutation; and to afford weight or plausibility to the latter, it is necessary to assume that the sun "blows heat and cold with the same breath"—in other words, that it attracts and repels with the same *modus operandi*. If we have no evidence of a repulsive force in the sun, to say nothing of a force sufficient to repel the lighter particles of these bodies to a distance from the head of the comet, equal to and sometimes exceeding a hundred millions of miles, this theory, to say the least of it, is labored and unsatisfactory. The length of these trains is far from being exaggerated. Referring to my minutes of the late return of Halley's comet, I find that, at one period, the tail, by direct vision, subtended an angle of twenty degrees, and on some occasions, by oblique vision, more than forty degrees. The tail of the comet of 1689 is said to exceed sixty eight degrees, and that of the comet of 1680, ninety degrees. Making a proper allowance for the faintness of the extremity of the tail, and the obstruction of the view by the atmosphere of the earth, it is by no means unsafe to conclude that many of them extend some hundreds of millions of miles from the nucleus of the comet.

In view then of the last mentioned theory, it is by no means a matter of surprise that Newton, and with him La Place and Sir J. Herschel, should entertain the opinion that the more remote particles could never be recalled by the gravitation of the nucleus, and that portions of the tails were at each revolution scattered in space, and hence that comets were continually wasting.

Arago, in speaking of the then anticipated return of Halley's comet in 1835, makes the following remark: "It appears probable that in describing their immense orbits, comets at each revolution, dissipate in space all the matter which when they are near the perihelion, is detached from the envelop forming the tail; it is therefore very possible that in time some of them may be entirely dissipated." But these views were not confirmed by the appearance of Halley's comet in 1835, and Arago has with a very becoming candor promptly acknowledged this fact. "If the reader," says he, "will take the trouble to compare what I record of the comet of 1835 with the circumstances of its former apparition, he certainly will not find in this collection of phenomena the proof that Halley's comet is gradually diminishing. I will even say that if, in a matter so delicate, observations made at very different periods of the year, will authorize any positive deduction, that which would most distinctly result from the two passages of 1759 and 1835, would be that the comet had increased in size during that interval. I ought to seize with more eagerness, this occasion to combat an error extensively accredited, (a belief in the constant wasting away of comets,) because I believe I have somewhat contributed to its dissemination."

The truth is, as I apprehend, that the data on which this conjecture was based, are probably false, and the tails of comets, if the subject is properly investigated, will not be found to consist of matter at all that has the least connection with the comet, but *formed by the sun's rays slightly refracted by the nucleus in traversing the envelop of the comet, and uniting in an infinite number of points beyond it, throwing a stronger than ordinary light on the ethereal medium, near to or more remote from the comet, as the ray from its relative position and direction is more or less refracted.*

It is not important to the truth of this hypothesis whether the nucleus be a solid mass or not, so that it be more dense than the surrounding nebulosity, nor yet that the tail be projected in an exact line with the radius vector of the sun and comet, so that it be nearly so. It is however important to its truth that an ethereal medium should exist, otherwise the reflection of these points of light would be impossible; also that the comet should *assume* the tail as it approaches the sun, and that it should progressively increase in length and brilliancy, the light of the sun increasing in

the proportion of the square of the diminution of distance,—again that the tail should have a cylindrical and hollow appearance, the rays of light being at least partially obstructed by the nucleus; moreover, that the tail should be curved, by the necessary effect of aberration. I apprehend it will be acknowledged that the weight of testimony is decidedly favorable to the fact that the nuclei of comets, though they generally resemble planets in form and brilliancy, may not be solid or opaque, inasmuch as some are unquestionably transparent, and the quantity of matter in all is exceedingly inconsiderable.

Professor Struve saw a star of the eleventh magnitude through the Encke comet; Sir William Herschel noticed one of the sixth magnitude through the centre of the comet of 1795; and his illustrious son, in a memoir communicated to the Royal Astronomical Society, mentions that he saw a cluster of stars of the sixteenth magnitude very near the centre of Biela's comet. Notwithstanding this tenuity, an increased density may always be noticed toward the centre of the head, except in a few small comets unaccompanied with trains.

Astronomers of all ages seem to have been inclined to a belief in an ethereal medium, and the present one has afforded a conclusive evidence of its existence, in its effect upon the duration of the revolution of the Encke comet. Professor Encke in a dissertation on this subject, after giving the minutiae of his observations, very modestly remarks—“If I may be permitted to express my opinion on a subject which for twelve years has incessantly occupied me, in treating which I have avoided no method, however circuitous, no kind of verification, in order to reach the truth so far as it lay in my power; I can not consider it otherwise than completely established, that an extraordinary connection is necessary for Pon's\* comet, and equally certain that the principal part of it consists in an increase of the mean motion proportionate to the time.” Professor Airy, in an appendix to a translation of Encke's memoir, adds—“I can not but express my belief that the principal point of the theory, namely, an effect exactly similar to that which a resisting medium would produce, is perfectly established by the reasoning of Professor Encke.” Arago, in speaking of the discrepancy between the result of calculation and

---

\* Called by others Encke's comet.

observation on the period of the Encke comet, states unhesitatingly that the cause "can be nothing but the resistance of the ether." And Dr. Bowditch, distinguished as he was for cautiousness, fully recognized the effect of an ethereal medium, in the translation of the *Mécanique Céleste*. The fact however that Halley's comet at its late return reached its perihelion *later* rather than *earlier* than the calculated time, independent of an allowance for a resisting medium, seems to have created some doubts in reference to the doctrine of resistance; but of the three comets whose periods are certainly known, those of Biela and Encke only can be relied on as indicating resistance, inasmuch as that of Halley has its aphelion in a region beyond the scan of human power, and the influence of planetary bodies which may exist there, is now and will perhaps forever remain unknown to us. These facts then, and the concurring opinions of the high authority above quoted, render it nearly unquestionable that there is diffused through the celestial regions an ethereal and exceedingly elastic medium; nor would it be unreasonable to suppose that this very medium constitutes the solar atmosphere, of which the zodiacal light may be a denser region.

When an opportunity is offered to observe a comet remote from the sun, it is generally found to be unaccompanied with a tail; but as it approaches, the tail begins to appear, and its length and brilliancy increase, till it reaches the perihelion of its orbit, and by an illusion, sometimes beyond this point. Although there is some degree of diversity in the form of the tails of different comets, yet they generally consist of two streams of light, not absolutely distinct from each other. In other words, the borders of the tail are brightest, plainly indicating a hollowness, the line of vision necessarily meeting with a greater number of luminous points on the edges than through the middle. Can any explanation of this hollowness be given, more simple and philosophical, than that the *rays of the sun's light* are more obstructed by the denser than the rarer portions of the comet?

That there is, in these tails, which acquire a considerable length, a slight curve, concave to that portion of the orbit which the comet has left, there is ample testimony. Now as light is progressive, a portion of time must elapse while the rays of light are passing from the head of the comet to their point of union, and during this period the comet moves onward in its course, and the result necessarily is a gentle or slight curve in the tail, the effect being

greater or less in proportion as the union of rays is more or less distant from the comet. It is manifest that if a ray of light could be traced during its entire course from the sun to a planet, it would present a similar phenomenon, equal in degree if the motion of the planet were swift as that of a comet. The comets of Biela and Encke have no tails, nor is there, strictly speaking, a nucleus in either. That of Encke, during the long period in 1828, when its position was so favorable to observation, had the appearance of a mere film of vapor, nearly circular but not well defined, and no central, stellar point could be detected with the telescopic power which I employed on that occasion. In fact, all the phenomena of the tails of comets appear to be so well explained by this theory that I can not doubt its truth, although nothing like demonstration accompanies it. There are indeed optical difficulties which I have been unable to overcome: no one however which may not be fairly attributed to our ignorance of the particular physical constitution of these bodies. It is no small confirmation of the truth of this explanation of the tails of comets, that there is not the slightest evidence, worthy of confidence, that the earth which we inhabit has ever been sensibly affected by a visitation from these enormous appendages, while the chance of collision between the earth and the *nucleus* of a comet, properly so called, is exceedingly small; yet when we reflect upon the number of comets belonging to our system, the hundreds that range within the earth's orbit, that their paths have every possible inclination to the ecliptic, that these immensely extended trains, projected in a direction *from* the sun, describe an inconceivable sweep when they are encompassing the sun in the region of their perihelion;— I say in view of these circumstances, it is difficult to avoid the conjecture, nay, it is exceedingly probable that these appendages, in very many instances, have brushed across the surface of our planet, harmlessly and unperceived.

I submit this theory (if indeed it is entitled to that name) to the consideration of the scientific, having no point to gain, no wish to gratify, but the promotion of science and the progress of truth, and if insuperable objections to it are raised, and my reasoning should prove fallacious, there will be at least one valuable result, that of showing what the tails of comets are not; moreover, it may be the humble means of exciting further inquiry on this interesting topic.

Nantucket, 10th mo., 1st, 1839.

## ART. VI.—A Gissi or Kissi Vocabulary; by Prof. J. W. GIBBS.

THE following list of Gis-si words and phrases is taken from the mouth of John Ferry, an African, who was born at Slan-go-lo, a town of Yom-bu, in the Gis-si country, and is now resident in New-York. He was brought from his native country about the year 1821 or 1822, at the age of 11 or 12, but has often conversed with Gis-si people since that period.

One	pe-le	King	su-lo
Two	mi-ûng	Slave	kel-ling
Three	nga	Name	di-u-lang
Four	hi-o-lu	People	won-da
Five	ngwai-nu	Village	son-da-kol-lo
Six	gnom-pum	Town	t:he
Seven	gnom-me-u	Country	ka-leng
Eight	gnom-ma	Good	ken-daw
Nine	gnom-ma-hi-ol	Bad	wawn-du
Ten	to	Big	o-ben-du
Twenty	bi-din	Little	pom-bo
Thirty	bil-li-a	Old	yu
Forty	bil-li-hi-ol	Young	pom-bo
One hundred	kem-me pe-le	Old	pan-du
Head	bul-leng	New	son-ne
Hair	yîn-de	White	hûm-bu
Ear	ni-leng	Black	ti-gni
Eye	hol-leng	Strong	ken-du
Nose	mi-lin-do	Sick	na
Mouth	sôn-do	I	ya
Lip	tshaw-tshawn	Thou	nom
Tooth	tshin-dong	He	ûn-du
Tongue	di-e-mo-leng	She	ûn-du
Hand	ba	We	na
Foot	beng-gu	Ye	in-da
Sun	pa-ra-leng	They	in-da
Moon	pan-gwi	My hand	ba-nu
Heaven	ha-la	My foot	beng-gu-nu
Fire	in-ding	Thy foot	beng-gu-nom-do
Water	men-dang	His foot	beng-gu-ndaw
God	{ ha-la ma-la-ka, i. e. { heaven king.	Our foot	beng-gu-na
Man	la-gna-gnaw	Your foot	beng-gu-in-da
Woman	{ won-na-lan-no { wain-đu	Their foot	beng-gu-in-da
Child	tu-a-le-bo	My father	fo-gua-nu
Father	fo-gna	Thy father	fo-gna-nom-do
Mother	{ ka-la { ndo-a	His father	fo-gna-ndaw
		My mother	ka-la-nu
		Thy mother	ka-la-nom-do
		His mother	ka-la-ndaw

Her mother	ka-la-ndaw	One man	la-gna-gnaw pe-le
Our mother	ka-la-na	Two men	lang-ba gnûng
Your mother	ka-la-in-da	Three men	lang-ba a
Their mother	ka-la-in-da	Four men	lang-ba hi-ol
I eat	ya i-di-e	Five men	lang-ba ngwai-nu
Thou eatest	nom a-di-e	A good man	la-gna-gnaw ken-daw
He eats	ûn-du a-di-e	A bad man	la-gna-gnaw wawn-du
We eat	na i-di-e	A white man	la-gna-gnaw hûm-bu
Ye eat	in-da a-di-e	A black man	la-gna-gnaw ti-gni
They eat	in-da a-di-e	God loves men	{ ha-la-ma-la-ka tshu- le lang-ba
A king	su-lo	Men love God	{ lang-ba tshu-le ha- la-ma-la-ka
Kings	su-la	Give to me	yon-ge-a
Close by the king	su-lo-li-ko		
A man	la-gna-gnaw		
Men	lang-ba		

The Kissi numerals, according to Dr. Prichard, are, 1. pi-li, 2. miu, 3. nga, 4. i-ôl, 5. ngue-nu, 6. ngom-pum, 7. ngom-mi-u, 8. ngom-mag, 9. ngue-nu-iol, 10. to.—*Researches into the Physical History of Mankind*. Lond. 1837. Vol. II. p. 99.

Dr. Prichard also says: "The Kissi are a people of whom we know nothing, except that they inhabit the mountainous country about the sources of the Niger, to the southward of Sulimana and Sangara."—*Researches*, Vol. II. p. 75.

I add from my informant.

The Gis-si country is bounded on the south by the Men-di country and on the west by Kon-no.

The Gis-si people constitute three kingdoms; one, the capital of which is close to Kon-no; the second, the capital of which is Kwin-de-hu; the third, the capital of which is Yen-gi-ma.

The principal towns in the Gis-si country are Te-i-du, Dwa-va, Slan-go-lo, Yen-gi-ma, Kwan-go, Dzhûm-ba-u, Bom-gba-du or Zon-gi-a-ma, Kom-man-du, Di-gwi-na, Ban-do-ning, Ton-gi, Sai-i-du, Du-gau-no, Kwin-de-hu, Kon-dzhu, Dzho-po-a-hu, Tshe-son-ne, i. e. new town, Dzham-ba-u, Ta-ku-lo, Su-a-du, Yaw-baw-du, Den-go-ben-gu, De-hu-ma, etc.

The principal rivers are (1.) Ma-ku-na, which flows by Slan-go-lo and Dzham-ba-u in the Gis-si country, by Kwan-go and Yen-gi-ma, now in Gis-si, formerly in the Men-di country, and thence into the Men-di country; (2.) Me-li, which flows by Di-gwi-na and Yaw-baw-du, and thence to the Kon-no country; and (3.) Ma-gna.



## ART. VII.—A Vai or Vey Vocabulary; by the Same.

THE following list of Vai words and phrases is taken from the mouth of John Ferry, who is mentioned in the preceding article, and who lived about one year in the Vai country.

One	don-do	Good	{ bel-le-
Two	fil-la		{ a-gni
Three	sa-kwa	Bad	a-ma-gni
Four	na-ni	Large	ki-li-ma
Five	sô-lu	New	nam-ma
Six	sun-don-do	White	be-ma
Seven	sun-fil-la	Black	vi-ma
Eight	sun-sa-kwa	Sick	ki-la
Nine	sun-na-ni	All	bi
Ten	tân	I eat	na dong
Twenty	fil-la-ban-di	I drink	na mi
Thirty	sa-kwa-ban-di	Open	ka
Forty	na-ni-ban-di	Shut	ma
One hundred	hun-dred don-do	Yes	e-he
Head	ku-gne	No	bul-le
Mouth	da	I	nga
Hand	bu-lu	Myself	nga-won-ga
Foot	king	Thou	i
Sun	te-le	Thyself	i-won-ga
Moon	ka-lu-i	He, she	a
Leaf	dzham-ba	We	mo-a
Fire	ta	You	i-nu
Water	dzhi	They	a-nu
God	ga-lum-ba	My king	na man-dzha
Man	kai	Thy king	i man-dzha
Woman	mu-shu	His king	a man-dzha
Child	di-gne	Her king	a man-dzha
Little child	ding-di-gne	Our king	mo-a man-dzha
Father	fa	Your king	i-nu-man-dzha
Mother	ba	Their king	a-nu man-dzha
King	man-dzha	My house	na ki-gne
Slave	dzhong	Thy house	i ki-gne
Pain	dûng	My father	ûm fa
Name	to	Thy father	i fa
People	moi-nu	His father	a fa
House	ki-gne	Our father	mo-a fa
Village	wa-e-law	My mother	ûm ba
Town	zan-dzha	Thy mother	i ba
Country	bul-le-lu	His mother	a ba
Morning	za-ma	Our mother	mo-a ba
Night	dzhe-lu-ma	One king	man-dzha don-do
Green wood	kong-e	Two kings	man-dzha fil-la
Dry wood	soi	Three kings	man-dzha sa-kwa

One man	kai don-do	People eat	moi-nu-a dong
Two men	ka-ye fil-la	A good man	{ kai bel-le
Three men	ka-ye sa-kwa		{ kai a-gni
Hands	bu-le-nu	Good men	ka-ye-nu a-gni
Feet	king-e-nu	A bad man	{ kai a-ma-gni
Leaves	dzham-ba-e-nu		{ kai yam-ma
Men	ka-ye-nu	A white man	kai be-ma
Women	mu-she-nu	A black man	kai vi-ma
Children	di-gne-nu	God loves men	ga-lum-ba-a ka-ye di-a
Kings	man-dzha-e-nu	Men love God	ka-ye-a ga-lum-ba di-a
Slaves	dzhong-e-nu	What is your name?	i to a-le
Names	to-e-nu	Give to me	in-ko
I eat	na dong	A Vai man	Vai mo
Thou eatest	ya dong	Vai men	Vai moi-nu
He eats	a dong	Mendi people	Hu-lo moi-nu
She eats	a dong	In the house	ki-gne-lo
We eat	mo-a dong	In my house	na ki-gne-lo
They eat	a-nu-a dong	In thy house	i ki-gne-lo

According to Ashmun, the Fey or Vey people extend from the Gallinas river to Grand Cape Mount, a distance of fifty miles along the coast, and from twenty-five to thirty miles into the interior. *Afr. Repos. III. 259.*

According to my informant, the Vai country constitutes two kingdoms, of which Ma-nu and Gen-du-ma are the capitals.

The principal towns in the Vai country are, Manu, not far from the sea, the residence of king Fu-li-ka-va; Gen-du-ma, three or four miles from a river, and nine or ten from the sea, the residence of king Sha-ka; Zalu, about twenty miles from the sea, subject to king Fu-li-ka-va; Dzhu-ling, near the sea, subject to king Sha-ka; Ho-wil-li, twenty or thirty miles from the sea, subject to king Fu-li-ka-va; Dam-ba-ru, close to Zalu, subject to king Fu-li-ka-va.

ART. VIII.—*A Mendi Vocabulary*; by the Same.

THE following list of Mendi words and phrases is taken from the mouths of James Covey and Charles Pratt, native Africans.

The former was born at Go-raun, by the river Mo-a, in the Mendi country; brought from his native country by Africans to Bul-lom, and sold there to the Spaniards; recaptured by the English; taught to read and write English in the English schools at Sierra Leone; and is now a sailor on board the British brig of war Buz-zard.

The latter was born at Sierra Leone of Men-di parents, and is now a cook on board the above mentioned vessel.

One	e-ta	Open land	dzho-po-a
Two	fe-le	Green wood	ngu-li
Three	sau-wa	Dry wood	kaw-wi
Four	na-ni	Grass	dzha-te
Five	do-lu or lo-lu	Leaf	tu-fe
Six	we-ta	Island	ting-hu
Seven	waw-fe--la	Small island	ti-wu-li-hung
Eight	wai-ya-gba		
Nine	ta-u	Bird	ngwaw-ni
Ten	pu	Fish	gne
Twenty	pu fe-le	Baboon	ngo-lu
Thirty	pu sau-wa	Cat	ma-gna-ri
Forty	pu na-ni	Cow	ni-ke
All	gbe-le	Dog	ngil-le
Half	mo-ni	Elephant	he-li
		Goat	ndzhi
Head	ngwi	Hedgehog	pi-wi
Forehead	la-wai or ta-wai	Hog	dôn-de
Hair	yâm-boi	Horse	su-i
Hair of the head	ngwi yâm-boi	Leopard	kaw-li
Ear	gu-li	Male leopard	kaw-li hin-ne
Eye	ngau-ma	Female leopard	kaw-li ha-le
Eyebrow	ngau-ma bi-ka	Lion	su-bu
Nose	ho-gbai	Monkey	kwa-le
Mouth	nda	Male monkey	kwa hin-ne
Lip	nda-gu-lu	Female monkey	kwa ha-le
Tooth	gong-gol-lu	Mouse	gni-ne
Tongue	ne	Sheep	ba-le
Hand	lo-kwi	English bird (duck)	pu-ngwaw-ni
Arm	lo-kwi		
Foot	gaw-we	God	{ ngil-li ge-waw
Leg	gaw-we	Great God	ge-waw wa
		Man	ta-moi
Sun	fu-li	Great man	ta-mo wa
Sunrise	fu-li gwa	Young man	ta-mo wu-lu
Sunset	fu-li gu-la	Woman	gna-pu
Morning	ngin-da	Young woman	gna-ha-lu-po
Evening	bo-ko	Father	ke
Night	gbin-di	Mother	ndzhi
Moon	nga-li	Child	do-le
Star	tùm-be-le-gai	Brother	ndig-ge hin-du
Wind	fe-fe	Sister	ndig-ge ya-ha-lu
Fire	ngom-gbi	Friend	ba-la
Water	ndzhe	King	ma-hai
Rain	dzhe-lo-wa	Governor	ma-hai
Rain water	ngwa-ye	Slave	nduo
River	ti	Man Slave	nduo hin-ne

Woman Slave	nduo gna-ha	Go	di
Name	nda	Open	ndau
Book	kol-le or kor-re	Shut	baw-lu
Mat	nga-le	And	ke
Bed	bu-kaw	If	na
House	pe-le	Yes	{ e-he
Tobacco	tá-we	No	{ um-hu
Pipe	ta-wé		bi-le
Tobacco snuff	ta-wu-ke	Who?	yi-le
Knife	bo-e	What?	be-gbe
Ship	den-de	Where?	min-du
Englishman	pu-lu moi	When?	mi-gbi
People	nún-ga	This	dzhi
Town	{ ta-wa-hu	Here	bin-du
	{ te-gnu	Now	san-gi
Village	{ fu-le-nu	That	na
	{ ba-ba-hu	There	mi-lan-du
Country	ndau-e-re	Then	san-gi
Good	yan-din-go	I	gna
Bad	{ e-yan-din-ne	Thou	bi-a
	{ yam-múng-gwaw	He	ta
Great	{ gaw-lawng-gaw	She	ta
	{ wa	We	mo-a
Small	{ ku-lo-paw-te	Ye	wa
	{ ku-lon-go	They	ti-a
Strong	ba-yan-go	I myself	gna be-kpe
Weak	ha-lan-go	Thou thyself	bi-a bi be-kpe
Old	go-wan-go	He himself	ta-ngi be-kpe
New	ni-nan-go	We ourselves	mo-a mu be-kpe
Aged	go-wan-go	Ye yourselves	wa wu be-kpe
Young	ku-lon-go	They themselves	ti-a ti be-kpe
White	ko-lin-go		
Black	{ te-yin-go	Thy head	bi-gwi
	{ le-yin-go	Thy forehead	bi-la-wai or bi-ta-wai
Sick	ma-wu-la	Thy ear	bi-wu-li
English	Pu-lu	My eye	gna-gau-ma
Born	ndi	Thy eye	bi-gau-ma
True	taw-gna-li	His eye	ta-ngi-gau-ma
False	nde-mi-la	Her eye	ta-ngi-gau-ma
Beautiful	yan-din-go	Thy eyebrow	bi-gau-ma-bi-ka
Ugly	yam-múng-gwaw	Thy mouth	bi-da
Male	hin-ne	Thy lip	bi-da-gu-lu
Female	ha-le	Thy hand	bi-lo-kwi
Eat	me	Thy arm	bi-lo-kwi
Drink	gbaw-li	Thy foot	bi-gaw-we
Sleep	yi	Thy back	bi-wu-ma
Stand	lo	My father	gna-ke
Walk	dzhi-a	Thy father	bi-ke
Come	wa	His father	ta-ngi-ke or ngi-ke

Her father	ta-ngi-ke or ngi-ke	One man	ta-mo yi-ra
Our father	mo-ke	Two men	ta-moi fe-le
Your father	wu-ke	Three men	ta-moi sau-wa
Their father	ti-ke	All men	ta-moi gbe-le
My mother	gna-ndzhi	A good man	ta-mo yan-din-go
Thy mother	bi-ndzhi	A bad man	ta-mo e-yan-din-ne
His mother	ta-ngi-ndzhi	A white man	ta-mo ko-lin-go
Her mother	ta-ngi-ndzhi	A black man	{ ta-mo te-yin-go ta-mo le-yin-go
Our mother	mo-ndzhi	I eat	gna gi-me
My king	gna-ma-hai	Thou eatest	bi-a bi-me
Thy king	bi-ma-hai	He eats	ta e-me
His king	ngi-ma-hai	We eat	mo-a mu-me
Her king	ngi-ma-hai	Ye eat	wa wu-me
Our king	mo-ma-hai	They eat	ti-a ti-me
Your king	wu-ma-hai	I sleep	gna gi-yi
Their king	ti-ma-hai	Thou sleepest	bi-a bi-yi
My book	gna-kol-le	He sleeps	ta i-yi
Thy book	bi-gol-le	She sleeps	ta i-yi
His book	ta-ngi-gol-le	We sleep	mo-a mu-yi
My house	gna-pe-le	Ye sleep	wa wu-yi
Thy house	bi-we-le	They sleep	ti-a ti-yi
His house	ta-ngi-we-le	I make	gna gi-pi-li
Her house	ta-ngi-we-le	Thou makest	bi-a bi-pi-li
Our house	mo-we-le	He makes	ta e-pi-li
My knife	gna-bo-e	We make	mo-a mu-pi-li
Thy knife	bi-bo-e	Ye make	wa wu-pi-li
His knife	ta-ngi-bo-e	They make	ti-a ti-pi-li
Her knife	ta-ngi-bo-e	Thou drinkest	bi-a bi-gbaw-li
Our knife	mo-bo-e	Thou standest	bi-a bi-lo
Your knife	wu-bo-e	Thou walkest	bi-a bi-dzhi-a
Their knife	ti-bo-e	Thou comest	bi-a bi-wa
This book	kol-le dzhi	I have eaten	gna gi-we-la a-me-la
These books	kol-le dzhi	Thou hast eaten	bia bi-we-la a-me-la
That book	kol-le na	He has eaten	ta e-we-la a-me-la
Those books	kol-le na	We have eaten	mo-a mu-we-la a-me-la
What book?	kol-le gbe	Ye have eaten	wa wu-we-la a-me-la
What books?	kol-le gbe	They have eaten	ti-a ti-we-la a-me-la
Any book	kol-le gbe-le		
One ship	den-de yi-ra		
This book is mine		kol-le dzhi gna wo mi-na	
This book is thine		kol-le dzhi bi wo mi-na	
This book is his		kol-le dzhi gi wo mi-na	
This book is ours		kol-le dzhi mu wo mi-na	
This book is yours		kol-le dzhi wu wo mi-na	
This book is theirs		kol-le dzhi ti wo mi-na	
I am your friend		{ gna ba-la bi-a	
I am his friend		{ gna ba-la law a bi-a	
		gna ba-la law a gi-e	

I go to Africa	gna gi-ya Men-di
I come from Africa	gna gi-hi-ya Men-di
God sees me	ge-waw e gna lo-a
I see God	gna gi ge-waw lo-a
God sees good men	ge-waw e ta-moi yan-din-go lo-a
God sees bad men	{ ge-waw e ta-moi e-yan-din-ne lo-a
	{ ge-waw e ta-moi yam-mûng lo-a
Shuma knows Kimbo	Shu-ma Kim-bo gan-law
Shuma strikes Kimbo	Shu-ma Kim-bo de-wi-a
Kimbo strikes Shuma	Kim-bo Shu-ma de-wi-a
What do you call this in Mendi ?	ba-ye dzhi lo-li Men-di yi-a hung?
Did I say it right ?	gna gin-de yan-din-go ?
I will not	gna gi-ru-ma-ni
Thank you	bi si-a
Have mercy on me	gi-la-ba-rung
Good bye	mu-ngen-da-he.

Some of the principal towns in the Men-di country, according to Covey and Pratt, are Dzha-e-ve-fu-lu, Go-raun or Go-la-hûng, Bai-ma, Se-bi-ma, Si-ma-bu, Gna-ya-hung, Gong-a-bu, Bom-ba-li, Fo-la, Fu-la-wa, Ben-de-bu, and Ben-der-ri.

The principal rivers are (1.) Mo-a, which runs into the Vai country; (2.) Sewa, which runs into the Bullom country; (3.) Ma-wu-a, which comes from Gissi, where it is called Ma-ku-na, and joins the Mo-a; (4.) Ma-le, which flows by Dzho-po-a, and joins the Mo-a; (5.) Ta-yem-ma, which joins the Sewa; (6.) Ke-ya, which comes from Gola, and joins the Ma-wu-a.

*Prayer composed for the use of the Mendi prisoners at New Haven, by their teachers, and translated into Mendi, by JAMES COVEY.*

O Ge-waw wa, bi-a-bi yan-din-go; bi-a-bi ha-ni gbe-le ba-te-ni; bi-a-bi fu-li ba-te-ni; bi-a-bi nga-li ba-te-ni; bi-a-bi tûm-bi-le-gai ba-te-ni; bi-a-bi ngi-yi ba-te-ni; ke ndzha wa; bi-a-bi dzha-te ba-te-ni, ke ngu-li, ke gnwaw-ni, ke nwu-a, ke nûn-ga wu-lo-a.

O Ge-waw, bi-a-bi hin-da gbe-le; bi-a-bi ta-moi si-na ti-gbe-le lo-a; bi-a-bi gna lo-a; bi-a-bi gna di lo-a; bi-a-bi gna lo-a, ki-a fu-li a-gu-a; bi-a-bi gna lo-a gbin-di; bi-a-bi gi-li-la hin-de gbi gna-ga ka-la.

O Ge-waw, bi-a-bi gna gaw ko-la, gna-gi si-a-gwa bi-ma; bi gna gaw me-he gi me ke gi gbaw-li, gi si-a-gwa bi-ma. Gna di ei ha, gna di a-lo-law ku-na-faw. Gna di ba-te yan-din-go. Gna-gi bi maw-li, bi gna-ma hum-gbi. Gna-gi bi maw-li, bi gna daw-wung yan-din-go. Gna-gi hin-da yam-mo wi-li-a. Ma-nu gna-ma. Gi bi-ma ni-ni-a. Ki-a nga ha, bi gna di we, bi di-la hin-da bi-gbe; Ge-waw wa ndui wa. Amen.

ART. IX.—*Vegetable Organography and Physiology, or the Formation and Vital Functions of Plants*;\* by HORACE GREEN, M. D., of New York.

THE study of the structure of vegetables and of the phenomena of vegetable life—a study embracing a wide and an interesting field for observation—has been very generally neglected in this country. The naturalist who has sought amidst the flowers and foliage, and other external forms of plants, for characters to enable him to arrange and classify these plants, has rarely directed his inquiries to their anatomical structure, or been aware of the diversified, yet beautiful phenomena manifested in the operation of their vital functions. The near approximation of the two kingdoms of organized matter, (the animal and vegetable,) to each other, and the striking analogy which exists in the laws governing the development of each, renders the study of vegetable anatomy highly interesting, and in some degree, important to the animal physiologist. Some of the most eminent naturalists allow, that in their structure, the two kingdoms present us with no diagnostic mark by which we can separate the lower and most approximated groups of both from each other. In the phenomena exhibited by their vital functions, the analogy is equally striking. “From the most simple vegetable up to the polypus, from the most simple polypus through all the ascending scale of being up to man, the characters of life are nearly the same.”†

From the researches of various eminent physiologists, it appears that all vegetable matter, when traced to its primary tissue, originates in a simple cell of inconceivable minuteness; and that, in this respect, there is identity of structure in animals and vegetables; for it is now generally allowed, by animal physiologists, that all animal tissues, however varied in form, have their origin, also, in a cellular structure.

The aid which has been derived from the study of comparative anatomy, has enabled the physiologist to make many interesting discoveries, and to settle many disputed questions, connected with the structure and functions of the human system; and such ad-

---

\* This paper was read before the New York Φ. B. K. Society, July 24th, 1839, and the publication of it authorized, by a vote of that Society, as a part of its Transactions.

† *Animal Physiology*, Part I, page 20.

Vol. xxxviii, No. 1.—Oct.—Dec. 1839.

vances have been made in the study of vegetable anatomy and physiology, by the labors of De Candolle, Dutrochet, Lindley, and, more recently, the interesting inquiries of Carpenter, as to lead to the belief, that the day is not distant when the naturalist will discover, from the study of vegetable life, an explanation of the cause of many of those phenomena which have, hitherto, baffled the inquiries of the animal physiologist. Already the remark made by Cuvier, on the various forms and vital functions of animals, may, with equal fitness be applied to those of the vegetable kingdom; that they "are so many kinds of experiments ready prepared by nature, who adds to, or deducts from each of them, different parts, just as we might wish to do in our own laboratories, showing us herself, at the same time, their various results." This is, indeed, the only true method of studying physiology: to listen to the language of nature, as she spontaneously reveals her secrets, is far preferable to the *inquisitorial* method of extracting them from her, by cruel experiments.

But before we undertake a description of the organs of plants, or of their functions, or attempt to trace the analogy which exists between the two kingdoms, vegetable and animal, it will be necessary to make a few brief inquiries into the nature of the *primary tissues*, which enter into the structure of the vegetable formations.

The primary tissues, or elementary organs of all plants, are three in number; the *cellular tissue*, the *woody fibre*, and the *vascular tissue*, or *spiral vessels*. To these is sometimes added another tissue, denominated *ducts*. Late inquiries, however, have shown these ducts to be a variety in the form of the spiral vessels, and to be identified with them.

The *cellular tissue* enters into the composition of all vegetables. It is composed of minute, transparent vesicles, or cells, the sides of which are adherent to each other. These vesicles are exceedingly minute; varying in size, in different plants, from the 30th to the 1000th part of an inch. They generally contain an elaborated fluid, which circulates freely, in all directions, through the vegetable membrane that forms the sides of these cells. But the medium by which this circulation is carried on, has, for a long time, engaged the inquiries of vegetable physiologists. The cells do not communicate by any appreciable pores or fissures. Nothing of the kind has ever yet been discovered, although they have



been subjected to the most powerful microscopic observation. They possess another wonderful faculty, which is a self-productive quality. Each vesicle is capable of generating many others within itself.

The *woody fibre* differs from the cellular tissue, in having its vesicles considerably elongated and pointed or wedge-form at their extremities. The sides of the woody fibres possess a much greater tenuity, and are more firm and elastic than the cellular tissues. Collected into parallel bundles, and wedged together by means of their pointed extremities, they afford strength and support to the vegetable fabric, and have, therefore, been denominated the "skeleton of the plant." The ascending sap is transmitted through these vessels, yet, like the vesicles of the cellular tissue, they have no visible pores.

The *spiral vessels*, like the woody fibre, appear to have originated from the simple cell. Like the former, too, they are elongated tubes; but they possess within their tube, a spiral, woody fibre, whose coil seems destined to preserve the integrity of their calibre. The office of the spiral vessels is not fully known; but as they very generally contain air, and, with the exception of the roots, pervade almost every part of the vegetable system, their function is, undoubtedly, connected with the respiration of the plant. "A very curious analogy to this structure," says Mr. Carpenter, "is exhibited in the tracheæ, or air tubes of insects, which ramify by minute subdivisions through the whole of their bodies. These tubes are formed, like the spiral vessels of plants, of an external membrane, distended by spiral fibre, which is coiled with the most beautiful regularity."\*

The *ducts*, which have been spoken of as being a modification of the spiral vessels, differ from the latter, in having no coiled fibre within their canal. Their sides are transparent, and are studded with minute dots, which give to them the appearance of perforations. Like the preceding tissues, however, they are destitute of all visible pores or openings. By some physiologists it is supposed that the dotted ducts serve to convey sap along the stem of the plant; others regard their functions, like the spiral vessels, to be connected with the respiratory system.

---

\* Principles of General and Comparative Physiology, by Wm. B. Carpenter.

These four primary tissues, constitute the only elementary organs which enter into the structure of vegetable formations. There are other organs connected with the phenomena of vegetable life, but they are composed of some one of these elementary tissues.

Of all the elementary organs which enter into the composition of plants, the cellular tissue is the most abundant. It is the basis of all vegetable structure, and is the only tissue that is universally present. The other forms sometimes entirely disappear, or are never developed.

The first natural division of all plants is into two grand classes, arranged according to the presence or absence of one of these primary tissues, viz. the *spiral vessels*. It has been ascertained that all flower-bearing plants, or those which are propagated by means of sexual organs, have spiral vessels; whilst those vegetables which have no flowers are destitute of spiral vessels.\*

The first class is denominated *vasculares*; the latter *cellulares*. Under the head of cellular plants are included the numerous tribes of Ferns, Mosses, and Lichens; vegetables which, to the uninitiated observer, may appear of little importance in the operations of nature. Yet, without their aid, many parts of our globe, which are now teeming with vegetation and life, must have remained barren and uninhabited wastes. Some of the tribes of cellulares, as the mosses and lichens, of which there are several thousand species, may be deemed the pioneers in vegetation. They are found where no other forms of vegetable life can exist. Attached to the bare rocks of newly found countries, and islands in the ocean; springing into life on the surface of the encrusted lava, they vegetate and decay; and thus, by depositing the remains of successive generations, gradually prepare these barren surfaces for higher grades of vegetable life. "How they find their way to such places," says Dr. Lindley, "and under what laws they are created, are mysteries that human ingenuity has not succeeded in unveiling."

Both the anatomy and the physiology of vascular plants are better understood than the growth and functions of cellulares. The organs of the circulating system, also, and the course of the sap in *vasculares* are now very well known, whilst much doubt

---

\* Introduction to the Natural System of Botany, by J. Lindley, &c. p. 16.

still exists in regard to the structure and functions of these organs in cellular plants. We shall therefore select a subdivision of the former class of plants, in describing the anatomy of their organs, and in tracing the analogy which exists between the vegetable and animal kingdoms.

Naturalists have discovered that there are two orders of plants belonging to vasculares, which are widely different in their anatomical structure, and in the laws which govern their development. These divisions have been termed endogenous and exogenous.

Endogenous plants are cylindrical, and are destitute of bark. Their development is by an annular deposition of new ligneous matter *within* the cylinder. The palm, the cane, corn, and the various grasses, are examples of endogenous plants. Exogenous compose a much larger, and a more interesting class. They include all the trees of our forests, for the protection of whose external surface nature has provided a bark. The reason for this provision will appear, when it is known that the growth of trees depends upon a deposition of new materials upon the outside of the wood, and between it and the bark.

All exogenous plants, of which class the oak, the elm, the pine, the beach, &c. are examples, are composed of five principal parts; the medulla or pith, the medullary sheath, the wood, the bark, and the medullary rays.

It has been said that only four primary tissues enter into the organization of vegetable structure, viz. the cellular tissue, the woody fibre, the spiral vessels, and the ducts. The pith, which is the central portion of the plant, is composed of vesicles of the cellular tissue; neither spiral vessels or woody fibre enter into its composition. The vesicles of the medulla are slightly bound together; and their walls, according to the opinion of some physiologists, are covered with minute globular bodies, which are regarded as the nervous organs of the plant.\*

No part of the ascending sap passes through the pith; but its cells are filled with an elaborated, nutrient fluid, which being disseminated in spring-time, serves to nourish the early buds, until they are sufficiently developed to procure nourishment for themselves. How far the pith may be considered as the special seat

---

\* Recherch. Anat. et Physiol. sur la Struct. &c.

of vegetable life, and analogous to the nervous system in animals, is still an interesting question for the vegetable physiologist.

Immediately surrounding the pith is the medullary sheath. Whilst the former is composed of cellular tissue, the latter consists of spiral vessels and ducts. The office of the medullary sheath is not well understood. Lindley, who believed it to be in direct communication with the leaf-buds, and the veins of the leaves, supposed that it was the medium through which the ascending sap is transmitted to the leaves. Dutrochet and some other physiologists are of the opinion that the office of circulating the ascending sap is confined to the lymphatic tubes of the woody fibre, and that the spiral vessels of the medullary sheath belong to the function of respiration. As these vessels are found almost invariably to contain air; and, moreover, have direct communication with the leaves, which are in fact the lungs of the plant, it is more than probable that the opinion of Dutrochet is correct.

Deposited in concentric layers around the medullary sheath, and lying immediately upon it, is the wood. It is composed of cellular tissue, woody fibre, and ducts. Each year a distinct layer is deposited. The concentric layer of the first year, or the one lying in immediate contact with the medullary sheath, consists of woody fibre and ducts; but each succeeding layer has an interior membrane of cellular tissue, (the same tissue of which the pith is composed,) and an external stratum of woody fibre and ducts. The wood is usually subdivided into the denser portion, which is called *lignum*; and external to this, a softer portion called *alburnum*.

The former consists of the internal layers surrounding the medullary sheath, which being fully formed, have ceased to afford a passage for the circulating fluid. It is also called *heart-wood*. External to this is the softer wood, called the *alburnum*; which is also deposited in concentric rings, between the true wood and the bark. It is through this part of the plant, the *alburnum*, that the fluid drawn from the earth, the ascending sap, is principally transmitted. *The bark* is composed of the same elementary tissues that enter into the composition of the wood, viz. cellular tissue, woody fibre and ducts; but whilst the layers of wood consist of an interior stratum of cellular tissue, and an outer stratum of woody fibre and ducts, those of the bark are reversed: they are composed of a layer of woody fibre and ducts inside, and of cellu-

lar tissue outside. The bark is also subdivided into three parts ; the inner portion is called the *liber* ; surrounding this is the *cellular envelop*, and external to all, the *epidermis*. It is through the liber, the inner portion of the bark, that the principal part of the descending sap is carried, after it has undergone those chemical changes, in its circulation through the leaves, that qualify it for giving support and nourishment to the different parts of the plant.

On making a horizontal section of the trunk, or branch of an exogenous tree, radii of cellular tissue are seen extending from the centre to the circumference of the wood. These vessels are denominated the *medullary rays*. Having their origin in the medullary sheath, and consisting of the same elementary tissue with the pith, projections of which pass through the sheath into the medullary rays, they serve to connect this central system of the plant with its circumference.

The medullary rays perform a very important function in the economy of vegetable growth. That peculiar secretion which is effused in the spring of the year, between the wood and the bark, and which separates the alburnum from the liber, is poured out by these medullary radii. This viscid secretion, when organized, is supposed to constitute the cellular portion of each concentric layer. Whilst this deposition is going on, a fibrous secretion is descending from the expanding buds, and by its adhesion to the first deposit from the medullary rays, constitutes the outer stratum of woody fibre and ducts of the new layer. Thus it will be seen, that a triple and diverse circulation is carried on, in exogenous plants, at the same time. During the vernal season, whilst the lymphatic sap is ascending in the greatest quantity, and the elaborated fluid, having undergone the necessary changes, in its circulation through the leaves, is descending and depositing its nutritious particles in the different parts of the plant, this transverse current is percolating through the horizontal radii, to deposit, on the exterior surface of the alburnum, a new layer of vegetable growth.

It would be interesting to trace minutely the course of the vegetable circulation, and to investigate the agency or powers by which this circulation is sustained. But the limits originally designed for this paper will not allow of this extended inquiry. We

can only glance briefly at the course of the sap, and notice the changes which take place in this fluid, in its circulation through the vegetable system.

De Candolle discovered that the roots of exogenous plants were terminated by small organic bodies, composed of cellular tissue and woody fibre, enclosing in their centre a minute bundle of ducts. These bodies, which are termed *spongioles*, possess the power of absorbing fluids from the earth with wonderful rapidity. This power has been denominated *endosmose*, by Dutrochet, who discovered, by some ingenious experiments, that the accumulation of a fluid in organic cavities, like the cells of plants, imparted to those bodies a vital principle by which their cavities were alternately emptied and replenished. It is a law of this "physico-organic action" that the denser fluid always attracts the rarer; and as the cells of plants are always filled with a matter of a denser consistence than water, this fluid, which always surrounds the roots of trees, is drawn up by the spongioles with great rapidity. This action possesses the property of rendering turgid the contents of these cavities, when once imbibed, so that a constant endosmose is kept up. Professor Daubeny, by some curious experiments, demonstrated that the roots of plants possess the power of selecting such materials as are required for their nourishment and growth, and of rejecting matter whose introduction into their tissues would prove deleterious to the plant. In almost all plants, however, the ascending sap is found to be nearly uniform in its composition; consisting of water, holding in solution various mineral substances, with atmospheric air. Having once entered the spongioles, the sap is conveyed along in its vertical current from one vesicle to another by this *endosmometric* property of the tissues of the plant, until it arrives at the leaves, where by its exposure to the atmospheric air it undergoes a chemical change, which prepares it to afford vitality and nourishment to the plant. This process is considered by physiologists as strictly analagous to the respiration of animals.

The phenomena connected with the respiration of plants, or the changes produced upon atmospheric air by vegetables, are highly curious and interesting. It was ascertained many years ago, by Bonnet, Priestley, and others, that healthy plants exposed to solar light, were constantly evolving oxygen gas. But the

manner in which this gas was produced, whether it was generated by the plant or taken from the atmospheric air and afterwards discharged, remained an unsettled question until the experiments of Sennebier, De Candolle, and other vegetable physiologists, proved that in this process are involved some of the most important laws of vegetable life. By the experiments of these philosophers it was proved that during the night oxygen is absorbed by the leaves of the plant, which combining with the carbon previously brought up from the earth in the ascending sap, is converted into carbonic acid. On the return of solar light, a decomposition takes place; the oxygen is evolved, and the carbon is retained for the nourishment of the plant. "It is evident," says Roget, "that the object of the whole process is to obtain carbon, in that precise state of disintegration to which it is reduced at the moment of its separation from carbonic acid, by the action of solar light, on the green substance of the leaves; for it is in this precise state alone that it is available in promoting the nourishment of the plant, and not in the crude condition in which it exists when it is pumped up from the earth along with the water which conveys it into the interior of the plant."\*

The amount of oxygen given off during the day, is much greater than the quantity which is absorbed during the night. Much of the carbonic acid of the atmosphere is also decomposed by the leaves of plants; the carbon is retained, and the oxygen is evolved. Hence it is that the growth of healthy plants exercises a purifying influence upon the surrounding atmosphere, and beautifully adapts it to the respiration of animals.

Besides this decomposition of carbonic acid, various other chemical changes are wrought upon the sap, and the materials contained in the sap, in their circulation through the leaves. A part of the water is decomposed, and by the various combination of its elements with the different mineral substances which it held in solution, those vegetable products are formed which are suited for the further growth and development of the plant. Thus will be seen the beautiful and perfect analogy which exists between the circulation in vegetables and animals. The ascending sap, like the venous blood in its circulation through the lungs, having been

---

\* *Animal and Vegetable Physiol.* Vol. II, p. 31.

renovated in passing through the leaves, by its combinations with atmospheric air, returns, and, like the arterial fluid, penetrates every part of the vegetable fabric, and deposits in each tissue its appropriate nourishment.

In glancing thus briefly at the organisms and functions of animals and vegetables, it will be seen that there is identity of structure and unity of function existing, throughout, between the two kingdoms. "Perhaps," says Professor Henslow, "until the contrary shall have been proved, we may consider the addition of *sensibility* to the living principle, as the characteristic property of animals." But as he defines this characteristic property of animals to be "a quality by which the individual is rendered conscious of its existence, or of its wants, and by which it is induced to satisfy those wants by some act of volition,"\* we are inclined to the belief, however difficult it may be to demonstrate it, that a quality strictly analogous, in its results, to this property in animals, belongs to vegetables!

During a residence of several years in the country, we have watched the growth and studied the habits of some of the exogenous plants, with the highest interest; and it is our intention to close this paper with some observations made upon one of the most common specimens of exogenous trees.

It is well known to botanists that some species of plants attach themselves, apparently from choice, to barren surfaces, and vegetate with surprising vigor. They even possess the power of excavating crevices for the attachment of their roots in the calcareous rocks to which they fasten themselves. This is the case with some tribes of lichen. Possessing the power of secreting an acid from their roots, which acts upon the carbonate of lime, they are thus enabled gradually to imbed themselves into the surface of the rock itself.† Some trees, also, of the exogenous class, as the *Ulmus Americana*, or common elm of this country, not only flourish best in mountainous regions, and where the soil is thin, but they are often seen growing upon the limestone ledges, where but little soil is found for the attachment of their roots. One of these trees had sprung up, and had attained some magnitude, on the thinly soil-clad surface, and near the edge of a broad calca-

---

\* Principles, page 8.

† Roget, page 39, et seq.



reous rock. From one side of the base of the tree the rock gradually sloped off towards the earth, into the soil of which the roots of the elm had imbedded themselves. On the opposite side, and within a few feet of the tree, the rock was abruptly broken off by a perpendicular descent of many feet. Over this edge of the bare rock a large root of the elm had crept, and when first seen by the writer, several years ago, was apparently seeking to hide itself in the soil below; but a distance of several feet still intervened between the root and the earth. This singular and unnatural position of the root attracted our attention at the time, and being in the vicinity of the tree two or three years afterwards, we visited it, and found that this wandering root had literally *retraced its steps*. It had actually bent directly back upon itself, and passing by the tree, had buried itself in the earth, along with its fellows, on the side opposite from where it sprang. Here certainly a "want" existed, and although we cannot, in strict philosophy, accord to vegetables the power of "volition," yet this want was satisfied by an act, or quality, analogous to the act of volition in animals.\*

In another instance, this quality, or vital principle, was manifested in a still more striking manner. About fifteen years ago, upon the top of an immense boulder of limestone, some ten or twelve feet in diameter, a sapling elm was found growing. The stone was but slightly imbedded in the earth; several of its sides were raised from four to six feet above its surface; but the top of the rock was rough with crevices, and its surface, which was sloping off, on one side to the earth, was covered with a thin mould. From this mould, the tree had sprung up, and having thrust its roots into the crevices of the rock, it had succeeded in reaching the height of some twelve or fifteen feet. But about this period, the roots on one side became loosened from their attachment, and the tree gradually declined to the opposite side,

---

\* "Plants," says Hugo Reid, in an attempt to draw a line between the animal and vegetable kingdoms, "have no consciousness of existence, no experience of any wants, no power of selecting food." (Science of Botany, page 16.) Yet this same author afterwards says: "Carbon, it is well known, is absolutely necessary for the support, and growth of vegetables, and when this element is not to be found in the soil, they can extract it from the atmosphere, and assimilate it to their substance." The Science of Botany; by Hugo Reid, p. 53.

until its body was in a parallel line with the earth. The roots on the opposite side, having obtained a firmer hold, afforded sufficient nourishment to sustain the plant; although they could not, alone, retain it in its vertical position. In this condition of things, the tree, as if "conscious of its wants," adopted (if the term may be used) an ingenious process, in order to regain its former upright position. One of the most vigorous of the detached roots, sent out a branch from its side, which passing round a projection of the rock, again united with the parent stalk, and thus formed a perfect *loop* around this projection, which gave to the root an immovable attachment. The tree now began to recover from its bent position. Obeying the natural tendency of all plants to grow erect; and sustained by this root, which increased with unwonted vigor, in a few years, it had entirely regained its vertical position; elevated, as no one could doubt, who saw it, by the aid of the root which had formed this singular attachment. But this was not the only *power* exhibited by this remarkable tree. After its elevation it flourished vigorously for several years. Some of its roots had traced the sloping side of the rock to the earth, and were buried in the soil below. Others, having imbedded themselves in its furrows, had completely filled these crevices with vegetable matter. The tree still continuing to grow, concentric layers of vegetable matter were annually deposited between the alburnum and liber, until by the force of vegetable growth alone, the rock was split, from top to bottom, into three nearly equal divisions, and branches of the roots were soon found, extending down, through the divisions into the earth below. On visiting the tree, a few months since, to take a drawing of it, we found that it had attained an altitude of fifty feet, and was four and a half feet in circumference at its base. Having overcome obstacles which do not ordinarily impede vegetable growth, by the manifestation of a principle, and a power, not ordinarily developed in vegetation, it was towering upwards, and stretching its branches abroad as if ambitious to take its place among the loftiest trees of the forest.

As no trace of a nervous system has, as yet, been discovered in vegetables, the spontaneous motions which they occasionally exhibit, and the various changes produced by their functions, are generally referred, by naturalists, to the *organic sensibility*, or

*vital energies* of vegetation. The process of nutrition, secretion, and the circulation—processes, which are “highly complex, and elaborate in plants,” and which are influenced by a nervous agency in animals—are carried on in vegetables by some power, or agency, as yet, imperfectly understood; but which, in its nature and results, is strictly analogous to the ganglionic system of nerves in animals.

We would not, however, be understood to express the opinion that plants, either possess the power of volition, or, that their vital movements are actually influenced by a nervous system. This is not our belief. But we have long been of the opinion, that there are vital energies, or properties, developed in the growth of vegetables, which are influenced by laws, that, as yet, are imperfectly understood;—laws which cannot be explained by any of the known phenomena of organic chemistry.

This subject still offers a wide and an interesting field for investigation. “On man,” says a late elegant philosopher, “has been conferred the high privilege of interpreting the characters of the book of nature, and of deriving from their contemplation, those ideas of grandeur and sublimity, and those emotions of admiration and of gratitude, which elevate and refine the soul, and transport it into regions of pure and more exalted being.”

Trees and flowers

Are social and benevolent, and he  
Who oft communeth in their language pure;  
Roaming among them, at the cool of day,  
Shall find like him who Eden's garden drest,  
His Maker there to teach his listening heart!

ART. X.—*Practical Remarks on Gems, especially on some of those found in the United States*; in a letter addressed to C. A. LEE, M. D., and by him communicated for insertion in this Journal; by THOMAS TABER, a practical Jeweller.

*Dear Sir,*—The following remarks relate principally to the second class of Gems, of which many localities in our own and neighboring states furnish no despicable supply. I have received a number of choice specimens from Chester County, Penn.,

which locality and its vicinity may be said literally to abound with those I am about to enumerate; many of them, which I have had cut and polished, would not suffer in comparison, with some of the highly prized European and Asiatic gems—productions of the same family.

Among these may be named the *Chrysoptase*, *Amethyst*, *Cairn-gorm*, *White Crystal*, *Brown Crystal*, *Precious Garnet*, *Chalcedony*, *Jasper*, *Corundum*, *Hypersthene*, *Red Oxide of Titanium*, *Sphene*, (to which this is nearly allied,) and *Spinelle*, together with the *Beryl*, *Zircon* and *Jade*,—the last three now fallen into disuse.

1. *Chrysoptase* is a very pretty second class gem of a delicate pea or apple green color, a good deal thought of by the jewellers, and used by them in every form, from the humble stomacher pin to the peerless tiara and aigrette. It looks however to best advantage when set in filagree, the dead yellow of which forms a pleasing contrast with its bright and agreeable green. Having a vitreous lustre, and hardness like quartz, it is in frequent requisition for signets and the like,—the demand varying with the fashion; but it is at all times considered a valuable stone. It is mentioned in Revelations as the tenth foundation stone of the heavenly Jerusalem. In some of the European countries it is worn as an amulet, and is like all other beautiful stones, successfully imitated.

2. The *Amethyst*, (*Violet Quartz*.) This was worn by the ancients as an amulet against intoxication. It varies in shade from a delicate pink or lilac, to a deep purple, sometimes approaching to a dark blue; the latter is called “oriental,”\* notwithstanding its being frequently found in northern Europe, and in many parts of Germany. Some call this stone “sapphire,” but sapphire is much harder and certainly a far greater rarity.

Amethyst I believe to be the softest of the quartz family, having found when setting this stone with a hard or ordinary file, and subsequently polishing the setting with rotten stone on threads, the facets considerably grubbed or rounded. This is also used by the jewellers in every form that taste or fancy dic-

---

\* *Oriental* was at first a geographical epithet, but is now used as a term of excellence.—EDS.

tates,—from the modest pin, to the ducal coronet, and imperial crown. It is well adapted for seal engraving, and on it coats of arms, crests, cyphers, &c. appear to great advantage. There are said to be in many of the European museums, some very fine cameos and intaglios, which have been cut on this stone. It forms a pretty connecting link between the pink topaz and the deep rich maroon of the carbuncle. Sunlight and heat are very injurious to its beauty, by causing it to fade, apparently extracting its color, and diminishing its lustre, as exposure for any length of time in a window has fully proved. This stone too is mentioned in Scripture, and was appointed in Exodus for the ninth stone or third in the third row of the high-priest's breastplate. It is also frequently required for the making up of posy or acrostic jewelry, as it is called. In England, when making a present of a ring or brooch, they have a delicate way of expressing a sentiment, that of arranging the stones in setting, so as to spell a word, a name, or a sentence; for example, the initial letters of the following stones when combined will form the word REGARD.

Ruby, Emerald, Garnet, Amethyst, Ruby, Diamond.

This together with some word or name, is made up into a half-hoop finger ring. When a sentence is desired, the stones are either set entirely round the finger, or a large centre stone or glass for the hair, or for a breast pin.

The imitations of this stone are so perfect as readily to deceive; but upon close examination small globules of confined air can be readily perceived; the best method for the unpractised is to have recourse to the file; this is at all times the only unerring test, all imitations of gems being scratched by that instrument.

3. *Cairn-gorm*, (*Citrine, Yellow Crystal or Quartz, Bohemian Topaz, &c.*) This is one of the beautiful inferior gems, passing insensibly from a pale straw to a bright yellow and deep orange color, and is held in much esteem on account perhaps of its close resemblance to the topaz; it however possesses a sufficient individuality whereby one of small experience in these matters may be able to distinguish the difference. It rarely or never exhibits the delicate though rich tinge of fawn or buff, which is the general characteristic of this gem. It is very transparent, and in constant demand for seals, cane tops, ear rings, breast pins, finger

rings, bracelets, &c., &c. Any and every device has been cut on this stone and with good effect: the contrast of the unpolished engraving with its natural brilliancy is very striking; stones are sometimes cut from this substance to imitate the rose diamond with the star and pavilion facet, and palmed off as yellow roses.

4. *White Crystal, (Limpid Quartz, Nova Mina, British Diamond or Rock Crystal.)* It bears a very high polish, is perfectly transparent, and is in reality second only to the diamond. This is used for the under parts of doublets, and is the base of all the imitative gems. It much used in jewelry of all kinds—shows a beautiful play of colors when set in clusters, and is cut for seal stones and desk seals; also for dagger, knife handles and the like, and being so completely a transparent medium, is polished by the optician for spectacles. It is said to be less trying to the eyes than glass, which is not the only advantage derived from using it in this way; it being considerably harder than glass, is not easily dimmed by scratches. This is found in great abundance in many places in the United States, and often appears fully equal to the best Alpine or Madagascar specimen.

5. *Brown Crystal, (Smoky Quartz.)* Some make a groundless distinction between the brown and smoky varieties. The smoky appears perhaps a little darker in the rough, but there is certainly no difference when polished, with the exception that the one may be a shade deeper than the other—they still are both brown. I have a very fine specimen, cut as a large seal stone from Lancaster Co., Pa.—beautiful as any similar thing from Scotland. This is frequently cut like a rose diamond and sold for jargon or zircon; and the better to deceive, odd shapes are selected and artificial defects introduced. At one time, also, an extensive traffic was carried on among the jewellers, by coloring this stone and calling it “Egyptian ruby;” but this no longer being a secret, the practice is discontinued. I remember also to have seen it when in England, cut thin like a garnet and painted and backed with garnet foil, which it not only imitated, but excelled the finest vinegar garnet I ever saw; and to render the illusion more complete, a hole is sometimes drilled in the centre, into which a turquoise is inserted—this being the expedient resorted to, to fill up the holes in real garnets, the finest and largest of which come drilled as beads to evade a heavy British duty. A

large centre of brown crystal encircled with aquamarines set transparent, or without a back, has a very pleasing effect.

6. *Garnet Precious*, (*Carbuncle, Almandine, Vermilion, Pyrope, &c.*) This is of a rich blood red or crimson color, with sometimes a shade of brown or mixture of bluish yellow; this kind is called by the lapidary, vinegar garnet. It is more transparent than the rest and a much better foil stone. All of them, however, are in constant demand for jewelry of all kinds, and justly so, it being a rich and beautiful stone, and always looks well under every form. This stone is found abundantly in the neighborhood of West Chester, and is one of those upon which very excellent engravings have been executed.

7. *Chalcedony*. There are more varieties perhaps of this than any other stone known; the most common is called white carnelian. In some parts of New York and Pennsylvania it is very abundant, and some specimens of it are very choice. The pieces I have had polished are very beautiful, differing from any I have hitherto seen, being mottled or clouded with buff, brown, and black, on a semi-transparent ground. This stone is mentioned in Scripture, and was in higher esteem formerly than at the present time. It is put to a variety of uses, being sometimes cut up for burnishers, letter weights, bell pulls, mortars, umbrella, cane, knife, dirk, and parasol handles; also for snuff boxes, seals, pins, &c. It has also been frequently employed for engraving or cutting bas reliefs.

8. *Jasper* has some resemblance to chalcedony, having a similar hardness and taking an equal polish, and is perhaps only a variety of the above; at any rate they are frequently, if not generally, found together or passing into each other, rendering it difficult to know where the one ends and the other begins. There is however one important distinction that must not be overlooked; chalcedony is generally translucent and rarely quite opaque, whereas jasper is never translucent, but always opaque, for it contains a large proportion of iron which forms its coloring matter. It is cut up into very handsome pin and seal stones resembling to a degree the Scotch and Egyptian pebbles. This stone also is spoken of in holy writ. I have some very good specimens of jasper which I found at Hoboken, N. J.—they take a high polish.

9. *Corundum*. This mineral being essentially the same as emery, is used by cabinet makers and others as a substitute for

emery paper ; it is also used extensively for the polishing of cutlery, and even of some of the gems. It occurs in long six-sided crystals, and in other forms in which the original crystals are so abraded that their form cannot be distinguished ; in color it is very dull, sometimes of an indefinable brown, green, red and gray.

10. *Hypersthene*, is the very opposite of corundum in consistency, being as soft as the other is hard ; neither is it so useful, though it is said sometimes to have figured in jewelry. It must have made a very uninteresting appearance, as it bears but an indifferent polish. Its color is greenish black or brown ; it is very abundant on the banks of the Brandywine, although of a very poor kind ; but I have just seen some beautiful specimens from Massachusetts. Although it appears to be in some repute with the French, for jewelry, it is almost unknown to North American jewellers.

11. *Red Oxide of Titanium*, is used by the dentists to impart a tinge of color to their porcelain or incorruptible teeth which renders them more natural in their appearance. The color of this is a copper red, approaching to brown, of metallic lustre, and when found together with quartz, its appearance is very beautiful, sometimes passing through the crystals in minute hair-like fibres.\*

12. *Sphene*, (*Calcareous Oxide of Titanium*.) Is but a variety of the preceding, and embraces such a range of form and color as to render it difficult of recognition, except to those well versed in the study. It is of a lustre less metallic than the above ; it is opaque and much harder ; it may easily be mistaken for the brown garnet, which however is of greater tenacity and different structure.

13. *Spinelle*. In color it is either red, brown or black with all their intermediate shades and modifications ; it is found in granular and angular fragments, and octahedral crystals ; those of a crimson color are much used in fine jewelry under the name of spinelle ruby, as also the rose-red or pink, which is styled the Balas ruby ; that of a violet color, closely resembles the Almandine garnet, and is known as the Almandine ruby. There are other varieties, such as the orangine or rubicelle.

---

\* The rutilite of Middletown, in Connecticut, forms a most beautiful gem. It has recently been brought out by Prof. C. U. Shepard, from London, polished and set, and almost rivals the ruby.—EDS.



14. *Beryl*, is in our times but little esteemed for jewelry ; it is of a very faulty or feathery nature, of a whitish, bluish, and yellowish or sea green color, rather dull, yet of vitreous lustre, feebly scratches quartz, and readily yields to the topaz ; it is translucent but seldom transparent. Crystals of this stone have been found in Chester Co., and other places, upwards of six and even eight inches in diameter. It is frequently mentioned in Scripture ; it is an inferior variety of the emerald, which greatly exceeds it in beauty. Beryl is found in very many places in the United States, and in some localities passes into the emerald, as in Maine, in Massachusetts, and at Haddam in Connecticut.\*

15. *Zircon*. This like the preceding has greatly depreciated in estimation ; it is much harder than quartz, is of a resinous lustre, and varies in external appearance and color, being sometimes yellowish brown, reddish green, &c. It sometimes appears as though scales of mica were intermixed. It was in much more esteem formerly than now as a gem, particularly the variety called hyacinth ; which was worn in mourning apparel.

16. *Jade* is now a dead letter in the arts, and only to be met with in the cabinet of the mineralogist ; there is a kind however, found in Turkey and used by the natives for dagger and scimitar handles, upon which various devices are carved ; there is a great discrepancy of opinion at the present day as to what jade really is, that known to the jewellers by this name is a shining white opaque mineral, and only very occasionally used by them in motto jewelry.† Whether the native productions of the United States will prove a source of international profit remains to be ascertained. There is one serious difficulty in the great difference in the cost of labor between this country and Europe. Lapidaries are at present but few in number, some of whom import polished specimens and even metal jewelry for the very purpose of breaking up and remodeling them. Stones ready cut for jewelry, may be imported from Germany, at one quarter the cost of polishing specimens furnished in New York. It is also true that the facilities are not so great here for their manufacture ; there is a want of enterprise in this branch of the arts ; but the

---

\* In New Hampshire crystals are found of a foot or more in diameter, and weighing 100 to 200 pounds.—EDS.

† The Jade of the South Seas is often of a deep leek green.—EDS.

investment of but a comparatively small capital would soon give it another complexion. We have as much water power here as they can possibly have in Oberstein or Bohemia, which are the grand marts of Europe.

*Remarks.*—We are happy to become acquainted with the experience of a sensible practical man like Mr. Taber, and to learn from him the state of this comparatively infant branch of manufacture among us; and especially in New York.

We should be gratified to receive similar communications from our other large cities, and especially from Philadelphia, where we suppose that all the arts relating to gems are farther advanced than any where else in this country. Mr. Taber does not mention the incomparably fine tourmalines of Paris, Maine—some of which as polished in London, and now in the hands of Prof. Charles U. Shepard, of this place, almost rival the ruby and the emerald in color and beauty, and far exceed them in size. They are we believe without a parallel in the world.\* The fine spinelles and other remarkable minerals of Orange Co., New York, and of the neighboring parts of New Jersey, as well as the splendid transparent and perfect beryls of Haddam, recently brought to light by Prof. Johnston, of the Wesleyan University at Middletown, Connecticut, some of them being little inferior in beauty to the emerald, and far surpassing it in size, we suppose are unknown to our lapidaries.—*Eds.*

ART. XI.—*On the Connexion between the Theory of the Earth and the Secular Variations of the Magnetic Needle*; by JOHN H. LATHROP, Professor of Mathematics and Natural Philosophy, Hamilton College, Clinton, N. Y.

(Communicated for this Journal.)

IN the course of some geological speculations I recently had occasion to make, with a view to the application of the prevailing theory of the earth to the solution of some physical problems, I was led to consider its bearing on the phenomena of terrestrial magnetism.

\* The information received by the recent return of Prof. Shepard from London, places this beyond a doubt. Nov. 13, 1839.

By the *theory of the earth*, I mean that theory which supposes the present condition of our globe to be the result of a primitive solution of its materials by caloric and a subsequent cooling process; by far the greater portion of the earth being still in a state of fusion, with an external solid crust of some forty or fifty miles in thickness.

With the direct evidence of the truth of this theory, the readers of the *Journal of Science* are of course well acquainted. Passing by this direct evidence, and the other numerous and satisfactory applications of the theory to the solution of physical problems, I propose in this paper to confine my remarks to the bearings of the theory on the phenomena connected with the variation of the declination of the needle.

The observations of two or three centuries past demonstrate, as is well known, the gradual westerly motion of the line of no declination, at a rate which if uniform will complete an entire revolution in about seven hundred years. The variations in the position of the horizontal and dipping needles at any point on the earth's surface, are doubtless dependent on the same physical causes, and have a like period.

Without going at all into the question of the *nature* of the magnetic forces, it is a truth which we may take for granted in the outset, that the position of the magnetic line at any place, (that is, the position of the magnetic needle freely suspended by its centre of gravity,) is the result of the combined action of all the magnetic forces in the mass of the earth, whatever the nature of these forces may be. This combined action may on familiar dynamical principles be resolved into the two sets of magnetic forces, namely, those contained in the solid crust of the earth, and those exerted by the internal fluid mass. Considering the former set by themselves, the needle freely suspended would take the direction of the resultant (A) of all the magnetic influences in the solid crust. Considering the latter set by themselves, the needle would take the direction of the resultant (B) of all the magnetic influences in the internal fluid mass. The actual position of the dipping needle at any given time and place, is in the direction of the diagonal between these two resultants.

Now adopting for the present as true, the hypothesis that the internal fluid mass has in reference to the external crust a westerly revolution once in about 700 years, it would seem that all

the observed consequences relative to the secular motions of the needle must of necessity follow. For the resultant (A) relatively to the observer at any place being a fixed line, the resultant (B) is movable, partaking as it must do of the westerly motion of the internal mass. If then we describe a vertical circle through the place of observation in the direction of the resultant (A) the plane of this magnetic vertical is fixed, and twice during each revolution of the fluid mass must the resultant (B) be found in this plane. Commencing with its higher position in this plane, it will pass westerly to its greatest elongation, thence easterly to its lower conjunction with the magnetic vertical, thence to its greatest easterly elongation, thence westerly to its original position. It is obvious that the needle freely suspended by its centre of gravity, taking the direction of the diagonal between the two resultants, will follow these motions of the resultant (B). Leaving the magnetic vertical at its minimum dip, passing to its greatest westerly declination, thence in its easterly progress passing said vertical at its maximum dip to its greatest declination on the other side, thence to the place of beginning. The pole of the dipping needle would thus describe a curve returning into itself, with a period equal to that of the supposed westerly revolution of the internal mass, and the secular motions of the horizontal needle in its arc of declination would have the same period.

It is obvious that if the magnetic poles of the external crust and of the internal fluid mass, were coincident with the pole of revolution, there would be no departure of the dipping or the horizontal needle from the plane of the meridian. As this coincidence does not exist in fact, the position of the magnetic pole of the solid crust will be determined by the intersection of magnetic verticals for different places, the position of such vertical at any place being determined by passing its plane through the needle when its dip is at a maximum or minimum. One only of these verticals will pass through the poles of revolution and coincide with a terrestrial meridian; and of course in all places situated on this meridian, the dip of the needle will be at a maximum or a minimum when the direction of the needle is due north and south. In all other places on the earth's surface, there will be an easterly or westerly declination of the needle when the dip is at a maximum or minimum.

Thus admitting a westerly revolution of the internal fluid mass, results analogous to observed magnetic phenomena would seem of necessity to follow.

The question then returns upon us—Does the theory of the earth require, as a necessary physical consequence, a westerly revolution of the internal fused mass?

It is a fact noticed by La Place, and indeed one of easy demonstration, that on the supposition of a gradual cooling process and a consequent diminution of the earth's radius by contraction, the diurnal revolutions of the earth would gradually become more rapid, that is, the length of our day would be gradually diminishing. Every particle of a revolving sphere, on falling towards the axis by a general contraction, tends, by preserving its absolute velocity, to a more rapid angular motion, and the period of revolution for the whole mass must be inevitably diminishing. In the case of the earth, it is true that astronomy has not detected any change in the length of our day—a fact by no means incompatible with the existence of such a change; for in the first place the extreme accuracy which now marks astronomical observations is comparatively of modern date; and secondly it is stated as the result of calculation that a contraction of the radius of the internal fused mass of one twenty fifth of an inch in a century would be sufficient to account for all the results of volcanic action at the present age of the world. That astronomy has been unable to detect the minute acceleration of the diurnal motion which has accrued since men began to converse with the stars on the plains of Chaldea, constitutes therefore no valid objection to the truth of a geological theory involving such a result. Improved methods, exact and long continued observations, will doubtless make astronomy a competent witness on this point in time to come. If the theory of the earth be true, it must be admitted as a necessary physical consequence, that the length of the day is diminishing; though the decrement at this age of the world may be inappreciable from century to century, and the records of astronomical science may as yet furnish no evidence of the fact of such diminution.

But this tendency to increased angular motion arising from contraction, must obviously be greatest in those portions of the mass of the earth which have contracted most, and least in those parts which have contracted least. Now the earth having been,

on the principles of the theory, subjected to a gradual cooling process, it is quite manifest that the contracting influences have had their principal seat of action on and near the surface, while in the interior their operation has been comparatively feeble. We seem therefore to be shut up to the conclusion, that the motion of the solid crust about the axis has been more accelerated by the cooling and contracting processes than that of the internal fused mass—that the angular velocity of the former is more rapid than that of the latter—that the latter as a whole is gradually falling back of the former. In other words, considering the solid crust as fixed relatively to the observer, there is a gradual westerly revolution of the internal fused mass.

Thus admitting the prevailing theory of the earth, we infer, as a necessary physical consequence, a westerly revolution of the internal mass; and admitting the western revolution of the internal mass, the observed secular motions of the horizontal and dipping needles would seem of necessity to follow.

In looking back on the attempts which have been made to assign the physical causes of the variation of the declination of the needle, it is curious to remark how completely the theory under consideration embodies the hypothesis of Halley; who supposed the earth to have four magnetic poles, two fixed and two movable. Regarding the resultant of the magnetic forces of the solid crust as indicating the two fixed poles, we have the two movable poles of Halley indicated by the resultant of the magnetic forces of the internal fluid mass. The hypothesis of Halley may well be set down as an instance of that grasp of mind with which "men before their time" seize upon truths, which it may require centuries of investigation fully to develop and demonstrate.

It will be observed that in this paper I have confined my remarks to the connexion between the theory of the earth and the *secular* motions of the magnetic line. I propose to make the bearing of the theory on the *subordinate* oscillations of the needle the subject of a future communication.

Hamilton College, Sept. 1839.

ART. XII.—*Notices of Tornadoes, &c.* ; by ROBERT HARE, M. D.,  
Professor of Chemistry in the University of Pennsylvania.

I. *Account of a Tornado, which passed over Providence, and the  
Village of Somerset, R. I., in August, 1838.\**

I PROPOSE to lay before the Society, for a place in their Transactions, an account of a tornado which occurred in the state of Rhode Island, towards the end of August last.

This phenomenon was first observed near Providence, over the south-western suburbs of which it passed in a course generally from west by north, to south by east. Only a few days subsequently I visited some of the most remarkable scenes of its ravages.

The characteristics of this tornado, from all that I could see or hear, are quite similar to those of the tornado which occurred at New Brunswick, N. J. in June, 1835, and to which I referred in my paper upon the causes of tornadoes and water-spouts, published in the sixth volume of the Society's Transactions.

This recent tornado was advantageously seen by J. L. Tillinghast, Esq. from a window of his mansion, which is so situated, on the brow of a hill on the eastern side of the city of Providence, as to afford an unobstructed view of the country opposite. Mr. Tillinghast alledges that his attention was at first attracted by seeing to the westward a huge inverted cone, of extremely dark vapor, which extended from the clouds to the earth. In the contortions and spiral movements of its lower extremity, this cone was conceived to resemble the proboscis of an enormous elephant, moving about in search of food. Sometimes it was elongated so as to reach the ground; at others it skipped over the intervening space without touching it; but at each contact with the terrestrial surface or bodies resting thereon, a cloud of dust intermingled with their fragments, was seen to rise within the vortex. To those who were sufficiently near to the meteor, a fearful explanation of these appearances was simultaneously evident. Ponds were partially exhausted. Trees uprooted or deprived of their leaves or branches. Houses were unroofed, or uplifted and then dashed to pieces. Farms were robbed of their grain, potatoes,

---

\* From the Transactions of the American Philosophical Society.  
Vol. xxxviii, No. 1.—Oct.—Dec. 1839.

fruit trees or poultry : nor were human beings secure from being carried aloft, and more or less injured by subsequent descent. It was alledged that at Somerset two women were carried from a wagon over a wall, into an adjoining field. Within the same village a cellar door frame, with its doors bolted, was lifted, and then deposited on one side of its previous position ; although situated to windward of the mansion to which it belonged. This result was the more striking, because, in consequence of their presenting an inclined plane to the blast, the doors and their frames would have been pressed more firmly upon their foundation by an ordinary wind. In consequence of the same dilatation of the air within the house, which lifted the cellar door, the weatherboarding on the leeward side was burst open, while that to the windward was undisturbed.

About four o'clock on the afternoon during which this tornado passed near Providence, there was heard at the farm at which I resided, twenty-five miles south of Providence and about fifteen miles from Somerset, the loudest thunder which I ever experienced. It made the house in which I was tremble sensibly.

I have received from an estimable friend, Mr. Allen, a most interesting account of this tornado, which passed over the river, and there produced the appearance of a water-spout, while he was sufficiently near for accurate observation. In one respect his narrative tends to justify my opinion, that the exciting cause of tornadoes is electrical attraction. In two instances in which flashes of lightning proceeded from the water, Mr. Allen remarked that the effervescence produced by the tornado in the water very perceptibly subsided.\*

*Extract from a Letter written by Zachariah Allen, Esq., of Providence.*

“ It was about three o'clock, P. M., during a violent shower, that I observed a peculiarly black cloud to form in the midst of light, fleecy clouds, and to assume a portentous appearance in the heavens, having a long, dark, tapering cone of vapor extending from it to the surface of the earth. The form of this black cloud, and of the cone of vapor depending from it, so nearly resembled

---

\* See Essay on the Cause of Tornadoes or Water-spouts in sixth vol. American Philosophical Transactions, or in Silliman's Journal, vol. 32, for 1837.



the engraved pictures of 'water spouts' above the ocean, which I had frequently seen, that I should have come speedily to the conclusion that one of these 'water spouts' was approaching, had I not been aware that this phenomenon occupied a space in the heavens directly over a dry plain of land. Whilst attentively watching the progress of the cloud, with its portentous dark cone trailing its point in contact with the surface of the earth, I noticed numerous black specks, resembling flocks of blackbirds on the wing, diverging from the under surface of the clouds, at a great elevation in the air, and falling to the ground. Among these were some objects of larger size, which I could discern to be fragments of boards, sailing off obliquely in their descent. This alarming indication left no room for doubt that a violent tornado was fast approaching, and that these distant, dark specks were fragments of shingles and boards uplifted high in the air, and left to fall, from the outer edge of the black conical cloud. This fearful appearance was repeatedly exhibited, as often as the tornado passed over buildings.

"The whirlwind soon swept towards an extensive range of buildings, within a few yards of me, the roof of which appeared to open at the top, and to be uplifted for a moment. The whole fabric then sunk into a confused mass of moving rubbish, and became indistinctly visible amid the cloud that overspread it, as with a mantle of mist.

"The destructive force of the tornado now became not only apparent to the eye, but also fearfully terrific, from the deafening crash of breaking boards and timbers, startling the amazed spectator in alarm for his personal safety, amid the roar of the whirlwind, and the shattered fragments flying like deadly missiles near him. At one instant, when the point of the dark cone of cloud passed over the prostrate wreck of the building, the fragments seemed to be upheaved, as if by the explosion of gunpowder, and I actually became intensely excited with the fear that the moving mass might direct its march towards the open area of the yard, to which I had resorted, after abandoning a building in which I had previously found shelter.

"Fortunately the course of the tornado was not over the building used as a depot by the Stonington Rail-road Company in Providence, where there was a numerous assemblage of passengers awaiting the departure of the cars; otherwise several lives might have been lost.

“The most interesting appearance was exhibited when the tornado left the shore, and struck the surface of the adjacent river. Being within a few yards of this spot, I had an opportunity of accurately noting the effects produced on the surface of the water.

“The circle formed by the tornado on the foaming water was about three hundred feet in diameter. Within this circle the water appeared to be in commotion, like that in a huge boiling cauldron; and misty vapors, resembling steam, rapidly arose from the surface, and entering the whirling vortex, at times veiled from sight the centre of the circle, and the lower extremity of the overhanging cone of dark vapor. Amid all the agitation of the water and the air about it, this cone continued unbroken, although it swerved and swung around, with a movement resembling that of the trunk of an elephant whilst that animal is in the act of depressing it to the ground to pick up some minute object. In truth, the tapering form, as well as the vibrating movements of the extremity of this cone of vapor, bore a striking resemblance to those of the trunk of that great animal.

“Whilst passing off over the water, a distant view of the cloud might have induced the spectator to compare its form to that of a huge umbrella suspended in the heavens, with the column of vapor representing the handle, descending and dipping into the foam of the billows. The waves heaved and swelled, whenever the point of this cone passed over them, apparently as if some magical spell were acting upon them by the effect of enchantment. *Twice I noticed a gleam of lightning, or of electric fluid, to dart through the column of vapor, which served as a conductor for it to ascend from the water to the cloud. After the flash the foam of the water seemed immediately to diminish for a moment, as if the discharge of the electric fluid had served to calm the excitement on its agitated surface.*

“The progress of the tornado was nearly in a straight line, following the direction of the wind, with a velocity of perhaps eight or ten miles per hour.

“Near as I was to the exterior edge of the circle of the tornado, I felt no extraordinary gust of wind; but noticed that the breeze continued to blow uninterruptedly from the same quarter from which it prevailed before the tornado occurred.

“I also particularly observed that there was no perceptible increase of temperature of the air adjacent to the edge of the whirlwind, which might have caused an ascending current by a rarefaction of a portion of the atmosphere. After passing over the sheet of water, and gaining the shore, I observed the shingles and fragments of a barn to be elevated and dispersed high in the air; and the dark cloud continued to maintain the same appearance which it at first presented, until it passed away beyond the scope of a distinct vision of its misty outlines.

“The above imperfect sketch can convey to your mind only a feeble impression of this exciting scene, which in passing before me excited just enough of terror to impart to the spectacle the most awful sense of the power, sublimity and grandeur of the Almighty, as described in the glowing words of the Psalmist. ‘He bowed the heavens also, and came down; and darkness was under his feet; and he did fly upon the wings of the wind. He made darkness his secret place; his pavilion round about him were dark waters and thick clouds of the skies.’”

## II. At Chatenay, near Paris.

To the Editors of the National Gazette.

*Messrs. Editors*—You had published a memoir on tornadoes by a distinguished foreigner, Ørsted. Conceiving the impression conveyed by that article less worthy of consideration than those which had been presented in a memoir which I had previously published, I hope that I shall be considered as having had a sufficient incentive for endeavoring through the same channel to correct the erroneous impressions which that memoir was in my opinion of a nature to produce.

In my letter to you of the 26th ult. it was stated that I considered tornadoes as the consequence of an electrical discharge superseding the more ordinary medium of lightning. From an article which has since met my attention in the *Journal des Debats*, published on the 17th of July at Paris, it appears that a tremendous tornado occurred about the last of the preceding June in the vicinity of that metropolis. The losers applied for indemnity to certain insurers, who objected to pay on the plea that the policies were against thunder storms not against tornadoes. This led to an application to the celebrated Arago, who referred the case to another savant, Peltier.

From the report of Peltier, of which I subjoin a translation, it will be seen that, excepting his neglect of the co-operative influence of the elasticity of the air, he sanctions my opinion that a tornado is the effect of an electrical discharge.\*

"Yesterday," says Peltier, "I visited the commune of Chatenay in the canton of Ecoeu, department of Seine and Oise, and investigated the disasters experienced in the month of June last, from a tornado which first originated over the valley of Fontenay des Louvres. At present I can give only a summary account of this wonderful phenomenon.

"Early in the morning a thunder cloud arose to the south of Chatenay, and moved at about ten o'clock over the valley between the hills of Chatenay and those of Ecoeu. The cloud having extended itself over the valley, appeared stationary and about to pass away to the west. Some thunder was heard but nothing remarkable was noticed, when about midday a second thunder storm coming also from the south and moving with rapidity advanced towards the same plain of Chatenay. Having arrived at the extremity of the plain above Fontenay, opposite to the first mentioned thunder cloud, which occupied a higher part of the atmosphere, it stopped at a little distance, leaving spectators for some moments uncertain as to the direction which it would ultimately take. That two thunder clouds should thus keep each other at a distance, led to the impression that being charged with the same electricity, they were rendered reciprocally repellent, and that a conflict would ensue in which the terrestrial surface would play an important part. Up to this time there had been thunder continually rumbling within the second thunder cloud, when suddenly an under portion of this cloud descending and entering into communication with the earth, the thunder ceased. A prodigious attractive power was exerted

---

\* I had presented copies of the pamphlet containing my memoir to M. Arago and several other members of the Institute. In a subsequent conversation he referred to some of the suggestions which it contained. As it conveyed a view of the question decisively favorable to the claimants, it may be inferred that it must have been alluded to by Arago and thus have become the source of Peltier's impressions. It may therefore be anticipated that due acknowledgment will be hereafter made by him when he realizes his promise of making a more elaborate report on the tornado of Chatenay. Before entering upon the arguments by which I sustained my hypothesis it was briefly stated in the following words: "*After maturely considering all the facts I am led to suggest that a tornado is the effect of an electrified current of air superseding the more usual means of discharge between the earth and clouds, in those vivid sparks which we call lightning.*"

forthwith, all the dust and other light bodies which covered the surface of the earth mounted towards the apex of the cone formed by the cloud. A rumbling thunder was continually heard. Small clouds wheeled about the inverted cone rising and descending with rapidity. An intelligent spectator, M. Dutour, who was admirably placed for observation, saw the column formed by the tornado terminated at its lower extremity by a cap of fire ; while this was not seen by a shepherd, Oliver, who was on the very spot, but enveloped in a cloud of dust.

“To the southeast of the tornado, on the side exposed to it, the trees were shattered, while those on the other side of it preserved their sap and verdure. The portion attacked appeared to have experienced a radical change, while the rest were not affected. The tornado having descended into the valley at the extremity of Fontenay, approached some trees situated along the bed of a rivulet, which was without water though moist. After having there broken and uprooted every tree which it encountered, it crossed the valley and advanced towards some other trees, which it also destroyed. In the next place, hesitating a few moments as if uncertain as to its route, it halted immediately under the first mentioned thunder cloud. This although previously stationary, now began as if repelled by the tornado, to retreat towards the valley to the west of Chatenay. The tornado after stopping as I have described, would infallibly on its part, have moved on towards the west to a wood in that direction, if the other thunder cloud had not prevented it by its repulsion. Finally it advanced to the park of the castle of Chatenay, overthrowing every thing in its path. On entering this park, which is at the summit of a hill, it desolated one of the most agreeable residences in the neighborhood of Paris. All the finest trees were uprooted, the youngest only, which were without the tornado, having escaped. The walls were thrown down, the roofs and chimneys of the castle and farmhouse carried away, and branches, tiles and other movable bodies, were thrown to a distance of more than five hundred yards. Descending the hill towards the north, the tornado stopped over a pond, killed the fish, overthrew the trees, withering their leaves, and then proceeded slowly along an avenue of willows, the roots of which entered the water, and being during this part of its progress much diminished in size and force, it proceeded slowly over a plain, and finally at the distance of more than a thousand

yards from Chatenay, divided into two parts, one of which disappeared in the clouds, the other in the ground.

“In this hasty account I have, with the intention of returning to this portion of the subject, omitted to speak particularly of its effect upon trees. All those which came within the influence of the tornado, presented the same aspect; their sap was vaporized, and their ligneous fibres had become as dry as if kept for forty eight hours in a furnace heated to ninety degrees above the boiling point. Evidently there was a great mass of vapor instantaneously formed, which could only make its escape by bursting the tree in every direction; and as wood has less cohesion in a horizontal longitudinal than in a transverse direction, these trees were all, throughout one portion of their trunk, cloven into laths. Many trees attest, by their condition, that they served as conductors to continual discharges of electricity, and that the high temperature produced by this passage of the electric fluid, instantly vaporized all the moisture which they contained, and that this instantaneous vaporization burst all the trees open in the direction of their length, until the wood, dried up and split, had become unable to resist the force of the wind which accompanied the tornado. In contemplating the rise and progress of this phenomenon, we see the conversion of an ordinary thunder gust into a tornado;\* we behold two masses of clouds opposed to each other, of which the upper one, in consequence of the repulsion of the similar electricities with which both are charged, repelling the lower towards the ground, the clouds of the latter descending and communicating with the earth by clouds of dust and by the trees. This communication once formed, the thunder immediately ceases, and the discharges of electricity take place by means of the clouds which have thus descended, and the trees. These trees, traversed by the electricity, have their temperature, in consequence, raised to such a point that their sap is vaporized, and their fibres sundered by its effort to escape. Flashes and fiery balls and sparks accompanying the tornado, a smell of sulphur remains for several days in the houses, in which the curtains are found discolored. Every thing proves that the tornado is nothing else than a conductor formed of the clouds, which serves as a passage

---

\* See 5th vol. of the American Philosophical Transactions, or Silliman's Journal for 1837, vol. 32, page 154.

for a continual discharge of electricity from those above, and that the difference between an ordinary thunder storm and one accompanied by a tornado, consists in the presence of a conductor of clouds, which seem to maintain the combat between the upper portion of the tornado and the ground beneath. At Chatenay this conductor was formed by the influence of an upper thunder cloud, which forced the lower portion of an inferior thunder cloud to descend and come into contact with the terrestrial surface."

Peltier concurs with me in the opinion that the tornado supercedes lightning by affording a conducting communication between the terrestrial surface and thunder cloud: but he conceives that the cloud by its descent becomes the conductor through which the electric discharge is accomplished: whereas agreeably to the explanation which I suggested, a vertical blast of air and every body carried aloft contributes to form the means of communication. Agreeably to this suggestion the electric fluid does not pass by conduction, but "convection," as explained in my letter of the 26th ult. That the idea of the Parisian savant that the cloud acts as a conductor is untenable, must be evident, since the light matter of which a cloud is constituted could not be stationary between the earth and sky in opposition to that upward aerial current of which the violence is proved to be sufficient to elevate not only water, but other bodies specifically much heavier than this liquid.

So much of the narrative of Peltier as relates to the repulsion between the thunder clouds, is inconsistent with any other facts on record respecting tornadoes which have come within my knowledge. It should be recollected that this part of the story does not depend upon the observation of the author, and may be due to the imagination of the witnesses whom he examined. The most important part of his evidence is that respecting the effect upon the trees, which appears to me to demonstrate that they were the medium of a tremendous electrical current.

In my memoir I noticed the injury done to the leaves of trees, and stated my conviction that "*as it was inconceivable that mechanical laceration could have thus extended itself equally among the foliage, a surmise may be warranted that the change was effected by electricity associated with the tornado.*"

III.—On Tornadoes, and *Ærsted's* Memoirs respecting them.

To the Editors of the National Gazette.

*Dear Sirs,*—I believe it is generally admitted by electricians that the enormous discharges of the electric fluid, which, during thunder gusts, take place in the form of lightning, are the consequence of the opposite electrical states of an immense stratum of the atmosphere coated by the thunder clouds, and a corresponding portion of the terrestrial surface. In a memoir published in the 5th volume of the American Philosophical Transactions, republished in Silliman's Journal, vol. 32, for 1837, I had endeavored to show that the tornado was the consequence of the same causes producing in lieu of lightning, an electrical discharge by a vertical blast of air, and the upward motion of electrified bodies. In your Gazette of the 30th ult., you have republished an article by the celebrated *Ærsted*, in which it is alledged that tornadoes or water-spouts cannot be caused by electricity, because there is no evidence proving that persons exposed to them have experienced electrical shocks. To me it appears evident that the scientific author confounds the different processes of discharge to which I have alluded, the one occurring in thunder gusts, the other in tornadoes; also that he has forgotten that a shock can be given neither by a blast of electrified air, nor by a continuous electrical current, a transient interruption of the circuit being indispensable to the production of the slightest sensation of that nature. If a person, having a conducting communication between one of his hands and a charged surface of a well insulated battery, hold in the other hand a pointed wire, the battery will be discharged through him and through the wire, producing a blast of electrified air from the point, without his experiencing any shock; neither would a shock be given to any person by exposure to the blast thus produced.

This form of electrical discharge to which I ascribe tornadoes, in which electricity is conveyed from one surface to another by the motion of air or other movable bodies intervening, is by Faraday designated as "*convection*," from the Latin "*conveho*," to carry along with.

In the comparatively minute experiments of electricians, the process of convective discharge, is exemplified not only by the electrified aerial blast, but likewise by the play of pith balls, the



dance of puppets, or the vibration of a pendulum, or bell clapper. The passage of sparks is found to arrest or to check such movements, and in like manner the passage of lightning has been observed to mitigate the vertical force of a tornado.

While a meteor of this kind, which passed over Providence last year, was crossing the river, the water, within an area of about three hundred feet in diameter, was found to rise up in a foam, as if boiling. Meanwhile two successive flashes of lightning occurring, the foam was observed to subside after each flash. It is thus proved that a discharge by lightning, is inconsistent with the discharge by convection, and that so far as one ensues, the other is impeded.

In an account of a tremendous storm of the kind of which I have been treating, published in Silliman's Journal for July last, it is mentioned that at its commencement it was only a violent thunder gust. This is quite consistent with the experience acquired by means of our miniature experiments, in which a discharge by sparks may be succeeded by a discharge by convection, or vice versa; or they may prevail alternately. In one case the electric fluid passes in the gigantic sparks called lightning, in the other it is conveyed by a blast of electrified air. In the former case, animals are subjected to deleterious shocks, while in the latter no other injury is sustained than such as results from collision with the air, or other ponderable bodies.

In the case of the tornado, the vertical blast is accelerated by the difference between the pressure of the air at the earth's surface, and at the altitude to which the blast extends. Should this be a mile there would be a difference nearly of one hundred and forty four pounds per square foot. During the tremendous gale which prevailed at Liverpool last winter, the greatest pressure of the wind was estimated at only thirty pounds per square foot. So far as the ingenious inferences and observations of Mr. Espy, as to the buoyancy resulting from a transfer of heat from aqueous vapor to air hold good, the vertical force so alledged to arise, will co-operate to aid the influence of electric discharges by convection.

The distinguished author of the memoir alluded to at the outset of this communication, conceives that were electricity the cause of tornadoes, the magnetic needle should be disturbed by them; and without advancing any proof that such disturbance

does not take place, founds thus an objection to electrical agency. I conceive that it would be unreasonable to expect a magnetic needle to be affected by an electrified blast of air if protected from its mechanical force.

It has been shown by Faraday that without peculiar management, tending to prolong the reaction, the most delicately suspended needle cannot be made to diverge in obedience to the most powerful discharges of mechanical electricity. An electrical spark may impart a feeble magnetism, but is too rapid and transient, to affect a needle. Moreover, when a needle is at right angles to an electric current which would be quite competent to influence it if parallel to it, there can be no consequent movement, since the current tends to keep it in that relative position. The direction of every electrical discharge inducing a tornado must necessarily be nearly at right angles to the needle, since it must be vertical, while the needle is necessarily horizontal when so supported as to traverse with facility.

I do not perceive any facts or suggestions in the article by *Ørsted*, which are competent to render the phenomenon of which he treats more intelligible than it was rendered by the accurate survey and examination of the track of the New Brunswick tornado, by Pres. A. D. Bache, and Mr. Espy, in connexion with the accounts published by other witnesses of that and other similar *météors*.

It seems to be admitted on all sides, that within a certain space there is a rarefaction of air tending to burst or unroof houses; that the upward blast consequent to this rarefaction, carries up all movable bodies to a greater or less elevation; and that an afflux of air ensues from all quarters to supply the vacuity which the vertical current has a tendency to produce. Trees within the rarefied area are uprooted and sometimes carried aloft, but on either side of it, or in front, or in the rear, are prostrated in a direction almost always bearing towards a point which during some part of the time in which the meteor has endured has been under the axis of the column which it formed.

It appears to me that all the well authenticated characteristics enumerated by *Ørsted*, are referable to the view of the case thus presented. This distinguished author assumes that there is a *whirling* motion, although between American observers, this is a debated question. It seems in the highest degree probable that

gyration does take place occasionally, if not usually, since in the case of liquids rushing into a vacuity, a whirlpool is very apt to ensue. But as slight causes will in such cases either induce or arrest the circular motion, such movements may be contingent. It would however appear probable that when gyration does exist, it may, by the consequent generation of a centrifugal force, tend to promote or sustain the rarefaction and thus contribute to augment the force, or prolong the duration of a tornado.

From observations made upon the track of the recent tornado at New Haven, I am led to surmise that there was more than one axis of gyration and vertical force. I conceive that in consequence of the diversities in the nature of the bodies or the soil, there was a more copious emission of electricity from some parts of the rarefied area than others. In two instances wagons with iron wheel tires and axles, were especially the objects of the rage of the elements. Trees equally exposed were unequally affected, some being carried aloft, while others were left standing. The area of a tornado track may be more analogous to a rough surface than a point, and the electricity may from its well known habits, be given off only from such bodies as are from their shape or nature most favorable to its evolution.

Since these inferences were made, I have observed in Reid's work upon storms, that similar impressions were created by facts observed during a hurricane at Mauritius, in 1824. It was remarked that narrow, tall and decayed buildings, ready to tumble into ruins, escaped at but little distance from new houses, which were overturned or torn into pieces. It was inferred there were local whirlwinds, subjecting some localities to greater violence than others in the vicinity. In the case of other hurricanes similar facts have been noticed.

It may be expedient here to subjoin, that I consider a hurricane as essentially a tornado, in which an electric discharge by "*convection*," associated with discharges in the form of lightning, takes place from a comparatively much larger surface. In the case of the hurricane, however, the area of the track is so much more extensive, that the height of the vertical column to the diameter of the base being proportionably less, there is necessarily a modification of the phenomena, which prevents the resemblance from being perceived. In the case of the hurricane, the column is too broad to come within the scope of a human eye.

So much has lately been presented to the public, either through the newspapers, journals, or lectures, which I consider demonstrably incorrect, that I can hardly, consistently with my love of true science, remain an inactive observer of the consequent perversion of the public mind. Unfortunately it is difficult if not impossible to discuss such subjects without a resort to language and ideas, which are too technical and abstruse for persons who have not made chemistry and electricity an object of study. I have however prepared a series of essays, in which the causes of storms are stated, agreeably to my view of this important branch of meteorology.

---

ART. XIII.—*On the Silurian System, with a Table of the Strata and Characteristic Fossils*; by T. A. CONRAD.

THE geological structure of the territory of the U. States is beginning to be fairly understood, through the active exertions of the State geologists. We no longer confine ourselves to the vague terms of transition and grauwacke, but are aware that many distinct formations have been so designated. Prof. Eaton has long since given names to some of these, which have been found useful, and would have been much more so, had the fossils been collected in sufficient numbers, and with great care to preserve their stratigraphical relations. But this is a work of time and labor, and could not be expected of an individual who had other duties to perform, and at a period when the transition with its beautiful fossils, and other most interesting history were almost wholly neglected even in Europe? Taking a glance at the geology of the United States, we find the Silurian system of Murchison spread over the greater portion of New York, Ohio, Indiana, Kentucky, and Tennessee, and terminating on the south in the mountainous or rather hilly region of North Alabama. In the vicinity of Florence and Tusculumbia we find the Oriskany sandstone, (as designated in the New York reports,) a rock very easily recognized by its casts and impressions of large brachiopodous bivalves, quite unlike, as a group, to any fossils above or below them. In Europe, a rock termed old red sandstone separates the Silurian from the carboniferous systems, and fortunately I have detected the same rock, and with its

*characteristic fossil*, the scales of a fish termed *Holoptychus nobilissimus*, figured in Murchison's work on the Silurian system. This rock not only holds precisely the same place between the coal and the Silurian rocks, and contains the same characteristic fossil, but is the same in color and mineral character, as the old red sandstone of England. It occurs on the rail-road near Blossburg, Tioga county, Pennsylvania, whence I received a fine specimen last spring. The carboniferous system is also well developed in this country, but the mountain limestone is rare and in thin depositions generally. The fossils, however, are numerous and well characterized in the shales and ironstone nodules. The next succeeding formation or system, the new red sandstone, is very limited, and above it we find no trace of that interesting series of rock, the oolites, lias, wealden, &c., but the cretaceous rocks are widely distributed. Finally, the tertiary formations, corresponding to the eocene, and older and newer pliocene, stretch along nearly the whole of the seaboard. I have lately ascertained that the eocene or lower tertiary occurs in the bluff at Natchez, Mississippi. The various formations, from the coal inclusive to the top of the series, have been found to correspond with those in Europe in a remarkable manner. It remains now to determine how far the correspondence between the subdivisions of the English and American Silurian rocks can be determined. As I have lately examined the splendid work of Murchison with this view, it may be interesting to geologists to learn the result, although it is necessarily as yet but an imperfect view of this important subject. Beginning, therefore, with the Llandeilo flags, I will observe that this formation in the New York geological reports was compared to the Trenton limestone, but since the examination of Murchison's work I find that the Llandeilo rocks are characterized by two species of trilobites which are extremely rare in this country, and although they occur in the Trenton limestone, I cannot but consider them as evidence that the Llandeilo rocks have been thinly deposited and subsequently swept away.

#### *Caradoc Sandstone.*

This appears to correspond with the celebrated limestone of Trenton Falls, known by the name of Trenton limestone, which occurs in many places in the northeastern portion of New York and in Canada, and passing under the upper Silurian rocks, reäp-

pears at Cincinnati, Columbus, and other places in Ohio, and terminates on the south in Tennessee. It occurs at Bedford Springs and other localities in Pennsylvania. It is a singular fact, and may be the means of lessening the faith of some geologists in the value of organic remains, that the well known trilobite, *Calymene Blumenbachii* is not known to occur in the Caradoc sandstone, but is here characteristic of the Trenton limestone. But we regard groups, not a single species, in comparing rocks of distant localities, and it will be found that such discrepancies occur in other formations without ever being in amount sufficient to create confusion and prevent comparison. There is one fossil figured by Murchison as a Caradoc species, which here lies immediately below the Wenlock shale. This arrangement would embrace Salmon river sandstones and shales and the Niagara sandstones, two very distinct formations, in the same division, whence I infer that the Salmon river rocks are wanting in Wales, and the Niagara sandstone very rarely present, which brings the *Pentamerus* rock in contact with the Caradoc sandstone. Traces of the Niagara sandstone in Wales may be recognized by the occurrence of *Agnostus latus*, (nob.) and *Planorbis trilobatus*, (*Bellerophon*, Sow.) which belong exclusively to this formation. It is remarkable that the Caradoc rocks should consist of sandstone in Wales, whilst the Trenton limestone and slate form so prominent a feature of the series in this country. Had it been otherwise, a more extended correspondence would probably have occurred between the fossil groups on each side of the Atlantic.

#### *Wenlock Shale.*

This formation is clearly identified with the shale of Rochester, (calciferous slate, Eaton.) It contains in considerable abundance, the *Asaphus limulus*, Green, (*A. longicaudatus*, Murch.) *Trimerus delphinocephalus*, so common in this shale, is said to occur in the Wenlock limestone, but to characterize the Ludlow formation in Wales, whilst here it has never been found above the Rochester shale; it is, therefore, a curious instance of a species having been preserved in one region after it had been destroyed in another, like the *Calymene Blumenbachii*.

#### *Wenlock Limestone.*

This is represented by a series of limestones admirably developed in the Helderberg mountain, of which I have noticed six,

distinguished by different groups of organic remains. They probably occupy more surface throughout the Union than any other fossiliferous rocks.

*Ludlow Rocks.*

These have not yet been subdivided, and they can only in a general way be compared with Murchison's group. The organic remains are in great numbers and variety, and are very unlike those of the lower Silurian rocks.

The following table is given in order to correct some errors in that published in the New York reports, and to show the relative position of certain fossils which may be regarded as characteristic species. Though the table is necessarily incomplete, great care has been taken to render it correct as far as it goes, and I trust it will be found to convey a novel view of the wonderful variety of strata, each with its peculiar organic remains, which compose the Silurian system.

OLD RED SYSTEM.

<i>Formations.</i>	<i>Characteristic Fossils.</i>
Old red sandstone, } (Blossburg, Pa.)	Holoptychus nobilissimus.

SILURIAN SYSTEM.

<i>Formations.</i>	<i>Characteristic Fossils.</i>	
22. Sandstone and shales of Cazenovia, &c.	{ Dipleura Dekayi, Cryphæus Greenii, Pterinea fasciculata, Cyrtoceras maximum, C. giganteum, Orththis orbiculatus, Orthoceras pyriforme, and many unnamed bivalves.	Ludlow rocks.
21. Shales of Moscow and Lake Erie,	{ Atrypa aspera, A. concentrica, Delthyris granulosa, Cryphæus calliteles.	
20. Onondaga limestone,	{ Atrypa nasuta, Delthyris, two species, (new,) Asaphus seleneurus.	Wenlock limestone.
19. Oriskany sandstone,	{ Atrypa elongata, Delthyris arenosa; other large bivalves.	
18. Sandstone of Clarks-ville, Helderberg,	{ A large Orthoceras, Pterinea, (bilobite,) Calymene platys.	
17. Limestone of Clarks-ville,	{ Pileopsis tubifer.	
16. Sandstone,	{ Fucoides cauda-galli.	
15. Blue limestone,	{ Delthyris, (new.)	
14. Shaly limestone, Catskill creek,	{ Trilobites, (two new genera,) Delthyris macropleura, Pileopsis? (ventricore,) Atrypa, (two species,) Strophomena costellata.	
13. 2d Pentamerus lime-stone,	{ Pentamerus (Atrypa) galeatus, Atrypa lacunosa.	
12. Water limestone,	{ Tentaculites annulatus, Delthris, (new,) Orththis, (new,) various univalves unnamed; Cytherina, a large species.	

11. Gypseous shales,	Eurypterus remipes.	} Wenlock shale.
10. Lockport limestone,	Catenipora, (new.)	
9. Rochester shale,	Asaphus limulurus, Platynotus, Trimerus delphinocephalus, Orthis elegantula, Strophomena transversalis, Caryocrinus.	
8. 1st Pentamerus limestone,	Pentamerus oblongus.	} Caradoc sandstone.
7. Green slate and iron ore, Top stratum.	Agnostus latus, Strophomena corrugata, Tentaculites parvus. Dictyoites Beckii.	
6. Niagara sandstone,	Fucoides Harlani, Lingula cornea.	
5. Olive sandstone and shale of Salmon river,	Pterinea carinata, Cyrtolites ornatus.	
4. { Black slate, Trenton limestone,	Triarthrus Beckii, Graptolites or Fucoides dentatus. Orthis testudinaria, O. callactis, Strophomena sericea, S. deltoidea, Calymene Blumenbachii, C. micropleura, Cryptolithus, Isotelus.	
3. Sparry limestone,	Fucoides demissus.	
2. Mohawk limestone,	Orthostoma communis.	
1. { Calciferous and Potsdam sandstone,	Lingula cuneata.	
Hudson slates,	Graptolites, (Fucoides serra.)	

*Species common to the Silurian rocks of Wales and the United States.*

LUDLOW ROCKS.

*Shells.*

Cyrtoceras (Phragmoceras) giganteum,  
Orthoceras pyriforme,  
Bellerophon expansus,  
Orthis orbicularis.

WENLOCK LIMESTONE.

*Corals.*

Cyathophyllum ceratites,  
helianthoides,  
turbinatum,  
dianthus,  
Catenipora escharoides,  
Favosites fibrosa,  
spongites,  
gothlandica.

*Shells.*

Tentaculites annulatus,  
Strophomena euglypha,  
rugosa,  
(Leptæna depressa, Sow.)  
Pentamerus galeatus,  
(Atrypa galeata, Dalm.)  
Atrypa prisca,  
(affinis, Sow.)  
aspera,  
lacunosa,  
tenuistriata,  
bidentata,

*Trilobites.*

Calymene bufo,  
(C. macrophthalma),  
Asaphus limulurus.\*

\* This appears to be the same with Murchison's *A. longicaudatus*, and is very distinct from the true *caudatus*, which has not I believe been found in New York; I have received from Dr. William Fleming, of Manchester, fine specimens of the latter in limestone, from Dudley. The former is common in the Rochester shales, and I have not seen it from any other formation. I also received from Dr. Fleming a specimen of *A. limulurus*, from Dudley.



## WENLOCK SHALE.

<i>Shells.</i>	<i>Trilobite.</i>
Strophomena transversalis, (Leptæna, Sow.)	Asaphus limulurus, (Wetherilli, Green.)
Orthis elegantula, (canalis, Sow.) hybrida,	(longicaudatus, Murch.)
Delthyris lineatus.	

## CARADOC SANDSTONE.

<i>Shells.</i>	<i>Trilobites.</i>
Strophomena alternata, sericea, (Leptæna, Sow.)	Cryptolithus tessellatus,* (Trinucleus caractaci, Murch.)
Orthis testudinaria, callactis, flabellulum,	Calymene micropleura, (Asaphus micropleurus, Green.) (Calymene punctata, Murch.)
Bellerophon acutus.	

*Observations on the Plastic Clay.*

There appears to be some difference of opinion respecting the relative position of this formation in the United States; by some geologists it is included in the secondary or cretaceous series, and by others in the lower tertiary, corresponding in position to the plastic clay of England. I have examined specimens from both countries, and the only difference I can perceive, is the more unctuous or glossy appearance of the English specimens. If of the same age, it is remarkable that a tertiary deposit should extend such a distance, and preserve its mineral character and its variegated appearance so perfectly as it does, or rather that the conditions for its deposition were so much the same in both countries in the same era. But this resemblance will not alone establish the relationship of the American with the plastic clay of Europe, and fossils we have none, whereby to institute a comparison. In Maryland and Virginia the lower fossiliferous tertiary rests either on the primary or cretaceous rocks, and has never been found re-

---

\* Mr. Murchison thinks his species different from the tessellatus, in consequence of having long spinous processes to the buckler; but in this respect there is no difference between specimens in Wales and at Glenn's Falls, in New York, where I found them abundantly. The original specimens examined by my friend Dr. Green, were very imperfect, which accounts for the incomplete description of that accurate observer. I cannot omit to pay a passing tribute of praise to the zeal, industry and talent, which have put us in possession of a monograph of the trilobites, illustrated by models, that have greatly facilitated the labors of geologists, and stimulated inquiry into the history of Transition remains.

posing on a stratum similar to that termed plastic clay, whilst this latter is found at a short distance, towards the primary boundary. I do not say that it may not occur beneath the fossiliferous beds of the lower tertiary, although it has never been found in this relative position, but in the vicinity of Piscataway, Maryland, it reposes on the latter strata, and forms the hills around, whilst the tertiary fossils are found in the beds of creeks and bottoms of ravines. This clay is precisely similar to that around Baltimore, but unfortunately I could not find the lignite stratum, which characterizes the plastic clay in so many places, over a great extent of its course throughout the Union. But as that is a thin stratum, its absence must be expected in many localities of this formation. The evidence then, so far, is in favor of the opinion that this clay *overlies* the fossiliferous strata of the lower tertiary, and, therefore, does not exactly correspond in position to the plastic clay of England which underlies the beds of marine shells of the eocene period; still, they all belong to one era, and appear to have been deposited in estuaries or in fresh water in the beds of rivers near the sea. These remarks are made to call the attention of the state geologists to this subject, and it is hoped the question will soon be determined.

*Observations on the Genus Gnathodon, with description of a new species.*

Until recently, but a single species of this interesting genus was known to naturalists, the *G. cuneata*, (Gray,) an inhabitant of the estuaries of the Gulf of Mexico, and occurring in the upper tertiary formation in the bank of the Potomac river in Maryland, and on the Neuse river, North Carolina. The second species described, was found in the high bank at Yorktown, Virginia, and is only known as a fossil. The third, which I now describe, is a recent species from Florida, which I owe to the kindness of Dr. Forman of Baltimore. The three species are very distinct, and the differences may be briefly stated in the following characters.

1. *G. cuneata*. Anterior and posterior lateral teeth arched, the latter being more than twice the length of the former.
2. *G. Grayi*, (fossil.) Anterior tooth not greatly shorter than the posterior; both nearly straight.
3. *G. flexuosa*. Lateral teeth not greatly differing in length, both much shorter than in the preceding species, and rectilinear. It is a smaller species than the others.

*Gnathodon flexuosa.*

Shell triangular, rather thick, posterior extremity subrostrated ; umbonial slope obtusely carinated ; lateral teeth short and straight.

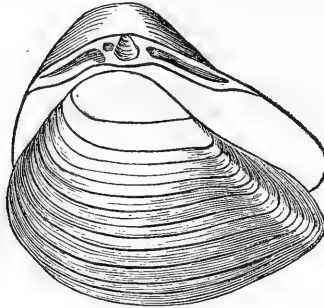

*Observations.*—I have seen only a few water-worn valves of this species, which have probably been found on the sea beach, but they are evidently recent. It will be interesting to know what estuaries in Florida contain this *Gnathodon*, and whether it accompanies the *G. cuneata*. The carinated umbonial slope is a character which widely separates it from its congeners.

---

ART. XIV.—*Abstract of the Proceedings of the Ninth Meeting of the British Association for the Advancement of Science.*

THE ninth meeting of this scientific association was held at Birmingham, during the week commencing on the 26th of August, 1839. From the extensive report of the proceedings, published in the *London Athenæum*, Nos. 618—621, we give the following abstract.

The total number of tickets issued at Birmingham was 1438. The finances of the association are prosperous. Its permanent property consists of £5500 in the three per cent. consols ; and books valued at £1094 10s.

At the General Meeting on the evening of August 26, Rev. Vernon Harcourt, President of the Association, delivered an eloquent address, in the course of which he gave an elaborate vindication of the claims of Cavendish to the scientific discoveries which have been usually attributed to him, and closed with a series of appropriate and impressive remarks on the accordance of science with Revelation.

The Marquis of Bredalbane was chosen President for the ensuing year. The next meeting will be at Glasgow, commencing on the 17th of September, 1840.

Section A. *Mathematics and Physics.*

Prof. Whewell, President of the Section, in a brief address, observed that one of the chief objects of the association was to grant sums of money to individuals or committees engaged in the pursuit of particular branches of science. Reports were then read concerning the progress of various committees in the duties assigned to them, as follows.

1. On a grant of £200, for the reduction, under the supervision of Sir J. Herschel, Mr. Airy, and Mr. Henderson, of the stars observed by Lacaille at the Cape of Good Hope, and recorded in his *Cælum Australe Stelliferum*; the committee reported "that considerable progress has been made in the reduction of the stars in Lacaille's *Cælum Australe Stelliferum*; and that, although only a small portion of the money appropriated, has been actually expended, nearly the whole will probably be required, during the ensuing year, to complete the work."

2. On a grant of £50 to defray expenses which might arise in the course of an inquiry, committed to Sir J. Herschel, Prof. Whewell, and Mr. Baily, concerning a *revision of the nomenclature of the stars* and a new distribution of the constellations; it was reported, "that some progress has been made in reforming the nomenclature of the northern constellations; and that the stars in the southern have been commenced laying down on a planisphere, according to their observed actual magnitudes, for the purpose of grouping them in a more convenient and advantageous manner. No expense has been incurred in this inquiry, but the committee are desirous that the grant should be continued for another year."

3. On a grant of £500 for the reduction of the stars in the *Histoire Céléste*, under the superintendence of Mr. Baily, Mr. Airy, and Dr. Robinson; it was reported, "that the reduction of the stars in the *Histoire Céléste* has been commenced, and already 13,000 stars have been reduced, at an expense of about £170. It is presumed that the greater part, if not the whole, of the remainder may be completed in the course of the ensuing year; and it is, therefore, expedient that the grant of money should be continued."

4. On a grant of £500, made for the purpose of *extending the Catalogue of Stars* of the Royal Astronomical Society, under the direction of Mr. Baily, Mr. Airy, and Dr. Robinson; it was reported, that about one half of the computations concerned in the extension of the Astronomical Society's Catalogue of Stars are completed, and about £180 has been expended. The whole of the remainder of the grant will probably be required within a year.

5. On a grant of £100 for the reduction, under the supervision of Sir John Herschel, of meteorological observations made at the equinoxes and solstices; it was reported, that owing to various causes, the execution of this commission had hitherto been impracticable, but it was hoped that the business might be accomplished before the next meeting.

6. On the resolution of August, 1838, requesting Sir J. Herschel and Mr. Baily to make application to the government for increase in the instrumental power of the Royal Observatory at the Cape of Good Hope, and the addition of at least one assistant to that establishment; it was reported, that application had been made, and the wishes of the association promptly and liberally complied with by the government.

7. Regarding the *Report on American Meteorology*, Pres. A. D. Bache of Philadelphia, stated to the meeting by letter, that the pressure of public duties and other causes, had thus far rendered its completion impracticable, but that he hoped to lay it before the next meeting.

8. Respecting the two *series of Hourly Meteorological Observations* kept in Scotland, Sir D. Brewster made a report, of which the following is a part: "Having fixed upon Inverness and Kingussie as two suitable stations for carrying on the two series of hourly observations which I undertook to establish and superintend for the British Association, I was fortunate in being able to prevail upon the Rev. Mr. Rutherford, of Kingussie, and Mr. Thomas Mackenzie, teacher of Raining's school, Inverness, to carry on these observations. The instruments which were necessary for this purpose, were made by Mr. Adie of Edinburgh, under the superintendence of Prof. Forbes, and the observations commenced on the 1st of November, 1838, the beginning of the meteorological year, or the first of the group of winter months. I directed the two observers to pay particular attention to the Au-

roræ Borealis, and to record every phenomenon of this nature; and I have no doubt, from the lists already sent me, that this class of observations will be the most complete and valuable that have ever been made." Accompanying this report were tables of hourly observations of the barometer and thermometer (made at Kingussie, 700 or 800 feet above sea level, by Mr. Rutherford) during the 27th, 28th, 29th, and part of the 30th of November, 1838; the barometer having gradually sunk down to the lowest, 27.200, on the 29th at 3 P. M., and risen again rapidly to its usual height after 9 A. M. of the 30th. There were also accounts of three occurrences of the Aurora Borealis, viz. on the 13th and 17th of November and 14th of December, 1838.

A paper was read *On the best positions of three magnets, in reference to their mutual action*, by Rev. H. Lloyd. It is a problem of much importance, in the arrangement of a magnetical observatory, to determine the relative position of the magnetical instruments in such a manner, that their mutual action may be either absolutely null, or at least readily calculable. Such the author stated to be the object of the present investigation. The problem may be reduced to this; to determine the position of the three magnets A, B, and C, in such a manner, that the resultant actions exerted upon A and B, respectively, by the other two, shall lie in the magnetic meridian. The solution of this problem was shown to be contained in two equations, which may, of course, be satisfied by means of two unknown angles; so that when we have a greater number of undetermined quantities, some of them remain arbitrary, and the conditions may be fulfilled in various ways. In reply to a question from the President, Mr. Lloyd briefly explained the arrangement of the *portable observatory*, adopted by Capt. J. Ross, in his preparations for the Antarctic Expedition. It is so constructed as to form either *three* small separate rooms, or *one* large one. The former arrangement is desirable at places where the dip is nearly  $90^{\circ}$ , and where, consequently, the horizontal directive force is very small, and the disturbing action of the magnets on one another, relatively great. The parts are connected with copper fastenings; and the whole is so arranged, as to occupy a very small bulk when in pieces, and to be capable of being put together with quickness and security.

*New Photometer.* Prof. Daubeny exhibited the model of an apparatus, by means of which, in a more complete condition, he

hoped to obtain a numerical estimate of the intensity of solar light at different periods of day, and in different parts of the globe. It consisted of a sheet of photogenic paper, moderately sensible, rolled round a cylinder, which by means of machinery, would uncoil at a given rate, so as to expose to the direct action of the solar rays, for the space of an hour, a strip of the whole length of the sheet, and of about an inch in diameter. Between the paper and the light was to be interposed a vessel, with plane surfaces of glass at top and bottom, and in breadth corresponding to that of the strip of paper presented. This vessel, being wedge-shaped, was fitted to contain a body of fluid of gradually increasing thickness, so that, if calculated to absorb light, the proportion intercepted, would augment in gradually increasing proportion from one extremity of the vessel to the other. Hence it was presumed that the discoloration arising from the action of light would proceed along the surface of the paper to a greater or less extent, according as the intensity of the sun's light was such as enabled it to penetrate through a greater or less thickness of the fluid employed. In order to register the results, nothing more was required than to measure, each evening, by means of a scale, how many degrees the discoloration had proceeded along the surface of the paper exposed to light, during each successive hour of the preceding day. To render the instrument self-registering, some contrivance for placing the paper always in a similar position with reference to the sun, must, of course, be superadded. The object of this contrivance differed from that aimed at, by Sir J. Herschel, in his *Actinometer*, which merely measures the solar intensity at the moment of observation; whereas, this is intended as a measure of the aggregate effect of the intensity at the period, be it long or short, during which the paper was submitted to its influence. The interposition of an absorbing fluid has at least this advantage, that it enables the observer to estimate the relative intensity by marking the point at which the paper ceases to be discolored, of which the eye is able to judge more exactly, than of the relative darkness of shade which might be produced on paper exposed unprotected to light of different degrees of brilliancy.

Mr. Talbot offered some remarks on Daguerre's *photogenic process*.\* M. Arago had stated to the Institute that the sciences

---

\* See this Jour. 37; 374.

of Optics and Chemistry united, were insufficient in their present state, to give any plausible explanation of this delicate and complicated process. If M. Arago, who had the advantage of being for six months acquainted with the secret, and therefore of considering its nature in all points of view, was of this opinion, it seemed as if a call were made on all the cultivators of science to use their united endeavors, by the accumulation of new facts and arguments, to penetrate into the real nature of these mysterious phenomena. For this reason he would offer a small contribution of new observations, which might perhaps be of service in the elucidation of this new branch of science. The first part of Daguerre's process consists in exposing a silver plate to the vapor of iodine, by which it becomes covered with a stratum of iodide of silver, which is sensitive to light. Mr. T. stated that this fact had been known to him for some time, and that it formed the basis of one of the most curious of optical phenomena, which as it did not appear to have been observed by Daguerre, he would here describe. Place a particle of iodine, of the size of a pin's head, on a plate of silver, or on a piece of silver leaf spread on glass. Warm it gently, and you will shortly see the particle surrounded with colored rings, whose tints resemble those of Newton's rings. Now, if these colored rings are brought into the light, a most singular phenomenon occurs; for the rings prove to be sensitive to the light, and their colors change, and in a short time their original appearance is quite gone, and a new set of colors occupy their places. These new colors are altogether unusual ones; they do not resemble any thing in Newton's scale, but seem to have a system of their own. For instance, the two first colors are *deep olive green, and deep blue inclining to black*, which is quite unlike the commencement in Newton's scale. It will be understood that the outermost ring is here accounted the first, being due to the thinnest stratum of iodide of silver, farthest from the central particle. The number of rings visible is sometimes considerable. In the centre of all, the silver leaf becomes white and semi-transparent like ivory. This white spot, when heated, turns yellow, again recovering its whiteness when cold: from which it is inferred to consist of iodide of silver in a perfect state. The colored rings seem to consist of iodide of silver in various stages of development. They have a further singular property, which, however, has not been sufficiently examined



into. It is as follows: it is well known that gold leaf transmits a bluish green light; but no other metal has been described as possessing colored transparency. These rings of iodide of silver, however, possess it, being slightly transparent, and transmitting light of different colors. In order to see this, a small portion of the film should be isolated, which is best done by viewing it through a microscope. Mr. T. said that he had considered the possibility of applying a silver plate thus combined with iodine, to the purpose of photogenic drawing, but he had laid it aside as insufficient for that purpose, because its sensitiveness appeared to be much inferior to that of paper spread with chloride of silver, and therefore in an equal time it takes a much feebler impression. Now, however, M. Daguerre has disclosed the remarkable fact that this feeble impression can be increased, brought out and strengthened, subsequently, by exposing the plate to the vapor of mercury. Another experiment was then related, in which a particle of iodine was caused to diffuse its vapor over a surface of mercury. In order to this, a copper plate was spread over with nitrate of mercury, and then rubbed very bright and placed in a closed box along with a small cup containing iodine. The result was, a formation of colored rings of the greatest splendor and of large size. But they did not appear to be in any degree, sensitive to light. The next point of Daguerre's process is, the exposure of the picture to the vapor of mercury, and this is by far the most enigmatical part of the whole process. For he states that if you wish to view the picture in the usual manner, i. e. vertically, you must hold the plate inclined to the vapor at an angle of  $45^{\circ}$ , and *vice versa*. Now this is altogether extraordinary; for who ever heard of masses of vapor having determinate *sides*, so as to be capable of being presented to an object at a given angle? From the hasty consideration which he had been able to give to it, his first impression was, that this fact bore a certain analogy to some others which he would mention. If a piece of silver leaf is exposed to the vapor of iodine, however uniform the tension of the vapor, it does not combine uniformly with the metal, but the combination commences at the edge of the leaf and spreads inwards, as is manifested by the formation of successive bands of color parallel to the edge. This is not peculiar to silver and iodine, but occurs when other metals are exposed to other vapors, not always with entire regularity, but it displays a ten-

dency to combine in that way. A possible explanation is that this is due to the powerful electrical effect which the sharp edges and points of bodies are known to possess: in fact, that electricity is either the cause or the attending consequence of the combination of vapor with a metallic body. Again, if a minute particle of iodine is laid on a steel plate, it liquefies, forming an iodide of iron, and a dew spreads around the central point. Now, if this dew is examined with a good microscope, its globules are seen not to be arranged casually, but in straight lines along the edges of the minute striæ or scratches which the microscope detects even on polished surfaces. This is another proof how vapor is attracted by sharp edges, for the sides of those striæ are such. In regard to the sensitiveness of his photogenic paper, Mr. T. stated, that it will take an impression from a common argand lamp in one minute, which is visible though weak. In ten minutes the impression is a pretty strong one. In full daylight the effect is nearly instantaneous.

Mr. Scott Russell brought up the Report by Sir John Robinson and himself, the committee on *Waves*. Since the last meeting the committee had continued their researches, and had in each department confirmed or corrected the results formerly obtained by them, and had also extended their acquaintance with several interesting phenomena. The first object of their attention was the determination of the nature and laws of certain kinds of waves. Of these, the most important species was that called by Mr. Russell, the Great Solitary Wave, or the Primary Wave of Translation: the second, was the Oscillatory Wave or secondary species. The recent researches, while they had confirmed and extended the observations of preceding years, have in no respect altered the views formerly stated by the committee. The form of the wave is that to which the name *hemicycloid* has been given; its velocity is that due to half the depth of the fluid, reckoned from the top of the wave to the centre of gravity of the section, where the depth of the channel is not uniform. The motion of the particles, is a motion of permanent translation in the direction of the motion of the wave, through a space equal to double the wave's height; the particles of the water perfectly at rest before the approach of the wave, are lifted up, translated forwards, and deposited perfectly at rest in their new locations,—the translation taking place equally throughout the whole depth of the fluid.

Prof. Whewell communicated a letter from T. G. Bunt, Esq., of Bristol, showing the progress made in the Tide-calculations which had been assigned to the former. Elaborate and delicate observations on the tides have for some time been carried on at this place, but the details are too extensive for insertion here.

*On the use of Mica in polarizing light*, by Professor Forbes. The author explained the method of preparing mica used by him since 1836 for the polarization of heat and light. The mica is exposed for a short time to an intense heat in an open fire, by which the laminæ are so subdivided, that a pellicle of extreme thinness contains a sufficient number of reflecting surfaces, to polarize very completely the light or heat transmitted through it at a certain degree of obliquity. Being struck by the resemblance to metallic lustre, which the mica thus acquires, he also examined in 1836 some of its leading properties with regard to light, and found 1st, that the light reflected from a plate of mica so prepared (which light is very intense,) is but feebly polarized in the plane of incidence; and 2d, that the reflection so far resembles that at metallic surfaces, that when plane-polarized light is reflected from it, the plane of reflection being inclined to that of primitive polarization, the light is found to be elliptically polarized.—Prof. Lloyd observed, that, simple as this discovery might appear to those not conversant with this intricate subject, yet he considered it as highly important, not only as furnishing a method of polarizing light elliptically and circularly, more simple than any previously in use, but as it would also essentially aid the researches of those engaged in perfecting the theory of this interesting branch of physical optics; indeed, did time permit, he thought he could show that it furnished a clue at least to the solution of some of the difficulties which had hitherto opposed the progress of inquiry. In polarizing light elliptically or circularly, it was well known that the condition to be obtained is, that two rays should encounter one another in different phases, or, to speak the conventional language, of which one is accelerated by a half or some proportional part of a wave, while the other is either similarly or dissimilarly retarded. In this case, this condition is obtained, and with respect to a greater quantity of rays than in other processes, for those rays which, after being reflected at the first surface of those very thin laminæ of mica which they met, were afterwards encountered by those rays which passed into the

laminæ, were reflected at the hinder surface, and came out again after refraction at the first. Now it is obvious that the necessary conditions of acceleration and retardation of the rays could be thus obtained; and the vast multitude of exceedingly thin laminæ which are produced in the plate of mica, by the process of Prof. Forbes, far surpassed any thing which, by the most delicate mechanical operations we can hope to obtain. These researches are also of the utmost importance as tending to throw light on the internal structure of metals. Young, with his usual sagacity long since conjectured, from the well known fact that very thin leaves of gold transmit greenish light with almost unimpaired regularity, that the surfaces of all metallic plates consist of very thin laminæ, pervious to light, and that the phenomena of their polarizing influences depended on this. Fresnel followed out this conception, and traced mathematically the mode in which the polarization would take place. The present researches not only confirm these views, which were heretofore only conjectural, but actually show, how under certain conditions, elliptic and circular polarization could be obtained by a method similar to that producing ordinary polarization.

Mr. J. F. Goddard described an apparatus which he had constructed, by means of which he could exhibit in the Oxyhydrogen microscope, all the beautiful phenomena of polarized light.

Mr. Addison presented tables of *meteorological observations made at Great Malvern*, in Worcestershire, from 1835 to 1838 inclusive. From these tables it appears, that the mean temperature of Malvern is  $47.7^{\circ}$ ; the mean barometrical pressure is 29.386 in., and the mean dew point at 9 A. M., is  $43.7^{\circ}$ . The range of temperature during the four years, is from  $9^{\circ}$  on the 20th of January, 1838, to  $84^{\circ}$  on the 5th of July, 1836. The range of the barometer is from 28.010 in., November 29, 1838, to 30.228, October 14, 1837.

Mr. Julius Jeffreys offered a few observations on *the meteorology of elevated regions*. In 1824 he traversed through a space of 200 miles the higher range of mountains in the protected States in the Himalayas, for the purpose of conducting inquiries into the meteorology of those regions, and the character of the climate in a medical point of view. His observations were made during six months, upon mountain heights and in their subjacent valleys, from an elevation of 16,300 feet down to 4,000; and of

valleys, from one nearly 14,000 feet high to one of 3,000 feet. The diurnal variations of temperature on mountain heights, he found to be small, rarely more than  $12^{\circ}$ , and sometimes only  $4^{\circ}$  or  $5^{\circ}$ ; while in the valleys they were very great, so that commonly the minimum of the night was  $30^{\circ}$  and sometimes  $40^{\circ}$  below the maximum of the day. The hygrometric condition of the air corroborated certain of Prof. Daniell's views. The medical application of these inquiries had induced Mr. J. to publish an essay, to show among other points, that a removal of a considerable portion of the atmospheric pressure from the surface of the human body, must conduce to the restoration of the function of the skin, when exhausted by excess of duty in a tropical climate, and sympathy with a debilitated liver.

Col. Sykes offered some statements on *Certain Meteorological phenomena in the Ghâts of Western India*. The correctness of the assertion of the annual fall of many feet of rain in certain localities of India, having been doubted by many persons, Col. S. had procured the official meteorological records for 1834, kept by order of the government of Bombay, at the convalescent station of Mahabuleshwar. The observations were taken by Dr. Murray, the medical officer in charge at that station. The place is in N. lat.  $17^{\circ} 58' 53''$ , E. long.  $73^{\circ} 29' 50''$ , near the western scarp of the Ghâts, or mountain chain extending from Surat to Cape Comorin. Its elevation is about 4,500 feet. The temperature of a spring is  $65.5^{\circ}$  F. and the mean temperature of the air is nearly the same. There is some forest along the Ghâts, but in belts and patches, so that the wood can have little meteorological effect. From the tables it appears, that the mean temperature of 1834 was  $67.3^{\circ}$  F.; that of the hottest month (April,)  $74.4^{\circ}$ ; that of the coldest month, (Dec.)  $62.3^{\circ}$ . The fall of rain was prodigious, amounting to 25 feet 2 inches; and this enormous mass of water fell almost entirely in the months of June, July, August and September. The excessive fall of rain seems not incompatible with health, for the military detachment stationed at Mahabuleshwar is not characterized by any unusual sickness.

Mr. Follet Osler gave an account of the *indications of his anemometer as observed at Birmingham*. He made a detailed statement of the changes of the wind about the 19th of November, 1838, observed at Plymouth and at Birmingham, and concluded with some remarks on the great storm of the 6th and 7th of Jan-

uary, 1838, which committed such dreadful ravages in England. A careful analysis of the information I have collected, leads me, (said Mr. O.) to the opinion that this was a small, but violent rotatory storm, moving forward at the rate of 30 or 35 miles per hour. The diameter of the rotating portion, I am not prepared to give, nor do I consider it at all certain that it could be ascertained, as it seems likely that the revolutions were not in contact with the earth. The tendency of this eddy, or violent whirling of the air, would of course, be to produce a vacuum in the centre. The air that forms the eddy being constantly thrown off in a slight degree spirally upwards, and dispersed on the upper portion of the atmosphere, the effect of this would be, to produce a strong current upwards. Now, supposing this large eddy to be perfectly stationary, there would be a rapid rush of air towards it from all sides, which would be drawn up and thrown off through this rotating circle, and dispersed with amazing rapidity above; but as it is moving on with great velocity, the air that is in the advance of the storm is not sensibly affected until the whirl is close upon it, while in the rear the motion of the air is greatly increased; first, by the tendency of the air to rush into the great vortex of the storm; and secondly, by the motion onward of the vortex itself. This vortex or revolving column would increase in size upwards, so as somewhat to resemble a funnel; it would, in fact, be similar in its shape and action to an immense water-spout; whether it was vertical or not is entirely a matter of conjecture, but I should consider it probable that it would incline in the direction that the storm was moving, namely, to the N. E., and that it was an upper current that carried it in that direction. The greatest intensity of the storm in England was evidently across Lancashire and Yorkshire. I therefore conceive that the nucleus of the hurricane passed in a N. E. direction over these two counties. Towards the sides, however, a little current set in a S. and even slightly in a S. E. direction, on the S. side of the vortex; and in a N. W. and W. direction on the N. side, as before stated; but the main rush is behind. Our anemometer shows that we first felt a fresh S. wind with a slight bearing of E. in it, which very shortly became more westerly, increasing considerably in violence. It then moved round to the S. W. and became quite a hurricane, and continued so, very violent at first, but decreasing in strength during the remainder of the day. At Plymouth it

commenced at S. W. and then very gradually moved round a little more westward. It was by careful examination of the records of these two instruments that I arrived at the view I ventured to take of this storm, and the evidence I have collected from various parts of the country concerning it, strongly confirms me in the opinion I have taken of it. Many violent storms followed in the wake of this extraordinary hurricane, but I have not attempted to investigate these, as the main storm would have thrown the atmosphere into so disturbed a state, that it would be very likely to produce minor eddies, gusts, &c.

Prof. Stevelly observed that so long ago as 1834, at the Edinburgh meeting, he read a paper in which he attempted to explain and account for, on well-established principles, the four leading meteorological phenomena,—cloud, rain, wind, and hail. He gave reasons for rejecting the vesicular hypothesis as to the constitution of cloud, chiefly because no causes were known to exist adequate to the production of vesicles, and capillary attraction would tend to prevent it; and adopting the view of solid spherules, he showed that mere diminution of size would be sufficient to account for their suspension, as even globules of platina could be so reduced in size and suspended in such a manner as to descend at any given velocity, however small; adding to this the fact that electrical atmospheres to the globules, by repelling the air on all sides from the spherule of water, would virtually enlarge the bulk, without adding to the weight of the drop, and thus aid the suspension. Next, as to the formation of cloud; when a portion of cloud was once formed in air, loaded with vapor in the elastic state, the instant effect was a diminution of tension, and a fall of temperature in that spot; air would then rush in on all sides, but air loaded with vapor, rushing into a void will form cloud; more cloud would, therefore, be formed, and the causes again put into operation for the formation of more, and this, (as he called it,) *secondary* formation of cloud, would go on with greater rapidity the more the air was loaded with vapor, and along whatever course the air so loaded by the growing of the cloud would advance; in the mean time, the air rushing in to fill up the comparative void, would establish, when the causes were strongly in operation, progressive whirls, such as those described by Mr. Redfield and Col. Reid, on the same principle that water while going on along a course, if let out by a hole in the bottom, forms

a whirlpool. The general correctness of this view was shown by the fact that Mr. Redfield's and Col. Reid's whirls were found to advance along the course of the gulf-stream, the warmth of which tended to load the air above it with vapor; and in the hurricane which did such damage to Charleston, the town was saved from destruction by the fact that the most violent part of the storm followed the bend of the river: the shipping was nearly destroyed. In this way was also to be accounted for, the perplexing fact that the storm was propagated against the course of the wind, as is well known also in summer thunder storms. These were the phenomena of dry storms. When much rain fell, the space above was left arid also by the descent of the water, while the air below was pushed out on all sides, thus very much modifying the current at the surface, increasing the force to leeward, and diminishing it to windward, causing sometimes the fearful and sultry calm preceding the thunder storm; the fall of temperature above, in consequence of the expansion of the air rushing in to fill the void, often froze into hail the rain-drops as they passed through, the surface of the boles of which would be clear ice; but, expanding as it formed the shell, the inner part would be opaque and crystalline, because partly void. Mr. Espy, of Philadelphia, had a theory nearly the reverse of this: he conceived the heat given out by the vapor in passing to the state of cloud or rain, to be so abundant, as, by its rarefying influence to cause a rapidly ascending column or vortex, capable of producing most appalling effects; and the only step doubtful in this theory was the first,—for before the vapor can pass to the state of water, it must be robbed of this very latent heat by an external cause; but, grant this first step, and the rest of Mr. Espy's theory was almost a series of mathematical demonstrations.

A valuable paper was then read, "*on certain results* which he had recently arrived at, respecting the minimum thickness of the crust of the globe, which might be consistent with the observed phenomena of Precession and Nutation, assuming the earth to have been originally fluid," by Mr. W. Hopkins.

Mr. Smythies then communicated a general method of solving dynamical problems relating to the motion of free bodies, by means of differentiation and elimination of differentials without any integration, by which the result is obtained in a finite number of algebraical terms, when the equations of condition determining the motion are algebraically assigned.



Prof. Powell presented a report on *refractive indices*, containing the mean results of many series of observations for a considerable range of substances. The author made a few preliminary observations on the nature of the inquiry, especially with reference to some points of dispute respecting the identification of certain rays of the spectrum, which had been discussed by Sir D. Brewster and himself.

Mr. Nasmyth exhibited a Plate-glass pneumatic speculum, of his invention. The glass was three feet three inches in diameter, and three sixteenths of an inch thick. It was placed on a concave cast-iron bed and fastened in with bees-wax, which rendered the apparatus air-tight.

*On a new case of interference of light*, by Prof. Powell. The author observed that when a prism of one substance was opposed to another, slightly differing in dispersive power, (as plate glass and oil of sassafras,) so as to produce a partial achromatism, *in the colored edges*, which appeared on either side of the white image of a narrow line of light, when viewed through a small telescope, there were formed *dark bands*; about four or five being visible on each edge, parallel to the line of light. The explanation is easy, when we consider that of the parallel pencil of each primary ray which enters the eye, (in breadth equal to the aperture of the pupil,) the rays which have traversed greater thicknesses of the first prism, traverse less thicknesses of the second; and thus have their retardations so nearly compensated, as to be in a condition to interfere and produce the dark bands observed. In the same manner Prof. P. explained the analogous optical phenomena observed by Sir D. Brewster, and stated at previous meetings of the Association.

Dr. Andrew Ure offered some account of his mode of measuring, by means of photogenic paper, diffuse daylight comparatively at any time and place. He also recounted a series of experiments which he had made to determine the fluency or viscosity of different liquids at the same temperature, and of the same liquids at different temperatures.

Mr. W. J. Frodsham exhibited and described his *improved compound pendulum*. It is an ordinary pendulum, with a steel rod, over which Mr. F. slips a zinc tube, which passes through a brass bob, and rests on the adjusting screw at the lower end of the rod, the bob being fastened at the centre by two connecting rods of

steel to the tube, at the point at which the expansion of the tube is the same as that of the rod; so that, as the steel rod expands downwards, and is lengthened by heat, the zinc tube expands upwards in the same degree; and therefore, if the lengths of the rod and the tube be rightly proportioned, the pendulum may be regarded as of invariable length. Some other additional apparatus is devised in order to the greater perfection of this pendulum, but the description is too long for this place.

The Secretary read the report of the Committee, consisting of Sir J. Herschel, Mr. Whewell, Mr. Peacock, and Prof. Lloyd, appointed to represent to government the resolutions adopted by the Association in August, 1838, recommending that *Magnetic Observatories* be established in various parts of the British dominions, and that a naval expedition be fitted out for the purpose of determining, by observations, the magnetic direction and intensity, in high southern latitudes, between the meridians of New Holland and Cape Horn. It is well known that this application was eminently successful; that the Antarctic Expedition sailed in the summer of 1839, and that efficient measures have been taken to secure a magnificent system of magnetic observations.

Prof. Powell made a communication on *certain points in the wave-theory as connected with Elliptic polarization*. Its object was to set forth a general statement of some material conditions which involve in a common relation the theory of dispersion, of the wave surface and of elliptic polarization.

Mr. E. Hodgkinson gave an account of experiments made by order of the Association on the *temperature of the Earth* in the deep mines of Lancashire and Cheshire. Satisfactory results appear not to have been yet fully attained, and the experiments are to be continued.

Prof. Forbes submitted a report of observations made by order of the Association on the *temperature of the Earth* at different depths near Edinburgh. These observations were commenced in February, 1837, and have been regularly continued since. The object was to ascertain the conducting power for heat, of different soils, and the measure of the sun's influence at different depths under similar external circumstances. At each station four thermometers were sunk to the depths of 3, 6, 12, and 24 French feet respectively, the tubes of each being carried above the surface so as to be conveniently exposed side by side. The

readings were made every week, and corrected for the temperature of the stem and scale, and the results were projected in the form of curves. Among other valuable results, it is deduced from the observations of 1838, that the oscillations of annual temperature would be virtually extinguished at a depth of 49 feet in *traf tufa*, 62 feet in incoherent sand, or 91 feet in compact sandstone.

Mr. Snow Harris reported on the progress of the *meteorological observations made by order of the Association at Plymouth*, with the barometer and thermometer. The following general results were mentioned. The mean height of the barometer at the Plymouth dock-yard, 60 feet above sea level, at 60° F. was from the latest results, 29.8967 in. It occurred in the mean hourly progression four times in the day, viz. at 2h. 20m. and 8h. 10m. A. M.; and at 12h. 30m. and 6h. 15m. P. M., at which times the waves crossed the mean pressure line. The hours of greatest pressure were 10 A. M. and 9 P. M.—of least pressure, 5 A. M. and 3 P. M. With reference to the *influence of the moon on the barometer*, Mr. H. had reduced about 4000 of the observations, so as to show the pressure for the time of the moon's southing, and for each hour before and after; but he could not discover any differences which could be supposed to arise from the moon's influence.

Dr. Andrew Ure described a *new Calorimeter*, by which the heat disengaged in combustion may be exactly measured, and he gave, also, some introductory remarks on the nature of different coals. In these researches, which are still in progress, the first determination sought is the proportion of volatile and fixed matter afforded by any kind of fuel. This shows how far the coal is a flaming or gas coal, and what quantity of coke it can produce. The second point to be determined is the amount of sulphur contained in the coals, a matter of great importance, as regards their domestic use, their employment by the iron master and the manufacturer of gas. Dr. Ure's future researches are intended to embrace every variety of fuel, and the results will doubtless be highly important.

Prof. Stevelling communicated his *method of filling a barometer without the aid of an air-pump*; and of obtaining an invariable level of the surface of the mercury in the cistern. He heated the mercury as hot as it could be used, and filled the tube in the

common mode, to within half an inch of the top; then worked out, in the usual way, all air bubbles as perfectly as possible; filled up the tube to the top and inverted it in a cup of hot mercury, when it, of course, subsided in the upper part of the tube to the barometric height; he then placed his finger on the mouth of the tube under the mercury in the cup, and lifted it out; and still holding his finger tightly over the mouth of the tube, laid it flat on a table, when the mercury in the tube soon lay at the under side of the tube, leaving void the upper part along the length of the tube. On turning the table slowly round, still keeping the finger on its mouth, every particle of air was gathered up. He then placed the tube upright, with its mouth upwards, and placing a funnel of clean dry paper about the upper part, an assistant filled the funnel slowly with hot mercury, so as to cover the fingers. On slowly withdrawing the finger, the mercury went gently in, and displaced almost perfectly the atmospheric air which had gathered into the void space. By renewing the process which succeeded the previous washing of the air out of the tube, once or twice, a column of the utmost brilliancy was obtained. Dr. Robinson suggested the substitution of a piece of caoutchouc for the finger in this process, and it was found a decided advantage. The method of procuring an invariable surface in the cistern was equally simple. He proposed to divide the cistern into two compartments, by a diaphragm of sheet iron or glass brought to a sharp edge at top. Into one of these compartments the tube dips; in the other is placed a plunger of glass or cast iron, which can be raised or lowered by a slow screw movement. To prepare for observation, the plunger is first screwed down, by which it displaces the mercury in one compartment, and raises its surface in the other above the edge of the diaphragm; on raising it slowly again, the mercury drains off to the level of the edge of the diaphragm; thus at every observation, reducing the surface to a fixed level.

The following letter was communicated from Sir John Herschel, containing a most interesting communication respecting the action of the dissevered rays of light in the solar spectrum.

*My Dear Sir,*—May I take the liberty of requesting that you will mention to the Physical Section of the British Association a very remarkable property of the extreme red rays of the Prismatic

Spectrum, which I have been led to notice in the prosecution of my inquiries into the action of the spectrum on paper, rendered sensitive to the chemical rays by Mr. Talbot's process, or by others of my own devising.

The property in question is this:—that the extreme red rays, (such, I mean, as are insulated from the rest of the spectrum by a dark blue glass colored by cobalt, and which are not *seen* in the spectrum unless the eye be defended by such a glass from the glare of the other colors,) not only have no tendency to darken the prepared paper, but actually exert a contrary influence, and *preserve* the whiteness of paper on which they are received, when exposed at the same time to the action of a dispersed light sufficient of itself to produce a considerable impression. I have long suspected this to be the case, from phenomena observed in taking photographic copies of engravings; but having at length obtained demonstrative evidence of the fact, I think this may not be an improper opportunity to announce it.

When a slip of sensitive paper is exposed to a highly concentrated spectrum, a picture of it is rapidly impressed on the paper, not merely in *black*, but in *colors*, a fact which I ascertained nearly two months ago, and which observation of mine seems to have been alluded to (though in terms somewhat equivocal) by M. Arago, in his account of Daguerre's process. In order to understand what follows, it will be necessary to describe the colors so depicted. The red is tolerably vivid, but is rather of a brick color than of a pure prismatic red; and what is remarkable, its termination falls materially short of the *visible* termination of the spectrum. The green is of a sombre, metallic hue; the blue still more so, and rapidly passing into blackness. The yellow is deficient. The whole length of the chemical spectrum is not far short of double that of the luminous one, and at its more refrangible end a slight ruddy or pinkish hue begins to appear. The place of the extreme red, however, is marked by no color, thus justifying *so far* the expression which M. Arago is reported to have used in speaking of my experiments, "Le rayon rouge est seul sans action."

It is impossible in this climate to form a brilliant and condensed spectrum without a good deal of dispersed light in its confines; and this light, if the exposure of the paper be prolonged, acts, of course, on every part of its surface. The colored picture is formed,

therefore, on a ground not purely white, but rendered dusky over its whole extent, *with one remarkable exception*, viz. in that spot where the extreme red rays fall, the whiteness of which is preserved, and becomes gradually more and more strikingly apparent the longer the exposure and the greater the consequent general darkening of the paper.

The above is not the only singular property possessed by the extreme red rays. Their action on paper already discolored by the other rays is still more curious and extraordinary. When the spectrum is received on paper already discolored slightly by the violet and blue rays *only*, they produce, not a white, but a red impression, which, however, I am disposed to regard as only the commencement of a process of discoloration, which would be complete if prolonged sufficiently. For I have found that if instead of using a prism, a strong sunshine is transmitted through a combination of glasses carefully prepared, so as to transmit absolutely no ray but that definite red at the extreme of refrangibility, a paper previously darkened by exposure under a *green* glass has its color heightened from a sombre neutral tint to a bright red; and a specimen of paper rendered almost completely black by exposure to daylight, when exposed for some time under the same glass, assumed a rich purple hue, the rationale of which effect I am disposed to believe consists in a very slow and gradual destruction, or stripping off as it were, of layers of color deposited or generated by the other rays, the action being quicker on the tints produced by the more refrangible rays in proportion to their refrangibilities.

It seems to me evident that a vast field is thus opened to further inquiries. A deoxydizing power has been attributed to the red rays of the spectrum, on the strength of the curious experiments of Wollaston on the discoloration of tincture of guaiacum, which ought to be repeated; but in the sensitive papers, and still more in Daguerre's marvellous ioduretted silver, we have re-agents so delicate and manageable, that every thing may be expected from their application.

J. F. W. HERSCHEL.

*Slough, August 28, 1839.*

*On the effects of lightning in three of Her Majesty's ships*, by Mr. Snow Harris. Mr. H. showed from the facts which he had collected, that were the masts of ships made perfectly good con-

ductors of electricity, and freely connected by efficient conductors with the sea, the electrical agency would have an unlimited and easy source of diffusion in all directions, and hence the ship would be safe from the moment the flash struck the mast head. From his inquiries it appeared that in 100 cases of ships in the British Navy struck by lightning, the number struck on the main-mast were to those struck on the fore-mast as 2 : 1 ; to those struck on the mizen-mast, as 10 : 1 ; to those struck on the bowsprit, as 50 : 1. About one ship in six is set on fire in some part of the hull, sails or rigging. In one half the cases some of the crew were either killed or wounded. In the 100 cases alluded to, 62 seamen were killed, and about 114 wounded. These are exclusive of one case of a frigate, in which nearly all the crew perished, and of 12 cases in which the numbers killed or wounded were set down in the accounts given as *several* or *many*. In these 100 cases, there were damaged or destroyed 93 lower masts, principally of line-of-battle ships and frigates, 83 top-masts, and 60 topgallant-masts.

A notice was read, from Dr. Robinson, on the determination of the arc of longitude between the observatories of Armagh and Dublin. In September, 1838, Mr. Dent, by means of twelve chronometers, determined the longitude of Dublin to be +25m. 21.08s., longitude of Armagh +26m. 35.44s. Subsequently, by means of rocket-signals, Dr. R. found the difference between Armagh and Dublin to be 1m. 14.258s. or .1s. less than the chronometrical determination.

The *Longitude of New York City Hall* was determined by Mr. E. J. Dent, by means of chronometers sent out by the British Queen, in July, 1839, to be +4h. 56m. 3.55s. which varies less than 3s. from the previously received determination. (See this Journal, vol. xxxvii, p. 400.)

Prof. Whewell made some remarks on Dr. Wollaston's argument on the question of the infinite divisibility of matter, drawn from the finite extent of the atmosphere. Dr. W. imagined that if the extent of the earth's atmosphere be finite, air must consist of indivisible atoms, since he assumed that the only way in which we can conceive an upper surface of the atmosphere, is by supposing an upper stratum of atoms, the weight of which, acting downwards, is balanced by the repulsive force of the inferior strata acting upwards. Prof. W. contended that such a

mode of conception was arbitrary, and the argument founded upon it, baseless; for if we investigate the relation between the height of any point in the atmosphere, and the density of the air at that point, on the supposition that the compressing force is as the  $n$ th power of the density, we find that the density vanishes at a finite height whenever  $n$  is greater than unity. Therefore, though the atmosphere do not consist of indivisible particles, it will still have a finite surface. In fact, the finite surface of the atmosphere no more proves the atomic constitution of air, than the finite surface of water, in a vessel, proves the atomic constitution of water.

### Section B. *Chemistry and Mineralogy.*

Prof. Graham, President of the Section, opened the meeting with some observations on the recent progress of chemistry, which, in his view, is advancing with unprecedented rapidity, both in its theory and its applications. The organic department is the most productive, and at present engrosses the attention of chemists. In this department he would allude to what seemed to him its two great features. 1. The happy generalization of Dumas,—*the law of substitutions*, which had been the clue to so many discoveries. He first applied it to the action of chlorine upon organic compounds, finding that when chlorine acts upon those bodies, for every atom of hydrogen abstracted in the form of hydrochloric acid, an atom of chlorine is left in its place. The same doctrine has been successfully applied to the action of oxygen and other elements on the same bodies. Thus, in the oxidation of alcohol in the acetous fermentation, hydrogen is withdrawn in the form of water, by combining with oxygen, and at the same time the hydrogen is replaced by an exactly equivalent quantity of oxygen. The same law led M. Dumas to his most recent discovery, that of chloro-acetic acid,—an acetic acid, in which chlorine is substituted for oxygen. One of the most interesting applications of this doctrine is that by M. Regnault, in elucidating the history of the chlorides of carbon. For the original discovery of these compounds we are indebted to Mr. Faraday. One of them which contains its two elements in the ratio of single equivalents has been named the protochloride of carbon. What is its real nature? M. Regnault has traced it through various compounds, all produced by the action of chlorine on ole-



fiant gas, by the abstraction of more and more hydrogen, and the substitution of a corresponding quantity of chlorine, till the whole four atoms of hydrogen of the olefiant gas are replaced by chlorine. This view, which represents the protochloride of carbon as consisting of four atoms of carbon and four of chlorine; or olefiant gas with its hydrogen replaced by chlorine, is consistent with the observed density of its vapor. Olefiant gas, also, has the four atoms of carbon belonging to alcohol from which it was formed, so that the protochloride of carbon has the carbon of alcohol from which it was primarily derived, and thus preserves, after numerous mutations, the most distinct traces of its origin.

2. The *binary theory of the constitution of bodies*, advocated by Liebig. This is the theoretical resolution of bodies, apparently the most complex, into not more than two proximate constituents, one of which, also, is generally a simple substance. There can be no doubt that compound radicals will be the basis of the classification of organic compounds, and that thus the same simplicity of arrangement will be introduced into organic compounds, as now exists in the metallic combinations of inorganic chemistry.

A communication was read from Prof. Hare, of Philadelphia, on the *preparation of barium, strontium and calcium*. By means of the alternate action of two deflagrators, each of 100 pairs, containing more than 100 square inches of zinc surface, assisted by refrigeration, Dr. H. has procured amalgams of these metals from their chlorides, and by distillation in an iron crucible, included in an air-tight alembic of the same metal, has extricated them from their mercurial solvent. (For full details, see this Journal, vol. xxxvii, p. 267.)

Mr. Coathupe, of Bristol, described an improved method of graduating glass tubes for eudiometrical purposes; and also exhibited an apparatus for determining the amount of carbonic acid in the atmosphere.

The Baron Eugene Du Mesnil gave a description of a safety lamp invented by him in 1834. It consists of a body of flint-glass, defended by a dozen of iron bars. The air is admitted by two conical tubes, inserted at the bottom, which are capped with wire-gauze, and enter by the side of the flame. The latter rises into a chimney, which has a piece of metal placed in the form of an arch over its top; the chimney being quite open. In consequence of this construction, a strong current is constantly passing

up the chimney. When carburetted hydrogen passes in, the fact is discovered by numerous small explosions, and the whole glass work is thrown into vibrations which emit a loud and shrill sound, audible at a great distance.

*On a small Voltaic battery of extraordinary energy* by W. R. Grove, Esq. In a letter published in the *Philos. Mag.* Feb. 1839, I stated, (said the author,) some reasons for hoping that by changes in the constituents of voltaic combinations of four elements, we might greatly increase their energy. At that period I sought in vain for improvements, which a fair induction convinced me were attainable; but being in the country, all my experiments were with copper as a negative metal. I was constantly unable to use concentrated nitric acid as an electrolyte, and its importance never occurred to me until forced upon my notice by an experiment which I made at Paris for a different object. This was an endeavor to prove the dissolution of gold in nitro-muriatic acid to be an electrical phenomenon; or rather, that this (and, as I believe with Sir H. Davy, every other chemical phenomenon,) could be resolved into an electrical one by operating on masses instead of molecules. The experiment was this: the extremities of two strips of gold leaf were immersed, the one in nitric, the other in muriatic acid; contact between the liquids being permitted, but mixture prevented, by an interposed porous diaphragm. In this case, the gold remained undissolved for an indefinite period, but the circuit being completed by metallic contact, either mediate or immediate, the strip of gold in the muriatic acid was instantly dissolved. Thus, it seems, that the affinity of gold for chlorine is not able alone to decompose muriatic acid; but when it is aided by that of oxygen for hydrogen, the decomposition is effected. The phenomenon bears much analogy to ordinary cases of double decomposition. The two gold strips in the experiment being connected with a galvanometer, occasioned a considerable deflexion; and it now occurred to me, coupling this experiment with my previous observations, that these same liquids, with the substitution of zinc and platinum for the gold leaf, would produce a combination of surpassing energy. My expectations were fully realized; and on the 15th of April, M. Becquerel presented to the Institute a small battery of my construction, consisting of seven liqueur glasses, containing the bowls of common tobacco-pipes, the metals zinc and platinum, and the electrolytes

concentrated nitric and dilute muriatic acids. This little apparatus produced effects of decomposition equal to the most powerful batteries of the old construction. Dilute nitric acid diminishes the energy; nitro-sulphuric acid acted as an electrolyte much as nitric acid; it is an excellent conductor, yielding oxygen at the anode, and hydrogen at the cathode. Applying this to my battery, I found it to succeed admirably, and hence a considerable diminution of expense on the side of the zinc; and I also found salt and water nearly equal to dilute muriatic acid. By using flattened parallelopiped-shaped vessels, the concentrated acid is much economized and the metals approximated. \* \* The rationale of the action of this combination, according to the chemical theory of galvanism, appears to be this. In the common zinc and copper combination, the resulting power is as the affinity of the anion of the electrolyte for zinc, *minus* its affinity for copper; in the common constant battery it is as the affinity of the anion for zinc, *plus* that of oxygen for hydrogen, *minus* that of hydrogen for copper. In the combination in question, the resulting power is as the affinity of the anion for zinc, *plus* that of oxygen for hydrogen, *minus* that of oxygen for azote. Nitric acid being much more readily decomposed than sulphate of copper, resistance is lessened and the power increased; and no hydrogen being evolved from the negative metal, there is no precipitation upon it, and consequently no counter-action. I need scarcely add a word as to the importance of improvements of this description in the voltaic battery. This valuable instrument of chemical research is thus made portable, and by increased power in diminished space, its adaptation to mechanical, especially to locomotive purposes, becomes more feasible.

Prof. Graham remarked on the *theory of the Voltaic Circle*. He first explained the received views of the propagation of electrical induction through the fluid and solid elements of the voltaic circle, by the formation of chains of polar molecules, each of which has a positive and a negative side, and in which no circulation of the electricities is supposed, but merely their displacement and separation from each other in the polar molecule. These electricities in the polar molecule of hydrochloric acid, for instance, are displaced, when the acid acts as an exciting fluid, and the positive electricity located in the chlorine atom, and the negative electricity in the hydrogen atom. These electricities are at

the same time, made the depositories of the chemical affinities of the chlorine and hydrogen respectively. Mr. G. proposed to modify this theory so far as to abandon the idea of electricities being actually possessed by these bodies, and to refer the phenomena at once to the proper chemical affinities of these bodies. He assigned similarly polar molecules to the exciting fluid and metals; and taking hydrochloric acid as a type of exciting fluids, he gave to each molecule a pole, having an affinity resembling that of chlorine, or *chlorous* affinity,—of negative electricity; and another pole, having an affinity resembling that of zinc and hydrogen, or *zincous* affinity, instead of positive electricity. He pursued the subject to a considerable length, illustrating his views by means of diagrams.

Dr. George Wilson gave an experimental demonstration of the *certain existence of haloid salts in solution*. All previous attempts to decide the question whether haloid salts do or do not decompose water, when dissolved in it, have afforded no certain results. The object of this paper is to show, that although the inquiry had long been abandoned as hopeless, a demonstration can be given of the persistent haloid condition of the dissolved haloid salts of the electro-negative metals. This the author appears to have satisfactorily demonstrated. It is mentioned as an incidental conclusion from the experiments recorded, that they afford a direct proof of the quasi-metallic character of hydrogen, so much insisted on by the advocates of the binary theory of salts; and that they supplied more direct evidence than any previous trials regarding this, since they not only demonstrate hydrogen to have the power of displacing many metals, but at the same time assign to it, as its proper place in its metallic character, a position intermediate between the electro-positive and electro-negative metals.

A paper was offered by Dr. S. Brown on the *Crystallization of Carburets*; having for its object to lay down a new form of the maxim of crystallization, viz. that when particles of a solid body are slowly evolved from the decomposition of a substance of which it, or its elements, are chemical constituents, they cohere in crystal, and that independently both of the fusion (or solution) of the body crystallized, and of the presence of any fluid medium of molecular action whatsoever. Dr. B. had obtained small crystals, colorless and intensely hard, of the carburets of iron, copper, zinc, lead, &c.

Dr. Clark read a paper on the *limits within which the equivalent weights of elementary bodies have been ascertained*. As the result of various researches, Dr. C. stated the following equivalents : viz.

Lead,	Least,	1292.65	Greatest,	1293.89	Mean,	1293.27
Sulphur,	"	199.45	"	200.77	"	200.09
Azote,	"	175.42	"	177.20	"	176.31
Carbon,	"	75.28	"	75.92	"	75.60

Dr. R. D. Thomson read an essay on the proofs of the *existence of free muriatic acid in the stomach* during digestion. He offered various reasons for doubting the certainty of the conclusion that muriatic acid thus exists, but that as the experiments which he had instituted in regard to the subject were not completed, he brought them forward at this time chiefly to show the necessity of further investigation.

Mr. Benson presented a paper on the *theory of the formation of White Lead*. He stated that white lead made from litharge, (protoxide of lead,) was rejected by painters. It is found that prepared in this way it is crystalline and partly transparent, whereas the ordinary white lead is amorphous and opake. It is found that in order to obtain the amorphous carbonate (or white lead) from litharge the latter must be supplied with a very minute portion of acetic acid.

Prof. Schönbein of Basle proposed a *new theory of the galvanization of metals*. The discovery of the chemical power of the voltaic pile, made at the beginning of the present century by British philosophers, drew the attention of the scientific world to the relations between chemical and electrical phenomena. Indeed, only a few years after this important fact had been ascertained, Davy and Berzelius did not hesitate to assert the theory, since generally adopted,—viz. that chemical and electrical forces are essentially the same. Prof. S. enumerates the results of several recent experiments which he considers as invalidating this theory. From these results he infers—1st. That neither common nor voltaic electricity is capable of changing the chemical bearings of any body, and that the principles of the electro-chemical theory, as laid down by Davy and Berzelius, are fallacious. 2d. The change which certain metallic bodies, when placed under the influence of a current, seem to undergo with regard to their chemical relations, is due to the production of some substance or

other, and its deposition upon those bodies by the agency of a current of electricity. 3d. The condition, *sine quâ non*, for efficaciously protecting readily-oxidizable metals against the action of free oxygen dissolved in fluids, is to arrange a closed voltaic circle, which is made up on one side, of the metal to be protected, and another metallic body more readily oxidizable than the former, and on the other side, of an electrolyte containing hydrogen, as water.

Prof. Shepard, of the Medical College of the State of South Carolina, gave an account of the *analysis of a meteorite*, in which he had detected chlorine and silicon.

*On the composition of Idocrase*, by Mr. T. Richardson. Mr. R. remarked that many of the formulæ of minerals are very incorrect representations of their constitution. Idocrase in this respect is greatly confused, and with the view of endeavoring to remove the discrepancies, Mr. R. made with great care the following analysis of specimens from the cabinet of Mr. Hutton.

No. 1 is Idocrase from Egg, in Norway. 2. Idocrase from Slatoush in Siberia. 3. Idocrase from Piedmont. 4. Vesuvian from Monte Somma. 5. Egerane from Eger, in Bohemia.

	1.	2.	3.	4.	5.
Silica,	38.75	37.45	39.25	37.90	38.40
Alumina,	17.35	18.85	17.30	18.10	18.15
Protox. Iron,	8.10	7.75	7.62	4.89	7.40
Protox. Manganese,	"	trace	3.50	"	trace
Lime,	33.60	35.25	32.25	34.69	33.09
Magnesia,	1.50	1.35	.47	3.23	3.02
	<hr/>	<hr/>	<hr/>	<hr/>	<hr/>
	99.30	100.35	100.30	98.86	100.06

From these results it appears that Idocrase may be represented by the formula,  $7(\text{FO, MO, CaO, MgO})_3 \text{SiO}_3 + 5\text{Al}_2 \text{O}_3 \text{SiO}_3$ .

Dr. Ure gave a summary of his *experiments on fermentation*, from which among other results it is found that without the addition of yeast, much alcohol is generated in grain worts at an early period of the process of malting.

Prof. Reich communicated his researches on the *electrical currents in metalliferous veins* made in the mine Himmelsfurst, near Freyberg. Phenomena of this sort were first made known by Mr. Fox, and have been since confirmed by the observations of others. Reich considers their cause to be the hydro-electric action of the metallic components of the vein.

Mr. Exley presented a paper on the *relations of atoms in organic compounds*, comprising many very ingenious views and speculations, which cannot be well condensed.

Dr. Charles Schafhaeutl, of Munich, communicated the results of his inquiries into the *relative combinations of the constituents of cast iron, steel and malleable iron*. Among other things, he showed that the purest carbon contained and retained hydrogen, and sometimes azote, even at the highest temperatures. Pure iron cannot be welded; the welding power of iron depends on its alloy with the carburet of silicon. Steel as it comes out of the converting furnace or the crucible, is nothing more or less than white cast iron, of which Indian steel, called *wootz*, is the fairest specimen. Analyses were given of two specimens of cast iron and one of steel. It appears that the peculiarities of Swedish iron, depend in a great degree, on the presence of arsenic; and those of Russia iron on the presence of phosphorus.

### Section C. *Geology and Geography.*

Dr. Buckland, the President of the Section, submitted a recommendation from a Society in Bradford, that the attention of members of Museums in provincial towns should be directed chiefly, if not solely, to the collection of specimens from their own immediate vicinities.

Dr. B. laid before the meeting the last number of M. Agassiz's work on *Fossil Fishes*, and spoke of the merits of that gentleman, who had sacrificed very flattering prospects in mercantile life to a love of science; being content to live almost in poverty, devoting his slender means to the furtherance of his undertaking. M. Agassiz had received pecuniary assistance from the Association; and to that body as well as to the English subscribers to his work, he was most grateful, for without such aid he must have abandoned the undertaking, so valuable to the scientific world, and especially to geology. Dr. B. stated the importance of fossil fishes to the geologist, their scales being preserved when their skeletons are destroyed; and made some observations on the adaptation of the covering of animals to the medium in which they live. He adduced the minute scales of the eel, covered over with mucus, to protect it from the mud,—this mucus preventing the scales from being grated or injured.

Mr Lyell read a paper on the *Tubular cavities filled with gravel and sand in the Chalk* near Norwich. The chalk near Norwich is covered with gravel, sand and loam, of variable thickness, much stained with iron, occasional masses of ferruginous sandstone being interstratified, in which are casts of the shells of the Norwich crag. The shelly crag itself forms here and there part of the same deposit. The outline of the chalk, at its junction with the incumbent gravel, is very irregular. In some places, tubular hollows, having the form of inverted cones, and filled with gravel and sand, are prolonged downwards to various depths into the chalk. These cavities vary in width from a few inches to 8 yards and upwards, and in depth from a few feet to more than 60 yards. Some are tortuous, but most of those at Eaton, two miles west of Norwich, are perpendicular. The materials filling the pipes agree precisely with those covering the chalk, with the exception that in the pipes they are unstratified. The pebbles in the gravel consist of rounded flint and quartz; but no shells or pieces of chalk, or any calcareous substance, occur in the pipes. In general, coarse sand and pebbles occupy the central parts of each pipe, while the bottom and sides are lined with a fine ferruginous clay, which however is permeable by water. This clay contains no calcareous matter. The chalk, for the distance of several inches, or even sometimes four or five feet from its junction with the sand pipe, is in a moist and softened slate, and contains a slight mixture of fine sand and clay, by which it is somewhat discolored. The chalk, at points more remote from the tubes, is white, pure, and perfectly soluble in acids. The pipes, which do not exceed a foot and a half in diameter, are often crossed by horizontal layers of flint nodules, which have remained in situ, while their chalky matrix has been removed. From this circumstance, the author infers that the pipes were due to the corroding action of water containing acid, which could not dissolve flint. But it is clear that the tubes were not first excavated to their present width and depth, and then filled subsequently and at once with gravel, for in that case the siliceous nodules would have been found in a heap at the bottom of each large cavity, having been derived from all the intersected layers of flint. This never happens, the larger flints being invariably dispersed irregularly through the gravel and sand which fills the tubes. Mr. L. therefore inferred that



the excavation and filling of the pipe proceeded contemporaneously and gradually, and that the flint nodules, when removed from their chalky matrix, subsided so as to rest upon sand and gravel which had previously sunk. As proving that the contents of the sand pipes came into their present position by slowly subsiding, the author mentioned the fact of strata of gravel elsewhere horizontally bending downwards into the mouth of a pipe, so as to become for a short space quite vertical within the pipe. He thought that the tubes, or at least some of the larger and deeper ones, were caused by springs impregnated with carbonic acid, which rose upwards through the chalk. But, afterwards, when these springs ceased, the descent of rain water, percolating the gravel, carried fine particles of sand and clay downwards, and deposited them at the bottom and sides of the tube, at all those points where the water was absorbed by the surrounding chalk. Some of the finer particles being carried into the chalk itself, caused the impurity and discoloration of that rock near the pipes. Mr. De la Beche mentioned that similar appearances are observed in other formations, as in green sand near Charmouth. Dr. Buckland agreed with Mr. Lyell as to the origin of the clay which lines these fissures. The gravel which covers the chalk he conceives to have been accumulated under salt water; and after the elevation of the strata, so as to become dry land, the clay lining was formed by the downward filtration of atmospheric water, carrying with it the material in solution. He did not agree with Mr. L. in considering these sand pipes as chimneys for the carbonic acid, as he saw no reason why the acid should come up in one place more than another, and a place serving as a chimney, should bear the marks of corrosion. Dr. B. concluded by instancing the example of fishes killed by carbonic acid, mentioned by Dr. Daubeny. In these, the death of the fish was very sudden, none living above five minutes. In volcanic districts the carbonic acid generated must have had a similar effect, and many specimens of fossil fish show the animals to have died suddenly, from the perfection of their preservation. He also insisted upon the importance of impressions of foot-marks, of atmospheric and of watery action on the surfaces of rocks, and stated that the most interesting point now in geology is the examination of those surfaces as they were exposed in different ages.

Mr. De la Beche called the attention of the meeting to the *geological map of Cornwall and Devon*, which he had made for the Ordnance Survey; it was universally admitted to be a most beautiful specimen of scientific topography.—Mr. J. E. Marshall exhibited a section across the Silurian rocks in Westmorland, from Shap Granite to Casterton Fell.—Rev. D. Williams read a paper on the rocks of South Devon and Cornwall, which was followed by a communication from Mr. Austen on the fossil remains of the limestones and slates of South Devon.

Mr. Lyell announced the *discovery*, in a crag pit at Newbourn, in Suffolk, *of the teeth of several species of mammalia*. The first of these fossils was determined by Mr. Owen, to be the posterior grinder of the lower jaw of the leopard. Mr. Wood, on receiving this intelligence, examined carefully a large collection of teeth from Newbourn, and they were found to belong chiefly to fishes of the genus *Lamna*; but among them was one which Mr. Owen has pronounced to be the molar tooth of a bear, and others which belong to a small ruminant. These fossils are all more or less broken, and there is no doubt they were found in the large pit at Newbourn, in which the teeth of fishes are abundant, in red crag. But, Mr. Lyell remarked, that there are many vertical fissures extending downwards to the depth of 30 feet and more, through the red crag at Newbourn; these fissures being filled with the detritus of shelly red crag. It is possible therefore, that the mammalian teeth may have been derived from the contents of these fissures, and may consequently belong to a qualified epoch, posterior to that of the red crag. Mr. L. however, inclines to the opinion that the teeth of the mammalia and fishes will prove of the same age; because, although the shells of the red crag are almost exclusively marine, yet Mr. Wood has discovered at places distant only a few miles from Newbourn, a fresh-water *Amiator*, the *Planorbis marginatus*, and two individuals of a land shell, *Auricula migosotis*, imbedded in the marine crag. The same river, therefore, that conveyed these shells to the sea, may also have carried down the remains of land quadrupeds. Mr. L. then mentioned the discovery of the teeth of an opossum in the London clay at Kyson, near Woodbridge. This fossil was obtained, together with the teeth of fish, from the upper part of a bed of sand about ten feet thick, which is covered by a mass of London clay about 17 feet thick. The clay is again covered,

at a short distance from Kyson by the red crag. Mr. Owen, on seeing this tooth, was clear that it could not belong to any of the decidedly carnivorous or herbivorous animals, but rather to some one of the mixed feeders, and having compared it with the teeth of the various tribes of quadrupeds included in that division, from the shrews to the monkeys, he found it to differ essentially from all of them, and he finally decided that it was marsupial, and one of the molars of a *Didelphis* allied to the Virginia opossum. Mr. L. immediately requested Mr. Wood and Mr. Colchester to renew their search in the same sand at Kyson, and they soon found a jaw and tooth, which Mr. Owen refers to a quadrumanous animal of the genus *Macacus*. The sand containing these remains is referable to the London clay; and this is the first instance of the fossil remains of quadrumana having been found in a deposit of the Eocene period. Cuvier had previously described a *Didelphis* from the Eocene fresh-water gypsum of the Paris basin. Mr. Lyell remarked, that the occurrence of an Eocene *Macacus* proved that the class most nearly approaching to man in its organization, was not limited, as some had supposed, to an era immediately antecedent to the creation of the human race. He also adverted to the great caution to be observed, when we reason from negative evidence in geology, as we do, where we infer the non-existence of certain classes of beings, at remote periods, from the mere fact of their fossil remains not having yet been found in ancient strata.

Mr. Bowman exhibited specimens of fossil fishes from Manchester, and submitted a communication upon them, from Mr. Binney. Scales and teeth of the sauroid fish, *Megalichthys*, are found in the low coal shales above the millstone grit in the Manchester coal field, and as far up as the fresh-water limestones of Ardwick. Remains of *Diplodus*, *Ctenoptychus*, *Holoptychus*, and *Palæoniscus* are found in greater abundance, though not so extensively disseminated. Some are found in a rock composed of the shells of a *Cypris* and a species of *Microconchus*, indicating a tranquil deposit of the bed as in a lagoon of a tropical climate. Some specimens are found quite close to the coal, but none have as yet been observed in it. The state of preservation and the position in which the fishes occur, lead to the conclusion, that they have been suddenly destroyed by water highly charged with decayed vegetable matter.

Mr. Strickland mentioned the *discovery of an Ichthyosaurus*, at Strensham near Tewkesbury, by Mr. Marrett, and also exhibited a fossil fish with cycloidal scales from the lias, a fact not agreeing with the hypothesis of Agassiz.

Dr. Wilde made a communication on *ancient Tyre*, and gave many interesting statements concerning the celebrated Tyrian dye.

Mr. Bowman read a paper on some *skeletons of fossil vegetables*, found by Mr. Binney, in the shape of a white impalpable powder, under a peat-bog near Gainsborough, occupying a stratum four to six inches in thickness, and covering an area of several acres. It appeared to be pure silica. On examination with high magnifiers, the powder was found to consist of a mass of transparent squares and parallelograms of different relative proportions, whose edges were perfectly sharp and smooth, and often traced with delicate parallel lines. On comparing these with the forms of some existing Confervæ, Mr. B. found the resemblance so strong, that he had no doubt they were the fragments of parasitical plants of that order, either identical with, or nearly allied to, the tribe *Diatomaceæ* which grow abundantly on the other Algæ.

Mr. Murchison exhibited a *geological map of Europe*, colored by Von Dechen, and the first part of a work on Petrifications, collected by Humboldt in South America. The latter work has led to some important conclusions;—no oölitic or jurassic strata seem to exist in South America (or perhaps even in North America;) but there is a large development of the tertiary series, and a still larger of cretaceous, in the southern continent. Specimens of Silurian fossils had been brought to the present meeting of the Association, collected in North America, by Prof. C. U. Shepard of New Haven, Ct.

Mr. Murchison called the attention of the meeting to a section of a part of Germany which he had lately visited. Mr. Murchison stated, that having with Prof. Sedgwick, examined the older rocks of Western Germany and Belgium, it is their intention to lay before the Geological Society of London, a memoir, illustrated by fossils, on the classification of those ancient deposits, a succession of the Carboniferous, Devonian and Silurian systems. His present communication bore only on one point of this analysis, offering to prove the geological position of the anthracite or culm-bearing strata of Devonshire and Cornwall.

Dr. Buckland announced that the *Fossil Flora of Great Britain* was about to be continued by Messrs. Hutton and Henslow.—Dr. Lloyd mentioned the recent discovery of Saurian remains in Warwickshire.—Dr. Ward exhibited specimens and drawings illustrative of *impressions of the feet of animals* on the Greensill sandstone, near Shrewsbury. Greensill hill consists of a steep escarpment of new red sandstone, and contains four strata that have been described by Mr. Murchison, and in the second of which the impressions were found. This stratum when exposed to the atmosphere, always splits so as to exhibit ripple marks, and on these marks the impressions of feet have been observed, as well as marks of drops of rain. The latter are often in an oblique direction, as if having fallen in a gale of wind, the direction of which is thus pointed out. The foot-marks differ from those of the *Cheirotherium*, in having only three toes, armed with long nails, directed forwards, and not spread out. Nothing resembling the ball of the foot has been observed, except in a few, which have some resemblance to the impression of the foot of a dog.

Mr. Knipe read a communication on a *trap dyke* in Cumberland. Its length is 22 miles and its width from 20 to 30 yards. Its course coincides with that of the great Cleveland Dyke, and it is not improbable that they may be connected; if so, a basaltic dyke, 120 miles long, crosses our island from the Solway Firth to the German Ocean.

Mr. Darwin announced that a work on *fossil teeth* by Prof. Owen, will shortly be published.

A communication on *Peat-bogs*, by Dr. G. H. Adams, was read. The author had examined microscopically many specimens of peat, and had found them to consist of bundles of little capsules, somewhat like bunches of raisins, attached to the radicles of the plants growing on the surface of the bogs.—Mr. J. B. Yates read a paper on the *Changes and improvements in the embouchure of the Mersey*.—A paper was received from Mr. R. Garner on the *use of millstone grit in the manufacture of white earthen-ware*. Millstone grit has been used in Staffordshire for three or four years, being ground instead of flint, which is more expensive, as it must be calcined before grinding. The ware thus produced is as white, compact and durable, as that made by the former process.

Section D. *Zoology and Botany.*

A paper by Mr. Lankester was read, *on the formation of woody Tissue*. The tissues of plants, are for the sake of convenience, divided into *five*; but the origin of all these may be traced to the simple cell. How they are formed from the simple cell, is an undecided question, especially with regard to woody tissue. Du Petit Thouars supposes, that woody fibre is formed by the buds and leaves, and sent down by them between the bark and wood of the tree; whilst other writers suppose that it is formed from the bark or wood. The conclusions of the author, from all the known facts on the formation of woody tissue are:—1. That the requisites for the formation of wood, are a living tissue developing elongated fibres, a tissue forming and depositing secreted matter, and exposure to the influence of external stimuli. 2. That the secreted matters are more easily brought under the influence of external stimuli in the younger tissues; hence the importance of leaves. 3. That neither bark nor leaves are essential to the formation of woody tissue.

Notice of *Zoological Researches in Orkney and Shetland* in June, 1839, by Edward Forbes and John Goodsir. Their attention was directed almost wholly to invertebrate animals. Of *Mollusca*, they found four new species of *Eolida*, a new *Velutina*, and three apparently new species of *Ascidia*. Of the *Annelida*, they took great numbers; among others, the beautiful *Planaria atomata* of Müller, not before recorded as British. As to the *Radiata*, they were equally successful. The genus *Holothuria* holds its British court in Shetland, and the king of them is an enormous species, which the authors name *H. grandis*. Five other new species of this genus were found, and also a new species of *Ophiocoma*, of *Dianæa*, of *Oceanea*, of *Alcynöe*, and a minute animal, the type of a new genus among the *Acalephæ*. The most beautiful contribution to the British Fauna, from the Orkneys, is a zoophyte of the family *Tubulariadaæ*, new both as a species and genus, and the largest known form of its tribe. It is about four inches long, and its stem half an inch in diameter. It belongs between *Tubularia* and *Coryne*, on the relations of which genera its discovery throws much light, as well as on the polypes in general. The authors propose to consecrate the genus to that great British zoophytist, Ellis, calling it *Ellisia*, and giv-

ing the species the appropriate name of *Flos maris*, as it may well be regarded, from its extreme grace and beauty, as the flower of the British seas.

Mr. Goodsir read a paper on the *follicular stage of dentition in the Ruminants, with some remarks on that process in the other orders of Mammalia*. He stated, that since the former meeting, he had detected the follicular stage of dentition in the pig, rabbit, cow and sheep. He had verified the fact, that all the permanent teeth, except the first molar which does not succeed a milk tooth, are developed from the internal surface of cavities of reserve, and that the depending folds of the sacs of composite teeth are formed by the lips of the follicles advancing inwards, after closure of the latter. He then described the progress of development of the pulps and sacs of the teeth in the cow and sheep, from their first appearance, as minute as possible, on the full surface of the membrane of the mouth, or on the internal surface of the cavities of reserve, till they have acquired their ultimate configuration. At an early period of the embryonic life of these animals, they possess the germs of canine and superior incisive teeth; the former existing as developed organs in two or three genera only of ruminants; the latter being found in the aberrant family of the camels. These germs have the form of slight dimples in the primitive groove, and after the closure of the latter, they remain for a short time opaque nodules imbedded in the gum, in the course of the line of adhesion.

Mr. Wilde communicated his mode of *preparing fish for cabinet specimens*, and also read a paper on some new species of Entozoa, discovered by Dr. Bellingham.

Messrs. Edward Forbes and John Goodsir made a communication, on the *Ciliograda of the British seas*. The Ciliograda of the British seas belong to three genera, viz. Cydippe (Eschscholtz,) Alcynöe (Rang,) and Beroe (Linnæus.) Of the first genus, there are four species in these seas: of the second and third, two each.

Mr. G. Webb Hall made a communication on the *acceleration of the growth of Wheat*. He called the attention of the members to certain facts connected with the acceleration of the growth of wheat, and a consequent diminution of the time of its occupying the ground. The ordinary period of the growth of wheat is from the middle of October to the middle of August. Close observa-

tion under different circumstances, and a peculiar selection of seed and soil, have reduced the period of this plant to five months. A quick crop might be produced by pressing and compacting the soil, and in light soils, well manured, a quicker growth is ensured. One great means of obtaining early crops is the use of seed produced by plants that were themselves of early growth.

Mr. Felkin exhibited the results of an experiment in *the growth of silk at Nottingham*. The circumstances of the case had been unpropitious, but the result was successful. Land and labor being high in England, it is improbable that she can in silk culture compete with other countries, but in her colonies, and in the vast regions of Hindoostan, she has the means of raising immense quantities at a low rate. He imagined that the whole world might be supplied from India with raw silk, at half its present cost.

Mr. George T. Fox communicated some observations on whales, in connexion with an account of the *remains of a whale recently found at Durham*. In recently clearing out the rubbish from the basement story of the old tower of Durham Castle, the workmen were surprised to find several large bones; and as they advanced these accumulated, until twenty vertebræ, and about as many ribs were taken out, and also two large jaw bones. Mr. F. on examination, determined that the bones belonged to a spermaceti whale. The discovery excited much interest in the town, and while the subject was in agitation, Rev. Jas. Raine discovered a curious letter from Jo. Duresme to Mr. Stapylton, dated London, June 20, 1661, which at once accounted for the discovery of these animal remains. The letter clearly shows that the bones belonged to an animal cast on shore on the coast of Durham at Earington, in 1661; and it is therefore the oldest whale of the kind recorded to have been found on the British coast. The bones have been collected and set up in the Museum of Durham University.

Dr. Prichard read a paper *on the extinction of the human races*. He expressed his regret that so little attention was given to Ethnography, or the natural history of the human race, while the opportunities for observation are every day passing away; and concluded by an appeal in favor of the Aborigines Protection Society. The paper gave rise to a long and desultory conversation.



Next was read a *Report on the distribution of the Pulmoniferous Mollusca in Britain, and the causes influencing it*; drawn up at the request of the Association, by Mr. E. Forbes. The object of this inquiry was to ascertain the geographical and geological distribution of pulmoniferous mollusca in the British isles. The subject was considered under three heads; *first*, a view of the various influences which affect their distribution; *second*, a detailed view of the distribution of the indigenous species in the various provinces of Britain; and *third*, the relations of that division of the native Fauna to the Fauna of Europe, and the distribution generally of the more remarkable species.

Mr. J. E. Bowman exhibited specimens of a species of Dodder, *Cuscuta epilinum*, first found in Britain two years ago, by himself; and again in a new locality within the present month. He believes it is found exclusively on flax, and has been mistaken for *C. Europea*, from which however it is quite distinct.

A paper was read on the *cultivation of the Cotton of commerce*, by Major General Briggs. The objects proposed in the paper, are, 1. To excite inquiry on the various species of cotton plant that produce the cotton of commerce. 2. To ascertain the nature of the soils adapted to each. 3. To prove the practicability of cultivating the plant in India, for the supply of the British market to any extent. Of the species that produce the various cottons of commerce, we have at present very little accurate knowledge, and this has arisen from the alterations undergone by the plant in the process of cultivation. But there can be no doubt that the plants which produce cotton in America, Asia and Africa are of decidedly different species. The plant that produces the Brazil cotton, probably the *Gossypium hirsutum*, grows 15 or 20 feet high, is perennial, and produces cotton with a long and strong staple, and moderately fine and silky. The plant common to the West Indies, (said to have been imported from Guiana,) is triennial, bearing abundantly a fine silky long staple, and is the *G. Barbadosense* of botanists. This also is the plant which produces the Sea-island cotton. When this plant was carried from the coast into the interior of Georgia and Carolina, the seed changed from a black to a green color, and the staple became shorter, coarser and more woolly. This plant was afterwards introduced into Egypt, and is the same that produces the Bourbon cotton, cultivated by the French on that island. Mr.

Spalding records several varieties, attention to which is of the greatest importance to the cultivation, since they vary in the character of their staple, in the shape and size of their pods, in the hue of the cotton, and in the duration of the plant. The common indigenous plant of India is the *G. herbaceum* of botanists, and differs in appearance from the cottons of the Western world; besides which there is the *G. religiosum*, producing the brown cotton extensively grown in China. The former plant is usually cultivated as an annual, but has been successfully treated and grown as a perennial, by the process of pruning down when the cotton is gathered. The produce of this plant is not inferior in fineness, and is superior in point of richness of color, to the best cottons of America. The staple is however short, and by the great neglect hitherto evinced in picking the produce at the proper time, and carelessness in allowing particles of dried leaves or the calyx of the flower to adhere to the wool, it brings a lower price, and is considered an inferior article in the English market, to the New Orleans and Georgian of America, though really superior in quality and durability. There is another kind of cotton produced from a species in Africa, which Dr. Royle considers allied to the *G. herbaceum* of India.

Mr. W. Danson made some remarks on the introduction of a species of *Auchenia* into Britain. Samples and manufactured specimens of Alpaca wool, in imitation of silk, (and without dye,) as black as jet, were exhibited. Mr. D. stated that the animals producing it ought to be propagated in Britain. Importations of the wool have already been made to the extent of one million pounds, and are likely to increase. There are five species of Llamas, of which, the *Alpaca* has fine wool, 6 to 12 inches long; the *Llamas*, hair which is very coarse, and the *Vicuña*, has a very short fine wool, more of the beaver cast. The wool of these animals would not enter into competition with the wool of sheep, but rather with silk. It is capable of the finest manufacture, and is especially suited to the fine shawl trade. The yarns spun from it are already sent to France in large quantities, at from 6s. to 12s. 6d. per pound, the piece of the raw Alpaca wool being now 2s. and 2s. 6d. per pound.

Prof. Jones made some observations on an apparatus for observing fish, (especially of the family Salmonidæ,) in confinement. He had prosecuted numerous inquiries in Scotland with reference

to the habits of the salmon and allied species, and with regard to the identity of various young and full grown fish.

Mr. C. C. Babington made an oral communication concerning some recent additions to the English Flora.—A letter was read from Mr. Garner, on the *Beroë pileus*, stating that he had not seen in this animal true luminosity, but only a peculiar luminosity in the dark. The external rows of ciliæ he believed might produce it. He had remarked, that if only one of the ciliæ were removed from this animal, it still continued to vibrate for many hours. He thought the currents in *Beroë* might be accounted for by ciliæ, which he observed to be placed in the whole of the interior of the animal. In the interior of the animal he had observed what appeared to him to be sacculi.

#### Section E. *Medical Science.*

After an introductory address from Dr. Yelloly, President of the Section, a paper by Sir David Dickson was read, containing abstracts of a remarkable case of rupture of the duodenum and of some other interesting cases.

Mr. Middlemore read a brief notice of the methods which have been used for the *removal of capsular cataract*, where the opaque capsule remains after absorption of the lens, for the purpose of introducing to notice an instrument to facilitate the operation of extraction without interfering with the transparent structures of the eye. It consists of a needle, accompanied by a small forceps, the former capable of being withdrawn, leaving the latter to be fixed on the opaque membrane and then withdrawn through the sclerotic, through which the needle had been introduced. He also detailed a case in which the operation for artificial pupil had been performed with success, and presented the patient for examination.

Dr. Foville, of Paris, presented a paper, detailing the results of his researches on the anatomy of the brain. He urged the advantages of examining the structure of the brain by manual separation rather than by section, and gave credit to Willis, as being the first advocate of this method.—Prof. Macartney read an essay on the means of repressing hemorrhage from arteries; giving the preference to metallic ligatures; and also a paper on the rules for finding with exactness the position of the principal arteries and nerves, from their relations to the external forms of the

body.—Dr. Blakiston read a paper on the sounds produced in respiration and on the voice.—Dr. G. Bird communicated observations on poisoning by the vapors of burning charcoal. Two opinions prevail on the mode in which this gas produces death. 1. That the gas acts negatively. 2. That the gas when respired, exerts a specific poisonous action on the nervous system. Dr. B. adopts the latter opinion.—Dr. Inglis read a paper, of which this was the summary:—1. Small pox is decidedly on the increase, and during each successive epidemic there is an increase of variolous patients from among those who were vaccinated in infancy. 2. The vaccine virus is as effectual now as it ever was, but re-vaccination is necessary after a period of years, as yet unknown. 3. The same cause which produces small pox during a variolous epidemic in the unvaccinated, may and does give rise to chicken pox in the vaccinated. 4. There is every reason to believe that cow pox had its origin in variola.—Mr. J. B. Estlin read a paper, to show, that the powers of the new virus diminish in intensity as successive vaccinations increased its distance from the cow.—Dr. R. D. Thomson, read a paper on alkaline indigestion, and gave the results of an extensive examination of patients laboring under this disease.—Mr. Hodgson read a paper on the red appearance on the internal coat of arteries, which he stated did not depend on inflammation in every instance, and from which it should be carefully distinguished.—Mr. C. T. Coathupe gave the results of a series of experiments on respiration. (See this Journal, Vol. xxxvii, p. 367.)—Dr. Costello presented a report of ten cases of calculus treated by lithotrity.—Mr. Nasmyth read a paper on the microscopic structure of the teeth, in which he treated also of the covering of the enamel and of the organization of the pulp. He subsequently read a paper on the structure of the Epithelium, (a layer of substance destitute of vessels, covering the vascular surface of mucous membranes,) which he described as being composed of cells.—Dr. L. Güterbock exhibited several instruments made from ivory, softened by the removal of the earthy matter by the action of dilute acid. He stated that the first idea of the preparation is contained in an English work published some time ago, entitled “Useful Arts and Inventions.”

Section F. *Statistics.*

Mr. Clarke read a paper containing contributions to the educational statistics of Birmingham.

Mr. G. R. Porter read a paper entitled *suggestions in favor of the systematic collection of the statistics of agriculture*. Of the material interests affecting the well-being of a community, one of the most important subjects is doubtless that of an adequate supply of food for the people; and yet in England the subject has not hitherto been considered to any useful or practical end. It cannot even be ascertained from any authentic document, what quantity of land in the country is under cultivation. The author enforced with much earnestness the importance of establishing the necessary organization to secure the statistics in question, and also to diffuse among the agriculturists a knowledge of the improvements in the science of husbandry which are often limited to narrow districts. It has been stated that if all England were cultivated as well as the counties of Northumberland and Lincoln, it would produce more than double the quantity of food now obtained.

A report on the state of the working classes in three parishes in Rutlandshire, from facts collected by the Manchester Statistical Society, was read by Mr. Gregg.—Mr. Langton of the same society, read a report on the educational statistics of the county of Rutland. Taking the scholars of all ages, about 5 per cent. of the population attend evening and day schools only; 9.6 per cent. attend day and Sunday schools; 6 per cent. attend Sunday schools only.

Mr. Rawson read a very elaborate paper on the *criminal statistics of England and Wales*. Of his interesting results we can here state but one or two. The average annual number of persons committed or bailed to take their trial, during the last five years, was 22,174, of which more than half were for simple larceny. Both in England and in France the ratio of male to female criminals is about as 4 to 1.—Next was read a report by the Manchester Statistical Society on the borough of Kingston-upon-Hull.—Mr. Wharton made a report on the progress of the inquiries made by the committee instituted for the purpose of inquiring into the statistics of the mining districts of Northumberland, Durham and Yorkshire.—Mr. Clarke read a report on the commercial statistics of Birmingham, prepared by a local committee. It in-

cludes returns from the Savings Bank, Assay Office, Workhouse, &c. During the past year, 25,000 gold wedding rings had been assayed and marked. The number of steam engines is 240, of which 65 are high pressure, and the remainder condensing engines.—Prof. Powell read a paper on Academic Statistics, showing the proportion of students in the University of Oxford, who proceed on to degrees. Among other results it is stated that the ratio of the number matriculated to those who pass final examination, is 1 : 2.67.—Mr. Fripp read the report of the committee appointed to inquire into the condition of the working classes in Bristol. This document goes into minute details and exhibits immense labor.—Mr. Clark presented contributions to the medical statistics of Birmingham by a local committee, comprising elaborate returns from the town Infirmary, General Hospital, &c.

#### Section G. *Mechanical Science.*

Mr. J. I. Hawkins made a communication on *paving roads with blocks of wood*, placed with the grain in a vertical position. He considered that roads formed of sound wood, with the grain vertical, might be made so even as to constitute a sort of universal railway, on which carriages might be drawn by a small proportion of horse-power, and on which steam carriages might run as safely and almost as fast as on railways.—Mr. Scott Russell read a paper on *the most economical proportion of power to tonnage in steam vessels*. It is a subject of anxious inquiry when about to construct a new steam vessel, what is the best amount of power to place in the ship, so as to secure in the highest degree, economy, rapidity and regularity. The general principle at which after much study of the subject, Mr. R. had arrived, was this: that in a voyage by a steam vessel in the open sea, exposed of course, to adverse winds, there is a certain high velocity and high portion of power which may be accomplished with less expenditure of fuel and of room, than at a lower speed with less power.

Dr. Lardner read a very extensive paper detailing a series of experiments by himself and Messrs. Woods and Earle on the *resistance of the air to railway trains*. The following are his general conclusions. 1. The resistance to a railway train, other things being the same, depends on the speed. 2. At the same speed the resistance will be in the ratio of the load, if the carriages remain unaltered. 3. If the number of carriages be in-

creased, the resistance is increased, but not in so great a ratio as the load. 4. Therefore, the resistance does not, as has been hitherto supposed, bear an invariable ratio to the load, and ought not to be expressed at so much per ton. 5. The amount of the resistance of ordinary loads carried on railways at the ordinary speeds, more especially of passenger trains, is very much greater than engineers have hitherto supposed. 6. A considerable, but not exactly ascertained proportion of this resistance is due to the air. 7. The shape of the front or hind part of the train has no observable effect on the resistance. 8. The spaces between the carriages of the trains have no observable effect on the resistance. 9. The train, with the same width of front, suffers increased resistance with the increased bulk or volume of the coaches. 10. Mathematical formulæ, deduced from the supposition that the resistance of railway trains consists of two parts, one proportional to the load, but independent of the speed, and the other proportional to the square of the speed, have been applied to a limited number of experiments, and have given results in very near accordance, but the experiments must be further multiplied and varied, before safe, exact, and general conclusions can be drawn. 11. The amount of resistance being so much less than has been hitherto supposed, and the resistance produced by curves of a mile radius being inappreciable, railways laid down with gradients of from 16 to 20 feet a mile have practically but little disadvantage compared with a dead level; and curves may be safely made with radii less than a mile; but further experiments must be made to determine a safe minor limit for the radii of such curves; this principle being understood to be limited in its application to railways intended chiefly for rapid traffic.

Dr. Ure read a paper on the specific gravity or density of steam at different temperatures. Mr. E. Hodgkinson detailed some experiments made to ascertain the power of different species of wood to resist a force tending to crush them. The specimens for experiment were turned into right cylinders, about an inch in diameter and two inches long. Great discrepancies were found when the woods were in different degrees of dryness; wet timber, though felled a considerable time, bearing in some instances, less than half of what it bore when dry.—Mr. G. Cottam gave an account of the Marquis of Tweedale's patent brick and tile machine.—Mr. Fairbairn related some

experiments on the effects of weights acting for an indefinite time on bars of iron.—Mr. Scott Russell made a report on the proceedings of the Committee appointed to inquire into the best form for vessels, and explained the nature of the experiments in progress.—Mr. Cottam described a new railway wheel, made wholly of wrought iron, so welded together, that independent of screws, rivets, or other kind of fastening, they form one piece with the spokes.—Mr. Jeffries read a paper on warming and ventilating, and gave a description of a pneumatic stove.—Mr. Gossage communicated an account of a new rotatory steam engine.—Mr. Player made a communication on the application of anthracite coal to the blast furnace, steam engine boiler and smith's fire, at the Gwendraeth Ironworks near Carmarthen.—Mr. Davies gave a description of a machine for cutting the teeth of bevel wheels.—Mr. Dredge offered some remarks on bridge architecture.—A new secret lock without a key, by Mr. Benge, was then exhibited; and also a model, sent by Mr. Hamilton of Edinburgh, of a method by which the resistance caused by the pressure of the wind against the valves of the organ can be overcome, thereby permitting the largest pipes to be played by the fingers with facility, and also rendering the movement of the pedal keys and valves more smooth.

The amount of moneys granted at this meeting for the prosecution of scientific inquiries was £2789 14s. 7d.

ART. XV.—*Account of a Journey to the Côteau des Prairies, with a description of the Red Pipe Stone quarry and Granite bowlders found there; by Mr. GEORGE CATLIN, in a letter to Dr. Charles T. Jackson.*

Read in the Boston Society of Natural History, Sept. 4, 1839, and communicated for this Journal.

*Dear Sir*—In the summer of 1835, whilst visiting the tribes of Indians on the Upper Mississippi, I spent some months at and in the vicinity of the Falls of St. Anthony. Whilst there, I resolved to pay a visit to the "Red Pipe Stone quarry," (as it is called,) on the "*Côteau des Prairies*," the place where the Indians procure the stone for their red pipes; of which place I had already learned many very curious and interesting traditions from the Upper Mis-



souri tribes. From the exceedingly strange nature of these traditions and the great estimation in which this place is held by the savages, as well as from a full conviction in my own mind, that this pipe stone differing in itself from all other known minerals, might be a subject of great interest to science, I determined to see it *in situ*, and not only to understand its position and relations, but also to enable myself to give to the world, with more confidence, the strange and almost incredible traditions and legends which I have drawn from the different tribes, who have visited that place.

For this purpose I had made all the necessary preparations, and was to start in a day or two, accompanied by several officers and men of the garrison, whom Maj. Bliss, then in command, had allowed to accompany me. Just at this time however, we got news by a steamer which arrived from below, that Mr. Featherstonhaugh, was near the fort with fifteen men, in a bark canoe, on his way up the St. Peter's, having been sent by government to explore the Côteau des Prairies. At this intelligence, I immediately abandoned the journey, and taking a corporal with me from the garrison, descended the Mississippi in a bark canoe, to Prairie du Chien, and afterwards to Rock Island and St. Louis. In that city I learned on the return of Mr. Featherstonhaugh, that he did not go to the Pipe Stone Quarry, and I returned to New York in the fall, and in the succeeding spring, made a journey from that city, by the way of Buffalo, Detroit, Green Bay, Prairie du Chien, and Falls of St. Anthony, to the Côteau des Prairies, and the Red Pipe Stone Quarry, a distance of 2,400 miles, for which purpose I devoted eight months, travelling at a considerable expense, and for a great part of the way with much fatigue and exhaustion. At Buffalo I was joined by a young gentleman from England, of fine taste and education, who accompanied me the whole way and proved to be a pleasant and amusing companion.

From the Falls of St. Anthony we started on horseback with an Indian guide, tracing the southern shore of the St. Peter's River about eighty miles, crossing it at a place called "Traverse de Sioux," and recrossing it at another point about thirty miles above the mouth of "Terre Bleue," from whence we steered in a direction a little north of west, for the "Côteau des Prairies," leaving the St. Peter's River, and crossing one of the most beau-

tiful prairie countries in the world, for the distance of one hundred and twenty or one hundred and thirty miles, which brought us to the base of the Côteau. This immense tract of country which we had passed over, as well as that along the St. Peter's River, is every where covered with the richest soil, and furnishes an abundance of good water, which flows from a thousand living springs. For many miles in the distance before us we had the Côteau in view, which looked like a blue cloud settling down in the horizon; and when we had arrived at its base, we were scarcely sensible of the fact from the graceful and almost imperceptible swells with which it commences its elevation above the country about it. Over these swells or terraces, gently rising one above the other, we travelled for the distance of forty or fifty miles, when we at length reached the summit, and also the Pipe Stone quarry, the object of our campaign. From the base of this magic mound to its top, a distance of forty or fifty miles, there was not a tree or a bush to be seen in any direction; the ground was every where covered with a green turf of grass about five or six inches high; and we were assured by our Indian guide that it descended to the west, towards the Missouri, with a similar inclination, and for an equal distance, divested of every thing save the grass that grows and the animals that walk upon it.

On the very top of this mound or ridge, we found the far famed quarry or fountain of the Red Pipe, which is truly an anomaly in nature. The principal and most striking feature of this place is a perpendicular wall of close grained, compact quartz, of twenty five or thirty feet in elevation, running nearly north and south with its face to the west, exhibiting a front of nearly two miles in length, when it disappears at both ends by running under the prairie, which becomes there a little more elevated, and probably covers it for many miles, both to the north and the south. The depression of the brow of the ridge at this place has been caused by the wash of a little stream produced by several springs on the top of the ridge, a little back from the wall, which has gradually carried away the superincumbent earth, and having bared the wall for the distance of two miles, is now left to glide for some distance over a perfectly level surface of quartz rock, and then to leap from the top of the wall into a deep basin below, and from thence seek its course to the Missouri, forming the extreme source of a noted and powerful tributary, called the "Big Sioux."

This beautiful wall is perfectly stratified in several distinct horizontal layers of light gray and rose or flesh colored quartz ; and through the greater part of the way, both on the front of the wall and over acres of its horizontal surface, it is highly polished or glazed, as if by ignition.

At the base of this wall and running parallel to it there is a level prairie of half a mile in width, in any and all parts of which the Indians procure the red stone for their pipes by digging through the soil and several slaty layers of the red stone to the depth of four or five feet. From the very numerous marks of ancient and modern diggings or excavations, it would appear that this place has been, for many centuries, resorted to for the red stone, and from the great number of graves and remains of ancient fortifications in its vicinity, (as well as from their actual traditions,) it would seem that the Indian tribes have long held this place in high superstitious estimation, and also that it has been the resort of different tribes, who have made their regular pilgrimages here to renew their pipes.

It is evident that these people set an extraordinary value on the red stone, independently of the fact that it is more easily carved and makes a better pipe than any other stone ; for whenever an Indian presents a pipe made of it, he gives it as something from the Great Spirit ; and some of the tribes have a tradition that the red men were all created from the red stone, and that it thereby is "a part of their flesh." Such was the superstition of the Sioux on this subject, that we had great difficulty in approaching it, being stopped by several hundred of them, who ordered us back and threatened us very hard, saying "that no white man had ever been to it, and that none should ever go."

In my notes on Manners and Customs of North American Indians, which will shortly appear, I shall give a very novel and curious account of their traditions and superstitious forms about this great medicine or mystery place.

The red pipe stone, will, I suppose, take its place amongst interesting minerals ; and the "Côteau des Prairies" will become hereafter an important theme for geologists, not only from the fact that it is the only known locality of that mineral, but from other phenomena relating to it. The single fact of such a table of quartz, resting in perfectly horizontal strata on this elevated plateau, is of itself, as I conceive, a very interesting subject for investigation, and one which calls upon the scientific world for

a correct theory with regard to the time when, and the manner in which, this formation was produced. That it is a secondary and sedimentary deposit, seems evident; and that it has withstood the force of the diluvial current, while the great valley of the Missouri from this very wall of rocks to the Rocky Mountains has been excavated and its debris carried to the ocean, I confidently infer from the following remarkable fact.

At the base of the wall and within a few rods of it, and on the very ground where the Indians dig for the red stone, rests a group of five stupendous bowlders of gneiss leaning against each other, the smallest of which is twelve or fifteen feet, and the largest twenty five feet in diameter, weighing, unquestionably, several hundred tons. These blocks are composed chiefly of feldspar and mica of an exceedingly coarse grain, (the feldspar often occurring in crystals of an inch in diameter.) The surface of these bowlders is in every part covered with a gray moss, which gives them an extremely ancient and venerable appearance, while their sides and angles are rounded by attrition to the shape and character of most other erratic stones which are found throughout the country.

That these five immense blocks, of precisely the same character, and differing materially from all other specimens of bowlders which I have seen in the great valleys of the Mississippi and Missouri, should have been hurled some hundreds of miles from their native bed and lodged in so singular a group on this elevated ridge, is truly matter of surprise for the scientific world, as well as for the poor Indian, whose superstitious veneration of them is such that not a spear of grass is broken or bent by his feet, within three or four rods of the group; where he stops and in humble supplication, by throwing plugs of tobacco to them, solicits their permission (as the guardian spirit of the place) to dig and carry away the red stone for his pipes. The surface of these bowlders I found in every part entire and unscratched by any thing, and even the moss was every where unbroken, which undoubtedly remains so at this time, except where I applied the hammer to obtain some small specimens, which I brought away with me.\*

---

\* In a specimen with which we are favored by Mr. Catlin, the feldspar is in distinct crystals, is tinted red and greatly abounds; the quartz is gray and white, and the mica black, while the moss covers nearly half the mass.—*Eds.*

The fact alone that these blocks differ in character from all other specimens which I have seen in my travels, amongst the thousands of bowlders which are strewn over the great valley of the Missouri and Mississippi, from the Yellowstone almost to the Gulf of Mexico, raises in my mind an unanswerable question as regards the location of their native bed, and the means by which they have reached their isolated position, like five brothers, leaning against and supporting each other, without the existence of another bowlder of any description within fifty miles of them. There are thousands and tens of thousands of bowlders scattered over the prairies at the base of the Côteau on either side, and so throughout the valley of the St. Peter's and Mississippi, which are also subjects of very great interest and importance to science, inasmuch as they present to the world a vast variety of characters, and each one, although strayed away from its original position, bears incontestible proof of the character of its native bed. The tract of country lying between the St. Peter's River and the Côteau, over which we passed, presents innumerable specimens of the kind, and near the base of the Côteau, they are strewn over the prairie in countless numbers, presenting almost an incredible variety of rich and beautiful colors, and undoubtedly traceable, (if they *can* be traced,) to separate and distinct beds. Amongst these beautiful groups, it was sometimes a very easy matter to sit on my horse and count within my sight, some twenty or thirty different varieties of quartz and granite in rounded bowlders, of every hue and color, from snow white to intense red and yellow and blue, and almost to a jet black, each one well characterized and evidently from a distinct quarry. With the beautiful hues and almost endless characters of these blocks, I became completely surprised and charmed, and I resolved to procure specimens of every variety, which I did with success, by dismounting from my horse and breaking small bits from them with my hammer, until I had something like an hundred different varieties containing all the tints and colors of a painter's palette. These I at length threw away, as I had on several former occasions, other minerals and fossils, which I had collected and lugged along from day to day, and sometimes from week to week.

Whether these varieties of quartz and granite can all be traced to their native beds, or whether they all have originals at this time exposed above the earth's surface, are generally matters of

much doubt in my mind. I believe that the geologist may take the different varieties which he may gather at the base of the Côteau in one hour, and travel the continent of North America all over, without being enabled to put them all in place; coming at last to the unavoidable conclusion, that numerous chains or beds of primitive rocks have reared their heads on this continent, the summits of which have been swept away by the force of the diluvial currents, and their fragments jostled together and strewed about, like foreigners in a strange land, over the great valleys of the Mississippi and Missouri, where they will ever remain and be gazed upon by the traveller, as the only remaining evidence of their native ledges, which have been again submerged or covered with diluvial deposits.

There seems not to be, either on the Côteau or in the great valleys on either side, so far as I have travelled, any slaty or other formation exposed above the surface, on which grooves or scratches can be seen, to establish the direction of the diluvial currents in those regions; yet I think the fact is pretty clearly established by the general shapes of the valleys, and the courses of the mountain ridges which wall them in on their sides.

The Côteau des Prairies is the dividing ridge between the St. Peter's and the Missouri rivers; its southern termination or slope is about in the latitude of the Falls of St. Anthony, and it stands equidistant between the two rivers, its general course bearing two or three degrees west of north, for the distance of two or three hundred miles, when it gradually slopes again to the north, throwing out from its base the head waters and tributaries of the St. Peter's on the east; the Red River and other streams which empty into the Hudson's Bay on the north; "La Riviere Jaques" and several other tributaries to the Missouri on the west; and the Red Cedar, the Ioway and the De Moines on the south.

This wonderful anomaly in nature, which is several hundred miles in length, and varying from fifty to an hundred in width, is undoubtedly the noblest mound of its kind in the world: it gradually and gracefully rises on each side, by swell after swell, without tree, or bush, or rocks, (save what are to be seen at the Pipe Stone Quarry,) and is every where covered with green grass, affording the traveller, from its highest elevations, the most unbounded and sublime views of—nothing at all,—save the blue and boundless ocean of prairies that lie beneath and all around

him, vanishing into azure in the distance, without a speck or spot to break their softness.

The direction of this ridge clearly establishes the course of the diluvial current in this region, and the erratic stones which are distributed along the base I attribute to an origin several hundred miles northwest from the Côteau. I have not myself traced the Côteau to its highest points, nor to its northern extremity, but on this subject I have closely questioned a number of travellers who have traversed every mile of it with their carts, and from thence to Lake Winnepec on the north, who uniformly tell me that there is no range of primitive rocks to be crossed in travelling the whole distance, which is one connected and continuous prairie.

The surface of the top and the sides of the Côteau is every where strewed over with granitic sand and pebbles, which, together with the fact of the five bowlders resting at the Pipe Stone quarry, show clearly, that every part of the ridge has been subject to the action of these currents, which could not have run counter to it, without having disfigured or deranged its beautiful symmetry.

The glazed or polished surface of the quartz rocks at the Pipe Stone quarry I consider a very interesting subject, and one which will hereafter produce a variety of theories, as to the manner in which it has been formed, and the causes which have led to such singular results. The quartz is of a close grain and exceedingly hard, eliciting the most brilliant sparks from steel; and in most places, where it is exposed to the sun and the air, its surface has a high polish, entirely beyond any result which could have been produced by diluvial action, being perfectly glazed as if by ignition. I was not sufficiently particular in my examinations, to ascertain whether any parts of the surface of these rocks under the ground and not exposed to the action of the air, were thus affected, which would afford an important argument in forming a correct theory with regard to it: and it may also be a fact of similar importance, that this polish does not extend over the whole wall or area, but is distributed over it in parts and sections, often disappearing suddenly, and re-appearing again, even where the character and exposure of the rock are the same, and unbroken. In general the parts and points most projecting and exposed, bear the highest polish, which would naturally be the case whether it was produced by ignition or by the action of the air and sun. It

would seem almost an impossibility that the air passing these projections for a series of centuries, could have produced so high a polish on so hard a substance, and in the total absence of all ignigenous matter, it seems equally unaccountable that this effect could have been produced by fire. I have broken off specimens and brought them home, which have as high a polish and lustre on the surface, as a piece of melted glass; and then, as these rocks have certainly been formed where they now lie, it must be admitted that this strange effect has been produced either by the action of the air, or by igneous influence, and if by the latter cause, we can come to no other conclusion than that these results are *volcanic*; that this wall has once formed the side of an extinguished crater, and that the pipe stone, lying in horizontal strata, was formed of the lava which issued from it. I am strongly inclined to believe, however, that the former supposition is the correct one, and that the pipe stone, which differs from all known specimens of lava and steatite, will prove to be a subject of great interest, and worthy of a careful analysis.

I inclose you fair specimens of every character to be found in the locality, and also a very slight outline of the place, copied from my original drawings.

Very respectfully yours, &c.

GEO. CATLIN.

New York, March 4, 1839.

#### ART. XVI.—*Auroras and Sunset.*

##### I. *Notice of an Aurora Borealis, as observed at Rochester, N. Y.;* by Prof. C. DEWEY.

THE Aurora Borealis was splendid here as well as over the country on Tuesday eve, Sept. 3d, 1839. It was distinguished for its streams, and pillars, and cloudy-light—for centering at a point a little S. and W. of the zenith, from which it seemed to radiate in all directions, and extended greatly towards the south, as well as from the north. The yellow, white, and *crimson* light was splendid. There was no waving motion, like that in Jan., 1837.

I have an account from an observer in the middle of the State of Illinois, which may be relied upon. It is as follows:



“Sept. 3d, Brown Co., Ill. We had a splendid Aurora Borealis. The light first appeared in the northeast, of a yellow color, and spread round the horizon each way, nearly to the west on one side and southeast on the other side. The aurora then began to shoot up in brilliant pillars of yellow light below and rose-colored above. These pillars converged to a point,  $3^{\circ}$  or  $4^{\circ}$  S. of the zenith; there was no waving or rolling motion. As the brilliancy increased above, the northern horizon became dark, like a bank of fog unilluminated, and through it the stars were visible. Gradually it faded away, and bright places E. S. E. and W. N. W. were all that would attract attention. In about half an hour, most brilliant columns shot upward from these points, of yellow and crimson light, and all over the northern horizon pillars gradually developed themselves, and became extremely bright. Meanwhile, deep crimson light appeared in the southeast and stretched over to the N. W., forming a complete arch about  $50^{\circ}$  high, and under that another arch of a white light about  $30^{\circ}$  high, both distinct, regular and well-defined. The crimson one was absolutely intense in its color, as palpable as *blood*. This continued several minutes. All this time the dark bank was black in the northern horizon and probably  $25^{\circ}$  high. At length brilliant yellow pillars rose from the northern horizon through the dark bank at several points, and faded and rose again. Gradually the whole became less brilliant, and soon the splendor of the phenomenon was gone. It exceeded in splendor all that I ever saw, except that in January, two years ago.” In this, as in many cases, the Aurora seems to be *black*, as well as *colored*. The *two* arches were not nearly so distinct as described in Illinois, though one was nearly complete for some time.

Is not the color of the light depending upon the *height* at which the electric fluid or Aurora is passing, the red making its way through the lower and denser parts of the atmosphere compared with the other? That the phenomenon has any connection with spiculæ of ice in the upper regions, appears most removed from any thing tangible.

## II. Aurora of Sept. 3d, as observed at Olean, N. Y.

About half an hour after sunset a mild lighting up of the heavens in the north, as is usual, or very frequent at this season,

and in this latitude, was observed; but as the evening came on and the last light from the sun could no longer be seen, streaming rays darted up higher and more towards the zenith, while the base spread farther and farther around, until the whole horizon seemed the Auroral fountain. The atmosphere was almost entirely clear from the commencement, and what appeared for a time to be a cloud ascending from the southern horizon so suddenly vanished, that it left a doubt whether it were in reality a vapory sheet or merely a modified exhibition of this beautiful Aurora. At twenty minutes past eight, the whole vault of the sky seemed made of silvery stripes constantly changing positions, separating into blocks, and incessantly dancing from the horizon to the zenith, where they converged in a ragged cloud, that assumed, in its interval-existence, every conceivable shape.

The pencils, for the most part, were bluish white, with a tinge of leaden color; and there prevailed, during the whole display, more or less of a beautiful lake and a lilac, which being thrown occasionally like a mellow cloud over wide sections of the heavens, and combined with, or spread over the pencils, presented the richest arrangements of colorst hat, it would seem, could be gathered in the skies. In some stages, the lake gave to the sky that gorgeous appearance, observed at the rising of a summer-sun, when the clouds, thin and scarcely visible, are tipped with a deep crimson tinge. In others, it lay a broad band, unmoved by the flashes that played above and below. Like the lake, there was a sheet of white that moved about, distantly accompanied by smaller sheets or more properly segments of belts, unaffected by the flickering agitation observed above and around.

Toward the close of the exhibition, which was of interest until past ten, the sheaves of light were long, and looked, when the eye was turned a little from a direct view, like the dartings of tongued flame from a large furnace, only more brilliant, and of greater length. Being cut off in some places by bars of white clouds near the horizon, the interest of the scene was heightened by the more rapid movement which was apparent near the bases of the pencils.

The focus continued very near the same point, which was about four degrees directly south from the zenith. At times the point to which all the sheaves tended, would be glowing as if with accumulated light, that looked like a torrent at its entrance,

within a circle around of a few degrees in diameter ; and again it would be a mere blank, all the pencils melting away before uniting.

Four meteors were seen to fall during the observations ; one to the southwest, and the other three toward the south.

*Observations.*—Notes of the changes were at first taken once in from one to four minutes, and even these were not frequent enough to record all the changes ; and oftentimes as many occurred during the time employed in writing a single remark as were witnessed in the intervals of employment with the pencil.

At 20 minutes past 8 o'clock the whole vault of the heavens was overspread with a series of alternating pencils of bluish white light, with the blue sky beyond, which converged to a point less than five degrees directly south from the zenith, a brilliant lake bar extending from the eastern to near the western horizon, about in the pathway of the sun.

23m. past 8. Red light in masses east and west of the zenith, the bar not continuous.

25m. past 8. Lake bar replaced and more brilliant than at first. Bright white ragged cloud in the centre.

27m. past 8. The lake or red in bright portions near the eastern and western extremes of the bar. Pencils in the south change from white to lilac and from lilac to white with great rapidity.

31m. past 8. Grown dim and again brightened up. Pencils most bright in S. E. and S. W.

34m. past 8. Intensely white pencils shoot up from the N. W. and N. E., most bright at the base.

Focus vanished and the crimson hues mildly shed all around.

35m. past 8. Focus re-established, with a bluish white group of rays radiating all about. The red pale, but most distinct in the west.

38m. past 8. Red in the west, but brightest in the northwest. Focus alternately vanishing and returning. Lilac and white about the zenith.

41m. past 8. Crescent in the focus and two parallel curved belts or crescents more nearly, of white in the southern heavens.

43m. past 8. Dim and thin vapory clouds rising in the south, tipped with the Aurora.

One bar of white light across the southern sky.

47m. past 8. Crescent inverted. Light growing more brilliant in the north and waning in the south.

50m. past 8. Bright pencils streaming up from a little north of east. Reddish or crimson hues barely perceptible.

53m. past 8. Clouds rising higher in the south.

55m. past 8. Crimson hues hardly to be discerned in the east and west. Flashes less rapid.

57m. past 8. Gathering again of crimson in the east. The rising clouds from the southern horizon are gorgeously lit up with the rays darting from behind them.

58m. past 8. Lake in the east is more like a sheet of flame than any thing else with which it may be compared.

2m. past 9. Lake in the east, as at the rising of a summer's sun. Supremely beautiful!

Below the clouds that have been climbing up from the south, lies a dark stratum of lilac.

4m. past 9. The bright sheet of lake in the east has ascended.

7m. past 9. A very bright ragged cloud constitutes the focus.

10m. past 9. Crimson almost gone.

15m. past 9. Crimson spread all over the north.

20m. past 9. The western sky decked with superbly brilliant red. Below a stripe of dark sky or cloud in the north, the pencils change so frequently and rapidly that the view is more like a glance at a fairy festival than at the mere sky.

25m. past 9. A broad stripe of very intensely brilliant lake, inclined at an angle of about  $60^\circ$  with the horizon, rising in the west and extending two-thirds of the way to the zenith.

30m. past 9. Growing dim.

35m. past 9. Lake most bright in the southeast. Light stripe resting upon a dark one about  $3^\circ$  in breadth.

40m. past 9. Fast growing dim.

45m. past 9. Flashings as of flame, more distinct than before. The white stripe of the south moved around to the west, accompanied above by the lake. Focus alternately existing and gone.

50m. past 9. Flashes more vivid and long. Crimson spreading around to the south.

5m. to 10. Lake again south and west, but most brilliant far, in the north. Lake in the south a stripe of  $10^\circ$  width, dim toward the margins.

10 o'clock. Crimson all gone.

5m. past 10. Flashing every where disappeared, except near the focus. Fogs coming on from the streams.

10m. past 10. Scattering broad sheaves of light, like fragments of thin white clouds, convergence of the pencils perceptible, but the focus disappeared.

Half past 10. All disappeared except the light of an ordinary Aurora in the north.

### III. *Sunset at the West*; by Prof. C. DEWEY.

To a native of New England, few objects appear more beautiful than the setting of the sun as it appears from the hills and valleys of her mountains. The clearness of the atmosphere, and the brilliancy of the colors, fasten his gaze upon the west as the sun has just sunk behind the mountains. As he passes, however, to the middle and western part of the State of New York, the sunsets become still more beautiful, and often absolutely splendid. The atmosphere does not appear more transparent and clear, but the variety of colors is greater, and they have a greater strength; the clouds show a more deep and brilliant reflection of red and yellow rays, and often the most splendid radiations of light soon after the sun has disappeared below the horizon. Those radiations have considerable uniformity, and yet they have much variety. They were well depicted in this Journal, Vol. xxxiii, p. 338-340. Between the broad radiating beams of red or yellow light, there is often the most beautiful and intense *blue*. If it is merely the common color of a clear sky, the intensity of the blue is greatly augmented by the contrast of the red or yellow light. Those radiations do not very often appear, although they occur many times in the course of several months. They begin sometimes so early as July, and do not cease till late in October. When the radiations do not appear, there is also an unusual splendor in the sunsets, transcending all I have ever witnessed in New England, or on the east side of the Allegany ridge. I have not been able to ascertain the peculiarity of the atmosphere when the splendid radiations are shown. They occur just after sunset, and last only for a few minutes. In the article referred to, it is suggested that the appearance may depend upon the reflection of the sun's light from the surface of the great lakes at the west of us. The supposition is very ingenious and interesting, but seems not to be true in fact, as is proved by the same appearances at the west of the lakes. In

the State of Illinois, the radiations are described as being even more beautiful and splendid than in this part of the state. From two individuals in distant parts of Illinois, I have received particular notices of the brilliancy of this *vision*, as compared with our own, by those who have admired it in both states. On the evening of July 4th, 1839, the sunset was splendid here, and more so in Illinois. An engineer in the middle of the state says, "the radiations like those of July 4th were not uncommon, at least in the summer of 1838. I noticed the appearance many times, and called the attention of others to it. Some facts are obvious. It never occurred before sunset, but from three to ten minutes after, and generally about five, and lasted from three to ten minutes—perhaps none of it ever remaining fifteen minutes after the sun had gone down. The radiations differed in breadth when compared one with another, and each increased in width with the distance from the sun, being one, two, or three, and perhaps four apparent diameters of the sun in breadth at the lowest visible part of the horizon. The color is generally pale yellow or straw color. Sometimes three radiations lie nearly along the horizon, diverging but little from it, of a reddish or rose color, and the more central radiations violet or bluish, not very vivid, but well defined, for the background seems always whitish. The central radiations sometimes extend nearly to the zenith, pale and diffused at the upper part, and generally from  $30^{\circ}$  or  $40^{\circ}$  to  $60^{\circ}$  long. Sometimes they occur on three successive days; when there has been little of storm for months; atmosphere very clear, and few clouds, and the sky too blue and brilliant to look at. The whole is beautiful. The sunsets are the most gorgeous that I ever beheld, and the hues upon the clouds are brilliant beyond description or comparison." No reflection from waters can account for these splendid appearances of nature.

## MISCELLANIES.

## DOMESTIC AND FOREIGN.

1. *Proceedings of the American Philosophical Society,\* January 5, 1838.*—The result of the annual election for officers held this day, was reported by the judges and clerks as follows:—

*President.*—Peter S. Du Ponceau, LL. D.

*Vice Presidents.*—Nathaniel Chapman, M. D., Joseph Hopkinson, LL. D., Robert M. Patterson, M. D.

*Secretaries.*—Franklin Bache, M. D., John K. Kane, Alexander D. Bache, LL. D., J. Francis Fisher.

*Counsellors for three years.*—Robert Hare, M. D., William Meredith, William Hembel, Jun., Charles D. Meigs, M. D.

*Curators.*—Isaac Lea, Isaac Hays, M. D., Franklin Peale.

*Treasurer.*—John Vaughan.

Mr. Lea read a paper in continuation of his memoir on fresh water and land shells, which was referred.

*January 19, 1838.*—Mr. Lea read a paper in further continuation of his memoir on fresh water and land shells, which was referred.

Mr. Walker presented to the notice of the Society, the drawings of a self-registering anemometer and rain gauge invented by Mr. Follett Osler, of Birmingham, England, of which he explained the character and advantages.

The Society elected John Vaughan, librarian.

Mr. Vaughan announced the death of Joshua Humphreys, a member of the Society, aged 86.

The following candidates were elected members:—

Capt. ANDREW TALCOTT, late of the U. S. Engineers.

THOMAS W. GRIFFITH, Esq., of Baltimore.

CHARLES G. B. DAUBENY, M. D., of the Univ. of Oxford.

HENRY REED, Esq., of the University of Pennsylvania.

WILLIAM NORRIS, of Philadelphia County.

WILLIAM SULLIVAN, Esq., of Boston.

*February 2, 1838.*—A letter was read from John K. Townsend, dated January 20th, 1838, announcing the transmission of the Indian Vocabularies collected for the Society, and of certain shells and geological specimens, selected for its use by Mr. Peale.

A communication from the late Joshua Humphreys, Esq., dated December 23d, 1837, was read, on the subject of the early history of

---

\* We were ignorant until recently, that the American Philosophical Society published reports of their doings. Had these reports been earlier transmitted, they would have been sooner noticed.—*Eds.*

the naval construction of the United States, tending to correct an erroneous impression as to the opinions and wishes of President Washington on the subject of the navy, which had found place in Professor Tucker's Biography of Mr. Jefferson, and which had been the subject of remark by Dr. Harris in his Life of Bainbridge. This communication was referred to the Historical Committee.

The president communicated a letter to him from Mr. Tyson, of the House of Representatives of Pennsylvania, dated Jan. 29th, 1838, giving intelligence in relation to the ancient records of the State, and of the proposed publication of them at the public expense.

February 16, 1838.—Professor Henry, of Princeton, made a verbal communication on the lateral discharge of electricity, while passing along a wire as in the Leyden experiment, or communicated directly to an insulated wire, or to a wire connected with the earth; and detailed various experiments proving that free electricity is not, under any circumstances, conducted silently to the earth.

Dr. Bache announced the death of Dr. John Eberle, a member of the Society, who died at Lexington, Ky., on the 2d of Feb., aged 54.

March 2, 1838.—The Historical Committee announced that they had completed the publication of Mr. Du Ponceau's Dissertation on the Nature and Character of the Chinese System of Writing, forming volume second of the Historical Transactions of the Society.

Mr. Walker read a paper, entitled "Determination of the Longitude of several Stations near the Southern Boundary of Michigan; calculated from Transits of the Moon and of moon culminating Stars, observed in 1835 by Andrew Talcott, late Captain of United States Engineers."

The longitude of places in the United States, north of the Ohio, had hitherto depended on the observations of Ellicott and De Ferrer, made at points on the banks of the Ohio river, and on meridian lines drawn from this river, several hundred miles northward, by the deputy surveyors. From Mr. Walker's computations, it appears that *Turtle Island, Lake Erie*, has been placed only 1.7 geographical miles too far east on Tanner's map. Its true place is  $41^{\circ} 45' 9''$  N. latitude; and 5 hours, 33 min. 34.3 sec. W. longitude from Greenwich. Also, *South Bend Lake, Michigan*, has been placed 3.9 miles too far east; its true place being N.  $41^{\circ} 37' 6''$ ; W. 5 hours, 49 min. 15.3 sec. These observations of Capt. Talcott will prove highly useful to geographers, by furnishing standard points of reference in the northernmost part of the United States.

Mr. Vaughan announced the death of Benjamin Dearborn, of Boston, a member of the Society, who died on the 22d of Feb., 1838, aged 83.

March 16, 1838.—Mr. Lea invited the attention of the Society to certain facts, mentioned in a "Memoire sur quelques Acephales d'eau



douce du Senegal," by Mr. Rang, in relation to the torpidity of the *Anodonta Chaiziana*.

*April 6, 1838.*—Dr. Patterson announced the death of Dr. Nathaniel Bowditch, a member of the Society, who died on the 16th of March last, aged 63. Dr. Patterson was appointed to prepare a necrological notice of the deceased.

Mr. Du Ponceau mentioned the death, not heretofore reported, of Mr. Adet, a member of the Society, who died in March, 1834.

*April 20, 1838.*—Mr. Lea read a Note supplementary to his Memoir, now in the Society's press, on the subject of the Uniones, and permission was given to add the same to the principal communication.

The following candidates were elected members :—

WILLIAM HARRIS, M. D., of Philadelphia.

ROBERT TREAT PAINE, of Boston.

JOHN P. EMMET, M. D., of the University of Virginia.

HUGH S. LEGARE, of Charleston, S. C.

SAMUEL BRECK, of Philadelphia.

Col. SYLVANUS THAYER, U. S. Engineers.

FRANCIS WAYLAND, D. D., of Brown University.

HENRY BALDWIN, of Pennsylvania.

WILLIAM H. PRESCOTT, of Boston.

*May, 4, 1838.*—Pursuant to appointment, Dr. Horner read a necrological notice of Dr. Philip Syng Physick, late a member of the Society. Dr. Horner having expressed a wish to make the same public, permission was granted to him to withdraw it from the files of the Society for publication.

Dr. Patterson read a letter from Professor Henry, of Princeton, dated May 4, 1838, announcing that, in recent experiments, he has produced directly from ordinary electricity, currents by induction analogous to those obtained from galvanism; and that he has ascertained that these currents possess some peculiar properties, that they may be increased in intensity to an indefinite degree, so that if a discharge from a Leyden jar be sent through a good conductor, a shock may be obtained from a contiguous but perfectly insulated conductor, more intense than one directly from the jar. Prof. Henry remarks that he has also found that all conducting substances screen the inductive action, and that he has succeeded in referring this screening process to currents induced for a moment in the interposed body.

Dr. Hare exhibited to the Society fourteen and a half ounces of platinum, fused by his hydro-oxygen blowpipe, and a specimen of pure platinum, freed from iridium by the process of Berzelius.

Dr. Patterson submitted to the Society's inspection, the log-book of the steam-ship Savannah, Capt. Moses Rogers, launched at New

York on the 22d of August, 1818; from which it appears that, after repeated voyages between New York, Savannah, and Charleston, this vessel left Savannah on the 24th or 25th of May, 1819, for Liverpool, saw Land's End on the 17th of June, and arrived at Liverpool on the 20th of June, having used steam thirteen days, and having exhausted her fuel (coal) three days before arrival. It also appears from the log-book that she left Liverpool on the 23d of July, arrived at Elsinour on the 9th of August, left Elsinour on the 14th of August, arrived at Stockholm on the 22d of August, left Stockholm on the 5th of September, arrived at Cronstadt on the 9th of September, and after several excursions between Cronstadt, &c., and Copenhagen, &c., left Arundel, Copenhagen, on the 23d of October, and arrived at Savannah on the 30th of November; that she subsequently arrived at Washington from Savannah on the 16th of December, after a passage of eleven days; that she was sold at Washington in September, 1820, and her engine taken out, after which she sailed as a packet, from New York to Savannah, until September, 1822, when she was lost. This log-book was supposed to derive additional interest from the recent arrival of the Sirius and Great Western, steam-ships, at New York, from England.

Dr. Mitchell repeated before the Society, Thilorier's process for solidifying carbonic acid, with an apparatus, made under his direction in Philadelphia, somewhat modified from that employed by Thilorier, and froze a quarter of a pound of mercury by the admixture of the solidified acid with nitrous ether.

*May 18, 1838.*—The Librarian read the translation of a letter from Pierre de Goetz to Mr. Du Ponceau, dated St. Petersburg, August 17th, (29th,) 1837, on behalf of the Imperial Russian Academy, announcing the transmission to the Society of the works which have been published by the Academy, numbering fifty seven volumes, and also of a donation of several volumes from himself personally.

Dr. Bache announced the death of Thomas Bradford, the latest survivor of the original members of the Society, who died on the 7th of May, 1838, aged 93 years and 3 days.

Dr. Hare communicated orally, that he has found that when the elements of water are exploded in contact with certain gases or essential oils, the aqueous elements, instead of condensing, combine with the hydrogen and carbon, and form a permanent gas.

*June 15, 1838.*—A communication was read, dated Cincinnati, May 7th, 1838, from Dr. John Locke, on the subject of Magnetic Observations, which was referred.

Dr. Dunglison announced the death of Thomas W. Griffith, of Baltimore, a member of the Society.

*July 20, 1838.*—Mr. Kane, from the Secretaries, reported that they had chosen Dr. Franklin Bache to be the Reporter of the Society.

The Committee appointed on the communication of Dr. John Locke of Cincinnati, read at the last meeting, [consisting of Messrs. Peter S. Du Ponceau, R. M. Patterson, and J. Saxton,] made the following report, which was adopted.

“The Committee to whom was referred the communication of Prof. John Locke of Cincinnati, report, that it gives the details of a series of experiments, made for the purpose of determining the magnetic intensity and dip for certain positions in Ohio. For these experiments he had furnished himself in London with the best apparatus, and had vibrated there two needles of the form recommended by Hansteen, and one in the form of a small flat bar. Five months afterwards, namely, on the 17th of January, 1838, he again vibrated these needles at Cincinnati, and found the ratio of horizontal intensity at the former place to that at the latter, as follows: by needle No. 1, as 1 to 1.1624; by needle No. 2, as 1 to 1.1639; by No. 3, as 1 to 1.2037. Of these results the author prefers the last; inasmuch as the magnetism of needles is liable to decrease, but not to increase.

“On the 20th of August, 1837, he made experiments with his dipping needle, to determine the dip at Westbourn Green, near London, the mean of which gives  $69^{\circ} 23'.3$ .

“On the 26th of November, 1837, the mean of a series of experiments made at Cincinnati, in lat.  $39^{\circ} 6' N.$ , and long.  $84^{\circ} 27' W.$ , gave the dip  $=70^{\circ} 45'.75$ .

“At Dayton, Ohio, in lat.  $39^{\circ} 44' N.$ , and long.  $84^{\circ} 11' W.$ , the dip was found to be  $71^{\circ} 22'.75$ , on the 26th of March, 1838.

“At Springfield, Ohio, in lat.  $39^{\circ} 53' N.$ , and long.  $83^{\circ} 46' W.$ , the dip was found on the 29th of March, 1838, to be  $71^{\circ} 27'.375$ .

“At Urbana, lat.  $40^{\circ} 03' N.$ , long.  $83^{\circ} 44' W.$ , March 30, 1838, the dip was found  $=71^{\circ} 29'.94$ .

“At Columbus, the seat of government of Ohio, lat.  $39^{\circ} 57' N.$ , long.  $83^{\circ} W.$ , April 3, 1838, the dip was found  $=71^{\circ} 04'.875$ .

“The interest of this paper is much increased by the circumstance that no accurate experiments on the intensity and dip of the needle have heretofore been made in the United States, west of the Alleghany mountains.

“The Committee conclude their report, by recommending that Prof. Locke's communication be printed in the Society's Transactions.”

The claims of Dr. Henry Hall Sherwood to remarkable discoveries in magnetism were discussed: both his postulates and his deductions were considered erroneous. [For his claims, see this Journal, 34: 210.]

Dr. Bache announced the death of Charles Maurice Talleyrand, Prince of Benevento, a member of the Society, who died on the 17th of May, 1838, aged 83.

August 17, 1838.—On motion of Dr. Patterson, a Committee was appointed to observe the eclipse of the Sun of the 18th of September next. Committee, Dr. Patterson, Mr. Walker, Mr. Paine, and Capt. Talcott.

Sept. 21, 1838.—The Committee on the solar eclipse of the 18th of September, made a report in part, comprising the observations made at Philadelphia, the principal results of which are as follows.\*

The observations made at Philadelphia are fifteen in number. A list of observers, telescopes, &c. is given in the following table. The correction in the third column is to be added algebraically to the latitude of the place of observation, to obtain that of the State House, +39° 56' 58". The correction in the fourth column is likewise to be added to the local longitude in time, to obtain that of the State House, + 5h. 0m. 39.2s.

No.	OBSERVERS.	Reduction to Latitude of State House.	Reduction to Longitude of State House.	Focal length in feet.	Maker of Telescope.	Description.	Screen Glass.	Estimated Power.
1.	E. J. Beans . . . .	-70.0	-1.70	2.5	Unknown.	Spy-glass	smoked	15
2.	Wm. Penn Cresson	- 1.8	" 5.20	2.5	Jones.	Achromatic	red.	30
3.	Prof. W. R. Johnson	- 1.8	" 5.20	3.5	Dollond.	"	"	100
4.	George M. Justice	-10.0	" 2.86	2.5	Jones.	Gregorian	"	80
5.	E. O. Kendall . . .	-10.0	" 2.86	2.5	Plössl.	Dialytic	green	50
6.	Joseph Knox . . .	-21.0	+1.39	3.5	Dollond.	Achromatic	red.	80
7.	Isaiah Lukens . . .	- 9.0	-0.86	1.8	Plössl.	Dialytic	yellow	20
8.	Thomas M'Euen	+ 0.4	" 2.33	2.5	Dollond.	Achromatic	red.	60
9.	Prof. Roswell Park	- 6.5	" 1.30	2.5	"	Gregorian	"	50
10.	Dr. R. M. Patterson	- 1.1	" 1.20	5.0	"	Equatorial	"	100
11.	Wm. H. C. Riggs	+ 0.4	" 2.33	3.5	"	Achromatic	"	50
12.	Samuel Sellers . .	- 7.5	" 0.05	2.5	Jones.	"	"	40
13.	Tobias Wagner . .	-10.0	" 2.86	3.5	Dollond.	"	"	80
14.	Sears C. Walker . .	-10.0	" 2.86	5.0	Tulley.	"	"	100
15.	William Young . .	+21.0	+1.39	7.0	Holcomb.	Herschelian	"	200

*Phases Observed, in Mean Times of the Places of Observation.*

No.	A.		B.		C.		D.		F.		H.		I.		K.		L.		M.		N.		O.		P.		
	h	m	h	m	h	m	h	m	h	m	h	m	h	m	h	m	h	m	h	m	h	m	h	m	h	m	
1																											
2																											
3																											
4																											
5																											
6																											
7																											
8																											
9																											
10																											
11																											
12																											
13																											
14																											
15																											

\* For observations on this eclipse, made at Yale College, see Vol. xxxv, p. 174, of this Journal.—Eds.

† Doubtful.

A. *Beginning.* Prof. Johnson noticed dark indentations for eight seconds after the first disturbance of the limb.

B. Arch of faint light, with speck or brush in centre, round the moon's limb beyond the cusps; brush or blaze in centre, between cusps, extending outwards about two digits. One cusp broken at end, presenting a bright bead.

C. Arch of light much increased in brightness; the brush or blaze, at first in the centre, now extends from cusp to cusp; radiation outwards, nearly three digits; cusps distant  $30^\circ$  on sun's limb, a broken point or bead at each end. This phase noted as that of the formation of the ring by Nos. 1, 2, 3, 4, and 11.

D. *Formation of ring, or instant of osculation of limbs.* This phase noticed as the approach of two sharp well defined points to a contact by Nos. 5 and 15. It was observed at the instant when the cusps, apparently  $20^\circ$  of the sun's limb apart, suddenly united by the extension of four or five luminous beads, or rounded portions of the sun's disc, by Nos. 3, 4, 8, 9, 10, 11, 13, and 14.

E. Omitted in the table. This letter refers to the time when the dark lines, described by Van Swinden and Baily, should have appeared. They were not seen by any observer, though carefully searched for.

F. Perfect ring, the beads of light having united, or run into each other suddenly.

G. Counterpart of E, not observed though looked for.

H. *Rupture of ring*, counterpart of D. Took place at a point, and so noted by all the observers.

I. Appearance of beads, five or six in number, extending from cusp to cusp.

K. Counterpart of C in every respect.

L. Counterpart of appearance just preceding C. Brush or blaze of light, narrowed down to a small space,  $3^\circ$  or  $4^\circ$  on the moon's border, extending outwards  $2\frac{1}{2}$  digits; cusps still broken, as seen by most of the observers. Nos. 5 and 15, however, saw no irregularity of cusps, no beads of light.

M. Final disappearance of arch of faint light, with brush of light extending beyond the middle, having previously become very faint. This phenomenon observed with great care and certainty by No. 10.

N. Appearance of dark lines extending into the sun's disk, noticed by Nos. 3, 4, 10, and 14. The time noted by Nos. 3 and 14 as the end of the eclipse.

O. *End of eclipse*, inferred by each observer from his notes.

P. Final disappearance of the dark lines, the sun's disc having resumed its natural shape. Nos. 3, 4, 10, and 14 inferred the time of O as at some instant intermediate between N. and P. The time of external contact difficult to determine, on account of this irregularity.

For the convenience of computers, the local times above given have been reduced to their corresponding value for the State House by E. O. Kendall, by means of his formulæ, in Vol. xx, of the Journal of the Franklin Institute, p. 125, which gives the following values for the variation of the local times of the several phases, for a small variation of terrestrial latitude or longitude, as follows :—

	Beginning. <i>s.</i>	Ring. <i>s.</i>	End. <i>s.</i>
Variation for † or north 1" terr. lat.	= -0.0397	-0.0382	-0.0343
Do. † or west 1s. of terr. lon. in time	= -1.2600	-1.1400	-0.9925

The means of his results for the State House, giving to each observation its proper weight, in mean time of the State House, are,

	<i>h.</i>	<i>m.</i>	<i>s.</i>
Beginning,	3	13	10.06
Formation of ring,	4	31	18.76
Rupture of ring,	4	35	31.35
End,	5	45	15.46
Duration of eclipse,	2	32	5.40
Duration of ring,		4	12.59

Mr. Du Ponceau presented a communication, entitled "A Vocabulary of the Language of the Valiente Indians, who inhabit the State of Costa Rica, in Central America, by Col. D. Juan Galindo, of Guatemala." Referred to the Historical and Literary Committee.

Mr. Nulty read a mathematical paper, entitled "New Formulæ relative to Comets, by E. Nulty, of Philadelphia." Referred to Dr. Patterson, Mr. Walker, and Capt. Talcott.

The subject of this paper was the component velocities of a comet, observed at three consecutive and moderately small intervals of time. In a preliminary notice of his subject and the means employed in its development, the author mentioned some advantages which he conceived to be attached to his peculiar mode of investigation. He alluded to different results already known, and, with several novel and general formulæ comprised in his paper, he announced two new sets of expressions which he represented as being directly applicable to the exceptive cases, in which particular observations render the forms hitherto given, doubtful or indeterminate. He also noticed a numerical application which he made of his formulæ and of others connected with the method of Laplace, to the data of the comet of 1803; and he intimated that a comparison of the results obtained by him in that and other instances, had led him to some remarks, which he inserted towards the close of his paper, from his opinion of their analytical and practical importance.

Dr. Patterson read a paper by Professor Charles Bonnycastle, of the University of Virginia, containing "Notes of experiments, made August

22d to 25th, 1838, with the view of determining the depth of the sea by the echo."

This paper, which was not offered for publication in the Society's Transactions, states that the generally received notions in regard to the intensity of sound in water, and the distance to which it is conveyed, had suggested to Mr. Bonnycastle, some years ago, the idea that an audible echo might be returned from the bottom of the sea, and the depth be thus ascertained from the known velocity of sound in water. The probability of this view was deemed at least sufficient to justify an experiment; and accordingly the Navy Commissioners authorized the construction of the necessary apparatus, and Captain Gedney, of the U. S. Brig Washington, attached to the coast survey, volunteered his services and the use of his vessel, and authority to this effect was liberally granted by the Secretary of the Treasury, Mr. Woodbury.

The apparatus, which is fully described in Mr. Bonnycastle's paper, consisted, first, of a petard or chamber of cast iron,  $2\frac{1}{2}$  inches in diameter and  $5\frac{1}{4}$  inches long, with suitable arrangements for firing gunpowder in it under water; secondly, of a tin tube, 8 feet long and  $1\frac{1}{4}$  inches in diameter, terminated at one end by a conical trumpet-mouth, of which the diameter of the base was 20 inches, and the height of the axis 10 inches; thirdly, of a very sensible instrument for measuring small intervals of time, made by J. Montandon of Washington, and which was capable of indicating the sixtieth part of a second. Besides these, an apparatus for hearing was roughly made on board the vessel, in imitation of that used by Colladon in the Lake of Geneva, and consisted of a stove-pipe,  $4\frac{1}{2}$  inches in diameter, closed at one end, and capable of being plunged four feet in the water. The ship's bell was also unhung, and an arrangement made for ringing it under water.

On the 22d of August, the brig left New York, and in the evening the experiments were commenced. In these, Mr. Bonnycastle was assisted by the commander and officers of the vessel, and by Dr. Robert M. Patterson, who had been invited to make one of the party.

In the first experiments, the bell was plunged about a fathom under water and kept ringing, while the operation of the two hearing instruments was tested at the distance of about a quarter of a mile. Both instruments performed less perfectly than was expected; the noise of the waves greatly interfering, in both, with the powers of hearing. In the trumpet-shaped apparatus, the ringing of the metal, from the blow of the waves, was partly guarded against by a wooden casing; but, as it was open at both ends, the oscillation of the water in the tube was found to be a still greater inconvenience, so that the sound of the bell was better heard with the cylindrical tube. At the distance of a quarter of a mile this sound was a sharp tap, about the loudness of that occasioned by

striking the back of a penknife against an iron wire : at the distance of a mile the sound was no longer audible.

In the second experiments, the mouth of the cone, in the trumpet apparatus, was closed with a plate of thick tin, and both instruments were protected by a parcelling of old canvas and rope-yarn, at the part in contact with the surface of the water. In these experiments the cone was placed at right angles to the stem, and the mouth directed toward the sound. The distances were measured by the interval elapsed between the observed flash and report of a pistol. At the distance of 1400 feet, the conical instrument was found considerably superior to the cylindrical, and at greater distances the superiority became so decided, that the latter was abandoned in all subsequent experiments. At the distance of 5270 feet, the bell was heard with such distinctness as left no doubt that it could have been heard half a mile further.

The sounds are stated in the paper to have been less intense than those in air, and seemed to be conveyed to less distances. The character of the sound was also wholly changed, and, from other experiments, it appeared that the blow of a watchmaker's hammer against a small bar of iron gave the same sharp tick as a heavy blow against the large ship's bell. It is well known that Franklin heard the sound of two stones struck together under water at half a mile distance ; yet two of the boat's crew, who plunged their heads below the water, when at a somewhat less distance from the bell, were unable to hear its sound.

On the 24th of August, the vessel having proceeded to the Gulf Stream, experiments were made with the view for which the voyage was undertaken ; that is, to ascertain whether an echo would be returned, through water, from the bottom of the sea. Some difficulties were at first presented in exploding the gun under water, but these were at length overcome. The hearing-tube was ballasted so as to sink vertically in the water. The observers then went, with this instrument, to a distance of about 150 yards from the vessel, and the petard was lowered over the stern, about three fathoms under water, and fired. The sound of the explosion, as heard by Mr. Bonnycastle, was two sharp distinct taps, at an interval of about one third of a second. Two sounds, with the same interval, were also clearly heard on board the brig ; but the character of the sounds was different, and each was accompanied by a slight shock. Supposing the second sound to be the echo of the first from the bottom of the sea, the depth should have been about 160 fathoms.

To ascertain the real depth, the sounding was made by the ordinary method, but with a lead of 75 pounds weight, and bottom was distinctly felt at 550 fathoms, or five furlongs. The second sound could not, therefore, have been the echo of the first ; and this was proved, on the following day, by repeating the experiment in four fathom water, when the double sound was heard as before, and with the same interval.



The conclusion from these experiments is, either that an echo cannot be heard from the bottom of the sea, or that some more effectual means of producing it must be employed.

Dr. Hare suggested the expediency of employing the Galvanic fluid to fire gunpowder below the surface of water, in experiments similar to those of Professor Bonnycastle.

The President laid on the table for the inspection of the members, an English and Japanese, and Japanese and English Vocabulary, by the Rev. W. H. Medhurst, late of Batavia, now in London, and a "Translation of a comparative Vocabulary of the Chinese, Corean, and Japanese Languages, to which are added the thousand Characters classic, in Chinese and Corean; the whole accompanied by copious Indexes of all the Chinese and English Words occurring in the Work," by the same author, under the name of Philo-Sinensis.

These two books, the President said, throw considerable light on the various graphic systems of the Indo-Chinese nations; they had been communicated to him by our associate, Mr. Pickering, of Boston, to whom they must be returned; he, therefore, recommended to the society to take measures to procure them for the library.

The recommendation of the President was then adopted, and the books referred to, ordered by the society.

Dr. Hare laid before the society, a specimen of platinum, weighing between twenty two and twenty three ounces, being part of a mass of twenty five ounces, fused by him in May last, by means of his compound blowpipe.

Dr. Hare also mentioned that he had observed, during a recent tornado at Somerset, Mass., various circumstances, which he detailed, all leading to the conclusion that a hiatus or place of rest exists at the centre of motion of the tornado.

Oct. 5, 1838.—The Committee on the solar eclipse of the 18th of September, made a further Report in part.

This portion of the report embraced the observations made in the vicinity of Philadelphia, of which the following are the principal results, arranged in the order in which they were received, and, with one exception, in mean time of the place of observation; the longitudes being reckoned from Greenwich.

No. 16, by Robert Treat Paine, Esq., at the west front of the Capitol, Washington. Latitude  $38^{\circ} 53' 23''$  N., as determined by Mr. Paine, with his Troughton's sextant. Longitude *5h. 8m. 8s.* west. With  $3\frac{1}{2}$  feet equatorial, green screen glass. Time by three chronometers, regulated by eastern and western altitudes of sun and stars, with his Troughton's sextant.

	<i>h.</i>	<i>m.</i>	<i>s.</i>
Beginning, . . . . .	3	6	9.58
Formation of ring, . . . . .	4	24	28.15
Rupture of ring, . . . . .	4	30	18.55
End, . . . . .	5	39	54.89
Duration of eclipse, . . . . .	2	33	45.31
Do. of ring, . . . . .		5	50.40

“The ring formed instantaneously, and broke nearly so. No beads were seen, nor the dark lines mentioned by Mr. Baily, nor the light round the moon, although all were looked for. No distortion of the moon’s limb could be seen, and the cusps of the sun, before the ring formed, were as sharp as needles.”

No. 17, by Lieut. Gilliss, U. S. N., at the Marine Observatory, Washington City, N. 8", W. 0.08s. in time, from the Capitol, with a 3½ feet achromatic, green screen glass, power 50. Astronomical clock regulated by a five feet transit instrument.

	<i>h.</i>	<i>m.</i>	<i>s.</i>
Beginning, . . . . .	3	6	10.4
Formation of ring, . . . . .	4	24	28.4
Rupture of ring, . . . . .	4	30	18.9
End, . . . . .	5	39	56.4
Duration of eclipse, . . . . .	2	33	46.0
Do. of ring, . . . . .		5	50.5

“At beginning of eclipse, limbs sharp and well defined. The same at formation and rupture of the ring, only in the former the light seemed to flash round the moon’s limb.” Two detached arched portions of the ring were seen separated from the cusps, “while the space between presented points of light (beads) only.”

No. 18, by Prof. Elias Loomis, at the Observatory of the Western Reserve College, Ohio. Latitude 41° 14' 42" N. Longitude 5h. 25m. 35s. W. With a five feet equatorial, mounted on a stone pier under a revolving dome, with yellow screen glass, power 150, nearly. Astronomical clock regulated by a 30 inch transit circle by Simms.

Beginning 14h. 27m. 26.7s. sidereal time.

Other phases lost by clouds.

Nos. 19 and 20, by J. Gummere and his son S. J. Gummere, at the Haverford School Observatory, Chester County, Pa. Latitude 41° 1' 12" N. Longitude 5h. 1m. 16s. W. With two 3½ feet telescopes by Tulley, with red screen glasses, powers 75, nearly. Astronomical clock regulated by a Dollond’s portable transit instrument.

	<i>h.</i>	<i>m.</i>	<i>s.</i>
Beginning, . . . . .	3	12	17.2
Formation of ring, . . . . .	4	30	29.2
Rupture of ring, . . . . .	4	34	44.8

	<i>h.</i>	<i>m.</i>	<i>s.</i>
End, . . . . .	5	44	28.7
Duration of eclipse, . . . . .	2	32	11.5
Do. of ring, . . . . .	4	15.6	

Arch of faint light, with brush in centre, seen before the formation of the ring. Arch seen after rupture, brush of light not recollected. Formation and rupture of the ring, by broken portions of the sun's border, several in number, not round like beads, but arched portions of the ring. These continued several seconds, and then suddenly united in the first instance, and separated in the last, without, however, exhibiting the dark lines figured by Baily.

Nos. 21 and 22, by Charles Wister and his son Caspar E. Wister, at the Observatory of the former, Germantown. Latitude  $40^{\circ} 1' 59''$  N. Longitude 2.7s. in time west of the State House. With  $2\frac{1}{2}$  and 2 feet Gregorian reflectors. Astronomical clock regulated by a 3 feet transit instrument.

	<i>C. Wister.</i>			<i>C. E. Wister.</i>		
	<i>h.</i>	<i>m.</i>	<i>s.</i>	<i>h.</i>	<i>m.</i>	<i>s.</i>
Beginning, . . . . .	3	12	55.4	3	12	54.4
Formation of ring, . . . . .	4	31	9.4	4	31	8.4
Rupture of ring, . . . . .	4	35	18.4	4	35	18.4
End, . . . . .	5	45	8.4	5	45	7.4
Duration of eclipse, . . . . .	2	32	13.0	2	32	13.0
Do. of ring, . . . . .	4	9.0		4	10.0	

"The lucid points and dark intervening spaces corresponded closely to Baily's description."

No. 23, John Griscom. Latitude  $9.7''$  N., longitude 0.3s. in time west of the Observatory of Haverford School. With a  $3\frac{1}{2}$  feet Dollond achromatic, power 80.

	<i>h.</i>	<i>m.</i>	<i>s.</i>
Beginning, . . . . .	3	12	18.6
Formation of ring, . . . . .	4	30	31.6
Rupture of ring, (not reported.)			
End, . . . . .	5	44	26.6
Duration of eclipse, . . . . .	2	32	8.6
Do. of ring, (not reported.)			

No. 24, by Prof. James Hamilton, of Burlington, New Jersey. Latitude  $40^{\circ} 5' 10''$  N.: 69.1s. in time east of State House, Philadelphia. With a five feet achromatic, power 80. Clock regulated by equal altitudes with a sextant.

	<i>h.</i>	<i>m.</i>	<i>s.</i>
Beginning, . . . . .	3	14	23.7
Formation of ring, . . . . .	4	32	32.6
Rupture of ring, . . . . .	4	36	19.6
End, . . . . .	5	46	8.5

	<i>h.</i>	<i>m.</i>	<i>s.</i>
Duration of eclipse, . . . . .	2	31	44.8
Do. of ring, . . . . .	3	47.0	

“The phases of the ring are the perfect formation and perfect rupture, without reference to beads. No dark lines seen.”

October 19, 1838.—The Committee on the solar eclipse of the 18th of September, made a further Report in part, comprising the following observation:—

No. 25, by F. R. Hassler, Esq., at Weasel Mountain, N. J., latitude  $40^{\circ} 52' 35''$  N., approximate longitude  $4h. 57m. 25.7s.$  W., being one of the stations of the coast survey, with telescopes of the large theodolite, powers 116 and 151.

	<i>h.</i>	<i>m.</i>	<i>s.</i>
First contact, . . . . .	3	15	56.98
Inner contact, . . . . .	4	35	57.09
End, . . . . .	5	47	13.10
Duration of eclipse, . . . . .	2	31	16.12
Do. of ring, . . . . .			1.00

From a drawing, accompanying Mr. Hassler's communication, it appears that several broken portions of the ring, or beads of light, for a second only, extended from cusp to cusp, presenting a most beautiful appearance. During the rest of the eclipse, except this single second, the cusps were dull and rounded off at the end.

November 2, 1838.—The Committee on the solar eclipse of the 18th of September, made a further Report in part, comprising the following observations:—

Nos. 26 and 27. Observations of Professors Alexander and Henry, at the house of the latter, (lat.  $40^{\circ} 20' 50''$  N., lon.  $4h. 58m. 37.2s.$  W. of Greenwich, being 0.1s. in time W. of Nassau Hall,) Princeton College, New Jersey; with a five feet Fraunhofer, yellow screen glass, power 60 for beginning and end, and 40 for the ring, and with a three and a half feet Dollond, dark red screen glass, power 80.

	<i>h.</i>	<i>m.</i>	<i>s.</i>	
Beginning, - - - - -	3	14	42.71	Henry.
do. - - - - -	3	14	43.31	Alexander.
Formation of ring, - - - - -	4	33	11.27	Both observers.
Rupture of ring, - - - - -			(not observed.)	
End, - - - - -	5	46	38.54	Henry.
do. - - - - -	5	46	39.24	Alexander.
Mean duration of eclipse, 2 31	2	31	54.88	
do. of ring, (not observed) less than tabular duration.				

About two minutes before the formation of the ring, Prof. Henry saw, in the Dollond telescope with a red screen glass, an arch of faint light between the cusps, and shortly afterwards a brush of greater

intensity, projecting from near the lower cusp. This phenomenon was not seen by Prof. Alexander in the Fraunhofer with green screen glass, till 61 seconds before the formation of the ring, and then only as a luminous spot. This difference could not have been the result of any oversight on the part of Prof. Alexander; as Prof. Henry, immediately on seeing it, called out to Prof. Alexander, and described its appearance. The optical capacity of the Fraunhofer is superior to that of the Dollond. Prof. Alexander is well known for his nice observations of the annular eclipse of the 13th February, 1831, and of the total eclipse of the 30th November, 1834. Its explanation must be sought for in the nature of the rays of which this arch and brush of light are composed; rays absorbed by the green screen glass, and transmitted by the red. The moon's limb became brightly illuminated at 4*h.* 32*m.* 53.28*s.* "An appearance, similar to a row of beads, was regarded as the formation of the ring." "The drops endured for a second or two." Expecting a longer duration of the ring, the attention of the observers was not directed to the sun's limb at the instant of the rupture. The light succeeding the rupture of the ring was visible in the Dollond telescope till 4*h.* 41*m.* 16.27*s.*, (the minute uncertain, perhaps a minute earlier,) having disappeared several minutes earlier in the Fraunhofer refractor.

No. 28. The beginning of the eclipse was observed by William Cranch Bond, at his private Observatory, with a two feet Gregorian, power 44; latitude 45° 19' 15" N., longitude 4*h.* 44*m.* 17.29*s.* west of Greenwich, (or 0.69*s.* in time west of Boston State House by Mr. Paine's trigonometrical survey,) as follows:—

Beginning, 3*h.* 28*m.* 10.90*s.* mean time of place of observation.

End, lost by clouds.

No. 29. The beginning was observed at 3*h.* 28*m.* 11.6*s.* at the State House, Boston, by Mr. Borden, with a 3½ feet refractor. Clouds prevented its observation at Cambridge.

The Committee also reported the following observations of R. T. Paine, Esq., on the occasion of his journey to Washington to observe the eclipse. These were made with his sextant, constructed by Troughton for the chronometrical survey of Massachusetts, and carefully corrected by that artist for all sensible error of eccentricity; and with three excellent chronometers used by Mr. Paine in the survey.

## Latitude of the Capitol.

Sep. 17th, by 21	observed altitudes of both limbs			of the sun,	38° 53' 23.39"
" " 16	do.			$\beta$ Ceti,	22.75
" " 22	do.			Polaris,	21.77
" 22d 12	do.			both limbs of the sun,	22.31
" " 12	do.			Polaris,	22.70
" " 7	do.			$\beta$ Ceti,	24.89
					<hr/>
By mean of 56 altitudes of sun and southern stars,					23.16
do. of 34 do. Polaris,					22.24
					<hr/>

Latitude of the Capitol, N. 38° 53' 22.7"

The corrections of the chronometers were determined by Mr. Paine for Boston State House, from transit observations of Mr. Bond, at Dorchester; those for Philadelphia State House, by eastern and western altitudes of stars, observed at the High School Observatory, by Messrs. Paine, Riggs, Walker, and Kendall, with the Troughton's sextant, circle, a Pistor's sextant, and a sextant (maker's name unknown) reading to 10". Those for Washington were made by Mr. Paine. The daily rates of the chronometers for Washington were on mean time,

151	Barraud	- 14.27
682	do.	+ 1.67
1678	Arnold	+ 8.46.

With these rates, the condition of the chronometers at the beginning of the eclipse was as follows:—

151 Barraud.	682 Barraud.	1678 Arnold.			
<i>m.</i> <i>s.</i>	<i>m.</i> <i>s.</i>	<i>m.</i> <i>s.</i>	<i>m.</i>	<i>s.</i>	
+19 31.59	+25 11.27	+31 46.21	by 8 W.	alt's of sun,	Sep. 17.
31.18	11.52	46.43	9 E.	" $\alpha$ Tauri,	"
30.96	11.61	46.34	4 E.	" $\alpha$ Orionis,	"
31.70	11.20	46.12	12 E.	" sun,	"
32.65	12.13	47.14	8 E.	" $\alpha$ Androm.	18.
31.70	11.38	46.34	12 E.	" sun,	"
<hr/>	<hr/>	<hr/>			
+19 31.68	+25 11.48	+31 46.41	Mean of 53 altitudes.		
<hr/>	<hr/>	<hr/>			

The longitude of the State House, Boston, is stated by Mr. Paine to be 4*h.* 44*m.* 16.6*s.* W., as the result of all the observations yet made. It is the same as that which Dr. Bowditch had deduced from those of 1811 and previous. The longitude of the State House, Philadelphia,

obtained by Mr. Walker from the principal observations made at Philadelphia to this time, is *5h. 0m. 39.2s. W.* With these longitudes as standards, Mr. Paine's chronometric observations give,

	<i>m.</i>	<i>s.</i>						
Boston—Philadelphia by 151 Barraud	16	24.27	going from Boston to Phila.					
682 do.		22.30	do.					
1678 Arnold		24.03	do.					
151 Barraud		23.33	returning from Phila. to Boston.					
682 do.		23.60	do.					
1678 Arnold		23.76	do.					
Philadelphia—Capitol by 151	}	Mean 7 26.43 going from Phila. to Capitol.						
682								
1678								
151	}	Mean 7 26.50 returning from Capitol to Phila.						
682								
1678								
Hence, longitude of Capitol	<i>h.</i>	<i>m.</i>	<i>s.</i>	<i>m.</i>	<i>s.</i>	<i>h.</i>	<i>m.</i>	<i>s.</i>
	= 4	44	16.6	+ 23	50.01	= 5	8	6.61
	= 5	0	39.2	+ 7	26.46	= 5	8	5.66
					Mean = 5	8	6.14	

Mr. Walker, in a paper read before the Society, March 2, 1838, from a discussion of all the observations then made at Washington, finds the longitude of the Capitol *5h. 8m. 7s. W.*, a value which is probably not far from the truth.

Thus we have an additional proof, if any were needed, of the error of 25 seconds in time of Lambert's longitude of the Capitol, reported to Congress, and adopted by that body.

The coincidence between the interval from Boston to Philadelphia, viz.

By celestial phenomena,	<i>m.</i>	<i>s.</i>
	16	22.60
By chronometers,	16	23.55

shows that the error of either is reduced within narrow limits.

The Mansion House, Northampton, Mass., lat.  $42^{\circ} 19' 4.6''$  N. by 327 altitudes of northern and southern stars, has the following longitude:—

Boston—Northampton,	<i>m.</i>	<i>s.</i>	
	6	17.72	by 74 chronometers.
do.	6	17.89	by immersion $\tau$ Sagittarii.
Northampton—Phila.	10	4.06	by do.

This immersion of  $\tau$  Sagittarii was observed, Aug. 22d, 1836, as follows:—

By R. T. Paine,	<i>h.</i>	<i>m.</i>	<i>s.</i>	
	at 10	14	57.46	at Mansion House, Northampton.
By W. C. Bond,	at 10	23	20.90	at his Observatory.
By S. C. Walker,	at 10	1	7.30	at N. $4.4''$ , W. 1.06s. of State House, Phil.

Again, for the longitude of Brown University, Providence, Mr. Paine finds,

	<i>m.</i>	<i>s.</i>	
Boston—Providence,	1	22.64	by 40 chronometers.
do.	1	22.29	by eclipse of May 15th, 1836.

Mr. Paine's observations of the eclipse of Sept. 18th have already been reported. Those for latitude and regulation of chronometers have been stated more at length, in order to furnish examples of the method pursued by that gentleman in the chronometric survey of Massachusetts, the only work of the kind of much extent hitherto performed in this country. Some idea of the labors of Mr. Paine may be formed from the fact, that, during its progress, he has been under the necessity of making and reducing more than 100,000 observations of altitudes of the sun and stars, without any assistance.

It is proper to add that Mr. Gilliss's observations, already reported, appear to require a subtractive correction of 1.95s. Thus Mr. Paine's observations give,

	<i>h.</i>	<i>m.</i>		<i>m.</i>	<i>s.</i>
Sept. 18th, 21	25	Barraud 151,	fast by its own rate,	+19	20.80
		by comparison with	682 Barraud,		20.91
			1678 Arnold,		20.89
		by mean of three chronometers,		19	20.87
		by Mr. Gilliss's transit observations,		19	22.82
		Discrepancy,			1.95

Professor Henry read a paper entitled "Contributions to Electricity and Magnetism, No. 3. On the Phenomena of Electro-dynamic Induction." Referred to Prof. A. D. Bache, Dr. Patterson, and Dr. Hare.

The primary object of the investigation undertaken by the author, was the discovery of induced currents from ordinary electricity, similar to those produced by galvanism. Preparatory to this, a new investigation was instituted of the phenomena of galvanic induction, and the result of this forms, perhaps, the most important part of the communication.

The first section of the paper refers to the conditions which influence the induction of a current on itself, as in the case of a long wire and a spiral conductor. These are shown to depend on the intensity and quantity of the battery current, and on the length, thickness, and form of the conductor.

The next section examines the conditions necessary to the production of powerful secondary currents, and also the changes which take place in the same, when the form of the battery, and the size and form of the conductor are varied. The important fact is shown, that not only a current of intensity can be induced by one of quantity, but



also the converse, that a current of quantity can be produced by one of intensity.

The third section relates to the effect of interposing different substances between the conductor which transmits the current from the battery, and that which is arranged to receive the induced current. All good conducting substances are found to screen the inducing action, and this screening effect is shown, by the detail of a variety of experiments, to be the result of the neutralizing action of a current, induced in the interposed body. This neutralizing current is separately examined, and its direction found to be the same as that of the battery current. The question is then raised, how two currents in the same direction can counteract each other? An answer to this question is given in a subsequent part of the paper.

The fourth section relates to the discovery of induced currents of the third, fourth, and fifth orders;—that is, to the fact that the second current is found capable of inducing a third current, and this latter again another, and so on. The properties of these new currents are next examined, and the screening influence is found to take place between them; quantity is induced from intensity, and conversely; magnetism is developed in soft iron; decomposition is effected, and intense shocks are obtained, even from the current of the fourth order. A remarkable and important fact is stated in reference to the direction of these currents. If the direction of the battery current and that of the second be called *plus*, then the direction of the third current will be *minus*, of the fourth current *plus*, of the fifth *minus*, and so on. The application of the fact of these alternations is made to the explanation of the phenomenon of screening before mentioned, and also to the improvement of the magneto-electrical machine.

The last part of the paper relates to the discovery of secondary currents, and of currents of the several orders, in the discharge of ordinary electricity. Shocks are obtained from these; the screening influence of good conductors is shown to take place; magnetism is developed; and the alternations in the direction are found to exist as in the currents from galvanic induction. Some remarkable results are given in reference to the great distance at which the induction takes place. Experiments are detailed in which needles were made magnetic, when the conductors were removed to the distance of twelve feet from each other.

Prof. Henry made a verbal communication, during the course of which he illustrated, experimentally, the phenomena developed in his paper.

November 16, 1838.—The Committee on the solar eclipse of the 18th of September, made a further Report in part, comprising the following observations:—

No. 30. Observation of A. Holcomb, at his Observatory, Southwick, Mass., with a seven feet Herschelian of his own construction, power 225, with red screen glass. Southwick is in latitude  $42^{\circ} 0' 41''$  north; longitude  $4h. 51m. 12s.$ , by Mr. Holcomb's triangulation with Springfield Court House, one of the points determined by Mr. Paine. Mr. S. C. Walker finds, from Mr. Holcomb's observation of the solar eclipse of 1836, for this longitude  $4h. 51m. 13.2s.$  Mean value  $4h. 51m. 12.6s.$  W.

	<i>h.</i>	<i>m.</i>	<i>s.</i>		
Beginning,	3	20	19	Mean time.	Observation satisfactory.
End,	5	50	27	do.	Doubtful one second. Sun's limb
Duration,	2	30	8		tremulous, and near horizon.

No. 31. Observation of Prof. Albert Hopkins, at the Observatory of Williamstown College, Mass. Latitude,  $42^{\circ} 42' 44''$  N., longitude  $4h. 52m. 52s.$  W. Astronomical clock regulated by a four feet transit instrument.

	<i>h.</i>	<i>m.</i>	<i>s.</i>		
Beginning,	3	17	19.9	Mean time.	Good observation.
End,				(not observed)	Sun too near the horizon.

The Committee on Dr. Hare's paper on the Tornado which passed over a suburb of Providence, R. I., in August last, reported in favor of publication, and the report was adopted.

The phenomena and facts, stated in this paper, are quite consistent with those mentioned upon the authority of Prof. Bache, Mr. Espy, and other observers, relative to the tornado which took place in New Jersey, at or near New Brunswick, in June, 1835, and of which an account will be found in the last volume of the Transactions of the Society. This paper embraced a letter from Zachariah Allen, Esq., a highly respectable gentleman of Providence, who was an eye-witness of the tornado, having been quite as near to it as was consistent with safety. One of the facts noticed by Mr. Allen, Dr. Hare considers as tending to justify his opinion, that the exciting cause of these meteors is electrical attraction. Mr. Allen alledged that, as soon as the tornado came into contact with the surface of the river, the water rose in a foam; that, under these circumstances, two flashes of lightning passed between the water and the overhanging clouds; and that, after each flash, there was a perceptible subsidence of the foam. This result is precisely what Dr. Hare conceives would ensue, if the foam arose from an attraction between the water and the stratum of air above, caused by opposite states of electrical excitement. In such case, the passage of sparks always necessarily tends to restore the equilibrium between the electrified masses, and consequently to lessen their reciprocal attraction.

Dr. Hare made a verbal communication in relation to his compound blowpipe. He stated that, having in a letter to the chemical section of the British Association, mentioned the fusion of twenty-five ounces of platinum, of which he had already informed the Society, a Mr. Maugham, who is employed at the Adelaide Gallery in London to exhibit the hydro-oxygen microscope, had asserted that the fusion in question had been accomplished by a blowpipe of a kind which he had contrived, and of which one had been bought by Dr. Hare when in London.

Dr. Hare said he would not have considered this ridiculous and groundless allegation worthy of notice, had it not been made before the chemical section of the British Association, and had not the individual, by whom it was made, been honored by a British society with a premium for the instrument which he miscalled *his* blowpipe. This blowpipe differed immaterially from one of which he, Dr. Hare, had published an engraving and description in Silliman's American Journal of Science for 1820, (Vol. II, page 298, fig. 3;) being a modification of his blowpipe described in Vol. XIV, of Tilloch's Philosophical Magazine for 1802.

The only difference between the instruments described and represented in those publications, and that employed by Maugham, was that the latter formed near the apex an acute angle, so as to be convenient for directing the flame upon a cylinder of lime for producing the lime-light.

With a view to show this method of illumination, agreeably to the process in which a revolving cylinder of lime is employed, Dr. Hare stated that he had purchased one of the crooked blowpipes alluded to; *but he had never used it for any purpose*, having found his own blowpipe above mentioned preferable, when the jet was directed obliquely upwards.

Unless cured of the crookedness, which was its only essential distinguishing attribute, the blowpipe used by Maugham was evidently unfit for the fusion of any metal. Dr. Hare stated that he would not undertake the fusion with it of an ounce of platinum; and concluded by saying, that whenever the process by which he had lately extended the power of his blowpipe should be published, it would be seen that however it might differ from those which he had previously contrived, it differed still more from that which Maugham had appropriated to himself.

Prof. Bache informed the Society, that, in conjunction with Prof. Rogers and Mr. Saxton on the nights of the 12th and 13th of November, and with Prof. Rogers and Mr. Walker on the 13th and 14th, he had observed the number of meteors or shooting stars. The first night

was clear for only about an hour, viz. between three-quarters past one and two, when but one meteor was seen. The second was clear until half past two; but not even an ordinary average number of meteors was seen.

On the authority of a letter from Mr. Levett Harris, Dr. Bache reported the decease of Mr. F. H. Le Comte, of Paris, a member of the Society.

December 21, 1838.—The Committee on the solar eclipse of the 18th of September, made a further Report in part, comprising the following observations, received through the attentions of their correspondent, Prof. S. Alexander, of Princeton College, New Jersey:—

No. 32, by Prof. Augustus A. Smith, of the Wesleyan University, Middletown, Conn. Latitude  $41^{\circ} 33' 8''$  N. : longitude as deduced by himself from this observation, by the method of Woolhouse, in the Nautical Almanac for 1837, 4h. 50m. 2s. W.

			<i>h.</i>	<i>m.</i>	<i>s.</i>	
Beginning,	-	-	3	22	0.31	Mean time.
End,	-	-	5	52	1.46	Mean time.

His telescope was a Herschelian, by Holcomb, seven feet in length, six inches in aperture, with a deep red screen glass, power 150. "There was nothing unusual in the appearance, except, perhaps, about the time of greatest obscuration. At first were seen two or three brushes or pencils of light, streaming out from that border of the moon, which was not projected on the sun's disc, about equidistant from each other, and from the higher cusp of the sun. These soon disappeared, and were succeeded by a faint diffuse light, bordering two-thirds of the lower part of the sun's limb. The duration of this appearance was not noted."

Prof. Smith also noticed an indentation in the sun's limb, which he attributes to the protrusion of a lunar mountain, before any other portion of the moon was visible on the sun's disc. The Committee are of opinion that this appearance should be referred to that class of phenomena which usually precede and follow a central eclipse and which are to be ascribed to some optical cause rather than to the protrusion of lunar mountains.

No. 33, by Mr. I. N. Z. Blaney, at New Castle, Del., latitude  $39^{\circ} 40'$  N., longitude 5h. 2m. 8s. W.; observation of the duration of the ring with a spy-glass, with smoked glass screen.

		<i>m.</i>	<i>s.</i>
From the appearance of the drops to the rupture of the ring,	4	47	
From the perfect formation of the ring to the perfect rupture,	4	45	

Prof. Alexander remarks that the luminous arch round the moon's dark limb, and the brush of light were only partially visible in his 4

feet Fraunhofer, with a yellow screen glass, having a slight tint of green. He saw them distinctly in the  $3\frac{1}{2}$  feet Dollond, with a red screen glass, used by Prof. Henry, for some four minutes after the rupture of the ring, though none was visible in the Fraunhofer telescope; at least none is recollected to have been seen, though he examined the sun in the direction in which the ring broke. The testimony of so experienced an observer, who, in examining this arch and brush of light, used, interchangeably, the yellow and red screen glasses, in favor of their far greater visibility through the red screen glass, appears to be conclusive on the subject. This remarkable circumstance, not hitherto noticed in European observations, and first suggested by Robert Treat Paine, Esq., from his observations at Washington, appears to be now confirmed. It is one of great importance; as it seems to furnish evidence of the existence of a lunar atmosphere, through which, as through our own, the red rays have the greatest penetrative power. It also leads to new views concerning the cause of the remarkable appearances of the beads of light, and the dark lines frequently noticed; since it shows that their appearance may be completely modified by a change in the color, and, consequently, in the absorbing power of the screen glass through which they are observed.

The fact, noticed by most of the observers, that before the formation and after the breaking of the ring, the edge of the moon off the sun was distinctly visible, and illuminated for some distance within the moon's surface, is just such as would be presented by a *twilight* caused by a lunar atmosphere; nor does there seem to be any other plausible explanation of this phenomenon.

Mr. Lea submitted the following description of a new shell, recently taken in the vicinity of Cincinnati by Mr. T. G. Lea.

MELANIA CINCINNATIENSIS.

“Testâ valde depressâ, infernè compressâ, fuscâ, trifasciatâ, bicarinatâ, apice acuminatâ; anfractibus quaternis; aperturâ subrotundâ.”

This is a very minute species, and very remarkable for its roof-shaped spire, and two carinæ which are colored.

On motion of Dr. Patterson, the Committee appointed on the late eclipse, were instructed to make and collect observations in relation to the occultation of stars in the constellation of the Pleiades, which will occur on the 27th instant.

January 4, 1839.—Dr. Dunglison made a verbal communication on the subject of the vaccine virus and its alledged liability to lose its protective character under certain circumstances.

He stated that, in consequence of severe epidemic small-pox having recently occurred in England, from which many who had been pre-

viously vaccinated had suffered severely, it had been a matter of solicitude with many medical practitioners to revert to the original source for vaccine virus. Mr. Estlin, of Bristol, having succeeded in obtaining some lymph from a cow laboring under cow-pox, inserted it in the arm of a young lady, in August last, and from her the disease was subsequently propagated. Some of the virus, obtained at ten removes, was sent to Dr. Dunglison by Messrs. Estlin and Carpenter of Bristol. This has been used in several cases, and the disease produced by it appeared to him to be more satisfactory than that which results from the old virus.

Dr. Dunglison stated that there was reason to believe that a sufficient supply of the new virus would soon be obtained for distribution through the country.

Professor A. D. Bache stated to the Society that observations had been made on the night of the 12th—13th of November last, by Professor Henry, at Princeton, Professor W. B. Rogers, at the University of Virginia, and Professor R. P. Smith, at Kenyon College, Ohio, neither of whom had noted an unusual number of the meteors commonly called "shooting stars."

*January 18, 1839.*—Professor A. D. Bache made a verbal communication relative to an extraordinary instance of the rapid corrosion of a chain cable in sea-water, reported to him by Lieutenant George M. Bache, of the U. S. Navy, and showed the Society a link from a portion of the cable.

The chain cable, of which this was a part, was used to anchor the Light-boat off Bartlett's reef, near New-London, Connecticut. The portion between the hawse-hole and the bridle of the anchors, about eleven fathoms in length, is particularly exposed to corrosion. In a few months the links, or the keys of the shackles attaching the chain to the bridle, become so much oxidated as to lose the requisite tenacity.

The link, presented as a sample of the chain, is irregularly oxidated and worn, presenting semi-spheroidal cavities, and the fibrous structure of the iron is very distinctly developed. While this is the case with the wrought iron part of the link, the cast iron stud which strengthens it is not materially acted on. The raised letters upon the stud are perfect.

The circumstances in which this chain is differently situated from others, used in similar situations, result from the peculiar construction of the Light-boat, by which the copper sheathing rises above, and is in contact with, the cast-iron hawse-pipe, through which the cable passes. This cast-iron pipe has on its exterior a lead pipe. The copper sheathing is bright.

This action being attributed by Lieutenant Bache, to the contact of the copper and iron in presence of sea-water, he had ordered the copper to be removed from around the hawse-hole, the result of which experiment would test the truth of the supposition.

Professor Bache stated his wish to call special attention to the entire soundness of the cast-iron, while the wrought-iron was corroded; as if the latter had acted as a protector to the former. He believed that some general laws of interest would be made out by the Committee of the British Association engaged in investigating the subject to which this fact appeared to belong.

The Committee on making and collecting observations of Celestial Phenomena, reported in part, that they had received the following observations of Lunar Occultations of the fixed stars, in mean time of the places of observation.

1833.		<i>h. m. s.</i>			
1.	Nov. 2, <i>d</i>	Pleiadum, Em.	13 53 11.10 d. l.	Phila. Obs'ry.	W. and K.
2.	" "	Im.	13 18 12.10 b. l.	"	"
3.		Em.	14 34 50.60 d. l.	"	"
4.	<i>f</i>	Im.	14 9 53.60 b. l.	"	"
5.		Em.	15 19 25.10 d. l.	"	"
6.	<i>h</i>	Em.	15 26 34.40 d. l.	"	"
7.	" 21, 58 $\omega$	Sagittarii, Im.	6 1 24.30 d. l.	"	"
8.	" "	" Em.	7 13 20.00 b. l.	"	"
9.	* 8th mag. "	Im.	6 9 12.30 d. l.	"	"
10.	60 $\alpha$	Sagittarii, Im.	7 43 5.10 d. l.	"	J. and K.
11.	Dec. 27, <i>n</i>	Pleiadum, Im.	8 0 34.70 d. l.	"	R. and W.
12.		Em.	9 17 33.80 b. l.	"	"
13.	<i>f</i>	Im.	8 53 56.70 d. l.	"	P. and W.
14.			57.60 d. l.	"	K. and R.
15.	<i>h</i>	Im.	8 54 10.80 d. l.	"	P. and W.
16.			12.20 d. l.	"	K. and R.
17.	Nov. 2, <i>d</i>	Pleiadum, Im.	12 34 26.10 b. l.	Wagner's House,	T. Wagner.
18.		Em.	13 53 28.80 d. l.	"	"
19.	<i>n</i>	Im.	13 18 48.80 b. l.	"	"
20.		Em.	14 34 38.60 d. l.	"	"
21.	<i>f</i>	Em.	15 19 24.40 d. l.	"	"
22.	<i>h</i>	Em.	15 26 32.40 d. l.	"	"
23.	Dec. 27, <i>d</i>	Pleiadum, Em.	8 34 35.00 b. l.	"	"
24.	<i>f</i>	Im.	8 54 0.00 d. l.	"	"
25.		Em.	10 1 17.90 b. l.	"	"
26.	<i>h</i>	Em.	10 11 59.90 b. l.	"	"
27.	Nov. 21, 58 $\omega$	Sagittarii, Im.	6 3 57.35 d. l.	Princeton College,	Alexander.
28.	60 $\alpha$	Sagittarii, Im.	7 44 37.49 d. l.	"	"
29.	Dec. 24, $\epsilon$	Piscium, Im.	9 35 30.80 d. l.	"	"
30.	" 26, 47	Arietis, Im.	14 20 54.50 d. l.	"	"
31.	" 27, <i>n</i>	Pleiadum, Im.	8 4 0.35 d. l.	"	"
32.		Em.	9 21 30.40 b. l.	"	A. and B.
33.	<i>d</i>	Im.	7 21 33.50 d. l.	"	"
34.		Em.	8 38 38.00 b. l.	"	"
35.	<i>p?</i>	Im.	7 59 20.10 d. l.	"	A.

1838.		<i>h. m. s.</i>			
36.	Dec. 27, <i>f</i>	Im.	8 57 7.85 d. l.	Princeton College,	A.
37.		Im.	8.15 d. l.	"	B.
38.		Em.	10 6 11.30 b. l.	"	A.
39.	<i>h</i>	Im.	8 57 32.76 d. l.	"	A. and B.
40.		Em.	10 21 31.55 b. l.	"	A.
41.	Nov. 13, <i>a</i>	Virginis,	Im. 20 32 38.40 b. l.	Dorchester Obs'y.	Bond.
42.	Dec. 2, <i>c</i>	Aurigæ,	Em. 17 32 19.00 d. l.	Paine's House, Boston.	Paine.
43.	" 24, <i>i</i>	Piscium,	Im. 9 53 16.84 d. l.	"	"
44.	" 27, <i>f</i>	Pleiadum,	Im. 9 18 43.28 d. l.	"	"
45.	Nov. 21, 58 <i>ω</i>	Sagittarii,	Im. 6 12 33.20 d. l.	Holcomb's Obs'y.	Holcomb.
46.	Dec. 24, <i>i</i>	Piscium,	Im. 9 44 29.50 d. l.	"	"
47.	" 27, <i>n</i>	Pleiadum,	Im. 8 16 43.10 d. l.	"	"

No. 1, at the Philadelphia Observatory of the Central High School. Lat.  $39^{\circ} 57' 8''$  N.; longitude  $5h. 0m. 42s.$  west of Greenwich.

No. 2, good observation. No. 3, doubtful, eye not directed to the exact place of emersion. Nos. 4, 5, 6, 7, 9, 11, 13, 14 and 15, good observations. No. 10, doubtful. No. 12, star reappeared in contact with bright limb.

No. 16, doubtful 1s.

No. 17, at T. Wagner's house, 2.16s. in time, east of the Philadelphia Observatory, with 5 feet equatorial. No. 18, probably too late several seconds.

No. 19, doubtful. No. 20, good observation, preferable to No. 3. Nos. 21, 22 and 24, good observations. Nos. 23, 25 and 26, uncertain, from brightness of moon's limb.

No. 27, at Prof. Stephen Alexander's house,  $6''$  north, 0.3s. in time, east of Nassau Hall, Princeton College, New Jersey.

Nos. 27, 28, 29, 30, 31, 32, 33, 36, 37 and 39, satisfactory observations.

Nos. 34, 38 and 40, uncertain from brightness of moon's limb.

No. 35, doubtful 1s. Nos. 33 and 36 appeared to be followed by a slight brush of light.

No. 41, at William Cranch Bond's Observatory, Dorchester, Mass. Lat.  $42^{\circ} 19' 15''$  N.; longitude  $4h. 44m. 17.3s.$  W. of Greenwich.

No. 42, at R. T. Paine's house, Boston. Lat.  $42^{\circ} 20' 56''$  N.; long.  $4h. 44m. 16.3s.$  W. Observation uncertain. Nos. 43 and 44, very good observations.

No. 45, at A. Holcomb's Observatory, Southwick, Mass. Lat.  $42^{\circ} 0' 41''$  N.; long.  $4h. 51m. 15.5s.$  W.

The initials denote respectively,

W. Sears C. Walker.

K. E. O. Kendall.

J. George M. Justice.

R. William H. C. Riggs.

P. Robert M. Patterson.

A. Stephen Alexander.

B. J. V. Z. Blaney.

b. l. and d. l. denote respectively the bright and dark limbs of the moon.

The following candidates were elected members of the Society:—

JAMES PRINSEP, of Calcutta.

JOHN EDWARDS HOLBROOK, M. D., of Charleston, S. C.

JOHN C. CRESSON, of Philadelphia.

JAMES C. BOOTH, of Philadelphia.

EDWARD COLES, of Philadelphia.

J. F. ENCKE, of Berlin. A. QUETELET, of Brussels.



February 15, 1839.—The officers and council to whom was referred the letter of Doctor Warren, of Boston, inclosing a circular from a meeting of gentlemen at Boston, on the subject of the formation of an American Association for the Promotion of Science, submitted the following resolution, which was adopted by the Society.

*Resolved*, That the American Philosophical Society, having given the most respectful attention to the letters laid before them by Doctor W. E. Horner, and to the circular letter from the Committee of gentlemen of Boston, by referring the first letter to a Special Committee, and the second, with the circular, to the Board of Officers, are of the opinion, founded on the Reports of the Committee and of the Officers, that it is inexpedient for this Society to undertake the organization of an Association, such as is alluded to in these communications.

Doctor Patterson read an extract from a letter from Mr. T. R. Peale, dated November 13th, 1838.

In this letter Mr. Peale states, that observations had been made on the night of the 12th—13th of November, on board of the exploring vessel, the Peacock, (place not given,) relating to the number of meteors. The greatest number supposed to have been observed in any one hour was seventy-one. Mr. Peale expresses his doubts whether, from the motion of the vessel on the night in question, it was possible to be accurate on this point, and believes the number to have been much overrated.

A display of the Aurora Australis had been witnessed a few weeks before the date of the letter.

Professor A. D. Bache called the attention of the Society to a very convenient method for determining the magnetic dip and intensity, by one instrument, proposed by Professor Lloyd, of Dublin, and used by him, Major Sabine, and Captain James Ross, in the recent magnetic surveys in Great Britain.

The approximate dip is observed without disturbing the magnetism of the needle. The angle with the horizon, when the centre of gravity of the needle is removed from the axis by a small weight, is also observed, the needle being in the plane of the magnetic meridian.

To the first observation, a correction is applied, from observation at a station where the dip is accurately known, to obtain the true dip. The second being repeated at different places, the elements necessary to determine the relative intensities are known; and the approximate formula, connecting these observed elements with the relative intensities of the magnetism of the places where the change of intensity is not great, is very simple.

Prof. Bache showed an instrument, made by Robinson, of London, of the usual construction, for determining the magnetic dip, with needles for the employment of Professor Lloyd's method. He also re-

ferred to a method proposed by Professor Christie, of Woolwich, similar in principle, but differing in detail, and showed the needles for applying this method.

Prof. Bache further stated, that he had caused the method of heating these needles to the temperature of boiling water, to bring them to a permanent magnetic condition, as proposed by Prof. Christie, to be tried by Mr. Robinson. It had not proved successful.

Mr. S. C. Walker made a verbal communication on the parallax of the star, 61 Cygni, recently investigated by Mr. Bessel, and described the nature of the researches by which this important point had been established.

*March 15, 1839.*—Professor Henry, of Princeton, made a verbal communication relating to a phenomenon of capillary action which had fallen under his notice.

A lead tube, of about half an inch in diameter, and eight inches long, happened to be left with one end immersed in a cup of mercury; and on inspection a few days afterwards, it was observed that the mercury had disappeared from the cup, and was found on the floor at the other end of the tube. Struck with the phenomenon, the cup was again filled with mercury: the next morning the same effect was exhibited.

The mercury had again passed over through the tube, apparently like water through a capillary siphon, and was again found on the floor.

On cutting the tube into pieces, it was evident that the mercury had not passed along the hollow axis, but had, apparently, been transmitted through the pores of the solid metal. To determine this, a lead rod about seven inches long and a quarter of an inch in diameter, was bent into the form of a siphon. The shorter leg was immersed in a watch-glass filled with mercury, and a similar glass placed under the end of the longer leg, to receive the metal which might pass over. At the end of twenty-four hours, a globule of mercury was perceived at the lower end; and in the course of five or six days all the mercury passed over, leaving a crop of beautiful arborescent crystals, of an amalgam of lead, in the upper glass.

The mercury did not pass along the surface of the wire, since the lead exhibited, externally, but little change of appearance; although the progress of the penetration could be traced by a slight variation of the color of the oxide on the surface.

The action is much influenced by the texture of the lead. When a rod of cast lead, of the same size and form, was substituted for the one before described, the globule of mercury did not make its appearance at the lower end until about forty days; and all the mercury of the upper glass had not yet (after three months) entirely disappeared.

The penetration takes place much more readily in the direction of the laminæ of the metal than across them. A plate of thick sheet lead was formed into a cup, and mercury poured into this; and it was found that before a drop had passed directly through, the mercury oozed out all around the edge of the plate.

Professor Henry stated that he had in progress a variety of experiments to investigate this action; and if any results of importance were obtained he would communicate them to the Society.

Dr. Hare made a verbal communication to the Society, by which it appears that he has obtained brilliant metallic spangles of calcium.

His processes have been, the deflagration of the phosphuret of calcium in an atmosphere of hydrogen; the exposure of the anhydrous iodide of calcium to a current of hydrogen,\* or ammonia in an incandescent tube; the ignition of the pure earth or its carbonate or nitrate with sugar; or of the tartrate and acetate per se. Hence resulted carburets, which, after washing with acetic acid and rubbing on a porcelain tile, display the lustre of plumbago, intermingled with metallic spangles, of a brilliancy rivalling that of the perfect metals. The carburets, or the spangles thus obtained, are insoluble in acetic or chlorohydric acid, but yield to aqua regia. The carburets are excellent conductors of the voltaic fluid, as evolved by a series of 100 pairs; and, by deflagration in a receiver filled with hydrogen, yield metallic particles, which, rubbed on a porcelain tile, form spangles of a metallic brilliancy. By igniting antimony with tartrate of lime, Dr. Hare had procured an alloy of that metal with calcium, and expected by analogous means to alloy the metals of the earths with various metals proper. He believed that no effort to obtain calcium prior to his, had been more successful than the abortive experiment of Sir H. Davy, in which the tube broke before the distillation of the mercury was completed, with which the calcium had been amalgamated in the voltaic circuit, agreeably to the process previously employed by Berzelius. Dr. Hare had produced amalgams by exposing the chloride, or sulphide of calcium to the circuit; and, by distillation in an iron alembic, under the protection of a current of desiccated hydrogen, had isolated a portion of calcium, not however endowed with the whiteness or the lustre of that metal, as when otherwise fairly evolved. When distilled in glass tubes or retorts, he had found the amalgam to leave only a film upon the glass, devoid of any metallic attribute; although in one instance, to secure the absence of oxygen, he had mixed an amalgam of ammonium with that of calcium. Hence he inferred, that even though the tube of Davy had remained unbroken, that distinguished chemist

---

\* By a deflagrator of one hundred pairs of plates, fourteen inches long by eight broad.

would not have found a residue of calcium, uncombined with the elements of the glass. That the spangles obtained by Dr. Hare from lime, were calcium, was ascertained by their solution in aqua regia, and the successive subsequent addition of ammonia and oxalic acid; the resulting precipitate being ignited, then redissolved and again precipitated as at first. No precipitate ensued from the addition of ammonia prior to that of the oxalic acid. Sulphydic acid produced a slight discoloration, but gave no precipitate. That the substances, resulting from the ignition of the carbonate with sugar, and washing with acetic acid, contained calcium in the metallic state, combined with carbon, was evident from their being insoluble in acetic or chlorohydric acid; from the deposition of carbon, and giving a precipitate of oxalate of lime on being subjected to aqua regia, ammonia, and oxalic acid; from their metallic brilliancy, when burnished, and from their being excellent conductors of the voltaic fluid. By the ignition of the carbonates of baryta and strontia severally with sugar, Dr. Hare had attained analogous results to those above mentioned in the case of the similar ignition of carbonate of lime.

The extreme avidity of calcium for iron was quite striking; since, when a crucible was inclosed in a clean iron case without a cover, the mass, swelling up so as to reach the iron, became slightly imbued with it. By intensely igniting the carburet of calcium, obtained from the carbonate and sugar, with an equal weight of dry tanno-gallate of iron, the whole of the aggregate became so magnetic that every particle was transferred from one vessel to another by means of a magnet. The mass was filled with minute metallic globules, which yielded only partially to chlorohydric acid, and which, when dissolved in aqua regia, gave, after adding ammonia and filtration a precipitate with oxalic acid.

Dr. Hare was aware that it did not seem consistent that spangles of calcium, burnished upon porcelain, should retain their lustre; as, under other circumstances, and especially when amalgamated, that metal was found to oxidize as soon as exposed to the air. He had, however, through the kindness of Mr. Booth, a pupil of Wöhler, procured a specimen of magnesium evolved by that celebrated chemist. This specimen yielded, under the burnisher, spangles of a lustre as enduring as that observed by Dr. Hare in the case of calcium. It should be recollected that slight causes may affect the oxidability of substances, as has been lately seen in the case of the reaction of iron with nitric acid; and it is well known that silicon, boron, and some other substances have two distinct states, in one of which there is a greater susceptibility of combination with other bodies than in the other.

*April 5, 1839.*—The Committee to whom was referred a paper, entitled “Contributions to the Geology of the Tertiary Formations of

Virginia, (second series,) by Prof. William B. Rogers, and Prof. Henry D. Rogers," reported in favor of the publication of the Memoir, which was ordered accordingly.

The object of this communication is to describe the geology of the peninsula embraced between the Potomac and Rappahannock rivers, extending from the Chesapeake Bay to the limit of tide water, near Fredericksburg.

This area consists almost exclusively of the two great divisions of the Tertiary Deposits of Virginia, namely, the *Eocene* and *Miocene* formations.

The paper commences with a sketch of the topographical features of the peninsula, making allusion, among other points, to the interesting *terraced* configuration of the land bordering the valleys of the two rivers. It then proceeds to delineate the boundaries of the *Eocene* and *Miocene* formations. The *Eocene* is shown to occupy the western part of the peninsula, overlapping at its western edge the secondary sandstone of Fredericksburg, and extending eastward with a very gentle eastern dip beneath the overlying Miocene deposits, until it finally disappears below the level of the tide near the mouth of Chingoteague creek on the Rappahannock, and Mathias's Point on the Potomac. The *Miocene* spreads eastward from the line connecting these two localities to the termination of the peninsula; while some of its lower beds extend west of the same line into the Eocene district, where they are confined, however, to the highest portions of the land.

After offering numerous details relating to the range and limits of these two divisions of the Tertiary Deposits, the paper treats in the next place of the arrangement and composition of the *Miocene* strata, which are shown to possess a close general analogy in these respects to the *Miocene* beds of the peninsula of the York and James rivers, described in a former communication. The two most interesting points of agreement are the occurrence of the blue marls low down in the series, and the presence of the thin band of ferruginous rock separating the *Miocene* from the overlying *diluvium*.

In general the blue marl at the base of the Miocene, is the most replete in fossils, though towards the eastern extremity of the peninsula, shells, &c., abound in the upper sands and clays. Usually the *upper* beds of the *Miocene* in this district are destitute of fossils, though full of their casts and impressions.

These strata consist generally of light colored sandy clays, distinguished by a sulphurous smell, and an acid and styptic flavor. Carbonate of lime is not abundant, but the sulphate of lime occurs sometimes in valuable proportion. Sulphate of iron, sulphate of alumina,

free sulphuric acid, sulphur, and even an appreciable amount of sulphate of magnesia are also met with.

The fossil impressions in these beds are beautifully distinct, and appertain to all the species of shells which are found in perfect condition in the subjacent strata. In the blue clayey marl beneath, there often occurs a notable proportion of green sand, which is also found in some of the other Miocene strata, mixed pretty largely with common sand and clay, in beds destitute of fossils.

The paper treats in detail of many of the more interesting localities in the *Miocene* district, describing the stratification, and presenting evidence of the relative fertilizing agency of the several beds.

The fossil species which characterize the *Miocene* strata, are next enumerated.

In the next section, an account is given of the arrangement and composition of the *Eocene* strata of the peninsula.

In general, the lowest bed of the series is a dark greenish-blue mass, composed of clay, fine sand, and a little green sand; while above it, the strata are of various shades, yellow, greenish-gray, and brown. Little uniformity prevails in their arrangement at different localities.

A thin band of ferruginous gravel frequently overlies the *Eocene* strata, and forms a distinct line of demarkation between them and the bottom of the *Miocene*.

The stratification of the *Eocene* at various localities is exhibited in detail, and the characteristic fossils specified, while the curious chemical changes which these have undergone, are also discussed.

Dr. Hays stated that he had received through a friend some of the vaccine virus, recently obtained by Mr. Estlin, of Bristol, from the cow, and had used it with the most satisfactory results. He exhibited a scab, which presented all the characters described by Jenner, as appertaining to the genuine vaccine scab.

*April 19, 1839.*—The Committee of Publication, reported the publication of Part Second, Vol. VI, of the Society's Transactions.

Professor Bache communicated at the request of the Committee on the Observatory, the following translation of a letter addressed to him by Professor Encke, Director of the Observatory of Berlin.

The nature of the operations of an observatory must depend more upon the individual taste and qualifications of the director than those of any other scientific establishment. There is still so much to be done in every department of Astronomy, in any one of which there is sufficient employment, that if a director shows a particular disposition for certain lines of research, it would be most profitable for science that he should be allowed to follow them, and not be tied

down to other observations. It would be best, therefore, that the director should be allowed to regulate his own establishment.

Large observatories, like those of Greenwich, Königsberg, and Dorpat, require, in the present state of science, large telescopes, the art of dividing having been carried so far, that small instruments will not answer. The necessity for large telescopes for the meridian instruments, as well as for other uses, renders such an establishment very costly, and requires that it shall be independent of others. It appears not to be the intention, at present, to erect such an observatory in the United States, and details in regard to it are therefore unnecessary.

But smaller observatories may also be useful to science, especially for geographical purposes. Such a one, for example, as would be furnished by a room with a solid foundation, connected with a second having a free horizon. The first to have cuts north and south and east and west, the second to have a turning dome. The following named instruments would be suitable for such an observatory.

1. A meridian circle with a 42 inch telescope and 20 inch circle, - - - -	1,000 Rix Dolls.
2. A telescope of 72 inches focal length, -	900 "
3. An astronomical clock, - - - -	400 "
4. A chronometer, - - - -	500 "
5. Small transit instrument, - - - -	350 "
6. Small telescopes, barometers, thermometers, &c., a theodolite, &c, - - - -	750 "
	<hr/>
	3,900 "
	or about \$3,000.

A small observatory would thus be furnished for about three thousand dollars.

Determinations of the places of stars and planets, and even of the asteroids, may be made with the circle as far as the power of the telescope permits. Director Hansen, at Seeberg, and Professor Schwerdt, at Spire, have made excellent observations with a similar instrument. Observations of moon-culminating stars for longitude may be also made with it.

Observations of more difficult objects, except perhaps the nearest double stars, of comets, for the exterior of the planets, &c., may be made with the larger telescope.

The small transit instrument, placed east and west, will give the latitude within limits depending upon the accuracy to which the declinations of the stars are determined, and in conjunction with the chronometer, will serve to determine the geographical positions of places which may be selected. For longitude, observations are made

of the moon-culminating stars, which are observed at the same time with the meridian circle. For latitude, the transit is placed east and west.

The Altona Observatory may serve as a model of such a small observatory, and the yearly journeys of the Russian astronomers from Dorpat, as models for the use of the instruments in determining geographical positions. The observations of Professor Schwerdt, of Spire, will be found useful in the application of the meridian circle.

Such a small observatory will be well adapted to form observers; as the art of handling instruments so as to obtain accurate results is only to be acquired by practice.

Dr. Patterson made the following verbal communication:—

That the use of the wax tablet written on with an iron stylus, as practiced by the ancient Romans, had been tried, for the first time, this day, at the Pennsylvania Institution for the Instruction of the Blind, and that the success had been perfectly satisfactory. The blind read, with ease, the words written, traced geometrical figures, &c. It is confidently believed that the Roman tablet will prove of great importance in the instruction of the blind.

Professor H. D. Rogers made a verbal communication, in which he called the attention of the Society to a new compound of platinum, discovered by himself and his friend, Martin H. Boyé; upon the further investigation of which they are at present occupied.

It is a well characterized salt, composed of the deutochloride of platinum, and the binoxide of nitrogen, in which the former may be conceived, in accordance with the views of Professor Hare, to act the part of an acid, while the binoxide of nitrogen is in the relation of a base. It is of a bright gamboge yellow, is distinctly crystalline, though, in consequence of the minuteness of the crystals, their form has not been determined. It is highly deliquescent, absorbing water at ordinary temperatures, with great avidity, from the atmosphere.

It is rapidly decomposed by the mere addition of water, which causes an active effervescence; the binoxide of nitrogen being copiously evolved, and the deutochloride of platinum remaining in solution.

This interesting compound is best procured by evaporating a solution of platinum in *aqua regia* nearly to dryness, and then adding a large excess of fresh nitro-muriatic acid by small quantities at a time. The compound may thus be readily procured by filtering and pressing the powder between folds of bibulous paper. Should the concentration of the liquid be carried too far, it is requisite to add a little water, just sufficient in quantity to preserve the mass in a semi-fluid condition, and to prevent the precipitation of any deutochloride of platinum.



Specimens of the salt were exhibited, together with the apparatus employed in the qualitative examination of the compound, the constitution of which was made manifest by proper chemical re-agents.

The following candidates were elected members of the Society :

HUMPHREY LLOYD, A. M., of Trinity College, Dublin.

J. K. PAULDING, Secretary of the Navy of the United States.

JOHN LUDLOW, D. D., Provost of the University of Pennsylvania

BENJAMIN W. RICHARDS, of Philadelphia.

GEORGE W. BETHUNE, D. D., of Philadelphia.

GEORGE M. JUSTICE, of Philadelphia.

May 3, 1839.—Prof. Bache called the attention of the Society to the donation of transparent models of crystals, presented to the cabinet by Prof. Alexander.

He stated that these models had all the advantages of those made from glass, with greater convenience in the construction of them. The thin plates of mica are readily marked with a sharp instrument, and easily cut. The parts are put together with diamond cement, it having been found that this is a much better method of connecting the pieces composing the model, than by cutting the sheets partly through and using the mica as a hinge, which renders the sheets liable to split. The forms resulting from the cleavage of crystals, &c. may be represented in these models as in those of glass.

Dr. Hays made a verbal communication relative to the catoptric examination of the eye, as a means of distinguishing the morbid conditions of the transparent tissues of that organ.

He stated that when a lighted candle is held before an eye, the pupil of which is dilated, and in which there is no obscurity of the transparent tissues, three distinct images of the flame are visible ; two upright and one inverted, the latter appearing between the two former.

Experiments made to determine the causes of these reflected images, and the changes which occur in their number, position, &c. have shown that if a light be placed before the convex face of a single watch glass, or of several of them superimposed, one or more upright images of the flame will be seen, according to the number of glasses employed.\* Now in the eye there are two superimposed convex surfaces, viz.—1st, the cornea ; and 2d, the anterior capsule of the crystalline lens. Thus the formation of the two upright images is explained. Again, if a light be placed before the concave surface of a watch glass, an inverted image is seen. Such a surface

---

\* To be strictly accurate, it should be said that each of these images is double, for one is reflected from each surface of the glass, and these images are the more distinctly double, the thicker the glass.

exists in the eye, in the posterior capsule of the lens; and thus the third image is accounted for.

M. Sanson, a distinguished French surgeon, has taken advantage of the above facts, to distinguish cataract from amaurosis, and has been enabled to determine by this means some cases of supposed amaurosis to be in fact cataract, and has treated them successfully by operation.

Dr. Mackenzie, an eminent ophthalmologist of Glasgow, has also employed this means to determine the condition of the eye in glaucoma. Dr. Hays remarked that he had resorted to the catoptric examination of the eye in many cases, and believed that it would prove as valuable a means of diagnosis in some of the diseases of the eye; as auscultation is in those of the chest.

Dr. Hays exhibited and explained several models, designed and constructed by Dr. John Neill, resident surgeon at Wills' Hospital, for the purpose of illustrating the catoptric phenomena just explained.

Dr. Patterson communicated verbally a method of using thin sheets of lead by the blind in writing, reading, and musical notation, invented by Mr. Joseph Saxton. The sheets of lead are three thousandths of an inch in thickness. Dr. Patterson presented specimens of the writing and musical notation.

Dr. Bache communicated the decease of Mr. George Pollok, a member of the Society, who died in April last.

May 17, 1839.—Dr. Hare made the following verbal communication relative to the blasting of rocks by the aid of galvanic ignition in firing the charge.

The Doctor called the attention of the Society to the fact, that he had, so long ago as the summer of 1831, demonstrated the safety, certainty, and facility, which would arise in rock-blasting, whether under water or otherwise, from a resort to galvanic apparatus as the means of igniting the gunpowder employed. His efforts had been incited originally by those of a person named Shaw, who had procured a patent for employing mechanical electricity for the purpose; but who, finding that method of operating too precarious to be useful, had applied to Dr. Hare to acquire a knowledge of more effectual means. This led to the experiments of which the result has been published, both in the newspapers, and in the Journal of the Franklin Institute. The subject was now referred to, in consequence of the recent publication of analogous experiments by his friend, Prof. Daniell, of King's College, London, who, in the case in point, no doubt as in that in which he had "*reinvented*" Dr. Hare's concentric blowpipe, was ignorant of the results previously obtained in this country. Prof. Daniell had, in blasting, used the highly ingenious appa-

ratus known as "*Daniell's sustaining battery*," the contrivance of which had done him great honor; but Dr. Hare conceived that however preferable might be a battery of that kind, in processes requiring a permanent current; for a transient energetic ignition, such as is most suitable for blasting, the calorimotors which he had contrived, would be decidedly more efficacious.

Dr. Hare further communicated the results of his recent experiments to obtain calcium, as follows:

By igniting an equivalent weight of lime with an equivalent and a half of crystallized bichloride of mercury, in two successive experiments, residual masses were obtained, which, within a small fraction, had the weight which would have resulted from the union of an equivalent of calcium, with an equivalent of cyanogen. A portion of the compound thus made, was placed between electrodes of charcoal, the lower piece being excavated slightly to receive it, and the upper one being so shaped as to enter the cavity. The electrodes were severally supported by copper rods passing through stuffing boxes, so as to be included within a glass receiver, ground to fit air tight upon an extra air-pump plate. In consequence of this arrangement, the receiver could be exhausted of air, and the electrodes consequently situated in vacuo, or in an atmosphere of hydrogen, as might be deemed preferable. The lower electrode formed the cathode, the upper the anode, of two hundred pairs, each comprising one hundred square inches of zinc surface. Under these circumstances, when the circuit was completed, by throwing the usual charge of acid upon the plates, the most intense ignition ensued. The supposed compound of cyanogen appears to be an excellent conductor, and nothing could exceed the splendor of the purple light emitted during its deflagration. It was too vivid, however, for more than a transient endurance by an eye unprotected by deep colored glasses. After the compound was adjudged to be sufficiently deflagrated, and time had been allowed for refrigeration, on lifting the receiver, masses were found upon the coal which had a metallic appearance, and which, when moistened, produced an effluvia, of which the smell was like that which had been observed to be generated under like circumstances, by the silicuret of potassium.

Similar results had been attained by the deflagration, in a like manner, of a compound procured by passing cyanogen over quicklime, enclosed in a porcelain tube heated to incandescence.

Phosphuret of calcium, when carefully prepared, and subsequently well heated, was found to be an excellent conductor of the voltaic current, evolved from the apparatus above mentioned. Hence it was thought expedient to expose it in the circuit of the deflagrator, both

in an atmosphere of hydrogen, and in vacuo. The volatilization of phosphorus was so copious as to coat throughout the inner surface of the glass receiver, with an opaque film, in color resembling that of the oxide of phosphorus, generated by exposing this substance under hot water, to a current of oxygen.

The phosphuret at first contracted in bulk, and finally was for the most part volatilized. On the surface of the charcoal adjoining the cavity in which the phosphuret had been deflagrated, there was a light pulverulent matter, which, thrown into water, effervesced, and when rubbed upon a porcelain tile, appeared to contain metallic spangles, which were oxidized by the consequent exposure to atmospheric oxygen.

In one of Dr. Hare's experiments with the apparatus described, portions of the carbon forming the anode appeared to have undergone complete fusion, and to have dropped in globules upon the cathode.

When rubbed, these globules had the color and lustre of plumbago, and by friction on paper, left traces resembling those produced by that substance. They were susceptible of reaction with chlorohydric or nitric acid, or with aqua regia. They were not, in the slightest degree, magnetic.

About 1822, Professor Silliman had obtained globules which were by him considered as fused carbon, by others were deemed to be depositions of carbon carried from one electrode to the other. Professor Silliman had at that time sent Dr. Hare several nodules for examination, of which none, agreeably to his recollection, appeared so much like products of fusion as those lately obtained.

Formerly, plumbago had been considered as a carburet of iron, but latterly, agreeable to the high authority of Berzelius, should be viewed as carbon holding iron in a state of mixture, and not in that of chemical combination. It would not then be surprising, if the globules in question furnished an instance of the conversion of charcoal into plumbago.

Since the above mentioned experiments were made, Dr. Hare has had reason to believe that the compound obtained as above described, by heating lime with bicyanide of mercury, contains fulminic acid, or an analogous substance. The compound being dissolved in acetic acid, and the filtered solution subjected to nitrate of mercury, a copious white precipitate resulted. This being desiccated, proves to be a fulminating powder. It explodes between a hammer and anvil like fulminating mercury, or rather with the sharp sound of fulminating silver.

Dr. Hays made a verbal communication of a case of the application of the catoptric method of examining the eye, by which he had de-

tected the destruction of the lens and of its capsule, under circumstances which would not otherwise have led to the conclusion that they had been destroyed, and where vision had been obtained by the use of a cataract lens.

*June 21, 1839.*—The librarian was authorized to take order in relation to an exchange of the Transactions of the Society, for the Journal of the Boston Natural History Society.

The committee on the letters of Mr. J. P. Hulliken and Dr. Townsend reported, and was discharged.

The committee to whom was referred the publication of certain meteorological tables, accidentally omitted in their place in the Transactions, and the journal of Dr. Thomas Hewson, reported in favor of the publication of certain of the former and of the latter.

Dr. Bache presented a translation of an obituary notice of Professor Rask of Copenhagen, late a member of the Society, to be deposited in the archives of the Society.

Mr. Vaughan informed the Society of the decease of Doctor Thomas Cooper, a member of the Society, who died on the eleventh of May last.

Dr. Hays communicated verbally the case of a woman laboring under an affection of the optic nerve, in which a defect in the recognition of colors was developed, according to her statement, at the same time with the affection of the general vision, and in which a partial recovery of the power of vision had been attended with the recovery of the power to distinguish colors.

Dr. Hare laid before the Society, portions of barium, strontium and calcium, and stated the considerations which led him to attempt their extrication, and the means by which he had succeeded.

*July 17, 1839.*—The Committee on the observations of the Solar Eclipse of May 14–15, 1836, reported, and their report was ordered for publication.

The American observations, twenty eight in number, were given at length. At the invitation of Mr. C. Rumker, Director of the Hamburg Observatory, conveyed through Prof. A. D. Bache, twenty one of these observations had been forwarded by Mr. John Vaughan to that distinguished astronomer, for comparison with those which had been made in Europe. The report contained a letter from Mr. Rumker, in which the time of ecliptic conjunction, with its variations for the small errors of the tables, was deduced from each of the European and American observations. Mr. Rumker remarks, that the corrections of this time for the corrections of the moon's declination and parallax, appearing with opposite signs in the observations on the two continents, afford unusual facilities for determining these corrections, par-

ticularly the latter. Mr. Rumker's letter not having given the final results deducible from his equations of condition, the committee appended a letter from Mr. Sears C. Walker, in which he deduces from Mr. Rumker's equations, the following corrections of the solar and lunar elements given in the Nautical Almanac.

$$\begin{aligned}
 d(\odot + \oplus) &= -2''.279 = \text{correction of sum of semidiameters.} \\
 d(\odot - \oplus) &= -1''.750 = \text{ " difference of semidiameters.} \\
 d\beta &= -6''.736 = \text{ " moon's latitude.} \\
 d\pi &= +1''.516 = \text{ " moon's parallax.} \\
 d\lambda &= -2''.276 = \text{ " moon's longitude.}
 \end{aligned}$$

These corrections being referred to the moon's orbit and its secondaries, give, after Bessel's notation (Astr. Nachr. 320)

$$\begin{aligned}
 \epsilon &= -2''.934 = \text{cor. moon's place in true orbit.} \\
 \zeta &= -7''.198 = \text{ " on secondary to do.}
 \end{aligned}$$

Mr. Peters, (Astr. Nachr. 326) without the American observations, had obtained

$$\begin{aligned}
 \epsilon &= -3''.650. \\
 \zeta &= -5''.472.
 \end{aligned}$$

Mr. Walker having previously reduced the American observations with Peters's co-ordinates and corrections, furnishes a comparison of the longitudes from Greenwich, derived by different computers from this eclipse.

	Walker from Rumker's equations.			Walker from Peters's co-ordinates.		
	<i>h.</i>	<i>m.</i>	<i>s.</i>	<i>h.</i>	<i>m.</i>	<i>s.</i>
Washington, (Capitol,) - - - - -	5	8	13.83	5	8	13.45
Haverford School, Delaware Co., Pa. - - -	5	1	16.53	5	1	15.05
Germantown, C. Wister's private Observatory, - - -	5	0	40.61	5	0	40.94
Philadelphia, (State House,) - - - - -	5	0	38.89	5	0	39.60
West Hills, (Coast Survey,) - - - - -	4	53	41.11	4	53	42.05
Southwick, Mass., A. Holcomb's p. Obs. - - -	4	51	12.89	4	51	13.25
Providence, Brown University, - - - - -	not reduced.			4	45	38.33
Dorchester, Mass., Wm. C. Bond's p. Obs. - - -	"			4	44	16.92

Mr. Walker finds from the resolution of Rumker's equations of condition, + 1''.516 for the correction of Burkhardt's constant of the moon's equatorial parallax. In the Memoirs of the Astronomical Society, Vol. x, Mr. Henderson gives + 1''.5 as the value of this correction, derived from Plana's *Théorie de la Lune*, and + 1''.3 as the value of the same, derived from a discussion of all the meridian observations of the moon made in 1832 and 1833, with the mural circles at Greenwich, Cambridge, and the Cape of Good Hope. This correction had hitherto been derived chiefly from theory and meridian observations. It is seldom that an eclipse or occultation has been so extensively observed as to furnish a determination of this element. In the present instance, the results by the three independent methods, present a close agreement.

Dr. Chapman, one of the Vice Presidents of the Society, stated that he had received a letter from the Prince of Musignano, informing him

that a meeting of the scientific men of Italy would be held at Pisa, in Oct. next, and inviting the Society to send a delegate to the meeting.

Dr. Patterson communicated the decease of Mr. Francis Nichols, a member of the Society, on the 7th of July.

Dr. Bache also announced the decease of Dr. John Newnam, formerly of Salisbury, N. Carolina, a member of the Society.

The following candidates were declared duly elected members of the Society:—

THEOD. ROMEYN BECK, M. D., of Albany.

RICHARD C. TAYLOR, of Philadelphia.

August 16, 1839.—A communication from the foreign Secretary of the Royal Society of London, in relation to magnetic observations was referred to the astronomical committee.

Dr. Duglison described the appearances which he had witnessed, in company with Professor Silliman, after the tornado of the 31st ultimo, at New Haven. The evidences appeared to him to favor the idea of a gyratory motion. The direction of the storm was from south-west to north-east.

Mr. Justice described a similar tornado which had occurred on the same day, fifteen miles north of Philadelphia, showing evidence, in his opinion, of a similar movement of gyration.

2. *Proceedings of the Boston Society of Natural History.* Compiled from the records of the Society, by JEFFRIES WYMAN, M. D., Recording Secretary.

June 5, 1839.—J. E. TESCHEMACHER, Esq. in the chair.

Dr. A. A. GOULD read a communication from Prof. C. B. Adams, giving the description of a shell found at East Boston, and called by him *Delphinula minor*; it was not referred to the genus *Delphinula*, however, without some hesitation. Dr. Gould having made a more extended examination was induced to consider it as identical with *Helix corpuloides*, Montagu; and that it came under Brown's new genus *Delphinoidea*.

Mr. T. J. WHITTEMORE read a report on the specimens of *Planorbis corpulentus* presented to the society by Prof. C. B. Adams. They were collected from the Otter Creek, Middlebury Vt., and the species is described in the appendix to Long's second expedition. The *corpulentus* is closely allied to the *trivolvus*. The former however is much less rounded on the sides of the whorls; carinæ are more prominent and the upper side is much more flattened horizontally; the shell is larger and higher in proportion to its width, and the aperture extends both above and below its penultimate whorl.—Habitat, in shal-

low and quiet water on rocks, to which it adheres in an erect position, the plane of the aperture being the base.

Mr. J. E. TESCHEMACHER presented a specimen of *Elvella esculenta* from Oak Island. This is much esteemed as an article of food, and at certain seasons of the year is in great demand in the London market; it is not however so rich or so highly esteemed as the *truffle*. He also exhibited a specimen of *yellow Trillium*, received from Mr. R. H. Gardiner, of Gardiner, Me.; this was first noticed by Dr. C. T. Jackson, and afterwards was procured by Mr. G. He also exhibited a new variety of the *Marchantia*, probably the *triceps* of Hitchcock's catalogue.

Mr. T. made a few remarks on the report of the surveyors of the State of N. York. He thought that besides giving descriptions of the actual state of things, they should also institute comparisons between them and similar appearances in other countries. Comparative information was extremely valuable in an agricultural or an arboricultural point of view, especially as to the importance or profit of different growths of timber; the same remarks might be applied to the botany of different countries.

June 19, 1839.—G. B. EMERSON, Esq., President, in the chair.

Mr. J. E. TESCHEMACHER read a report on the minerals found at the *sienite quarry*, at Milk row, in Charlestown. *Prehnite* is found there, varying in color from pure translucent and opaque white, to fine apple green; some specimens are as dark and brilliant as the finest *Chrysoptase*. The crystals consist for the most part of aggregated groups with curvilinear faces. In one instance the form of aggregation was elliptical, imbedded in carbonate of lime. There are also crystals of the primary form, a right rhombic prism; the measurements by the goniometer were as follows; M or M' on f  $139^{\circ} 45'$ ; M on M'  $101^{\circ} 05'$ ; according to Phillips the last is  $100^{\circ}$ ; the result stated however was procured from repeated observations. *Quartz* is met with in nodules and crystals; the latter small, but of the purest water, occasionally rising from the midst of pure green *prehnite*; in some the modifications *n*, *h*, 1, 2, and *i*, 1, 2 are visible. *Feldspar*; this is generally in a state of decomposition, which appears to commence from the centre. In one specimen the prism was coated with bright green *crystallized chlorite*, interspersed with small masses of pure white and nearly transparent curvilinear *prehnite*. *Hornblende* is found in form of oblique rhombic prism with modifications C, K, *l*; crystals are small and black on white *prehnite*. *Epidote* is found in minute dark green crystals with the usual terminations. *Carbonate of lime* occurs in small crystals with modifications resembling dog tooth spar; also in the form of the primary rhomb half an inch in



length. In one specimen the carbonate rested on green prehnite; decomposition, indicated by the deep striæ in the lines of cleavage, had apparently commenced in the lime, and had been subsequently arrested, crystallization recommencing, as the sharp edges produced by decomposition were covered with an infinite number of minute crystals. Another specimen assumed the form of a nodule six inches in diameter, bearing a strong resemblance to the carbonate of iron. *Stilbite* is found in cavities of prehnite, assuming the form of the rhombic prism without modifications; also with the modification *a* and *c*. *Chabasie*, on prehnite, of a rhomboidal form is met with, measuring  $94^{\circ} 46'$  and  $85^{\circ} 40'$ , generally of an opaque milk white color, and one sixteenth of an inch in size. *Laumonite*, abundant. Other minerals had been found which he had not been able to determine.

July 3, 1839.—C. K. DILLAWAY, Esq., in the chair.

Dr. D. H. STORER exhibited living specimens of male and female *Syngnathus*. He stated that numerous males had been taken in this vicinity during the present season, in all of which there existed a pouch on the abdomen, posterior to the anus, in which were numerous ova; these last were hatched in the course of twenty four hours after they were taken. The females were subsequently found and recognized by the existence of ovaries. The female deposits the ova in the pouch of the male, where they remain until hatched.

July 17, 1839.—Dr. A. A. GOULD, in the chair.

Dr. D. H. STORER stated that since the last meeting he had had an opportunity of seeing a large specimen of the *Carcharias obscurus* of Le Sueur, taken off Nahant. This specimen was about nine feet long, and weighed 800 or 900 pounds. There were six or seven rows of well formed teeth, but only one row above and two below had as yet made their appearance through the lining membrane of the mouth; all the teeth were serrated.

Dr. S. also exhibited a specimen of *Emys Blandingii* of Holbrook, taken in Haverhill in this state. The only localities heretofore known were the prairies in Illinois and the territory of Ouisconsin, where they are said to be abundant. This species belongs to the section *Hiantes*, (Dum. and Bibron,) being unable perfectly to close the shell.

Dr. T. M. BREWER stated that considerable doubt existed with regard to the color and configuration of the eggs of the *Chicadee*. He had during the last week received two specimens which were small, oval, and uniformly speckled with red spots.

Mr. J. E. TESCHEMACHER exhibited specimens of the following plants brought from the Blackstone river, by Mr. F. A. Eddy, a member of the society.—*Scirpus sylvaticus* of Lin., Willd., Vahl, Hooker,

De Cand. and J. E. Smith; it grows in moist and shady woods, and on banks of rivers; pretty common in Scotland, less frequent in England; root is creeping; plant grows a yard high or more, smooth; leaves grassy and flat, rough, cutting on the edges and keel. Panicle consists of innumerable little dark green, ovate spikes; glumes obtuse with more or less of a small point: stigma 3-fid; seed lenticular, whitish, smooth with six or eight rough bristles. We have many *Scirpi* which are unknown in Europe. Sir J. E. Smith only names three which are unknown here, viz. *S. setaceus*, *holoschemus* and *sylvaticus*.

Mr. T. also exhibited a specimen of the *Andromeda mariana* from the same locality; also the rarest of our American plants, *Lygodium palmatum*. A curious variety of *Linaria vulgaris* (the *Peloria* of Lin.) was exhibited; the corolla appears in the form of a cone, terminated above by a prominent border of five divisions, and below producing five spurs instead of one; so that according to Nuttall we have the ringent flower restored to its natural symmetry and regularity, this being the original condition of the flower, an opinion, however, which is not substantiated.

Dr. A. A. GOULD read descriptions of the following species of shells.

**SOLECURTUS NITIDUS.** Testâ oblongo-ovatâ; utrinque rotundatâ, inequilaterali; epidermide inflectâ, luteo-virescente, glabrâ, postice corrugatâ; intus costâ transversali. Long. 3 poll. Alt.  $1\frac{3}{10}$ . Lat.  $\frac{7}{10}$ .

**MACTRA OVALIS.** Testâ magnâ, crassâ, obovatâ, subtriangulari, subequilaterali; epidermide rudi, fusco-viridi, transverse corrugatâ indutâ; natibus, areolâ lanceolatâ. Long. 4 poll. Alt.  $2\frac{7}{10}$ . Lat.  $1\frac{9}{10}$ .

**BULLA DEBILIS.** Testâ parvâ, convolutâ, ovatâ, ventricosâ, hyalinâ, basi truncatâ, sub-umbilicatâ; spirâ retusâ, discoideâ; anfractibus quatuor, suprâ rotundatis. Long.  $\frac{5}{10}$ . Lat.  $\frac{1}{10}$ .

**BULLA OBSTRACTA.** Testâ parvâ, pallidâ, convolutâ, ovoideâ, medio obstrictâ; anfractibus quinque, spirâ elevatâ, obtusâ; suturâ duplicatâ; aperturâ longitudinali, inferne dilatatâ. Long.  $\frac{7}{10}$  poll. Lat.  $\frac{4}{10}$ .

**LYMNEA CHALYBEEA.** Testâ ovatâ, anfractibus quatuor; spirâ acutâ; suturâ profundâ; aperturâ magnâ, dilatatâ; intus chalybeâ, extra nigricante. Long.  $\frac{7}{10}$  poll. Lat.  $\frac{7}{10}$  poll.

**VALVATA PUPOIDEA.** Testâ parvâ, castaneâ, elevatâ: anfractibus quatuor ad quinque, ultimâ a precedente disjunctâ. Long.  $\frac{1}{10}$  poll. Lat.  $\frac{3}{10}$  poll.

**PLANORBIS HIRSUTUS.** Testâ dextrorsâ, discoideâ, utrimque concavâ; anfractibus quatuor, lineis hirsutis, volventibus insignibus. Lat.  $\frac{4}{10}$  poll. Long.  $\frac{1}{10}$ .

**NATICA FLAVA.** Testâ ventricoso-globosâ, imperforatâ, albâ, epidermide flavâ; anfractibus quatuor; columellâ flexuosâ; aperturâ amplâ. Long. 1 poll. Lat.  $\frac{9}{10}$  poll.

**NATICA CANALICULATA.** Testâ ovato-conicâ, ponderosâ; spirâ retusâ: anfractibus quatuor, superne subcarinatis; suturâ profundé impressâ; aperturâ semilunari; umbilico parvo, lineari. Long.  $1\frac{1}{10}$  poll. Lat.  $\frac{7}{10}$  poll.

**LACUNA NERITOIDEA.** Testâ ovato-globosâ, tenui, lævi, flavescente, epidermide scabrâ; anfractibus tribus convexis, ultimo magno; spirâ fere nullâ; aperturâ obliquâ, semilunari; umbilico profundo. Long.  $\frac{1}{2}$  poll. Lat.  $\frac{1}{4}$  poll.

**FUSUS SCALARIFORMIS.** Testâ fusiformi, albâ vel castaneâ, longitudinaliter 15 ad 20 lamelloso-costatâ; caudâ longiusculâ; aperturâ spiram æquante. Long.  $1\frac{3}{4}$  poll. Lat.  $\frac{4}{5}$  poll.

**FUSUS TORNATUS.** Testâ ovato-conicâ, antiquatâ, pallide corneâ; anfractibus sex vel septem convexis, costis tribus obsoletis, castaneis cinctis; aperturâ rotundatâ, evasâ, spiram æquante; canali brevi, valdé recurvâ. Long.  $2\frac{3}{4}$  poll. Lat. 2 poll.

**BUCCINUM ROSACEUM.** Testâ parvâ, conico-acutâ, albâ, rosaceo-tinctâ; anfractibus sex, plano-convexis, spiraliter lineolatis; aperturâ spirâ breviorē; columellâ arcuatâ, planulatâ. Long.  $\frac{3}{10}$  poll. Lat.  $\frac{3}{20}$  poll.

Dr. J. WYMAN exhibited the intestine of a *mackerel shark*, (*Lamna punctata*, Mitchill,) showing the ducts of the pancreas and liver, the spiral valve formed by the mucous membrane of the intestine, a communication between the cavity of the peritoneum and anus by means of two small canals, and an opening in the lower part of the intestine communicating with a hollow organ, on which commenced the first branches of the vena cava.

August 7, 1839.—Dr. J. B. S. JACKSON, in the chair.

Dr. J. WYMAN made a written report on the *electrical eel*, (*Gymnotus electricus*, Lin.) exhibiting dissections of the electrical organs, and of the nerves by which they are supplied; he also gave an account of the physical and physiological properties of the electricity developed by this fish, and showed the analogy between it and common electricity.

Dr. D. H. STORER read a communication from Mr. J. G. Anthony of Cincinnati, giving a description of the two following new species of shells; viz. *Helix striatella* and *Paludina Cincinnatiensis*.

Dr. S. also gave an account of an *elephant shark* (*Squalus elephas*, Le Sueur) taken near Provincetown, Mass., measuring 30 ft. in length.

Mr. J. E. TESCHEMACHER exhibited some fossil corals and madrepores in limestone, from Devonshire, England, beautifully ground and polished; also some photogenic drawings of plants, feathers, &c., copied from nature.

Sept. 4, 1839.—AMOS BINNEY, Vice President, in the chair.

Dr. C. T. JACKSON gave an analysis of the *serpentine marble* from Vermont. This mineral is harder than common serpentine or feldspar. The result of analysis is as follows :

Water,	-	-	-	-	-	7.70
Silica,	-	-	-	-	-	45.80
Magnetic Iron,	-	-	-	-	-	2.00
Magnesia,	-	-	-	-	-	33.44
Protoxide of Iron,	-	-	-	-	-	7.60
Oxide of Chrome,	-	-	-	-	-	2.00
Loss,	-	-	-	-	-	1.46

100.00

Dr. JACKSON also gave an analysis\* of a new mineral obtained from Chessy, France, which was supposed to be a hydrate of copper; analysis however proved it to be a crenate of copper instead of the hydrate. For this mineral, he proposed the name of Beaumontite, in honor of M. Elie de Beaumont, the distinguished French geologist. He also exhibited specimens in which *crenic* and *apocrenic* acid were combined with metallic bases. Crystals of *crenic acid* were also exhibited; these were obtained by dissolving the acid in alcohol, and evaporating to dryness in the sun.

Dr. JACKSON then read a communication addressed to him by Mr. George Catlin, giving an account of his visit to the Côteau des Prairies, the locality from whence is obtained the Indian "pipe stone."†

### 3. Reports on the Shells and Minerals presented by Dr. Brinckerhoff to the New York Lyceum of Natural History.‡

The subscriber, who was appointed to examine and report upon certain shells forming part of the valuable specimens of natural history presented

\* For the analysis of this mineral, see last number of this Journal, p. 398.

† See the letter, page 138 of this No.

‡ To the Editors of the *Am. Jour. Science and Arts*.—In the month of July last, Dr. Brinckerhoff, of the U. S. ship North Carolina, presented to the Lyceum of Natural History of this city, a large and valuable collection of specimens in natural history, collected by him during the recent voyage of this ship. These specimens consisted of various *mammalia*, birds, reptiles, *mollusca* and *crustacea*, numerous tropical plants and seeds, with many interesting geological and mineralogical specimens. They were deemed of sufficient interest and importance to be referred to special committees for examination and report. The only full reports which have yet been made, are those upon the mineralogical specimens, and upon the mollusca. As there is no immediate prospect of a continuation of our "Annals," we have thought the best use we could make of these reports would be to offer them for publication in your Journal. Yours most respectfully,

JOHN H. REDFIELD, Cor. Sec. N. Y. L. N. H.

New York, November 19th, 1839.

to the Lyceum by Doctor Brinckerhoff, of the U. S. Navy, respectfully reports, that the shells thus referred to him consist of *Annulata*, *Cirrhipe**da*, *Conchifera* and *Mollusca*, and are found to be as follows:

*Annulata*, 4 genera, viz.

1. Dentalium politum, Linn.
2. Sabellaria, 1 species, ?
3. Spirorbis, 1 do. ?
4. Serpula, 2 do. ?

*Cirrhipe**da*, 7 genera, viz.

1. Tubicinella Balænarum, Lam.
2. Coronula Balænaris, Lam.  
—— diadema, "  
—— Testudinaria, "
3. Balanus tintinnabulum, Brug.  
—— ——— ?
4. Anatifa lævis, Lam.
5. Pollicipes mitella, Lam.
6. Cineras vittata, Lam.
7. Otion Cuvieri, Lam.

*Conchifera*, 22 genera, viz.

1. Solen Dombeii, Lam.
2. Amphidesma solidum, Gray.
3. Mesodesma donacia, Desh.
4. Saxicava pholadis, Lam.
5. Petricola ochroleuca, Lam.
6. Tellina sulphurea, Lam.  
—— scobinata, Linn.
7. Capsa Brasiliensis, Lam.
8. Cytherea impudica, Lam.  
—— meretrix, Lam.  
—— Dione, Lam.  
—— flexuosa, Lam.  
—— castanea, Lam.
9. Venus corbis, Lam.  
—— Peruviana, Linn.
10. Cardium unedo, Linn.
11. Cardita.  
——
12. Hiattella arctica, Lam.
13. Isocardia Moltkiana, Born.

14. Arca scapha, Lam.  
—— rhombea, Born.  
—— senilis, Linn.
15. Modiola discors, Lam.  
—— caudigera, Lam.
16. Mytilus bilocularis, Lam.  
—— smaragdinus, Chemn.
17. Meleagrina margaritifera, Lam.
18. Pecten purpuratus, Lam.
19. Plicatula cristata, Lam.
20. Spondylus maximus, Gualt.
21. Ostrea cornucopiæ, Lam.
22. Orbicula lamellosa, Brod.

*Mollusca*, 50 genera, viz.

1. Chiton elegans, Frembl.  
—— olivaceus, Frembl.  
—— Cumingii, Frembl.  
—— spinosus, Brug.  
—— Barnesii, Gray.
2. Patella lævigata, Chemn.  
—— saccharina, Linn.  
—— striata, Petit.  
—— tessellata, Mull.  
—— Testudinaria, Linn.  
—— ——— ?
3. Siphonaria gigas, Sowb.  
—— Lessonii, Blain.
4. Fissurella biradiata, Frembl.  
—— grandis, Sowb.  
—— oriens, Sowb.  
—— Panamensis, Sowb.
5. Hipponix barbata, Sowb.
6. Calyptrea radians, Desh.  
—— rugosa, Desh.  
—— spinosa, Sowb.  
—— tectum sinense, Lam.
7. Crepidula foliacea, Brod.  
—— fornicata, Lam.  
—— squamosa, Brod.

8. *Bulla ampulla*, Linn.  
 9. *Helix Peruviana*, Lam.  
 ——— *melanotragus*, Born.  
 10. *Bulimus Gravesii*, King.  
 ——— *Leuzonicus*, Sowb.  
 ——— *undatus*, Brug.  
 11. *Partula hyalina*, Brod.  
 12. *Neritina zebra*, Lam.  
 ——— *picta*, Sowb.  
 ——— *caffra*, Gray.  
 13. *Nerita textilis*, Gray.  
 ——— *polita*, Linn.  
 14. *Natica glaucina*, Lam.  
 ——— *glauca*, Humb.  
 15. *Janthina communis*, Lam.  
 ——— *exigua*, Lam.  
 16. *Sigaretus haliotoideus*, Lam.  
 17. *Haliotis Cracherodii*, Linn.  
 ——— *striata*, Linn.  
 18. *Solarium granulatum*, Lam.  
 19. *Trochus ater*, Lesson.  
 20. *Monodonta fragarioides*, Lam.  
 ——— *pagodus*, Lam.  
 ——— *viridis*, Lam.  
 21. *Turbo petholatus*, Linn.  
 ——— *torquatus*, Lam.  
 ——— *cornutus*, Gmel.  
 22. *Phasianella Peruviana*, Lam.  
 ——— ——— ?  
 23. *Turritella replicata*, Lam.  
 ——— *fuscata*, Lam.  
 24. *Cerithium aluco*, Brug.  
 ——— *nodulosum*, Brug.  
 ——— *tuberculatum*, Lam.  
 25. *Pleurotoma virgo*, Lam.  
 26. *Turbinella rhinoceros*, Lam.  
 ——— *pugillaris*, Lam.  
 27. *Cancellaria cancellata*, Lam.  
 ——— *decussata*, Sowb.  
 28. *Fasciolaria aurantiaca*, Lam.  
 29. *Fusus incrassatus*, Lam.  
 ——— *longissimus*, Lam.  
 30. *Pyrula ventricosa*, Sowb.  
 31. *Ranella ventricosa*, Brod.  
 ——— *granifera*, Lam.  
 32. *Murex radix*, Lam.  
 ——— *regius*, Swains.  
 ——— *crassilabrum*, Gray.  
 ——— *ramosus*, Linn.  
 33. *Triton canaliferum*, Lam.  
 ——— *tuberosum*, Lam.  
 34. *Rostellaria curvirostris*, Lam.  
 35. *Strombus canarium*, Linn.  
 ——— *gibberulus*, Linn.  
 ——— *granulatus*, Wood.  
 ——— *auris Dianæ*, Linn.  
 ——— *floridus*, Lam.  
 36. *Cassis rufa*, Brug.  
 ——— *vibex*, Brug.  
 ——— *sulcosum*, Brug.  
 37. *Ricinula tuberculata*, Blain.  
 38. *Purpura armigera*, Lam.  
 ——— *patula*, Lam.  
 ——— *planospira*, Lam.  
 ——— *chocolatum*, Duclos.  
 ——— *columellaris*, Lam.  
 ——— *Riosquiformis*, Duclos.  
 ——— *hippocastanum*, Lam.  
 ——— *angulifera*, Duclos.  
 39. *Concholepas Peruviana*, Lam.  
 40. *Buccinum annulatum*, Lam.  
 ——— *Gayii*, Kiener.  
 ——— *inflatum*, Lam.  
 41. *Terebra* ——— ?  
 42. *Columbella mercatoria*, Lam.  
 ——— *mendicaria*, Lam.  
 43. *Mitra pontificalis*, Lam.  
 ——— *tæniata*, Lam.  
 44. *Marginella Bellangeri*, Kiener.  
 45. *Ovula birostris*, Sowb.  
 46. *Cypræa Testudinaria*, Linn.  
 ——— *Mauritiana*, Linn.  
 ——— *Argus*, Linn.  
 ——— *pustulata*, Lam.  
 ——— *obelata*, Lam.  
 ——— *coccinella*, Linn.

- |                                |                             |
|--------------------------------|-----------------------------|
| 47. Terebellum subulatum, Lam. | Conus imperialis, Linn.     |
| 48. Ancillaria castanea, Sowb. | ——— betulinus, Linn.        |
| ——— cinnamomea, Lam.           | ——— textile, Linn.          |
| 49. Oliva hiatula, Lam.        | ——— tulipa, Linn.           |
| ——— Senegalensis, Lam.         | ——— terebra, Brug.          |
| ——— episcopalis, Lam.          | ——— stercus muscarum, Gmel. |
| ——— ispidula, Lam.             | ——— canonicus, Brug.        |
| 50. Conus litteratus, Gmel.    | ——— sponsalis, Chemn.       |
| ——— lividus, Brug.             |                             |

The above mentioned shells are generally in good order and preservation. They are principally from Mazatlan, St. Lorenzo, Guayaquil, Calao, Valparaiso, and the Sandwich and Society islands; a few are from the Atlantic coast of South America.

Doctor Brinckerhoff has also with much pains procured several of these species containing the animal, and preserved them in spirits of wine. These, as well as various fruits, seeds, animals, &c. &c., have been carefully divided and placed in separate jars. Among the more rare specimens, may be noticed the Marginella Bellangeri, Kiener, from Bahia, the Cypræa Testudinaria, the Ancillaria cinnamomea, the clusters of the Orbicula lamellosa, Brod., from Valparaiso, and the Purpura planospira.

The entire collection is one of the most valuable in this department ever presented to the Lyceum, embracing more than two hundred species; of nearly one half of which there were no specimens in our museum. It has been made by a gentleman attached to the navy, in the intervals of his official duties and during a single cruise. By it he has well deserved not only the thanks he has already received from this institution, but those of every lover of science and useful knowledge. His example and that of several others show how much may be accomplished by the naval officers if a similar zeal shall become general among them. By collecting and bringing home the natural productions of the lands and oceans that they visit, they may employ the leisure which their profession sometimes affords, in an occupation at once useful and interesting; enlarge the boundaries of science, and add new claims to the many they already possess to the esteem and admiration of their countrymen.

The subscriber suggests the propriety of publishing the several reports upon the specimens presented by Dr. Brinckerhoff in such manner as the Society may think expedient.

JOHN C. JAY.

New York, October, 1839.

*Report upon the Minerals, Geological Specimens and Fossils, from the island of St. Lorenzo, presented to the New York Lyceum of Natural History, by Dr. Brinckerhoff, and referred to Jos. Delafield.*

*Selenite*, in detached crystals and in fasciculated groups, imbedded in dark red and brown indurated clay.

Vol. xxxviii, No. 1.—Oct.—Dec. 1839.

*Calcareous Spar*, white, massive, from a vein of the same in one of the rock strata of the island.

*Galena.*

*Asphaltum.*

*Ferruginous Clay.*

*Saline Sandstone*, assuming singular configurations, cellular, cavernous, and sometimes botryoidal. The forms seem to be derived from the accidental solution of the salt, and wasting away of the sandstone irregularly.

One triangular specimen of saline sandstone is in the form of an irregular tetrahedron, the two axes being unequal. The planes are wasted away, and the solid angles not, so that a continuation of the same process would leave a cellular substance like the others, but regular. This form is said to be the most common, and although it is not decidedly a crystal, the tendency of its component parts to crystallize and the symmetry of this specimen, increase the probability that it is. Further specimens and observations are desirable, and the observer should be acquainted with the sandstone of Fontainbleau, which suggests itself as analogous in some respects.

The geological specimens from the same island are compact *Quartz rock* from the summit, *Basaltiform rock*, but its identity with basalt is doubtful; the forms are the chief resemblance in the specimens exhibited, which specimens are argillaceous and ferruginous. Their exposure to the weather and contact with other mineral substances, may have caused some change; and as basalt is sometimes liable to decomposition, it is probable that the specimens are from a formation of true basalt.

*Striped or Variegated Sandstones.*

*Light Colored Clay Slate.*

*Dark Red Ferruginous Clay.*

*Graywacke.*

Coal has lately been discovered on the island, and fossils are contained in some of the rock strata, so that this little island offers to the geologist in its numerous strata of rocks, with their accompanying minerals and fossils, a more varied field for observation than is usual in so small a space. The committee cannot give the desired geological description for the want of other facts, but hopes to obtain them.

The fossils consist of small bivalves in the clay slate.

Trigonia in graywacke, and casts of Trigonia in the red clay.

Ammonites and casts of ammonites, and some small Isocardia.

Dr. Brinckerhoff has also collected a variety of the rolled pebbles of the beach. They are principally porphyries of different colors, the feldspar crystals being smaller and generally white; siliceous pebbles and common jaspers.



4. *Further account of the Shooting Stars of Aug. 9 and 10, 1839.*

1. *Columbia, Tenn., N. lat. 35° 36' ; W. lon. 87°.*—Mr. Thomas R. Dutton has communicated to me the following observations made on the night of August 9, 1839. “From 0h. 41m. A. M. (Aug. 10,) to 1h. 31m., I saw 45 shooting stars; three fourths of these proceeded from a radiant; about one fourth had trains. From 2h. 36m. to 3h. 6m. I saw 35; from 3h. 6m. to 3h. 36m. I saw 20. Of those which had trains, scarcely one moved in an unconformable direction: of those seen from 2h. 36m. to 3h. 6m. about three fourths left trains behind them, and five sixths of them obeyed the radiant. The meteors were not as large or as brilliant as those of last year, but resembled them in other particulars. I observed the progression of the radiating point noticed last year by Mr. Schaeffer.” (This Journal, Vol. xxxv, p. 169.)

2. *At Tunbridge Wells, (Eng.) N. lat. 51° 7' ; E. lon. 15'.* “Prof. Powell saw on the 10th of August, 1839, a very brilliant exhibition of meteoric stars: they averaged from 15 to 20 in the quarter of an hour: they all left trains of light after them: the motion of all was from N. toward the S.” *Lond. Athenæum, Aug. 31, 1839, p. 657.*

3. *At Brandsbury House, about 3 miles N. W. of London.* Edward Cooper, Esq., aided by Messrs. Jones and Fenton, observed during 3h. 22m. on the night of Aug. 10, 1839. The sky was at times partially overcast. “The average number of meteors observed in the half hemisphere to which we attended, was 44. Three or four were very splendid, but none equal to the finest seen Aug. 10, 1838, at Geneva. The general result however fully establishes the fact that the nights of the 10th or 11th of August, furnish a most remarkable exhibition of these interesting celestial travellers.” *Extract from a paper by Mr. Cooper, in Lond. and Ed. Phil. Mag., Nov. 1839, p. 372.*

4. *Breslau. N. lat. 51° 6½' ; E. lon. 17° 2'.* The St. James's Chronicle, of London, Sept. 5, 1839, contains a translation of an account published by Von Boguslawski in the Prussian State Gazette, of meteoric observations, at the August epoch, made under his superintendence. The following is an abstract of the account. “For several days previous to August 10, 1839, the sky was overcast. The night of the 10th was clear, and at dusk, it was evident that an unusual fall of meteors had begun. Arrangements were made for observing the numbers, times, durations, magnitudes, courses, &c. of the meteors. These however were not completed until 9h. 26m. P. M., when all the observers, fifteen in number, were assembled. Eleven (?) were stationed at the six windows of the Observatory, and four at the clocks. In the course of 5h. 48m. ending at 3h. 14m. (A. M. of the 11th, when daylight interfered,) they noticed *one thousand and eight shoot-*

*ing stars*,—not including numbers which must have been overlooked, because the observers were not sufficiently numerous. Sometimes the stars succeeded each other so rapidly that nothing but the *time* could be noted. The courses therefore of only 977 were marked upon the star-maps, with all their circumstances. The following result is as near the truth as possible. Five meteors appeared as bright as Venus; 14 as Jupiter; 238 as stars of the first magnitude; 354 of the second, and 257 of the third magnitude: 101 were reckoned smaller still, and the magnitudes of eight were lost in the hurry. Two hundred and seventy three left luminous trains. \* \* Three observers watched on the night of the 11th, and saw 323 shooting stars, while the sky was partly covered. On the night of the 12th, one observer counted 103 meteors, between 10 P. M. and 1h. 45m. A. M. of the 13th. “Therefore, the annual periodical return of an uncommon fall of stars towards the 10th of August, is once more confirmed, as well as that the passage of this host of meteors near the earth, lasts several days.”

It thus appears that on the night of August 10th, 1839, meteors were seen as abundantly at Breslau as at New Haven. (This Jour. Vol. xxxvii, p. 325.) The place of apparent radiation will doubtless be well determined from the ample materials obtained by the Prussian observers.

No returns from the southern hemisphere have yet been received.

E. C. HERRICK.

5. *British Antarctic Expedition*.—The British Antarctic Exploring Expedition, under command of Capt. J. C. Ross, sailed from England in September, 1839. It consists of the *Terror*, of 340 tons, and the *Erebus*, of 370 tons, six guns each. They were built expressly for this purpose, and are finished and furnished in the most complete style at the expense of the Admiralty, under the superintendence of a committee of the Royal Society. The ships are in three compartments below, for greater safety. They are supplied with eight boats, two sets of all needed instruments, double decks, spare rudders, &c., together with abundance of pemmican, and fresh provisions for three years. The expedition is to establish magnetic observatories at St. Helena, the Cape of Good Hope, and Van Dieman's Land; thence to make for the Antarctic pole as far as possible. The highest latitude yet reached is 73° S., by Capt. Weddell in 1823.

6. *Compound Electro-Magnet*.—Messrs. EDITORS,—As the subject of electro-magnetism is now occupying much of the attention of the scientific world, and many experiments made to procure a motive

power, I would suggest what may be called a compound electro-magnet. I propose to have a series of circles, encircling each other to any definite extent required. I would after having formed a primary electro-magnet have it insulated on the outer surface; then place either a cylinder of iron or a succession of wires, until they have encircled the primary electro-magnet; then make a helix of copper wire in the usual manner; (I would prefer platinum wire to make the helix;) after having made a number sufficient to try an experiment, unite them by a plate of iron, either entire or in rims corresponding to each magnet. I also suggest the trial of brass cylinders over each successive electro-magnet to cut off the radiations of electricity; this will have either the effect to increase or decrease the magnetic power; experiments thereon must determine. Not having leisure to pursue the subject myself, I offer these suggestions for the public good through the medium of your highly valuable Journal.

Yours respectfully,

JONAS HUMBERT, Jr., Medical Electrician,  
327 Broome St., New York City.

#### 7. *Exchanges of American Shells and Insects.*

TO THE EDITORS—*Gent.* :—I have for several years spent much of my leisure time in collecting the fresh-water and land shells of this state, and have on hand a large number of species of *Unio*, *Margaritana*, (*Alasmodonta*), *Anodonta*, *Cyclas*, *Ancylas*, *Helix*, *Polygyra*, *Helecina*, *Pupa*, *Succinea*, *Cyclostoma*, *Planorbis*, *Physa*, *Lymneus*, *Melania*, *Anculosa*, *Valvata*, and *Paludina*, which I am desirous of exchanging for such native and foreign species as are not in my collection. My shells are generally very perfect; the *Naiades*, which are mostly from the Scioto River and its tributaries, are remarkably so. I am particularly desirous of exchanging for native shells in the above genera, especially for native and foreign *Naiades*.

I am also collecting the Insects of this state, and would be pleased to exchange them for native and foreign *labelled* species.

I can label my shells with the names by which they are known to our western naturalists.

Either this fall or early in the spring I will do myself the pleasure of sending for your acceptance a suit of western shells.

I am respectfully, your obedient servant,

C. S. WARD.

Roscoe, Ohio, November 14, 1839.

8. *The Railway Magazine and Steam Navigation Journal.* Edited by John Herapath Esq. London. Published by J. Wyld. 8vo. Monthly.—This is a periodical work devoted chiefly to what is now

generally considered a highly important interest of society, viz. the means of a rapid locomotion. It is edited with much industry and ability, and must be of great value to civil engineers, and to all in any way engaged in railroads and steamboats, and it is not destitute of interest to the man of theoretical science. In the miscellaneous department we find an extensive range of scientific notices, and at the conclusion of every number, a table of the current prices of railroad stocks, with the original cost of each. The numbers average 88 pages each, and are sold at 1s. 6d. No. 37, which commenced the 6th volume of the new series, is dated March, 1839.

9. *To remove Carbonic Acid Gas from Wells, &c.*—Prof. HUBBARD, of Dartmouth College, writes: “Saussure, in his experiments upon the property possessed by ignited charcoal of absorbing gases, showed, that of carbonic acid gas, it absorbs 35 times its volume in 24 hours. Several years ago, I availed myself of this property in *purifying a well of carbonic acid gas*, and in my lectures have urged others to do the same, and the result in all cases of its use has been successful.

“As is well known, the extinguishment of a lighted candle in a well, if there be no odor, indicates the presence of carbonic acid gas. In this case, half a peck or more of ignited charcoal in a kettle should be let down by a cord nearly to the surface of the water. The glow is immediately deadened, *combustion ceases*, and the absorption of the gas begins. The lighted candle will show the progress of the experiment; in an hour the coal may be drawn up and reignited and let down again, and this repeated till the whole is removed. A well containing 8 feet in depth of the gas above the water was purified by two processes, and another with 26 feet of gas during an afternoon.

“The certainty of this remedy, and the facility with which it may be applied, give it a superiority over the ordinary modes of purification by explosion of gunpowder, &c.”

10. *The Katakekaumene*.—Dr. Daubeny (Description of Volcanos) has quoted from Strabo a notice of the *Κατακεκαυμενη* near Smyrna. The term (from the Greek) implies—a region completely burnt by fire. Strabo says “it is without trees, with the exception of the vine. The surface of the ground is cindery, and the mountains and rocks are black as if they had been calcined. Some, he adds, have supposed the country to have been affected by fire from heaven, but it is most probable that so large a tract of country should have been burnt by fire from the earth.”

Of this remarkable district Mr. Hamilton has given the following notice.

“*The Katakekaumene*.—The extent of this interesting tract is much less than is assigned to it in published maps, being not more than 7 miles from north to south, and 18 or 19 from east to west. After alluding to his first visit to it in company with Mr. H. E. Strickland, and referring to that gentleman’s account of a portion of the district,\* Mr. Hamilton describes minutely the two systems of volcanos, distinguished by the state of preservation of the craters and of the coulées; he defines also the course of each lava-current, and points out its attendant phenomena—but these details admit of only partial abridgment.

“The volcanic products are basalt, lava, and ashes, the first being confined to the more ancient craters, and the last to the more modern. The numerous older cones are further distinguished by being situated on parallel ridges of gneiss and mica slate, and the newer, only three in number, by being confined to the intervening alluvial valleys. This important distinction Mr. Hamilton explains on the supposition, that the elevation of the schistose ridges produced cracks, through which, as points of least resistance, the first eruptions of lava found vent; and that these openings becoming subsequently plugged up, by the cooling of injected molten matter, the schists were rendered so solid, that when the volcanic forces again became active, the lines of least resistance were transferred to the valleys.

“The coulées from the ancient craters appear to have been partly under water, as their surface is, in some places, covered with sediment and turf; but the lava streams from the modern are bare, rugged, and barren, and the craters are surrounded by mounds of loose scoriæ and ashes. In addition to the comparative view given by Mr. Strickland of the phenomena of the *Katakekaumene* and Central France, Mr. Hamilton enters into a more extended investigation of points of resemblance, including other portions of Asia Minor. The great volcanic groups of Mont Dore, the Cantal, and Mont Mezen, Mr. Hamilton conceives are represented by Ak Dàgh, Morad Dàgh, the trachytic hills east of Takmak, Hassan Dàgh, and Mount Argæus. The modern volcanic period of Central France he compares with the *Katakekaumene*, as respects the composition of the lavas, their arrangement at different levels, and the cones being scattered, not collected in great mountain masses. The *Katakekaumene*, in Mr. Hamilton’s opinion, exhibits also additional evidence, that the disposition of comparatively recent volcanos is coincident with the strike of the granitic axis, from the interior of which the volcanos have burst forth. The author also alluded to other comparative phenomena noticed in Mr. Strickland’s paper. Lastly, he pointed out two distinctions—in

---

\* See L. & E. Phil. Mag. vol. x, p. 70.

Central France streams of igneous products may be traced from the most ancient volcanic masses of Mont Dore, but in Asia Minor none have been detected which could have flowed from Ak Dagh, or Morad Dagh. In France, also, trachytic eruptions occurred during the deposition of the lacustrine limestone; but in the Katakekaumene, they appear to have preceded that of the white limestone, or are associated with only its lowest beds.

“In conclusion, the paper gives a general summary of the geological phenomena of the country south of the Demirji range.

“The relative antiquity of the vast lake or sea in which the strata were deposited, cannot be determined, as the micaceous sandstone forming the lowest series of beds is apparently destitute of organic remains, and Mr. Hamilton, therefore, does not attempt to compare that deposit with any European formation. The sandstone, he conceives, was accumulated upon an irregular surface of schistose rocks and crystalline limestone, and before the elevation of the Demirji chain. Upon the sandstone were deposited in the north of the district the beds of peperite, derived probably from subaqueous volcanos; and upon the peperite and the micaceous sandstone, the white limestone, which is the highest sedimentary rock. The drainage of the lake, he is opinion, took place during the earliest volcanic eruptions of the Katakekaumene.

“Three well-defined periods of igneous operations may be traced. The first is marked by the masses of basalt which cap some of the plateaux of white limestone, and were ejected previously to the country assuming its present configuration, and to the formation of the valleys. Mr. Hamilton considers that the basalt flowed under water, and probably but a short time before the drainage of the lake.

“The second period is characterized by the currents of basalt and lava from the ancient system of volcanos in the Katakekaumene, and was subsequent to the formation of the present valleys, as many of the lava streams may be traced into them. The coulées which flowed towards the Hermus from the crater or Karadevit near Koola, present an inclined plane, the surface of which is not more than 150 or 200 feet above the present bed of the river; but they must, at one period, have been under water, as the lava is covered with a sediment which filled its crevices and smooths its asperities.

“The third period would be to the more modern system of cones, the lava of which is as rugged and barren as the recent coulées of Etna and Vesuvius. Of the date of these eruptions, Mr. Hamilton offers no opinion, merely remarking that the craters are mentioned by Strabo, and that there is no tradition of their activity.”—*Lon. and Ed. Phil. Mag.*

THE  
AMERICAN  
JOURNAL OF SCIENCE, &c.

---

---

ART. I.—*Contributions to Electricity and Magnetism. On Electro-Dynamic Induction*; by JOSEPH HENRY, PROFESSOR of Natural Philosophy in the College of New Jersey, Princeton. Read November 2, 1838.\*

INTRODUCTION.

1. SINCE my investigations in reference to the influence of a spiral conductor, in increasing the intensity of a galvanic current, were submitted to the Society, the valuable paper of Dr. Faraday, on the same subject, has been published, and also various modifications of the principle have been made by Sturgeon, Masson, Page and others, to increase the effects. The spiral conductor has likewise been applied by Cav. Antonori to produce a spark by the action of a thermo-electrical pile; and Mr. Watkins has succeeded in exhibiting all the phenomena of hydro-electricity by the same means. Although the principle has been much extended by the researches of Dr. Faraday, yet I am happy to state that the results obtained by this distinguished philosopher are not at variance with those given in my paper.

2. I now offer to the Society a new series of investigations in the same line, which I hope may also be considered of sufficient importance to merit a place in the Transactions.

3. The primary object of these investigations was to discover, if possible, inductive actions in common electricity analogous to

---

\* From the Transactions of the American Philosophical Society, Vol. 6. N. S. Vol. XXXVIII, No. 2.—Jan.—March, 1840. 27

those found in galvanism. For this purpose a series of experiments was commenced in the spring of 1836, but I was at that time diverted, in part, from the immediate object of my research, by a new investigation of the phenomenon known in common electricity by the name of the lateral discharge. Circumstances prevented my doing any thing further, in the way of experiment, until April last, when most of the results which I now offer to the Society were obtained. The investigations are not as complete, in several points, as I could wish, but as my duties will not permit me to resume the subject for some months to come, I therefore present them as they are; knowing, from the interest excited by this branch of science in every part of the world, that the errors which may exist will soon be detected, and the truths be further developed.

4. The experiments are given nearly in the order in which they were made; and in general they are accompanied by the reflections which led to the several steps of the investigation. The whole series is divided, for convenience of arrangement, into six sections, although the subject may be considered as consisting, principally, of two parts. The first, relating to a new examination of the induction of galvanic currents; and the second, to the discovery of analogous results in the discharge of ordinary electricity.\*

Fig. 1.

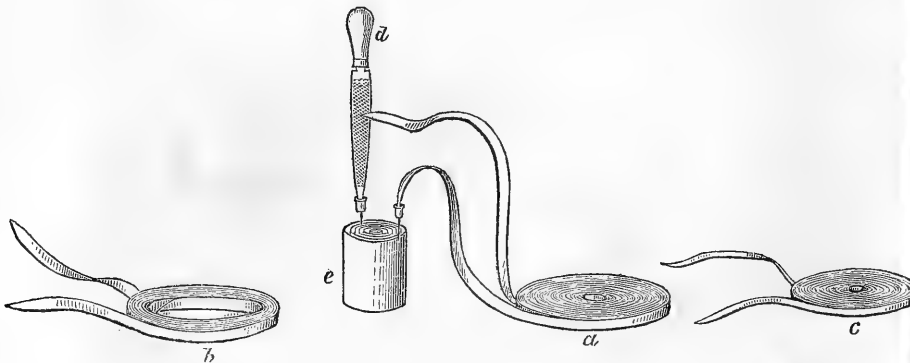

*a* coil No. 1, *b* coil No. 2, and *c* coil No. 3; *e* the battery, *d* the rasp.

5. The principal articles of apparatus used in the experiments, consist of a number of flat coils of copper riband, which will be

\* The several paragraphs are, for convenience of reference, numbered in succession, from the first to the last, after the mode adopted by Dr. Faraday.



designated by the names of coil No. 1, coil No. 2, &c.; also of several coils of long wire; and these, to distinguish them from the ribands, will be called helix No. 1, helix No. 2, &c.

6. Coil No. 1 is formed of thirteen pounds of copper plate, one inch and a half wide and ninety-three feet long. It is well covered with two coatings of silk, and was generally used in the form represented in Fig. 1, which is that of a flat spiral, sixteen inches in diameter. It was however sometimes formed into a ring of larger diameter, as is shown in Fig. 4, Section III.

7. Coil No. 2 is also formed of copper plate, of the same width and thickness as coil No. 1. It is, however, only sixty feet long. Its form is shown at *b*, Fig 1. The opening at the centre is sufficient to admit helix No. 1. Coils No. 3, 4, 5, 6, &c., are all about sixty feet long, and of copper plate of the same thickness, but of half the width of coil No. 1.

Fig. 2.

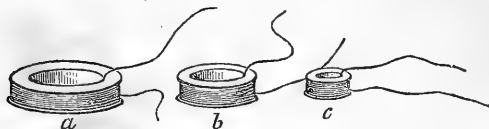

*a* helix No. 1, *b* helix No. 2, *c* helix No. 3.

8. Helix No. 1 consists of sixteen hundred and sixty yards of copper wire,  $\frac{1}{4}$ th of an inch in diameter; No. 2, of nine hundred and ninety yards; and No. 3, of three hundred and fifty yards, of the same wire. These helices are shown in Fig. 2, and are so adjusted in size as to fit into each other; thus forming one long helix of three thousand yards: or, by using them separately, and in different combinations, seven helices of different lengths. The wire is covered with cotton thread, saturated with bees' wax, and between each stratum of spires a coating of silk is interposed.

9. Helix No. 4 is shown at *a*, Fig. 4, Section III; it is formed of five hundred and forty-six yards of wire,  $\frac{1}{4}$ th of an inch in diameter, the several spires of which are insulated by a coating of cement. Helix No. 5 consists of fifteen hundred yards of silvered copper wire,  $\frac{1}{2}$ th of an inch in diameter, covered with cotton, and is of the form of No. 4.

10. Besides these I was favored with the loan of a large spool of copper wire, covered with cotton,  $\frac{1}{8}$ th of an inch in diameter,

and five miles long. It is wound on a small axis of iron, and forms nearly a solid cylinder of wire, eighteen inches long, and thirteen in diameter.

11. For determining the direction of induced currents, a magnetizing spiral was generally used, which consists of about thirty spires of copper wire, in the form of a cylinder, and so small as just to admit a sewing needle into the axis.

12. Also a small horse-shoe is frequently referred to, which is formed of a piece of soft iron, about three inches long, and  $\frac{2}{3}$ ths of an inch thick; each leg is surrounded with about five feet of copper bell wire. This length is so small, that only a current of electricity of considerable quantity can develop the magnetism of the iron. The instrument is used for indicating the existence of such a current.

13. The battery used in most of the experiments is shown in Fig. 1. It is formed of three concentric cylinders of copper, and two interposed cylinders of zinc. It is about eight inches high, five inches in diameter, and exposes about one square foot and three quarters of zinc surface, estimating both sides of the metal. In some of the experiments a larger battery was used, weakly charged, but all the results mentioned in the paper, except those with a Cruickshank trough, can be obtained with one or two batteries of the above size, particularly if excited by a strong solution. The method of interrupting the circuit of the conductor by means of a rasp, *b*, is shown in the same Figure.

#### SECTION I.

##### *Conditions which influence the Induction of a Current on itself.*

14. The phenomenon of the spiral conductor is at present known by the name of the induction of a current on itself, to distinguish it from the induction of the secondary current, discovered by Dr. Faraday. The two, however, belong to the same class, and experiments render it probable that the spark given by the long conductor is, from the natural electricity of the metal, disturbed for an instant by the induction of the primary current. Before proceeding to the other parts of these investigations, it is important to state the results of a number of preliminary experiments, made to determine more definitely the conditions which influence the action of the spiral conductor.

15. When the electricity is of low intensity, as in the case of the thermo-electrical pile, or a large single battery weakly excited with dilute acid, the flat riband coil No. 1, ninety-three feet long, is found to give more brilliant deflagrations, and louder snaps from a surface of mercury, than any other form of conductor. The shocks, with this arrangement, are, however, very feeble, and can be felt only in the fingers or through the tongue.

16. The induced current in a short conductor, which thus produces deflagration, but not shocks, may, for distinction, be called one of quantity.

17. When the length of the coil is increased, the battery continuing the same, the deflagrating power decreases, while the intensity of the shock continually increases. With five riband coils, making an aggregate length of three hundred feet, and the small battery, Fig. 1, the deflagration is less than with coil No. 1, but the shocks are more intense.

18. There is, however, a limit to this increase of intensity of the shock, and this takes place when the increased resistance or diminished conduction of the lengthened coil begins to counteract the influence of the increasing length of the current. The following experiment illustrates this fact. A coil of copper wire  $\frac{1}{16}$ th of an inch in diameter, was increased in length by successive additions of about thirty two feet at a time. After the first two lengths, or sixty four feet, the brilliancy of the spark began to decline, but the shocks constantly increased in intensity, until a length of five hundred and seventy five feet was obtained, when the shocks also began to decline. This was then the proper length to produce the maximum effect with a single battery, and a wire of the above diameter.

19. When the intensity of the electricity of the battery is increased, the action of the short riband coil decreases. With a Cruickshank's trough of sixty plates, four inches square, scarcely any peculiar effect can be observed, when the coil forms a part of the circuit. If however the length of the coil be increased in proportion to the intensity of the current, then the inductive influence becomes apparent. When the current, from ten plates of the above mentioned trough, was passed through the wire of the large spool, (10,) the induced shock was too severe to be taken through the body. Again, when a small trough of twenty five one inch plates, which alone would give but a very feeble shock,

was used with helix No. 1, an intense shock was received from the induction, when the contact was broken. Also a slight shock in this arrangement is given when the contact is formed, but it is very feeble in comparison with the other. The spark, however, with the long wire and compound battery is not as brilliant as with the single battery and the short riband coil.

20. When the shock is produced from a long wire, as in the last experiments, the size of the plates of the battery may be very much reduced, without a corresponding reduction of the intensity of the shock. This is shown in an experiment with the large spool of wire, (10.) A very small compound battery was formed of six pieces of copper bell wire, each about one inch and a half long, and an equal number of pieces of zinc of the same size. When the current from this was passed through the five miles of the wire of the spool, the induced shock was given at once to twenty six persons, joining hands. This astonishing effect places the action of a coil in a striking point of view.

21. With the same spool and the single battery used in the former experiments, no shock, or at most only a very feeble one, could be obtained. A current, however, was found to pass through the whole length, by its action on the galvanometer; but it was not sufficiently powerful to induce a current which could counteract the resistance of so long a wire.

22. The induced current in these experiments may be considered as one of *considerable intensity*, and *small quantity*.

23. The form of the coil has considerable influence on the intensity of the action. In the experiments of Dr. Faraday, a long cylindrical coil of thick copper wire, inclosing a rod of soft iron, was used. This form produces the greatest effect when magnetic reaction is employed; but in the case of simple galvanic induction, I have found the form of the coils and helices represented in the figures most effectual. The several spires are more nearly approximated, and therefore they exert a greater mutual influence. In some cases, as will be seen hereafter, the ring form, shown in Fig. 4, is most effectual.

24. In all cases the several spires of the coil should be well insulated, for although in magnetizing soft iron, and in analogous experiments, the touching of two spires is not attended with any great reduction of action; yet in the case of the induced current, as will be shown in the progress of these investigations, a single

contact of two spires is sometimes sufficient to neutralize the whole effect.

25. It must be recollected that all the experiments with these coils and helices, unless otherwise mentioned, are made without the reaction of iron temporarily magnetized; since the introduction of this would, in some cases, interfere with the action, and render the results more complex.

#### SECTION II.

#### *Conditions which influence the production of Secondary Currents.*

26. The secondary currents, as it is well known, were discovered in the induction of magnetism and electricity, by Dr. Faraday, in 1831. But he was at that time urged to the exploration of new, and apparently richer veins of science, and left this branch to be farther traced by others. Since then, however, attention has been almost exclusively directed to one part of the subject, namely, the induction from magnetism, and the perfection of the magneto-electrical machine. And I know of no attempts, except my own, to review and extend the purely electrical part of Dr. Faraday's admirable discovery.

27. The energetic action of the flat coil, in producing the induction of a current on itself, led me to conclude that it would also be the most proper means for the exhibition and study of the phenomena of the secondary galvanic currents.

Fig. 3.

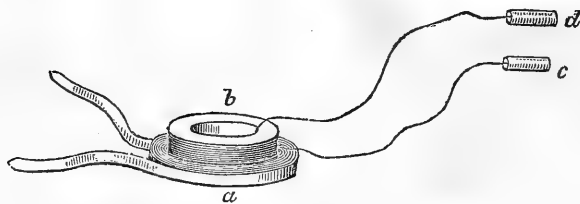

*a* coil No. 1, *b* helix No. 1, and *c*, *d*, handles for receiving the shock. The plate of glass is omitted in the drawing.

28. For this purpose coil No. 1 was arranged to receive the current from the small battery, and coil No. 2 placed on this, with a plate of glass interposed to insure perfect insulation; as often as the circuit of No. 1 was interrupted, a powerful secondary current was induced in No. 2. The arrangement is the same as that ex-

hibited in Fig. 3, with the exception that in this the compound helix is represented as receiving the induction, instead of coil No. 2.

29. When the ends of the second coil were rubbed together, a spark was produced at the opening. When the same ends were joined by the magnetizing spiral (11,) the inclosed needle became strongly magnetic. Also when the secondary current was passed through the wires of the iron horse-shoe, (12,) magnetism was developed; and when the ends of the second coil were attached to a small decomposing apparatus, of the kind which accompanies the magneto-electrical machine, a stream of gas was given off at each pole. The shock, however, from this coil is very feeble, and can scarcely be felt above the fingers.

30. This current has therefore the properties of one of moderate intensity, but considerable quantity.

31. Coil No. 1 remaining as before, a longer coil, formed by uniting Nos. 3, 4 and 5, was substituted for No. 2. With this arrangement, the spark produced when the ends were rubbed together, was not as brilliant as before; the magnetizing power was much less; decomposition was nearly the same, but the shocks were more powerful, or, in other words, the intensity of the induced current was increased by an increase of the length of the coil, while the quantity was apparently diminished.

32. A compound helix, formed by uniting Nos. 1 and 2, and therefore containing two thousand six hundred and fifty yards of wire, was next placed on coil No. 1. The weight of this helix happened to be precisely the same as that of coil No. 2, and hence the different effects of the same quantity of metal in the two forms of a long and short conductor, could be compared. With this arrangement, the magnetizing effects, with the apparatus before mentioned, disappeared. The sparks were much smaller, and also the decomposition less, than with the short coil; but the shock was almost too intense to be received with impunity, except through the fingers of one hand. A circuit of fifty six of the students of the senior class, received it at once from a single rupture of the battery current, as if from the discharge of a Leyden jar weakly charged. The secondary current in this case was one of small quantity, but of great intensity.

33. The following experiment is important in establishing the fact of a limit to the increase of the intensity of the shock, as

well as the power of decomposition, with a wire of a given diameter. Helix No. 5, which consists of wire only  $\frac{1}{1\frac{1}{2}}$ th of an inch in diameter, was placed on coil No. 2, and its length increased to about seven hundred yards. With this extent of wire, neither decomposition nor magnetism could be obtained, but shocks were given of a peculiarly pungent nature; they did not, however, produce much muscular action. The wire of the helix was further increased to about fifteen hundred yards; the shock was now found to be scarcely perceptible in the fingers.

34. As a counterpart to the last experiment, coil No. 1 was formed into a ring of sufficient internal diameter to admit the great spool of wire, (10,) and with the whole length of this (which, as has before been stated, is five miles) the shock was found so intense as to be felt at the shoulder, when passed only through the forefinger and thumb. Sparks and decomposition were also produced, and needles rendered magnetic. The wire of this spool is  $\frac{1}{8}$ th of an inch thick, and we therefore see from this experiment, that by increasing the diameter of the wire, its length may also be much increased, with an increased effect.

35. The fact (33) that the induced current is diminished by a further increase of the wire, after a certain length has been attained, is important in the construction of the magneto-electrical machine, since the same effect is produced in the induction of magnetism. Dr. Goddard of Philadelphia, to whom I am indebted for coil No. 5, found that when its whole length was wound on the iron of a temporary magnet, no shocks could be obtained. The wire of the machine may therefore be of such a length, relative to its diameter, as to produce shocks, but no decomposition; and if the length be still further increased, the power of giving shocks may also become neutralized.

36. The inductive action of coil No. 1, in the foregoing experiments, is precisely the same as that of a temporary magnet in the case of the magneto-electrical machine. A short thick wire around the armature gives brilliant deflagrations, but a long one produces shocks. This fact, I believe, was first discovered by my friend Mr. Saxton, and afterwards investigated by Sturgeon and Lentz.

37. We might, at first sight, conclude, from the perfect similarity of these effects, that the currents which, according to the theory of Ampere, exist in the magnet, are like those in the short

coil, of great quantity and feeble intensity; but succeeding experiments will show that this is not necessarily the case.

38. All the experiments given in this section have thus far been made with a battery of a single element. This condition was now changed, and a Cruickshank trough of sixty pairs substituted. When the current from this was passed through the riband coil No. 1, no indication, or a very feeble one, was given of a secondary current in any of the coils or helices, arranged as in the preceding experiments. The length of the coil, in this case, was not commensurate with the intensity of the current from the battery. But when the long helix, No. 1, was placed instead of coil No. 1, a powerful inductive action was produced on each of the articles, as before.

39. First, helices No. 2 and 3 were united into one, and placed within helix No. 1, which still conducted the battery current. With this disposition a secondary current was produced, which gave intense shocks but feeble decomposition, and no magnetism in the soft iron horse-shoe. It was therefore one of intensity, and was induced by a battery current also of intensity.

40. Instead of the helix used in the last experiment for receiving the induction, one of the coils (No. 3) was now placed on helix No. 1, the battery remaining as before. With this arrangement the induced current gave no shocks, but it magnetized the small horse-shoe; and when the ends of the coil were rubbed together, produced bright sparks. It had therefore the properties of a current of quantity; and it was produced by the induction of a current, from the battery, of intensity.

41. This experiment was considered of so much importance, that it was varied and repeated many times, but always with the same result; it therefore establishes the fact *that an intensity current can induce one of quantity*, and, by the preceding experiments, the converse has also been shown, *that a quantity current can induce one of intensity*.

42. This fact appears to have an important bearing on the law of the inductive action, and would seem to favor the supposition that the lower coil, in the two experiments with the long and short secondary conductors, exerted the same amount of inductive force, and that in one case this was expended (to use the language of theory) in giving a great velocity to a small quantity of the fluid, and in the other in producing a slower motion in a larger



current ; but in the two cases, were it not for the increased resistance to conduction in the longer wire, the quantity multiplied by the velocity would be the same. This, however, is as yet a hypothesis, but it enables us to conceive how intensity and quantity may both be produced from the same induction.

43. From some of the foregoing experiments we may conclude, that the quantity of electricity in motion in the helix is really less than in the coil, of the same weight of metal ; but this may possibly be owing simply to the greater resistance offered by the longer wire. It would also appear, if the above reasoning be correct, that to produce the most energetic physiological effects, only a small quantity of electricity, moving with great velocity, is necessary.

44. In this and the preceding section, I have attempted to give only the general conditions which influence the galvanic induction. To establish the law, would require a great number of more refined experiments, and the consideration of several circumstances which would affect the results, such as the conduction of the wires, the constant state of the battery, the method of breaking the circuit with perfect regularity, and also more perfect means than we now possess of measuring the amount of the inductive action. All these circumstances render the problem very complex.

### SECTION III.

#### *On the Induction of Secondary Currents at a distance.*

45. In the experiments given in the two preceding sections, the conductor which received the induction, was separated from that which transmitted the primary current by the thickness only of a pane of glass ; but the action from this arrangement was so energetic, that I was naturally led to try the effect at a greater distance.

46. For this purpose coil No. 1 was formed into a ring of about two feet in diameter, and helix No. 4 placed as is shown in the figure. When the helix was at the distance of about sixteen inches from the middle of the plane of the ring, shocks could be perceived through the tongue, and these rapidly increased in intensity as the helix was lowered, and when it reached the plane of the ring they were quite severe. The effect, however, was still greater when the helix was moved from the centre to the

inner circumference, as at *c*: but when it was placed without the ring, in contact with the outer circumference, at *b*, the shocks were very slight; and when placed within, but its axis at right angles to that of the ring, not the least effect could be observed.

Fig. 4.

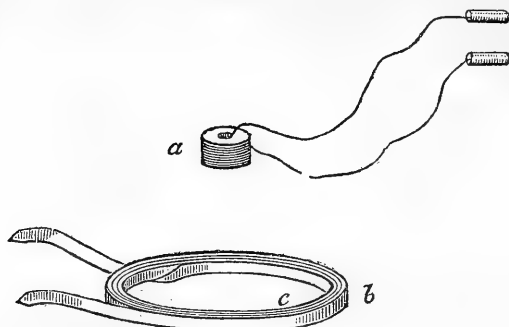

*a* helix No. 4, *b* coil No. 1, in the form of a ring.

47. With a little reflection, it will be evident that this arrangement is not the most favorable for exhibiting the induction at a distance, since the side of the ring, for example, at *c*, tends to produce a current revolving in one direction in the near side of the helix, and another in an opposite direction in the farther side. The resulting effect is therefore only the difference of the two; and in the position as shown in the figure, this difference must be very small, since the opposite sides of the helix are approximately at the same distance from *c*. But the difference of action on the two sides constantly increases as the helix is brought near the side of the ring, and becomes a maximum when the two are in the position of internal contact. A helix of larger diameter would, therefore, produce a greater effect.

48. Coil No. 1 remaining as before, helix No. 1, which is nine inches in diameter, was substituted for the small helix of the last experiment, and with this the effect at a distance was much increased. When coil No. 2 was added to coil No. 1, and the currents from two small batteries sent through these, shocks were distinctly perceptible through the tongue, when the distance of the planes of the coils and the three helices, united as one, was increased to thirty six inches.

49. The action at a distance was still further increased by coiling the long wire of the large spool into the form of a ring of

four feet in diameter, and placing parallel to this another ring, formed of the four ribands of coils No. 1, 2, 3 and 4. When a current from a single battery of thirty five feet of zinc surface was passed through the riband conductor, shocks through the tongue were felt when the rings were separated to the distance of four feet.\* As the conductors were approximated, the shocks became more and more severe; and when at the distance of twelve inches, they could not be taken through the body.

50. It may be stated in this connection, that the galvanic induction of magnetism in soft iron, in reference to distance, is also surprisingly great. A cylinder of soft iron, two inches in diameter and one foot long, placed in the centre of the ring of copper riband, with the battery above mentioned, becomes strongly magnetic.

51. I may perhaps be excused for mentioning in this communication, that the induction at a distance affords the means of exhibiting some of the most astonishing experiments, in the line of *physique amusante*, to be found perhaps in the whole course of science. I will mention one which is somewhat connected with the experiments to be described in the next section, and which exhibits the action in a striking manner. This consists in causing the induction to take place through the partition wall of two rooms. For this purpose coil No. 1 is suspended against the wall in one room, while a person in the adjoining one receives the shock, by grasping the handles of a helix, and approaching it to the spot opposite to which the coil is suspended. The effect is as if by magic, without a visible cause. It is best produced through a door, or thin wooden partition.

52. The action at a distance affords a simple method of graduating the intensity of the shock in the case of its application to medical purposes. The helix may be suspended by a string passing over a pulley, and then gradually lowered down towards the plane of the coil, until the shocks are of the required intensity. At the request of a medical friend, I have lately administered the induced current precisely in this way, in a case of paralysis of a part of the nerves of the face.

---

\* Since writing the above, this distance has been much increased by using a compound battery of eight elements, each of the above size; with this, shocks through the tongue have been obtained, when the conductors were separated to the remarkable distance of six feet eight inches.

53. I may also mention that the energetic action of the spiral conductors enables us to imitate, in a very striking manner, the inductive operation of the magneto-electrical machine, by means of an uninterrupted galvanic current. For this purpose, it is only necessary to arrange two coils to represent the two poles of a horse-shoe magnet, and to cause two helices to revolve past them in a parallel plane. While a constant current is passing through each coil, in opposite directions, the effect of the rotation of the helices is precisely the same as that of the revolving armature in the machine.

54. A remarkable fact should here be noted in reference to helix No. 4, which is connected with a subsequent part of the investigation. This helix is formed of copper wire, the spires of which are insulated by a coating of cement instead of thread, as in the case of the others. After being used in the above experiments, a small discharge from a Leyden jar was passed through it, and on applying it again to the coil, I was much surprised to find that scarcely any signs of a secondary current could be obtained.

55. The discharge had destroyed the insulation in some part, but this was not sufficient to prevent the magnetizing of a bar of iron introduced into the opening at the centre. The effect appeared to be confined to the inductive action. The same accident had before happened to another coil of nearly the same kind. It was therefore noted as one of some importance. An explanation was afterwards found in a peculiar accident of the secondary current.\*

#### SECTION IV.

##### *On the Effects produced by interposing different Substances between the Conductors.*

56. Sir H. Davy found, in magnetizing needles by an electrical discharge, that the effect took place through interposed plates of all substances, conductors and non-conductors.† The experiment which I have given in paragraph 51 would appear to indicate that the inductive action which produces the secondary current might also follow the same law.

---

\* See paragraph 75.

† Philosophical Transactions, 1821.

57. To test this, the compound helix was placed about five inches above coil No. 1, Fig. 5, and a plate of sheet iron, about  $\frac{1}{16}$ th of an inch thick, interposed. With this arrangement no shocks could be obtained; although, when the plate was withdrawn, they were very intense.

Fig. 5.

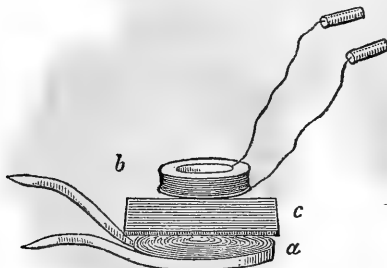

*a* coil No. 1, *b* helix No. 1, and *c* an interposed plate of metal.

58. It was at first thought that this effect might be peculiar to the iron, on account of its temporary magnetism; but this idea was shown to be erroneous by substituting a plate of zinc of about the same size and thickness. With this the screening influence was exhibited as before.

59. After this various other substances were interposed in succession, namely, copper, lead, mercury, acid, water, wood, glass, &c.; and it was found that all the perfect conductors, such as the metals, produced the screening influence; but non-conductors, as glass, wood, &c., appeared to have no effect whatever.

60. When the helix was separated from the coil by a distance only equal to the thickness of the plate, a slight sensation could be perceived even when the zinc of  $\frac{1}{16}$ th of an inch in thickness was interposed. This effect was increased by increasing the quantity of the battery current. If the thickness of the plate was diminished, the induction through it became more intense. Thus a sheet of tinfoil interposed produced no perceptible influence; also four sheets of the same were attended with the same result. A certain thickness of metal is therefore required to produce the screening effect, and this thickness depends on the quantity of the current from the battery.

61. The idea occurred to me that the screening might, in some way, be connected with an instantaneous current in the plate, similar to that in the induction by magnetic rotation, discovered

by M. Arago. The ingenious variation of this principle by Messrs. Babbage and Herschel, furnished me with a simple method of determining this point.

62. A circular plate of lead was interposed, which caused the induction in the helix almost entirely to disappear. A slip of the metal was then cut out in the direction of a radius of the circle, as is shown in Fig. 6. With the plate in this condition, no screening was produced; the shocks were as intense as if the metal were not present.

63. This experiment however is not entirely satisfactory, since the action might have taken place through the opening of the lead; to obviate this objection, another plate was cut in the same manner, and the two interposed with a glass plate between them, and so arranged that the opening in the one might be covered by the continuous part of the other. Still shocks were obtained with undiminished intensity.

Fig. 6.

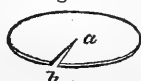

*a* a lead plate, of which the sector *b* is cut out.

Fig. 7.



*a* a lead plate, *b* the magnetizing spiral.

64. But the existence of a current in the interposed conductor was rendered certain by attaching the magnetizing spiral by means of two wires to the edge of the opening in the circular plate, as is shown in Fig. 7. By this arrangement the latent current was drawn out, and its direction obtained by the polarity of a needle placed in the spiral at *b*.

65. This current was a secondary one, and its direction, in conformity with the discovery of Dr. Faraday, was found to be the same as that of the primary current.

66. That the screening influence is in some way produced by the neutralizing action of the current thus obtained, will be clear, from the following experiment. The plate of zinc before mentioned, which is nearly twice the diameter of the helix, instead of being placed between the conductors, was put on the top of the helix, and in this position, although the neutralization was not as perfect as before, yet a great reduction was observed in the intensity of the shock.

67. But here a very interesting and puzzling question occurs. How does it happen that two currents, both in the same direc-

tion, can neutralize each other? I was at first disposed to consider the phenomenon as a case of real electrical interference, in which the impulses succeed each other by some regular interval. But if this were true, the effect should depend on the length and other conditions of the current in the interposed conductor. In order to investigate this, several modifications of the experiments were instituted.

68. First a flat coil (No. 3) was interposed instead of the plates. When the two ends of this were separated, the shocks were received as if the coil were not present; but when the ends were joined, so as to form a perfect metallic circuit, no shocks could be obtained. The neutralization with the coil in this experiment was even more perfect than with the plate.

69. Again, coil No. 2, in the form of a ring, was placed not between the conductors, but around the helix. With this disposition of the apparatus, and the ends of the coil joined, the shocks were scarcely perceptible, but when the ends were separated, the presence of the coil has no effect.

70. Also when helices No. 1 and 2 were together submitted to the influence of coil No. 1, the ends of the one being joined, the other gave no shock.

71. The experiments were further varied by placing helix No. 2 within a hollow cylinder of sheet brass, and this again within coil No. 2, in a manner similar to that shown in Fig. 12, which is intended to illustrate another experiment. In this arrangement the neutralizing action was exhibited, as in the case of the plate.

72. A hollow cylinder of iron was next substituted for the one of brass, and with this also no shocks could be obtained.

73. From these experiments it is evident that the neutralization takes place with currents in the interposed or adjoining conductors of all lengths and intensities, and therefore cannot, as it appears to me, be referred to the interference of two systems of vibrations.

74. This part of the investigation was, for a time, given up almost in despair, and it was not until new light had been obtained from another part of the inquiry, that any further advances could be made towards a solution of the mystery.

75. Before proceeding to the next Section, I may here state, that the phenomenon mentioned, paragraph 54, in reference to helix No. 4, is connected with the neutralizing action. The

electrical discharge having destroyed the insulation at some point, a part of the spires would thus form a shut circuit, and the induction in this would counteract the action in the other part of the helix ; or, in other words, the helix was in the same condition as the two helices mentioned in paragraph 70, when the ends of the wire of one were joined.

76. Also the same principle appears to have an important bearing on the improvement of the magneto-electrical machine : since the plates of metal which sometimes form the ends of the spool containing the wire, must necessarily diminish the action, and also from the experiment of paragraph 72, the armature itself may circulate a closed current which will interfere with the intensity of the induction in the surrounding wire. I am inclined to believe that the increased effect observed by Sturgeon and Calland, when a bundle of wire is substituted for a solid piece of iron, is at least in part due to the interruption of these currents. I hope to resume this part of the subject, in connection with several other points, in another communication to the Society.

77. The results given in this Section may, at first sight, be thought at variance with the statements of Sir H. Davy, that needles could be magnetized by an electrical discharge with conductors interposed. But from his method of performing the experiment, it is evident that the plate of metal was placed between a straight conductor and the needle. The arrangement was therefore similar to the interrupted circuit in the experiment with the cut plate (62,) which produces no screening effect. Had the plate been curved into the form of a hollow cylinder, with the two ends of the metal in contact, and the needle placed within this, the effect would have been otherwise.

#### SECTION V.

#### *On the Production and Properties of induced Currents of the Third, Fourth and Fifth order.*

78. The fact of the perfect neutralization of the primary current by a secondary, in the interposed conductor, led me to conclude that if the latter could be drawn out, or separated from the influence of the former, it would itself be capable of producing a new induced current in a third conductor.

79. The arrangement exhibited in Fig. 8 furnishes a ready means of testing this. The primary current, as usual, is passed through



coil No. 1, while coil No 2 is placed over this to receive the induction, with its ends joined to those of coil No. 3. By this disposition the secondary current passes through No. 3; and since

Fig. 8.

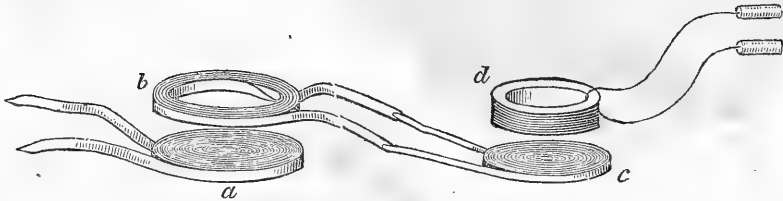

*a* coil No. 1, *b* coil No. 2, *c* coil No. 3, *d* helix No. 1.

this is at a distance, and without the influence of the primary, its separate induction will be rendered manifest by the effects on helix No. 1. When the handles *a*, *b* are grasped, a powerful shock is received, proving the induction of a tertiary current.

80. By a similar but more extended arrangement, as shown in Fig. 9, shocks were received from currents of a fourth and fifth order; and with a more powerful primary current, and additional coils, a still greater number of successive inductions might be obtained.

81. The induction of currents of different orders, of sufficient intensity to give shocks, could scarcely have been anticipated from our previous knowledge of the subject. The secondary current consists, as it were, of a single wave of the natural electricity of the wire, disturbed but for an instant by the induction of the primary; yet this has the power of inducing another current, but little inferior in energy to itself, and thus produces effects apparently much greater in proportion to the quantity of electricity in motion than the primary current.

82. Some difference may be conceived to exist in the action of the induced currents, and that from the battery, since they are apparently different in nature; the one consisting, as we may suppose, of a single impulse, and the other of a succession of such impulses, or a continuous action. It was therefore important to investigate the properties of the currents of different orders, and to compare the results with those before obtained.

83. First, in reference to the intensity, it was found that with the small battery a shock could be given from the current of the

third order to twenty-five persons, joining hands; also shocks perceptible in the arms were obtained from a current of the fifth order.

84. The action at a distance was also much greater than could have been anticipated. In one experiment shocks from the tertiary current were distinctly felt through the tongue, when helix No. 1, Fig. 8, was at the distance of eighteen inches above the coil transmitting the secondary current.

85. The same screening effects were produced by the interposition of plates of metal between the conductors of the different orders, as those which have been described in reference to the primary and secondary currents.

86. Also when the long helix is placed over a secondary current generated in a short coil, and which is therefore, as we have before shown, one of quantity, a tertiary current of intensity is produced.

87. Again, when the intensity current of the last experiment is passed through a second helix, and another coil is placed over this, a quantity current is again produced. Therefore, in the case of these currents, as in that of the primary, a *quantity current can be induced from one of intensity, and the converse*. By the arrangement of the apparatus as shown in Fig. 9, these different results are exhibited at once. The induction from coil No. 3 to helix No. 1 produces an intensity current, and from helix No. 2 to coil No. 4, a quantity current.

88. If the ends of coil No. 2, as in the arrangement of Fig. 8, be united to helix No. 1 instead of coil No. 3, no shocks can be obtained; the quantity current of coil No. 2, appears not to be of sufficient intensity to pass through the wire of the long helix.

89. Also, no shocks can be obtained from the handles attached to helix No. 2, in the

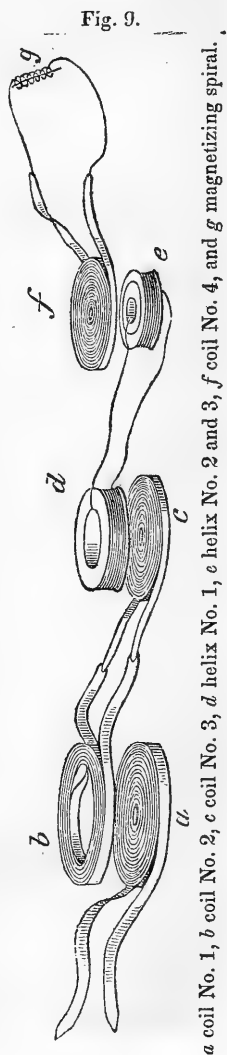

arrangement exhibited in Fig. 10. In this case the quantity of electricity in the current from the helix appears to be too small to produce any effect, unless its power is multiplied by passing it through a conductor of many spires.

Fig. 10.

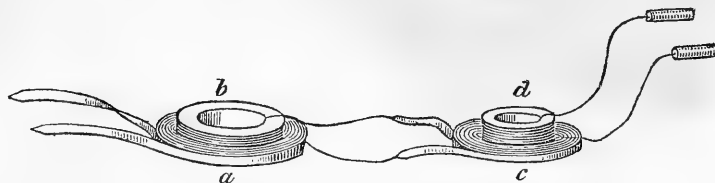

*a* coil No. 2, *b* helix No. 1, *c* coil No. 3, and *d* helix No. 2.

90. The next inquiry was in reference to the direction of these currents, and this appeared important in connection with the nature of the action. The experiments of Dr. Faraday would render it probable, that at the beginning and ending of the secondary current, its induction on an adjacent wire is in contrary directions, as is shown to be the case in the primary current. But the whole action of a secondary current is so instantaneous, that the inductive effects at the beginning and ending cannot be distinguished from each other, and we can only observe a single impulse, which, however, may be considered as the difference of two impulses in opposite directions.

91. The first experiment happened to be made with a current of the fourth order. The magnetizing spiral (11) was attached to the ends of coil No. 4, Fig. 9, and by the polarity of the needle it was found that this current was in the same direction with the secondary and primary currents.\* By a too hasty generalization, I was led to conclude, from this experiment, that the currents of all orders are in the same direction as that of the battery current, and I was the more confirmed in this from the results of my first experiments on the currents of ordinary electricity. This conclusion, however, caused me much useless labor and perplexity, and was afterwards proved to be erroneous.

92. By a careful repetition of the last experiment, in reference to each current, the important fact was discovered, that *there ex-*

---

\* It should be recollected that all the inductions which have been mentioned, were produced at the moment of breaking the circuit of the battery current. The induction at the formation of the current is too feeble to produce the effects described.

ists an alternation in the direction of the currents of the several orders, commencing with the secondary. This result was so extraordinary, that it was thought necessary to establish it by a variety of experiments. For this purpose, the direction was determined by decomposition, and also by the galvanometer, but the result was still the same; and at this stage of the inquiry I was compelled to adopt the conclusion that the directions of the several currents were as follows:

Primary current,	.	.	.	.	.	+
Secondary current,	.	.	.	.	.	+
Current of the third order,	.	.	.	.	.	-
Current of the fourth order,	.	.	.	.	.	+
Current of the fifth order,	.	.	.	.	.	-

93. In the first glance at the above table, we are struck with the fact that the law of alternation is complete, except between the primary and secondary currents, and it appeared that this exception might possibly be connected with the induced current which takes place in the first coil itself, and which gives rise to the phenomena of the spiral conductor. If this should be found to be *minus*, we might consider it as existing between the primary and secondary, and the anomaly would thus disappear. Arrangements were therefore made to satisfy myself fully on this point. For this purpose, the decomposition of dilute acid and the use of the galvanometer were resorted to, by placing the apparatus between the ends of a cross wire attached to the extremities of the coil, as in the arrangement described by Dr. Faraday; (ninth series;) but all the results persisted in giving a direction to this current the same as stated by Dr. Faraday, namely, that of the primary current. I was therefore obliged to abandon the supposition, that the anomaly in the change of the current is connected with the induction of the battery current on itself.

94. Whatever may be the nature or causes of these changes in the direction, they offer a ready explanation of the neutralizing action of the plate interposed between two conductors, since a secondary current is induced in the plate; and although the direction of this, as has been shown, is the same as that of the current from the battery, yet it tends to induce a current in the adjacent conducting matter of a contrary direction.\* The same ex-

---

\* See paragraph 130, Fig. 15:

planation is also applicable to all the other cases of neutralization, even to those which take place between the conductors of the several orders of currents.

95. The same principle explains some effects noted in reference to the induction of a current on itself. If a flat coil be connected with the battery, of course sparks will be produced by the induction, at each rupture of the circuit. But if in this condition another flat coil, with its ends joined, be placed on the first coil, the intensity of the shock is much diminished, and when the several spires of the two coils are mutually interposed by winding the two ribands together into one coil, the sparks entirely disappear in the coil transmitting the battery current, when the ends of the other are joined. To understand this, it is only necessary to mention that the induced current in the first coil is a true secondary current, and it is therefore neutralized by the action of the secondary in the adjoining conductor; since this tends to produce a current in the opposite direction.

96. It would also appear from the perfect neutralization which ensues in the arrangement of the last paragraph, that the induced current in the adjoining conductor is more powerful than that of the first conductor; and we can easily see how this may be. The two ends of the second coil are joined, and it thus forms a perfect metallic circuit; while the circuit of the other coil may be considered as partially interrupted, since to render the spark visible the electricity must be projected, as it were, through a small distance of air.

97. We would also infer that two contiguous secondary currents, produced by the same induction, would partially counteract each other. Moving in the same direction, they would each tend to induce a current in the other of an opposite direction. This is illustrated by the following experiment: helices No. 1 and 2 were placed together, but not united, above coil No. 1, so that they each might receive the induction; the larger was then gradually removed to a greater distance from the coil, until the intensity of the shock from each was about the same. When the ends of the two were united, so that the shock would pass through the body from the two together, the effect was apparently less than with one helix alone. The result, however, was not as satisfactory as in the case of the other experiments; a slight difference in the intensity of two shocks could not be appreciated with perfect certainty.

## SECTION VI.

*The production of Induced Currents of the Different Orders from Ordinary Electricity.*

98. Dr. Faraday, in the ninth series of his researches, remarks, that "the effect produced at the commencement and the end of a current (which are separated by an interval of time when that current is supplied from a voltaic apparatus) must occur at the same moment when a common electrical discharge is passed through a long wire. Whether if it happen accurately at the same moment, they would entirely neutralize each other, or whether they would not still give some definite peculiarity to the discharge, is a matter remaining to be examined."

99. The discovery of the fact that the secondary current, which exists but for a moment, could induce another current of considerable energy, gave some indication that similar effects might be produced by a discharge of ordinary electricity, provided a sufficiently perfect insulation could be obtained.

Fig. 11.

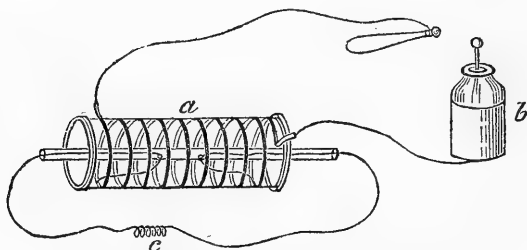

*a* glass cylinder, *b* Leyden jar, *c* magnetizing spiral.

100. To test this, a hollow glass cylinder, Fig. 11, of about six inches in diameter, was prepared with a narrow riband of tin-foil, about thirty feet long, pasted spirally around the outside, and a similar riband of the same length, pasted on the inside; so that the corresponding spires of the two were directly opposite each other. The ends of the inner spiral passed out of the cylinder through a glass tube, to prevent all direct communication between the two. When the ends of the inner riband were joined by the magnetizing spiral (11,) containing a needle, and a discharge from a half gallon jar sent through the outer riband, the needle was

strongly magnetized in such a manner as to indicate *an induced current through the inner riband in the same direction as that of the current of the jar*. This experiment was repeated many times, and always with the same result.

101. When the ends of one of the ribands were placed very nearly in contact, a small spark was perceived at the opening, the moment the discharge took place through the other riband.

102. When the ends of the same riband were separated to a considerable distance, a larger spark than the last could be drawn from each end by presenting a ball, or the knuckle.

103. Also if the ends of the outer riband were united, so as to form a perfect metallic circuit, a spark could be drawn from any point of the same, when a discharge was sent through the inner riband.

104. The sparks in the two last experiments are evidently due to the action known in ordinary electricity by the name of the lateral discharge. To render this clear, it is perhaps necessary to recall the well known fact, that when the knob of a jar is electrified positively, and the outer coating in connection with the earth, then the jar contains a small excess of positive electricity beyond what is necessary to neutralize perfectly the negative surface. If the knob be put in communication with the earth, the extra quantity, or the free electricity, as it is sometimes called, will be on the negative side. When the discharge took place in the above experiments, the inner riband became for an instant charged with this free electricity, and consequently threw off from the outer riband, by ordinary induction, the sparks described. It therefore became a question of importance to determine, whether the induced current described in paragraph 100 was not also a result of the lateral discharge, instead of being a true case of a secondary current analogous to those produced from galvanism. For this purpose the jar was charged, first with the outer coating in connection with the earth, and again with the knob in connection with the same, so that the extra quantity might be in the one case *plus* and in the other *minus*; but the direction of the induced current was not affected by these changes; it was always the same, namely, from the positive to the negative side of the jar.

105. When, however, the quantity of free electricity was increased, by connecting the knob of the jar with a globe about a

foot in diameter, the intensity of magnetism appeared to be somewhat diminished, if the extra quantity was on the negative side; and this might be expected, since the free electricity, in its escape to the earth through the riband, in this case would tend to induce a feeble current in the opposite direction to that of the jar.

106. The spark from an insulated conductor may be considered as consisting almost entirely of this free or extra electricity, and it was found that this was also capable of producing an induced current, precisely the same as that from the jar. In the experiment which gave this result, one end of the outer riband of the cylinder (100) was connected with the earth, and the other caused to receive a spark from a conductor fourteen feet long, and nearly a foot in diameter. The direction of the induced current was the same as that of the spark from the conductor.

107. From these experiments it appears evident that the discharge from the Leyden jar possesses the property of inducing a secondary current precisely the same as the galvanic apparatus, and also that this induction is only so far connected with the phenomenon of the lateral discharge as this latter partakes of the nature of an ordinary electrical current.

108. Experiments were next made in reference to the production of currents of the different orders by ordinary electricity. For this purpose a second cylinder was prepared with ribands of tinfoil, in a similar manner to the one before described. The two were then so connected that the secondary current from the first would circulate around the second. When a discharge was passed through the outer riband of the first cylinder, a tertiary current was induced in the inner riband of the second. This was rendered manifest by the magnetizing of a needle in a spiral, joining the ends of the last mentioned riband.

109. Also by the addition, in the same way, of a third cylinder, a current of the fourth order was developed. The same result was likewise obtained by using the arrangement of the coils and helices shown in Fig. 9. For these experiments, however, the coils were furnished with a double coating of silk, and the contiguous conductors separated by a large plate of glass.

110. Screening effects precisely the same as those exhibited in the action of galvanism were produced by interposing a plate of metal between the conductors of different orders, Figures 8 and 9. The precaution was taken to place the metal between two plates



of glass, in order to be assured that the effect was not due to a want of perfect insulation.

111. Also analogous results were found when the experiments were made with coils interposed instead of plates, as described in paragraph 68. When the ends of the interposed coils were separated, no screening was observed, but when joined, the effect was produced. The existence of the induced current, in all these experiments, was determined by the magnetism of a needle in a spiral attached to one of the coils.

Fig. 12.

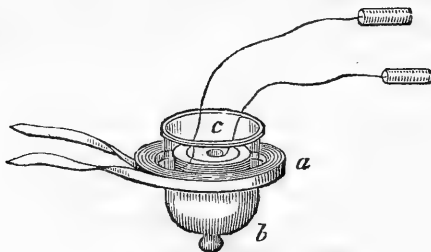

*a* coil No. 2, *b* an inverted bell glass, *c* helices No. 2 and 3.

112. Likewise shocks were obtained from the secondary current by an arrangement shown in Fig. 12. Helices No. 2 and No. 3 united, are put within a glass jar, and coil No. 2 is placed around the same. When the handles are grasped, a shock is felt at the moment of the discharge, through the outer coil. The shocks, however, were very different in intensity with different discharges from the jar. In some cases no shock was received, when again, with a less charge, a severe one was obtained. But these irregularities find an explanation in a subsequent part of the investigation.

113. In all these experiments, the results with ordinary and galvanic electricity are similar. But at this stage of the investigation there appeared what at first was considered a remarkable difference in the action of the two. I allude to the direction of the currents of the different orders. These, in the experiments with the glass cylinders, instead of exhibiting the alternations of the galvanic currents (92,) were all in the same direction as the discharge from the jar, or, in other words, they were all *plus*.

114. To discover, if possible, the cause of this difference, a series of experiments was instituted; but the first fact developed,

instead of affording any new light, seemed to render the obscurity more profound. When the directions of the currents were taken in the arrangement of the coils, (Fig. 9,) the discrepancy vanished. *Alternations were found the same as in the case of galvanism.* This result was so extraordinary that the experiments were many times repeated, first with the glass cylinders, and then with the coils; the results, however, were always the same. The cylinders gave currents all in one direction; the coils in alternate directions.

115. After various hypotheses had been formed, and in succession disproved by experiment, the idea occurred to me that the direction of the currents might depend on the distance of the conductors, and this appeared to be the only difference existing in the arrangement of the experiments with the coils and the cylinders.\* In the former the distance between the ribands was nearly one inch and a half, while in the latter it was only the thickness of the glass, or about  $\frac{1}{20}$ th of an inch.

116. In order to put this supposition to the test of experiment, two narrow slips of tinfoil, about twelve feet long, were stretched parallel to each other, and separated by thin plates of mica to the distance of about  $\frac{1}{30}$ th of an inch. When a discharge from the half gallon jar was passed through one of these, an induced current in the same direction was obtained from the other. The ribands were then separated, by plates of glass, to the distance of  $\frac{1}{20}$ th of an inch; the current was still in the same direction, or *plus*. When the distance was increased to about  $\frac{1}{8}$ th of an inch, no induced current could be obtained; and when they were still further separated the current again appeared, but was now *found to have a different direction, or to be minus*. No other change was observed in the direction of the current with a farther increase of distance; the intensity of the induction gradually diminished as the ribands were separated. The existence and direction of the current, in this experiment, were determined by the polarity of the needle in the spiral attached to the ends of one of the ribands.

117. The question at this time arose, whether the direction of the current, as indicated by the polarity of the needle, was the

---

\* This idea was not immediately adopted, because I had previously experimented on the direction of the secondary current from galvanism, and found no change in reference to distance.

true one, since the magnetizing spiral might possibly itself, in some cases, induce an opposite current. To satisfy myself on this point, a series of charges, of various intensity and quantity, from a single spark of the large conductor to the full charge of nine jars, were passed through the small spiral, which had been used in all the experiments; but they all gave the same polarity. The interior of this spiral is so small, that the needle is throughout in contact with the wire.

118. The fact of a change in the direction of the induced current by a change in the distance of the conductors, being thus established, a great number and variety of experiments were made to determine the other conditions on which the change depends. These were sought for in a variation of the intensity and quantity of the primary discharge, in the length and thickness of the wire, and in the form of the circuit. The results were, however, in many cases, anomalous, and are not sufficiently definite to be placed in detail before the Society. I hope to resume the investigation at another time, and will therefore at present briefly state only those general facts which appear well established.

119. With a single half gallon jar, and the conductors separated to a distance less than  $\frac{1}{20}$ th of an inch, the induced current is always in the same direction as the primary. But when the conductors are gradually separated, there is always found a distance at which the current begins to change its direction. This distance depends certainly on the amount of the discharge, and probably on the intensity; and also on the length and thickness of the conductors. With a battery of eight half gallon jars, and parallel wires of about ten feet long, the change in the direction did not take place at a less distance than from twelve to fifteen inches, and with a still larger battery and longer conductors, no change was found, although the induction was produced at the distance of several feet.

120. The facts given in the last paragraph relate to the inductive action of the primary current; but it appears from the results detailed in paragraphs 110 and 114, that the currents of all the other orders also change the direction of the inductive influence with a change of the distance. In these cases, however, the change always takes place at a very small distance from the conducting wire; and in this respect the result is similar to the effect of a *primary current* from the discharge of a small jar.

121. The most important experiments, in reference to distance, were made in the lecture room of my respected friend Dr. Hare of Philadelphia, with the splendid electrical apparatus described in the Fifth Volume (new series,) of the Transactions of this Society. The battery consists of thirty-two jars, each of the capacity of a gallon. A thick copper wire of about  $\frac{1}{10}$ th of an inch in diameter and eighty feet in length, was stretched across the lecture room, and its ends brought to the battery, so as to form a trapezium, the longer side of which was about thirty-five feet. Along this side a wire was stretched of the ordinary bell size, and the extreme ends of this joined by a spiral, similar to the arrangement shown in Fig. 13. The two wires were at first placed within the distance of about an inch, and afterwards constantly separated after each discharge of the whole battery through the thick wire. When a break was made in the second wire at *a*, no magnetism was developed in a needle in the spiral at *b*, but when the circuit was complete, the needle at each discharge indicated a current in the same direction as that of the battery.

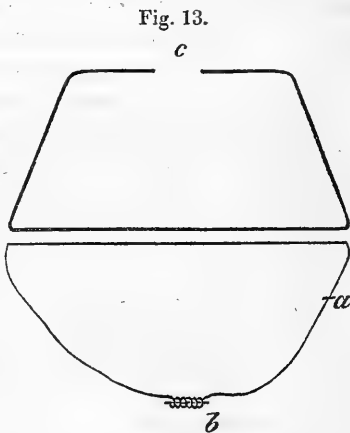

*c* place of the battery, *b* spiral.

When the distance of the two wires was increased to sixteen inches, and the ends of the second wire placed in two glasses of mercury, and a finger of each hand plunged into the metal, a shock was received. The direction of the current was still the same, but the magnetism not as strong as at a less distance.

122. The second wire was next arranged around the other, so as to enclose it. The magnetism by this arrangement appeared stronger than with the last; the direction of the current was still the same, and continued thus, until the two wires were at every point separated to the distance of twelve feet, except in one place where they were obliged to be crossed at the distance of seven feet, but here the wires were made to form a right angle with each other, and the effect of the approximation was therefore (46) considered as nothing. The needle at this surprising

distance was tolerably strongly magnetized, as was shown by the quantity of filings which would adhere to it. The direction of the current was still the same as that of the battery. The form of the room did not permit the two wires to be separated to a greater distance. The whole length of the circuit of the interior large wire was about eighty feet; that of the exterior one hundred and twenty. The two were not in the same plane, and a part of the outer passed through a small adjoining room.

123. The results exhibited in this experiment are such as could scarcely have been anticipated by our previous knowledge of the electrical discharge. They evince a remarkable inductive energy, which has not before been distinctly recognized, but which must perform an important part in the discharge of electricity from the clouds. Some effects which have been observed during thunder storms, appear to be due to an action of this kind.

124. Since a discharge of ordinary electricity produces a secondary current in an adjoining wire, it should also produce an analogous effect in its own wire; and to this cause may be now referred the peculiar action of a long conductor. It is well known that the spark from a very long wire, although quite short, is remarkably pungent. I was so fortunate as to witness a very interesting exhibition of this action during some experiments on atmospheric electricity made by a committee of the Franklin Institute, in 1836. Two kites were attached, one above the other, and raised with a small iron wire in place of a string. On the occasion at which I was present, the wire was extended by the kites to the length of about one mile. The day was perfectly clear, yet the sparks from the wire had so much projectile force, (to use a convenient expression of Dr. Hare,) that fifteen persons, joining hands and standing on the ground, received the shock at once, when the first person of the series touched the wire. A Leyden jar being grasped in the hand by the outer coating, and the knob presented to the wire, a severe shock was received, as if by a perforation of the glass, but which was found to be the result of the sudden and intense induction.

125. These effects were evidently not due to the accumulated intensity at the extremities of the wire, on the principles of ordinary electrical distribution, since the knuckle required to be brought within about a quarter of an inch before the spark could be received. It was not alone the quantity, since the experi-

ments of Wilson prove that the same effect is not produced with an equal amount of electricity on the surface of a large conductor. It appears evidently therefore a case of the induction of an electrical current on itself. The wire is charged with a considerable quantity of feeble electricity, which passes off in the form of a current along its whole length, and thus the induction takes place at the end of the discharge, as in the case of a long wire transmitting a current of galvanism.

126. It is well known that the discharge from an electrical battery possesses great divellent powers; that it entirely separates, in many instances, the particles of the body through which it passes. This force acts, in part, at least, in the direction of the line of the discharge, and appears to be analogous to the repulsive action discovered by Ampere, in the consecutive parts of the same galvanic current. To illustrate this, paste on a piece of glass a narrow slip of tinfoil, cut it through at several points, and loosen the ends from the glass at the places so cut. Pass a discharge through the tinfoil from about nine half gallon jars; the ends, at each separation, will be thrown up,

and sometimes bent entirely back, as if by the action of a strong repulsive force between them. This will be understood by a reference to Fig. 14; the ends are shown bent

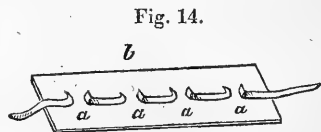

*b* glass plate; *a, a, a, a*, openings in tinfoil.

back at *a, a, a, a*. In the popular experiment of the pierced card, the bur on each side appears to be due to an action of the same kind.

127. It now appears probable, from the facts given in paragraphs 119 and 120, that the table in paragraph 92 is only an approximation to the truth, and that each current from galvanism, as well as from electricity, first produces an inductive action in the direction of itself, and that the inverse influence takes place at a little distance from the wire.

128. In reference to this view, the compound helix was placed on coil No. 1, to receive the induction, and its ends joined to those of the outer riband of tinfoil of the glass cylinder, while the magnetizing spiral was attached to the ends of the inner riband. A feeble tertiary current was produced by this arrangement, which in two cases gave a polarity to the needle indicating a di-

rection the same as that of the primary current. In other cases the magnetism was either imperceptible or *minus*. With an arrangement of two coils of wires around two glass cylinders, one within the other, the same effect was produced. The magnetism was less when the distance of the two sets of spires was smaller, indicating, as it would appear, an approximation to a position of neutrality. These results are rather of a negative kind, yet they appear to indicate the same change with distance in the case of the galvanic currents, as in that of the discharge of ordinary electricity. The distance however at which the change takes place, would seem to be less in the former than in the latter.

129. There is a perfect analogy between the inductive action of the primary current from the galvanic apparatus and of that from the larger electrical battery. The point of change, in each, appears to be at a great distance.

130. The neutralizing effect described in Sections IV and VI, may now be more definitely explained by saying that when a third conductor is acted on at the same time by a primary and secondary current (unless it be very near the second wire) it will fall into the region of the *plus* influence of the former, and into that of the *minus* influence of the latter; and hence no induction will be produced.

131. This will be rendered perfectly clear by Fig. 15, in which *a* represents the conductor of the primary current, *b* that of the secondary, and *c* the third conductor. The characters + + +, &c., beginning at the middle of the first conductor and extending downwards, represent the constant *plus* influence of the primary current, and those + 0 - -, &c., beginning at the second conductor, indicate the inductive influence of the secondary current as changing with the distance. The third conductor, as is shown by the figure, falls in the *plus* region of the primary current, and in the *minus* region of the secondary, and hence in it the two actions neutralize each other, and no apparent result is produced.

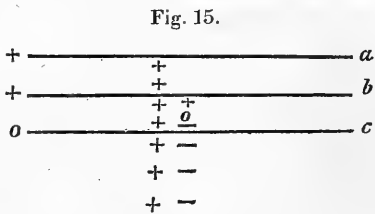

132. Fig. 16 indicates the method in which the neutralizing effect is produced in the case of the secondary and tertiary currents.

The wire conducting the secondary current is represented by *b*, that conducting the tertiary by *c*, and the other wire, to receive the induction from these, by *d*. The direction of the influence, as before, is indicated by + 0 - -

Fig. 16.

&c., and the third wire is again seen to be in the *plus* region of the one current, and in the *minus* of the other. If, however, *d* is placed sufficiently near *c*,

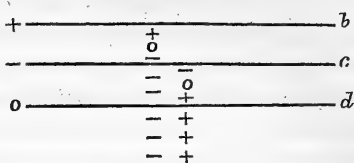

then neutralization will not take place, but the two currents will conspire to produce in it an induction in the same direction. A similar effect would also be produced were the wire *c*, in Fig. 15, placed sufficiently near the conductor *b*.

133. Currents of the several orders were likewise produced from the excitation of the magneto-electrical machine. The same neutralizing effects were observed between these as in the case of the currents from the galvanic battery, and hence we may infer, that also the same alternations take place in the direction of the several currents.

134. In conclusion, I may perhaps be allowed to state, that the facts here presented have been deduced from a laborious series of experiments, and are considered as forming some addition to our knowledge of electricity, independently of any theoretical considerations. They appear to be intimately connected with various phenomena, which have been known for some years, but which have not been referred to any general law of action. Of this class are the discoveries of Savary, on the alternate magnetism of steel needles, placed at different distances from the line of a discharge of ordinary electricity,\* and also the magnetic, screening influence of all metals, discovered by Dr. Snow Harris of Plymouth.† A comparative study of the phenomena observed by these distinguished *savants*, and those given in this paper, would probably lead to some new and important developments. Indeed every part of the subject of electro-dynamic induction appears to open a field for discovery, which experimental industry cannot fail to cultivate with immediate success.

\* Annales de Chimie et de Physique, 1827.

† Philosophical Transactions, 1831.



*Note.*—On the evening of the meeting at which my investigations were presented to the Society, my friend, Dr. Bache of the Girard College, gave an account of the investigations of Professor Ettingshausen of Vienna, in reference to the improvement of the magneto-electric machine, some of the results of which he had witnessed at the University of Vienna about a year since. No published account of these experiments has yet reached this country, but it appears that Professor Ettingshausen had been led to suspect the development of a current in the metal of the keeper of the magneto-electric machine, which diminished the effect of the current in the coil about the keeper, and hence to separate the coil from the keeper by a ring of wood of some thickness, and afterwards, to prevent entirely the circulation of currents in the keeper, by dividing it into segments, and separating them by a non-conducting material. I am not aware of the result of this last device, nor whether the mechanical difficulties in its execution were fully overcome. It gives me pleasure to learn that the improvements, which I have merely suggested as deductions from the principles of the interference of induced currents (76,) should be in accordance with the experimental conclusions of the above named philosopher.\*

---

ART. II.—*Analysis of a Chromic Iron Ore, first observed by R. C. TAYLOR, Esq., at Mahobal, near Gibara, Island of Cuba; by JAMES C. BOOTH and M. CAREY LEA.*

1. *Description.*—This mineral has a black color, and shining metallic lustre, closely resembling Franklinite from New Jersey. It is moderately brittle, exhibiting a chocolate brown streak, when reduced to the finest powder. The mass consists of coarsely crystalline particles, aggregated together, with intervening talcose matter, of a lighter color and softer texture than the chromic iron. This crystalline structure is so evident, that triangular faces of the octahedron are observable in a majority of the specimens.

---

\* The reader is referred to a subsequent paper by Prof. Henry, (containing important additions to the facts stated in this article,) of which an account is given in the present Number, among the *Proceedings of Am. Phil. Soc.*, under date of October 18, 1839.—*Eds.*

2. Before the blowpipe, it dissolves in a bead of borax or microcosmic salt, exhibiting the characteristic reaction of oxide of chrome.

3. *Analysis.*—To obtain a proper specimen of the mineral for analysis, it was coarsely broken up and separated from the gangue, as far as practicable. It was then finely pulverized, and one gramme of it ignited with carbonate of soda and caustic potassa, in order to convert the oxide of chrome into chromate of potassa.

4. The fused mass was digested with water and thrown upon a filter, which separated the oxide of iron and that portion of the mineral which had not been decomposed, from the other constituent which passed through in solution. The filter was then treated with hydrochloric acid, which dissolved the iron, leaving the undecomposed ore on the filter. This was found to amount to .353.

5. The solution of chloride of iron which passed through, was then digested with nitric acid, and the peroxide precipitated by ammonia. This amounted to .172. In a previous experiment, it was found to contain neither alumina nor magnesia.

6. The solution obtained by the first filtration (4), was next neutralized by nitric acid, enough being added to precipitate and redissolve the alumina. The latter was then precipitated by bicarbonate of soda and its weight found to be .1414.

7. The remaining solution was now evaporated to dryness with carbonate of soda, and treated with water. The magnesia thus rendered insoluble, was separated and amounted to .090.

8. In the solution from (7), there still remained the oxide of chrome, which was estimated by concentrating the liquid by evaporation and adding to it while boiling, hydrochloric acid and alcohol. The chromic acid, thus converted into oxide of chrome, was precipitated by ammonia and separated on a filter. The solution passing through, still contained a small portion of oxide of chrome and was therefore evaporated to dryness and digested with water. The oxide of chrome thus rendered insoluble, was added to that before obtained, and the weight of the whole amounted to .244.

9. *Conclusions.*—The streak of the mineral being chocolate brown, it is difficult to say whether this color arises from the protoxide of iron or the brown oxide of chrome, a problem of exceed-

ingly difficult solution by chemical analysis. Supposing the iron, however, to be in the state of protoxide, the .172 will be reduced to .1544 of protoxide. Now if ignition with carbonate of soda and caustic potassa, left a portion of the mineral undecomposed, it may without great error be assumed that the iron in this portion has not been peroxidized by that operation, and that therefore .353 is the correct weight of the undecomposed portion of the mineral. By adding the several weights obtained, we have,

Oxide of chrome,	-	-	-	-	.2440
Protoxide of iron,	-	-	-	-	.1544
Alumina,	-	-	-	-	.1414
Magnesia,	-	-	-	-	.0900
Undecomposed ore,	-	-	-	-	.3530
					<hr/>
					.9828

This shows a loss of 1.72 per cent., which may be ascribed in part to errors in analysis, and partly, without impropriety, to a partial peroxidation either of the iron or chrome.

By omitting the undecomposed matter, and calculating the percentage of each ingredient, we find the mineral to consist of

Oxide of chrome,	-	-	-	-	38.742
Protoxide of iron,	-	-	-	-	24.516
Alumina,	-	-	-	-	22.452
Magnesia,	-	-	-	-	14.290
					<hr/>
					100.000

This result indicates that a portion of the talcose matter was included in the specimen, notwithstanding the care exercised in its separation. Viewing the alumina, with a little silica included in it and the magnesia, as belonging to the talc, we find the formula for the oxides of chrome and iron, to be 2 : 3, or  $3(\text{FeO}) + 2(\text{Cr}^2\text{O}^3)$ . The formula generally received for the pure mineral is  $2\text{Cr} + \text{Fe}$ , and leads to the supposition, that in the present case, a portion of the iron exists as protoxide, a view which is strengthened by the brown streak of the mineral.

Philadelphia, Dec. 5, 1839.

ART. III.—*Remarks upon some of the probable effects of a Resisting Medium*; by THOMAS H. PERRY, Prof. Maths. U. S. N.

It is a somewhat common opinion, that the resisting medium believed to occupy the planetary spaces, must eventually destroy the motions of the solar system. This conclusion does not seem to me to be justified by the state of the facts at present known: and, although it may not be easy to demonstrate the absolute impossibility of such an effect, the admirable provisions for the continuance of the present arrangement of the heavenly bodies, which science has already elicited, ought to be considered, at least until contrary probabilities are shown to exist, presumptive indications of its future permanence.

The final effects of a resisting medium must depend upon its extent and mode of distribution. The facts from which its existence is deduced, do not apprise us whether it is, or is not, limited to a comparatively small distance from the sun; nor whether it is diffused *continuously* from this luminary to the remotest limits of his system, or is disposed about him in concentric zones, separated by intermediate spaces, incapable of impeding ponderable bodies. It is not a legitimate inference that the medium by which comets are retarded is essential to the transmission of light, and therefore the visibility of the remotest stars, which would in that case be a relevant fact, has no necessary connection with the subject.

Were it proved that the ether is in its extent as unlimited as space, and that its elasticity is no where counterbalanced by any kind of attraction, it would indeed follow that its effects, however inappreciable and indefinitely slight in any finite period, must become sensible, when augmented by the increments of time in the same degree indefinitely great; and that the planets, as has been often asserted, must, in the lapse of a sufficient series of ages, fall to the sun.

But while we have, in known facts, no evidence that the ether is thus universally diffused, we are led by analogy and the favorite theories of the age, to presume the contrary. If, as every circumstance that has any bearing upon the subject conspires to evince, all the ponderous globes in the universe, once pervaded space as attenuated nebulae, surely it must require great elasticity and expansion of the ethereal matter to fill the vacuum formed by

their condensation ; unless, indeed, it be assumed that it has ever penetrated alike the interstices between the particles of solid, fluid and aeriform bodies ; an assumption which might involve us in unauthorized conclusions.

If this medium be possessed of gravity, as we might consistently presume, especially since it must otherwise tend to recede from the sun and planets into infinite space, leaving them and their satellites to revolve in vacuo ; it may be considered as a circumsolar atmosphere, subject to the usual laws of atmospheric density and limitation, modified by its vast extent, its extreme tenuity, by any relevant peculiarities it may possess, and by the present and past condition and changes of the system.

In objecting then to the prevalent opinion state ! at the commencement of these remarks, it seems that we are authorized, by the state of such known facts, analogies and principles as relate to the subject, and by the condition and position of the argument, to presume that the resisting medium is finite in extent ; and that, being so constituted as to obey the laws of physical mechanics, its particles, if once in a state of revolution about the sun, would have a tendency to continue their motions, upon the same principles according to which the planets describe their respective orbits. And therefore ; whatever may have been its primary condition, it must have, in the existing state of things, motions consentaneous with those of the sun and planets, which have been so long revolving in it, in the same angular direction, and in nearly the same plane ; since it could require a small fraction only of their momenta, to communicate rotation to a medium so rare as to impede very little bodies of immense magnitude, yet incapable of disturbing sensibly the satellites of Jupiter, when in close proximity.

Again, as the planets nearest the sun revolve most rapidly, the *angular velocity of the ether must also vary with the distance*. Supposing it to have ever been continuous, the exterior portions would be accelerated by the friction of those near the centre, until the centrifugal force should exceed the centripetal, when the former would begin to recede, thereby producing a successive separation into zones, upon principles somewhat analogous to those according to which, a similar arrangement of the primeval belts of planetary vapors is alleged to have taken place. Whatever may have been its original condition, it would be difficult to con-

ceive how any other mode of distribution than what is here supposed eventually to obtain, could be *permanent*.

Those who admit the nebular theory, would hardly contend that the ether has been otherwise circumstanced since the detachment of the planetary rings. While each expanded belt or attenuated globe was describing the orbit which the planet has since described, a medium capable of resisting its motions, could not remain at rest. There is no known reason why an incongruity of angular velocity, and partial equilibrium of the centripetal and centrifugal forces, capable of separating the zones of grosser matter exceedingly rarefied, should fail to produce analogous effects upon any other fluid, governed by similar laws, and having like diversities of velocity. And should the belts of ether, having their several appropriate rates of motion, and separated by considerable intervals, probably, even before the completion of the earlier adjustments of the system, subsequently interfere with each other, or be otherwise disturbed, the same causes which would be capable of producing it, must operate to restore the arrangement.

Should it be assumed that this medium is, and must necessarily *remain continuous*, and that such a disposition of it as has been indicated, is impossible, it is conceded that the system must experience important changes. The impropriety of any such assumption has been already shown. Since then no disposition or tendency of the resisting medium inconsistent with the purposes of our argument, is at all probable, and since the planets cannot be retarded by a medium having the same periodical revolution with themselves, it is conceived that we are justified in concluding that we have no sufficient reason to infer that these bodies must, from any such cause, fall to the sun.

But although what has been already advanced is deemed sufficient to evince that the orbits of the principal planets are not likely to experience any essential alteration from the causes under discussion, the possible effects upon the rotation of the primaries upon their axes, and upon all the motions of their secondaries, remain to be noticed. Such motions, whenever they take place in a zone of ethereal fluid, must evidently be resisted until the contiguous portions acquire an equal rotation. This could not happen, until they should cease to be retarded by other and exterior portions; but that it must sooner or later take place is evident from the following considerations.

1st. The circumferences of circles being as their radii, and gravity inversely as the square of the distance; the centrifugal force of portions remote from the primary, at length exceeding the force of attraction, must cause them to recede; and this process must continue as long as the momenta of the planet and its satellite continue to be transmitted to the circumference of its tenuous atmosphere.

2nd. The rotation of any mass having motions similar to those of the planets, must, as might easily be proved, have a tendency to remove a resisting medium from its path, and therefore if ever the ether were so disposed as to interfere with the motions of the planets and their satellites, it must, unless retained by causes of whose existence we are not apprised, recede from the vicinity of their orbits.

3rd. So much of the ether as should nevertheless be retained by the attraction of any of these bodies, would probably be disposed in concentric zones, analogous to those in the general system, and upon similar principles; after the separation of which zones, the influence of a resisting medium would cease to be felt, at least until their arrangement should be disturbed.

4th. And finally, as the magnitude of the planetary bodies was probably much greater formerly than at present, it may be presumed that most of these changes occurred before the process of condensation was completed.

The ether once distributed throughout the system as has been indicated, and with the elements of readjustment, must resist the action of a disturbing force. A cause of disturbance exists in the excentric motions of comets, which in their course must necessarily displace portions of the intersected zones. But this cause can hardly exceed the force requisite to render their present orbits consentaneous with the general motions of the system. Besides, while it acts with exceeding slowness in widely distant regions, it operates at the two intersections of each zone made in a revolution, in nearly opposite directions; and therefore comparatively feeble as the resulting forces must be, under any circumstances, it is possible that in consequence of its mode of operation, this cause may effect little else than temporary oscillations of the medium until it ceases to act.

The consideration of influences and consequences foreign to the system, has been thus far, for the most part, purposely avoided.

A little reflection however will evince that if we view the starry universe as composed of *systems of systems*, acknowledging a common centre, and suppose a resisting medium to be partially diffused throughout, the preceding reasoning would with a little modification be applicable to its mode of distribution. Even here we find no cause to apprehend the dissolution of creation, or to infer that physical worlds will cease to exist, as theatres for the operation of the infinite love and infinite wisdom of the Divine Creator.

I am aware that there are those whose religious feelings are enlisted to prove, upon philosophical grounds, the certainty of the final destruction of at least this terrestrial globe; and who may therefore distrust the tenor of the foregoing remarks. With the hazards to which our earth may be exposed from other sources, I have at this time nothing to do. But with all due deference to those who may differ from me in opinion, if such there are, although I revere the sacred scriptures as the manifestation of divinity to man, I do not regard them as designed to instruct us in physical philosophy. Prophecy has not always been understood until the time of its fulfilment; and while some contend, as the admirers of Swedenborg; that the word of God contains throughout a figurative or spiritual sense, the prophecies are confessedly full of metaphor. In those relating to the final consummation of all things, circumstances are stated which must be considered figurative. It is not improbable that others are misunderstood, and it is believed to be alike dangerous to science and to religion, to be unduly biased in our investigations of philosophical questions, by uncertain interpretations of the sacred volume.

---

ART. IV.—*Description and Analysis of a Meteoric mass, found in Tennessee, composed of Metallic Iron, Graphite, Hydroxide of Iron and Pyrites*; by G. TROOST, M. D., Prof. of Chemistry, Mineralogy and Geology in the University of Nashville, Tenn.

DURING my excursions through East Tennessee, I had seen small fragments of native iron, and had heard of large masses of it, which were believed to be silver. It being considered a precious metal, all that was known about it, and the place where it was found, were kept a profound secret. Some less prejudiced inhabitant at last became acquainted with the nature of the metal,



and its real value was made known. To the politeness of Col. Micajah C. Rodgers, of Serierille, I am indebted for a considerable quantity of it; and the Hon. Judge Jacob Peck of Jefferson County, has also presented me with some small fragments. I am thus enabled to lay a description of this singular substance before the scientific public.

Having ascertained, as appears from the analysis below given, that this iron contains nickel, the mass must be considered of meteoric origin; but it differs from most of the masses of meteoric iron hitherto described. The original weight of it is said to have been about 2000 pounds. The portions that I have seen, (as well as those which are in my possession,) present a singular heterogeneous mixture of metallic iron, carburet of iron or graphite, sulphuret of iron, (pyrites,) and hydroxide of iron, the latter, brown and yellow; in some parts all four ingredients form a kind of homogeneous mixture.

The most abundant constituent, however, is the nickeliferous iron, and it composes about  $\frac{9.5}{100}$ ths of the whole mass. It has partly a crystalline structure, and is in part, composed of grains or globules of various sizes and forms, merely agglutinated together, or sometimes separated by a thin flexible highly polished pellicle of graphite. The crystalline part is composed of laminæ of various thickness, in the form of equilateral triangles, which are separated from each other by very thin flexible pellicles, as mentioned above respecting the grains.

I expected to find these triangular laminæ placed in such position as to form octahedrons, or showing a cleavage parallel to the sides of a regular octahedron; but this is not the case, as the cleavage gives a regular tetrahedron. I have one of these forms, which is about an inch from base to apex.

The metallic iron is also dispersed in small irregular-shaped masses through a hard, compact, brown hydrated oxide of iron. Throughout this the iron is also dispersed in invisible grains, to be detected only by the magnet, which attracts them when the substance has been reduced to powder.

This iron is malleable. I have in my possession a horse-shoe nail, which was made of it without having undergone a previous preparation, but it is harder and whiter than common wrought iron. This hardness and color may be owing to a small quantity of carbon which it contains, or perhaps to the nickel; in its natural state, however, the color of the iron differs much in different

parts. In some it is black, and has no metallic lustre; in others, it has a brilliant metallic lustre, and is then always much whiter than steel or common iron. It is then but little susceptible of being tarnished when exposed to the action of the air; the black part being merely tarnished, may be rendered white by a file; in some places it is covered with a kind of black varnish.

The substance which constitutes the greatest part of the remainder of the mass, is graphite. This substance is not easily distinguished from the common graphite or plumbago, except that it is a little harder than the common granular and compact varieties, and is also rather blacker, and makes a finer, blacker, and more distinct line upon paper than common plumbago. When rubbed with a hard body it assumes a bright metallic lustre. It is not pure graphite, but rather a mixture of graphite and metallic iron. The iron can be partly removed by a magnet when the graphite is reduced to powder, but a considerable portion remains mixed with the graphite, which, when acted upon with hydrochloric acid, is dissolved with a brisk effervescence of hydrogen gas.

The sulphuret of iron, or pyrites, occupies the smallest portion of the mass. This pyrites is not attracted by the magnet, nor does it seem to act upon the magnetic needle. It can easily be cut with a knife, and is consequently softer than common pyrites. It does not give sparks when struck with steel, another property which distinguishes it from common pyrites. It is easily soluble in diluted hydrochloric acid, with a brisk evolution of sulphuretted hydrogen gas, leaving a mixed powder of white and black in the fluid. It has a more or less sub-lamellar structure, in which no regularity can be perceived, and a color between bronze yellow and copper red, often tarnished.

The hydroxide of iron, which forms part of this mass, is a heterogeneous mixture of the varieties of the ore generally known under the names of brown iron ore and yellow ochre, and resembles this terrestrial mineral. Its color is generally brownish black, passing into liver brown. The external surface of the mass is covered here and there with the yellow earthy variety (yellow ochre); how far this covering extended, I am not able to say, as the mass was too roughly handled before any part of it came into my possession. Its fracture resembles that of the common compact brown iron ore. The blackish brown variety is so very hard, that the best file is immediately dulled upon it, and leaves

particles of the steel on the surface of the ore. Nevertheless, the whole is not of uniform hardness; a part, particularly the liver brown, being scratched by the file.

Some small cavities in it are lined with lamellar crystals, resembling those of white pyrites.

This hydroxide, which serves as a matrix of the metallic iron, is not, judging from my specimens, abundant in the interior of the mass, but the exterior of the mass is entirely made up of it. At some places it is about one inch thick, while at others it is no more than one quarter of an inch, showing here and there small points of the metallic iron piercing through it.

Such are the characters and appearances of this mass, of the date and circumstances of whose fall, nothing is known. It was accidentally discovered near Cosby's creek, in the southwestern part of Cocke County, East Tennessee, and as I mentioned above, was considered as silver ore. Indeed, there is yet a fragment of it in the hands of an inhabitant, who asks for it \$1500—a sum, which would be some hundred dollars too much, if it were pure silver.

*Chemical constituents of the different parts.*

1. *Metallic Iron.*—100 grains of the metallic iron were dissolved in diluted hydrochloric acid, leaving a residue of half a grain of a black powder, similar to that obtained from the graphite. This solution being treated with nitric acid, to convert the protoxide into peroxide, was precipitated by pure ammonia. The precipitate being washed and ignited, gave 124 grains of peroxide, = 87 grains of iron. The ammoniacal solution gave 16 grains of protoxide of nickel, = 12 grains of metallic nickel, with a trace of cobalt; loss, half a grain.

Iron,	-	-	-	-	-	-	-	87.0
Nickel,	-	-	-	-	-	-	-	12.0
Carbon,	-	-	-	-	-	-	-	0.5
Loss,	-	-	-	-	-	-	-	0.5
								100.0

2. *Graphite.*—50 grains of the graphite being pulverized and freed by a magnet from intermixed iron, were acted upon with diluted hydrochloric acid. An effervescence took place, with expulsion of hydrogen gas, owing to metallic iron, which was so intimately mixed with the graphite, that it was not attracted by



ART. V.—*Notice of Tracks of Animals in Variegated Sandstone at Pölzig, between Ronneburg and Weissenfels*; by Hr. Dr. B. COTTA.\*

Translated for this Journal by Rev. Prof. W. A. LARNED, of Yale College.

WHILE recently engaged in revising the preparations for the geological map of Saxony, in the country between Ronneburg and Weissenfels, I frequently met with stone slabs in the region of the variegated sandstone, which were covered on one side with the same sort of reticular padding as the track-sandstone of Hildburghausen. These net-formed pads could have originated in no other way, as every thing about them shows, than by the filling up of clefts occasioned by the drying of thin layers of clay. But if thin beds of clay formed between sandstone strata, had time and opportunity for drying before the deposition of a new layer of sand, then manifestly there existed some of the essential pre-requisites for the preservation of ancient foot-prints; it would only be necessary that there should be animals at that period to roam at will over the soft clay, before the water covered it anew with sand. Under these impressions, I began to search for foot-tracks on my way to Pölzig, where, as I was informed, the slabs were abundant. Before reaching the quarries at Pölzig and Klein-Pörthen, I observed at a village, in a heap of building stones, several small elevated figures, which arrested my attention on account of their similarity in form and size; their form, however, appeared so remarkable that I could hardly persuade myself they were casts of tracks, although I was in search of such. On arriving, however, at the quarry of Pölzig, I obtained full evidence that these figures actually originated from the footsteps of animals. Several large slabs were here entirely covered with them, and in one place at the first quarry, on the left slope of the valley above Pölzig, I found the track-stratum still remaining, a portion dug under and covered on the under side entirely with reliefs. Such is the history of the discovery, though it is but just to say, that had not Dr. Sickler led the way, I should never have thought of

---

\* Neues Jahrbuch für Mineralogie, Geognosie, Geologie und Petrofaktenkunde, herausgegeben von Dr. K. C. v. Leonhard und Dr. H. G. Bronn, Professoren an der Universität zu Heidelberg. Erstes Heft. 1839.

looking for foot-prints here, nor recognized these when accidentally found, as such.

A.

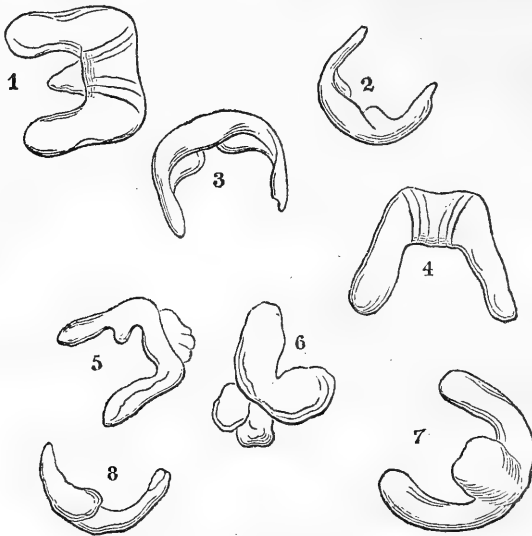

The form of these foot-reliefs, which resemble those of Hildburghausen in no other respect than the mode of their occurrence, is very peculiar, being two-toed, and more like horse-shoes than feet. I sought in vain for any regular arrangement or the continuous course of any one individual; all the tracks stood singly, as in the above plate A, in as much disorder as if there had been a large tumultuous assemblage of animals there. For this reason, the forms of individual casts are often not expressed entire, and all are not alike, some being rounded behind, (2, 3, 7 and 8,) and others more angular, (1, 4 and 5;) sometimes we observe on the hind part a little irregular prominence, (5 and 6.) These variations may have arisen, in part, though hardly all of them, from the inequality of the soft ground, from the impression and direction of the foot, &c. The irregular position speaks rather for two-footed than four-footed animals. Some slabs are covered with little round bosses of the same size with the foot-casts; these, however, occur only on the under surface of the layers resting on the clay. Could the clay, in a certain state of softness, have hardened on the feet so as to make their prints obscure?

The net-formed pads had first led me, as already observed, to search for tracks; I was, therefore, quite surprised to find them so rarely in connection with the foot-tracks, although occurring very abundantly in the same quarry. The clayey underlayer of the track-strata happens to be so thin here ordinarily, ( $\frac{1}{4}$ — $\frac{1}{2}$  an inch,) that it perhaps on this account did not crack in drying. I would remark farther on one striking peculiarity of the track-slabs of this place; they are generally very undulatory upon the side opposite the impressions, that is, the upper, and more even on the under. The water evidently has had more effect on the sand than on the tough clay.

*New Red Sandstone formation.*

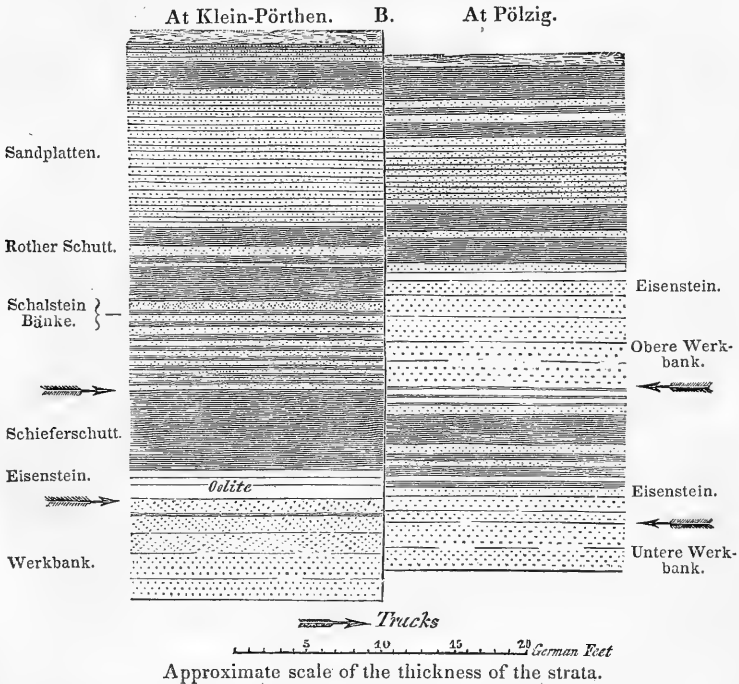

Approximate scale of the thickness of the strata.

The track-reliefs occur at Pölzig and Klein-Pörthen, it is probably only in two layers, whose particular position is indicated on the plate (B) by small arrows. These layers belong in general to the middle region of the variegated sandstone formation. They are characterized throughout the whole district by gray, yellow, and even white colors; at Crossen, on the Elster, we see them

distinctly embedded upon the lower red sandstone, and in the Saal valley, between Weissenfels and Dürrenberg, they are covered by the upper red clay. We find traces of track-casts also at Crossen, at Weissenfels, and at Gross-Aga not far from Zeitz; however, only here and there, and perhaps less distinctly than at Pölzig. At the latter place, the animals seem to have congregated in herds. But however rare they appear in the other places, the wide extent of the region in circumstances favorable to their hardening, is worthy of attention.

The quarries of Pölzig and Klein-Pörthen are situated in parallel level vallies, and are separated from one another by a mountain ridge about an hundred feet high and one mile broad. The arrangement of the individual strata in them is represented on the plate, (B,) and needs only a few explanations in addition.

In both places, the sequence of the strata is tolerably uniform, although some variations exist with respect to thickness and internal composition. The track-strata, indicated by arrows, may be regarded as parallel, since their position in general corresponds so exactly, that they might be held as actually identical.

The lowest track-layer in both places occurs in a minutely granular gray-yellow sandstone, whose strata, from one to two feet thick, and separated by a thin layer of clay, are preferably employed for the getting out of the larger building-stones, and on this account, they are called by the workmen, "Werkbank."\*

Upon this follows, at Pörthen, a firm, dark gray oolite, passing beneath into gray sandstone with traces of copper-green, but at Pölzig on the contrary, a firm, gray sandstone, which only rarely contains oolite. At both of these places these strata are called, on account of their hardness, "Eisenstein," and are used especially for road making.

Next, at Pörthen, greenish-gray slate clay, called "Schieferschutt," and the same at Pölzig, but alternating above and below with sandstone strata.

On this follows, at both places, the upper track-layer, on the under surface of the sandstone strata, which, at Pörthen, are thin, and frequently alternating with slate-clay, on which account they

---

\* The local terms employed by the workmen I have not thought it necessary to translate in the text or plate. I give their literal signification *Werkbank*, *shop-board* or *work-bench*; *eisenstein*, *ironstone*; *schieferschutt*, *slate earth*; *schalsteinbänke*, *shale-banks*; *rother schutt*, *red earth*; *sandplatten*, *sandplates*.—*Tr.*



are called, "Schalsteinbänke;" while at Pölzig they correspond to the under "Werkbank," and are called the upper "Werkbank." This sandstone formation at Pölzig, consists of thinner strata, is firmer, and more gray, on which account it is called, in the upper region, "Eisenstein;" but I found no oolite there.

On these sandstone strata, follows at both places, slate-clay, with one or two sandstone plates intermediate. At Pörthen, however, it is colored rather red, than greenish gray, and is there called, "rother Schutt." Upon this, rest the so called, "Sandplatten," thin, yellow sandstone strata, which extend over a much larger region at Pörthen than at Pölzig.

The slate-clay and sandstone, finally, which cover these sand plates, occur only in some places in the highest parts of the quarries, and in general considerably contorted.

The engraved plate is not to be regarded as geometrically exact, for the thickness of the layers is only conjectured, and it is in the main, a representative of several contiguous quarries, rather than an accurate copy from one, which appeared to me would be exact enough for the present object.

I proceeded in a similar manner, with the copies of the foot-tracks: they are sketched, indeed, individually exact, according to their natural size, being even measured with the compasses; but their relative position is arbitrary, they being placed thicker than is usual on the slabs, as the most distinct reliefs of several individual slabs, are united in a small space. Besides, the form in these hasty outlines, may be more sharply marked out, than is really the case in nature, in order to make up for the want of a practiced hand, which alone can represent any thing distinctly, and yet true to nature. These sketches may give an idea of the thing, but a better account may be hoped for, from Professor Rossmässler, for whom I have this day ordered a wagon-load of the large slabs to Freiberg.

ART. VI.—*Observations on the Aurora Borealis of September 3, 1839*; communicated by EDWARD C. HERRICK, Rec. Sec. Conn. Acad.

ON the night of Tuesday, the 3d of September, 1839, an extraordinary display of the Aurora Borealis was seen in all parts of the United States, and was probably also visible over a large portion of the northern hemisphere above the latitude of  $30^{\circ}$ . The public attention throughout the country, was much attracted by this display, and numerous descriptions of its phenomena were published in the newspapers. I propose here to give a brief abstract of some of these accounts.

1. *New Haven.* Observations were made here by Mr. A. B. Haile, Mr. F. Bradley, and myself, and doubtless also by many others. The auroral light was first noticed about half an hour after sunset, and of course while the twilight was quite strong. At this time the sky was much obscured by thin clouds, but these gradually dispersed. As daylight faded, the Aurora grew more conspicuous, and soon presented a most splendid scene. So many good detailed descriptions of great Auroral displays have however already been published in this Journal, that it seems unnecessary to attempt in this place a very minute account of the particulars of this instance. Previous to midnight, there were three or four seasons of maximum energy, during which a large portion of the heavens was covered with a vast assemblage of streamers of various hues, in which crimson and silver-white predominated. The exhibition was, on the whole, quite equal in splendor to any which we have ever seen in this region. Several times in the course of the evening, the corona was distinctly formed, enveloped, as usual in a tumultuous, ever-shifting mass of Auroral light. The mean of numerous observations of the altitude of the centre of the corona, taken by a plumb-quadrant, gave  $74^{\circ}$ ; which is not more than half a degree greater than the present magnetic dip at this place. Before 9h. 26m. there was but little undulation in the streamers, but about this time the Auroral waves began to show themselves, and soon flashed up towards the zenith with great magnificence. Low in the north, we saw at this time, what appeared to be short dark columns rising across the intensely luminous band which lay there, and then almost

instantly vanishing. This was often repeated. The southern part of the heavens was occupied with streamers to very unusual extent. The arch bounding the streamers on the South gradually descended, so that at 10h. its vertex was not more than  $10^{\circ}$  above the horizon. We were consequently led to infer that this occurrence extended very far to the south of us, which has been found to be the fact.

At 7h. 37m. I stationed within the house, a surveyor's compass, so that the needle coincided with the N. and S. points. At 8h. 7m. it stood at  $30'$  W. of N. At 9h. 7m. a splendid red blaze in the E., needle N.  $30'$  E.: 9h. 27m. needle 0. At noon on the 4th, the needle stood at N.  $1^{\circ} 30'$  W., so that, (if we assume, as is most probable, that the needle had then regained its usual place,) its north end was not observed during the Aurora, to be carried to the west of its mean position. Circumstances rendered it inconvenient to retain the instrument any longer in the place it occupied during the Aurora, so that it can not be confidently asserted that the influence of the Aurora was entirely ended at noon on the 4th. The needle is much less sensitive than that of the variation compass formerly employed. Of course I can not compare the magnetic effects of this display with those of other great occasions of this kind. During the evening, the temperature was from  $70^{\circ}$  to  $60^{\circ}$ . At 9h. the dew point was  $58^{\circ}$ , the air being  $65^{\circ}$ .

We discontinued our observations a little after 11h. at which time the display had greatly declined. A person who was abroad after midnight, informed me that about 1 A. M., (4th,) the spectacle was, if possible, more splendid than before. At 4 A. M., I found numerous streamers in active undulation, about the Northern horizon; but not reaching to a greater elevation than  $20^{\circ}$ .

During the night of Wednesday, the 4th, the sky was densely overcast. A moderate Auroral display was seen at Albany, N. Y., at Middlebury, Vt., and probably at many other places where the state of the weather permitted observation.

2. *Nashville, Tenn.* N. lat.  $36^{\circ} 9' 33''$ ; W. lon.  $86^{\circ} 49'$ . The following observations are contained in a letter to Prof. Silliman from Prof. James Hamilton, of the University of Nashville. "Although a resident in this city for more than six years, between 1827 and 1835, I have never seen so beautiful an exhibition of the Aurora Borealis, as that which occurred in the evening

of September 3, 1839; nor have I been able to learn that any of the oldest inhabitants remember one of equal magnificence. The late display was but little inferior to those I have observed in New Jersey, three times within the last four years. About 7 P. M., the northern sky appeared unusually bright, as if affected by lunar twilight. A large bank of vapor or thin cloud was discovered in the N., gently declining toward the E. and W. points of the horizon, and extending perhaps  $30^\circ$  in each direction. A similar bank of smaller dimensions was seen in the N. E., but less bright than the Northern. In a few minutes, the upper edges of both banks, but especially of the Northern, had a whiteness resembling the enlightened disk of the moon in its greatest splendor. The bank was at this time about  $12^\circ$  in height as determined by a theodolite. At 7h. 25m. a white streamer about  $2^\circ$  in width, arose from the bank about N.  $6^\circ$  E., and shot upwards through the Pole star as far as the zenith, being rather convex on the Western side. Others appeared immediately on both sides of it, passing through or near Ursa Major and Cassiopeia. The bank in the N. E. exhibited as yet no coruscations. At 7h. 45m., the columns had become larger and more numerous. One embraced Ursa Major, and another Cassiopeia, without farther extension horizontally. These were both of a brilliant crimson color, and remained nearly stationary for a considerable time, while the intervening column became faint. A westward motion was soon after observed in three principal columns, and about the same time a diminution in the brightness of the red ones. On this last occurrence, thin horizontal clouds of a red color were seen crossing the columns at an altitude of  $30^\circ$ , which however soon disappeared. When the northern bank possessed less energy, the Northeastern sent up to the zenith an intensely red column which continued to glow until nearly 9h., alternating however in brightness with those in the N. The Northern coruscations ceased about 9 P. M., and the other bank gave forth afterward but few and less vivid streamers. Before 10h. these had also ceased, yet the northern bank continued to exhibit its silvery edge; and another display occurred after midnight. The Northern bank attained an altitude of  $22\frac{1}{2}^\circ$  at 8h. 15m., and was about  $3^\circ$  higher at 8h. 40m.

“A very brilliant white column,  $1^\circ$  wide, and  $3^\circ$  W. of Arcturus, appeared to have undulations in the directions of its length

for a considerable time, as if caused by the gentle flow of a fluid on its surface. The first column from the N. was evidently either in or very near the plane of the magnetic meridian. The banks continued to increase along the horizon until 9 P. M., when they extended from the E. to within  $10^{\circ}$  of the W. The extremities were not bright, but had the usual appearance of light clouds. At this most westerly point, a shower had arisen about sunset which had been driven toward the S. W., and during the Aurora flashes of lightning at a great distance were occasionally seen. These became less and less vivid, the storm being driven away by a N. E. wind, blowing at the rate of three miles, and increasing to about six miles an hour during the phenomenon. The needle (about 10 inches long, and very sensitive,) vibrated through an arc of  $1^{\circ} 10'$ , while the columns were apparent, and on the following morning it had rested in an intermediate position only  $20'$  W. of its greatest eastern limit during the evening. The plate of an electrical machine, in an adjoining room, showed more than usual activity, giving after two turns, pungent and loud sparks to the knuckles three inches distant. The season has been exceedingly dry since the middle of July.

“Taking the direction of my transit telescope, I found the magnetic variation this day, (Sept. 7, 1839,) to be  $5^{\circ} 56'$  E.”

3. At *New Orleans, La.*, (N. lat.  $29^{\circ} 58'$ ) the Auroral display was quite conspicuous, and appeared so much like a large conflagration, that the fire engines were called out to extinguish the flames. The altitude of the streamers is not mentioned. No corona was probably formed at this place. Being desirous to ascertain how far south a corona was visible, I made special inquiries of a friend at *Claiborne, Ala.*, (N. lat.  $31\frac{1}{2}^{\circ}$ ) where the Aurora was very splendid, and learn that it could scarcely be said that a corona was formed there, although several times the Auroral columns were nearly united overhead. It is probable that a corona might have been seen within a hundred miles north of this.

4. *Carlyle, Ill.* (N. lat.  $38\frac{1}{2}$ ; W. lon.  $89\frac{1}{2}$ .) Prof. John Locke has published in the *Daily Missouri Republican*, St. Louis, Sept. 8, 1839, a description of this Aurora, from his own observations. The display was of the most splendid character, and the point to which the streamers converged was determined by him to coincide exactly with that to which the dipping needle is there directed. Dr. L. had a few days previous found the magnetic

dip at Louisville Ky., to be  $70^{\circ} 8'$ , and on the 8th of Sept., he ascertained the dip at St. Louis to be  $69^{\circ} 32'$ .\*

5. Throughout *England* the Aurora of September 3d, is described as most gorgeous. A confused and rhetorical account contained in a London paper of Sept. 4, (copied in N. Y. Journal of Commerce, Oct. 12,) states that the Aurora "had a most alarming appearance, and was exactly like that occasioned by a terrific fire. The consternation in the metropolis was very great, thousands of persons were running in the direction of the supposed awful catastrophe. \* \* \* At two o'clock in the morning (4th) the phenomenon presented a most gorgeous scene, and one very difficult to describe. The whole of London was illuminated as light as noonday, (!) and the atmosphere was remarkably clear. The southern hemisphere though unclouded was very dark, but the stars which were innumerable shone beautifully. The opposite side of the heavens presented a singular, but magnificent contrast; it was clear in the extreme, and the light was very vivid. There was a continual succession of meteors which varied in splendor. They apparently formed in the centre of the heavens, and spread till they seemed to burst; the effect was electrical, myriads of small stars shot out over the horizon, and darted with that swiftness towards the earth that the eye could scarcely follow the track; they seemed to burst also, and throw a dark crimson vapor over the entire hemisphere. \* \* \* Stars were darting about in all directions, and continued until 4 o'clock, when all died away."

From this description some have imagined that there was actually during this Aurora, a shower of shooting stars, similar to that seen on the 13th November, 1833. Although it is doubtless possible that such a meteoric shower may occur on the 3d of September, yet the statement above given, unsupported by other testimony, is altogether inadequate to establish the fact. This is evidently a loose and overcharged description, and it is entitled to a literal interpretation about as much as is an article professedly on the "November Asteroids," which was published in a London paper in November, 1838, in which it is asserted that "several stars of an ordinary size" were seen "shooting *from their original spots*, and falling apparently to the earth."

\* The statement of the altitude of the corona as observed in Brown Co., Ill. (p. 147 of this Journal,) is doubtless incorrect. The estimate was probably made by the eye; and in such circumstances an error of even  $17^{\circ}$  is not surprising.

ART. VII.—*Abstracts of Meteorological Observations made at St. Johns, Newfoundland, and at Canton, in China: with some Notice of the Half Yearly Inequalities of Atmospheric Distribution, which appear in these Observations; by W. C. REDFIELD.*

THE annexed summary of meteorological observations at St. Johns, was kindly furnished by Joseph Templeman, Esq., having been printed by him for circulation. The summary for ten years at Canton, in China, was obligingly forwarded by John Slade, Esq., and has appeared in the Canton Register. A comparative half yearly analysis of these observations, and of those made by me at New York, is herewith submitted.

*Observations at Newfoundland.*

The observations at St. Johns include a period of five years, ending with 1838. The barometer, we are informed, is 140 feet above the sea level. The annual mean of the barometer, deduced from these observations, is 29.735 inches; while the mean of my own observations near the sea level at New York, for the same period, is 30.111 inches: \*—showing a difference in the mean atmospheric pressure of 0.376 inch; or more than one third of an inch of the barometric column. † Part of this difference, equal to about 0.180, is due to the difference of elevation of the two instruments; which when added, gives 29.915 inches for the sea level at St. Johns. If we assume the annual mean at the two places to be equal, there still remains a discrepancy of 0.196, or  $\frac{1}{5}$  inch, nearly, to be accounted for. In the absence of more definite information concerning Mr. Templeman's barometer, I am inclined to ascribe this discrepancy to the stretching of the leather which forms the bottom of the cistern, while in a moist

---

\* At a mean temperature of the mercury of about 68° or 70° F.

† I had recently an opportunity to compare the adjustment of my glass-cisterned barometer with the standard of the Royal Society, as transmitted by means of one of Newman's best iron-cisterned barometers, in the care of Lieut. Riddell, R. A., who has charge of the Magnetic Observatory which is now established in Canada. The height of the mercury by the scale of my instrument was found to exceed that of the standard barometer by a mean of 0.015 inch: which falls a little short of the permanent allowance I had made for the capillarity of the tube; the diameter of which is four fifteenths of an inch.

state, or while screwed up for safe transportation ; which are the most common causes of error in the adjustment of the scale to its proper height in barometers. Now as the mean annual pressure at the two places, at the sea level, is presumed to be nearly equal, we may add 0.376 inch, or three eighths of an inch, to all the results in Mr. Templeman's summary, for the purpose of comparison with the observations at New York.

With this assumed correction, we find that the mean height of the barometer at St. Johns, at the sea level, for the five *half years*, which include the months of November, December, January, February, March, and April, which takes in the winter period, is 30.039 inches : while the mean of the five half years which include the remaining months, is 30.184 inches. The mean pressure of the half year which includes the summer, we here perceive, *exceeds* that which includes the winter, by the amount of 0.145 inches ; or *one seventh of an inch*, nearly.

At New York, I find on the contrary, that the mean pressure of the half year which includes summer, for the same period of time, is *less* than that of the half year which includes the winter by 0.044 inch ; or something less than  $\frac{1}{20}$  of an inch : the mean for the winter half years being 30.133, while that for the summer period is 30.089. There appears no reason to doubt the accuracy of these results, in either case.

This analysis shows also an average difference of pressure at the two places for the same half year ; assuming the same annual mean : the inequality for the winter period being 0.094 inch, or nearly one tenth of an inch greater at New York than at Newfoundland ; while for the half year that includes summer, which exhibits the least fluctuations of pressure, and in which the equilibrium of the atmosphere is least disturbed by violent winds, the mean pressure is 0.095 inch greater at St. Johns than at New York.

It appears from the table, that the extreme *range* of the barometer at Newfoundland during the five years was 2.54 inches, or *two and a half inches*, nearly : while at New York for the same period, as corrected one fortieth for variation in the cistern, it was 2.265 inches ; or *two and a quarter inches*, nearly. The difference of latitude in the two places is  $6^{\circ} 52'$  ; the difference of longitude  $21^{\circ} 22'$  ; both places being on the western margin of the same ocean.



Observations at Canton.

If we now turn to the observations at Canton, we shall find the mean half yearly results for the same months, for ten years, as follows: viz.

Mean pressure of ten half years, November to April inclusive,	30.140 inches.
Mean pressure of ten half years, May to October inclusive,	29.868 inches.

Thus, at Canton the mean pressure of the winter half year exceeds that of summer, 0.272 inch, or more than *one fourth of an inch*. The latitude of Canton is 23° 07' N., being nearly in parallel with the north side of Cuba and part of the Bahama Islands: lon. 113° 14' E. The mean height of the barometer for the ten years observed at Canton, is 30.005 inches; but if we add a correction for an assumed elevation of 40 feet above tide, it will be 30.051 inches. We may infer, therefore, that there is little error in the adjustment of the scale of inches in this barometer.

Assuming the same mean annual pressure for Canton as at New York, the following comparison of the half yearly results at these two places may be instituted.

	Winter half year.	Summer half year.
Mean at New York,	30.133	30.089
Mean at Canton, as adopted,	30.246	29.974

Excess at Canton, 0.113 in. Excess at N. Y., 0.115 in.

The inequality at these places for the two periods, being the same in kind, but differing in degree by more than *one ninth of an inch*; the inequality being greatest at Canton.

If the results at St. Johns, Newfoundland, be compared in like manner with those at Canton, they will appear as follows:

	Winter half year.	Summer half year.
Mean pressure at Canton,	30.246 in.	29.974 in.
Mean do. at Newfoundland,	30.039	30.184

Excess at Canton, 0.207 in. Excess at N. F., 0.210 in.

These results are different in kind and the inequalities greater than those between Canton and New York: the mean inequalities being more than *one fifth of an inch*.

The inequalities of pressure in the opposite seasons at Canton will appear more strongly, if we omit the months of April and October, which have nearly the mean pressure of the year. We have then a mean for the five months of the northerly monsoon or winter period, of 30.178 inches: the mean for January being as high as 30.24 inches. But for the five months of the southerly monsoon we find a mean of only 29.836 inches; and the mean of July and August is still lower, being 29.80 inches. We have thus an inequality of 0.342 inch: more than *one third of an inch*, for the average period of the two monsoons; while as between January and July and August, in the opposite monsoons, we have the still greater difference of 0.440 inch; approaching to *half an inch* of the barometric column. I have alluded to this extraordinary inequality of barometric pressure, on a former occasion.\*

In regard to the prevalent winds at Canton, and their state of humidity, we perceive that the greater number of rainy days and the greatest depression of the barometer, accord nearly with the period in which the southerly monsoon most steadily prevails. The smallest number of rainy days and greatest atmospheric pressure accord equally with the prevalence of the northerly monsoon.

At New York, and also at Newfoundland, the tendency of the winds and the distribution of rain, throughout the year, is probably more uniform than at Canton; but the region about Newfoundland is believed to be somewhat remarkable for its humidity, particularly in the summer months; while, as we have seen, in the latter season the barometer maintains more than its average elevation.

In view of all the facts presented, therefore, there appears no good reason to ascribe to hygrometric considerations, in any considerable degree, the great differences in the equality of atmospheric distribution which are here brought to our notice.

New York, December 3d, 1839.

---

\* See this Journal, Vol. xxxiii, p. 264.

1. St. Johns, Newfoundland. Meteorological Table for five years ending Dec. 31, 1838. From observations made by Joseph Templeman of the Colonial Secretary's Office.

	JANUARY.		FEBRUARY.		MARCH.		APRIL.		MAY.		JUNE.	
	Therm.	Barom.	Therm.	Barom.	Therm.	Barom.	Therm.	Barom.	Therm.	Barom.	Therm.	Barom.
<b>1834.</b> Mean of the Month, Extremes, { Highest, { Lowest, Mean of Extremes, Days on which ex- tremes occurred,	degs. 17 1/4 36 —7 14 1/2 18 1/2 31st	inches. 29.63 30.30 30.60 29.45 30th 31st	degs. 16 3/4 40 —14 13 6th	inches. 29.75 30.35 28.50 29.425 11th & 16th 27th	degs. 20 1/2 46 —6 20 3d	inches. 29.73 30.30 28.80 29.55 8th & 25th 14th	degs. 30 1/2 46 13 29 1/2 25th 17th	inches. 29.60 30.42 28.80 29.61 5th 20th	degs. 39 1/2 57 24 40 1/2 10th 30th	inches. 29.85 30.40 29.35 29.87 16th 1st	degs. 49 1/2 76 30 48 8th 18th	inches. 29.87 30.27 29.35 29.81 6th 15th
<b>1835.</b> Mean of the Month, Extremes, { Highest, { Lowest, Mean of Extremes, Days on which ex- tremes occurred,	24 1/2 44 —5 19 1/2 1st 4th	29.67 30.20 28.75 29.47 6th 1st	25 1/2 47 0 23 1/2 28th 3d	29.81 30.44 28.78 29.61 15th 5th	22 1/2 47 —2 22 1/2 2d 12th	29.75 30.49 28.62 29.55 8th 18th	33 1/2 51 19 35 7th & 8th 5th	29.61 30.17 28.95 29.56 5th 15th	39 1/2 60 25 42 1/2 30th 23d	29.64 30.30 29.09 29.70 13th 3d	48 73 29 51 21st & 28th 10th	29.83 30.11 29.35 29.73 28th 5th
<b>1836.</b> Mean of the Month, Extremes, { Highest, { Lowest, Mean of Extremes, Days on which ex- tremes occurred,	26 48 4 96 25t 17th	29.81 30.42 29.04 29.73 24th 26th	24 1/2 48 1 24 1/2 22d 27th & 28th	29.78 30.52 28.78 29.65 20th 15th	23 1/2 55 2 28 1/2 11th 19th	29.77 30.30 28.90 29.60 10th 2d	31 1/2 60 14 37 22d 12th	29.81 30.37 29.20 29.78 21st 2d	37 66 18 42 19th 3d	29.76 30.10 29.30 29.70 27th 5th & 8th	45 80 27 53 1/2 7th 3d	29.85 30.22 29.20 29.71 6th 16th
<b>1837.</b> Mean of the Month, Extremes, { Highest, { Lowest, Mean of Extremes, Days on which ex- tremes occurred,	26 3/4 46 6 93 23d 28th	29.29 29.95 28.76 29.30 8th	20 1/4 40 —6 17 28th 7th	29.46 30.04 28.67 29.35 27th 13th	21 1/4 45 9 23 1/2 11th 5th	29.89 30.44 29.15 29.80 5th 27th	37 1/4 60 25 42 1/2 23d 24th	29.50 30.05 28.80 29.42 24th 6th	37 1/2 65 25 47 1/2 7th 2d	29.64 30.22 28.95 29.58 20th 2d	45 1/2 73 29 51 22d & 25th 3d & 20th	29.67 30.02 29.34 29.68 1st 12th & 30th
<b>1838.</b> Mean of the Month, Extremes, { Highest, { Lowest, Mean of Extremes, Days on which ex- tremes occurred,	22 1/2 49 —6 22 1/2 8th 24th	29.87 30.72 28.80 29.76 26th 31st	17 1/2 40 0 20 17th 17th	29.13 29.78 28.30 29.04 14th 17th	26 47 3 25 16th 4th	29.71 30.48 28.65 29.56 22d 28th	33 1/2 61 12 36 1/2 20th 24th	29.72 30.27 28.85 29.56 30th 2d	41 1/2 65 29 46 1/2 30th 6th	29.85 30.21 29.31 29.80 31st 16th	52 73 30 51 1/2 11th & 26th 19th	29.79 30.30 29.35 29.82 1st 4th
Monthly means for 5 years,	29.654		29.586		29.770		29.648		29.748		29.802	

1. St. Johns, Newfoundland. Meteorological Table for five years ending Dec. 31, 1833. From observations made by Joseph Templeman, of the Colonial Secretary's Office.

	JULY.		AUGUST.		SEPTEMBER.		OCTOBER.		NOVEMBER.		DECEMBER.	
	Therm. degs.	Barom. inches.	Therm. degs.	Barom. inches.	Therm. degs.	Barom. inches.	Therm. degs.	Barom. inches.	Therm. degs.	Barom. inches.	Therm. degs.	Barom. inches.
<b>1834.</b>												
Mean of the Month,	58	29.84	56	29.86	47	29.95	47	29.95	33	29.68	25	29.79
Extremes, { Highest,	86	31.28	78	30.25	74	30.32	70	30.30	52	30.13	45	30.67
Extremes, { Lowest,	37	21.48	36	29.40	36	29.50	28	29.40	15	29.11	4	28.98
Mean of Extremes,	61	21.88	57	29.82	55	29.91	49	29.85	33	29.62	24	29.82
Days on which ex- { Highest,	15th	20th	25th	31st	3d & 4th	14th	10th	12th & 19th	15th	17th	15th	19th
tremes occurred, { Lowest,	1st	1st	10th	8th & 14th	16th	7th & 10th	26th	10th	29th	8th	29th	7th
<b>1835.</b>												
Mean of the Month,	58	29.80	61	29.87	55.56	29.90	46	29.98	31	29.58	24	29.52
Extremes, { Highest,	80	30.27	81	30.25	77	30.27	70	30.45	54	30.15	46	30.15
Extremes, { Lowest,	37	29.37	43	29.57	35	29.15	25	29.38	14	28.97	8	28.50
Mean of Extremes,	58	29.78	62	29.91	56	29.71	47	29.91	34	29.56	27	29.32
Days on which ex- { Highest,	19th	21st	11th	16th	1st	13th	9th	20th	17th	15th	27th	20th
tremes occurred, { Lowest,	12th	17th	7th	17th	16th	3d	27th	12th	22d & 25th	21st	24th	3d
<b>1836.</b>												
Mean of the Month,	55	29.83	57	29.88	49	29.80	43	29.80	36	29.62	27	29.80
Extremes, { Highest,	81	30.11	78	30.14	74	30.33	71	30.30	61	30.23	47	30.55
Extremes, { Lowest,	30	29.35	40	29.43	30	29.31	22	29.30	20	28.24	2	29.05
Mean of Extremes,	55	29.73	59	29.78	52	29.82	46	29.80	40	29.23	24	29.80
Days on which ex- { Highest,	12th & 14th	12th	2d	6th & 12th	5th	7th	6th	2d	16th	9th	31st	25th
tremes occurred, { Lowest,	2d	20th	29th	9th	24th	20th	31st	28th	19th	30th	23d & 24th	1st
<b>1837.</b>												
Mean of the Month,	53	29.63	56	29.77	51	29.80	40	29.86	37	29.73	23	29.49
Extremes, { Highest,	72	29.98	78	30.13	75	30.20	63	30.46	60	30.28	37	30.25
Extremes, { Lowest,	33	29.20	41	29.14	33	29.35	21	29.23	18	28.98	6	28.65
Mean of Extremes,	52	29.59	59	29.63	54	29.77	42	29.84	39	29.63	21	29.45
Days on which ex- { Highest,	16th & 28th	31st	3d	14th	11th	22d	28th	20th	23d	1st	26th	28th
tremes occurred, { Lowest,	12th	10th	31st	23d	29th	13th	19th	2d	30th	7th	17th & 27th	12th
<b>1838.</b>												
Mean of the Month,	55	29.75	55	29.74	52	29.84	44	29.72	31	29.72	25	29.66
Extremes, { Highest,	79	30.25	76	30.16	76	30.36	66	30.10	59	30.22	47	30.52
Extremes, { Lowest,	38	29.34	33	29.23	32	29.23	25	28.98	12	28.97	2	29.00
Mean of Extremes,	58	29.80	54	29.60	52	29.80	45	29.54	35	29.60	24	29.76
Days on which ex- { Highest,	25th	25th	24th	30th	3d	13th	3d	11th	6th	11th	6th	31st
tremes occurred, { Lowest,	21st	29th & 31st	3d	27th	9th	20th	30th	29th	24th	25th	20th	19th
Monthly means for 5 years,		29.770		29.824		29.840		29.862		29.666		29.652

“*Remarks.*—St. Johns is in lat.  $47^{\circ} 34' 3''$  N. and lon.  $52^{\circ} 38' 30''$  W. The height of the barometer above the level of the sea is 140 feet. From the foregoing table it will be observed that in the peculiar climate of this Island the mean temperature of the month of September is very little below that of July, whilst that of October is nearly equal to that of June. The first fortnight in February is usually the severest part of the winter—in which period the thermometer in some seasons sinks to from  $10^{\circ}$  to  $20^{\circ}$  below the *zero* of Fahrenheit. It will also be seen that in the year 1836 there was only one month (August) in which frost did not occur. The temperature above shown is the mean of the maximum and minimum of every 24 hours commencing at 9 A. M. It generally happens, therefore, that the greatest degree of cold occurs on the *morning following* the date here shown. Where two dates are mentioned, it shows, of course, that the same *extreme* occurred on both days.

“As regards the barometer, it may be observed that it is scarcely ever steady for 6 hours together. Its oscillations are often great and sudden, sometimes as much as from  $1\frac{1}{2}$  to  $2\frac{1}{2}$  inches, in the course of 36 hours. These are greatest and most frequent in the winter months—during which period almost every variety of weather is experienced in the course of every *four* days. The barometer attains, during that interval, to the height of from 30.20 to 30.40 inches, the weather being calm and serene and the cold severe—the mercury soon indicates a change—a breeze springs up from the S. E. and increases to a gale with snow and drift. This is most frequently, although not always, succeeded by heavy rain from S. W. (the temperature, which in the morning was perhaps near or below *zero*, rising to above 40 degrees) and in a few hours the wind, which generally subsides after the rain, suddenly shifts to the N. W., with a strong breeze. The barometer (which on these occasions falls rapidly and almost always sinks to several 10ths below 29 in.) then begins to rise again, as rapidly as it had before fallen. At the turn of the barometer, the gale increases for a few hours, and then gradually subsides. The barometer very rarely rises above 30.50 inches, and has never, except on one occasion, during the above period of five years, fallen as low as 28.50 inches.”

2. Canton, China. Table showing the Mean of the Monthly Range of the Thermometer and Barometer, from 1829 to 1838, both inclusive, with the predominance of N. and S. Winds, and number of Rainy Days, and the Average Monthly Range of the Thermometer and Barometer, and number of Rainy Days in 1838.

Month.	1829 to 1838.										1838.			
	Therm. Barom.	Winds		Rainy Days.	Mean of night and noon.		Mean of night and noon.		Lowest.    Night.	Highest.    Noon.	Barom.	Rainy days.		
		N.	S.		of night.	of noon.	Night.	Noon.						
January,	52½	25.	6	50	59	54½	39	12th	73	30.21	2			
February,	55	30.17	18.	7	55	61	32	8th	72	30.20	7			
March,	62½	30.11	17.	14	61	68	46	6th	76	30.05	10			
April,	70	29.96	12.	18	67	72	50	9th	85	29.96	15			
May,	77	29.89	10.	21	76	83	67	4th	89	29.88	19			
June,	81	29.87	4.	26	78	85	72	13th	92	29.83	0			
July,	83	29.80	6.	25	81	89	76	11th	96	29.80	17			
August,	82	29.80	10.	21	80	84½	77	24, 29th	94	29.83	11			
September,	80.033	29.82	17½.	12½	77	85½	72	13, 25th	93	29.84	14			
October,	73¼	30.03	21.	9.	67	78	60	11th	86	29.79	1			
November,	65½	30.17	23.	10.	59½	70½	44	26, 27th	78	30.19½	3			
December,	57.134	30.20	25½.	6½	53¼	63½	32	18th	72	30.22	7			

The above observations were made from a self-registering instrument, by Gilbert, of London. The instrument is placed in the verandah of a house in Canton, built on a stone foundation, on the side of a creek, which washes the wall on the eastern side. The verandah has a northerly exposure, and is elevated about thirty feet from the ground; the instrument is suspended about five feet from the marble floor of the verandah and one inch from the plastered brick wall.

ART. VIII.—Abstract of a Meteorological Journal for the year 1839, kept at Marietta, Ohio, Lat. 39° 25' N., and Lon. 4° 28' W. of Washington City; by S. P. HILDRETH, M. D.

Months.	THERMOMETER.				Fair days.	Cloudy days.	Rain and melted snow.		Prevailing winds.	BAROMETER.		
	Mean temperature.	Maximum.	Minimum.	Range.			Inches.	100ths.		Maximum.	Minimum.	Range.
January,	35.33	66	-3	69	13	18	2	30	N. N. E., S. S. E.	30.00	28.95	1.05
February,	36.33	70	7	63	21	7	2	00	W. N. W., S. & S. W.	29.82	28.70	1.12
March,	42.66	74	-4	78	21	10	2	25	S. S. W. & N. W.	29.72	28.95	.77
April,	57.53	84	26	58	24	6	1	44	S. S. E. & N.	29.65	28.96	.69
May,	64.33	92	32	60	21	10	4	16	S. S. E. & W. N. W.	29.55	28.98	.57
June,	68.33	90	45	45	16	14	4	33	S. S. W. & W.	29.50	29.10	.40
July,	72.33	92	50	42	21	10	6	04	S. S. W. & W.	29.55	29.12	.43
August,	69.00	88	53	35	26	5	2	04	E. S. E. & N.	29.63	29.15	.48
September,	59.66	80	32	48	18	12	3	25	S. S. W., W. & E.	29.70	29.05	.65
October,	50.64	84	26	56	26	5	0	25	S. & S. E.	29.75	29.20	.55
November,	38.00	59	17	42	15	15	2	50	S. W. & N. N. E.	30.01	28.88	1.13
December,	36.33	57	7	50	6	25	2	46	W. N. W. & N. E.	29.52	28.80	.72
Mean,	52.54						33	32				

Remarks on the year 1839.—The mean temperature for the year 1839 is 52.54°, which is two degrees greater than that of 1838, and may be considered as about the mean for this place. The quantity of rain and melted snow is 33.32 inches; and is two inches less than that of the preceding year, which was considered as a remarkable one for the little rain that fell in the latter half of it, and is about nine inches less than the mean amount for this region. In the past year, however, the distribution of rain has been very equal, so that every month had its due share in such seasonable showers as to afford a good supply for vegetation, and the crops of all kinds of grain and grass were never more abundant. The mean temperatures of the four seasons are as follows, the winter being made up with the aid of December, 1838, which properly belongs to it.

Winter months, 33.27°                      Spring months, 54.84°  
 Summer months, 69.88                      Autumn months, 49.43

The winter was milder than that of 1838 by three degrees, and the spring warmer by five degrees. The summer was cooler by nearly five degrees, and far more pleasant and fruitful. Autumn varied but little from the preceding one. The pear and cherry tree were in blossom on the 11th of April, the apple on the

17th, and Cornus florida on the 24th. An unusual depression of temperature on the 4th of March, sinking the mercury to four degrees below zero, destroyed nearly all the blossom buds of the pear and the peach. Apples, and all the smaller fruits, were abundant. The severe storms in December, which visited the coast in the eastern states, were but slightly felt here. On the 15th, 22d, and 28th of December, we had falls of snow, accompanied with but little wind, amounting in all to about a foot. Thirty miles west of this place the ground has barely been covered with snow, to this time, the twentieth of January, while E. and S. E. as we approach the mountain ranges, it has fallen to a depth unprecedented for many years. The same great abundance of snow seems also to have attended the storms in the middle and eastern states.

January 20, 1840.

ART. IX.—*Description of a New Compensating Pendulum*; by  
WILLIAM GWYNN JONES, A. M.

DURING the latter part of the past year, while engaged in some interesting astronomical observations which required considerable accuracy, it was indispensable to procure a time-keeper whose rate would not be affected by the variations in the temperature of the weather, to which all such machines, of ordinary construction, are liable. The expensiveness of a chronometer which could be relied upon for such a purpose, rendered a resort to some more economical instrument desirable, if it could be depended upon. The gridiron pendulum as well as the mercurial one, both of which have been designed to effect this object, were found unsatisfactory; the former from the difficulty of procuring an exact adjustment of the different rods of which it is composed, so as to produce the desired counterbalancing expansion and contraction, and the mercurial pendulum proving upon experiment too sensitive to be relied upon. Under these circumstances, I contrived a simple arrangement for a pendulum, acting upon the principle of the lever, which performed with so much accuracy that I have been induced to present it to the notice of the readers of the American Journal, believing it will not prove uninteresting to those engaged in scientific investigations requiring great uni-



formity of action in a time-keeper. The arrangement of the parts is so simple as to be readily understood by any skillful workman, and as it is entirely free for the adoption of any one who may prefer its construction, I have prepared a description and diagram to render it intelligible.

Fig. 1, shows the whole pendulum, the dotted lines representing similar parts to those on the opposite side, and are introduced to render the drawing more easily understood; *a* is a similar spring to that which is attached to the pendulum of an ordinary eight-day clock, and is firmly attached to the perpendicular brass bar *b*. Through *b* there is the usual opening for the guy-wire, which gives motion to the pendulum. This bar is firmly affixed to the transverse bar *c* either by riveting or soldering. On each end of the bar *c* there is attached a brass rod *d, d*, and one inch from each of these there is also affixed a steel rod *e, e*. These four rods pass through the bar *p*, which is intended merely to preserve them in their proper position, and is attached to the two brass rods by a pin passing through both, while the steel rods are allowed to move freely through the holes. At *f*, a transverse bar or lever is affixed to *d* by a loose pin passing through them, and the same attachment is made to the steel rod *e* at *g*. This bar is four inches long, three inches of which extend from *g* to *h*, and a similar one is attached to the dotted rod *d* and extends on the opposite side. At *h* there is another loose attachment to the rod *i*, which is of steel, and which is again affixed to the bar *k*. At *k* there is a permanent bar *m*, which passes through the weight *o*, and has the usual adjusting screw *n* at the bottom.

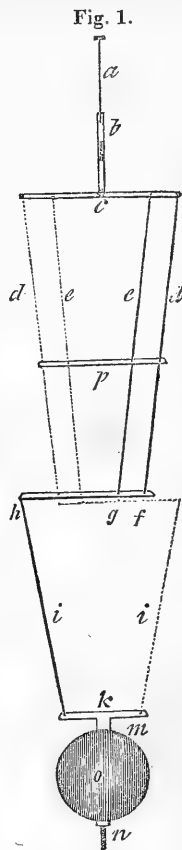

*Rationale.*—Suppose that by an increased temperature of  $20^{\circ}$ , the steel rods *e, e*, are expanded in length  $\frac{1}{16}$  of an inch. The rods *d, d*, being of brass, and a small fraction larger than the steel, will expand  $\frac{1}{8}$  of an inch by the same increase of temperature, it being an established theory with the best French chemists,

that the relative effect of the temperature upon the two metals is as 3 to 5, or nearly double the expansion in brass as in a steel rod of similar size. The outer rods then have expanded in length  $\frac{1}{6}$  of an inch more than the inner rods. It will be apparent from a slight inspection of the drawing, that as the brass rod  $d$  and the steel one  $e$  are attached by a connecting pin to the transverse bar  $f h$ , that by  $d$  expanding more than  $e$ , that  $f h$  becomes a lever,  $g$  being the fulcrum, and as  $g h$  is three times as long as  $f g$ , consequently if  $d$  be expanded  $\frac{1}{6}$  more than  $e$ , the end  $h$  will be elevated  $\frac{3}{6}$  of an inch, and thereby raise the weight  $o$   $\frac{1}{2}$  of an inch more than the expansion of  $d$  has depressed it. This increased elevation is intended to allow that the spring  $n$ , the bar  $b$ , the rod  $i$ , and the bar  $m$ , unitedly, will expand  $\frac{1}{2}$  of an inch also, and if so, it must be apparent that the whole pendulum has preserved its equilibrium and remains precisely of the same length as if no change had taken place in any of its parts.

Fig. 2, shows a perpendicular view of the transverse bar  $f h$ , arranged so as to admit the corresponding bar for the other side to work freely, and at the same time preserve the four upper rods upon a line with each other, which, as the levers intrude within each other, could not be done without the recess as shown in the section. The same letters correspond to the same parts in Figs. 1 and 2. The dotted lines in Fig. 2, are intended to show the relative position of the lever which is attached to the dotted line  $d$ , Fig. 1, in regard to the other.

Baltimore, Md., 1834.

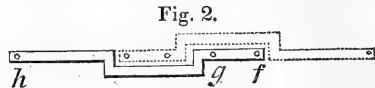

---

ART. X.—*Some account of ITHIEL TOWN'S improvement in the construction and practical execution of Bridges, for Roads, Railroads, and Aqueducts.*

THE improvement which is described in the following paper, was secured by patent in 1835, and is intended as a general system for the construction of bridges, whether of wood entirely, or of cast or wrought iron, over rivers, creeks, harbors, &c., where required for any kind of conveyance; either with wide openings between the piers, of two hundred to four hundred feet, or with

smaller openings ; whether the piers and abutments are of stone, framed timber upon mud-sills, or piles driven into the bed of the river.

Economy of expense, great strength, durability, and a level road-way, united in a general system of building bridges, &c., suited to any part of the United States, which may be constructed of such materials as can be obtained in any part of the country, are what is attempted, and it is confidently hoped have been accomplished.

The subject is here explained in a general manner, with remarks, also, on some of the disadvantages which have heretofore attended the other modes of construction, which, by this improvement, have been guarded against or obviated.

A quarto pamphlet has just been published, and may be had at the principal bookstores in New York, giving a very minute description and explanation, by engravings and otherwise, of the principles, as well as the practical and mechanical execution, in detail, of all that appertains to the construction of the patentee's latest improvements.

A model may be seen at the Patent Office, Washington City, and at the American Institute, back of the City Hall, City of New York, at which latter place the patentee may be found, or letters post-paid, directed to him there, will be promptly attended to.

The great and increasing use of wooden bridges, and the frequent obstruction by freshets and other accidents, in this extensive country, intersected with its rivers, immense both in number and magnitude, render unnecessary any apology for improvements introduced ; especially if either the great annual amount of capital expended, or the important daily use of bridges for roads, railroads, &c., be considered.

The patentee's former improvement in bridges, in 1821, was published in the American Journal of Science of that year, and subsequently in a pamphlet, but too brief for that correct illustration of the subject which is to be found in the pamphlet now referred to, for this last improvement, or in the general manner which here follows in describing it. It consists principally in the introduction of two, or in some cases more, series of truss-braces, diamonds or lattices, by which two very important advantages have been realized, neither of which, it is believed, could be realized to an equal extent in any other manner, viz.

1st. An immense additional strength may be obtained, with much less quantity of plank in the string-pieces, in proportion to the strength, stiffness, and durability thereby gained ; especially, as double the number of tree-nails pass through all the string-pieces which are in the middle of each truss, or between the two series of truss-braces, and thereby secure the splices of the plank composing the string-pieces, in a much more effectual manner, against their *tension strain*, which is great, and therefore requires the best possible security to counteract it. This manner is effectual, even without the aid of iron, to a greater degree than is practicable in any other manner known in practical mechanics.

2. The great evil, so much complained of in the first mode, by all bridge builders, viz. of keeping the trusses straight, or from warping, twisting, or leaning sidewise, is by this improvement entirely done away ; it being more easy to keep the trusses in their true position, and have them remain so, than in any other mode ; because, first, the trusses are of greater thickness, and therefore less liable to admit of any *curve*, twisting, or deviation from their true position. And secondly, because the trusses run horizontally, they are less liable, even with the same thickness, to get out of their straight and vertical position, than would be the case with the arched bridge, which, by rising higher at the crown of its arches, gives much greater leverage to its own gravity, and to the winds, for a deviation from its true position, to that of a curved or twisted one, which might impair its strength or safety.

It may be stated, as it is believed by the patentee, that with this last improvement, his mode of construction, for all important purposes, is such as to avoid all possible objections of every kind, for whatever purpose it may be used ; but more especially for bridges of very wide spans, as also for railroads and aqueducts, which indispensably require great strength, and a level road-way, which other bridges would not admit of, to an equal degree, however much might be expended in their construction.

The patentee is aware, that some engineers have by some means obtained the opinion, that this improvement, though good, and very strong for a proper extent of span, as well as more economical than other modes, is not as well suited to very wide spans, as possibly some other mode might be ! There could not, most certainly, be formed an opinion more erroneous. With

twenty years' experience in bridges, the *patentee* feels confident of no one fact, in science and practical mechanics, more than this, that the wider the spans are adopted, the greater, by far, is the strength and durability of this last improvement, when suitably executed to such width of span, compared with any other mode of construction now in use. If, indeed, this were not the fact, beyond a doubt, in the mind of the *patentee*, he certainly not only would not trouble himself with its introduction into public use, but would promptly admit that this, or any other mode not possessed of such principles, would neither be entitled to the credit of a "general system," or be possessed of any other advantages worthy of public confidence or patronage.

It has ever been his opinion, even from the *first*, that this mode of combining materials, when properly perfected by practical experience, was such as not only to possess all the advantages that science could render in its mathematical principles, but also to have the immense advantages of the application, in its mechanical execution, of materials, which may be procured in any part of the country, with the greatest ease, dispatch, and economy.

It is also found, in a long practice of this particular principle, that the advantages in the mechanical execution, by using light timber, combined of sawed planks, and by a distribution, therefore, of the strain or weight to be overcome, into such an almost innumerable number of nearly equal parts, that the strength of any material, even the *softest pine*, becomes abundantly sufficient to sustain its portion of such strain; and the mode, also, of securing each and every part of the construction, without the aid of iron, becomes practicable—so amply sufficient as to ensure strength, rigidity, and durability, to a degree, most certainly not to be even very nearly approached by any other system of combination and mechanical execution in practice. The great and equal distribution of the material, in the sides or trusses of the bridge; the immense number of intersections or crossings of the timber, in each truss, which are, each and all of them, thoroughly secured by four, three, or two *hard wood* tree-nails, of two inches in diameter, according as each particular intersection may require, in the importance of its situation for the purpose of bearing its part of the strain; and, lastly, and by no means the least important, the advantage gained in this mode, which has never been

accomplished or claimed for any other arrangement, viz. of having all the strain or weight, of every description, which the bridge can be made to receive or sustain, whether it be its own weight, which is generally the greatest, or any other, such as droves of cattle, or trains of cars, with locomotives, &c., so distributed, that in all cases such strain or weight is sustained, in due proportion, by every piece of plank composing the sides or trusses, in a direct end-grain strain, viz. either a tension or pulling strain, or a thrust or pushing strain. In both instances, of course, therefore, the strain is exactly in the direction of the length of the pieces. The great advantages of this one particular point, in the construction of bridges, is very important; and in wide spans, this importance is increased to a degree that can only be duly appreciated by the most experienced and sound practical engineers.

That the plank composing the trusses is liable to shrink, is true; but as the strain is, in all important respects, in the direction of the length of such planks, it is therefore evident, that such shrinking cannot produce any effect, unless it be to do good, by holding more firmly to the three or four tree-nails, which pass through each plank, in several places, and, of course, cannot be affected in any other manner than to be more tight on the tree-nails, in the direction of the width of the plank, but without alteration in the direction of their length, which alone could have the least effect to do injury. What is stated in regard to shrinkage, is also true, to a greater extent, in that of the mashing or compression of timber; in this arrangement of construction, there is not the least tendency whatever to the compression of any of the plank composing the trusses, by any strain to which they are liable in their own support, or the support of any other weight; except, only, where the trusses rest upon the piers, and this only by its own gravity, and not by any strain or compression occasioned by the mode of construction, as is the case in all bridges of other modes of construction, where posts are introduced for the insertion of braces, by tenons and mortices, and where, of course, the accumulation of shrinkage, and the compression of the posts, by a great strain on a few points, both contribute to operate towards the weakening of the bridge, so as to give it a vibratory motion, which, in time, is sure to do violence to a bridge, and, in the end, destroy it, or occasion large repairs, and the con-

stantly tightening of wedges and other parts ; which, however, cannot possibly raise a bridge which has once settled, or become weak, from such looseness of its parts, and the consequent vibrations thereby occasioned.

Nor is cast iron, whatever expense for it may be incurred, any more than a very partial remedy ; for still, the wood will both shrink and be, by the great pressure of the parts, compressed ; so that in a span of 100 feet, if made in a shape of parallelogram trusses, with a tie-string piece at the bottom, to prevent a horizontal thrust or pressure against abutments and piers ; and, as usual in bridges depending on exact and expensive execution of carpentry, with king-posts at every eight or nine feet distance, and filled up between them, with any kind of double braces, whether with iron footings, or even without them ; still the shrinkage and compression, *both*, of each post, must take place, and, consequently, the accumulation of shrinkage and compression of all the posts. Some eleven or twelve, in the hundred feet span, will operate to one end, viz. to give the bridge motion, by use, and a depression to a line below its first position. By wedges, carefully driven, and with the most prompt attention at all times to them, a part of the evil may be prevented, but by no means can it be fully prevented, even in so small a space as 100 feet. When spans, however, of 150, 175, 200, and from 200 to 300 feet, are required, and, of course, the strength requisite for the support of such a span, so very much greater, while, at the same time, the accumulation of shrinkage and compression of timber becomes twice or thrice as great as in the span of 100 feet, from the fact that so many more such posts are necessary to its construction, it must be, beyond all doubt, perceived, that such constructions, from these disadvantages in their execution, by which they are inevitably exposed to such disadvantageous frailty in the material, for which there is no remedy, and which the mode of using or combining does not provide against, or remedy in the execution, must be defective and of short duration.

Hence it appears, to a certainty equal to mathematical, that, at no reasonable expense can there be bridges of the other modes of construction of wide spans, constructed with an arrangement of the materials, such as to admit so much pressure or strain, on comparatively a few points ; and, at nearly all of them, the strain, depending so much on a pressure against the side grain of a ma-

terial so frail, and so certain to be operated upon by two such formidable evils as shrinkage and compression, and that, too, in the accumulated quantity of from twenty to thirty posts, and twice or thrice the number of braces, all of which also admit of the same evil, to a very considerable extent. Time has shown, and will in future show, the truth of these observations, to such an extent as will fully remedy the evil.

The original mode of using the arch, by Burr, Wernwag, Field, and many others, it must be admitted, had the very important advantage of sustaining the most important portions of the strain, in the direction of the length of the materials, as in the arch-pieces, which, indeed, were the main support of the structure. In these constructions, in which the arch is so conspicuous for the strength and beauty of the superstructure, (for beautiful, it must be admitted the arch is, when applied with good taste,) there seem to be evils too great to be overcome, by the most profound science, or the most refined practical experience in execution. Some of which are—

1st. The great expense of construction, too great, by far, to be incurred, except at a few points, where the great importance of the work, and a command of great wealth can be united.

2d. The great horizontal thrust against abutments and piers, requires great expense in its construction; and even then, when an accident destroys one arch, the others, by their own gravity, destroy not only themselves, but their piers also, to any length to which the bridge may extend. In bridges of many arches, therefore, it would be fearfully imprudent to construct them in this manner, even if means might be had for the purpose. Two bridges of this kind were erected over the Schuylkill, at Philadelphia, many years ago; one of three arches, the other of one arch; and although so short, each one cost a very large sum to its proprietors. A third, for the Western Railroad, was erected six or seven years ago, a short distance above the other two, on fine stone piers of solid masonry, laid in coffer-dams. It has five or six arches, but in their construction the more modern mode of attempting to add what is termed a tie, to the arches forming a level road-way, and at the same time, relieving the arches from the horizontal thrust or pressure against abutments and piers. This mode has recently been much practised, but it is very questionable whether, in many instances, this kind of tie for the



safety of the arches, piers, &c., is sufficient to save either the bridge or the piers, in the event of the destruction of one of the arches, or of one of the piers. A case in point, tested the truth of this statement, at Pittsburg, in 1832. A high freshet, in the Ohio, forced away one pier of one of the long bridges at that place, by which two arches were destroyed; and although the bridge was intended to be secured with tie-string pieces, effectually, at or near the foot of each arch, yet such was the effect when, by the absence of two arches, the whole counteracting pressure of the arches was destroyed, that the patentee found, by careful examination, soon after the destruction of the two arches, that all the other arches were giving way and settling, nearly or quite across this wide river. The giving way of these ties, on which the road-way was placed, was so great as to require prompt and ample additional support, by props and otherwise, to keep some of the arches from falling; and even then, they settled so as to push nearly all the piers from their true position, in a horizontal direction, so as to produce cracks and violence, which was plainly seen; but was greatest in those piers nearest to the part broken away. These piers were not very high, and yet were large in proportion, and of hewn stone on the exterior. The remaining parts were much injured; and, by great care and good fortune, were saved from a general destruction. This, then, is a very strong proof, that such mode or intention to secure the arches against so formidable an evil, is not generally done so as to render them safe, in case of such an accident. That all bridges should be safe in this respect, especially long ones, is of so great importance, as not to admit, with prudence, of any possible doubt or question on the subject.

3d. The arched bridge requires great weight of timber; most of which, large enough to be subjected to the dry-rot.

4th. The feet of the arches generally stand against the abutments and piers, at a point much lower than the floor of the bridge. By this means, they are exposed to rains in windy weather, and to dampness from the piers; so much so, as to cause their decay in twenty or twenty-five years. This was the case with the bridge at Trenton, over the Delaware; the feet of the arches were renewed, at very great expense, about 1832; and from the great exposure to the weather, of this bridge, above the floor, it will probably require rebuilding, in the upper parts, within

thirty years, unless better protected from the weather. It has been stated, that it was left so exposed to the weather to render it secure against wind; most certainly a more mistaken, absurd, and unphilosophical idea, could not be entertained. There is much less danger from winds to bridges, when covered completely from the weather, than in almost any other kind of building of wood; because they are, when of considerable length, much secured by combination, into one mass, their whole length; they are, also, very heavy, compared with most other wooden structures, and have great strength, as well as a long and continued connection of parts, by which means, one part is weight and support to the other; they are never high enough to present a very deep volume to the wind; and, lastly, the wind passes under them so freely as to give itself vent, and if the length presents a wider resistance to wind, the great length of heavy and well combined materials is an amply sufficient anchor of safety to itself.

It may well be doubted, whether the covering of a bridge on any construction, with trusses or framed work to support them, for spans of more than 100 feet, presents more surface of obstruction to the winds, than is secured from its action by the inclosure. If not covered, all the timbers have half of their surface exposed to strong winds, in a manner similar to what would be the case if such bridge, with all its timbers, were immersed in a quick current of running water; it is evident that in both cases, more surface is exposed to the action of the moving fluid, than would be the case if covered sufficiently to keep out the weather. The reason of which is, because half of the exterior surface of the covering, &c. of a bridge is probably much less than half of the exterior surface of all the timber, plank, &c. of the uncovered bridge; the covering protects the interior timbers, &c. from the action of winds, and presents its own volume only, as one mass, to its force.

The great exposure to decay, from having the feet of the arches stand below the floor of the bridge, and bear or butt against the abutments and piers, thereby occasioning certain decay of their timber, sooner or later, has, in some instances, been obviated by placing the feet of the arches into the tie-string pieces. This certainly does away with the danger of decay, but another greater difficulty succeeds, viz. that in arches of any considerable span, the arch timbers must be, in a segment of a

circle, so flat as to be wholly incapable of bearing so great a weight as that of the bridge itself, and the travel over it, which it would be required to sustain also.

It is a well established fact, ascertained by practical experience, that a flat segment, or, which is the same, a small portion of the circumference of a circle or other curve, when applied to the arch of a bridge, executed in wood, becomes so much exposed to the compression of its wood, by a thrust-strain, as to be wholly inadequate to the purpose. The reason of which is founded in the plain mathematical principle, that as any curved arch of a given span, loaded with a given weight, approaches, by its low altitude, to a horizontal line, its exposure to the compression of its materials, in a thrust manner of strain, increases to an almost incredible degree; so much so, that the wood, which does not increase in its density, or power to resist compression, but remains stationary in this respect, becomes too weak and entirely insufficient, until at last, on a near approach to the horizontal line, even one tenth of its own weight could not be sustained.

In wide spans, to raise the arch so as to give it its adequate power to support a bridge, would present so large a volume to the wind, and that too with such great leverage, as might, indeed, create reasonable fears for the safety of such a construction.

The opinions and descriptions of several eminent engineers in England, in their late publications on bridges and railroads, are here introduced.

David Stevenson, in his sketch of the Civil Engineering of North America; London, John Weale, Architectural Library, 59 High Holborn, 1838; has the following account of this mode. He however, did not see but a small number of those that are well constructed.

“Plate 9th is a drawing of ‘Town’s Patent Lattice Bridge,’ which is much employed on the American railways. This construction is sometimes used for bridges of so large a span as 220 feet, and it exerts no lateral thrust, tending to overturn the piers on which it rests. A small quantity of materials, of very small scantling, arranged in the manner shown in the plates, possesses a great degree of strength and rigidity.

“For this drawing, I am indebted to Mr. Moncure Robinson, of Philadelphia, who is constructing many large bridges on this principle, on the Philadelphia and Reading Railway, several of which I examined, both in their finished and unfinished state.

“ If the bridge is of greater extent than can be included in one span, it is simply rested on a thin pier, in the manner shown in the elevation, without any other support. A covering of light boarding, extending from the level of the road-way to the bottom of the ribs, is spiked on the outside of the lattice-work to preserve the timber.

“ The largest lattice-bridge which I met with, was constructed by Mr. Robinson, on the Philadelphia and Reading Railroad. It measures 1,100 feet in length. The lattice-frames, of which it is formed, extend throughout the whole distance, between the two abutments, without a break, and are supported on ten stone piers, in the manner shown in the plates.

“ On the New York and Harlem Railway, there is a lattice-bridge 736 feet in length, supported in the same manner, on four stone piers.”

Since the above, there have been others finished, of much greater extent and goodness, both under the direction of Moncure Robinson, Esq. and others. That at Richmond, Va., is so remarkable for its magnitude and grandeur of effect, from the very bold and rich landscape of that fine city, that its description may well be here introduced, for it will convey both practical information and rational entertainment.\*

#### *The Railroad Bridge across James River.*

What is there yet to be done upon the face of the earth, that cannot be effected by the powers of the human mind, connected with the ingenuity of the human hand? The great elementary principles of nature have long ago been mastered by the skill of

---

\* The following description of a bridge, constructed on the improvement of Ithiel Town, as patented in 1835, it is fully believed will serve to show, not only the confidence of one of the most eminent and experienced engineers of the United States, in the superior durability, economy, and strength of principle, as lately improved by Mr. Town, but also the confidence which the public now feel in this mode of construction, from this and many other railroad bridges now in use or being erected. Among which is one on the Harlem Railroad, near New York; four over the North and Mohawk rivers, near Troy; one executed in a most splendid manner, over the Schuylkill, near Philadelphia, for the Baltimore Railroad; two on the railroad from Petersburg to Raleigh, N. C.; one at Tuscaloosa, Ala.; one at Circleville, Ohio, &c. Reference to Mr. Town's advertisement in the National Intelligencer, of August 5th, 11th, &c., and in the New York Weekly Express, of the 4th of August, 1839, for terms and other particulars.—*New Haven Daily Herald*, September 19th, 1838.

man, and rendered subservient to his wants and happiness. The bowels of the earth and the fathomless ocean, have alike been made to pour forth their treasures at his bidding. He has navigated the sea and the air, and made the inanimate objects of nature perform the labor that would have otherwise devolved upon his own hands. He has even, by his inventions, contemned the drudgery of personal locomotion, and caused himself to be carried, from point to point, upon the face of the earth and the waters, by inanimate agents, "with the rapidity of the wind;" while he luxuriously reclining, as though quiescent, drinks in new draughts of knowledge from the great fountain of the press, at once the offspring and parent of his intelligence. He is indeed, "lord of creation;" and all nature, as though daily more sensible of the conquest, is progressively making less and less resistance to his dominion.

The great bridge across James river, at Richmond, for the accommodation of the Richmond and Petersburg Railroad, may justly be considered as one of the greatest works of its kind in this country, or perhaps in the world. There are longer bridges of less altitude, and higher bridges of shorter span; but when the altitude and length of span of this bridge are taken collectively, there is, perhaps, not its equal in the world.

The location of the bridge is across the falls of the James river, a few hundred yards above tide water, where the velocity of the current is exceedingly great. It is constructed of substantial lattices, upon lofty granite piers, with a floor upon the summit of the lattice frame. The stoutness of the flooring corresponds with the general strength of the design, and it is rendered water and fire proof, by a strong coat of pitch and sand. The entire length of the span of the bridge is 2,900 feet, and the span between the piers 160 feet. The entire width of the floor is  $22\frac{1}{2}$  feet, (wide enough for a double railroad track,) being wider than, and projecting over the lattice-frame,  $2\frac{1}{2}$  feet on each side; the framework is, therefore,  $17\frac{1}{2}$  feet wide, on the top of the piers. The piers are 18 in number, founded in the rapids, upon the solid bed of granite rock that lies beneath. The elevation of the piers above common water is 40 feet, and their dimensions 4 by 18 feet at the top, increasing one foot in width and one foot in thickness, for every 12 feet in the descending scale. The masonry consists of regular courses of heavy stone, hewn to a joint on

their fitting surfaces; but on the showing faces of each pier, the stone is rough as it came from the quarry.

The whole structure was designed with a view to as much economy as was thought consistent with a just regard to strength and durability. Its execution was commenced in December, 1836, and the work was finally completed on the 5th of September, 1838, at an expense of about \$110,000. I doubt whether any bridge of the same gigantic dimensions and substantial character, composed of such choice materials and rare workmanship, has ever been constructed at a smaller expense. This work was projected by Moncure Robinson, Esq., chief engineer, and executed under the direction of himself and his principal assistant. The work itself stands like a mighty Colossus, bestriding the ancient Powhatan, destined to hand down to posterity both itself and its authors; and those piers of imperishable granite will remain as proud monuments, to remote generations of the present State of Virginia, and her sons, as connected with the sciences and the mechanic arts.

This improvement possesses the very important advantage of exerting no *lateral strain* upon piers or abutments; an advantage that cannot be too highly appreciated in aqueduct bridges; to completely avoid this lateral pressure, becomes immensely important in their *cost* and *safety*. This mode of construction is perfectly suited to the purposes of aqueduct bridges, as well as all others, especially for railroads; it being continued horizontally, and admitting, in the principle and practical execution, of any degree of strength that may be required, for any span which is practicable under any circumstances; it also presents the advantage of having the trunk or canal so suspended, as to preclude all possibility of self-destruction, by the leakage coming in contact with any of the important timbers, besides rendering other facilities, of the greatest importance in the mechanical execution, as connected with the top and side bracing. When the great facility and ease with which this kind of bridge is covered, is considered, in connection with other advantages, its adoption for all purposes of bridges, aqueduct bridges, railroad bridges, canal bridges, &c., is beyond all question desirable, as the strongest, most durable, and by far the cheapest mode of construction, and to keep in repair.

It may be stated *most truly*, that if most bridges were built with spans of 200 feet or over, there would be a much less num-

ber of different principles in bridge building used, than at present ; for although a very indifferent principle, or execution of a principle, or even *both*, will answer a considerable purpose for a time, for bridges of 75 to 120 feet spans, yet, it is always apparent *very soon*, and beyond *all question*, whether the principle or execution of bridges having spans of 200 feet or more, are sufficient or insufficient ; here is no room for doubt—no disguise ; the principle and practice, *both*, must be good, or the defect will soon exhibit itself in some shape not to be misunderstood. The reason of this difference between large and small spans is evident—it is for the same reason that a model of some modes of building bridges may have considerable strength, and appear to *many* to be good, yet when executed *full size*, will either fall down when the stages are removed, or soon thereafter. Perhaps the most obvious explanation of the reason of this fact may be thus explained, viz. suppose a piece of pine wood, half an inch square and 15 feet long, supported at the two ends, and resting in a horizontal position ; it is easy to perceive that it would have strength to sustain its own weight, and probably something more. Conceive this to be an exact model of another stick of the same kind, the dimensions of which should be every way increased in a twenty fold ratio, viz. 300 feet long, and 10 inches square ; let this stick be supported at the ends, as the model of it was, and what would be the result ? *Nay*, cut it into three pieces of 100 feet each, and would they, if supported in the same manner, bear their own weight ? Most certainly not.

Thus, then, the idea or belief that models are good representations of the strength of bridges when built, is erroneous in the extreme, and leads to sure disappointment and the destruction of property. Models of bridges only show the *relative* strength, or merit of different modes or principles ; this they show pretty *accurately*, when made to the same scale, to the same width of spans, of the same materials, and in all other respects similar. Perhaps no one error has done more mischief, in the hands of unscientific and ignorant mechanics, than the misunderstanding of the nature and real use of models, in illustrating the strength and goodness of bridges. Millions have been sacrificed in this country, either in this manner, or in a way so similar as not to need a nicer distinction.

Here follow some formulæ, for the investigation of models, in accordance with the best writers on the subject :

From an experiment, made to ascertain the firmness of the model of a bridge, or of an edifice, certain precautions are necessary, before we can infer the firmness of the structure itself.

1. If the side of a model be to the corresponding side of the structure, as 1 to  $n$ , the stress which tends to *draw* asunder, or to *break transversely* the parts, increases from the smaller to the greater scale, as 1 to  $n^3$ ; while the resistance of those ruptures increases only as 1 to  $n^2$ . The structure, therefore, will have so much less firmness than the model, as  $n$  is greater. If  $w$  be the greatest weight which one of the beams of the model can bear, and  $w$  the weight or stress which it actually sustains, then the limit of  $n$  will be  $n = \frac{w}{w}$ .

2. The side of the model being to the corresponding side of the structure as 1 to  $n$ , the stress which tends to crush the parts by *compression*, increases from the smaller to the greater scale, as 1 to  $n^3$ , while the resistance increases only in the ratio of 1 to  $n$ . Hence, if  $w$  were the greatest load which a modular wall or column could carry, and  $w$  the weight with which it is actually loaded; then the greatest limit of increased dimensions would be found from the expression  $n = \sqrt{\frac{w}{w}}$ . If, retaining the length or height  $n h$ , and the breadth  $n b$ , we wished to give to the solid such a thickness  $x t$ , as that it should not break in consequence of its increased dimensions, we should have  $x = n^2 \sqrt{\frac{w}{w}}$ . In the case of a pilaster with a square base, or of a cylindrical column, if the dimension of the model were  $d$ , and of the largest pillar, which should not crush with its own weight when  $n$  times as high,  $x d$ , we should have  $x = n^3 \sqrt{\frac{n^2 w}{w}}$ . These theorems will often find their application in the profession of an architect or an engineer.

3. Suppose, for an example, it were required to ascertain the strength of a bridge on this improvement, from experiments made with a model. In this construction, the truss-work is carried across from pier to pier, so that the road-way entirely across, shall be in a horizontal plane, and all the parts shall retain their own respective magnitudes throughout the structure. Now, let  $l$  rep-



resent the horizontal length of the model, from interior to exterior of the two piers,  $w$  its weight,  $w$  the weight it will just sustain at its middle point  $B$  before it breaks. Let  $n l$ , the length of a bridge actually constructed of the same material as the model, and all its dimensions similar: then, its weight will be  $n^3 w$ , and its resisting power to that of the model, as  $n^2$  to 1, being  $=n^2 (w + \frac{1}{2} w)$ . Hence  $n^2 (w + \frac{1}{2} w) - \frac{1}{2} n^3 w = n^2 w - \frac{1}{2} n^3 (n - 1) w$ , the load which the bridge itself would bear at the middle point.

This mode of construction will have the same advantages in iron as in wood, and some in cast iron which wood has not, viz. that of reducing the braces in size between the joints, and of casting flanges to them where they intersect, thereby making it unnecessary to have more than one bolt and nut to each joint or intersection.

When it is considered that bridges, covered from the weather, will last eight or ten times as long as those not covered, and that the cheapness of this mode will admit of its being generally adopted, with openings or spans between piers which are composed of piles, and at a distance of 150 to 200 feet apart, then the construction of long bridges over mud bottomed rivers, like those at Washington, Boston, Norfolk, Charleston, &c., on this principle, will be perceived to be of great importance; especially as the common mode of piling is so exposed to freshets, uncommon tides, drift-wood, and ice, as not to insure safety or economy in covering them, and consequently continual repairs, and often rebuilding them, become necessary. There is very little doubt, that one half of the expense, computing stock and interest, that would be required to keep up, for 100 years, one of the common pile bridges, like those at Boston, would be sufficient to maintain one built in this new mode, keep it covered, and have all or nearly all the piers built with stone at the end of 100 years. If this be the case, it would be great economy to commence rebuilding by degrees, in this manner. The saving in the one article of floor planks, if kept dry, would be very great, as by being so much wet they rot, and wear out in about half the time.

No. 1. *A section of a bridge, with the roof, suspension posts, and all the parts, upon the pier, with a scale of feet.*

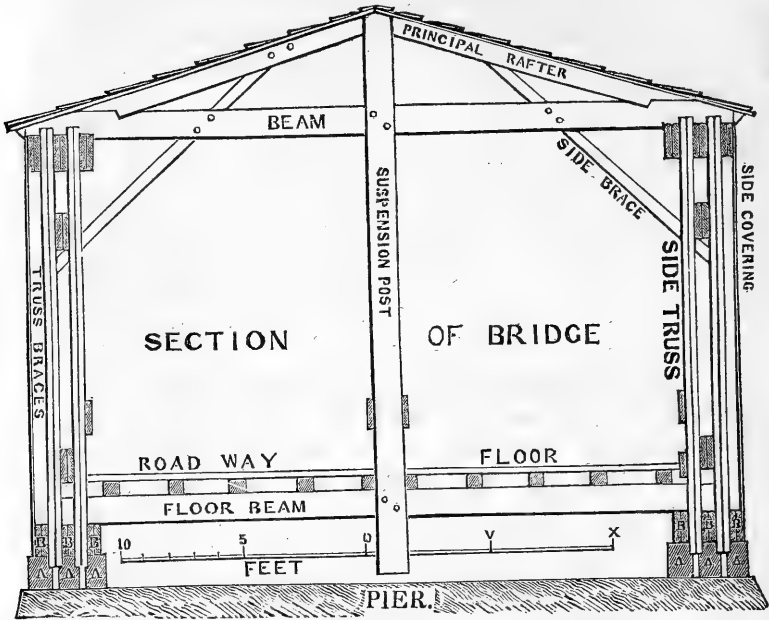

No. 2. *The side elevation of a truss, to the same scale. The height of a truss may be greater or less, by any number of half diamonds, or by a change of the angle of the truss-braces.*

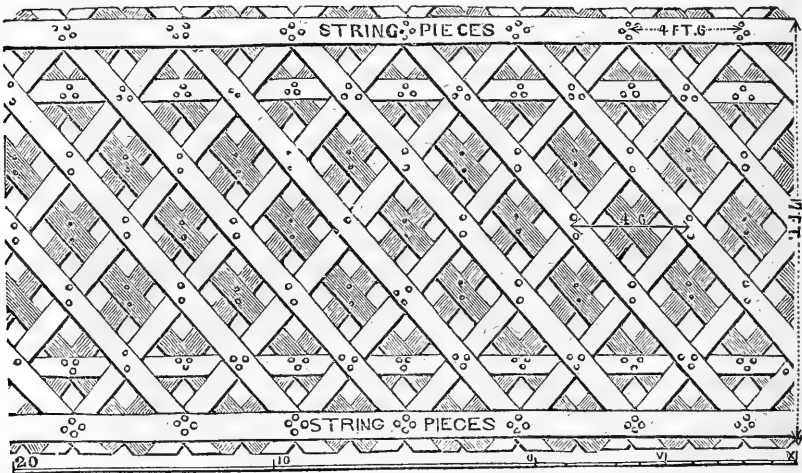

*Description of the Plates, with Definitions of technical terms, &c.*

Numbers 1, 2, and 3 exhibit all the parts of a bridge on the last improvement, with suspension posts, &c., suited to a span of 170 to 220 feet, according to the size and number of its parts, which may be so varied as to suit the width of span required.

*Definitions, Explanations and General Remarks.*—1st. A truss is that combination (No. 2) of materials, which, with one or more other similar ones, constitute the whole vertical support of the bridge. They are placed in a vertical position on the piers, and are kept so by the addition of bottom beams, top beams, and horizontal and side braces, as shown in No. 1.

These few parts may be termed the skeleton of the bridge, and constitute the whole strength and support of the superstructure; to which a floor is added, for the conveyance of travel, produce, goods, &c., and generally a roof and side covering, to save the skeleton and floor from that decay which is incident to its exposure to the weather.

2d. Truss-braces, or diagonal braces, are those crossing each other, and forming the truss into diamonds. There are two series or sets of such truss-braces, separated by middle string-pieces, six or seven inches thick. (See figs. 1 and 2.) Each series of truss-braces may be termed a lattice; hence it is, by some, termed the double lattice bridge. The diamond-truss bridge, double diamond-truss, or double diamond bridge, would be more appropriate and better understood.

3d. String-pieces are all those horizontal parts of a truss, at top and bottom, or intermediate, which run the whole length, and are secured to the truss-braces by three or four tree-nails, at each intersection of them, over which the string-pieces pass.

4th. Intermediate string-pieces are those which pass over the lines of intersections of the truss-braces, between the extreme top and bottom string-pieces. Middle ones are here added, and the others may be added when more strength is required.

5th. Centre, or middle string-pieces, are all those which run between the two series of truss-braces, whether at top, at bottom, or intermediate; intermediate middle ones only, are here represented.

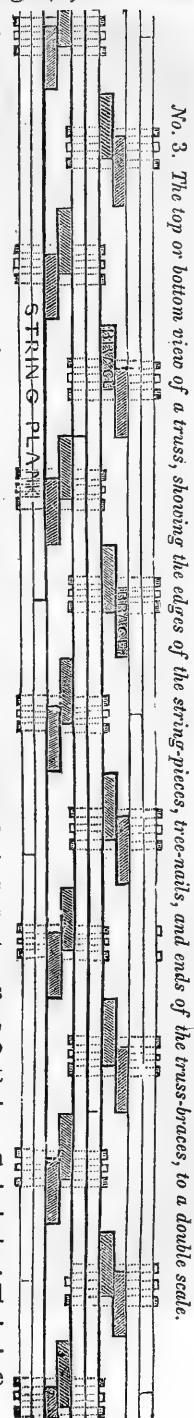

6th. String-plank are those pieces of which all the string-pieces are composed, and are half the thickness of the string-pieces, and are, in this case, 27 feet long. They break joints in their centres.

7th. Floor-beams are those which rest upon the trusses, and support the flooring of the bridge. The size of them should be in suitable proportion to the distance between their bearings upon the trusses, or suspension-posts and trusses, when the former are introduced; great depth in proportion to their thickness is important.

8th. Suspension-posts (see No. 1) are pieces 12 or 14 inches by 4 or 5 inches, firmly secured by tree-nails, locking, &c. to the top and bottom beams, and to each pair of principal rafters. They are introduced instead of a middle truss, for the support of the floor beams of a covered bridge, when the floor is on the bottom beams, and when the width of the bridge is so great that floor beams of sufficient strength cannot be procured.

9th. Floor-joists are pieces running lengthways of the bridge, and resting upon the top of the floor beams. They should be  $4\frac{1}{2}$  to 6 inches square, according to the distance apart of the floor beams.

10th. Floor-planks are the pieces resting on the floor-joists, of various widths, from 6 to 12 inches, and from  $2\frac{1}{2}$  to 4 inches thick, as may be required. In some instances, two thicknesses of planks are preferred; in which case, they cross each other at right angles or obliquely, and may be of less thickness, or such as their use may require.

11th. Horizontal braces at the top are either framed in diagonally, between the top beams, or consist of long planks of suitable dimensions, spiked and tree-nailed to the top of the beams, so as to give the most secure support, to keep the trusses in a straight line at top. This is a very important support, and should be done in the most secure manner, in every respect.

12th. Principal rafters are those which stand upon the top beams, and are thoroughly secured to them at their feet. They may be 10 to 12 inches deep, and 4 to 5 inches thick, according to their length.

13th. Small rafters are those between the principal ones, to nail the roof-boardings to, for the purpose of shingling.

14th. Floor-braces, or bottom-braces, are pieces about  $4\frac{1}{2}$  by  $6\frac{1}{2}$  inches, as their length may require, framed in and keyed, be-

tween the bottom beams, to keep the bottom part of the bridge secure against any motion or vibration sideways, by wind, travel, or transportation.

15th. Side-braces (see No. 1) are pieces about  $4\frac{1}{2}$  by  $5\frac{1}{2}$  inches, connected with the side-truss, the top-beam, and the principal rafters, for the purpose of preventing the side-trusses from leaning, or inclining up or down stream. In the section No. 4, the side-braces are differently secured, and may cross each other or not, as shown in the section. By crossing, greater strength is obtained.

*No. 4. A section of a bridge, with the floor, side railing, &c. on the top of the trusses. The floor may easily be made to turn off the water, and with side boarding, would be effectually secured from the weather. A scale is annexed.*

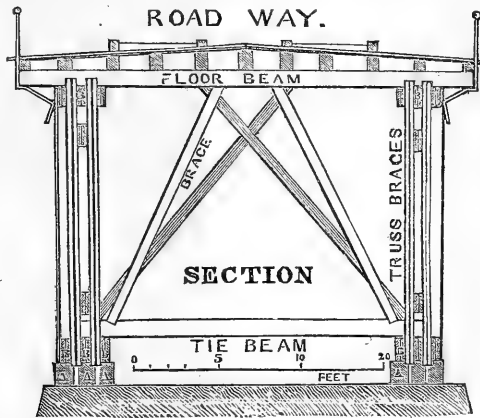

16th. Side-walks are sometimes made for foot travel, and may be in the inside or on the outside. They are parted off by a railing 3 or 4 feet high, and if on the outside, may be made very ornamental, as seen in No. 5.

17th. Tree-nails of two inches diameter, made of white oak or other hard wood, are used for securing the truss-braces and string-pieces together, as seen in Nos. 2 and 3. They should be exactly fitted to the augers used, so as when seasoned to drive tight, and make solid work. Tree-nails may be made different ways, but the best and most economical is, to saw them out square from plank, with a circular saw, and then turn them with a small lathe, attached to some water or other machinery. They should be unseasoned, to be easily made, but must afterwards be well seasoned before driven into the work; they will season

No. 5. A perspective view of a roofed bridge, with side-walks on the outside, protected by colonnades and railings, finished in a very rich style of decoration.

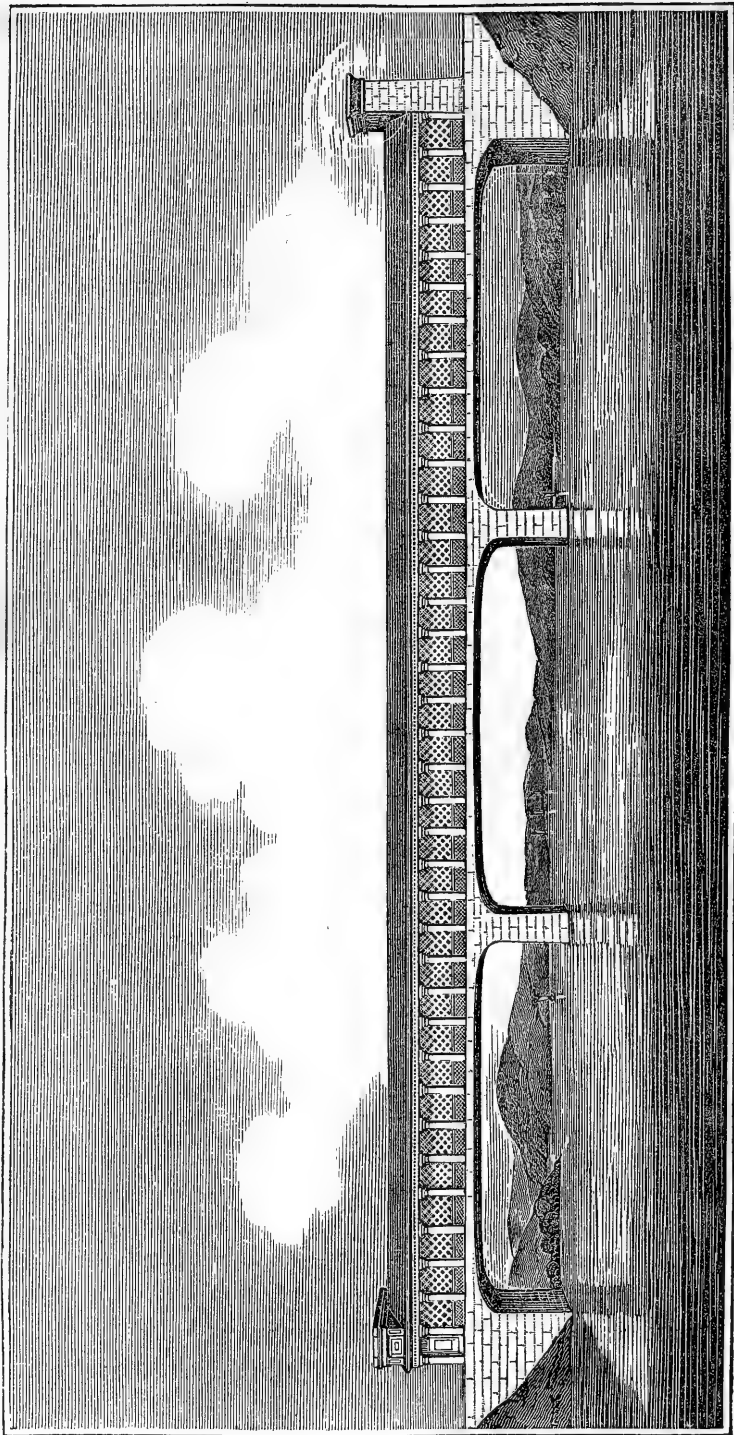

quick, or may be kiln-dried. Tallow, or oil, &c. may be rubbed upon them, to make them drive more easily, if necessary.

18th. Abutments are the two supports of a bridge or aqueduct, at the ends, and are erected against and connected with the banks, on each side of the stream or ravine. They may be constructed in various ways, the same as the piers, if any, with which they are connected. The abutment for a bridge, on this improvement, requires no other strength or solidity, than a pier of equal exposure, there being no lateral or horizontal pressure, to affect either the abutments or piers, and therefore a perpendicular support only is required, sufficient to bear up the weight of the bridge, and that which may pass over it. One or more draws, for the passage of shipping, &c., may consequently be any where placed or constructed, without producing the least injury to this kind of bridge, as its strength and safety do not depend, in the least, on being connected throughout; except very partially, as respects the action of severe gales of wind, in which case, a structure in one entire connected mass, is of course somewhat less liable to be acted upon.

---

ART. XI.—*Description of an Economical Apparatus for Solidifying Carbonic Acid, recently constructed at the Wesleyan University, Middletown, Conn.*; by JOHN JOHNSTON, A. M., Professor of Natural Science.

THE solidification of carbonic acid has of late excited considerable interest both in Europe and in this country; but the cost of the necessary apparatus has been considerable, and many probably have on this account, merely, been prevented from making any attempt to repeat the experiment. Most of our public literary institutions, in which alone in this country such apparatus is ever used, are obliged to study economy, and they are therefore often liable to be prevented from availing themselves of the benefits of new discoveries like the present, merely on account of the expense of apparatus.

It is therefore thought a description of an economical apparatus for solidifying carbonic acid may be acceptable to the public, though we do not pretend to offer any thing new on the general subject.

The generator **A** is made of a common mercury flask, several of which I have tested and find sufficiently strong. They may be purchased in New York for a dollar a piece, or even less. The aperture at the neck may be a little enlarged, so as to make it an inch or an inch and a quarter in diameter, and the thread of the screw re-cut. A plug of cast-steel **B** is made of a bar two inches in diameter, and turned with a wide and smooth shoulder, so as to fit accurately upon a collar of block-tin when screwed into its place, as represented in the figure. This collar should be soldered to the iron; which is easily accomplished by filing the iron bright and tinning it in the ordinary manner, and then melting the block-tin and pouring it on, having first screwed a cork into the aperture and formed a wall of putty or clay at a sufficient distance around it. The shoulder of the plug is readily made to fit the collar accurately by screwing it a few times into its place, and then removing with a coarse file the parts of the collar upon which it touches. In this manner an accurate joint may be made without the use of a lathe; and if the plug does not correspond precisely with the axis of the flask it is just as well.

The faucets or stop-cocks are the most difficult part to construct, and occasion full half the expense. These in our apparatus are supposed to be essentially the same as are used by others for this purpose, but it may not be amiss to insert a description, since none has to my knowledge been given. There is this peculiarity about ours, however; they are inserted in the cast-steel plugs, which indeed make a part of them. **D** is designed to represent the plug removed from the generator; at the upper end of it a hole **F** one inch in diameter is drilled about an inch deep, terminating in a hollow cone into which the point **G** is accurately ground. A small hole extends quite through the plug. Around the aperture **F** a collar of block-tin is fitted to receive the shoulder of the part **E**, as seen at **I**, and prevents any passage around the threads of the screw. Through the axis of the part **E** a hole three eighths of an inch in diameter is drilled, and receives the part **G** which is screwed in from below, the handle **H** being removed. The handle **H** should be afterwards riveted on.

Now suppose **H E G** to be inserted in its place in the cast-steel plug, as represented at **B I**, the plug itself being screwed into the generator. If **H'** be screwed down, the aperture from the generator is firmly closed by the conical point **G**; and by giv-



ing H' a single revolution in the opposite direction, the shoulder of G is brought firmly against the bottom of E, so that no escape is permitted directly upward, but only in a lateral direction through the brass tube L, which connects the generator with the receiver C. A washer of sheet lead should be placed around the shoulder of G, in order to secure a perfect metallic contact between it and the bottom of E.

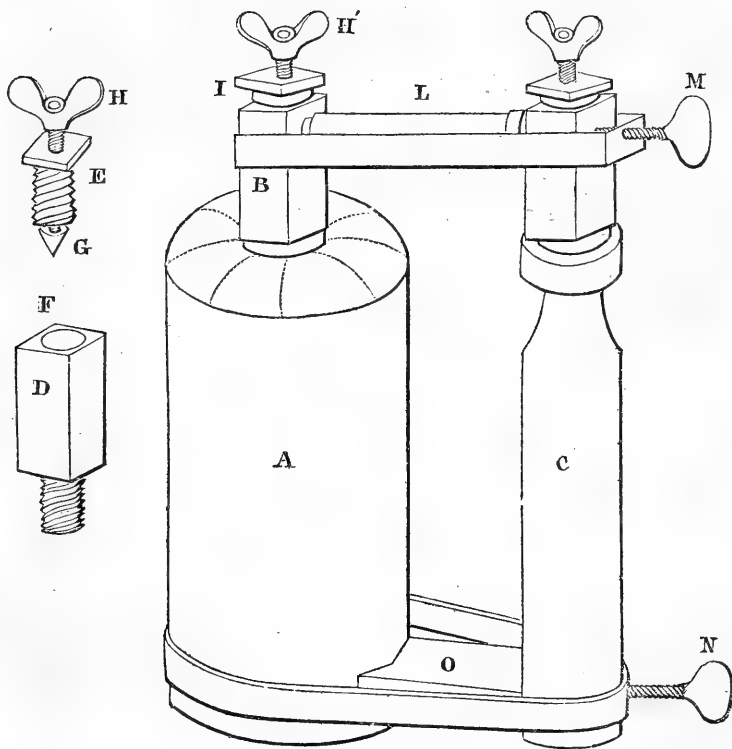

The receiver C is made of the best boiler iron, which was strongly welded around a cylinder and a bottom also welded in. It is of the same height as the generator, which is about one foot, but only about two inches in diameter internally, and has a capacity of about one pint. This form enables it to resist much greater pressure than if it was of a larger diameter; and it is rather an advantage than otherwise to have it of the same length as the generator.

A cast-steel plug with stop-cock precisely similar to the one described, screws into the receiver, as the other does into the generator. The tube L screws into the plug which is inserted in the receiver, and the other end, turned to a conical point, fits accurately into a cavity in the plug B, and is held in its place by means of the stirrup screw M. Another stirrup screw N, and block of wood O, secures the receiver C in its place.

To use this apparatus the generator and receiver are separated, and the plug B being removed, two pounds of bicarbonate of soda, made into a paste with the same weight of water, are introduced into A, and twenty ounces\* of strong sulphuric acid are poured into several lead vessels, made by soldering bottoms in pieces of lead tube a little shorter than the length internally of the generator, and of such a diameter that they will just pass the aperture. These being nearly filled with acid are dropped into the generator, which, after the plug B is inserted, is allowed to lie on one side for fifteen or twenty minutes, or a less time if it is several times rolled over to mix the acid with the soda. The receiver is then attached to it as seen in the figure, by means of the stirrup screws M and N; and if kept sufficiently cool by means of ice, the liquid carbonic acid formed in A will shortly be distilled over into C, the passage between them being of course previously opened by means of the stop-cocks before described.

The stop-cocks are now to be closed and the receiver, which now contains the liquid carbonic acid, separated from the generator. A small tin cup is then to be attached to the tube L, precisely as in Dr. Mitchell's apparatus,† to receive the jet of acid from the receiver. It is essential that the *liquid* acid should escape into this cup, which is effected by having a small tube pass from the steel plug nearly to the bottom of the receiver, or by inverting the receiver before opening the stop-cock.

The best method of testing the strength of the apparatus, is by means of a hydraulic press, but it can be done as effectually by permitting it to lie, when charged, exposed to the direct rays of the sun, and excluded from currents of air, till the temperature

---

\* The quantity of acid required to saturate or neutralize the soda would be a little more than 24 oz., or 22 oz. only if the soda is in crystals, but something less than this should always be used.

† Journal of the Franklin Institute, Vol. xxii, p. 289, and Vol. xxxv, p. 346, of this Journal.

rises to 100° or 110° F. This should be done two or three times before running any risks by venturing to handle the apparatus while charged.

It has been our object to construct an apparatus for forming the solid acid merely, but the gauges for ascertaining the pressure, &c. might of course be added as in Dr. Mitchell's apparatus.

The above apparatus, including the expense of testing three times, cost us about nineteen dollars.

ART. XII.—*Observations made at Canton, China, on the Shooting Stars of the 10th and 11th of August, 1839, in a letter from REV. PETER PARKER, M. D. of Canton, to E. C. HERRICK.*

“IN accordance with your request I have made observations for shooting stars on the evenings specified in your letter. On the 3d of August, 1839, a gentle South wind prevailed during the day. The evening was beautiful; but discovering only *two* meteors between 8 and 9 o'clock, I gave up the watch. Aug. 4. Cloudy. Wind N. At 3 P. M., came on a sudden and violent squall from S. S. E., which drove the cargo boats with their anchors against a six-knot tide. Several lives were lost in the river front of the factories. Aug. 5. Cloudy. Aug. 6. From 10h. to 10h. 30m. P. M. saw but *three* meteors. Aug. 7. Strong gale from S. E. Aug. 8 and 9. Storm continued. Aug. 10. Extremely pleasant during the day and evening, with a gentle breeze from the South. At 8h. P. M. *three* meteors fell simultaneously: at 8h. 5m. a fourth. At 8h. 10m. a very beautiful one from Cassiopeia to the S. It had the singular appearance of being propelled by three distinct successive forces, and moved in an irregular but graceful undulating course. At 8h. 30m., another, similar to the last: at 8h. 45m., one from  $\alpha$  Serpentis to the S. Other duties then interrupted the observations. At 10 o'clock observations were commenced by two persons and continued about two hours, during which time the following meteors were seen by them.

10h. P. M. 1 fr. Cassiop. to S. E. very beautiful.	10h. 12m. 1
5m. 1 “ Zenith to N.	13 2 fr. Zenith to S.
7 1 “ “ “ Ursa maj.	15 2 “ “ “ “
10 1 “ “ “ do. small.	22 1 “ Cass. to Ursa Major, the train was very broad and visible for half a minute.
11 1 “ “ “ do.	

10h. 24m.	1 Ursa Major to S.
29	2 towards W.
30	1 S. E. to S. large.
37	1 Cass. to Ursa Major.
38	1
39	1 S. to W.
"	1 N. to W.
42	1 Ursa Major to S.
45	1 " " " "
47	3 " " " W.
51	1 S. to S. W.
54	1 S.—vertical.
55	2 Cass. to S.
55½	2 " " S. swift.
<hr/>	
	30 meteors.
11h. 3m.	2 in S. beautiful.
8	1 fr. Zen. to E.
9	1 S. vertical.
10	1 Zen. to S.
12	1
15	1 Ur. Maj. to W. large.
17	1 Ur. Maj. to S.
21	2 Cass. to S.

11h. 22m.	1 Cass. to W.
22	2 Cass. to S.
24	1 Cass. to S. E.
25	1 Cass. to E.
28	1 Cass. to S.
29	1 Cass. to S.
29	1 Zen. to S.
30	2 Cass. to W.
31	1 Cass. to W.
32	1 Cass. to S.
33	1 Cass. to W.
34	1 Cass. to W.
36	1 Cass. to S. W.
39	1 Cass. to W.
40	1 Zen. to S.
42	1 Zen. to S.
43	2 Cass. to W.
44	1 Zen. to N. W.
45	1 Zen. to N. E.
45	1 E. to W.
46	1 Cass. to W.
<hr/>	
	34

August 11th. The observations commenced at an early hour, and continued until 4h. 30m. A. M. of the 12th. Below is a list of the meteors observed and recorded.

8h. 15m.	P. M. 4 meteors.
17	2 fr. Zen. to E.
20	1 Zen. to W.
25	1 Zen. to W.
26	1 Zen. to W.
30	1 Zen. to S.
35	2 Zen. to S.
40	1 Zen. to W.
45	1 Lyra to S.
50	1 Serpens to S.
51	1 Zen. to S.
<hr/>	
	16
9h. 1m.	1 N. to E.
10	1 S. to N.
11	1 E. to S.
11.	1 Zen. to S.
12	1 W. to E.
13	1 Zen. to E.
14	1 Zen. to N.
18	1 S. to N.
19	1 Cass. to S. large.
26	1 S. to N.

9h. 29m.	2 Zen. to S.
31	1 E. to S.
32	1 Zen. to S.
41	1
42	1 S. to N.
44	1 Cass. to N.
47	1 Cass. to N.
47	1 Lyra to S.
49	1 S. to N.
<hr/>	
	20
10h. 3m.	1 Zen. to S.
5	2
8	1 Regulus to N. very fine.
12	1 Zen. to S. long trail.
13	4
14	2
20	1 Zen. to S.
23	1 N. to S.
25	2
27	2 E. to W.
29	1
30	1 N. to W.

10h. 31m. 1 Zen. to S.  
 33 1 W. to E.  
 34 1 Cass. to S.  
 40 1 N. to S.  
 42 1 Lyra to S.  
 43 1 N. to E.  
 44 3 N. to S.  
 45 1 Cass. to S.  
 56 1 N. to S.  
 57 1 W. to S.  
 59 1 Cass. to S.

32

11h. 2m. 1 W. to E.  
 4 1 Cass. to N.  
 6 2 Cass. to N.  
 9 2 Cass. to S.  
 15 3 Cass. to S.  
 16 1 E. to W.  
 17 1 Cass. to S.  
 18 1 S. to Cass.  
 23 1 Cass. to S.  
 25 1 Ursa m. to S.  
 25 1 Cass. to S.  
 26 2 Cass. to S.  
 30 1 Cass. to S.  
 31 1 Cass. to S.  
 33 1 Cass. to N.  
 33 1 Zen. to W.  
 35 2 Cass. to S.  
 36 1 Cass. to S.  
 39 1 Cass. to N.  
 40 1 Zen. to W.  
 40 1 Ursa m. to S.  
 43 1 Cass. to S.  
 45 1 Cass. to W.  
 46 2 Cass. to W.  
 46 1 Cass. to S.  
 49 1 Cass. to N.  
 50 2 Cass. to N.  
 51 1 Cass. to E.  
 51 1 Cass. to W.  
 58 1 Cass. to W.  
 58 1 Cass. to S.

39

12th.

A.M. 0h. 5m. 1 Cass. to S.  
 6 1 Cass. to S.  
 8 3 Cass. to E. and W.  
 10 1 N. to S.

0h. 11m. 1 S. to N.  
 12 2 Cass. to W.  
 12 1 Cass. to S.  
 13 1 S. to N.  
 15 2 Zen. to S.  
 16 1 Zen. to S.  
 20 2 Zen. to S.  
 29 1 Cass. to S.  
 30 1 Cass. to S.  
 31 2 Cass. to S. and W.  
 33 1  
 35 2 Cass. to S.  
 36 1 Cass. to W.  
 37 1 Cass. to S.  
 40 1 Cass. to W.  
 45 2 Cass. to S. and W.  
 46 1 Cass. to W.  
 46 4 Cass. to S.  
 50 1 Zen. to N. very fine.  
 51 1 E. to W.  
 53 1 Cass. to S. W.  
 54 1 Zen. to S.  
 55 2 Cass. to S.  
 56 2 Cass. to S. and W.  
 57 2 Cass. to S. and W.  
 58 2 Cass. to S. and W.  
 59 1 Cass. to W. large.

46

1h. 1m. 1 Zen. to N.  
 4 1  
 5 1 Cass. to W.  
 6 1 Zen. to E.  
 10 1 Cass. to E.  
 11 1 Zen. to W.  
 12 5  
 13 2 Cass. to S.  
 15 1 Cass. to W.  
 16 1 Cass. to S. W.  
 20 1 Cass. to W.  
 25 1 Cass. to W.  
 25 1 Cass. to S. E.  
 26 3 Cass. to S. W.  
 28 2 Cass. to S. W.  
 28 2 Cass. to N.  
 30 1 Cass. to S.  
 30 1 Cass. to N.  
 31 2 Cass. to N.  
 31 1 Cass. to S.  
 33 5  
 35 1 Zen. to S.

1h. 36m. 4 Cass. to S.  
 40 1 Cass. to N.  
 40 1 Cass. to E.  
 46 3 Cass. to N. W.  
 to  
 52 12  
 55 3 Cass.  
 57 5 Cass. one fine.  
 58 2 Zen. to S. W.

---

67

2h. 0m. 1 Cass. to N. W.  
 0 1 Zen. to N. W.  
 1 1 Cass. to N.  
 1 1 Zen. to N. W.  
 2 3 Zen. to N.  
 3 3 Zen.  
 5 1 Zen. to N.  
 10 2 Cass. to W.  
 11 1 Cass. to N.  
 11 1 Cass. to S.  
 14 1 Cass. to W.  
 14 3 Cass. to N.  
 15 6  
 16 1  
 20 6 Cass. to E.  
 30 3 Cass. to S.  
 35 6  
 37 1 Cass. to S.  
 38 1 Cass. to N.  
 40 1 Cass. to S.  
 40 1 Cass. to W.  
 42 5 Cass. to S. W.  
 45 2 Cass. to S.  
 46 2 Cass. vertical.  
 48 1 Cass. to S. W.  
 48 1 Cass. to S.  
 49 2 Cass. to N. E.  
 52 1 Cass. to S.  
 53 2 Cass.  
 54 1 Cass. to E.  
 54 1 Cass. to S. W.  
 55 1 Cass. to N.  
 55 1 Cass. to S.  
 56 2 Zen. to S.  
 57 3 Zen. to S. W.

---

70

3h. 0m. 1 Zen. to S. W.  
 1 1 Zen. to E.

3h. 4m. 4 Cass. to E.  
 5 1 Zen. to E.  
 6 3 Cass.  
 7 2 Cass.  
 10 3 Cass. to S. W.  
 12 1 Cass. to S.  
 15 1 Cass. to E.  
 17 3 Cass. to E.  
 20 1 Cass. to E.  
 22 2  
 24 3 Zen. to S.  
 25 7 Cass. to S. W.  
 27 3 Cass.

to 35 22 course not taken.

37 6

40 4

42 4

46 4

47 5

50 2

54 2

55 5

56 3

---

93

4h. 0m. 8

5 4

15 10

25 8

30 1

---

31

*Aggregate.*

Aug. 10th, 10h. to 11h. P. M. = 30 meteors.

11 to 12 " = 34

---

64

Aug. 11th, 8h. to 9h. P. M. = 16

9 to 10 " = 20

10 to 11 " = 32

11 to 12 " = 39

12 to 13 " = 46

13 to 14 " = 67

14 to 15 " = 70

15 to 16 " = 93

16 to 16½ " = 31

---

414

“There can be no question that the meteors of the night of the 11th of August, (1839,) exceeded the usual number. They attracted the notice of Europeans and Chinese, whose attention had not been called to the subject. Several friends watched on the night of the 12th from 9 P. M. till 2 A. M. (13th) and saw only about half a dozen meteors. I have repeatedly looked out since the 11th, [up to the 28th, the last date of the letter,] and have seen but very few meteors.

“The most casual observer on the 10th and 11th could not fail to notice that the great majority of the meteors were from the constellation *Cassiopeia*. One of the three meteors seen at 1h. 55m. of the morning of the 12th, was exceedingly beautiful. Starting apparently from the neighborhood of this constellation, it resembled a broad stream of burning phosphorus, until it descended within about  $25^{\circ}$  of the horizon. There it exploded, exhibiting a beautiful brilliant light, resembling the combustion of *iodide of phosphorus*, but far exceeding any thing of the kind ever witnessed in our laboratories. A white phosphoric color characterized the majority.

“In watching these phenomena, a person might easily receive the impression that they resulted from some combustible material in our atmosphere, which gradually accumulated until it took fire. Although the meteors were occasionally scattered along at intervals of a minute, yet more frequently they appeared in clusters about every five minutes. The majority of those from the vicinity of *Cassiopeia* took a Southerly or South-westerly course, but still while this region was the common starting point, the directions of many seem to be determined by no obvious law. Surely the South wind on this occasion had no influence, unless by the ‘rule of contrary.’

“I may here mention that on the evening of the 12th of August, (following the evenings of the meteors,) about sunset, the wind was squally from the South, and the clouds were of a peculiar auburn tinge, approaching to a whitish red. This continued for two or three hours, when the clouds passed away, and a pleasant day succeeded. The same was the case after the meteors seen here in November, 1838. The coincidence may be quite accidental and unimportant, but the facts are perhaps worth mentioning.

“ You have probably seen, in the Canton papers, that on the 5th of December, 1838, we had a merry exhibition of meteors. Two observers counted *a hundred and sixty* in one hour from 8½ to 9½, P. M.”\*

[*Note.*— The observations above recorded, (which are perhaps the first ever systematically made at this epoch in that part of the globe,) serve to confirm the position, that about the 10th of August, for two or three millions of miles at least, the earth traverses a region abounding with small planetary or nebulous bodies, which, when rendered luminous by their rapid passage through our atmosphere, we call *shooting stars*. The observers seem not to have endeavored to determine very closely the point of the heavens from which the meteors appeared to diverge; they refer it to *Cassiopeia* or its vicinity, which cannot be far from that part of *Perseus* in which the observations made in this country fixed the radiant, (this Jour. Vol. xxxvii, p. 328.) Regarding the whole number of meteors visible at Canton at this time, we can make no definite estimate, since we are not informed whether the positions of the two observers were such as to secure the greatest possible amount. The time of the night at which the meteors were most numerous, appears to agree with our previous approximate determinations. E. C. H.]

New Haven, Feb. 5, 1840.

ART. XIII.—*Remarks chiefly on the Synonymy of several North American Plants of the Orchis Tribe; by ASA GRAY, M. D.*

THERE are comparatively very few representatives of the remarkable family of Orchidaceous plants in the United States. The Epiphytic forms, now the pride of conservatories, embracing many of the most bizarre as well as splendid productions of the vegetable kingdom, belong to tropical climes. Many species approach the southern borders of the United States, but only one (*Epidendrum Magnoliæ*) is found within its limits. Linnæus described only fourteen species of *Epidendrum* in the first edition of the *Species Plantarum*, (1753.) Now, perhaps fourteen hun-

\* These meteoric observations, as well as many others made about that time, in this country and in England, may be found in this Journal, Vol. xxxv, p. 361, and Vol. xxxvi, p. 355.



dred epiphytic species may sometimes be seen growing in a single hot-house. The genus *Orchis*, as at present constituted, although belonging to temperate regions and to the northern hemisphere, is almost wholly confined to Europe, and is represented in North America by a single species. Excepting this, all our Linnæan and Willdenovian species belong to *Habenaria*, as characterized by Brown, and to *Platanthera* and *Peristylus* of Lindley. Having had occasion recently to examine the specimens upon which these and other species were founded, I was surprised to find very great confusion in the synonymy; some of our commonest species having, as it appears, been widely mistaken from the time of Linnæus to the present day. When we consider how limited an interchange of specimens took place between the earlier botanists, how seldom they were able to consult each other's herbaria, taking also into the account the brevity in the specific phrase enjoined by the Linnæan canon, and the absence of any method of distinguishing between authenticated synonyms and the more or less probable ones which an author might venture to adduce, we shall not wonder at the frequent occurrence of such mistakes.

Only four North American species of *Orchis* are described by Linnæus, viz. *O. ciliaris*, *O. flava*, *O. psycodes*, and *O. spectabilis*. The latter is still retained in that genus. Respecting the first, I have no remark to make, except that Linnæus's reference to Gronovius, *Fl. Virg.*, is to be excluded, as it relates to *O. blephariglottis*. To this last the *Platanthera holopetala* of Lindley is perhaps too closely allied, as I have seen apparently intermediate specimens from Canada, and also in the Newfoundland collection of Pylaie. Sprengel states the flowers of *O. ciliaris* to be red. The two remaining Linnæan species require more extended notice.

*ORCHIS FLAVA*, *Linn.* has remained an uncertain species quite down to the present time, no succeeding author having identified it. Pursh, indeed, remarks that he has seen the specimen in the herbarium of Gronovius; but he failed to recognize it as the same with another species described in his work, viz. his *O. fuscescens*. Nuttall has taken for it a very different species, (apparently his own *O. integra*;) in which he is followed by Elliott; who states, however, that the plant differs much from the original description of Gronovius. Having examined the herbarium of Clayton and Gronovius's *Fl. Virg.*, through the kind permission

of Mr. Brown and Mr. Bennett, I may state that a minute examination of the specimen on which this species is founded, proves it to be identical with the well known *Habenaria herbiola*. It is a somewhat loosely flowered form, with the stem rather naked above, exactly similar to those we often receive from the Southern States, as well as from Pennsylvania. The description of Clayton is so far correct, that it is probable the pale or greenish-yellow flowers alone have prevented all succeeding botanists from suspecting it to be the Linnæan plant. The specific name is certainly not happily chosen for a plant of which Clayton observes, "floribus obsolete luteis," but it must nevertheless be retained. The remarkable tooth or process on the upper side of the lip near the base, by which the plant is so well distinguished, is also unnoticed. I find the same species among the plants of Pursh, in Mr. Lambert's herbarium, under the name of *O. fuscescens*. This last species was established upon a figure and description of Gmelin's *Flora Sibirica*, which accord so well with the American plant, that, in the absence of specimens, I am unable to pronounce them distinct. The lip has the same lateral teeth, but, instead of the projecting process, Gmelin describes the posterior portion as "in cymbam fere excavata." The inspection of Willdenow's herbarium enables me to add as a synonym the *O. virescens* of that author; of whose character: "cornu obtusum scrotiforme brevissimum," it should be remarked that it is totally at variance with his own solitary specimen received from Muhlenberg, under this name. The latter, in his unpublished *Flora Lancastriensis*, thus describes the lip and spur:—"Labio nectarii oblongo emarginato indiviso et subtrilobo, vel basi utrinque dentato; cornu setaceum germine brevius, acutum." The synonymy of this species, so far as already ascertained, may stand as follows.

HABENARIA (PLATANThERA) FLAVA.

*Orchis flava*, Linn. ! *spec. ed. 1. p. 942, et ed. 2., excl. syn. Moris. hist., non Nutt.*

*Orchis radice palmata*; floribus obsolete luteis, &c. &c. *Clayt. ! no. 639.*

*Orchis radicibus palmatis*: nectarii labio trifido, integerrimo, &c. *Gronov. ! fl. Virg. ed. 2. p. 137.*

*Orchis virescens*, *Muhl. fl. Lancastr. ined., et in Willd. ! spec. 4. p. 37. (descr. pess.)*

*Orchis fuscescens*, Pursh! *fl.* 2. p. 587; *Ell. sk.* 2. p. 487, vix *Gmel.*

*Orchis herbiola*, Pursh, *l. c.* (quoad syn.)

*Orchis bidentata*, Ell. ! *sk.* 2. p. 488.

*Habenaria herbiola*, R. Br. ! *in hort. Kew.* (ed. 2.) 5. p. 193, *et auct. omn.*

*Habenaria virescens*, Spreng. *syst.* 3. p. 688. (quoad syn.)

*Habenaria fuscescens*, Torr. *compan.*

*Platanthera herbiola*, Lindl. ! *gen. et spec. Orchid.*

HABENARIA (PLATANTHERA) INTEGRÆ.

*Orchis integra*, Nutt. *gen.* 2. p. 188.

*Orchis flava*, Nutt. *l. c.*, non Linn.

*Orchis flava?* Ell. *sk.* 2. p. 485.

*Habenaria integra*, Spreng. *syst.* 3. p. 689; Beck, *bot.* p. 348.

*Habenaria Elliottii*, Beck! *l. c.*

This last species is very nearly allied to *H. (Platanth.) cristata*, but is readily distinguished by its subulate spur, entire petals, and nearly entire, crenate, or somewhat sinuately toothed labellum. Its geographical range is from New Jersey to Florida and Louisiana.

ORCHIS PSYCODES, Linn.—So great is the confusion of the synonymy, and so extensive the series of mistakes in regard to this species, that it becomes at first sight questionable whether the Linnæan name should not be altogether dropped. But as the description of Linnæus is perfectly applicable to the species he had in view, and to no other, we are not at liberty to pass by the original name; still less to apply it to a plant subsequently mistaken for this species. The *O. psychodes* is described from a plant collected in Canada, by Kalm, which is still preserved in the Linnæan herbarium. This plant I find to be, not the *Orchis lacera* of Michaux, as is generally supposed, but the *Orchis fimbriata* of Aiton and succeeding authors. The synonym of "*Orchis floribus aureis*," &c. of Gronovius, must be excluded, as it relates to *Orchis cristata* of Willdenow. The Gronovian plant, however, does not exist in the herbarium of Linnæus, neither does the character and description appear to have been at all derived from it. On the authority of the herbarium of Willdenow, and also from the manuscript detailed descriptions of Muhlenberg, I have ascertained that both the *Orchis incisa* and the *Or-*

*chis fissa* of these authors, are identical with the original *O. psychodes* of Linnæus; that is, are the ordinary smaller-flowered forms of *Orchis fimbriata*. Muhlenberg says of his *O. fissa*, that the flowers are very small; as indeed they are in the specimen sent to Willdenow, when compared with his *O. fimbriata*, (which is the *O. grandiflora* of Bigelow,) or with *O. fissa* of succeeding authors. *Orchis psychodes* of Willdenow, as to the plant in his herbarium, is *O. lacera* of Michaux. The synonymy of these species will therefore assume the following form.

HABENARIA (PLATANThERA) PSYCODES.

*Orchis psychodes*, *Linn. ! spec. 2. p. 493, excl. syn. Gronov., non Willd.*

*Orchis fimbriata*, *Ait. ! hort. Kew. (ed. 1.) 3. p. 297, et auct.*

*Orchis incisa*, *Muhl. ! fl. Lancast. ined., et in Willd. ! spec. 4. p. 40, non Pursh, nec Nutt.*

*Orchis fissa*, *Muhl. ! l. c. et in Willd. ! l. c. non Pursh, nec auct. seq.*

*Habenaria fimbriata*, *R. Br. ! in hort. Kew. (ed. 2.) 5. p. 193, et auct.*

*Habenaria incisa*, *Spreng. syst. 3. p. 692. (quoad syn.)*

*Habenaria fissa*, *Spreng. l. c. (quoad syn.,) non R. Br.*

*Platanthera fimbriata*, *Lindl. ! gen. et spec. Orchid.*

β. GRANDIFLORA: labelli segmentis (lateralibus præcipue) capillaceo-fimbriatis, floribus majoribus.

*Orchis fimbriata*, *Willd. ! l. c.*

*Orchis grandiflora*, *Bigel. ! fl. Bost. ed. 2. p. 321.*

*Habenaria grandiflora*, *Torr. ! compan. ; Beck, bot. p. 349 ; Darlingt. fl. Cest. ed. 2. p. 509.*

HABENARIA (PLATANThERA) PERAMCENA.

*Orchis palmata peramcena*, Caryophylli montani floribus, margine fimbriatis, ex Virginia. *Pluk. mant. p. 141, t. 434, f. 5.*

*Orchis fissa*, *Pursh ! fl. 2. p. 588, non Willd.*

*Orchis incisa*, *Pursh, l. c. ; Nutt. gen. 2. p. 189, non Willd.*

*Habenaria fissa*, *R. Br. ! in herb. Banks, non Orchis fissa, Muhl. et Willd.*

*Platanthera fissa*, *Lindl. l. c.*

HABENARIA (PLATANThERA) LACERA.

*Orchis radice palmata*: foliis lili, &c. *Clayt.*! no. 644; *Gronov.*! *fl. Virg.* p. 137.

*Orchis psycodes*, *Muhl.*! l. c.; *Willd.*! *spec.* 4. p. 39, non *Linn.*

*Orchis lacera*, *Michx.*! *fl.* 2. p. 156; *Pursh*, l. c.; *Ell.* l. c.

*Habenaria psycodes*, *Torr.*! *compan.*; *Beck!* l. c.

*Habenaria lacera*, *R. Br.*; *Spreng.* l. c.

*Platanthera psycodes*, *Lindl. gen. et spec. Orchid.*

HABENARIA (PLATANThERA) CRISTATA.

*Orchis floribus aureis*, spica habitiore congestis: bracteis longitudine floris: labio inferiore nectarii fimbriato capillaceo: seta germine brevior. *Clayt.*! no. 688; *Gronov.*! *fl. Virg. ed.* 1. p. 184.

*Orchis cristata*, *Michx.*! *fl.* 2. p. 156; *Willd.*! *spec.* 4. p. 9; *Pursh!* l. c.

*O. psycodes*, *Pursh*, l. c.? non *Linn.*, nec *Willd.*

*Habenaria cristata*, *R. Br.*! *in hort. Kew.* (ed. 2.) 5. p. 194, *et auct.*

*Habenaria psycodes*, *Spreng.* l. c.? (ex colore florum.)

*Platanthera cristata*, *Lindl.*! *gen. and spec. Orchid.*

Respecting *Habenaria* (*Plat.*) *orbiculata* and *Hookeri*, and also *H.* (*Plat.*) *dilatata*, I have only to remark, that the view suggested several years since, in the third volume of the Annals of the New York Lyceum of Natural History, is proved to be correct.

*Orchis obsoleta* of Willdenow (fide herb.!) is made up of the scape of a *Corallorhiza* and a leaf of *Tipularia*?

*Orchis limodoroides* of the same herbarium is *Tipularia* of Nuttall. To this also belongs "Orchis floribus sparsis, nectario pedunculum superante, labio infimo lineari." *Gronov.*! *fl. Virg.* p. 137.

Head of an Alligator from *Luconia*—drawn from the original in the Museum of the Boston Society of Natural History.

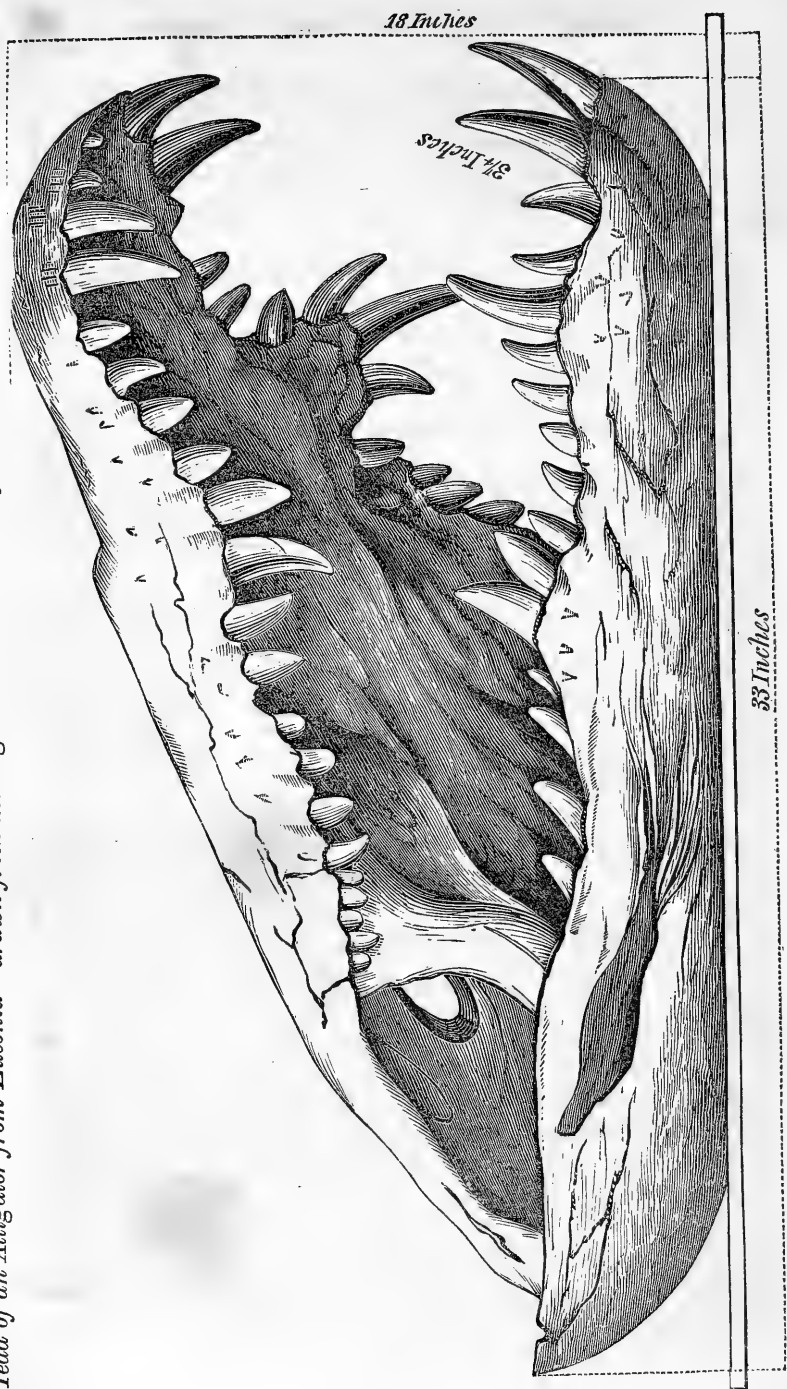

18 Inches

3 1/2 Inches

33 Inches

ART. XIV.—*Account of the Capture and Death of a large Alligator.* Communicated for this Journal at the request of the Editors, by a gentleman concerned in the affair.

## TO THE EDITORS.

THE interest you have manifested in the head of the alligator, deposited in the room of the Society of Natural History in this city, (see the annexed drawing,) and the request you have made that I would acquaint you with the circumstances of its capture, induce me to offer you the following sketch. Whatever imperfections may appear in it, must be attributed to the time that has passed since my residence at Manilla, near which place the alligator was killed.

The lake, from which flows the river on which Manilla is situated, is about twenty miles from that place. It is of irregular form, and from many points looks like three distinct bodies of water of about equal dimensions, caused by a long island nearly in the centre, and a wide tract of land parallel to and about eight miles from it. The latter, called Halahala, was a plantation which I occasionally visited, and was the property of a French gentleman, distinguished for his hospitality, and for a strength of character which had led him to establish himself successfully, alone and unaided, amidst a barbarous people, whose respect and love he had secured by his uniform courage, justice, and benevolence. A small part of the estate was cultivated by the hired Indians, whose huts formed a picturesque little village near the house of the proprietor, and the remainder, embracing a circuit of fifteen or twenty miles, gave every variety of natural beauty. A chain of high hills ran through the centre, whose summits were covered with grass so luxuriant as often to rise over the head of a man on horseback; and the forests on either side, extending in many places to the lake, were the growth of centuries. The axe had never thinned them, and they stood in their massive magnificence as nature had planted and reared them; some in fantastic forms, which gave them so much the appearance of works of art, as to be distinguished by the names of things they were supposed to resemble; some, vanquished by the creeping plant, which strangles in its close and deadly embrace what at first it clings to for support and protection, had struggled against

its folds till the destroyer and destroyed seemed one ; and the giant tree, which, year after year, had been rocked by the earthquake and had borne bravely against the whirlwind, slowly yielding to its tenacious persecutor, stood at last lifeless within its green and living shroud.

Amidst the wonders of nature, animal life has its full share ; and in the tangled recesses of the woods, where exuberant vegetation has given the earth a covering almost impenetrable to man, there live the deer, the boar, and that most desperate and dangerous enemy of the hunter, the wild buffalo, whose ferocity and contempt of danger is only equalled by his hatred of the human form. There is also the boa constrictor, sometimes seen of great size, who crushes in his folds and devours whatever first comes in his way ; and then, gorged and inactive, is easily despatched. One with a large deer inside of him, was killed when I was there, but had been cut up by the natives for food, before we were aware of it. Since I left that country, I have been informed that one thirty-five feet long has been destroyed, after killing two Indians, who entered a cavern where he had retired, one of whom he swallowed, and the other was found dead beside him.

The deep, still inlets of the more retired parts of the lake, are the lurking places of the alligators ; and one spot, remarkably situated, was their favorite resort. Nearly opposite to the point of Halahala, on the other shore, there issues from a mountain a stream of so high a temperature that the natives use it for cooking ; and the bones of fish and fowls, scattered at its sides and in its bed, show how commonly it is availed of for that purpose. Rude baths are constructed near it, which are found very serviceable in chronic diseases, and are sometimes visited by invalids from Manilla. Near this place is an island, in the centre of which is a small, deep, black lake, surrounded by hills, except at a narrow opening, which is low and marshy. The sides, as they slope to the margin, are thickly wooded, and the trees hang clustering over the banks, their dense foliage drooping to the water. Here reigns the stillness of death ; not a breath of wind penetrates the close barrier, and there is sound and motion on the glassy surface, only when it is rippled by the alligators, who have made the place their own. At other times they float like logs, or stretched along the mingled masses of decayed wood and exposed roots, enjoy the coolness and shade of this gloomy solitude.



In the course of the year 1831, the proprietor of Halahala informed me that he frequently lost horses and cows on a remote part of his plantation, and that the natives assured him they were taken by an enormous alligator, who frequented one of the streams which run into the lake. Their descriptions were so highly wrought that they were attributed to the fondness for exaggeration, to which the inhabitants of that country are peculiarly addicted, and very little credit was given to their repeated relations.

All doubts as to the existence of the animal were at last dispelled by the destruction of an Indian, who attempted to ford the river on horseback, although entreated to desist by his companions, who crossed at a shallow place, higher up. He reached the centre of the stream, and was laughing at the others for their prudence, when the alligator came upon him. His teeth encountered the saddle, which he tore from the horse, while the rider tumbled on the other side into the water and made for the shore. The horse, too terrified to move, stood trembling where the attack was made. The alligator, disregarding him, pursued the man, who safely reached the bank, which he could easily have ascended, but rendered fool-hardy by his escape, he placed himself behind a tree, which had fallen partly into the water, and drawing his heavy knife, leaned over the tree, and on the approach of his enemy, struck him on the nose. The animal repeated his assault and the Indian his blows, until the former, exasperated at the resistance, rushed on the man, and seizing him by the middle of the body, which was at once enclosed and crushed in his capacious jaws, swam into the lake. His friends hastened to the rescue; but the alligator slowly left the shore, while the poor wretch, writhing and shrieking in his agony, with his knife uplifted in his clasped hands, seemed, as the others expressed it, "held out as a man would carry a torch." His sufferings were not long continued, for the monster sank to the bottom, and soon after reappearing alone on the surface, and calmly basking in the sun, gave to the horror-stricken spectators the fullest confirmation of the death and burial of their comrade.

A short time after this event, I made a visit to Halahala, and expressing a strong desire to capture or destroy the alligator, my host readily offered his assistance. The animal had been seen, a few days before, with his head and one of his fore feet resting on

the bank, and his eyes following the motion of some cows which were grazing near. Our informer likened his appearance to that of a cat watching a mouse, and in the attitude to spring upon his prey when it should come within his reach.

I would here mention, as a curious fact, that the domestic buffalo, which is almost continually in the water, and in the heats of mid-day remains for hours with only his nose above the surface, is never molested by the alligator. All other animals become his victims when they incautiously approach him, and their knowledge of the danger most usually prompts them to resort to shallow places to quench their thirst.

Hearing that the alligator had killed a horse, we proceeded to the place, about five miles from the house. It was a tranquil spot, and one of singular beauty, even in that land. The stream, which a few hundred feet from the lake narrowed to a brook, with its green banks fringed with the graceful bamboo, and the alternate glory of glade and forest, spreading far and wide, seemed fitted for other purposes than the familiar haunt of the huge creature that had appropriated it to himself. A few cane huts were situated a short distance from the river, and we procured from them what men they contained, who were ready to assist in freeing themselves from their dangerous neighbor. The terror which he had inspired, especially since the death of their companion, had hitherto prevented them from making an effort to get rid of him ; but they gladly availed themselves of our preparations, and with the usual dependence of their character, were willing to do whatever example should dictate to them. Having reason to believe that the alligator was in the river, we commenced operations by sinking nets, upright, across its mouth, three deep, at intervals of several feet. The nets, which were of great strength, and intended for the capture of the wild buffalo, were fastened to trees on the banks, making a complete fence to the communication with the lake.

My companion and myself placed ourselves with our guns on either side of the stream, while the Indians, with long bamboos, felt for the animal. For some time he refused to be disturbed ; and we began to fear that he was not within our limits, when a spiral motion of the water, under the spot where I was standing, led me to direct the natives to it ; and the creature slowly moved on the bottom towards the nets, which he no sooner touched,

than he quietly turned back and proceeded up the stream. This movement was several times repeated, till, having no rest in the enclosure, he attempted to climb up the bank. On receiving a ball in the body, he uttered a growl like that of an angry dog, and plunging into the water, crossed to the other side, where he was received with a similar salutation, discharged directly into his mouth. Finding himself attacked on every side, he renewed his attempts to ascend the banks; but whatever part of him appeared was bored with bullets, and feeling that he was hunted, he forgot his own formidable means of attack, and sought only safety from the troubles which surrounded him.

A low spot, which separated the river from the lake, a little above the nets, was unguarded, and we feared that he would succeed in escaping over it. It was here necessary to stand firmly against him; and in several attempts which he made to cross it, we turned him back with spears, bamboos, or whatever first came to hand. He once seemed determined to force his way, and foaming with rage, rushed with open jaws, and gnashing his teeth, with a sound too ominous to be despised, appeared to have his full energies aroused, when his career was stopped by a large bamboo thrust violently into his mouth, which he ground to pieces, and the fingers of the holder were so paralyzed that for some minutes he was incapable of resuming his gun.

The natives had now become so excited as to forget all prudence, and the women and children of the little hamlet had come down to the shore to share in the general enthusiasm. They crowded to the opening, and were so unmindful of their danger that it was necessary to drive them back with some violence. Had the monster known his own strength, and dared to have used it, he would have gone over that spot with a force which no human power could have withstood, and would have crushed, or carried with him into the lake, about the whole population of the place.

It is not strange that personal safety was forgotten in the excitement of the scene. The tremendous brute, galled with wounds and repeated defeat, tore his way through the foaming water, glancing from side to side, in the vain attempt to avoid his foes, then rapidly ploughing up the stream he grounded on the shallows, and turned back frantic and bewildered at his circumscribed position. At length, maddened with suffering, and desperate from continued persecution, he rushed furiously to the

mouth of the stream, burst through two of the nets ; and I threw down my gun in despair, for it looked as though his way at last was clear to the wide lake. But the third net stopped him, and his teeth and legs had got entangled in all. This gave us a chance of closer warfare with lances, such as are used against the wild buffalo. We had sent for this weapon at the commencement of the attack, and found it much more effectual than guns. Entering a canoe, we plunged lance after lance into the alligator, as he was struggling under the water, till a wood seemed growing from him, which moved violently above, while his body was concealed below. His endeavors to extricate himself, lashed the water into foam, mingled with blood ; and there seemed no end to his vitality, or decrease to his resistance, till a lance struck him directly through the middle of the back, which an Indian, with a heavy piece of wood hammered into him, as he could catch an opportunity. My companion, on the other side, now tried to haul him to the shore, by the nets to which he had fastened himself, but had not sufficient assistance with him. As I had more force with me, we managed, with the aid of the women and children, to drag his head and part of his body on to the little beach, where the river joined the lake, and giving him the "coup de grace," left him to gasp out the remnant of his life on the sand.

I regret to say, that the measurement of the length of this animal was imperfect. It was night when the struggle ended, and our examination of him was made by torch-light. I measured the circumference, as did also my companion, and it was over eleven feet immediately behind the fore legs. It was thirteen feet at the belly, which was distended by the immoderate meal made on the horse. As he was only partly out of the water, I stood with a line at his head, giving the other end to an Indian, with directions to take it to the extremity of the tail. The length so measured, was twenty-two feet ; but at the time I doubted the good faith of my assistant, from the reluctance he manifested to enter the water, and the fears he expressed that the mate of the alligator might be in the vicinity. From the diameter of the animal, and the representations of those who examined him afterwards, we believed the length to have been about thirty feet. As we intended to preserve the entire skeleton, with the skin, we were less particular than we otherwise should have been. On opening him, we found, with other parts of the horse, three

legs entire, torn off at the haunch and shoulder, which he had swallowed whole, besides a large quantity of stones, some of them of several pounds weight.

The night, which had become very dark and stormy, prevented us from being minute in our investigation; and leaving directions to preserve the bones and skin, we took the head with us and returned home. This precaution was induced by the anxiety of the natives to secure the teeth; and I afterwards found that they attribute to them miraculous powers in the cure or prevention of diseases.

The head weighed near three hundred pounds; and so well was it covered with flesh and muscle, that we found balls quite flattened which had been discharged into the mouth and at the back of the head, at only the distance of a few feet, and yet the bones had not a single mark to show that they had been touched.

I would observe, that the head, as it now appears, conveys a feeble impression of its size before it was divested of its integuments.

I returned shortly after to Manilla, and expected to have been followed by the bones and skin of the alligator. They were drying on a scaffold, near the place where he was killed, when a typhon, or hurricane, of unexampled severity, which laid low the cabin of the Indian and the tree of the forest, and covered the shores of the lake with the bodies of man, and beast, and fish, swept away the platform and whirled into the lake or the jungle, every fragment of our victim.

The head was an object of great curiosity at Manilla, nothing of similar size having been seen there; and on a visit which I subsequently made to Europe, I examined, with some attention, the museums of natural history, particularly those of France and England, without finding any thing of equal magnitude.

While the head was at Manilla, an English frigate arrived there that had been long on the East India station. The officers had, at Ceylon, killed an alligator of extraordinary size, the skeleton of which they intended to send to the British Museum. They expressed however their disinclination to do so, after seeing that from Halahala, which was much larger than the one they had taken.

In comparing notes with them respecting the nature and habits of this animal, I was struck with the similarity of the supersti-

tions prevailing at Ceylon and Luconia; such as the alligator swallowing a stone whenever he kills a human being, as if to keep account of his misdoings, and, after devouring the body, placing the head before him and weeping from remorse.

It is not strange that extravagancies like this should be current with so rude a people; but it is singular that two, remote from each other and without connection, should both give credit to the same absurdities.

The native of Luconia, the island on which Manilla is situated, is excessively fond of the marvellous. He is ever ready to give supernatural constructions to every thing that cannot be solved at once; and there is no limit to his credulity. One night, in the country, my attention was directed to a light midway on a mountain, which I naturally attributed to a fire made by some one who had lost his way—as proved to be the case—not so the Indians. It was too favorable an opportunity to let pass with such a common-place supposition. They said an anaconda had found a stone of inestimable value, and, according to his usual practice, when in such luck, was playing at cup and ball with it. They could see the gorgeous gem, sparkling with light, tossed into the air; and the serpent bounding from the earth, as he caught it in his mouth, or rapidly twining among the trees, as with wild glee, he pursued his game.

I sometimes visited a place so secluded and difficult of access, that probably no human feet had ever reached it. There the enormous vampire bat, or flying fox, slept away the hours of daylight; and hanging to the boughs by his hooked claws, with his head downward and his wings folded like a cloak about him, waited till night should enable him to look for the plantain, his accustomed food. There thousands of the animals congregated, and when disturbed by the report of a gun, rose with screams, darkening the air with their heavy flight, and encircling the woods they dared not leave. Little was required to invest a spot like this with mystery; and well might the islander fancy, as the black wings flapped like evil spirits around him, that he stood on unhallowed ground.

At the time of our expedition against the alligator, the periodical visitation of locusts, which occurs about once in seven years, was devastating parts of the island; and, on the following day, the place where I resided was doomed to share in the distress.

We were flattering ourselves that the scourge would not come near us, when the dark clouds were seen, far over the lake, approaching noiselessly, save in the rushing of wings, and soon the sun was hid, and night seemed coming before her time. Mile upon mile in length moved the deep broad column of this insect army; and the cultivator looked and was silent, for the calamity was too overwhelming for words. The sugar cane, the principal crop of that country, gave promise of unusual productiveness when the destroyer alighted. In a moment nothing was seen, over the extended surface, but a black mass of animated matter, heaving like a sea over the hopes of the planter. And when it arose to renew its flight, in search of food for the hungry millions who had had no share in the feast, it left behind, desolation and ruin. Not a green thing stood where it had been, and the very earth looked as though no redeeming fertility was left to it. Human exertions availed nothing against this enemy; wherever he came he swept like a consuming fire, and the ground appeared scorched by his presence. Branches of trees were broken by the accumulated weight of countless numbers; and the cattle fled in dismay before the rolling waves of this living ocean. The rewards of government and the devices of the husbandman, for his own protection, were useless. Myriads of these insects were taken and heaped together, till the air for miles was polluted, without apparent diminution of their numbers.

The typhon was the irresistible agent which at last terminated their ravages, and drove them before it far into the Pacific. This remedy prostrated what the locust had left, but still it was prayed for as a mercy, and received with thanksgiving.

Of the Philippine Islands, Luconia is the one best known; but the world of nature there is yet unexplored; and the few men of science who have been permitted to carry their researches into the interior, have either been too easily satisfied with the wonders they encountered at the outset, or have not been spared to give the result of their labors. The one best fitted for the work, who visited that country during my residence in it, was an Italian. He penetrated where the white man had not been seen since the earliest days of the colony, when the followers of Magellan made the circuit of the island, with the daring spirit of investigation which distinguished that age of discovery.

He made his way to the wandering negro tribes which roam through a tract of mountain country, near the middle of the island, and who, uninfluenced by the semi-civilization around them, pass an erratic life without fixed habitations, gathering their food from the wild fruit trees, and offering wide field for conjecture on their origin and insulated position.

The individual I allude to, returned from his interesting excursions, stored with most valuable information. His indefatigable spirit was undaunted at the great plan he had laid out before him, and he left Manilla with the determination to penetrate to the centre of Borneo—that unknown world, whose savage inhabitants have not been overcome or softened, even by the cupidity of commerce, and whose resources can only be imagined from its magnitude, situation, and the exceeding fruitfulness of its coasts. He had scarcely entered on his new discoveries, when approaching too near a volcano, he slipped into the hot ashes of its burning crater, which in a few days caused his death.

If, in recurring to some of the incidents of my life in Luconia, I have inclined to dwell on what may seem irrelevant to the object of this communication, it is that I am fond of remembering the days I have passed in the solitudes of that lovely land. The dreams of fancy have never pictured scenes of more romantic beauty than are there lavishly spread around;—where the principle of life is profusely scattered and every thing is glowing with animated being—where the bland air makes mere existence enjoyment; and the day, with its mild sky and refreshing sea breeze, gives place to the more serene night, with her clear brilliancy, when the eye looks deep into heaven, and the stars glitter with a radiance unknown in less genial climes—where the land wind rises, and is felt, but not heard, for the stillness of midnight is not broken as its soft breath comes from the untrodden depths of the wilderness, laden with the fragrance of the spice tree and the wild flower.

But in that luxurious region, nature at times shows herself in the power and sublimity of her convulsions, and awes by the earthquake, the tornado, and the thunder storm. Her hours of anger are fearful, but are soon forgotten as she resumes her almost permanent tranquillity.

Boston, Feb. 12, 1840.



ART. XV.—*Synopsis of a Meteorological Journal, kept in the city of New York for the years 1838 and 1839, including also the mean results of the last seven years; by W. C. REDFIELD.*

(Reported to the Regents of the University of the State of New York.)

THE observations which I have made on the direction of the surface winds, and also on the direction of the highest observed wind in the region of clouds, for periods of four hours duration, commencing at 6 A. M., and ending with 10 P. M., are comprised in the following tables.\*

*Monthly and annual results for the year 1838.*

1838.—Months.	Observations of the surface winds, in periods of four hours.				Observations of highest observed wind in the region of clouds, in periods of four hours.			
	From N. E. quarter including N.	From S. E. quarter including E.	From S. W. quarter including S.	From N. W. quarter including W.	From N. E. quarter including N.	From S. E. quarter including E.	From S. W. quarter including S.	From N. W. quarter including W.
January, . . .	19	7	91	36	5	3	119	15
February, . . .	15	7	35	78	0	0	37	52
March, . . .	61½	19½	33½	34	11	1	25	59
April, . . .	27	16½	43	56½	0	4	32	80
May, . . .	19	19½	79½	24	2	4	60	59
June, . . .	22½	46½	59½	17	4	5	83	29
July, . . .	19	10	81½	39½	6	0	27	90
August, . . .	16	28½	56½	46½	1	0	39	77
September, . . .	40½	21½	48½	27½	7	1	73	8
October, . . .	13½	12	63	43	1	8	63	33
November, . . .	18	21	54½	51½	0	0	71	34
December, . . .	11½	6	74½	54	0	0	84	31
Annual results,	282½	215	720	507½	37	26	713	567
Proportion in 1000,	164	125	417	294	28	19	531	422

\* For summaries of the observations from 1833 to 1837 inclusive, see the Reports of the Regents of the University of the State of New York, made to the legislature in 1835 and 1837, and Am. Jour. of Science, Vol. xxviii, pp. 154—159, and Vol. xxxiv, pp. 373—376.



*Table of the Monthly mean height of the Barometer in inches for each of the five daily observations recorded in the Journal during the year 1838.*

1838.—Months.	6 A. M.	10 A. M.	2 P. M.	6 P. M.	10 P. M.	Monthly means.
January, . . .	30.242	30.258	30.219	30.246	30.265	30.246
February, . . .	30.044	30.072	30.017	30.021	30.046	30.040
March, . . .	30.138	30.164	30.129	30.121	30.146	30.140
April, . . .	30.056	30.079	30.029	30.025	30.054	30.049
May, . . .	29.983	29.999	29.971	29.955	29.976	29.977
June, . . .	30.033	30.053	30.034	30.022	30.048	30.038
July, . . .	30.180	30.094	30.065	30.049	30.070	30.072
August, . . .	30.051	30.160	30.129	30.106	30.141	30.137
September, . .	30.185	30.196	30.177	30.160	30.181	30.180
October, . . .	30.073	30.085	30.045	30.050	30.084	30.067
November, . .	30.236	30.277	30.219	30.220	30.243	30.239
December, . .	30.094	30.143	30.094	30.121	30.150	30.120
Mean annual results,	30.110	30.132	30.094	30.091	30.117	30.109

*Table of the Monthly mean height of the Barometer in inches for each of the five daily observations during the year 1839: to which are added the mean average results for the last seven years.*

1839.—Months.	6 A. M.	10 A. M.	2 P. M.	6 P. M.	10 P. M.	Monthly means.
January, . . .	30.198	30.207	30.141	30.188	30.248	30.194
February, . . .	30.222	30.281	30.205	30.206	30.224	30.227
March, . . .	30.116	30.163	30.122	30.112	30.142	30.131
April, . . .	30.089	30.115	30.075	30.057	30.084	30.084
May, . . .	30.031	30.065	30.020	30.000	30.017	30.027
June, . . .	29.971	29.999	29.974	29.968	29.989	29.980
July, . . .	30.033	30.040	30.024	30.016	30.033	30.029
August, . . .	30.097	30.109	30.105	30.104	30.098	30.103
September, . .	30.097	30.128	30.093	30.081	30.099	30.100
October, . . .	30.281	30.316	30.263	30.241	30.266	30.273
November, . .	30.160	30.203	30.154	30.161	30.185	30.173
December, . .	29.948	29.980	29.935	29.954	29.974	29.958
Mean annual results,	30.104	30.134	30.092	30.091	30.113	30.106
Means for seven years,	30.101	30.122	30.088	30.086	30.108	30.101

It will be seen that the monthly means of the atmospheric pressure in 1838, are found highest in January and November; being equal to nearly thirty and a quarter inches of the barometric column. The lowest is found in May, being less than thirty inches. The highest monthly means for 1839 are found in February and October; the latter exceeding that of any month which I have observed; although not comprising the highest ranges of

the year. This effect appears to be due to the proximity of several violent storms of wind which passed over neighboring regions during the month, but did not visit New York. The mean for December of this year, is uncommonly low, and it is believed to be due to the dispersive effect exerted upon the atmosphere by the several violent and extensive storms which passed over us during the month.

The means of the several daily observations for seven years, show an excess in those assigned to 10 A. M.; also, a probable disproportion in those for 6 A. M. The former is probably owing chiefly to the fact that the observations for that hour, in most cases, are necessarily anticipated, and approximate more nearly to 9 A. M., and are taken at or near the time of the daily maximum of elevation; while the latter are perhaps slightly increased by the fact that for a portion of the year the hour assigned is too early for convenient observation. It is not improbable, that the mean of the two observations at 6 P. M. and 10 P. M., gives more nearly the true average pressure for the whole term of years, being 30.097; while the general mean in the table is 30.101.

My barometer has a glass cistern, and tube of  $\frac{4}{15}$ ths of an inch diameter, the scale for which was adjusted at a pressure of thirty inches and temperature of  $68^{\circ}$  F.; capacity of the tube to cistern  $\frac{1}{4}$ ; and the instrument is fitted up in a basement room, the cistern being less than ten feet above the mean level of the tide in New York harbor.

Through the kindness of Lieut. Riddell, R. A., the officer in charge of the new magnetic observatory in Canada, I had an opportunity, in September last, of comparing the adjustment of my barometer with one of Newman's portable iron-cisterned barometers, sent as a standard of comparison from the Royal Society. This comparison, made at the temperature of  $59^{\circ}$  F., showed an excess of 0.015 in. in my barometer, over that of the Royal Society. This agrees nearly with my own admeasurement; but I had allowed the excess as compensation for the capillarity of the tube, in order to avoid the necessity for this correction. If, however, this difference is to be deducted from the above general mean, it will give for the mean annual pressure at New York, 30.086 inches; or, if the mean of the hours of 6 and 10 P. M. be taken, we have 30.082 in. This is without any correction for temperature. The mean temperature of the instrument for the entire period is supposed to be about  $68^{\circ}$  Fahrenheit.

A Table showing the Monthly Maximum and Minimum and Range of the Barometer at New York for the year 1838.

1838.—Months.	Monthly maximum and date.	Monthly minimum and date.	Monthly range.
January, -	1st, winds high, followed by good weather,	19th, wind S. S. W.; change of a S. E. storm,	1.11
February, -	1st, after a long northwester,	16th, wind N.; veering of a N. E. storm,	1.33
March, -	4th, wind light and var.; a S. E. storm follows,	29th, wind W.; change of storm from N. E. by N.,	1.20½
April, -	17th, wind light; a S. E. storm follows,	9th, wind W. S. W.; change of easterly storm,	.82
May, -	15th, wind S. W.; a storm before and after,	5th, easterly storm,	.87
June, -	20th, closing of thick easterly weather,	5th, wind N. E., close of easterly gale,	.85
July, -	14th, after a low barometer; follows fair,	30th, wind W. N. W.; a fair weather period,	.59
August, -	20th, closing up of the storm of 16th,	15th, change of S. E. storm to N. W.,	.63½
September, -	26th, strong easterly winds and rain,	13th, N. E. gale, hurricane at sea,	.80
October, -	17th, preceded and followed by storms,	30.59½ 11th, change of easterly storm,	1.00½
November, -	11th, closing up of a storm,	5th, wind N., veering of N. E. storm,	1.45½
December, -	31st, closing up of a slight storm,	30.99½ 23d, change of southerly storm,	1.45½
Annual results,	November 11th, - - - - -	February 16th, - - - - -	1.91½

In this Table the correction for variation in the cistern is made in the entries.

The maximum for the year was the greatest which had been observed from the commencement of my observations; it having followed the closing or westerly wind of a southeast storm which appeared two and a half days previous; and for five days following the barometer did not fall below 30 inches. The maximum of this atmospheric freshet was observed at Hudson, Ohio, by Prof. Loomis, on the 10th of November, at 11 A. M.; at Ogdensburg, N. Y., by John H. Coffin, on the 11th, about 8 A. M.; at Montreal, L. C., by J. S. M'Cord, from 9 A. M. till noon of the 11th; at New York, at 9 A. M.; at Providence, R. I., at 10 A. M. or later. In lat. 40° 34', lon. 55° 35', on the 14th, by Joseph C. Delano; and on the 16th, by the steamer Liverpool, latitude and longitude unknown. At the close of December there was a still greater rise of the barometer, which followed a storm of but moderate intensity, and reached its maximum on the first of January, 1839.

The greatest fall of the barometer in 1838, was on the 16th of February, at 6 P. M., under the veering of a N. E. storm to W. N. W. The wind during the greater part of the 16th hung at N., the barometer falling with a steady fall of frozen *rain drops* or small hail, while the thermometer was 9° to 11° below the freezing point; showing, as I think, the presence of a warmer stratum or current of wind in the region of clouds. When the wind had veered to N. W. the barometer commenced rising.

*A Table showing the Monthly Maximum and Minimum of the Barometer at New York for the year 1839 : with the Range for seven years, from 1833 to 1839 inclusive.*

1839.—Months.	Monthly maximum.	Monthly minimum.	Range.
January,	1st, follows a light S. E. storm,	31.07½	26th, change of a violent S. E. gale, 28.88
February,	12th, follows a light storm,	30.57	28th, change of E. N. E. storm by N. to N. W., 29.39
March,	31st, follows a light E. N. E. storm,	30.70	9th, change of an easterly storm, 29.43
April,	3d, strong settled E. N. E. winds,	30.45	17th, N. E. gale changing by N., 29.53
May,	8th, settled easterly winds,	30.38	3d&28th, change of S. E. storm, light easterly do. 29.60
June,	7th, light S. wind, preceded and foll'd by storms,	30.30	22d, light southerly storm, 29.70
July,	18th, between two light S. E. storms,	30.31	11th, change of S. S. E. storm, 29.70
August,	14th, settled easterly winds,	30.38	9th, change of a light S. E. storm, 29.68
September,	3d, do. do.	30.47	9th, change of a light southeasterly storm, 29.80
October,	6th and 21st, do. do.	30.78	30th, edge of a neighboring storm, 29.87
November,	22d, between two storms,	30.86	5th, change of an E. gale to W., 29.50
December,	31st, closing up of storm of 28th,	30.36	28th, lull and change of a hard easterly gale, 28.89
Annual results,	January 1st,	31.07½	January 26th, 28.88
Do. correct. 1.40 for var. in cist.	As corrected,	31.10	As corrected, 28.85
Range for seven years,	January 1st, 1839,	31.10	January 26th, 1839, 28.85

The extraordinary accumulation of atmosphere on the first of January reached its maximum at 10 A. M., the height of the barometer, as corrected, being 31.10 inches. The barometer also continued above 30 inches for six days. A severe gale is known to have appeared in the Atlantic on the first of January not far from our coast; and it is not improbable this was the same storm which on the 6th caused so much destruction on the coast of England. A southeast storm had also preceded this unusual rise of the barometer.

The greatest depression of the barometer which I have yet observed, took place on the 26th of January; the mercury then falling to 28.85 inches at the crisis or change of a violent southeast gale.\* This fall of the barometer was from a previous elevation of 30.43 inches, and took place for the most part within twenty four hours; the rapidity of descent being in this case proportioned to the violence of the gale. Its rise, however, as is not uncommon in the case of great overland storms, was prolonged to a much greater period, as was also the less violent

\* A nearly equal fall of the barometer took place in the violent storm of December 23th.

westerly wind which followed or closed up the easterly gale. This storm broke up the heavy ice in the Hudson for ten miles below Albany, and will long be remembered for the damages which it occasioned. It is not a little remarkable that the maximum, minimum and extreme range of the barometer for a period of seven years, should all have occurred in this month.

The fluctuations of the barometer and other phenomena which characterize our great storms, can only be thus cursorily alluded to in this place; but they have strong claims to the attention and inquiries of all observers; and when duly investigated, will probably add more to our knowledge of the laws of storms and atmospheric changes than all the mean results of instrumental observations which have been so industriously sought by philosophers and men of science. Of the available means for ascertaining these phenomena, few are more promising than the system of observation which is organized under the direction of the Regents of the University. It is now only necessary, that accurately adjusted barometers be furnished for two or three selected stations in each of the senatorial districts, and that the observations of this instrument, for fixed hours, be returned to the Regents with the usual annual reports.

New York, January 22, 1840.

---

ART. XVI.—*Notice of a Manual of Chemistry, containing the principal facts of the science, in the order in which they are discussed and illustrated in the Lectures at Harvard University, N. E., and several other colleges and medical schools in the U. States. Compiled and arranged as a text-book for the use of Students and persons attending Lectures on Chemistry. Third edition, comprising a summary of the latest discoveries, as contained in the works of Brande, Turner, Thomson, and other distinguished Chemists, illustrated with upwards of two hundred engravings on wood; by JOHN W. WEBSTER, M. D., Erving Professor of Chemistry and Mineralogy in Harvard University. 1 Vol. 8vo. pp. xxii, 556. Boston: Marsh, Capen, Lyon & Webb. 1840. (Communicated.)*

Two editions of the Manual of Chemistry by Dr. Webster, have already been presented to the public, by means of which it has become extensively known among men of science; its char-

acter has long since been established, and its merits as a work of reference and a text-book have been admitted and duly appreciated. Indeed, as a text-book it was introduced into many of our colleges, and continued to be employed in them so long as copies could be procured. The second edition was long ago exhausted, and although the demand for the work continued unabated to the last, such were and are the arduous duties of the author, as Professor of Chemistry in the University at Cambridge and in the Medical School at Boston, that we have been somewhat apprehensive lest sufficient leisure should not be left him to prepare another edition, considering the labor required properly to digest the amount of material which has so abundantly accumulated of late years, and bearing in mind the many discoveries in, and important additions to, the science that it was necessary to post up. We are however not only highly gratified to find our fears at length happily and satisfactorily removed, but are also much pleased to observe the improved appearance of the work, and to notice the many important and judicious changes that have been made in it.

This edition may indeed be almost considered as an entirely new work, so thorough a revision is evident on every page; affording ample evidence of the unremitting care, patient research, sound judgment, and nice discrimination, that were exercised to render it in all respects what a Manual should be; perspicuous, comprehensive, and withal concise. The author never sacrifices sense to sound; he never leads the reader away from the subject; and as he is dealing with facts, he proceeds in a strictly philosophical manner. He avoids the two extremes; being neither so brief as to bewilder and confuse, nor so prolix as to weary and disgust. Frequently, whilst examining its pages, have we been forcibly reminded of the truth of a remark made by the celebrated surgeon, Pott. "Any man," observed he, "may give an opinion, but it is not every mind that is qualified to collect and arrange important facts." All the great principles of the science are clearly laid down, and most of the recent discoveries are incorporated in its pages. So solicitous indeed has Dr. Webster evidently been to present every thing of value that was made known in his favorite science to the moment of sending the last page to press, that it will be found, by referring to the Addenda and Appendix, he has incorporated every discovery of any worth



which had been announced, down almost to the very day of publication. This edition is better printed than those were that preceded it. There is one change that in an especial manner pleases us, and for which, unless we greatly err, he will receive the thanks of every student; we mean the introduction of neat and well executed wood cuts into the body of the work, instead of the insertion of the illustrations at the end. The advantage of the former over the latter plan is too obvious to require designating.

In a short preface, or advertisement as it is styled, the author informs us that owing to the adoption of Dr. Turner's Elements into several institutions, (the Manual being out of print,) and knowing that Dr. T. was preparing a new edition for the press, he was induced to relinquish, for the time, the publication of the present work. Subsequently, he was prompted to renew his labor and perfect his design, from ascertaining that Dr. Turner's work was *left incomplete* at the time of the decease of that good man and most excellent chemist. That he *was* prompted to finish that which he had undertaken we rejoice at; because the "Elements," admirable as is the work, is not practical; it is not a work that a beginner can follow *experimentally*; and yet this course is the only one whereby chemistry can be profitably and satisfactorily studied, and thoroughly and advantageously taught.

The present work, we are told by Dr. Webster, is *compiled* and *arranged* by him. Such a task, if faithfully and judiciously executed, requires no less intimate a knowledge of the subject, and demands a far greater amount of labor than the writing of an original treatise. Indeed, we can hardly say that we have or can have an entirely original treatise on practical chemistry. All of our manuals and systems are in truth, for the most part, compilations; they must from the very nature of the subject be made up of the thousand facts, experiments, discoveries, deductions, &c., that are to be found scattered through a vast number of scientific journals, transactions, memoirs, and other publications.

Whilst perusing the volume, we continually see abundant evidence that the author spared no pains in collecting, examining, and duly arranging his materials, and that he often condensed elaborate papers, clothing their substance in language of his own, the more surely to bring them within the comprehension of the reader. Some may think that he is occasionally too concise, but his references to the original sources are always given, so that the

student, if not satisfied with the condensed or abridged account, knows where to seek for farther details. It is pleasing to observe how scrupulously the author "renders unto Cesar the things that are Cesar's," and bestows honor upon whom honor is due, by crediting every important observation or discovery to its rightful owner; an act of justice that is too often neglected.

Dr. Webster alludes to Prof. Bache, the accomplished editor of the American edition of Turner's Elements, in well merited terms of commendation. To Mitchell, Hare, Silliman, Jackson, Hayes, Torrey, and others, that we with pride rank among our prominent scientific men, he gives due acknowledgment for such of their labors as come within the scope of his work. The various valuable pieces of chemical apparatus figured and described, which are the products of the inventive genius of some of our own scientific men, are attributed to those to whom he is indebted for them; and the same just course is pursued in regard to many of the processes and experiments mentioned.

The arrangement of the subjects in this edition is quite different from that which was followed in either of the former editions. It is very nearly that of Turner; and a better model could not have been selected. The first chapter treats "of the Powers and Properties of Matter, and of the general laws of chemical changes;" and in it are incorporated the new facts relating to heat, electricity, and galvanism. The discoveries and deductions of Dr. Faraday are given principally from the lucid and satisfactory statements of Dr. Turner, some additions being made to the account from Faraday's later papers. The very curious and interesting observations of Forbes, on the *polarization* of heat, are also referred to in this chapter.

The second chapter is a highly important one, inasmuch as it contains the very *alphabet* of the science, without a knowledge of which every thing would be as unintelligible and as incomprehensible as the alchemistic gibberish of former days; and also a full description of the apparatus to be used, and the manner of using it, without a familiarity with which, all previous knowledge would be of little practical advantage. This chapter is divided into three sections; the first embracing an outline of the new nomenclature, with an explanation of the principles upon which it is founded; the second, a detailed account of "Apparatus and Manipulation," fully and clearly illustrated by explanatory cuts;

the third describes the various methods of estimating the specific gravities of solids, liquids, and gases. The author in this chapter has not confined himself exclusively to an account of matters as they are at the present time, but to a certain extent has combined historical with practical information ; thus furnishing the student with sufficient knowledge of the views and opinions entertained at various periods, to enable him easily to trace the progress of the science through various devious paths to its present state of advancement.

The third chapter is occupied with "Inorganic Chemistry," and contains a history, an account of the nature and properties, and the methods for the obtaining, of oxygen, hydrogen, nitrogen, carbon, sulphur, chlorine, &c. &c., and also a description of their compounds. The various theories of combustion are herein spoken of, the analysis and synthesis of water shewn, eudiometry is described, and numerous other important topics are discussed. Under the section on carbon, whilst speaking of carbonic acid, the important results of the experiments of Dr. Mitchell of Philadelphia, on the liquefaction and solidification of this gas, are stated. On Plate I, facing page 13, will be found represented the apparatus of Mr. Adams, which was contrived for the purpose of obtaining the gas in a solid state and on a large scale. It is accompanied by a full description of every part of the generator and receiver, of the proportions of the materials used, of the method of charging the generator, and of the manner of obtaining the solid result. It is the only account of this apparatus which we have seen ; and it seems hardly credible that it can sustain uninjured, the immense pressure to which it is subjected. It has however been fully tested, and we presume is the same with which Dr. Webster obtained the very large quantities of this solidified gas, which we understand he exhibited in his lectures before several societies during the winter just past.

The fourth chapter includes, under seven sections, an account of the metals. All of the important characters and properties of each are given, and then follow descriptions of the oxides, chlorides, &c.

In the fifth chapter we find the salts of the metals. These are arranged under four orders ; the author very wisely adopting the division into oxy-salts, hydro-salts, sulphur-salts, and haloid-salts, which we deem the best that has yet been devised. The com-

position of these substances, and indeed of all other important ones, is given in symbolic language after the name of each, as is also the atomic weight. This plan is a decided improvement over the tabular arrangement introduced by Turner. It saves the student much trouble, and the vexatious labor he would have to undergo in referring back to ferret out the name of a substance contained somewhere, in a long table. The descriptions of the metallic salts are selected mainly from the excellent ones of Turner and Liebig.

The four remaining chapters treat of organic chemistry, under which are embraced both animal and vegetable chemistry. This reminds us to remark, that Dr. Webster has rejected the old divisions just alluded to, and recognizes in his Manual two great divisions only; viz. the chemistry of unorganized and that of organized bodies. Under the second general division, the author, manifestly with great labor, has compressed within the compass of one hundred and fifty pages, most of the important matter to be found in the late elaborate and masterly volume of Dr. Thomson. That volume contains upwards of one thousand closely printed pages, and of course is a very unwieldy tome; we therefore are under no small obligations to Dr. W. for furnishing us with so excellent an abridgment of it. He also introduces, in this part of the work, the views and theories of Liebig. Although the chemistry of animal substances is very important, still, as the time devoted to this department in most of our institutions and in almost all courses of lectures, is very short, Dr. W. has not thought best to enter much into detail in the chapter appropriated to this subject. In this portion of the work he has followed Dr. Reid, and what has been furnished will be found amply sufficient for all purposes of elementary instruction.

As has already been incidentally mentioned, numerous important addenda are placed near the end of the work, followed by an Appendix, made up of tables and other valuable matter, a very copious general index, and an index of cuts.

We have also already alluded in very general terms to the fact of this volume being liberally supplied with wood engravings; they amount to upwards of *two hundred* in number. The vast number of experimental illustrations, and the careful directions as to manipulations, many of which are, if we mistake not, original, and many others we know have not hitherto been introduced into

works of general use, will greatly enhance the value of this Manual, and render it the more acceptable both to teachers and students. The arrangements of apparatus, and the descriptions of the figures are unusually full and complete. In the frontispiece we find represented Dr. Charles T. Jackson's newly invented oxy-alcohol and air-blast lamp, which possesses great power. We also find in the frontispiece a figure of a new air-pump of great simplicity and beauty, recently made for Harvard College. It was constructed by N. B. Chamberlain, Philosophical Instrument Maker, School street, Boston; and we learn from the Manual that it will freeze water on Leslie's plan, with perfect ease and great rapidity. It affords us much pleasure to direct attention to this instrument, as we can well remember how extremely difficult it was, until within a few years, to get chemical and philosophical apparatus of good quality made in this country. We were often compelled to forego the pleasure of prosecuting our investigations, and of following along the paths newly opened by our transatlantic brethren; to make the essay with inferior instruments and the almost positive knowledge that we should in consequence fail of attaining the desired result; or to lose much valuable time and expend much money in ordering the requisite instruments from Europe. This difficulty was owing in part, undoubtedly, to our artists not having been duly encouraged to exert their ingenuity and skill. Dr. Webster informs us that all the apparatus figured and described in his work, is or can be made by Mr. Chamberlain. As therefore there is no longer any deficiency of skill or ingenuity upon the part of artists, we trust there will be no withholding of patronage upon the part of our men of science; and most sincerely do we hope, for the honor of our country, that public institutions as well as individuals, will be more patriotic than to send abroad for apparatus, when it can be so well and so cheaply made under their own inspection at home.\*

We cannot close this notice, without expressing a desire that Dr. Webster would abridge his Manual for the use of the higher classes of schools and of academies. A good text-book is much needed in such seminaries.

---

\* It is but justice to our excellent artists and to the progress of practical as well as theoretical science among us to say, that our principal cities now contain establishments, in which almost every kind of philosophical apparatus is manufactured with elegance and skill.—*Eds.*

ART. XVII.—*Engraving and Description of an Apparatus for the Decomposition and Recomposition of Water, employed in the Laboratory of the Medical Department of the University of Pennsylvania; by R. HARE, M. D., Prof. of Chem. Read before the Amer. Philos. Society, Dec. 7, 1838.*

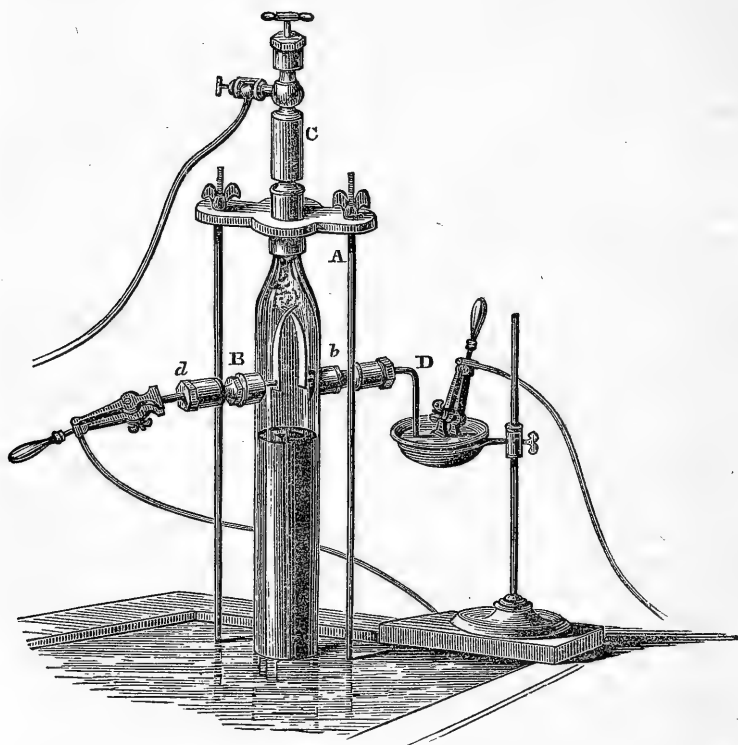

HAVING to illustrate the decomposition and recomposition of water to a class of between three and four hundred pupils, I have found it expedient to exhibit the process on an extensive scale.

For many years I have employed a glass tube, of about an inch and a half in bore, and about two feet in height.

The tube (A), which I have used for three years past, has been furnished with two tubulures (B, *b*), about three inches below the upper extremity, where it converges to an apex, having an aperture not larger than a goose quill. Upon this apex there is an

iron cap, in which a female screw is wrought so as to allow a large iron valve cock (C) to be screwed to it.

Upon the tubulures also iron caps are cemented, which are so wrought as, with the aid of appropriate screws, to constitute stuffing boxes.

Through each of these a platina rod (D, *d*) is introduced, and fastened to plates of platina, to act as "*electrodes*," agreeably to the language of the celebrated Faraday.

The tube being supported over the mercurial cistern, by means of a communication with an air pump, through the valve cock and flexible leaden pipe, the bore of the tube is exhausted of air, so as to cause the mercury to take its place.

The mercury is so far displaced by a solution of borax, consisting of equal parts of water and saturated solution of that salt, as to sink the surface of the column of metal in the tube about an inch or more below the "*electrodes*." The projecting end of one of the rods (D, *d*,) to the other ends of which the "*electrodes*" are severally attached, is bent at right angles outside of the tube, so as to enter some mercury in an iron capsule, supported purposely at a proper height, and communicating with one end of my deflagrator of an hundred pairs of Cruickshank plates of about eight inches by foureteen. Of course the rod of the other electrode must have a communication with the other end of the deflagrator. Under these circumstances, if the circuit be completed by throwing the acid on the plates of the deflagrator, a most rapid evolution of hydrogen and oxygen will ensue in consequence of the decomposition of the water, so that within a few seconds, several cubic inches of gas will be collected.

The action being now suspended by throwing the acid off the plates, and the foam being allowed to subside, the resulting gaseous mixture may be ignited, and of course condensed, by completing the circuit again as at first, and at the same time causing the ends of the "*electrodes*" to come into contact with each other, and thus to produce a spark.

This contact is effected by causing a very slight movement in the rod, bent at right angles, and entering the mercury in the iron capsule. Of course the process may be repeated as often as can be reasonably desired.

ART. XVIII.—*Improved Process for obtaining Potassium*; by  
ROBERT HARE, M. D., Prof. of Chem. in the Univ. of Penn.  
Read before the Amer. Philos. Society, Dec. 7, 1838.

IN evolving potassium, agreeably to Brunner's plan, I have substituted for the luting usually employed to protect the iron bottle, a cylinder of iron, which is made to surround the bottle; also a disk of the same metal, of a diameter and thickness equal to that of the cylinder.

The disk is supported by bricks of kaolin. The bottle being vertical, the blast acts more equably on the surface of the iron, and the operator can, by additional fuel, protect any part from that undue exposure, to which the under surface is always liable, when the bottle is horizontal.

The potassium is received into an iron tube, of which the bore is two inches in diameter. This tube screws at one end into the bottle, and at the other is closed by a perforated plug, terminating in a small orifice. To this a leaden tube is fitted, which is so adjusted by bending, as to cause the vapor resulting from the burning of the gas, to go into the ash-hole. By these means the hydrogen, being ignited as soon as it comes over, serves as an index of the success and progress of the process. In this way no resort to naphtha is in the first instance necessary. The potassium is extricated from the tube by cooling it by affusion of water, detaching it from the bottle, and then closing the end thus exposed by a cap, in which a suitable conical female screw is wrought.

The part of the tube containing the potassium is then made in a vertical position to occupy the axis of a cylindrical furnace, the end terminating, as above mentioned, in a tapering plug, being lowermost, and projecting below the bottom of the furnace. Before the temperature reaches redness, globules of the metal begin to descend; but to extricate the last portion, a white heat is requisite. The potassium may be received in bottles, kept full of hydrogen by a constant current, or in naphtha. The first portion, which descends before the temperature is high, can be more easily received without naphtha than the latter portion.



ART. XIX.—*Engraving and Description of a Rotatory Multiplier, or one in which one or more Needles are made to revolve by a Galvanic Current; by R. HARE, M. D., Prof. of Chem. in the Univ. of Penn. Read before the Amer. Philos. Society, Dec. 7, 1838.*

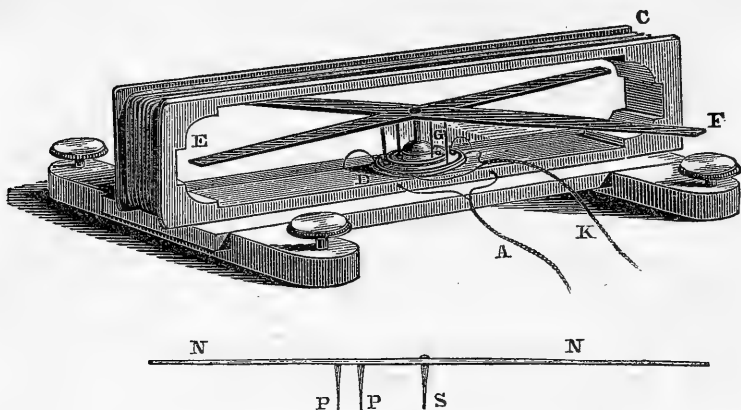

THE preceding engraving represents a rotatory galvanometer, or multiplier, which I contrived in November, 1836, and which must have value as an addition to the amusing, if not to the useful implements of science. It is well known that by passing a temporary discharge through the coil of a multiplier, the needle may be made to perform a revolution, whereas if the current be continuously applied, the movement is checked as soon as the situation of the poles is reversed. To produce a permanent motion, the discharge must be allowed to take place only when the poles are in a favorable position, relatively to the excited coil. This object I attained by means of two pins, descending from the needle perpendicularly, so as to enter two globules of mercury, communicating, on one side, with a galvanic pair, on the other with the coil of the multiplier. In the next place, by winding over the first coil, another of similar length, but in a direction the opposite of that in which the first coil was wound, I was enabled, by two other globules, situated so as to communicate severally with the lower ends of the pins, at the opposite side from that on which the first mentioned globules were, to cause an impulse at every semi-revolution.

The one coil being wound to the right, the other to the left, the alternate effect of each upon the needle was similar in opposite

parts of the orbits described by the pins. Lastly, a second needle, furnished with pins in like manner, being fastened at right angles to the first, so as to form with it a cross, as represented in the engraving, each needle is made to receive two impulses during every revolution. Hence one of Danell's sustaining batteries, as made by Newman, is quite adequate to cause a revolution as rapid as consistent with a due degree of stability in the mercurial globules employed.

One end of each coil, by means of the branching wire A, communicates with one pole of the galvanic pair; the other ends of the coils terminate in mercurial globules contained in cavities on opposite sides of the wooden disc G, upon the centre of which the spindle of the magnetic needle rests. The branches of the wire K proceeding from the other galvanic pole, terminate in globules situated in the vicinity of those above mentioned, so that as the needles revolve, the pins proceeding therefrom perpendicularly may touch a pair of the globules first on one side and then on the other. Whenever this contact takes place, the circuit is completed, and a discharge is effected through one or the other of the coils of the multiplier.

Supposing E and F to be north poles, a discharge through one of the coils will cause E to move off a quarter of a circle, or more. As this ensues, the pins of F will come in contact with the globules which those of E touched before. Of course F will be propelled so as to cause the pins of E to reach the pair of globules at G, which, completing the circuit of a coil wound in a way the opposite of that first mentioned, concurs with that coil in its influence, so as to promote the rotation previously induced. The same result ensues when the pins proceeding from F come in contact with the globules situated at G, and when E returns to its original starting point. It follows, that by a repetition of the process the galvanic action is sustained. The phenomenon is as well illustrated by employing the single needle, N, N, as by two, but the most pleasing and energetic effect is produced by the crossed needles. In this simple form the spindle on which the needle rests and revolves is represented at S; the pins at P, P. Each coil, consisting of copper bell wire, is about thirty feet in length, and is contained in the groove C. The frame of the multiplier is constructed of mahogany and is levelled by the milled headed screws, on the ends of which it is supported.

ART. XX.—*Crania Americana ; or a Comparative view of the Skulls of various Aboriginal Nations of North and South America ; to which is prefixed an Essay on the Varieties of the Human Species, illustrated by seventy-eight plates and a colored map ;* by SAMUEL GEORGE MORTON, M. D., Professor of Anatomy in the medical department of Pennsylvania College, at Philadelphia, &c. &c. Philadelphia : J. Dobson. London : Simpkin, Marshall & Co. Letter Press, pp. 296, folio, 1839.

WE hail this work as the most extensive and valuable contribution to the natural history of man, which has yet appeared on the American continent, and anticipate for it a cordial reception by scientific men not only in the United States, but in Europe. The subject is one of great interest, and Dr. Morton has treated it in a manner at once scientific and pleasing, while the beauty and accuracy of his lithographic plates are not surpassed by any of the modern illustrations of science.

The principal design of the work, says Dr. Morton, has been "to give accurate delineations of the crania of more than forty Indian nations, Peruvian, Brazilian and Mexican, together with a particularly extended series from North America, from the Pacific Ocean to the Atlantic, and from Florida to the region of the Polar tribes. Especial attention has also been given to the singular distortions of the skull caused by mechanical contrivances in use among various nations, Peruvians, Charibs, Natches, and the tribes inhabiting the Oregon Territory." His materials, in this department, are so ample, that he has been enabled to give a full exposition of the subject. He has also bestowed particular attention on the crania from the mounds of this country, which have been compared with similar relics, derived both from ancient and modern tribes, "in order to examine, by the evidence of osteological facts, whether the American aborigines, of all epochs, have belonged to one race, or to a plurality of races."

The introductory Essay, "on the varieties of the human species," occupies ninety-five pages. It is learned, lucid, and like the whole work, classically written. The author notices the great diversities of opinion that have existed among naturalists regarding the grouping of mankind into races ; Linnæus referred all the human family to five races ; Buffon proposed six great di-

visions; subsequently, however, he reduced it to five; while Blumenbach, adopting the arrangement of Buffon, has changed the names of some of the divisions, and designated, with greater accuracy, their geographical distribution. Cuvier admitted three races only, the Caucasian, Mongolian and Ethiopian; while Malté Brun enumerates sixteen. A French professor, Broc, in his *Essai sur les Races Humaines*, published in 1836, has attempted to establish several *sub-genera*. The cause of these wide diversities of opinion obviously lies in the imperfect knowledge yet possessed of the subject.

Dr. Morton adopts the arrangement of Blumenbach in so far as regards the great divisions, substituting, however, the word *race* for the term "variety" of the German author, and changing the order in which Blumenbach considers some of them. He considers the human species as consisting of *twenty-two* families, which he arranges under the heads of the Caucasian, Mongolian, Malay, American, and Ethiopian races.

I. "THE CAUCASIAN RACE is characterized by a naturally fair skin, susceptible of every tint; hair fine, long and curling, and of various colors. The skull is large and oval, and its anterior portion full and elevated. The face is small in proportion to the head, of an oval form, with well proportioned features. The nasal bones are arched, the chin full, and the teeth vertical. The race is distinguished for the facility with which it attains the highest intellectual endowments."

The subdivisions of this race are into—1st. The *Caucasian*; 2d. The *Germanic*; 3d. The *Celtic*; 4th. The *Arabian*; 5th. The *Lybian*; 6th. The *Nilotic*, (Egyptian;) and 7th. The *Indostanic* families.

II. "THE MONGOLIAN RACE. This is characterized by a sallow or olive colored skin, which appears to be drawn tight over the bones of the face; long, black, straight hair, and thin beard. The nose is broad and short; the eyes are small, black, and obliquely placed, and the eye-brows arched and linear; the lips are turned, the cheek bones broad and flat, and the zygomatic arches salient. The skull is oblong-oval, somewhat flattened at the sides, with a low forehead. In their intellectual character the Mongolians are ingenious, imitative, and highly susceptible of cultivation.

The subordinate divisions are into—8th. The *Mongol-Tartar*; 9th. The *Turkish*; 10th. The *Chinese*; 11th. The *Indo-Chinese*; and 12th. The *Polar* families.

III. "The MALAY RACE. It is characterized by a dark complexion, varying from a tawny hue to a very dark brown. Their hair is black, coarse, and lank, and their eye-lids are drawn obliquely upwards at the outer angles. The mouth and lips are large, and the nose is short and broad, and apparently broken at its root. The face is flat and expanded, the upper jaw projecting, and the teeth salient. The skull is high and squared or rounded, and the forehead low and broad. This race is active and ingenious, and possesses all the habits of a migratory, predaceous and maritime people."

The subdivisions embrace—13th. The *Malay*; and 14th. The *Polynesian* (or South Sea Island) families.

IV. "The AMERICAN RACE is marked by a brown complexion, long, black, lank hair, and deficient beard. The eyes are black and deep set, the brow low, the cheek bones high, the nose large and aquiline, the mouth large, and the lips tumid and compressed. The skull is small, wide between the parietal protuberances, prominent at the vertex, and flat on the occiput. In their mental character the Americans are averse to cultivation, and slow in acquiring knowledge; restless, revengeful, and fond of war, and wholly destitute of maritime adventure."

The families into which this race is subdivided, are two: 15th. The *American*; and 16th. The *Toltecan*.

V. "The ETHIOPIAN RACE is characterized by a black complexion, and black, woolly hair; the eyes are large and prominent, the nose broad and flat, lips thick, and the mouth wide; the head long and narrow, the forehead low, the cheek bones prominent, the jaws projecting, and the chin small. In disposition, the negro is joyous, flexible, and indolent; while the many nations which compose this race present a singular diversity of intellectual character, of which the far extreme is the lowest grade of humanity.

This race is divided into—17th. The *Negro*; 18th. The *Caffrarian*; 19th. The *Hottentot*; 20th. The *Oceanic Negro*; 21st. The *Australian*; and 22d. The *Alforian* families. The latter family is most numerous in New Guinea, the Moluccas and Magindano.

The map which precedes the work, shows the geographical distribution of the five races of men; and the lines of demarcation are those indicated by Professor Blumenbach, as separating the different races in the primitive epochs of the world. These divisions, of necessity, are only approximations to truth. The boundary between the *Caucasian* and *Mongolian* races is ex-

tremely vague. The line adopted runs from the Ganges in a northwestern direction to the Caspian Sea, and thence to the River Obi, in Russia. "At a comparatively recent period, however, several Mongolian nations have established themselves in Europe; as the Samoyedes, Laplanders, &c." The *Ethiopian line* is drawn north of the Senegal River, obliquely east and south to the southern frontier of Abyssinia, and thence to Cape Guardafui, thus embracing the Atlas Mountains. "Of the latter, little is known; but many negro nations inhabit to the north of them, at the same time that the Arab tribes have penetrated far beyond them to the south, and in some places have formed a mixed race with the natives."

Dr. Morton gives a brief but clear description, extending to his 91st page, of the leading characteristics of each of these families, accompanying his text by references to the authorities from which the information is drawn. The labor and accuracy of the true philosopher are here conspicuous. After perusing these details, however, we are strongly impressed with the conviction that this branch of science is still only in its infancy. The descriptions of the mental qualities which distinguish the different families of mankind, given even by the best travellers, are vague and entirely popular. There is scarcely an instance of the specification of well defined mental faculties, present or absent in the races, or possessed in peculiar combinations; nothing, in short, which indicates that the travellers possessed a mental philosophy under the different heads of which they could classify and particularize the characteristic qualities of mind which they observed, as the botanists describe and classify plants, or the geologists minerals. The anatomical characters of the races, also, are still confined to a few particulars, and many even of these have been drawn from the inspection of a very limited number of specimens. The subject, however, possesses so much inherent interest and importance, that we may expect rapid advances to be made in its future development.

The unity of the human species is assumed by Dr. Morton. It is known that the *black* race possess an apparatus in the skin, which is wanting in that of the *white* race. Flourens states that there "are, in the skin of the *white* race, three distinct laminæ or membranes—the *derm*, and two *epiderms*; and in the skin of the *black* race, there is, besides the *derm*

and the two epiderms of the *white* race, a particular apparatus, an apparatus which is altogether wanting in the man of the *white* race, an apparatus composed of two layers, the external of which is the seat of the *pigmentum*, or coloring matter of negroes.\* “The coloring apparatus of the negro is always found in the mulatto.” Flourens adds, “The *white* race and the *black* race are then, I repeat, two essentially distinct races. The same is true of the *red*, or American race. Anatomy discovers, under the second epiderm of the individual of the *red*, *copper-colored*, *Indian* or *American* race, (for this race is called indifferently by all these names,) a *pigmental apparatus*, which is the seat of the *red* or *copper color* of this race, as the *pigmental apparatus* of the negro is the seat of his black color.”

Dr. Morton does not advert to the existence of this pigmental apparatus in the American race. The investigations of Dr. McCulloh, he observes, “satisfactorily prove that the designation ‘*copper-colored*,’ is wholly inapplicable to the Americans as a race.” “The *cinnamon* is, in Dr. McCulloh’s apprehension, the nearest approach to the true color” of the native Americans. Dr. Morton considers that the “*brown race*” most correctly designates them collectively. “Although,” says he, “the Americans thus possess a pervading and characteristic complexion, there are occasional and very remarkable deviations, including all the tints from a decided white to an unequivocally black skin.” He shows, also, by numerous authorities, that “climate exerts a subordinate agency in producing these diversified hues.” The tribes which wander along the burning plains of the equinoctial region, have no darker skins than the mountaineers of the temperate zone. “Again, the Puelchés, and other inhabitants of the Magellanic region, beyond the 55th degree of south latitude, are absolutely darker than the Abipones, Macobios and Tobas, who are many degrees nearer the equator. While the Botocudys are of a clear brown color, and sometimes nearly white, at no great distance from the tropic; and moreover, while the Guyacas, under the line, are characterized by a fair complexion, the Charruas, who are almost black, inhabit the 50th degree of south latitude; and the yet blacker Californians, are 25 degrees north of the equator.” “After all,” he adds, “these differences in complex-

---

\* Annales des Sciences Nat. t. x, Dec. 1838, pp. 361, &c.

ion are extremely partial, forming mere exceptions to the primitive and national tint that characterizes these people, from Cape Horn to the Canadas. The cause of these anomalies is not readily explained; that it is not climate is sufficiently obvious; and whether it arises from partial immigrations from other countries, remains yet to be decided."

Buffon defines species—"A succession of similar individuals which reproduce each other." Cuvier also defines species—"The union of individuals descended from each other or from common parents, and of those who resemble them as much as they resemble each other." "The apparent differences of the races of our domestic species," says Cuvier, "are stronger than those of any species of the same genus." "The fact of the *succession*, therefore, and of the *constant succession*, constitutes alone the *unity of the species*." Flourens, who cites these definitions, concludes that "*unity, absolute unity*, of the human species, and *variety* of its races, as a final result, is the general and certain conclusion of all the facts acquired concerning the *natural history of man*."\*

Dr. Morton, while he assumes the unity of the species, conceives that "each race was adapted from the beginning (by an all-wise Providence) to its peculiar local destination. In other words, that the physical characteristics which distinguish the different races, are independent of external causes."

This inference derives support from the fact adverted to by Dr. Caldwell, in his "Thoughts on the Unity of the Human Species." "It is," says he, "4179 years since Noah and his family came out of the ark. They are believed to have been of the Caucasian race." "3445 years ago, a nation of Ethiopians is known to have existed. Their skins, of course, were dark, and they differed widely from the Caucasians in many other particulars. They migrated from a remote country and took up their residence in the neighborhood of Egypt. Supposing that people to have been of the stock of Noah, the change must have been completed, and a new race formed, in 733 years, and probably in a much shorter period."† Dr. Morton observes, that "the recent discoveries in Egypt give additional force to the preceding state-

---

\* Flourens' article before cited, and the *Edin. New Philosophic. Journ.*, Vol. xxvii, p 358, October, 1839.

† P. 72. *Phila.*, 1830.



ment, inasmuch as they show, beyond all question, that the Caucasian and Negro races were as perfectly distinct in that country, upwards of three thousand years ago, as they are now ; whence it is evident, that if the Caucasian was derived from the Negro, or the Negro from the Caucasian, *by the action of external causes*, the change must have been effected in at most one thousand years ; a theory which the subsequent evidence of thirty centuries proves to be a physical impossibility ; and we have already ventured to insist that such a commutation could be effected by nothing short of a miracle." p. 88.

Dr. Morton describes the general characteristics of the American, under the head of the "Varieties of the Human Species," and then enters on a special description of the "crania" of upwards of seventy nations or tribes belonging to that family, illustrating the text by admirable plates of the crania, drawn from skulls, mostly in his own possession, and of the full size of nature.

He regards the American race as possessing certain physical traits that serve to identify them in localities the most remote from each other. There are, also, in their multitudinous languages, the traces of a common origin. He divides the race into the "Toltecan family," which bears evidence of centuries of demi-civilization, and into the "American family," which embraces all the barbarous nations of the new world, excepting the Polar tribes, or Mongol Americans. The Eskimaux, and especially the Greenlanders, are regarded as a partially mixed race, among whom the physical character of the Mongolian predominates, while their language presents obvious analogies to that of the Chippewyans, who border on them to the south.

In the American family itself, there are several subordinate groups. 1st. The *Appalachian* branch includes all the nations of North America, excepting the Mexicans, together with the tribes north of the river of Amazon and east of the Andes. 2d. The *Brazilian* branch is spread over a great part of South America east of the Andes, viz. between the Rivers Amazon and La Plata, and between the Andes and the Atlantic, thus including the whole of Brazil and Paraguay north of the 35th degree of south latitude. In character, these nations are warlike, cruel, and unforgiving. They turn with aversion from the restraints of civilized life, and have made but trifling progress in mental cul-

ture or the useful arts. In character, the Brazilian nations scarcely differ from the Appalachian ; none of the American tribes are less susceptible of cultivation than these ; and what they are taught by compulsion, in the missions, seldom exceeds the humblest elements of knowledge. 3d. The *Patagonian* branch includes the nations south of the La Plata, to the Straits of Magellan, and the mountain tribes of Chili. They are for the most part distinguished for their tall stature, their fine forms, and their indomitable courage, of all which traits the Auracians possess a conspicuous share. 4th. The *Fuegian* branch, which roves over a sterile waste, computed to be as large as one half of Ireland. Forster computes their whole number at only two thousand souls. Their physical aspect is altogether repulsive, and their domestic usages tend to heighten the defects of nature. The expression of the face is vacant, and their mental operations are to the last degree slow and stupid. The difference between them and the other Americans, is attributed by Dr. Morton to the effects of climate and locality.

Thus far Dr. Morton has travelled over ground previously occupied by other naturalists ; but we proceed to a field in which he has had the courage and sagacity to enter boldly on a new path. He has added to his text numerous and minute measurements of the size and capacity not only of each entire cranium, but of its different parts, with a view to elucidate the connection (if there be any) between particular regions of the brain and particular mental qualities of the American tribes. In his dedication to John S. Phillips, Esq., of Philadelphia,\* he observes : " It may, perhaps, be thought by some readers, that these details are unnecessarily minute, especially in the phrenological tables ; and again, others would have preferred a work conducted throughout on phrenological principles. In this study I am yet a learner ; and it appeared to me the wiser plan to present the facts unbiassed by theory, and let the reader draw his own conclusions. You and I have long admitted the fundamental principles of phrenology, viz. that the brain is the organ of the mind, and that its different parts perform different functions ; but we have been

---

\* Dr. Morton acknowledges himself to be under many obligations to Mr. Phillips in the prosecution of his enquiries, and says that it was he who invented the machines used in making the measurements, and executed many of them himself.

slow to acknowledge the details of craniology as taught by Dr. Gall, and supported and extended by subsequent observers. We have not, however, neglected this branch of enquiry, but have endeavored to examine it in connection with numerous facts, which can only be fully appreciated when they come to be compared with similar measurements derived from the other races of men." We shall state, in a subsequent part of this article, the conclusions at which Dr. Morton has arrived, in consequence of his observations and measurements; meantime it is important to state the principles on which he proceeded.

In a few years, it will appear a singular fact in the history of mind, that in the nineteenth century, men holding the eminent station in literature occupied by Lord Jeffrey and Lord Brougham, should have seriously denied\* that the mind, in this world, acts by means of material organs; yet such is the case; and the denial can be accounted for only by that entire neglect of physiology, as a branch of general education, which prevailed in the last century, and by the fact that the metaphysical philosophy in which they were instructed, bore no reference to the functions of the brain. We need not say, that no adequately instructed naturalist doubts that the brain is the organ of the mind. But there are two questions, on which great difference of opinion continues to prevail: 1st. Whether the *size* of the brain (health, age, and constitution being equal) has any, and if so, what influence, on the power of mental manifestation? and 2dly. Whether different faculties be, or be not, manifested by particular portions of the brain.

The *first* proposition, that the size of the brain, other conditions being equal, is in direct relation to the power of mental manifestation, is supported by analogy, by several well known facts, and by high physiological authorities. The power of smell, for example, is great in proportion to the expansion of the olfactory nerve on the internal nostrils, and the volume of the nerve itself bears a direct relation to the degree of that expansion. The superficial surface of the mucous membrane of the ethmoidal bone, on which the nerve of smell is ramified, is computed in man to extend to 20 square inches, and in the seal, which has

---

\* Lord Jeffrey, in the Edin. Review, No. 88, and Lord Brougham in his Discourse on Natural Theology, p. 120.

great power of smell, to 120 square inches. The optic nerve in the mole is a slender thread, and its vision is feeble; the same nerve is large and thick in the eagle, accompanied by intense powers of sight. Again, the fact admits of demonstration, that deficiency in the size of the brain is one, although not the only, cause of idiocy. Although the brain be healthy, if the horizontal circumference of the head, with the muscular integuments, do not exceed thirteen or fourteen inches, idiocy is the *invariable* consequence. Dr. Voisin states that he made observations on the idiots under his care at the Parisian Hospital of Incurables, and found that in the lowest class of idiots; where the intellectual manifestations were null, the horizontal circumference, taken a little higher than the orbit, varied from eleven to thirteen inches, while the distance from the root of the nose backwards, over the top of the head, to the occipital spine, was only between eight and nine inches; and he found no exception to this fact. If, therefore, extreme defect of size in the brain be invariably accompanied by mental imbecility, it is a legitimate inference that size will influence the power of manifestation through all other gradations of magnitude, always assuming other conditions to be equal.

Physiological authorities are equally explicit on this subject. Magendie says, "the volume of the brain is generally in direct proportion to the capacity of the mind. We ought not to suppose, however, that every man having a large head is necessarily a person of superior intelligence; for there are many causes of an augmentation of the volume of the head besides the size of the brain; but it is rarely found that a man distinguished by his mental faculties has not a large head. The only way of estimating the volume of the brain, in a living person, is to measure the dimensions of the skull; every other means, even that proposed by Camper, is uncertain."

The difference of mental power between young and adult minds, is a matter of common observation. The difference in the weights of their brains is equally decided.

According to Cruveilhier, in three young subjects, the weights of the brains were as follows:

In the first, the brain weighed 2 lbs. 2 oz.; the cerebellum,  $4\frac{1}{8}$  oz.; together, 2 lbs.  $6\frac{1}{8}$  oz. In the second, the brain weighed 2 lbs. 8 oz.; the cerebellum,  $3\frac{1}{2}$  oz.; together, 2 lbs.  $11\frac{1}{2}$  oz. In

the third, the brain weighed 2 lbs. 5 oz. ; the cerebellum, 5 oz. ; together, 2 lbs. 10 oz.

In the appendix to Dr. Monro's work on the brain, Sir William Hamilton states the average weight of the *adult* male Scotch brain and cerebellum to be 3 lbs. 8 oz. troy.

Again, a difference in mental power between men and women is also generally admitted to exist, and there is a corresponding difference in the size of their brains.

Sir William Hamilton states the average weight of the adult female Scotch brain and cerebellum, to be 3 lbs. 4 oz. troy ; being 4 oz. less than that of the male. He found one male brain in *seven* to weigh above 4 lbs. ; and only one female brain in a *hundred* exceeded this weight.

In an essay "on the brain of the negro, compared with that of the European and the ourang outang, published in the Philosophical Transactions for 1836, part II, Professor Tiedemann, of Heidelberg, adopts the same principle. After mentioning the weights of fifty-two European brains, examined by himself, he states that "the weight of the brain in an adult male European, varies between 3 lbs. 2 oz. and 4 lbs. 6 oz. troy. The brain of men who have distinguished themselves by their great talents, is often very large. The brain of the celebrated Cuvier weighed 4 lbs. 11 oz. 4 dr. 30 gr. troy, and that of the distinguished surgeon Dupuytren weighed 4 lbs. 10 oz. troy. The brain of men endowed with but feeble intellectual powers is, on the contrary, often very small, particularly in congenital idiotismus. The female brain is lighter than that of the male. It varies between 2 lbs. 8 oz. and 3 lbs. 11 oz. I never found a female brain that weighed 4 lbs. The female brain weighs on an average from four to eight ounces less than that of the male ; and this difference is already perceptible in a new-born child."

We have adduced these proofs and authorities in support of the proposition that size influences power, because we conceive it to be a principle of fundamental importance in every investigation into the natural history of man, founded on the physiology of the brain ; and also because in the hasty zeal of many of the opponents of phrenology, to undermine the discoveries of Dr. Gall, it has been denied with a boldness and pertinacity more allied to the spirit of contentious disputation, than to that of philosophical enquiry. Its importance in a dissertation on *national crania* is

very apparent. One of the most singular features in the history of this continent, is, that the aboriginal races, with few exceptions, have perished or constantly receded, before the Anglo-Saxon race, and have in no instance either mingled with them as equals, or adopted their manners and civilization. These phenomena must have a cause; and can any enquiry be at once more interesting and philosophical than that which endeavors to ascertain whether that cause be connected with a difference in the brain between the native American race, and their conquering invaders? Farther, some few of the American families, the Auracanian, for instance, have successfully resisted the Europeans; and the question is important, whether in them, the brain be in any respect superior to what it is in the tribes which have unsuccessfully resisted?

It is true, that Dr. Gall's fundamental principle, that size in the brain (other conditions being equal) is a measure of the power of mental manifestation, is directly involved in these enquiries; but we can discover no reason why it should not be put to the test of an extensive and accurate induction of facts. The unphilosophical prejudice that every proposition and fact in physiology must be neglected or opposed, because it bears on the vexed question of phrenology, has been too long indulged. The best interests of science require that it should be laid aside, and we commend Dr. Morton for having resolutely discarded it. He does not enter the field as a partisan, for or against Dr. Gall's doctrines, but as a philosophical enquirer, and states candidly and fearlessly the results of his observations.

Dr. Morton reports the size in cubic inches, of the interior of nearly every skull described by him. "An ingenious mode," says he, "of taking the measurement of the internal capacity, was devised by Mr. Phillips. In order to measure the capacity of a cranium, the foramina were first stopped with cotton, and the cavity was then filled with *white pepper seed*,\* poured into the foramen magnum until it reached the surface, and pressed down with the finger until the skull would receive no more. The contents were then transferred to a tin cylinder, which was well shaken in order to pack the seed. A mahogany rod (previously graduated to denote the cubic inches and parts contained in

---

\* "White pepper seed was selected on account of its spherical form, its hardness, and the equal size of the grains. It was also sifted, to render the equality still greater."

the cylinder) being then dropped down, with its foot resting on the seed, the capacity of the cranium, in cubic inches, is at once read off on it."

Dr. Morton gives also measurements of particular regions of the brain, as indicated by the skull; and in this portion of his work, the phrenologists alone can claim precedence of him.

*Secondly.* The most distinguished philosophers on the mind, divide the human faculties into the active and intellectual powers; and some admit even subdivisions of the feelings into propensities common to man with the lower animals, and moral emotions; and of the intellect, into observing and reflecting faculties. Dr. Thomas Brown's division of the intellectual powers into simple and relative suggestion, corresponds with this last classification. If, then, the mind manifest a plurality of faculties, and if the brain be the organ of the mind, it appears to be a sound inference that the brain *may* consist of a plurality of organs. The presumptions which arise, in favor of this idea, from the constitution of the external senses and their organs, are strong. Each sense has its separate nervous apparatus. Nay, when the function of a part is compound, the nerves are multiplied, so as to give a distinct nerve for each function. The tongue has a nerve for voluntary motion, another for common sensation, and the best authorities admit a third nerve for *taste*, although the precise nerve is still in dispute. The internal nostrils are supplied with two nerves, the olfactory, and a nerve of common sensation, ramified on the mucous membrane, each performing its appropriate function. The spinal marrow consists, by general consent of physiologists, of at least two double columns, the anterior pair for voluntary motion, and the posterior pair for common sensation. Sir Charles Bell has demonstrated the distinct functions of the nerves proceeding from these columns. Farther, every accurate observer distinguishes diversities of disposition and inequalities of talents, even in the same individual. The records of lunatic asylums show numerous instances of partial idiotcy and partial insanity. These facts indicate that the brain consists of a plurality of organs, and this idea is countenanced by many high authorities in physiological science. "The brain is a very complicated organ," says Bonnet, "or rather *an assemblage of very different organs.*"\* Tissot contends that every perception has

\* *Palingénésie*, I, 334.

different fibres;\* and Haller and Van Swieten were of opinion that the internal senses occupy, in the brain, organs as distinct as the nerves of the external senses.† Cabanis entertained a similar notion,‡ and so did Prochaska. Cuvier says that "*Certain parts of the brain, in all classes of animals, are large or small, according to certain qualities of the animals;*"§ and he admits that Gall's doctrine of different faculties being connected with different parts of the brain, is nowise contradictory to the general principles of physiology.||

If, then, there be reason to believe that different parts of the brain manifest different mental faculties, and if the size of the part influence the power of manifestation, the necessity is very evident of taking into consideration the *relative proportions of the different parts of the brain*, in a physiological enquiry into the connection between the crania of nations and their mental qualities. To illustrate this position, we present exact drawings of two casts from nature; one, figure 1, is the brain of an American Indian; and the other, figure 2, the brain of an European. Both casts bear evidence of compression or flattening out, to some extent, by the pressure of the plaster; but the European brain is the flatter of the two. We have a cast of the entire head of this American Indian, and it corresponds closely with the form of the brain here represented.

It is obvious that the absolute quantity of brain, (although probably a few ounces less in the American,) *might be the same in both*; and yet, if different portions manifest different mental powers, the characters of the individuals, and of the nations to which they belonged, (assuming them to be types of the races,) might be exceedingly different. In the American Indian, the anterior lobe, lying between A A and B B is small, and in the European it is large, in proportion to the middle lobe, lying between B B and C C. In the American Indian, the posterior lobe, lying between C and D is much smaller than in the European. In the American, the cerebral convolutions on the anterior lobe and upper surface of the brain, are smaller than in the European.

\* Œuvres, III, 33. † Van Swieten, I, 454.

‡ Rapports du Physique et du Moral de l'Homme, 2de Edit. I, 233, 4.

§ Anatomie comparée, tome II.

|| Rapport Historique sur les Progrès des Sciences Naturelles, &c. p. 193.



AMERICAN INDIAN, FIG. 1.

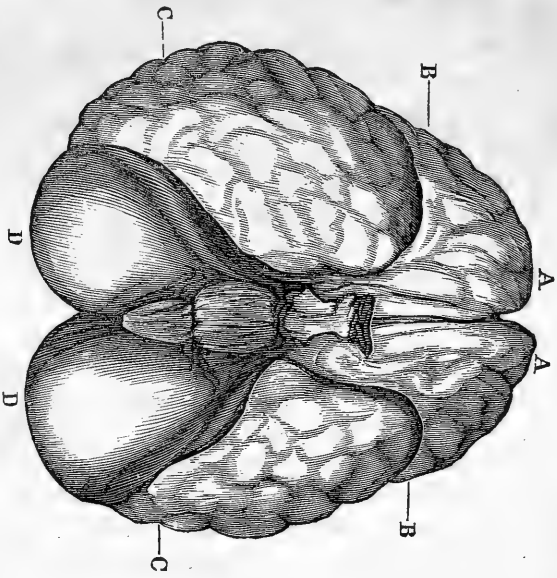

EUROPEAN, FIG. 2.

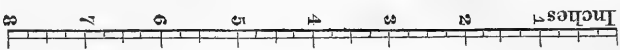
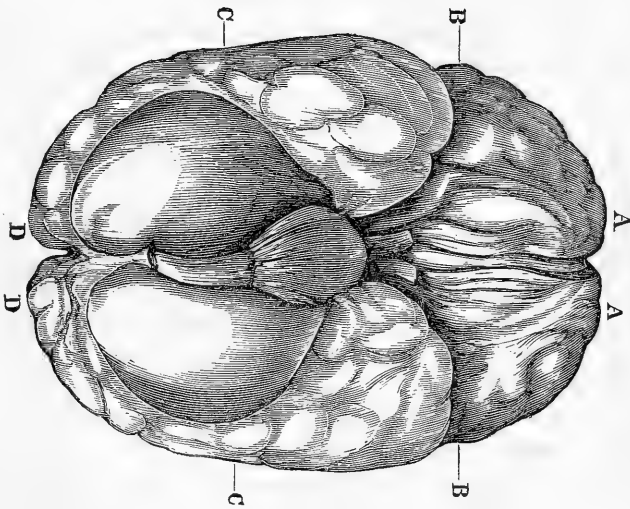

If the anterior lobe manifest the intellectual faculties—the middle lobe, the propensities common to man with the lower animals—and the posterior lobe, the domestic and social affections; and if size influence power of manifestation—the result will be that in the native American, intellect will be feeble—in the European, strong;—in the American, animal propensity will be very great—in the European, more moderate;—while in the American, the domestic and social affections will be feeble, and in the European, powerful. We do not state these as established results; we use the cuts only to illustrate the fact that the native American and the European brains *differ widely in the proportions of their different parts*;\* and the conclusion seems natural, that if different functions be attached to different parts, no investigation can deserve attention which does not embrace the size of the different regions, in so far as this can be ascertained.

We have entered more minutely into the reasons why we regard these measurements as important, because we conceive that the distinguishing excellence of Dr. Morton's work consists in his having adopted and followed out this great principle. It appeared necessary to dwell upon it at some length, also, because Professor Tiedemann, in his comparison of the European with the Negro brain, has entirely neglected it, and in consequence has arrived at physiological conclusions which we regard as at variance with the most certain psychological facts, viz. He says that "there is undoubtedly a very close connection between the **ABSOLUTE SIZE** of the brain and the **INTELLECTUAL POWERS AND FUNCTIONS** of the mind;" and proceeding on this principle, he compares the weight of the whole brain, as ascertained in upwards of fifty Europeans of different ages and countries, with its weight in several Negroes, examined either by himself or others. He gives extensive tables showing the weight of the quantity of millet seed necessary to fill Ethiopian, Caucasian, Mongolian, American, and Malay skulls; and adds that "the cavity of the skull of the Negro in general, *is not smaller* than that of the European and other human races." The inference which he draws, is that *intellectually* and *morally*, as well as anatomically, the Negro is naturally on a par with the

---

\* From inspecting numerous crania of both races, we cannot doubt of the general truth of this proposition.

European ; and he contends that the opposite and popular notion is the result of superficial observation, and is true only of certain degraded tribes on the *coast* of Africa.\*

We entertain a great respect for Prof. Tiedemann, but we cannot subscribe to his principle that the whole brain is the measure of the *intellectual* faculties ; a proposition which assumes that the animal and moral feelings have no seat in this organ. He does not grapple with Dr. Gall's facts or arguments, but writes as if Gall had never existed. Dr. Morton has followed a different course, and we think wisely. He says, "I was from the beginning, desirous to introduce into this work, a brief chapter on phrenology ; but, conscious of my own inability to do justice to the subject, I applied to a professional friend to supply the deficiency. He engaged to do so, and commenced his task with great zeal ; but ill health soon obliged him to abandon it, and to seek a distant and more genial climate. Under these circumstances, I resolved to complete the phrenological table, and omit the proposed essay altogether. Early in the present year, however, and just as my work was ready for the press, George Combe, Esq., the distinguished phrenologist, arrived in this country ; and I seized the occasion to express my wants to that gentleman, who, with great zeal and promptness, agreed to furnish the desired essay, and actually placed the MS. in my hands before he left the city." He adds that Mr. Combe provided his memoir without having seen a word of the MS. of the work, or even knowing what had been written, and besides, owing to previous arrangements, he was limited to a given number of pages.

\* Tiedemann's Essay has been critically examined by Dr. A. Combe, in the *Phrenological Journal*, (vol. xi,) who shows not only the error of principle committed by the author in assuming the whole brain to be the organ exclusively of the *intellectual* faculties, but the more striking fact that Tiedemann's own tables refute his own conclusions. Tiedemann's measurements are the following :

		Inches.	Lines.
Average length of brain in 4 Negroes, . . . . .		5	11
do. do. do. 7 European males, . . . . .		6	2 1-7
do. do. do. 6 European females, . . . . .		5	10½
do. greatest breadth in 4 Negroes, . . . . .		4	8 1 6
do. do. do. 7 European males, . . . . .		5	1 1-7
do. do. do. 3 European females, . . . . .		5	4½
do. height of brain in 3 Negroes, . . . . .		2	11½
do. do. do. 7 European males, . . . . .		3	4
do. do. do. 4 European females, . . . . .		2	9½

The inferiority of the Negro brain in size, is self-evident from these dimensions.

We can afford space only to notice Mr. Combe's illustration of the location of the great divisions of the faculties in the different regions of the brain. It is necessary to give this in order to render the true import of several of Dr. Morton's measurements and results intelligible to the reader.

SWISS, Fig. 3.

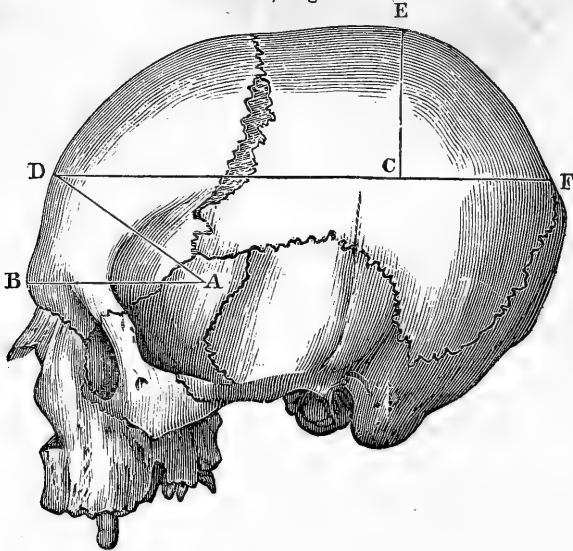

All the figures are drawn to the same scale.

In this figure (Fig. 3,) a line drawn from the point A transversely across the skull, to the same point on the opposite side, would coincide with the posterior margin of the super-orbital plate: the anterior lobe rests on that plate. The line A B, denotes the length of the anterior lobe from back to front, or the portion of brain lying between A A and B B in figures 1 and 2. A in figure 3, "is located in the middle space between the edge of the suture of the frontal bone and the edge of the squamous suture of the temporal bone, where these approach nearest to each other, on the plane of the super-ciliary ridge." We have examined a Peruvian skull of the Inca race, a skull of a flat-headed Indian, an Indian skull found near Boston, and compared them with several skulls of the Anglo-Saxon race, and observe that the line A B, is considerably longer in the latter than in the former, and that it corresponds with the length of the ante-

rior lobe, as denoted by the super-orbital plate. The point C is the centre of ossification of the parietal bone, corresponding to the centre of Cautiousness. The line C D is drawn from C through the center of ossification in the left side of the frontal bone. This is the centre of Causality. E corresponds with Firmness of the phrenologist. The space D A B is an approximation to the department occupied by the intellectual faculties. D C E contains the organs of the moral sentiments. All the space behind A and below the line D C F is devoted to the animal organs. The space E C F contains Self-Esteem and Love of Approbation, which may act either with the moral sentiments or animal propensities, according as either predominate. Mr. Combe states that these lines are only approximations to accurate demarcations of the regions, as no modes of rigid admeasurement have yet been discovered.

Mr. Phillips invented an instrument, (which he describes,) by which Dr. Morton and he measured the contents of the space above D C F in cubic inches, in nearly all the skulls. This is called the *coronal region*. By deducting the contents of this space from the contents of the whole skull, they give the measurement of the *subcoronal region*. Mr. Phillips found it impossible to measure D A B and the space behind A and below D C F in cubic inches, and Dr. M. therefore measured, as an approximation, the whole space contained in the skull anterior to the anterior margin of the foramen magnum. He designates this the *anterior chamber*. He measured all behind that margin, and calls it the *posterior chamber*.

In addition to these, Mr. Phillips has added tables of thirty nine phrenological measurements, (which are lucidly described by him,) of each skull. We quote the following statement as an example of the spirit of philosophical enquiry, which animated Mr. Phillips in his labors. "A series of measurements with the craniometer and compasses, much more extensive than any we had seen published, had been carefully made on upwards of ninety of the crania, when Mr. George Combe arrived in this city. That gentleman immediately pointed out so many erroneous points of measurement, (arising from the use of a badly marked bust,) that those tables *were condemned*, together with the labor bestowed on them," and new measurements of the whole were substituted in their place!

It is impossible to commend too highly the zeal and perseverance manifested by both of these gentlemen in their endeavors to do justice to their subject; and we anticipate that their example, and the results to which their labors have led, will give a powerful impulse to others to prosecute this interesting branch of science.

We shall now present a brief view of the manner in which Dr. Morton applies his own principles, and of some of the conclusions at which he has arrived.

He divides the native American nations into two great families, the *Toltecan* and *American*. "It is in the intellectual faculties, says he, that we discover the greatest difference between them. In the arts and sciences of the former we see the evidences of an advanced civilization. From the Rio Gila in California, to the southern extremity of Peru, their architectural remains are every where encountered to surprise the traveller and confound the antiquary; among these are pyramids, temples, grottoes, bas-reliefs and arabesques; while their roads, aqueducts, and fortifications, and the sites of their mining operations, sufficiently attest their attainments in the practical arts of life." p. 84. The desert of Atacama divides the kingdom of Peru from that of Chilé, and is nearly a hundred miles in length. A river, abounding in salt, runs through it. This desert was the favorite sepulchre of the Peruvian nations for successive ages. The climate, salt and sand, dry up the bodies, and the remains of whole generations of the former inhabitants of Peru may now be examined, after the lapse perhaps of thousands of years. Dr. Morton has been enabled to examine nearly one hundred Peruvian crania, and concludes that that country has been, at different times, peopled by two nations of differently formed crania, one of which is perhaps extinct, or at least exists only as blended by adventitious circumstances, in very remote and scattered tribes of the present Indian race. "Of these two families, that which was antecedent to the appearance of the Incas is designated as the *ancient Peruvian*, of which the remains have been found only in Peru, and especially in that division of it now called Bolivia. Their tombs, according to Mr. Pentland, abound on the shores and islands of the great Lake Titicaca, in the inter-alpine valley of the Desaguadera, and in the elevated valleys of the Peruvian Andes, between the latitudes of 14° and 19° 30' South." Our knowledge of their physical appearance is

derived solely from their tombs. They were not different "from cognate nations in any respect except in the conformation of the head, which is small, greatly elongated, narrow in its whole length, with a very retreating forehead, and possessing more symmetry than is usual in skulls of the American race. The face projects, the upper jaw is thrust forward, and the teeth are inclined outward. The orbits of the eyes are large and rounded, the nasal bones salient, the zygomatic arches expanded; and there is a remarkable simplicity in the sutures that connect the bones of the cranium." p. 97. Dr. Morton presents the following cranium, plate IV of his series, "as an illustrative type of the cranial peculiarities of the people;" and he is of opinion that the form is "natural, unaltered by art."

ANCIENT PERUVIAN, Fig. 4.

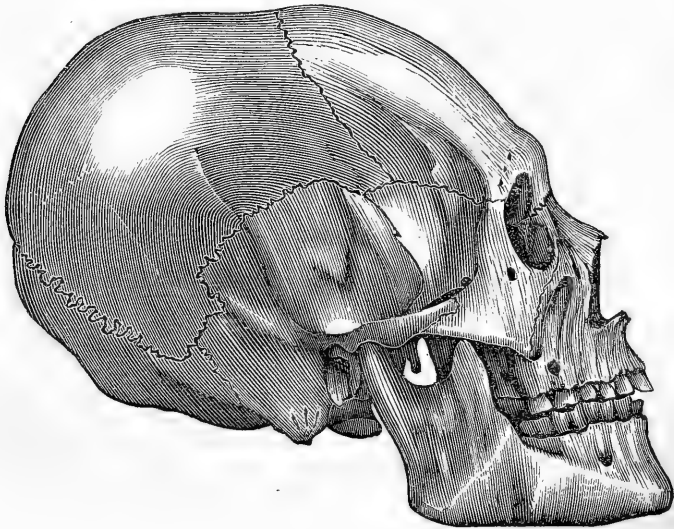

He gives the following description of this cranium :

"Though the forehead retreats rapidly, there is but little expansion at the sides, and from the face to the occiput, inclusive, there is a narrowness that seems characteristic of the race. The posterior view represents the skull elevated in that region, without any unnatural width at the sides, and the vertical view sufficiently confirms the latter fact.

## MEASUREMENTS.\*

Longitudinal diameter, . . . . .	7.3 inches.
Parietal do. . . . .	5.3 do.
Frontal do. . . . .	4.3 do.
Vertical do. . . . .	5.3 do.
Inter-mastoid arch, . . . . .	14. do.
Inter-mastoid line, . . . . .	4.3 do.
Occipito-frontal arch, . . . . .	15. do.
Horizontal periphery, . . . . .	19.8 do.
Extreme length of head and face,	8.2 do.
Internal capacity, . . . . .	81.5 cubic inches.
Capacity of the anterior chamber,	31.5 do.
Capacity of the posterior chamber,	50. do.
Capacity of the coronal region,	16.25 do.
Facial angle, . . . . .	73 degrees."

This skull was found by Dr. Ruschenberger, about a mile from the town of Arica, on the south side of the *morro*, a cemetery of the ancient Peruvians. "The surface is covered with sand an inch or two deep, which being removed discovers a stratum of salt, three or four inches in thickness, that spreads all over the hill. The body (to which this head belonged) was placed in a squatting posture, with the knees drawn up and the hands applied to the sides. The whole was enveloped in a coarse, but close fabric, with stripes of red, which has withstood,

---

\* The measurements are thus described by Dr. Morton. The *longitudinal* diameter is taken from the most prominent part of the os frontis to the occiput; the *parietal* diameter from the most distant points of the parietal bones; the *frontal* diameter from the anterior inferior angles of the parietal bones; the *vertical* diameter from the fossa, between the condyles of the occipital bone, to the top of the skull; the *inter-mastoid arch* is measured with a graduated tape, from the point of one mastoid process to the other, over the external tables of the skull; the *inter-mastoid* line is the distance, in a straight line, between the points of the mastoid processes; the *occipito-frontal arch* is measured by a tape over the surface of the cranium, from the posterior margin of the foramen magnum to the suture, which connects the os frontis with the bones of the nose; the *horizontal periphery* is measured by passing a tape around the cranium so as to touch the os frontis immediately above the superciliary ridges, and the most prominent part of the occipital bone; the *length of the head and face* is measured from the margin of the upper jaw, to the most distant point of the occiput; the *zygomatic diameter* is the distance, in a right line, between the most prominent points of the *zygomæ*; the *facial angle* is ascertained by an instrument of ingenious construction and easy application, invented by Dr. Turnpenny, and described by Dr. Morton. Dr. Morton took nearly all the anatomical measurements with his own hands.



wonderfully, the destroying effects of ages, for these interments were made before the conquest, although at what period is unknown."

Dr. Morton states that the average internal capacity of the Caucasian or European head, is at least 90 cubic inches. In three adult ancient Peruvians, it is only 73. The mean capacity of the anterior chamber is about one half of that of the posterior, or 25 to 47, while the mean facial angle is but 67 degrees.

"It would," he continues, "be natural to suppose, that a people with heads so small and badly formed, would occupy the lowest place in the scale of human intelligence. Such, however, was not the case." He considers it ascertained that "civilization existed in Peru anterior to the advent of the Incas, and that those anciently civilized people constituted the identical nations whose extraordinary skulls are the subjects of our present inquiry."

There is a discrepancy between this description of these skulls and the civilization ascribed to their possessors, which is unique in Dr. Morton's work. In every other race, ancient and modern, the coincidence between superior cranial forms and superior mental qualities, is conspicuous. On turning to Mr. Phillips's phrenological measurements, however, we find that the *mean* extent of the forehead in this skull, from the point A on one side, to the same point on the other, over B, or the "inter-sphenoidal arch, over the *perceptive* organs," (as ascertained by a graduated tape,) is 6.37 inches; and the mean extent from A to A, over D, or the "inter-sphenoidal arch over the *reflective* organs," is 6.12 inches. The mean of the same measurements of "100 *unaltered* crania of adult aboriginal Americans," of which many are ascertained to be males, are 6.7 and 6.87 inches; showing a superiority in the region of the *observing organs* in the ancient race, and in that of the *reflecting organs* in the modern. This indicates a larger quantity of brain in the anterior lobe in the extinct race, than Dr. Morton's description leads us to infer. This subject obviously requires further elucidation.

If these skulls had been compressed by art, we could have understood that certain portions of the brain might have been only displaced, but not destroyed. The spine, for instance, may be bent, as in hump-back, yet retain its functions; and we might suppose the anterior lobe, in cases of compression, to be

developed laterally, or backwards, and still preserve its identity and uses. This, indeed, is Dr. Morton's own conclusion, in regard to the brain in the flat-headed Indians. He gives an interesting and authentic description of the instrument and process by means of which the flat-head tribes of Columbia River compress the skull, and remarks that "besides the depression of the head, the face is widened and projected forward by the process, so as materially to diminish the facial angle; the breadth between the parietal bones is greatly augmented, and a striking irregularity of the two sides of the cranium almost invariably follows; yet the absolute internal capacity of the skull is not diminished, and, strange as it may seem, the intellectual faculties suffer nothing. The latter fact is proved by the concurrent testimony of all travellers who have written on the subject." Dr. Morton adds, that in January, 1839, he was gratified with a personal interview with a full blood Chenouk, in Philadelphia. He is named William Brooks, was 20 years of age, had been three years in charge of some Christian missionaries, and had acquired great proficiency in the English language, which he understood and spoke with a good accent and general grammatical accuracy. His head was as much distorted by mechanical compression, as any skull of his tribe in Dr. Morton's possession. "He appeared to me," he adds, "to possess more mental acuteness than any Indian I had seen, was communicative, cheerful, and well mannered." The measurements of his head were these: longitudinal diameter, 7.5 inches; parietal diameter, 6.9 inches; frontal diameter, 6.1 inches; breadth between the cheek bones, 6.1 inches; facial angle, about 73 degrees. Dr. Morton considers it certain that the forms of the skull produced by compression, never become congenital, even in successive generations, but that the characteristic form is always preserved, unless art has directly interfered to distort it. pp. 206, 207.\*

---

\* Mr. George Combe, in his late lectures in New Haven, mentioned, that in May, 1839, he had been introduced, in New York, to the Rev. Jason Lee, who had been a missionary among the Indians, 2000 miles beyond the Rocky Mountains, and who had with him Thomas Adams, a young Indian of about 20 years of age, of the Cloughewallah tribe, located about 25 miles from the Columbia River. This young man's head had been compressed by means of a board and cushions, in infancy. Mr. C. examined his head, and found that the parietal was actually greater than the frontal and occipital diameter. The organs in the superciliary ridge of the forehead were fully developed; the upper part of the forehead was flat and

The extinct race in Peru, was succeeded by the "INCA, OR MODERN PERUVIANS." This race dates its possession of Peru from about the eleventh century of our era; and as this period corresponds with the epoch of the migration from Mexico of the Toltecas, the most civilized nation of ancient Mexico, Dr. Morton concurs in the opinion expressed by other authors, that the modern Peruvians were of a common origin with the ancient Mexicans. "The modern Peruvians," says he, "differ little in person from the Indians around them, being of the middling stature, well limbed, and with small feet and hands. Their faces are round, their eyes small, black, and rather distant from each other; their noses are small, the mouth somewhat large, and the teeth remarkably fine. Their complexion is a dark brown, and their hair long, black, and rather coarse." p. 115. The civilization and comparative refinement of the Incas was blended with some remains of the ferocity of the savage. "Matrimonial engagements were entered into with very little ceremony or forethought, and they were as readily set aside at the option of the parties. Polygamy was lawful, but not prevalent." Among the people, incontinence, sensuality, and child-murder were common. Their diet was chiefly vegetables. The people were indolent, filthy and negligent in their persons. The hair of their mummies, in many instances, is charged with desiccated vermin. Their religious system was marked by great simplicity, and was divested of those bloody rites which were common with the Aztecs of

---

deficient; his organs of language and form, said Mr. C.; were large. He had studied the English language for two years, and spoke it tolerably well. Mr. C. added, that in conversation he was intelligent, ready, and fluent, on all subjects that fell within the scope of the faculties of observation, situated in the superciliary ridge, but dull, unintelligent, and destitute equally of ideas and language, on topics that implied the activity of the reflecting faculties, situated in the upper part of the forehead. Mr. C. considered his mental powers to be in direct harmony with the development of his brain. We record this observation, because it is obvious, that if different parts of the brain manifest different faculties, it is indispensable that observations on the *manifestations* of the mental powers should be equally minute and discriminative with those on the development of particular portions of the cranium. Mr. C. added, that the only way to ascertain whether the brain was merely displaced by compression, or otherwise altered, was by careful examination after death; and that he had recommended to Mr. Lee to call the attention of any medical men who might visit these Indians, to this subject. We observed the death of one of these flat-headed Indians mentioned as having occurred in New York. Did any of the phrenologists or anti-phrenologists examine the brain? It was an excellent opportunity for Dr. Rees.

Mexico. They believed in one God, whom they called Viracocha, in the immortality of the soul, and in rewards and punishments in the next life. They worshipped both the sun and moon, in whose honor they erected temples and formed idols. They consecrated virgins, in the same manner as practised in modern convents. Their funeral rites were barbarous and cruel : when their chief men died, they buried a number of human victims, women, boys and servants, to attend on the departed in the next world. They were conquered by Pizarro with a force which consisted of 62 horsemen and 102 foot soldiers. p. 124. The following is given as a strikingly characteristic Peruvian head.

MODERN PERUVIAN, Fig. 5.

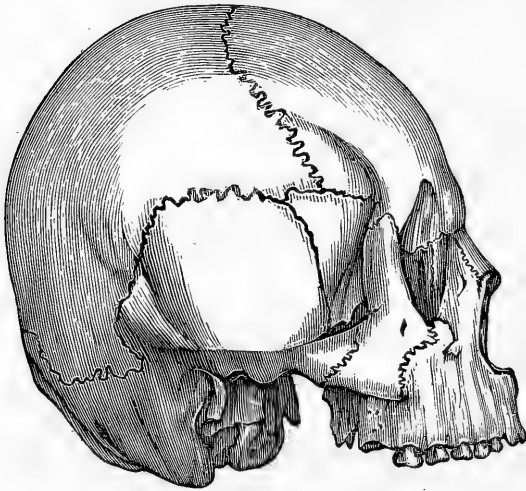

“The skull in these people,” says Dr. Morton, “is remarkable for its small size, and for its quadrangular form. The occiput is greatly compressed, sometimes absolutely vertical; the sides are swelled out, and the forehead is somewhat elevated, but very retreating. The skulls are remarkable for their irregularity. The dimensions of this skull are as follows :

Longitudinal diameter,	. . . . .	6.1 inches.
Parietal do.	. . . . .	6. do.
Frontal diameter,	. . . . .	4.7 do.
Vertical do.	. . . . .	5.5 do.

Inter-mastoid arch, . . . . .	16. inches.
Inter-mastoid line, . . . . .	4.5 do.
Occipito-frontal arch, . . . . .	14.1 do.
Horizontal periphery, . . . . .	19.5 do.
Internal capacity, . . . . .	83. cubic inches.
Capacity of the anterior chamber, . . . . .	33.5 do.
Capacity of the posterior chamber, . . . . .	49.5 do.
Capacity of the coronal region, . . . . .	15.75 do.
Facial angle, . . . . .	81 degrees."

Dr. Morton gives the result of the measurement of twenty-three adult skulls of the pure Inca race. "The mean of the internal capacity is 73 cubic inches, which is probably lower than that of any other people now existing, not excepting the Hindoos." The mean of the anterior chamber is 32, of the posterior, 42, of the coronal region, 12 cubic inches. The highest measure of the coronal region is 20.5, and the smallest 9.25 cubic inches. The mean facial angle is 75 degrees. The heads of nine Peruvian children appear to be nearly, if not quite as large, as those of children of other nations at the same age. p. 133.

The small size of the brains of this race, compared with that of the Europeans who invaded them, is in accordance with the ease with which the former were overcome and retained in subjection. The deficiency in the posterior region of the brain, in which the organs of the domestic affections are situated, corresponds with their feeble conjugal attachment and indifference to the lives of their children. The diameter from constructiveness to constructiveness, is stated by Mr. Phillips to be 4.5 inches, and from ideality to ideality, 5.1. These organs give a talent for art, and are considerable. The same measurements in the Naumkeagh, the race which occupied New England, and whose skulls are still dug up near Boston and Salem, and which never made any attainments in the arts, are 4.1 and 4 inches, respectively. Dr. Robertson, in his history of America, mentions that the modern Peruvian race was distinguished for its extraordinary powers of concealment and secrecy. Mr. Phillips states the breadth from secretiveness to secretiveness to be 5.6 inches, which is large; the longitudinal diameter is only 6.1. The region of combativeness also appears to be deficient in these skulls.

The IROQUOIS confederacy, consisted originally of five nations, the Mohawks, Oneidas, Onondagas, Cayugas and Senecas. They

were intellectually superior to the surrounding nations, passionately devoted to war, and victorious over the other tribes. They forced their women to work in the field and carry burdens; they paid little respect to old age, were not much affected by love, were regardless of connubial obligations, and addicted to suicide. "They were proud, audacious, and vindictive, untiring in the pursuit of an enemy, and remorseless in the gratification of their revenge. Their religious ideas were vague, and their cautiousness and cunning proverbial. They were finally subdued and nearly exterminated by the Anglo-Americans in 1779. Some miserable remnants of them, ruined by intoxicating liquors, still exist in the state of New York." The following is the skull of a Huron, one of these nations.

HURON, Fig. 6.

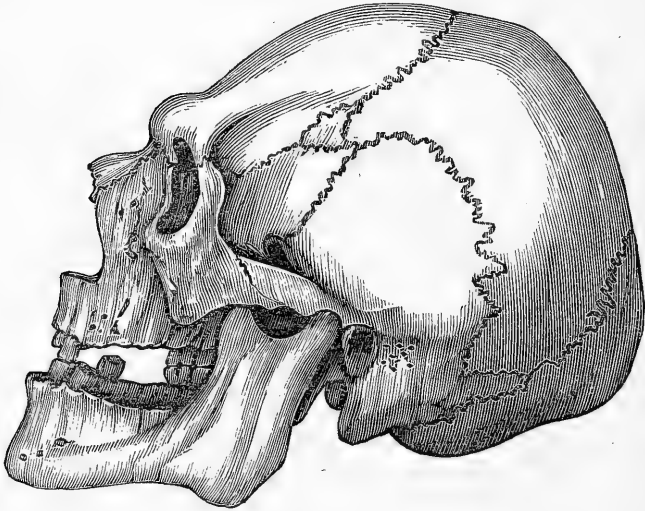

The following are *average* measurements of the five skulls of these nations given by Dr. Morton: internal capacity, 88; coronal region, 15; anterior chamber, 31.5; posterior chamber, 50 cubic inches.

The ARAUCANIANS are the most celebrated and powerful of the Chilian tribes. They inhabit the region between the rivers Bio-bio and Valdivia, and between the Andes and the sea, and derive their name from the province of Arauco. "They are a robust

and muscular people, of a lighter complexion than the surrounding tribes. Endowed with an extraordinary degree of bodily activity, they reach old age with few infirmities, and, generally, retain their sight, teeth, and memory, unimpaired. They are brave, discreet, and cunning to a proverb, patient in fatigue, enthusiastic in all their enterprises, and fond of war as the only source of distinction." "Their vigilance soon detected the value of the military discipline of the Spaniards, and especially the great importance of cavalry in an army; and they lost no time in adopting both these resources, to the dismay and discomfiture of their enemies. Thus in seventeen years after their first encounter with Europeans, they possessed several strong squadrons of horse, conducted their operations in military order, and, unlike the Americans generally, met their enemies in the open field." "They are highly susceptible of mental culture, but they despise the restraints of civilization, and those of them who have been educated in the Spanish colonies, have embraced the first opportunity to resume the haunts and habits of their nation." p. 241. The following is one of three Araucanian skulls delineated in the work.

ARAUCANIAN, Fig. 7.

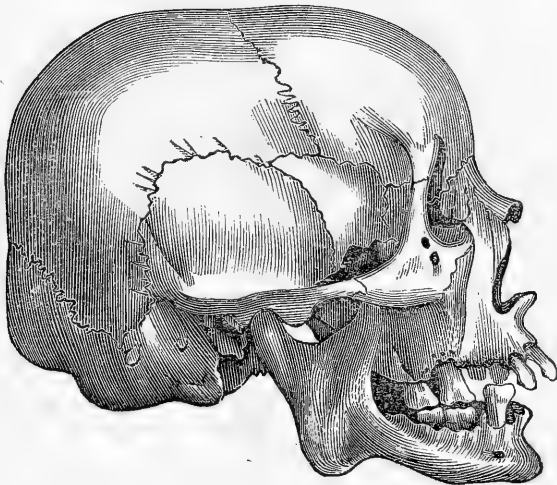

The average measurements of the three skulls are as follows: internal capacity, 79; coronal region, 15.4; anterior chamber 32.2; posterior chamber, 48.50.

The measurements of the *anterior* and *posterior* chambers, as we have already mentioned, (p. 359,) are not in accordance with any phrenological rule. The anterior embraces the whole intellect, a portion of the moral sentiments, and a portion of the animal propensities; while the posterior chamber includes the remainder of the animal propensities and the remainder of the moral organs. The measurement of the internal capacity, is free from all objection; and that of the coronal region approaches to correctness; but the first gives merely the aggregate size of all the organs, animal, moral, and intellectual; and the second that of the moral organs, with a portion of the intellectual organs, and also a portion of the organs common to man with the lower animals. The phrenological measurements given by Mr. Phillips may probably afford more correct means of comparing one portion of the brain with another, in the different nations, but our limits prevent us from analyzing them. Unfortunately also the letter-press titles to his columns are printed up-side down, which renders it exceedingly laborious to consult them. We, therefore, only remark that the application of lines delineated by Mr. Combe on the skull Figure 1, to those specimens, brings out the relation between the mental character and cranial development pretty forcibly to the eye. Estimating from A to B and D, the ancient Peruvian is seen not to be so defective in the intellectual region as a cursory glance would indicate; while the modern Peruvian is obviously larger in that region. The space above D C, devoted to the moral organs, is large in the modern Peruvian in proportion to the portion below C D, and behind the ear. This race was intelligent, and comparatively mild, but superstitious and feeble. It has been subdued by the Europeans, and lives under their dominion. The Hurons, always averse to civilization, have been nearly exterminated. The preponderance of the region below C D, (that of the animal propensities,) in them is conspicuous, combined with relative deficiency in the moral and intellectual regions. The Araucanians have maintained their independence in the open field, but resisted civilization. The large development of the space A B C, devoted to intellect, and also that below C D and behind the ear, devoted to the propensities, is obvious, while the space above C D, or the region of the moral organs, is proportionally deficient. This indicates great animal and intellectual power, with imperfectly evolved moral feelings. To the latter



defect, probably is to be ascribed their aversion to civilized habits. The inferiority of all of these skulls to that of the Swiss is conspicuous. The internal capacity of it is 95.5, and that of the coronal region, 21.25. Dr. Morton does not give the capacity of the anterior and posterior chambers of this skull, but the larger dimensions of the intellectual organs have already been stated.

We have no space to enter into any description of the skulls found in the ancient tombs, or of those of the Flat-headed Indians and Charibs; suffice it to say that Dr. Morton's materials are full and satisfactory on these topics, and his facts and conclusions highly interesting. We subjoin a few of the general results at which he arrives from a survey of his entire field.

"The intellectual faculties," says he, "of the great AMERICAN FAMILY, appear to be of a decidedly inferior cast, when compared with those of the Caucasian or Mongolian races. They are not only averse to the restraints of education, but for the most part incapable of a continued process of reasoning on abstract subjects. Their minds seize with avidity on simple truths, while they at once reject whatever requires investigation and analysis. Their proximity, for more than two centuries, to European institutions, has made scarcely any appreciable change in their mode of thinking or their manner of life; and as to their own social condition, they are probably in most respects what they were at the primitive epoch of their existence. They have made few or no improvements in building their houses or their boats; their inventive and imitative faculties appear to be of a very humble grade, nor have they the smallest predilection for the arts or sciences. The long annals of missionary labor and private benefaction bestowed upon them, offer but very few exceptions to the preceding statement, which, on the contrary, is sustained by the combined testimony of almost all practical observers. Even in cases where they have received an ample education, and have remained for many years in civilized society, they lose none of their innate love of their own national usages, which they have almost invariably resumed when chance has left them to choose for themselves." "However much the benevolent mind may regret the inaptitude of the Indians for civilization, the affirmative of this question seems to be established beyond a doubt. His moral and physical nature are alike adapted to his position among the races of men, and it is as reasonable to expect the one to be changed

as the other. The structure of his mind appears to be different from that of the white man, nor can the two harmonize in their social relations except on the most limited scale. Every one knows, however, that the mind expands by culture; nor can we yet tell how near the Indian would approach the Caucasian after education had been bestowed on a single family through several successive generations." p. 82.\*

The following are parts of Dr. Morton's table of "mean results," given from his whole measurements.

	Toltecan nations, and skulls from mounds.		Barbarous nations, with skulls from the valley of Ohio.		American race, embracing Toltecan and barbarous nations.		Flathead tribe of Columbia river.		Ancient Peruvians.	
	No. of skulls.	Mean.	No. of skulls.	Mean.	No. of skulls.	Mean.	No. of skulls.	Mean.	No. of skulls.	Mean.
Internal capacity in cubic inches,	57	76.8	87	82.4	144	79.6	8	79.25	3	73.2
Capacity of anterior chamber,	46	32.5	73	34.5	119	33.5	8	32.25	3	25.7
Capacity of posterior chamber,	46	43.8	73	48.6	119	46.2	8	47.00	3	47.4
Capacity of coronal region,	46	14.0	71	16.2	117	15.1	8	11.09	3	14.6
Capacity of sub-coronal region,	46	61.8	71	66.5	117	64.5	8	67.35	3	58.6

*Remarks.*—"The barbarous nations possess a larger brain by  $5\frac{1}{2}$  cubic inches, than the Toltecan; while, on the other hand, the Toltecan possess a greater relative capacity of the anterior chamber of the skull, in the proportion of 42.3 to 41.8. Again, the coronal region, though absolutely greater in the barbarous tribes, is rather larger in proportion in the demi-civilized tribes; and the facial angle is much the same in both, and may be assumed, for the race, at 75 degrees.

"In conclusion, the author is of the opinion that the facts contained in this work tend to sustain the following propositions:

"1st. That the American race differs essentially from all others, not excepting the Mongolians; nor do the feeble analogies of language, and the more obvious ones, in civil and religious institutions and the arts, denote any thing beyond casual or colonial communication with the Asiatic nations; and even those analogies may perhaps be accounted for, as Humboldt has suggested, in the mere coincidence arising from similar wants and impulses in nations inhabiting similar latitudes.

\* Dr. Morton adds that the Indians are extremely defective in comprehending every thing relating to numbers, and we may remark that Mr. Combe, in his lectures in New Haven, showed the great deficiency of the organ of number in their skulls.

"2d. That the American nations, excepting the polar tribes, are of one race and one species, but of two great families, which resemble each other in physical, but differ in intellectual character.

"3d. That the cranial remains discovered in the mounds from Peru to Wisconsin, belong to the same race, and probably to the Toltecan family." Dr. Morton subjoins the following

"NOTE on the internal capacity of the cranium in the different races of men. Having subjected the skulls in my possession, and such also as I could obtain from my friends, to the internal capacity measurement already described, I have obtained the following results. The mean of the American race (omitting fractions) is repeated here, merely to complete the table. The skulls of idiots, and persons under age, were of course rejected.

Races.	No. of skulls.	Mean internal capacity in cubic inch.	Largest in the series.	Smallest in the series.
1. Caucasian,	52	87	109	75
2. Mongolian,	10	83	93	69
3. Malay,	18	81	89	64
4. American,	147	80	100	60
5. Ethiopian,	29	78	94	65

"1st. The *Caucasians* were, with a single exception, derived from the lowest and least educated class of society. It is proper, however, to mention that but three *Hindoos* are admitted in the whole number, because the skulls of these people are probably smaller than those of any other existing nation. For example, seventeen *Hindoo* heads give a mean of but seventy-five cubic inches; and the three received into the table are taken at that average. To be more specific, we will give, in detail, the number of individuals of each nation, as far as ascertained.

Anglo-Americans,	6
German, Swiss and Dutch,	7
Celtic, Irish and Scots,	7
English,	4
Guanché, (Lybian),	1
Spanish,	1
Hindoo,	3
Europeans not ascertained,	23
Total,	52

"2d. The *Mongolians* measured, consist of Chinese and *Eskimaux*, and what is worthy of remark, three of the latter give a mean of 86 cubic inches, while seven Chinese give but 82.

"3d. The Malays embrace Malays proper and Polynesians, thirteen of the former and five of the latter; and the mean of each presents but a fractional difference from the mean of all.

"4th. The *Ethiopians* were all unmixed negroes, and nine of them native Africans, for which I am chiefly indebted to Dr. McDowell, formerly attached to the colony at Liberia.\*

"5th. Respecting the American race, I have nothing to add, excepting the striking fact that of all the American nations, the Peruvians had the smallest heads, while those of the Mexicans were something larger, and those of the barbarous tribes the largest of all, viz.

Toltecan nations,	{	Peruvians collectively,	76 cub. inch.
		Mexicans collectively,	79 do.
		Barbarous tribes, as per table,	82 do.

"An interesting question remains to be solved, viz. the relative proportion of brain in the anterior and posterior chambers of the skull in the different races; an inquiry for which I have hitherto possessed neither sufficient leisure nor adequate materials." p. 261.

We now add Dr. Morton's statement in his prefatory letter to Mr. Phillips. "I am free to acknowledge," says he, "that there is a singular harmony between the mental character of the Indian, and his cranial developments, as explained by phrenology."

Our readers will discover in the length and minuteness of this article, the great value which we attach to Dr. Morton's work. We regard it as an honor to the country, and as a proof of talent, patience, and research in himself, which place him in the first rank among natural philosophers. We rejoice to see that he does "not, even now, consider his task as wholly completed;" but hopes to publish a "supplementary volume, in which it will fur-

---

\* Dr. Morton states the mean internal capacity of the European, or Caucasian skulls, to be 87, and of the Ethiopian, or Negro race, to be 78 cubic inches. We observe that Dr. Andrew Combe, in his "Remarks on the Fallacy of Professor Tiedemann's Comparison of the Negro brain and intellect with those of the European," arrives at results coinciding with those obtained by Dr. Morton. Tiedemann gives the weight of only four Negro brains. "The average European," he says, "runs from 3 lbs. 2 oz. to 4 lbs. 6 oz.; while the average of the four Negro brains rises to only 3 lbs. 5 oz. 1 dr.; or 3 oz. above the lowest European averages; and the highest Negro falls 5 oz. short of the highest average European, and no less than 10 oz. short of Cuvier's brain." Phren. Journ., Vol. XI. We have already shown, p. 357, that Tiedemann's linear dimensions of the European and Negro brain also contradict his theory of equality, and are in harmony with Dr. Morton's results.

ther be my aim to extend and revise both the anatomical and phrenological tables, and to give basal views of at least a part of the crania delineated." We sincerely trust that the favorable reception of this volume will induce him to execute these intentions. Valuable as the materials are in the present work, they lie very much apart. He wrote without systematic relation to phrenology; yet phrenological facts and inferences are presented *passim* throughout the work. Mr. Phillips's phrenological tables are extensive, minute and interesting, but they are not connected directly with the text; while Mr. Combe's essay was composed and printed without his having seen either the text of Dr. Morton, or the final results of Mr. Phillips's measurements. There is strong evidence, in this course of proceeding, of a very direct love of truth, and a reliance on all its parts harmonizing with each other; but much of the effect and instruction are lost to the reader, in consequence of the facts and principles not being brought into juxtaposition by the respective contributors. We shall expect this defect to be supplied in the next edition, which we do not doubt will be called for. The work is remarkably cheap, keeping in view the quantity and quality of the *materiel* of which it is composed.\*

---

\* *Postscript*.—On page 363, we remarked that "there is a discrepancy between the description of the ancient Peruvian skulls, and the civilization ascribed to their possessors, which is unique in Dr. Morton's work." When the present sheet was in the press, we received a letter from Dr. Morton, in which he says, "Since that part of my work which relates to the *ancient Peruvians* was written, I have seen several additional casts of skulls belonging to the same series, and although I am satisfied that Plate IV, (Fig. 4, p. 361,) represents an unaltered cranium, yet, as it is the *only unaltered one* I have met with, among the remains of that ancient people, I wish to correct the statement, too hastily drawn, that it is the *cranial type* of their nation. My matured opinion is, that the ancient Peruvians were a branch of the great Toltecan family, and that the cranium had the same general characteristics in both. I am at a loss to conjecture how they *narrowed the face* in such due proportion to the head; but the fact seems indisputable. I shall use every exertion to obtain additional materials for the farther illustration of this subject."

Signed,

SAMUEL GEORGE MORTON.

Philadelphia, March 3, 1840.

Dr. Morton requests us also to subjoin the following note: "The author has published five hundred copies of his work, which he nominally divides into two editions, the American and the Foreign. They differ in nothing but the dedication; the American copies being dedicated to Dr. Ruschenberger and Mr. J. S. Phillips—the Foreign copies to Dr. Prichard and James Morton, Esq., the author's uncle. In the Foreign copies, the letter to Mr. Phillips is inserted at the end of the volume."

## MISCELLANIES.

## DOMESTIC AND FOREIGN.

1. *Aurora Borealis of September 3, 1839.*—The following extracts from observations made at *Middlebury, Vt.*, by Prof. A. C. Twining, (and published in the *People's Press*, Sept. 10, 1839,) were intended for insertion among other accounts at p. 261, but they were unavoidably omitted.

At 7h. 23m. P. M.—daylight being yet strong enough for ordinary purposes of vision—an irregular belt of thin whitish clouds was seen over head, lying east and west; its constituent strata manifesting a tendency to arrange themselves in lines directed towards the magnetic pole, through which the southern boundary of the belt passed, leaving the hemisphere south of the pole unclouded. By attentive observation, some of the clouds were seen to vanish so suddenly as to make it evident that the belt was auroral in its nature. Rosy tints were also just discernible in the N. E. and N. W.; and soon after in the N., faint streamers of light. The belt might probably have been seen earlier if my attention had been directed to it. As daylight departed, the phenomena became more decided. At 7h. 33m. a corona was discernible at the magnetic pole. The belt moved south—rapidly at first—then, to appearance, more slowly, and at last almost imperceptibly; the streaks which composed it blending their light, as they became more distant, till at 7h. 43m. they formed a twilight in the south, having a southern or lower boundary in the form of an arch, whose crown was elevated  $10^{\circ}$ , and beneath which arch the sky was clear, and dark by contrast, as often seen in the north.

Various evolutions of the aurora presented themselves from this until 9h. 5m. when the arrangement was beautifully symmetrical. A broad, fan-like sheet, having its vertex at the corona, and opening towards the horizon, seemed to be let down over the southern quarter from E. to W., presenting an assemblage of white, yellow, and red streamers, indescribably grand. The corona also was perfect, and exhibited all around a fine striated and mottled appearance, like the most delicately figured fancy-work. From 9h. 21m. to 9h. 23m. the aspects were of such glory and beauty as to excite transports of admiration. I have witnessed all the remarkable auroras of the last five years, in the latitude of New Haven, Conn., but this, for the time just specified, as least doubled in splendor the finest of them all. \* \* \* At 9h. 31m. the aurora was comparatively faint, but embraced the entire concave;—streamers ascending from every side towards and up to the corona, like the rafters of a dome. Just at this moment

appeared for the first time, *auroral waves* or the *merry dancers*.<sup>\*</sup> These were very decided and magnificent, and continued their play with various degrees of activity,—all other phenomena seeming to give place to them, until 11h. 10m., at which time the aurora had entirely disappeared except a faint zone of twilight from E. to W. \* \* \* At 1h. 23m. (A. M. 4th) the auroral waves were extremely active; and luminous currents were seen ascending to the corona, distinct from the waves or flashes, and making directly up in the course of the streamers. This was to me an entirely new phenomenon. There was in fact a combination of three phenomena. 1st. The *streamers*, which formed the dome, and seemed to be fixed. 2d. These seemed to be the conductors of a *subtle but just discernible fluid*, which ascended along or beneath them. 3d. This subtle ascending fluid seemed like a medium in which the auroral waves exhibited themselves. This is a description of *appearances* only. It seemed to the spectator as if he was looking up the cupola or funnel of a furnace along which heated vapors were ascending with a rush like that of a mill-race; the vapors being every where pervaded by the flashes and flickerings of the auroral waves. Both the waves and the upward currents were most active as they approached the region of the corona, and were not discernible below about 20° of altitude. At 2h. 10m. I found the waves and all the phenomena faint. The watchman at the cotton manufactory states, however, that near this time there was a period of extreme splendor continuing about two minutes.

2. *Meteoric Observations in November and December, 1839.*—At the time of the expected appearance of an unusual frequency of meteors on the 14th of November, 1839, the sky in this region was so much obscured by clouds, that it could not be determined whether or not there was any uncommon meteoric display. Clouds prevented observation here also on the evenings of the 5th, 6th, and 7th of December, 1839. No accounts have reached us of observations at these dates in places where the sky was clear.

Observations for meteors were made here on the evening of October 8, 1839, and on the mornings (between 3h. 30m. and 5h. A. M.) of October 9, 11, 16, but no unusual meteoric frequency was detected. The general radiation of the meteors was then from the region of the constellation Gemini. (See this Journal, Vol. xxxv, p. 366.)

No intelligence has yet arrived here concerning the result of meteoric observations at the August epoch in southern latitudes. It would not

---

\* It is probable that they were seen simultaneously at Middlebury and at New Haven, (see p. 260,) the time being uncertain within three or four minutes.

be surprising if it should be found that this display is chiefly limited to the northern hemisphere. The inhabitants of the southern hemisphere may, however, at other seasons, be favored with meteoric displays which are to us invisible.

E. C. H.

New Haven, Conn.

3. *New edition of EATON'S Manual of Botany.*—The eighth edition of this popular Manual will be published in the course of the spring of 1840, by Mr. Elias Gates, bookseller, Troy, N. Y. The title in full, is *North American Botany; comprising the Native and Common Cultivated Plants North of Mexico: Genera arranged according to the Artificial and Natural Methods.* In this edition, Prof. Eaton is associated with JOHN WRIGHT, M. D., Prof. Veg. and An. Phys. in Rensselaer Institute; Mem. Yale Nat. Hist. Soc., &c., from whose labors the public may justly expect that the book will receive much increase of value. It will contain indications of the *medicinal properties of plants*, from Lindley's Medical Flora; with numerous other valuable additions and improvements, and will constitute a volume of about 550 pages, large 8vo.

4. *Experimental Researches in Electricity;* by MICHAEL FARADAY, D. C. L., F. R. S. *Reprinted from the Philosophical Transactions of 1831–1838.* London: R. & J. E. Taylor, 1839. 8vo. pp. 574. 8 plates.—This volume comprises the fourteen series of Experimental Researches which this distinguished author has published in the Philosophical Transactions, and which are now reprinted in order to supply the series, accompanied with an Index, in a convenient form, for a moderate price. These Researches have contributed greatly to the advancement of the science of Electricity, and are too well known and appreciated to need any commendation at our hands.

5. *A New Comet.*—At 28 minutes after 3h. A. M., December 9, 1839, (civil reckoning at Berlin,) a new comet was observed by *Encke*, at the Royal Observatory at Berlin, Prussia, at which time he found its right ascension to be 13h. 42m. 44s.; and its southern declination, 11' 30".

At 6h. 31m. 13s. A. M., December 10, (civil reckoning at Altona,) Professor *Schumacher*, at the Observatory of Altona, determined the comet's place to be in R. A. 13h. 43m. 45s.; N. Dec. 8' 18"; at 6h. 2m. 42s. A. M. of the 11th, according to the same observer, the comet's place was in R. A. 13h. 53m. 19.27s.; N. Dec. 27' 57.7".

At the Observatory of Hamburg, December 15, at 4h. 21m. 55.38s. A. M. (civil reckoning at Hamburg,) M. *Rümker* found the place of the comet to be in R. A. 14h. 32m. 59.49s.; N. Dec. 1° 39' 33.49".—*Extract in N. Y. Jour. of Com. Feb. 1; 1840.*



6. *Reports on the Fishes, Reptiles and Birds of Massachusetts. Published agreeably to an order of the Legislature, by the Commissioners on the Zoological and Botanical Survey of the State.* Boston. 8vo. pp. 426. 4 plates.—This volume, prepared under the fostering care of the enlightened and liberal State of Massachusetts, is a most valuable contribution to science. The first and second reports are drawn up by D. H. Storer, M. D.; the third (on the Birds) by Mr. W. B. O. Peabody. The report on the Fishes is by far the best treatise on this department which has been published in our country. That on the Reptiles, being prepared at short notice and under several disadvantages, is probably less complete than it may hereafter be rendered; but it is nevertheless a work of which the author has no reason to be ashamed. The birds of our country having been so thoroughly described by Wilson, Bonaparte, Audubon, Nuttall, and others, Mr. Peabody considered it unnecessary to copy at length their scientific descriptions, and has therefore very properly given especial attention to an account of their habits. The remarks upon these reports, by a committee of the Boston Nat. Hist. Society, (published at p. 393,) render it unnecessary for us to say any thing more in their praise.

#### 7. *Telescopes.*

*To the Editors*—Agreeably to your request, I forward you a description of my telescope, with many thanks for your kind offer.

It is fitted up in very handsome style, near 8 feet long and 5 in diameter, objective treble glass, with a magnifying power of about 180; price, \$4,000.

In 1821, while at Warsaw, the Emperor Alexander ordered me to make a telescope for his college, such as the one I have now finished, but could not undertake it in consequence of the difficulty of obtaining a suitable piece of flint glass. In travelling through England and France, I met with a piece which enabled me to finish one of the above power, and which I am confident will give satisfaction to men of science.

I have one in hand, of much larger dimensions, viz. 16 or 18 feet long, and 12 or 14 inches diameter, objective glass, but from want of means, cannot proceed with it.

If any society here would advance me \$1,000 on the above instrument, they might use it, and I then could proceed with the larger one.

I have to lose a great deal of time in sending to England and France for flint to grind here, but have some now on the way.

I have encouraged the glass manufacturers in this country to make flint glass, and I hope, ere long, to be enabled to get it here instead of having to send to Europe.

Should you visit New York soon, you would honor me much by calling upon me, and I then could explain myself more fully. May I beg the favor of your sending me that number of the American Journal in which the description of the telescope will appear. With very many thanks for the trouble I have occasioned you,

I remain your obedient servant,                      LEON LEWENBERG.  
New York, 28th Feb., 1840.

8. *Interesting Minerals*.—The subscriber has recently supplied himself with an additional collection of the interesting minerals of Nova Scotia, formerly discovered by Dr. Jackson and himself, and is desirous of exchanging them for those of other regions, foreign or domestic. The minerals are similar to those found in the trap rocks of other countries, and the specimens have been selected with great care, are of good size, and most of them beautifully crystallized, often uniting in the same mass, several different species.\* Those who may wish to exchange for them specimens of an equivalent character, will please forward to the subscriber a list from which he may make a selection; his object being to obtain those from localities with which his cabinet is not already supplied, without adding much to his stock of duplicates. The minerals comprise most of the species of the genus Kouphone spar of Mohs and Haidinger, besides most of the varieties of rhombohedral and uncleavable quartz, with several interesting ores of iron and copper, crystallizations of carbonate and sulphate of lime, &c. &c.                      FRANCIS ALGER.

Boston, January 1, 1840.

9. *Observations Météorologiques et Magnétiques faites dans l'étendue de l'Empire de Russie redigées et publiées aux frais du Gouvernement, par A. T. KUPFFER, Mem. Acad. Sci. St. Pet. Tome 1er. St. Pétersbourg, 1837. 4to. pp. xlvii and 196.*—We have been favored by the author with the first volume of this valuable work. It contains, 1st. Extracts from the instructions given to the officers of the mines, appointed to make meteorological and magnetical observations in the Russian Empire, and 2d. Series of tables of observations in meteorology and in magnetism, made at St. Petersburg and at Catherinenburg, in 1835, 1836. The meteorological observations were taken eight times per diem, and appear to have been made with very great care.

---

\* For an enumeration of these minerals, the reader is referred to Vols. xiv and xv of this Journal, and to the Memoirs of the American Academy, for 1833, new series. Having recently inspected them in Mr. Alger's cabinet, we can bear testimony to their extraordinary beauty and perfection.—EDS.

At Catherinenburg, from the observations made every day of December, 1836, by *M. Reinke*, the magnetic declination was found to be  $5^{\circ} 5' 23''$  east. At the close of the volume is a series of corresponding observations made at St. Petersburg, on the horary variations of the magnetic declination, during various days in 1835 and 1836. The observations were generally made at intervals of five minutes throughout the entire twenty-four hours. Observations of this nature are now regularly made in various parts of the world, and will soon be greatly extended, through the zeal and liberality of the British nation. We trust that the series, of which the volume before us is so excellent a beginning, will be long continued, and that it may excite the honorable rivalry of all civilized nations to take part in so important a scientific enterprise.

A recent letter from Sir John Herschel to his distinguished correspondent in Boston, expresses an earnest wish that magnetic observations may be extended as far as possible on this vast continent. In anticipation of this view, the American Philosophical Society of Philadelphia had already addressed the Secretary of War on the subject—(we trust with success)—and we believe we are correct in stating, that the Girard College of Philadelphia has appropriated funds for the establishment of a magnetic observatory in connection with that institution.—Eds.

10. *On the geognostic position of the Zeuglodon, or Basilosaurus of Harlan.*—European geologists, whose attention has been directed to the remains of this gigantic animal, seem at a loss to refer it to its position in the scale of formations. If they mean the European formation, of which the American is the equivalent or contemporaneous deposit, I am not surprised at their uncertainty, since the limestone, which abounds in the remains of the Zeuglodon, contains a group of fossils which have scarcely any analogy to those of any European formation. But the position of the Zeuglodon in the scale of American formations is well ascertained, no less than the remains of nine individuals having been found in the limestone of Alabama, immediately under the lower tertiary fossiliferous strata, with which the limestone contains a few species of shells in common. This formation seems to fill the chasm which in Europe has been often noticed to occur between the secondary and tertiary series, or the Maestricht deposit and the eocene, and has been termed by Dr. Morton, "the upper cretaceous formation." It contains very few species in common either with the middle cretaceous strata below, or the lower tertiary above, and might with equal propriety be considered the last of the cretaceous, or the first of the tertiary series. Dr. Harlan has

referred them to the tertiary because they were covered by the eocene fossiliferous sands; but the bones were found on the shore of the Washita River, where the debris of the tertiary has enveloped them, and led to the mistake. I traversed the section of Alabama where the Zeuglodon occurs, and collected the organic remains of the limestone which contains the bones, and therefore I can say without hesitation or doubt, that the gigantic animal is restricted to this limestone, the vertebræ of the different specimens lying in a relative position to each other that could only occur where an animal has remained undisturbed upon the spot where it died.

T. A. CONRAD.

11. *Professor Johnson's Analyses of Anthracite and Iron Ore.*—In the Journal of the Franklin Institute, November, 1839, is a valuable paper by Prof. Walter R. Johnson, Prof. Chem. and Nat. Phil. Med. Dept. Penn. Coll., entitled—*Analysis of some of the Anthracites and Iron Ores found on the head waters of Beaver Creek, in the Counties of Luzerne, Northampton and Schuylkill, Pa.* The paper contains an account of the geological arrangement of the coal fields lying near the head waters of the Beaver Creek, which were explored by Prof. J. in the summer of 1838, and from which the specimens analyzed were obtained. From the cutting made for the railroad leading to the mines of the Beaver Meadow Coal Company, it is evident that there is more than one flexure in the Beaver Meadow Coal Trough. "In this cutting there is displayed a nearly vertical bed of coal, more than 30 feet in thickness; having, however, a real position or dip of S. 10° E. 85°, and consequently a course or strike N. 80° E." To the geological account succeed the descriptions and analyses of various specimens of anthracite.

No. 1. Sp. grav. 1.613. Water, 3.43; gaseous matter volatile at bright red heat, 4.08; carbon not volatile by simple heat, 87.48; earthy matter, 5.01=100.

No. 2. Sp. grav. 1.594. Water, 3.26; other matter volatile at red heat, 1.05; carbon, 91.69; earthy matter, 4.=100. Analysis of the ashes of No. 1 and 2, gave, on an average, silica, 52.375; alumina, 36.745; peroxide of iron, 8.125; lime, 1.550; magnesia, 1.275.

No. 3. Sp. grav. 1.630. Volatile matter, 9.6; carbon not volatilizable by simple heat, 85.337; earthy matter, 5.063=100. The combustible gas given out in the distillation of this coal is of considerable amount, and indicates it as a fuel well adapted for use under steam boilers.

No. 4. Sp. grav. 1.560. Water and combustible gases, 6.89; carbon not volatile by simple heat, 91.64; earthy residuum, 1.47=100.

Prof. J. remarks: "In comparing the results in the above analyses with those of other experiments on anthracite, I find the average amount of carbon much greater than has heretofore been assigned to that species of fuel. Thus, of twelve species of anthracite analyzed by Berthier, the mean per-centage of carbon was 79.15; ashes, 13.25; volatile matter, 7.37."

No. 5. Sp. grav. 1.6127. Combustible carbonic oxide, and a little carburetted hydrogen expelled at red heat, 3.55; carbon not volatilizable by simple heat, 86.06; earthy matter, 3.71=100.

No. 6. Sp. grav. 1.559. Water, .390; gaseous matter, including some azote, volatile at bright red heat, 5.515; carbon, not volatilizable by heat, 91.016; earthy matter and oxides, 3.079=100.

*Iron Ores.*—The bed of iron ore from which were taken the samples examined by Prof. Johnson, is found on the southern declivity of the bluff, about forty rods northerly from the south fork of Beaver Creek. The thickness of the bed of ore and shale is seven feet, and it lies seventeen feet beneath the surface of the ground at the point where it is opened. The *first* variety analyzed gave by the usual assay in the dry way, the following results:

Water, expelled at 250°, . . . . .	0.4
Carbonic acid, . . . . .	26.6
Cast iron, . . . . .	33.8
Earthy matter, . . . . .	26.64
Oxygen, . . . . .	12.55
	<hr/>
	99.99

The ore has a light bluish ash color, is moderately tough before calcination, and has a spec. grav. of 3.247. The pig metal given in the assay is soft, tough, and of a dark gray color. The cinder is a transparent, nearly colorless, glass, very fusible, and contains few adhering particles of metal. The use of pure carbonate of lime as a flux in the proportion of one part of this metal to six parts of raw mine, will produce a complete reduction of the ore and fusion of the earthy ingredients. Assayed in the humid way, this ore yields the following results:

Water, . . . . .	0.40
Carbonate of iron, . . . . .	63.20
"    of lime, . . . . .	2.50
"    of magnesia, . . . . .	2.27
Oxide of manganese (?), . . . . .	2.00
Silica, . . . . .	17.50
Alumina, . . . . .	10.55
	<hr/>
	98.42

The above quantity of carbonate corresponds to 39.1 per cent. of protoxide or 30.45 per cent. of pure metallic iron, which is 3.35 per cent. below the above yield in *pig metal*, or it is 9.9 per cent. of the pig metal itself, to be regarded as pure iron matter; which is probably very near the true average amount according to the latest and best analyses. The yield in *iron* is equal to the average of Scotch ores in the neighborhood of Glasgow.

The *second* variety of the ore examined, was a sample from the same locality, but from a different part of the bed from that in which the preceding was found. Sp. grav. 2.896. Assayed in the dry way it gave—

Water,	13.12
Pig metal,	44.96
Earthy matter,	24.804
Oxygen,	17.11

The ore seemed to have suffered a change by atmospheric influences, from the condition of a carbonate of the protoxide of iron, to that of a hydrate of the peroxide; in which process some of the earthy ingredients may have washed away. Analyzed in the *humid* way, it gave—

Water,	13.12
Peroxide of iron, with a trace of manganese,	63.65
Silica,	13.45
Alumina,	8.77
Magnesia,	1.01
	<hr/>
	100.00

The quantity of peroxide of iron corresponds to 44.55 per cent. of iron, or .41 per cent. less than that of the metal actually obtained. Hence it appears that the quantity of iron remaining in the cinder, is very nearly equal to that of the carbon, &c., in the pig metal.

Near the second bed of coal opened on the slope of the hill north of the northern branch of Beaver Creek, Prof. J. found some ore thrown out in excavating a coal shaft. It is of a brown, or yellowish brown color, compact, with small shining particles. Sp. grav. 3.555.

At a temp. of 330° it loses in moisture,	0.550
By strong calcination, it loses of water,	10.048
It contains of peroxide of iron,	71.120
“ earthy impurities,	13.382
	<hr/>
	100.

The quantity of pig metal obtained in Prof. Johnson's analysis was 49.77 per cent.; its color dark gray; structure crystalline, granular.

It was soft, tough, and well adapted for foundry purposes. The cinder was a perfect glass, translucent on the edges, of a smoky color, readily fusible before the blow-pipe, and consequently it presents no obstacle to the free running of iron in a furnace. This ore being in the immediate vicinity of the richest of the coals above described, will be a highly valuable resource, if it shall be found in beds of such thickness, and with such accompaniments as to render its attainment not too expensive.

12. *Parasite of the eggs of the Elm-tree Moth.*—On the 15th inst. I noticed several minute insects busily engaged in thrusting their eggs into the eggs of the *Elm-tree Canker-worm Moth*,—(supposed to be the *Geometra verinata* of Peck,) which had been laid a short time previous. On applying a microscope, it was immediately apparent that this parasitic insect belongs to the genus *Platygaster* of Latreille. Of this genus, Say has described one American species, (*Contrib. Macl. Lyceum*, p. 81, *Philad.*, 1829,) and Mr. F. Walker has published descriptions of ninety nine foreign species, in the *Entomological Magazine*, London, October, 1835. Whether the insect in question is new or not, I have been too much occupied to determine. Should it prove to be new, I shall endeavor to give some account of it hereafter. The parasite appears quite abundant, and must be of great service in checking the increase of the canker-worm.

E. C. HERRICK.

New Haven, November 30, 1839.

13. *Great Earthquakes in Burmah.*—The following account is from a letter written by Eld. E. Kincaid, Baptist Missionary in Burmah, to Dr. L. C. Paine, Albion, N. Y., and published in the *Utica Register* of Jan. 17th, 1840.

“On the 23d of March, 1839, between three and four in the morning, Ava was visited with one of the most terrible earthquakes ever known in this part of the world. A loud rumbling noise, like the roar of distant thunder, was heard, and in an instant the earth began to reel from east to west with motions so rapid and violent, that people were thrown out of their beds and obliged to support themselves by laying hold of posts. Boxes and furniture were thrown from side to side, with a violence similar to what takes place on board a ship in a severe storm at sea. The waters of the river rose, and rolled back for some time with great impetuosity, strewing the shores with the wrecks of boats and buildings. The plains between Umerapora and the river were rent into vast yawning caverns, running from north to south, and from ten to twenty feet in width. Vast quantities of water and black sand were thrown upon the surface, emitting at the

same time a strong sulphureous smell. As you will suppose, the cities of Ava, Umerapura, and Sagaing, are vast piles of ruins, burying in their fall great numbers of unfortunate people who were asleep at the awful moment. The destruction of life, however, is not so great as might have been expected from the entire overthrow of three large and populous cities. The reason is, the great mass of the people live in wood and bamboo houses. Had the houses in these cities been built of bricks and stone, as cities are built in America, the entire population must have perished. Every thing built of bricks,—houses, monasteries, temples, pagodas, and the city walls, are all crumbled down. Of all the immense number of pagodas in Ava, Umerapura, and Sagaing, and on the Sagaing hills opposite to Ava, not one is standing. The labor and wealth of ages, the pride and glory of Boodhism, have been laid low in the dust in one awful moment. \* \* \*

“Letters from Ava up to the 11th of April, inform us that the rumbling noise, like distant thunder, had not yet ceased; and shocks, often considerably violent, were felt day and night, with seldom as much as one hour’s intermission. The extent of the great shock, or rather the succession of great shocks on the morning of the 23d of March, is not yet fully ascertained. It was felt so severely in Maulmein, that many sprang out of bed, supposing a gang of thieves had broken into the house, yet it was not violent enough to do any damage. As far as is now ascertained, Prome to the south, and Bomee to the north of Ava, were entirely overthrown by the earthquake; so that from Prome to the borders of China, more than six hundred miles north and south, embracing the most populous parts of the empire, not a single pagoda, temple, or brick building is left standing. The earthquake was severe in Arracan, and an old volcano on the island of Bromree was re-opened, and the long-concealed fires, mingled with smoke and ashes, rose to a fearful height. It remains to be ascertained, how far this great earthquake extended into China; but as there are several volcanoes among the mountains between Burmah and China, it is more than probable to me that there are subterranean communications between these volcanoes in the north and the volcanoes to the south, as among the mountains between Arracan and Burmah, and in the island of Bromree, and also on the Andeman islands in the Martiban gulf.

“The two extremes are more than one thousand miles apart, in a direct line north and south. But the fact that the whole intermediate country was shaken at the same moment, and a prodigious subterranean noise was heard, resembling the rolling of thunder, is, I think, satisfactory evidence that there are subterranean communications between these widely separated volcanoes. How else can we account



for so terrible an earthquake over so vast an extent of country? The coincidence of volcanic eruptions and earthquakes is not remarkable, but that several hundred miles of territory, with all its mountains and rivers should be thrust up and thrown into undulating motions at the same moment of time, accompanied by sounds from the depths of the earth, like the rolling of thunder, are phenomena which cannot be accounted for on any other supposition than that of vast subterranean lines of communication between volcanic mountains."

14. *Progress of the U. S. Exploring Expedition.*—The following letter from the Commander of the Expedition was received by the Navy Department about the close of January, 1840.

U. S. Ship Vincennes, Matavai Bay, Island of Tahiti, Sept. 15, 1839.

*Sir*—I have the honor to report my arrival at this anchorage, after a passage of sixty days from Callao; having been employed in examining and surveying many of the islands to the northward and eastward; and take leave to submit the following report of the operations of the exploring squadron, under my command, since my report dated at Callao on the first of July last.

We sailed from Callao on the 13th of July, after completing our supplies of stores and outfits, having been much expedited by the facilities and kind attentions of Capt. McKeever, in command of the United States ship Falmouth.

We steered a westerly course through the trade wind, with fine weather. On our track we passed over the location assigned to an island, as laid down in Arrowsmith's chart, but saw nothing of it, or any appearance of land in the vicinity.

On our route, daily observations were made of the deep sea temperature and dip. We made the island Clermont de Tonnin on the 13th of August, of which we completed a survey, and ascertained the longitude of its southeast point to be  $136^{\circ} 21' 12''$  W. and latitude  $18^{\circ} 32' 49''$  S.

From thence we proceeded to Serle Island, the distance from Clermont de Tonnin being twenty seven miles. Here, again, we made a careful survey of the island, finding its southeast point in longitude  $137^{\circ} 4' 10''$  W. and latitude  $18^{\circ} 21' 10''$  S.

We saw nothing of Minerva Island.

We then proceeded to the northward toward the Disappointment group of Byron, and in our way fell in with Hondon Island, (which was uninhabited,) and found its southeast point in longitude  $138^{\circ} 47' 36''$  W., latitude  $14^{\circ} 55' 40''$  S.

From thence to Wyhite, one of the Disappointment group, the northwest point of which we found in  $141^{\circ} 17' 24''$  W. longitude, and

14° 10' 30" S. latitude. We surveyed the island, and had communication with the natives. From thence we steered to the second island, Otoooho, and found the longitude of its centre to be 141° 29' 50" W., and latitude 14° 3' 20" S. After which we again steered to the southward for Ravaka, lying to at night, owing to the dangerous navigation; and on the 30th of August we made an island to the northward of Rarika, not laid down on any chart, which I named King's Island, from the name of one of the crew of this ship, who first discovered it from aloft. We made a survey of it, and found the longitude of its centre to be 144° 37' 45" W., and latitude 15° 44' 10" S. We landed, but could find no inhabitants, although there were appearances of the pearl fishery having been carried on by the natives.

From thence we visited Rarika, and made a survey of it; the longitude of the entrance to its lagoon is 144° 57' 52" W., latitude 16° 5' 30" S. We landed, and found the natives very friendly. We took on board one Englishman from this island, who had been left by a vessel engaged in the pearl fishery some time previous.

To the westward, and in sight of Rarika, we discovered another large island, which is not laid down on any chart, which I named Vincennes Island, after this ship; its southwest point is in longitude 145° 12' W., and latitude 16° 39' S.; northwest point in longitude 145° 18' W., latitude 15° 52' 40" S.

From thence we made Carls-Hoff, 28 miles to the westward, and in longitude 145° 28' 36" W., latitude 16° 36' S., which, finding erroneously laid down, we surveyed.

From thence we made King George's group, and searched for the two islands westward of them, which have hitherto been considered doubtful, and were supposed to be the Waterland of Le Maire. The northern island, Wilson or Waterland, is in longitude 146° 5' 57" W., latitude 14° 26' S. These we surveyed, and having ascertained the existence of two islands, I named the second one Peacock Island, as that ship first made the signal of having discovered it; its longitude is 146° 25' 37", latitude 14° 34'. Here I had an opportunity of observing the eclipse of the sun, (Sept. 7.)

The squadron then separated; the Peacock passed to the Rurick chain of islands and along the south side of Prince of Wales island, the Vincennes taking the north side, the Porpoise and Flying Fish having been ordered to make investigations of islands in that vicinity.

These islands have been carefully examined on all sides, which has resulted in detecting many errors of the charts and of former determinations.

From thence we proceeded to Matea island, which we surveyed, and from thence direct to this anchorage.

The explorations and surveys were made in the boats and vessels, frequently running with the vessels within a quarter or half a mile of the shore and coral reefs; and I am happy to inform you that notwithstanding the dangerous navigation among these islands, we have escaped without accident, and I flatter myself that I have carried into effect most fully all that part of your instructions referred to in the notes of Admiral Krusenstiern, which were attached to and formed a part of them.

No opportunity has been omitted to land upon the islands and establish a friendly intercourse with the natives, and to make all possible observations and collections in the different departments, all of which will be disposed of agreeably to your instructions.

On my arrival here, I was gratified to find by the observation had at point Veners, my chronometers in error only 1' and 3" with the longitude of that point.

I shall remain here only a few days to complete our observations and procure a supply of wood, water, fresh provisions, and vegetables, for the crew, and proceed to carry out your farther instructions with all dispatch. I have the honor to be, Sir, most respectfully,

Your obedient servant,

CHARLES WILKES, *Commanding Exploring Expedition.*

To the Hon. J. K. PAULDING, *Secretary of the Navy.*

### 15. *The Twilight Bow.*

*To the Editors*—I have for several years been in the habit of observing a daily meteorological phenomenon which occurs twice in the 24 hours, and which, so far as I have been able to ascertain, has never been noticed in any scientific work, and yet seems worthy of the attention of philosophers. I mean the appearance, morning and evening, of a prismatic bow. Having shown the bow to several friends, they were equally struck with the fact that so obvious, and at the same time so beautiful a phenomenon, should not have attracted attention. It may still have been noticed in some scientific journals, though it has escaped my observation.

The bow in the morning begins to be defined in the west about half an hour before sunrise. The height of the arch is about  $15^{\circ}$  above the horizon, and spans nearly, perhaps quite,  $180^{\circ}$ . Its first aspect is that of a blue belt, the red next appears like a faint blush above the blue, producing the purple as it mingles with the blue. Then appears the yellow above the red, producing the orange as it mingles with the red. As the sun advances towards his rising, the bow descends to coincide with the horizon, and at an angle of  $8^{\circ}$  above the horizon, or about 15 minutes before sunrise, the colors are most dis-

tinct and concentrated. At sunrise, the bow coincides with the horizon.

In the appearance of the evening bow, the whole process of appearance and disappearance is in a reverse order : the bow is in the east ; it rises at sunset, and disappears in about half an hour.

The bow is best seen in the clearest atmosphere, and then an hour before sunrise, a second series of colors forms another bow within the other, and the same height above the horizon, very faint, it is true, and diffuse, but still very perceptible ; so that the series of colors, naming them as they proceed from the centre, and always naming the yellow first, would be yellow, blue, red, yellow, blue, red. I have long observed in examining the various series of prismatic rings that occur in nature, that the order of colors is not the same in the various series. Now in a series of three, we can have but two orders ; either there will be 1, 2, 3 ; 1, 2, 3 ; or 1, 3, 2 ; 1, 3, 2. In the prismatic spectrum there are but three primitive colors. Every series of concentric prismatic rings will therefore be one of two orders. The choice of a color to commence with in reading the orders of colors in any series, is indeed arbitrary, the result will always be the same, but as it is necessary to fix upon one, let us fix upon the yellow, and always read from the centre outwards ; this method will fix the order of any series, and the two orders may then very properly be termed the *blue* order or the *red* order, according as the *blue* or the *red* follows the yellow in reading the series. To illustrate these remarks I would state, that the rings produced by thin plates are of the *red order* ; the halo round the moon is of the *blue order* ; the series round a candle, seen through gauze, is of the *red order* ; the series on metallic plates, produced by throwing the flame of a blow-pipe perpendicularly upon a plate of metal, is of the *blue order* ; the rainbow is of the *red order* ; and in conformity with this arrangement, the bow which I have been describing, and which may perhaps with propriety be called the *Twilight Bow*, is of the *blue order*.

Perhaps some of your correspondents can explain this meteorological phenomenon. Your obedient servant,

SAMUEL F. B. MORSE.

New York City University, Dec. 1, 1839.

*Note.*—The *Twilight Bow* has, we believe, been often observed, but we do not know that any description of it is to be found in print. The blue portion of the arch appears to lie within the earth's shadow.—*Eds.*

16. *Lectures on Phrenology, by George Combe, Esq., of Edinburgh, in New Haven.*—A large audience, embracing a fair propor-

tion of cultivated minds, recently listened attentively to Mr. Combe's lectures on phrenology and mental philosophy, delivered in New Haven. His course occupied thirteen evenings, each lecture being two hours long, with an intermission of five minutes.

A thirteenth lecture, on physical education, was added to the usual course of twelve, and paid for extra, at a very reasonable rate, in order to purchase his collection of busts and masks, which object has been effected in consequence of a full attendance for that purpose, and they are to remain in New Haven.

During the eighteen months that have elapsed since the arrival of Mr. Combe in this country, its people have, in many places, enjoyed the opportunity of hearing phrenology explained by one of its most accomplished professors. The sterling good sense and integrity—the extensive and various science—the numerous illustrative anecdotes—the clear method—the unity of design and execution—the simplicity of language and the absence of all pretension, which characterize Mr. Combe's lectures, have secured for him the respect, esteem and kind regard of his hearers.

That all who listened, especially for the first time, to the details of this extraordinary branch of science, should fully adopt, or even entirely comprehend them, is not to be expected. But whatever opinion may be formed respecting the external manifestation of the mental powers and sentiments by the size and figure of the cranium, no one can doubt that all which distinguishes man from the animals, is manifested through his mind—that the propensities and the faculties are real, and therefore an able analysis of them by a master, must ever be an interesting and instructive thing. There is no doubt that the knowledge admits of important practical applications, and that a just comprehension of human physiology and anatomy, would correct many errors in education, and lead the way to reform in many important particulars as regards our habits of life.

We have no time or space in this passing notice, to add any thing more than our good wishes for Mr. Combe, assured that he has made very favorable impression of his powers and character in the country which he is about to leave.

17. *Proceedings of the Boston Society of Natural History, compiled from the Records of the Society, by* JEFFRIES WYMAN, M. D., *Recording Secretary.*

Oct. 2, 1839.—GEORGE B. EMERSON, Esq., President, in the chair.

The president made a report on a specimen of the *Lycopodon giganteum*, of Batsch. Its greatest circumference was 3 feet 4½ inches;

least do., 2 feet 9½ inches; greatest length, 1 foot 3 inches; weight, 6 pounds. At a distance, it had the appearance of a large bundle made of very dirty silk; near at hand, it resembled dirty white buckskin, or kid. It rested on the ground, its point of attachment being a very short, black stipe, around which the skin had the furrowed appearance of a handkerchief drawn together to tie at the corners. The surface, examined under a microscope, had the appearance of common white leather. The covering, or peridium, is twofold; the external layer is rather thin, and almost imperceptibly scaly; the inner, rather tough and thick. The substance within was of a close, soft, leathery, approaching to a fleshy consistence, having but little firmness. After having been kept a short time it became exceedingly offensive; it however ceased to be so after the third or fourth day.

Berkely says that the *bovista* sometimes attains the size of many feet in circumference, and when wounded, it heals by forming a web in the interstices, somewhat analogous to the veins of the truffle.

Oct. 15, 1839.—C. K. DILLAWAY, Esq., in the chair.

Dr. D. H. STORER read a communication from Dr. J. P. Kirtland, of Ohio, describing fifteen species of fishes, accompanying which were colored drawings. The species are as follows: *Luxillus elongatus*, *Semotilus biguttatus*, *Semotilus cephalus*, *Amia colva*, *Luxillus dissimilis*, *Petromyzon argenteus*, *Ichthelis aurita*, *Ichthelis nitida*, *Coregonus Artedii*, *Lota maculosa*, *Catostomus aureolus*, *Etheostoma blenioides*, *E. caprodes*, *Sciæna oscula*, and *Cychla fasciata*. Of these species five are new, and ten have not before been figured. Dr. Kirtland hopes to continue these communications till all the fishes of the western waters have been described.

Dr. T. M. BREWER stated that recently he had an opportunity to examine the habits of certain birds, while on an excursion through the States of New Hampshire, Vermont and New York. His attention had been more particularly turned to the habits of the *Hirundo fulva*, (Vieillot,) variously known as the *Republican*, *Rocky Mountain*, *Cliff*, *Eave* and *Square-tailed Swallow*. He had found their nests in Jaffrey, N. H., to the number of one hundred and twenty, disposed in a single line, and completely occupying the eaves on one side of an old wooden church. A few were engaged in feeding their young as late as Aug. 20. The note, both of the young and the parent, is a sharp and shrill twitter, as loud and piercing as that of the canary bird. They made their first appearance in Jaffrey, also in New Ipswich, during the present season. They have however been observed for several years in Nelson, N. H., from which place probably emanated the colonies of more recent date. This bird was first described by

Vieillot, in 1807, from specimens obtained in St. Domingo. It has, however, been for many years past known as a resident of the Rocky Mountains, from which region it has gradually moved eastward, and has been successively discovered in Kentucky, upon the banks of the Ohio, in New York, Maine, and of late in other New England states, their appearance being followed by the partial exclusion of the barn swallow. The nest, generally found in colonies, but occasionally solitary, is composed of clay, having the form of an inverted retort bulb, the mouth being below and the interior lined with soft substances.

Nov. 20, 1839.—GEORGE B. EMERSON, Esq., President, in the chair.

AMOS BINNEY, Esq., made a report on the volume entitled, *Reports on the Fishes, Reptiles and Birds of Massachusetts*, giving a detailed account of the history and progress of these Reports, and entering into a critical examination of their contents.

The report on Fishes by Dr. Storer, makes up the greater part of the volume, and constitutes an important contribution to American natural history. Considering the short period of time allowed for its completion, it is exceedingly creditable to the author's science, and to his diligence and perseverance. A new impulse has latterly been given to the study of ichthyology, by the publication of the works of Cuvier and Valenciennes, and of Yarrell. The cultivators of science will hail the present work with pleasure, as coming from a country whose ichthyology was not long since pronounced by Cuvier to be a desideratum in natural history. But its appearance has an importance at this time independent of its own particular merits, since it will serve as an effective check to the propagation of the mistakes and impositions of another work on Massachusetts fishes, which has already been quoted by respectable authors, and which was thus beginning to introduce confusion and error into science.

Of the small number of fishes appertaining to our territory, the whole number described being one hundred and nine, it is truly wonderful that they comprise all those genera and many of the species which contribute so largely to the subsistence of mankind, and which have for ages furnished the materials of an important branch of the commerce of nations. The pages of this work furnish ample proof of their importance to our community, by making known the fact that there are eighteen species which are objects of extended trade, and fifty-nine additional species, which, distributed by the bountiful hand of nature in countless numbers in the sea and fresh waters, and within reach of the poorest citizen, are or may be used as wholesome and nutritious food; while there only thirty-three species, which from their diminutive size, their hideous form, their coarse structure, or from some prejudice

connected with them, are absolutely rejected. It has been said that he should be considered a public benefactor, who makes but a single blade of grass grow where none grew before; the same honor ought truly to be accorded to another, who, though he cannot create, makes known to the community the existence of a new species of edible fishes, or that a species already known, though shunned or rejected from some unfounded prejudice, may be used with safety and advantage. This has been done to a considerable extent in this book, and no doubt with useful effect.

The new species described are ten; one, constituting a new genus, to which the author has given the name of *Cryptacanthodes maculatus*. It is of the family of "mailed cheeks," and particularly distinguished from any other genus of this family, by the existence of concealed spines on the operculum, preoperculum and scapular bones. It seems to be established on correct principles, and will undoubtedly be adopted by ichthyologists. The other new species are

Pholis sub-bifurcatus,  
 Leuciscus argenteus,  
 " pulchellus,  
 Morrhua Americana,  
 Platessa ferruginea,  
 Echeneis quatuordecem-laminatus,  
 Syngnathus fuscus,  
 " Peckianus,  
 Monocanthus Massachusettensis.

One of these is the common cod, of Massachusetts Bay, which Dr. Storer considers not to be sufficiently identified with the *Morrhua vulgaris*, of Europe, and therefore describes it as a new species, under the name of *M. Americana*. If this is a new species, it is a most extraordinary instance of a most abundant animal having passed through the hands of various observers, for a great length of time, without detection, including within their numbers so celebrated a naturalist as Pennant. But it may be considered as very doubtful whether this be any thing more than a variety. The same fish appears to have been noticed by Dr. Mitchill, in his paper on the fishes of New York, as the *M. callarias*, (Lin.) The remarks of Dr. Storer prove very clearly that it is not the European *callarias*; but it is doubtful whether Richardson's remark on Mitchill's, "that it is probably a distinct species," meant any thing more than that it was distinct from the *callarias* of which he was then speaking. Yarrell, who was evidently acquainted with Mitchill's description, considered it to be the common cod, as must be inferred from his quoting his words under his own description of *Morrhua vulgaris*. He also states most ex-



pressly, that the eastern coast of America, from the latitude of 66° north, to that of 40°, is abundantly frequented by them. Le Sueur, too, an excellent ichthyologist, and well acquainted with the markets of New York and Boston, where this fish may always be seen, did not consider it a novelty, although on the look-out for new species. The difference in the descriptions of the two species is not greater than that between other species inhabiting the shores of both continents. The number of fin-rays, particularly, seem to vary greatly from English species; the number stated by Yarrell and Dr. Storer, never corresponding, except in the ventral fin, which, in the family of Gadidæ, the only one in which comparison has been made, correspond in every instance. The question of identity now raised, will no doubt soon be determined, it being very easy to procure, through the fishermen, specimens of the true bank cod for examination.

There are in the work some few errors of fact, and inaccuracies of language, which, though of little importance in themselves, deserve notice, that the author's attention may be called to them, in anticipation of a reprint of his work, which without doubt will be called for before any considerable time shall elapse.

These remarks on the report on fishes, will be concluded with the expression of a sincere hope, in which I doubt not all will participate, that Dr. Storer will continue to give his attention to this subject, and will from time to time bring before the society such new information as he may acquire.

Having given so much time to the first report, there remains but little for the reptiles. The number of species of this class described is only forty. Of the order Chelonians there are eight, divided among the genera *Emys*, *Sternotherus*, *Emysaurus*, *Cistuda*, and *Sphargis*. The numerous order of Saurians is represented by a single lizard. Of the Ophidians there are twelve, one of which, *Coluber occipito-maculatus*, is a newly described species. The Batrachians number seventeen, viz. of the genus *Rana* four, *Hylodes* one, *Hyla* two, *Bufo* one, *Salamandra* nine. The descriptions are shorter and less elaborate than those of the fishes, and do not seem to have been produced with the same satisfaction to the author, but are entirely creditable to him.

The number of species belonging to the class of reptiles in this state, is without doubt destined to be very much enlarged. The Emydes or fresh-water tortoises, and the Salamanders, two genera which are distributed in extraordinary numbers in North America, have not yet contributed their full proportion to the list. In conclusion, the Society may be congratulated on the appearance of these reports. They are the legitimate fruits of the exertions of this institution in

disseminating new tastes and new sources of pleasure and usefulness in the community. Taking into view their public character, they are the best proofs of the success of our efforts, and should incite us to new endeavors in the same cause.

Dr. D. H. STORER exhibited the tails of two species of Ray, probably of the genus *Cephaloptera*, both of which were provided with two strong serrated spines near their anal extremities. One of the specimens was smooth and the other covered with short and conical spines. He also stated that a species of *Solea*, had been found in the waters of Massachusetts during the last six months.

Dec. 4, 1839.—GEORGE B. EMERSON, Esq., President, in the chair.

Prof. C. B. ADAMS read descriptions of two new species of shells, obtained by dredging, from the bottom of the harbor at New Bedford, viz. *Pleurotoma plicata* and *Tornatella puncto-striata*. He also stated that the *Pholas costatus* hitherto unknown in our waters, had also been found in the same locality.

Prof. A. also read additional descriptions to the following species of Say, viz. *Natica heros*; *Turbo aculeus*; *Solicurtus costatus*, and *Solen costatus*.

Dr. A. A. GOULD made a report on the shells from California committed to him at a previous meeting. He found them to consist of *Murex tricolor* and *bicolor*; *Cardium Californianum*, *Trochus vittatus*, *Bulimus undatus*, and several species of *Purpura*.

Dec. 18, 1839.—AMOS BINNEY, Esq., Vice President, in the chair.

Prof. C. B. ADAMS read descriptions of two new species of shells, viz. *Jaminia producta* and *Ancylus fuscus*, from Andover Mass. He also exhibited specimens of *Valvata tricarinata*, in which the carinæ were very indistinct.

Dr. D. H. STORER made a communication to the Society, stating that all the specimens in the ichthyological cabinet had been arranged in their appropriate genera, and, as far as practicable, in their geographical localities. The whole number of genera now in the cabinet is one hundred and fifty eight, containing three hundred and forty four species; of which one hundred and eighteen genera, and one hundred and ninety four species have been added during the last two years.

18. *Proceedings of the American Philosophical Society, Philadelphia. September 20, 1839.*—Professor Bache, on behalf of the Committee appointed on the paper of Professor Elias Loomis, of Western Reserve College, Ohio, entitled "Observations to determine the

Magnetic Dip at various places in Ohio and Michigan," reported in favor of publication, and the Report was adopted.

The observations recorded in this paper were made with a dipping needle by Gambey. The results are contained in the following table.

Place.	Latitude.	Longitude.	Date.	Magnetic dip.
Hudson, Ohio, .	41° 15' N.	81° 24' W.	September, 1838.	72° 48.2'
Hudson, Ohio, .	41 15	81 24	April, May, 1839.	72 46.8
Cleveland, Ohio,	43 30	81 51	May,	73 26.0
Detroit, Michigan,	42 19	83 03	"	73 42.6
Ann Arbor, do.	42 18	83 45	"	73 13.9
Ypsilanti, do.	42 14	83 38	"	73 18.0
Monroe, do.	41 55	83 28	"	73 32.3
Toledo, Ohio,	41 41	83 33	"	73 06.1
Maumee city, Ohio,	41 34	83 38	"	72 49.1
Sandusky, Ohio,	41 29	82 48	"	72 57.8

Professor Loomis infers from a comparison of these observations with others made in the eastern part of the United States, that the lines of equal dip intersect the parallels of latitude, their direction being from about N. 82° W. to S. 82° E.

Dr. Chapman, from the Committee appointed to apply to Mrs. Madison, for certain meteorological observations made by the late President Madison, reported that a number of documents had been received, and presented them to the Society. The secretaries were directed to return thanks to Mrs. Madison for this donation.

A necrological notice of the late Bishop White, prepared in pursuance of the request of the Society, by Bishop De Lancey, was read.

Dr. Chapman announced the death of Matthew Carey, of Philadelphia, a member of the Society, and Mr. Lea was requested to prepare an obituary notice of the deceased.

Dr. Bache announced the decease of Dr. Robert Perceval, of Dublin, a member of the Society.

The Librarian of the Society was authorized to furnish to the family of the late Dr. Bowditch, to be placed in the library of the deceased, any volumes of the Transactions which may be deficient in the set belonging to Dr. Bowditch, and the future volumes, so long as the library shall be kept open for public use.

Dr. Hays presented a table, compiled by him, of the peculiarities in various cases of individuals not able properly to distinguish colors. Mr. Kane added the comparisons which he had made, in the case of a friend, with the specimens named by Dr. Dalton, of Manchester, in the possession of Professor Bache.

Professor Bache made a verbal communication of the measures taken by the British government, on the recommendation of the British

Association, and under the advice of the Royal Society, for obtaining a series of magnetic observations in different quarters of the globe, in conjunction with a naval expedition in the southern hemisphere, under the command of Capt. James Clark Ross, and read extracts from letters of Professor Lloyd and Major Sabine, relating to the preparation for the undertaking.

Professor Bache further stated, that on submitting the circular addressed to him by the Foreign Secretary of the Royal Society, with extracts from the letters before referred to, and other information as to the nature and importance of the results to be obtained by this combined system of magnetic observations, to the Building Committee of the Girard College, through their Architect, they had, with creditable liberality, given orders for the erection of an observatory suited to the observations contemplated, and to the instruments already in the possession of the Trustees of the College.

Professor Bache submitted the plans of the observatory drawn by Thos. U. Walter, Esq. Architect.

Mr. Justice made some remarks in continuation of those offered at the last meeting of the Society, in support of his opinion of a gyratory motion in the tornado, of the 31st July, 1839, the destructive effects of which were felt about seventeen miles north of Philadelphia.

October 4, 1839.—The Committee, consisting of Dr. Dunglison, Mr. Kane, and Mr. Lea; to whom were referred a letter of the Rev. Charles Gutzlaff to John Vaughan, Esq. dated Macao, January 2, 1839, and the letter of Peter S. Du Ponceau, Esq. to the same gentleman, dated Philadelphia, September 20, 1839, made their report, which was read and accepted.

The communication of Mr. Gutzlaff was suggested by the dissertation of Mr. Du Ponceau, "On the nature and character of the Chinese system of writing." As the results of his reflection and observation, Mr. Gutzlaff affirms, that China was the great centre of civilization, whence it diverged to all the countries of Eastern and Southern Asia; the colonists from China driving the autochthonous tribes into the mountains, and incorporating the country itself, including Tunkin and Annam, with the central kingdom. A constant influx of Chinese also took place into Korea, but the emigration to Japan and the Loo Choo Islands was less extensive.

Chinese words, and the Chinese art of writing, were thus introduced into these countries; Chinese books became their literature; and, like the Latin in the middle ages, the Chinese was the language of the learned. Yet all the nations that have adopted the Chinese mode of writing, speak a language more or less distinct from the written idiom. The different nations, too, who employ the Chinese characters, call

them differently, using their own language to designate them, and they, as well as the Chinese themselves, have to learn the meaning of the characters from teachers, who explain them in the dialect spoken amongst the people. The dialects spoken by the different nations, who use the Chinese character, are very distinct from the language of China proper. The Koreans and Japanese, whilst they transact all important business in the Chinese character, have a syllabary with which they write their own language. The Cochin Chinese occasionally use the Chinese in a contracted form, without any reference to its meaning, to express sounds, but they have no syllabary.

It is not strictly true that sound is not inherent in the Chinese character. A majority of the signs are not pronounced by the Chinese at random, nor do the nations abandon all analogy in reading them, although they vary much. Mr. Gutzlaff has been struck with the ease with which communication may be held with the Cochin Chinese, Japanese and Koreans, by means of the Chinese character, even without comprehending a word of their idiom. This, he says, does not refer to the learned classes only, but to the very fishermen and peasants, with some exceptions only. In the Loo Choo Islands, men of distinction talk Chinese with great fluency, but the mass of the people speak a dialect of the Japanese, and employ the Chinese character as well as the Japanese syllabary. Mr. Gutzlaff considers it certain, that the nations who have adopted the Chinese character, attach the same meaning to it as the natives from whom it was originally derived, and that its construction is likewise retained with scarcely any alterations.

The communication of Mr. Du Ponceau is a rejoinder to that of Mr. Gutzlaff. Mr. Du Ponceau repeatedly combats the notion entertained by some, that the superiority of the Chinese alphabet is such that it forms a kind of pasigraphic system, which may be adapted to every language. He admits, to a certain extent, what he was disposed at one time to doubt, that the Chinese characters do actually serve as a means of communication between different nations, who can neither speak nor understand each other's oral language, and he investigates at some length, the causes by which the effect is induced; but he expresses himself at a loss to understand how the fishermen and peasants of Japan, Korea and Cochin China, "with only some exceptions," can be readily communicated with by means of Chinese characters, even by a person who does not understand a single word of their spoken language. The remark of Mr. Gutzlaff, he conceives, cannot be meant to imply that all, or nearly all the fishermen and peasants of the countries referred to, can read and write the Chinese; for, on the authority of Mr. Medhurst, there are villages, even on the coast of China, where few, if any, of the inhabitants can either read or write. If,

however, the assertion of Mr. Gutzlaff be assumed to be rigorously accurate, it will have to be explained by the circumstance, that as the Chinese is esteemed a universal medium of communication between the people referred to, it is more extensively taught amongst them than even amongst the Chinese themselves.

Mr. Du Ponceau enters, at some length, into the nature of the four languages, or classes of languages which are embraced in the communication of Mr. Gutzlaff. 1. Of the various dialects of the Chinese. 2. Of the Annamitic languages. 3. Of the languages of Japan and the Loo Choo Islands; and 4. Of the Korean; the two first of which are monosyllabic, the two last polysyllabic; and from all the facts and reflections, he concludes, that the circumstance of the Chinese characters being understood so extensively amongst these people, is not owing to any thing inherent in the Chinese characters, in their shape or greater perspicuity, but to their connexion with the languages from which they were formed, and to the mode in which they have been adapted to them. The vernacular languages of Japan, the Loo Choo Islands, and Korea, are so different from the Chinese, that it was found impossible to apply to them the Chinese system of writing; consequently, when the people of these countries read the Chinese characters, they do not read them in their native language, but in the Chinese, which they have acquired, but pronounce differently from the Chinese themselves. This is not the case with the people of Tunkin and Cochin China—the Annamites; their language or languages being formed on the model of that of China, with some variations, which they learn, in their schools, to correct, and to employ the proper characters as a superior orthography, by which they are enabled to read the Chinese as well as their own language.

The Committee recommended that the interesting communications of Mr. Gutzlaff and Mr. Du Ponceau, tending as they do, to elucidate a contested topic of Oriental philology, be published in the transactions of the Society.

Dr. Hare made a verbal communication on the subject of tornadoes, and on his electrical theory of their formation, supporting his views by reading an extract from a Memoir by M. Peltier, describing a destructive tornado which occurred near Paris, in June last.

Dr. Hare stated that agreeably to a publication in the *Journal des Débats* for the 19th of July, some losers by this tornado having effected insurance against damage from thunder gusts, applied to the insurers for indemnity, which was refused, upon the plea that a tornado was not a thunder gust (orage). The question having been submitted to Arago, it was by him referred to Peltier.

Peltier, after due investigation, came to the conclusion that a tornado is a modification of the thunder gust, in which, in lieu of passing in the form of lightning, electricity passes through a cloud, acting as a conductor between the terrestrial surface and the sky. It will be perceived that this view of the subject differs but little from that which, in a memoir in the transactions of the Society, had been presented by Dr. Hare, in the following language :—"A tornado is the effect of an electrified blast of air, superseding the more usual means of discharge between the earth and clouds, in the sparks and flashes which we call lightning. I conceive that the effect of such a current would be to counteract, within its sphere, the pressure of the atmosphere and thus to enable this fluid, in obedience to its elasticity, to rush into the rarer medium above."

Dr. Hare went on to say, that the only difference arises from the omission of the Parisian philosopher to call in the elasticity of the air in aid of the electrical forces, and his assigning to a cloud the agency which Dr. Hare had attributed to a vertical blast of electrified air, mingled with every species of movable matter coming within the grasp of the meteor; and that it would seem, from a subsequent communication made by Peltier to the Institute, that he had so entirely misapprehended Dr. Hare's theory, as to ascribe to it deficiencies for which it was not amenable, but which had existed in his own explanation, as stated in his report.\*

The fault of Dr. Hare's explanation was, according to him, "*en ne tenant pas compte des forces nouvelles que la première, (that is to say, the electric attraction,) acquiert par le mouvement gyrotoire quiaccompagne souvent la coulonne de nuages et d'eau qu'on appelle trombe.*"

As the most appropriate refutation of this misstatement, Dr. Hare stated that he would quote a paragraph from his Memoir.

"*When once a vertical current is established, and a vortex produced, I conceive that it may continue after the exciting cause may have ceased.*

"*The effect of a vortex in protecting a space about which it is formed, from the pressure of the fluid in which it has been induced, must be familiar to every observer. In fact, Franklin ascribed the water spout to a whirlwind.*

---

\* Tout confirme donc que la trombe n'est qu'un conducteur nuageux; qu'elle sort de passage aux décharges continue de nuages supérieure que la différence entre un orage ordinaire et l'orage accompagné du trombe, est dans ce conducteur servant à établir le combat entre l'extrémité de la trombe, et la portion du sol situé au dessous. (See Peltier's report upon the tornado of Chatenay, *Journal des Débats du 17 Juillet, 1839.*)

*“ His hypothesis was I conceive, unsatisfactory, because it did not assign any cause for the concentration of the wind, or for the hiatus presumed to be the cause. This deficiency is supplied, if my suggestions be correct.”*

On reading this passage, after previously hearing or reading the allegation above quoted, that Dr. Hare's hypothesis was defective in not appealing to a gyratory movement, it was presumed that it would be perfectly evident to every one, that, from ignorance of English, or inattention, Mr. Peltier's statement was the reverse of the reality.

In proof of a gyratory force having been exercised during the New Brunswick tornado, Dr. Hare referred to his having, in his Memoir, cited the case of a chimney, of which the upper portion had been so twisted upon the lower portion, as to have its corners projecting over the sides of the latter; but he had now taken a different view of that fact, which had since struck him as being of much higher importance than he had formerly considered it.

During an examination of the track of the tornado which lately ravaged the suburbs of New Haven, Conn., Dr. Hare had been led to infer that the electrical discharge is concentrated upon particular bodies, according to their character, or the conducting nature of the soil; so that the vertical force arising from electrical reaction, and the elasticity of the air, acts upon them with peculiar force. Hence, while some trees were borne aloft, others, which were situated very near them on either side, remained rooted in the soil. In two instances at New Haven, wagons were especially the victims of the electro-aërial conflict. In the case of one of these, the axletree was broken, and while one wheel was carried into an adjoining field, the other was driven with so much force against the weather-boarding of a barn, as to leave both a mark of the projecting hub, and of the greater portion of the periphery. The plates of the elliptical springs were separated from each other. During the tornado at New Brunswick, the injury done to some wagons in the shop of a coach-maker, appeared at the time inexplicable. It was now inferred, that the four iron wheel-tires, caused by their immense conducting power, a confluence of the electric fluid, producing a transient explosive rarefaction, and a subsequent afflux of air with a local gyration of extreme violence.

It may be reasonably surmised, that the excessive injury done to trees results, not from the general whirl, but from a local gyration to which they are subjected, in consequence of the multiplicity of points which their twigs and leaves furnish for the emission of the electrical fluid. The fact that the leaves of trees thus injured, appear afterwards as if they had been partially scorched, seems to countenance this idea. The twisting of the chimney at New Brunswick, as above



mentioned, seems difficult to explain, agreeably to the idea of a general whirl, throughout the whole area of the tornado track. The chances are infinitely against any chimney having its axis to coincide with that of a great whirlwind, forming a tornado; and it must be evident, that in any other position, it could only be subjected to the rotary force on one side at a time. But if this were adequate to twist the upper upon the residual portion, the former would necessarily be overthrown. Evidently, it could not be left, as was the chimney which called forth these remarks.

During the tornado at New Haven, chimneys seemed to be especially affected. One, after being lifted, was allowed to fall upon a portion of the roof of the house to which it belonged, at a distance from its previous situation too great to have been reached, had it been merely overthrown. In the case of a church which was demolished, a portion of the chimney was carried to a distance greater than it could have reached without being lifted by a vertical force.

It appeared quite consistent that chimneys should be particularly assailed, since that rarefaction, which, by operating upon the roofs of houses, carries them away, must previously cause a great rush of air through the chimney flues. But this concentration of the air must tend to facilitate the "convective"\* discharge in that direction; since an electrical discharge by a blast of air, is always promoted by any mechanical peculiarities favoring an aerial current or jet.

That during a recent tornado in France, articles were carried from the inside of a locked chamber to a distance without, when no opening existed besides that afforded by a chimney, seemed to justify the suggestion that there must be a great rush of air through such openings.†

Dr. Hare also made some remarks on the aurora which occurred on the 3rd of September, 1839, in which he suggested that the electric fluid, producing the phenomena then observed, might have been derived from remote parts of space.

---

\* A "convective" discharge, or a discharge by "convection," in the very appropriate language of the celebrated Faraday, is a process by which electricity is conveyed by the transfer of electrified bodies from one excited surface to another in an opposite state. This is conceived to be a good definition of the discharge which produces a tornado.

† Dr. Hare did not conceive it proper to trespass upon the time of the Society, to make any allusion to that part of his memoir, in which the three enormous concentric spaces occupied by the earth, the denser non-conducting atmosphere, and the rare conducting medium beyond the denser atmosphere, are represented as competent to perform a most important part in the production of electrical storms; nor did he feel at liberty to make any remarks in support of an opinion which he had recently formed, that a hurricane is a gigantic tornado. Neither had he time to cite the evidence furnished by Reid's work upon storms, in favor of a local force or gyration, like that of which he had seen proofs, arising from the New Haven tornado.

Oct. 18.—The following extract from a letter, addressed by Prof. Henry, of Princeton, to Prof. Bache, was read, announcing the discovery of two distinct kinds of dynamic induction, by a galvanic current.

“Since the publication of my last paper, I have received through the kindness of Dr. Faraday, a copy of his fourteenth series of experimental researches; and in this I was surprised to find a statement directly in opposition to one of the principal results given in my paper. It is stated in substance, in the 59th paragraph of my last communication to the American Philosophical Society, that when a plate of metal is interposed between a galvanic current and a conductor, the secondary shock is neutralized. Dr. Faraday finds, on the contrary, under apparently the same circumstances, that no effect is produced by the interposition of the metal. As the fact mentioned forms a very important part of my paper, and is connected with nearly all the phenomena described subsequently to it, I was anxious to investigate the cause of the discrepancy between the results obtained by Dr. Faraday and those found by myself. My experiments were on such a scale, and the results so decided, that there could be no room for doubt as to their character; a secondary current of such intensity as to paralyze the arms having been so neutralized, by the interposition of a plate and riband of metal, as not to be perceptible through the tongue. I was led by a little reflection to conclude that there might exist a case of induction similar to that of magnetism, in which no neutralization would take place; and I thought it possible that Dr. Faraday’s results might have been derived from this. I have now, however, found a solution to the difficulty in the remarkable fact, that an electrical current from a galvanic battery exerts *two* distinct kinds of dynamic induction: one of these produces, by means of a helix of long wire, intense secondary shocks at the moment of breaking the contact, and feeble shocks at the moment of making the contact. This kind of induction is capable, also, of being neutralized by the interposition of a plate of metal between the two conductors. The other kind of induction is produced at the same time from the same arrangement, and does not give shocks, but affects the needle of the galvanometer; it is of equal energy at the moment of making contact, and of breaking contact, and is not affected by the introduction of a plate of copper or zinc between the conductors.\* The phenomena produced by the first kind of induction form the subject of my last paper, as well as that of the one before; while it would appear from the arrangement of Dr. Faraday’s experiments, that the results detailed in his first series,

---

\* Since writing the account of the two kinds of induction, I have found that the second kind, although not screened by a plate of copper or zinc, is affected by the introduction of a plate of iron. In the cases of the first kind of induction, iron acts as any other metal.

and those in the fourteenth, were principally produced by the second kind of induction. Although I may be too sanguine in reference to the results of this discovery, yet I cannot refrain from adding that it appears to lead to a separation of the electrical induction of a galvanic current from the magnetical, and that it is a step of some importance towards a more precise knowledge of the phenomena of magneto-electricity."

19. *Ehrenberg on the Infusoria*.—The following interesting conclusions are stated in a short review, given in Charlesworth's Mag. of Nat. Hist. London, Oct. 1839, of Ehrenberg's recent work, entitled *Die Infusions thierchen*, etc. (Leipzig. folio. 64 plates.) In the *Infusoria* themselves, Prof. Ehrenberg has either confirmed or first established a considerable number of very curious qualities and relations, which are highly interesting in a physiological and other points of view, the most important of which we briefly enumerate.

1. Most (probably all) microscopic *animalcula* are highly organized animals.
2. They form, according to their structure, two well-defined classes.
3. Their geographical distribution in four of the parts of the world follows the same laws as that of other animals.
4. They cause extensive volumes of water to be colored in different ways, and occasion a peculiar phosphorescence of the sea by the light they develop.
5. They form a peculiar sort of living earth; and as 41,000 millions of them are often within the volume of *one cubic inch*, the absolute number of these *animalcula* is certainly greater than that of all other living creatures taken together; the aggregate volume is even likely to be in favor of the *animalcula*.
6. They possess the greatest power of generation known within the range of organic nature; one individual being able to procreate many millions within a few hours' time.
7. The *animalcula* form indestructible earths, stones, and rocks by means of their siliceous *testæ*; with an admixture of lime or soda they may serve to prepare glass; they may be used for making floating bricks, which were previously known to the ancients; they serve as flints, as tripoli, as ochre, for manuring land, and for eating, in the shape of mountain meal, which fills the stomach with a harmless stay. They are sometimes injurious by killing fish in ponds, in making clear water turbid, and in creating miasma; but that they give rise to the plague, *cholera morbus*, and other pestilential diseases, has never been shown in a credible manner.
8. As far as observation goes, the *animalcula* never sleep.
9. They exist as *Entozoa* in men and animals, the *Spermatozoa* not being taken into consideration here.
10. They themselves are infested with lice as well as *Entozoa*, and *on the former, again, other parasites have been observed*.
11. They are,

in general, affected by external agents, much in the same manner as the larger organic beings. 12. The microscopic *animalcula* being extremely light, they are elevated by the weakest currents, and often carried into the atmosphere. 13. Those observers who think they have seen how these minute creatures suddenly spring from inert matter, have altogether overlooked their complicated structure. 14. It has been found possible to refer to certain limits or organic laws, the wonderful and constant changes of form which some of these *animalcula* present. 15. That the organism of these *animalcula* is comparatively powerful, is evinced by the strength of their teeth and of their apparatus for mastication; they are also possessed of the same mental faculties as other animals. 16. The observation of these microscopic beings has led to a more precise definition of what constitutes an animal, as distinct from plants, in making us better acquainted with the systems of which the latter are destitute—*W. W.—Weimar.*

20. *Meeting of the British Association for the Advancement of Science.*—Just as this No. was closing, we have received the following important communications, to which by request, we give immediate insertion.

1. *Letter from RODERICK IMPEY MURCHISON, Esq., to Prof. SILLIMAN.*  
London, 16 Belgrave Square, Feb. 24, 1840.

*My dear Professor*—I enclose herewith an invitation to attend the next meeting of the British Association, to be held at Glasgow on the 17th of September next. The local authorities of that city, from whom this invitation is sent, wish you to be the organ, through your widely circulated and valuable Journal, of asking any Professors or cultivators of science in the different states of N. America, to honor us by being present at our next meeting.

I need hardly tell you who are so well versed in British geology, that Glasgow is peculiarly attractive to geologists, and that the Isle of Arran alone will afford much instruction in some of the most interesting pages of geological history.

As Senior General Secretary of the Association, I can assure you, that the greater the number of your countrymen, who may honor the meeting with their presence, the higher will be the gratification of the officers and council of our body, including yours, very faithfully,

ROD. I. MURCHISON.

2. *Circular of the British Association for the Advancement of Science, addressed to the gentlemen invited to attend its next meeting.*

Glasgow, 1st January, 1840.

*Sir*—We have the honor to announce, that the next meeting of the British Association for the Advancement of Science, takes place in

Glasgow, beginning on 17th September, 1840, and continues its sittings for one week. Actuated by the ambition to procure the countenance of your illustrious name, and the aid of your distinguished talents, as well as by the desire to confer on British men of science the highest gratification, the citizens of Glasgow have ventured to hope, that your engagements and convenience may permit you to do them the honor of visiting them on that occasion, and they beg to assure you of their best hospitality.

Should you feel at liberty to honor them in this manner, we respectfully solicit you to notify your intention by letter to the secretaries, previous to 1st July next, in order that due arrangements may be made for your reception.

We have the honor to be, Sir, your obedient servants,

HENRY DUNLOP, *Lord Provost of the City.*

D. MACFARLAN, { *Principal, Univer. of Glasgow,*  
*V. P. British Association.*

J. P. NICHOL,  
 ANDREW LIDDELL, } *Local Secretaries.*  
 JOHN STRANG,

3. *Letter to Prof. SILLIMAN, from one of the local secretaries.*

*Sir*—It has been suggested that instead of sending special invitations to the many scientific individuals, of which the United States of America can boast, that you would have the goodness to state in your widely circulating Journal, the fact that the British Association is to meet at Glasgow on the 17th Sept. next, and that the local committee would feel highly honored with the presence of as many of the men of science of America, as can make it convenient to attend. It is calculated that the coming meeting will be the largest that has ever taken place in Great Britain.

I am, Sir, your most obedient servant,

JOHN STRANG, *Secretary.*

4. *British Association for the Advancement of Science.*

Office-bearers for meeting at Glasgow, on Thursday, 17th September, 1840.

*President.*—The most noble the MARQUIS OF BREADALBANE.

*Vice-Presidents.*—The very Rev. PRINCIPAL MACFARLAN, LORD GREENOCK, SIR THOMAS M. BRISBANE, Bart., SIR DAVID BREWSTER.

*General Secretaries.*—R. I. MURCHISON, Esq., F. R. S., London, MAJOR SABINE, London.

*Secretary to Council.*—JAMES YATES, Esq., London, PROFESSOR PHILLIPS, York, *Assistant Secretary.*

*Treasurer.*—JOHN TAYLOR, Esq., London.

*Local Secretaries.*—PROFESSOR NICHOL, LL. D., ANDREW LIDDELL, Esq., JOHN STRANG, Esq.

*Local Treasurer.*—CHARLES FORBES, Esq., Banker.

*Committees.*—On finance.—The Hon. the LORD PROVOST, *Convener*. JOHN LEADBETTER, Esq., *Sub-Convener*. JAMES M'CLELLAND, Esq., *Accountant, Secretary and Treasurer*.

To provide sectional and other accommodations.—WM. RAMSAY, Esq., *Professor of Humanity, Convener*. JAMES SMITH, Esq., *Architect, Sub-Convener*. ALEX. M'DOWALL, Esq., *Writer, Secretary*.

On exhibition of Models and Manufactures.—JOHN HOULDSWORTH, Esq., *Convener*. WM. HUSSEY, JUN. Esq., *Sub-Convener*. JAMES THOMSON, Esq., *C. E. Secretary*.

On Museum of minerals found in the West of Scotland.—THOMAS EDINGTON, Esq., *F. R. S. Convener*. WM. MURRAY, Esq. of Monkland, *Sub-Convener*. Dr. WM. COUPER, *Professor of Natural History, Curator*. THOMAS EDINGTON, JUN. Esq., *Secretary*.

5. *Classification of Rocks.*—*Extract of a letter from R. I. MURCHISON, Esq., to Prof. SILLIMAN, dated London, Feb. 24, 1840.*

“In furtherance of the views which we propounded last year, of classifying the ancient rocks beneath the carboniferous system into three great systems or terrains, “Devonian,” “Silurian,” and “Cambrian,” Prof. Sedgwick and myself are about to read before the Geological Society of London a memoir, in which we endeavor to show the true succession of these strata in the Rhenish provinces, parts of Germany, Belgium, &c., and their relations to our British rocks. I am most impatient to test the value of this classification in the United States, but a year at least must elapse before I can think of an expedition to your shores. Complete suites of the fossils of the infra-carboniferous rocks would be most valuable to me, and most gladly repaid by a copy of my large work, or with Silurian fossils.”

21. *On the action of Metallic Tin on solutions of Muriate of Tin;* by AUGUSTUS A. HAYES.

It has been long known to those who frequently dissolve tin in muriatic acid, that under some circumstances, the metal after it has been dissolved is precipitated. It sometimes presents large sections of octahedral crystals, at others, long prismatic needles, which are so arranged as to form skeletons of such sections. In this Journal, Vol. xxvii, p. 255, Mr. W. W. Mather has described some experiments having a similar result. The interest which has been excited of late by notices of the non-action of metals in acid solutions and in relation to chemical action of a similar kind, has induced me to publish the facts which I sometime since observed.

When tin is dissolved in muriatic acid, either by gradual action under exposure to air, or by the aid of heat, a solution containing an excess of acid is obtained. This solution may be concentrated to a sp. gr.=1.750, and retains its fluid form at or above 60° F. Although an excess of tin is present, the solution thus obtained is always acid. After decanting the clear solution, the tin used in excess with its impurities remains. Generally, after a few days exposure, the matters left in the solution vessel change in appearance. The dull, corroded fragments of metal become frosted over, with bright needles of tin, and beautiful arborescent forms are seen. On studying the circumstances, I have found that the effect is due to electrical action. One portion of the undissolved tin, becoming a *positive* electrode, while another portion of the same mass assumes the state of a *negative* electrode, and precipitation of the dissolved tin takes place on it. Numerous cases of like action are known to chemists, where a part of a bar becomes indifferent to a concentrated solution, although a positive state is exhibited at another part, and active solution of the metal is taking place.

For the purposes of experiment, a solution of muriate of tin, of sp. gr. about 1.650, contained in a cylindrical vessel, may be carefully covered by half its volume of an acid solution of the same, having a sp. gr. about 1.20. The two fluids should not be mixed more than the slight diffusion which will take place. After placing a flat bar or plate in an inclined position, so that it passes through both solutions, the effects become immediately perceptible. That part of the bar which is within the diluted solution takes the *positive* state. A few minute bubbles of hydrogen form and escape, if the solution is quite acid. Precipitation of metallic tin commences near the line of contact of the two solutions, and extends throughout that part of the bar immersed in the denser solution. If the diluted solution is not rendered acid by the addition of acid, hydrogen is not perceived, and the action is more gradual. In either case the precipitation continues until the two fluids have attained the same electrical relation to the bar. If after the precipitation has ceased, water be carefully poured upon the surface of the fluid, it will form a stratum of very dilute solution. That part of the bar not before immersed takes the negative relation to this solution, and the same kind of precipitation follows as had taken place in the lower solution. The positive part of the bar, retains its state unaltered under the new conditions, and the line of separation is as clearly defined as in the first case. If a solution mixed with crystals be used, instead of a moderately concentrated solution, they are not decomposed under the above conditions. The presence of atmospheric oxygen has been supposed to influence

this action. Such is not a correct statement; by exposure to atmospheric vapor, strong solutions of muriate of tin become weaker, and any masses of undissolved tin, projecting into the weaker solution, will decompose the denser solution below. In numerous trials, I have found all the cases of precipitation referable to different states of two solutions resting in contact.

Roxbury Laboratory, March 16, 1840.

22. *New Minerals*.—Associated with the nitrate of soda of the province of Tarapuca, I have found the iodate of soda or potash, in irregular crystalline grains. The chloriodate of magnesia, in the state of solution, colors parts of the masses of the nitrate of soda a lemon yellow color. This new salt, doubtless, exists in mineral waters, conferring its highly active properties on them. The so called sulphate of alumina, from near Iquique, is a new mineral species, composed essentially of sulphuric and phosphoric acids, alumina and magnesia. It is entirely soluble in a small proportion of water, and is one of the most beautiful of saline minerals. Borate of magnesia, containing a larger than usual proportion of water under a different crystalline form, is found in the vicinity of the latter. A. A. HAYES.

March 16, 1840.

23. *An additional fact illustrating the inferior surface of the Calymene Bufo*; by Prof. JACOB GREEN, M. D.—In one of the recent numbers of your valuable Journal, there were published a few facts, which I had been so fortunate as to collect respecting the structure of the inferior surface of the trilobite. The *Calymene Bufo* was the species to which most of my remarks applied. The following additional note will perhaps be interesting to some of your readers.

Within a few days I received from my friend, Mr. T. A. Conrad, the zealous and distinguished fossilist of the New York survey, three highly interesting fragments of the *C. Bufo*, which develop a small portion of its anatomical structure not heretofore observed. In my former communication above noticed, the following statement will be found. "None of our fragments exhibit fairly the small surface on each side of the *gullar plate*, and the edge of the buckler beneath the eyes. This space was probably concave," &c. Now the fragments of Mr. Conrad illustrate this part of the organization in quite a satisfactory manner. This space is concave, and the edge of the buckler beneath the eyes, which in one of the specimens is very perfect, is marked by six denticulations or tooth-like prominences along the inferior edge of the lower lip. The lower lip has therefore a smooth or unbroken edge in front, and is terminated on each side below the eyes by a denticulated margin.

In no instance have I seen the interior edge of the buckler so perfect as in one of the above specimens, and in looking at the groove which forms the lips, one is almost persuaded to believe that the mouth of the animal was really located in this part of the head.



# INDEX TO VOL. XXXVIII.

## A.

- Acid, carbonic, apparatus for solidifying, Johnston's, 297.
- Adams, Prof. C. B., new species of Delphinula, 193.  
Shells obtained by dredging, and other new species, 396.
- Agriculture, collection of statistics, 135.
- Alger, Mr. F., exchanges of minerals, 380.
- Allen, Z., letter to R. Hare on the Providence Tornado, 74.
- Alligator, a huge one killed at Manilla, account of, 313.
- American Association for Advancement of Science proposed, 179.  
Philosophical Society's Proceedings, abstract of, 153.
- Analysis of Chrome Iron, 243.  
of Idocrase, 120.  
of Iron Ore and Anthracites, 382.  
of a meteoric mass from East Tennessee, by Troost, 250.  
of serpentine marble from Vermont, by Jackson, 198.  
of water from British Channel, 12.
- Andromeda mariana, 196.
- Anemometer, indications of, 103.
- Antarctic Expedition, 204.
- Arteries, new mode of repressing hemorrhage from, 133.  
red appearance of their coats, 134.
- Association, British, 10th meeting of, announced at Glasgow, 406.  
Circular of to scientific men, 406.
- Atmospheric distribution, inequalities in, 265.
- Atoms of organic compounds, how related, 121.
- Aurora Borealis of Sept. 3d, 260, 376.  
and sunset at Rochester, 146, 147.

## B.

- Bache, Prof. A. D., on American Meteorology, 95.  
on the rapid corrosion of a chain cable, 177.
- Barium, strontium and calcium, how prepared, 115.
- Barometer, new mode of filling, 109.

- Basilosaurus of Harlan, geognostic position of, 381.
- Beaumontite, a new mineral species described, 198.
- Binney, report on birds, and fish, and reptiles of Massachusetts, 393.
- Birds, habits of certain species, 392.
- Blasting rocks by galvanic and electrical excitement, 33, 188.
- Booth, J. C., analysis of chrome iron, 243.
- Bonnycastle, Prof. C., on the depth of the sea as determined by echo, 161.
- Boston Society of Natural History, abstract of their proceedings from June 5 to Sept. 4, 1839, 193; from Oct. 2 to Dec. 18, 1839, 391.
- Botany and Zoology, section A, of British Association Proceedings, 128.
- Boyé, Martin H., new compound of platinum, 186.
- Brain, manual mode of examination, 133.
- Brewer on eggs of Chicadee, 195.  
on the habits of certain birds, 392.
- Bridges, Ithiel Town's improvements in, 276.
- Bridge across James River, 286.
- Brinckerhoff, minerals and shells to N. Y. Lyceum Natural History, 198.
- British Association, 9th meeting, abstract of proceedings, 93.
- British Association for Advancement of Science, 10th meeting of announced, 406.  
R. I. Murchison's letter to Prof. Silliman on, 406.  
office bearers of, 10th meeting, 407.  
Antarctic Expedition, 204.  
Channel, water from analyzed, 12.
- Burmah, earthquakes in, 385.

## C.

- Calcium obtained by Dr. Hare, 181, 189.
- Calculus treated by lithotripsy, 134.
- Calorimeter, a new one by Dr. Ure, 109.
- Calymene Bufo, inferior surface of, 410.
- Canton, China, meteorological observations made at, 265, 301.
- Capillary action, a new development of, 180.
- Carburets, crystallization of, 118.
- Carcharias obscurus, 195.

- Carbonic acid condenser, 297.  
 removed from wells, 206.
- Cataract, capsular, removal of, 133.
- Catlin, Mr. G., his journey to Côteau des Prairies, 138.
- Catoptric examination of the eye, 187.
- Cavities in chalk filled with gravel, 122.
- Chain cable, corrosion of, 176.
- Charcoal burning, deadly effects of, 134.
- Chemistry, binary theory of bodies, 115.  
 Law of substitutions, 114.
- Chemistry and mineralogy, section B, British Association, 114.  
 Webster's Manual of reviewed, 329.
- Chinese writing, 398.
- Circular of Brit. Association, 10th meeting, 407.
- Chromic iron ore analyzed, 243.
- Classification of rocks, letter of R. I. Murchison on, 408.
- Ciliograda of British seas, 129.
- Combe, G., lectures on phrenology, 390.
- Comet, a new one seen by Encke, 378.  
 tails, 35.
- Conductors, electrical, effects of introducing substances between, 222.
- Conrad, T. A., on Caradoc sandstone, 87.  
 Ludlow Rocks, 89.  
 observations on plastic clay, 91.  
 new species of Gnathodon, 92.  
 on Silurian system, 86, 89.  
 Wenlock shale and limestone, 88.
- Cotta, Hr. Dr., on footmarks in sandstone, 255.
- Cotton of commerce, cultivation of, 131.
- Côteau des Prairies, Catlin's acc't of, 138.
- Crania Americana reviewed, 341.
- Crust of globe, minimum thickness of, 106.
- Crystals, models of, in mica, 187.
- Cuba, chromic iron of, analyzed, 243.
- Current, electrical, induced on itself, 212.  
 of third, fourth, and fifth order, 226.
- Currents, secondary, how produced, 215.  
 at a distance, 219.
- D.
- Delphinula, new species, 193.
- Dewey, Prof. C.; on aurora and sunsets, 146.
- Dodder, common, 131.
- Donation of books to American Philological Society, Philadelphia, 156.
- Du Ponceau on Chinese writing, 400.
- Dyke of trap in Cumberland, 127.
- E.
- Earthquakes, severe, in Burmah, 385.
- Earth's temperature in deep mines, 108.  
 at different depths near Edinburgh, by Prof. Forbes, 108.
- Earthen ware made of millstone grit, 127.
- Eaton's Manual of Botany, 378.
- Eclipse, solar, of May 14 and 15, 1836, 191.  
 of Sept. 18, 1838, 158, 163, 171, 174.
- Ehrenberg, M., discoveries in fossil infusorial animalcules, 405.
- Electricity, experimental researches in, by M. Faraday, 378.
- Electricity and magnetism, contributions to, 170, 209.  
 ordinary, induced currents produced from, 232.
- Electrical currents in metalliferous veins, 120.
- Electro-dynamic induction, 209.
- Elephant Shark, 197.
- Elm tree moth, parasite on its eggs, 385.
- Elvella esculenta, 194.
- Emerson, G. B., on Lycopodon giganteum, 391.
- Emys Blandingii, 195.
- Encke's letter to Prof. Bache, 184.
- Europe, geological map of, 126.
- Exchanges of shells and insects, 205.
- Exploring Expedition, U. S., progress of, 387.
- Eye, catoptric examination of, 190.
- F.
- Faraday, M., a letter to him from Dr. Hare, 1.  
 Experimental researches in electricity, 378.
- Feet of animals, impressions of, 127.
- Fermentation, experiments on, 120.
- Fish fossil of Agassiz, last No. on, 121.  
 from Manchester, Eng., 125.  
 how studied in confinement, 132.  
 reptiles, and birds of Mass., 379.  
 reports on, examined by Mr. Binney, 393.  
 fifteen species from Ohio named, 392.  
 two of Ray, 396.
- Flora of England, additions to, 133.  
 fossil, of Great Britain, 127.
- Forbes on mica for polarizing light, 101.
- Formulæ relative to comets, 160.
- G.
- Galvanic battery used in blasting, 33.
- Geom., practical remarks on, 61.
- Geology and Geography in British Association report, 121.
- Germany, rocks of, examined, 126.
- Gibbs, J. W., on Gissi vocabulary, 41.  
 on the Vai or Vey vocabulary, 43.  
 on the Mendi vocabulary, 45.
- Gnathodon, new species of, 93.
- Gould, A. A., new species of Delphinula, 193.  
 on thirteen species of shells, 196.

Gould, A. A., on Californian shells, 396.  
 Graham, Prof., theory of voltaic circle, 117.  
 Gray, on several North American Orchidaceæ, 306.  
 Green, H., on vegetable organography, &c., 49.  
 Green, Prof. J., on inferior surface of Calymene Bufo, 410.  
 Griffith, Mrs. M., on halo or fringe, 22.  
 Grove, W. R., on small galvanic battery, 116.  
 Gutzlaff, Rev. C., letter on Chinese writing, to Mr. Du Ponceau, 398.  
 Gymnotus electricus dissected, 197.

## H.

Hamilton, on Katakakaumene, 206.  
 Halo or fringe surrounding bodies, 22.  
 Hare, Dr. Robert, on barium, strontium, and calcium, 115.  
 on blasting rocks by galvanism, 188.  
 his compound blowpipe, 173.  
 on calcium, 181.  
 letter to Faraday, 1.  
 large mass of platinum melted, 155, 163.  
 notice of tornadoes, 73, 400.  
 decomposition and recombination of water, 336.  
 Hayes, A. A., on the action of metallic tin on solutions of muriate of tin, 408.  
 on new minerals, 410.  
 Hays, Dr., on catoptric examination of the eye, 188.  
 Henry, Prof. J., contributions to electricity and magnetism, 170, 209, 404.  
 new capillary action, 180.  
 currents produced from ordinary electricity, 232.  
 lateral discharge of electricity, 154.  
 Herapath, J., Railway Magazine, &c. 205.  
 Herrick, E. C., aurora borealis, 260.  
 meteoric observations, November and December, 1839, 377.  
 parasite of elm tree moth, 385.  
 shooting stars of Aug. 10 and 11, 1839, as seen in Canton, China, 301.  
 shooting stars of Aug. 9 and 10, 203.  
 Herschel on dissevered rays of light, 110.  
 Hildreth, S. P., Meteorological Journal, 273.  
 Hubbard, Prof. O. P., on removal of carbonic acid from wells, 206.  
 Human race, extinction of, 130.  
 Humbert, Jonas, Jr., compound electro-magnet, 205.

## I.

Ichthyosaurus at Strensham, Eng., 126.  
 Idocrase, composition of, 120.

Indigestion, alkaline, 134.  
 Induced currents of the third, fourth, and fifth order, 226.  
 from ordinary electricity, 232.  
 Induction, electro-dynamic, 209.  
 conditions which influence, 212.  
 of secondary currents, 215.  
 at a distance, 219.  
 Infusoria, analysis of M. Ehrenberg's discoveries, 405.  
 Iron, steel and malleable iron, how differing in composition, 121.  
 Ivory deprived of earthy matter, 134.

## J.

Jackson, Dr. C. T., analysis of serpentine marble from Vermont, 198.  
 Jackson, Dr. C. T., analysis of new mineral, 198.  
 letter to him on the Côteau des Prairies, 138.  
 his oxy-alcohol lamp, 335.  
 Japanese and English vocabulary, 163.  
 Johnson, Prof., analysis of anthracite and iron ore, 382.  
 Johnston, Prof. J., carbonic acid solidifying apparatus, 297.  
 Jones, Wm. G., on a new compensating pendulum, 274.

## K.

Katakakaumene described, 207.  
 Kirtland, Dr., description of fifteen new species of fish, 392.  
 Kupffer, A. T., observations météorologiques, 380.

## L.

Lacaille's Cælum Australe Stelliferum, reduction of stars in, 94.  
 Lamp of safety, by Baron Mesnil, 115.  
 of Dr. Jackson's, oxy-alcohol, 335.  
 Lardner on resistance of air to rail cars, 136.  
 Larned, Rev. Wm. A., translation of Dr. Cotta's article of footmarks, 255.  
 Lathrop, Prof., theory of the earth, 68.  
 Latitudes of various places, 168.  
 Lea, J., on new species of Melania, 175.  
 M. Carey, analysis of chromic iron, 243.  
 Lead, white, theory of formation of, 119.  
 Lee, A., M. D., letter to him on gems, 61.  
 Letter of Dr. Hare to Mr. Faraday, 1.  
 Letter of John Strang to Prof. Silliman on British Association, 406.  
 Lewenberg, Leon, his telescope, 379.  
 Lightning, effects of, on three of H. B. M. ships, 112.

- Locke, Dr. John, on magnetic dip and intensity in Ohio, 157.
- Longitude, determination of an arc between Armagh and Dublin, 113.  
of City Hall, New York, 113.  
of several places in Michigan, 154.
- Loomis, Prof. E., on magnetic dip and intensity in Ohio, 397.
- M.
- Mackerel shark's intestine, 197.
- Magnetic dip and intensity, mode of determination, 179.  
in Ohio, 157.
- Magnets, best positions of three for mutual action, 96.
- Map, geological, of Cornwall and Devon, 124.
- Mathematics and physics, section A, British Association, report 9th meeting, 94.
- Matter not infinitely divisible, 113.
- Mechanical science, section G, of British Association, report 9th meeting, 136.
- Medical science, section E, British Association, report 9th meeting, 133.
- Medium, resisting theory of, 246.
- Melania Cincinnatiensis, 175.
- Metallic tin, action of on solutions of muriate of tin, 408.
- Metals, galvanization of, 119.
- Meteoric mass, description and analysis of, 250.  
observations in November and December, 1839, 377.
- Meteors of November, 1838, as observed at Philadelphia, and elsewhere, 173, 176, 179.
- Meteorology of elevated regions, 102.  
American, report on, 95.
- Meteorological hourly observations, 95.  
observations made at equinoxes and solstices to be reduced, 95.  
observations at Great Malvern, 102.  
at Plymouth, Eng., 109.  
phenomena at Ghats, W. I., 103.  
Journal, kept at New York for 1838-9, 323.  
at St. Johns, N. B., and Canton, China, 265.  
at Marietta, Ohio, 273.
- Mica used in polarizing light, 101.
- Minerals and shells presented to N. Y. Lyceum Nat. History, by Dr. Brinckerhoff, 198, 201.
- Minerals, new ones mentioned from S. America, 410.
- Mitchell, Wm., on tails of comets, 37.
- Mollusca, pulmoniferous, 131.
- Morgan, K. G., on galvanism in blasting rocks, 33.
- Morse, S. F. B., on the twilight bow, 389.
- Morton, S. G., his *Crania Americana* reviewed, 341.
- Murchison, R. I., letter to Prof. Silliman on British Association, 406.  
letter to Prof. Silliman on classification of rocks, 408.
- Murchison's Silurian system, 86.  
on geological map of Europe, 126.  
on a part of Germany, 126.
- N.
- Natural History Society of Boston, proceedings of, 391.
- Newfoundland, meteorological observations at, 265.
- Nomenclature of the stars revised, 94.
- Nully on formulæ for comets, 160.
- O.
- Observations of magnetic dip and intensity in Ohio, 397.
- Observatory at Cape of Good Hope, 95.  
at Girard College authorized, 398.  
magnetic, their establishment recommended by British Association, 108.
- Observatory, letter from Prof. Encke on, to Prof. Bache, 183.
- Orsted's memoirs on tornadoes, 82.
- Orchis tribe, synonymy of several species, 306.
- Osler, Mr. F., on indications of his anemometer, 103.
- P.
- Parasite of the eggs of *Geometra vernata*, 385.
- Parker, P., meteoric observations at Canton, August, 1839, 301.  
Paving with wood, 136.
- Peat bogs, 127.
- Peltier on tornadoes, 401.
- Pendulum, new compensating, 274.  
improved compound, by W. J. Frodsham, 107.
- Perry, Thos. H., on a resisting medium, 246.
- Philosophical (Amer.) Society; proceedings of, 153, 396.
- Photogenic drawing, Talbot's remarks on Daguerre's process, 97.
- Photometer, new, described by Dr. Daubeny, 97.
- Pipe Stone quarry on Côteau des Prairies, 139.
- Phrenology, lectures on, by G. Combe, 390.
- Physick, Dr. P. S., notice of, 155.

- Planorbis, new species, 193.  
 Platinum, new compound of, 186.  
     large quantity melted, 163, 155.  
 Polarized light, oxyhydrogen blowpipe  
 used to exhibit, 102.  
 Polarizing light by mica, 101.  
 Powell, Prof., on interference of light,  
 107.  
     on refractive indices, 107.  
     on wave theory, 108.  
 Prayer in the Mendi language, 48.  
 Problems, dynamical, new mode of solv-  
 ing, 106.  
 Proceedings of Boston Society of Natu-  
 ral History, 396.  
     American Philosophical  
     Society, 153, 396.
- R.
- Redfield, W. C., abstract of meteorologi-  
 cal observations made at Canton and  
 St. Johns, 265.  
     abstract of meteorological  
     register kept at New York, 1838 and  
     1839, 323.  
 Refractive indices, 107.  
 Resistance of the air to railway trains,  
 136.  
 Resisting medium, probable effects of,  
 246.  
 Rocks, classification of, 408.  
 Rogers, Wm. B., Prof., on the tertiary of  
 Virginia, 183.  
 Ruminants, follicular dentition in, 129.  
 Rutland county, Eng., statistics of, 135.
- S.
- Salts, haloid, existing in solution, 118.  
 Schweitzer, G., analysis of sea water, 12.  
 Sea, depth of, determined, 161.  
 Secular variations of the magnetic needle  
 in connection with theory of the earth,  
 68.  
 Scirpus sylvaticus, 195.  
 Serpentine marble, analysis of, 198.  
 Shells and minerals presented to N. Y.  
 Lyceum by Dr. Brinckerhoff, 198.  
 Silk, grown at Nottingham, Eng., 130.  
 Silurian system of America, 86.  
 Skulls of Aboriginal Americans, 341.  
 Small pox is on the increase, 134.  
     power of new virus, 134.  
 Spectrum, solar, new observations on, by  
 Sir J. Herschel, 110.  
 Speculum of plate glass, 107.  
 Stars, nomenclature of, to be revised, 94.  
     reduction of those in the Cælum  
     Australe, 94.  
     reduction of those in the Histoire  
     Celeste, 94.  
     extension of the Astronomical So-  
     ciety's Catalogue, 95.
- Stars, shooting, of Aug. 9 and 10, 1839,  
 203.  
     seen at Canton, Aug. 10  
     and 11, 1839, 301.  
 Statistics of agriculture, 135.  
     criminal, of England and Wales,  
     135.  
 Steam, specific gravity of, at different  
 temperatures, 137.  
 Steam Navigation Journal, 205.  
 Steam ship Savannah, her log book, 155.  
 Stevelly, on cloud, wind, and rain, 105.  
     on filling barometers, 109.  
 Stomach, existence of muriatic acid in  
 during digestion, 119.  
 Storer, on Carcharias obscurus, 195.  
     Emys Blandingii, 195.  
     fishes and reptiles of Massa-  
     chusetts, 379.  
     Squalus elephas, 197.  
     fifteen species of Ohio fishes,  
     392.  
     two species of Ray, described  
     by, 396.  
 Strang, John, letter to Prof. Silliman, 407.  
 Syngnathus, taken near Boston, 195.  
 Synonymy of the Orchis tribe, 306.
- T.
- Taber, Thomas, practical remarks on  
 gems, 61.  
 Tails of comets, 35.  
 Talbot, on Daguerre's photogenic pro-  
 cess, 97.  
 Teeth of mammalia in Suffolk, England,  
 described by Lyell, 124.  
     fossil, examined by Owen, 127.  
     microscopic structure of, 134.  
 Tertiary of Virginia, by Prof. Wm. B.  
 Rogers, 183.  
 Teschemacher, J. E., on Elvella esculen-  
 ta, 194.  
     minerals found  
     at Milk row, 194.  
     plants from Black-  
     stone river, 195.  
     Andromeda ma-  
     riana, 196.  
     fossil coals and  
     madrepores, 197.  
 Theory of the earth in connection with  
 secular magnetic variations, 68.  
 Tin, metallic, action of on muriate of tin,  
 408.  
 Tornados, notices of, by R. Hare, 73.  
     Ersted's memoir on, 82.  
 Tornado at Chatenay, near Paris, 77.  
     Providence, R. I., 74.  
 Town, Ithiel, his improvements in bridg-  
 es, 276.  
 Tracks of animals in variegated sand-  
 stone, 255.  
 Troost, Prof. G., analysis of a meteoric  
 mass, 250.

Tubular cavities in the chalk, 122.

Twilight bow, 389.

Twining, Prof. A. C., on Aurora borealis  
of Sept. 3, 1839, 376.

Tyrian dye, 126.

V.

Vegetable organography and physiology,  
49.

Vegetables, fossil, structure of, 126.

Virus, vaccinae; liable to lose its virtue,  
175.

Vocabulary of Gissi or Kissi language,  
41.

Mendi language, 45.

Vai language, 43.

Voltaic battery of extraordinary power,  
116.

circle, theory of, 117.

W.

Ward, C. J., exchanges of shells, 205.

Water of British Channel analyzed, 12.  
decomposition and recomposition  
of, 336.

Waves, determination of their laws, 100.

Wax tablet used in instructing the blind,  
186.

Webster, Prof. J. W., notice of his Man-  
ual of Chemistry, 329.

Weights, atomic, of elementary bodies,  
119.

Whales, remains of, found at Durham,  
Eng., 130.

Wheat, its growth accelerated, 129.

Wilkes, Lt. C., account of exploring ex-  
pedition, 387.

Woody tissue, formation of, 128.

Wool, new species of, introduced into  
Britain, 132.

Wyman, Dr. J., dissection of mackerel  
shark, 197.

eel, 197. electrical

abstract of proceedings  
of Boston Nat. Hist. Soc., 193, 391.

Z.

Zeuglodon, geognostic position of, 381.

Zoological researches in the Orkneys,  
123.

## APPENDIX.

---

### MANUFACTURE OF PINS.

WE have seen with great satisfaction the beautiful machine for the manufacture of pins invented by Dr. Howe.

Its operation is so like that produced by intelligence directed in the immediate movements by a specific purpose, and furnished with the organs (so to speak) adapted to fulfil its designs, that it perfectly imitates the human fingers, obeying the impulse of the mind.

The production of a perfect pin headed and pointed by one system of movements, is equally surprising and gratifying. The manufacture although of a small article, is also of national importance, and we therefore admit the reasonable statements of Dr. Howe, as an Appendix to this Number,—trusting that the publication may not be without effect upon the minds of those who form our commercial regulations, and determine the success or failure of our domestic manufactures.—*Editors.*

TO THE EDITORS OF THE AMERICAN JOURNAL OF SCIENCE, &c.

*Gentlemen*—Agreeably to your suggestion, I take leave to communicate to you a few of the facts and circumstances connected with the attempt, in which I am engaged, to introduce the manufacture of pins, in our country, by the use of labor-saving machinery.

You are aware that in the manufacture of pins, in Europe, manual labor, for the most part, of the cheapest kind is employed; and, consequently, that any attempt to manufacture them, in this country, by a similar method, must inevitably fail, on account of the comparatively high price of labor here,—unless protected by a high import duty, or a prohibition of the importation of the article. During the war of 1812, when the supply from abroad was in a great measure cut off, pins were sold in this country at greatly enhanced prices.

A friend told me, recently, that he sold pins, at that time—at wholesale—for twelve dollars per pack, (of 12 papers—500 pins each) which is eight or ten times the present price. I believe thorns were very generally substituted for pins, both in the late war and during that of the revolution. According to the most probable estimate I can form from the information I have received, there are manufactured in Great Britain, at least, fifteen tons of pins per week,—about one fifth of which are supposed to be sent to the United States; and there are also larger importations to this country from the Continent. Considering the great quantity and value of pins used in this country—and their importance as an article of general use, and convenience, if not of necessity, it would seem reasonable that encouragement should be given to an attempt to manufacture them; or at least that no obstacle arising out of the past legislation of our government, should be allowed to remain in the way of such an undertaking. But it so happens that under the existing revenue laws of the United States, pins are, not only an unprotected article of manufacture, but to a certain extent, the making of them in this country is *prohibited*; inasmuch as that pins of foreign manufacture, are admitted free of duty; whereas, brass wire of which pins are made, is charged with an import duty of nearly twenty five per cent. It is obvious that the advantage is given to the foreign over the American manufacturer, by this state of our revenue law. Supposing the two to be on an equal footing in all other respects, it is sufficient to enable the former, effectually, to keep or drive the latter out of our markets. And supposing the use of labor-saving machinery should enable us for a time, to compete successfully with the foreigner, notwithstanding the *bounty* thus conferred upon him,—we have no reason to hope that machinery once successfully established here, will not speedily find its way into the hands of our foreign rivals, and be brought to bear upon us to the ruin of our prospects, unless we succeed in getting relief from our own government. A market, so important as that of this country for the article of pins, will not be given up without a struggle, by those who have had the exclusive benefit of it.

We have petitioned Congress, at the two last sessions for relief, without success; but being confident in the justice of our claim, it is our intention to renew our application at the ensuing session.



In reference to this object, my wish to have some notice of the undertaking appear in your well known and influential Journal, arises from a belief that information communicated through such a medium—founded partly on your own observation—would be more readily received and credited, than if communicated directly from parties interested, or conveyed through any ordinary channel. We cannot expect Congress to legislate for our relief, unless members are first convinced that there is some reasonable prospect that with such relief, our enterprise may succeed. We shall petition for a duty to be laid on pins, equivalent to that to which brass wire is now subject. In accordance with such a petition a bill was introduced, by Mr. Adams, from the Committee on Manufactures, at the last session, but it was not acted on in the House.

I believe ours is the first successful attempt to manufacture pins entirely by self-acting machinery. I am aware of other attempts having been previously made, but without success. Since we commenced, another establishment has been started in this country, and I understand is likely to succeed.

We have now three of the larger improved machines in operation, each of which produces about 24,000 pins per day. The intention of the Company is to put up fifty of them (in case we get the relief we seek from Congress,) which will produce about 2,000 packs (of 12 papers each,) per week; and the establishment might afterwards be enlarged, if the business afforded sufficient encouragement. I estimate that twelve persons (men and boys) would be able to keep fifty machines in full operation. But it would require the labor of one hundred or a hundred and fifty individuals, (women and girls,) to shut or paper the pins. At the present time we give the pins out into families to be shuted; we have fifty or sixty hands employed (more or less steadily) in this department, some of whom reside ten miles from the manufactory.

Allow me to express my sincere thanks for the kind and liberal feelings manifested by you towards our infant establishment; and to subscribe myself,

Very respectfully and truly, yours,

JOHN I. HOWE.

Birmingham, (Derby,) Nov. 25, 1839.

**Messrs. NESTLER & MELLE,**

**BOOKSELLERS, HAMBURG, GERMANY.**

IF any of our correspondents and friends wish to procure German Books, from Germany, we would take the liberty of recommending, as suitable agents for this purpose, Messrs. *Nestler & Melle*, as a house desirous of establishing business relations with this country, and as having shown prompt and kind attention to such commissions as we have had occasion to trouble them with.

—EDS. AM. JOUR.

New Haven, Dec. 10, 1839.

ACKNOWLEDGMENTS TO CORRESPONDENTS, FRIENDS  
AND STRANGERS.

*Remarks.*—This method of acknowledgment has been adopted, because it is not always practicable to write letters, where they might be reasonably expected; and still more difficult is it to prepare and insert in this Journal, notices of all the books, pamphlets, &c., which are kindly presented, even in cases, where such notices, critical or commendatory, would be appropriate; for it is often equally impossible to command the time requisite to frame them, or even to read the works; still, judicious remarks, from other hands, would usually find both acceptance and insertion.

In public, it is rarely proper to advert to personal concerns; to excuse, for instance, any apparent neglect of courtesy, by pleading the unintermitting pressure of labor, and the numerous calls of our fellow-men for information, advice, or assistance, in lines of duty, with which they presume us to be acquainted.

The apology, implied in this remark, is drawn from us, that we may not seem inattentive to the civilities of many respectable persons, authors, editors, publishers, and others, both at home and abroad. It is still our endeavor to reply to all letters which appear to require an answer; although, as a substitute, many acknowledgments are made in these pages, which may sometimes be, in part, retrospective.—*Eds.*

SCIENCE.—FOREIGN.

First Annual Report of the Natural History Society of Dublin, Ireland, 1838. From the Society.

An Address delivered at the 7th Annual Meeting of the Geol. Soc. of Dublin; by J. E. Portlock, F. R. S. G. S. Dublin, 1838.

Journal of the Geological Society of Dublin, Vol. I, Part III, 1837. From the Society.

Reports of the Council of the Belfast Natural History Society for 1837, 1838. From the Society.

A Review of Mr. Lyell's Elements of Geology, with observations on the progress of the Huttonian Theory of the Earth. From Dr. Wm. H. Fitton, the Author.

Minutes of Proceedings of the Institution of Civil Engineers, session of 1839. From the Institution.

Tracts on Docks and Commerce, printed between 1793 and 1810, with an Introduction, Memoir and Miscellaneous Pieces; by Wm. Vaughan, Esq., F. R. S. London, 1839. From the Author.

Proceedings of the Geol. Society of London. Nos. 1, 2, 4 to 8, 18 to 22, 28 to 47. From the Council of the Society.

Popular Lectures on Geology; by K. C. Von Leonhard; with Engravings. Translated from the German, by J. G. Morris, A. M., and edited by Prof. F. Hall, M. D. Baltimore, Md., N. Hickman. From the Translators and Publishers.

On the older stratified rocks of North Devon, with remarks by Thomas Weaver, Esq., F. R. S., &c. From the Author.

Experimental Researches in Electricity, series 1 to 14; also 15 series; by Michael Faraday, D. C. L., F. R. S. From the Author.

An Account of Experiments with a constant Voltaic Battery; by Mr. O. V. Walker. London, 1838. From William Sturgeon, Esq.

Experimental and Theoretical Researches in Electricity; first and second Memoirs; by William Sturgeon, Esq. From the Author. London, 1837-38.

Proceedings of the Botanical Society of London, from July, 1836, to Nov. 1838, with plates. London, 1839. From the Society. Also Hist. and objects of the Society, several copies.

Société de Géographie réglement. From W. W. White.

The Lancet. London. Vol. II, No. 15, June, 1839, with a notice of the Mantellian Museum. From Dr. Mantell.

Some account of the Art of Photogenic Drawing; by Henry Fox Talbot, Esq., F. R. S. London, 1839. From the Author.

Transactions of the Meteorological Society of London. 1839, Vol. I. From the Society.

Orchideæ in the collection of Conrad Loddiges & Sons, Hackney, near London. From Prof. C. U. Shepard.

Catalogue of Plants and Shrubs in the Botanical Collection of Loddiges & Sons. From C. U. Shepard.

Catalogue of Mathematical and Optical Instruments, made by John Braham, Bristol, Eng. From the Same.

Outlines of the Science of Magnetism, &c. ; by John Braham, Bristol, Eng. From the Same.

Bristol Institution, 13th Annual Meeting, 1836. From the Institution.

SCIENCE.—DOMESTIC.

Bear Valley Coal Basin Illustrated, (a map,) for the Yale Natural History Society.

Remarks on Mr. Espy's Theory of Centripetal Storms ; by and from W. C. Redfield. Also, a copy for the Yale Nat. Hist. Soc.

Lyell's Elements of Geology ; 1st American Edition. From the Publishers, Kay & Brothers, Phil.

Descriptive Catalogue of North American Insects belonging to the Linnæan Genus SPHINX, in the Cabinet of T. W. Harris, M. D., Librarian of Harvard University. From the Author ;—two copies, one for the Library of the Yale Nat. Hist. Soc., and the other for the Library of Yale College.

Boston Journal of Natural History ; containing papers and communications read before the Boston Society of Natural History, Vol. II, Nos. 3 and 4. Boston, 1839. From the Society.

Reports on the Fishes, Birds and Reptiles of Massachusetts ; by the Commissioners on the Zoological and Botanical Survey of the State. Boston, 1839. From D. Humphreys Storer, M. D., one of the Commissioners.

American Almanac for 1840. From its Conductor, J. E. Worcester, Esq.

An Address on the Utility of Astronomy, delivered before the Young Men's Society, Lynchburg, Va.

A Treatise on the Evolution of Powers, Simple and Mixed ; by Jacob S. Davis, Teacher. From the Author.

Report of the Committee on the Solar Eclipse of May 14 and 15, 1836. Read July 19, 1839, before the Am. Phil. Soc., Phil. By and from Sears C. Walker, Esq.

Animal Mechanism and Physiology ; by John Griscom, M. D. From the Author.

## MISCELLANEOUS.—FOREIGN.

The Publishers' Circular. London, several parts. Nos. 47, 49, 50. Sept. and Oct. 1839. From Wiley & Putnam.

Bible Stories from the Old and New Testament. From the Author, Rev. Samuel Wood. London, 1832.

Meeting of the British Association at Newcastle. Report of the Local Secretaries; by Prof. J. F. W. Johnston. From the Author.

The Meteorologist and Almanac for 1839. London; by J. W. Limmonite. From Mr. W. W. White.

Bent's Monthly Literary Advertiser. London, August 10, 1839. Nos. 417 and 419. Oct. 10, 1839.

## MISCELLANEOUS.—DOMESTIC.

Address of S. P. Hildreth, M. D., before the Medical Convention of Ohio. Cleveland, May, 1839.

Twenty-third Annual Report of the American Bible Society. New York, 1839. From the Society.

Laws of the University of Ga.

Proceedings of the Session of Broadway Tabernacle against Lewis Tappan. New York, 1839.

A Centurial Sermon, delivered March 29, 1839; by Rev. Thomas P. Davies, late of Green's Farms. New Haven, 1839. From Mr. Davies.

The Tusculan Questions of Cicero, in five books, 8vo. Boston, 1839. Translated by G. A. Otis, Esq. From the Translator.

Memoir of Nathaniel Bowditch; (*Mécanique Céleste*) by his son, N. I. Bowditch, Esq. Boston, 1839. From the Biographer. Also a copy for Yale Coll. Library.

Pres. Clap's Defence of the Doctrines of the New England Churches.

Prospectus of the Faculty of Physic of the University of Maryland, for the Session of 1839-40.

A Catalogue of the Officers and Students of Dartmouth College, for 1839-40. From Prof. O. P. Hubbard.

Autikon Botanikon; by and from C. S. Rafinesque.

Improvements in Universities and Colleges, and Ancient Monuments of the United States; by C. S. Rafinesque. Philadelphia, 1839. From the Author.

A Catalogue of English Books imported by Wiley & Putnam. Lond. and N. Y. From W. & P.

Report of the Committee appointed to enquire into the condition of the New Haven Burying Ground, and propose a plan for improvement. New Haven, 1839. From A. N. Skinner, Esq.

Exposition of the plan and objects of the Greenwood Cemetery, an incorporated trust, chartered by the Legislature of New York. New York, 1839.

Catalogus Universitatis Harvardianæ, MDCCLXXXIX. From J. E. Worcester, Esq.

Report of a Committee to enquire into the State of Prisons in Fairfield County. From Roger M. Sherman, Esq.

Report of the Executive Committee of the American Temperance Union.

Annual Circular of the Univ. State of N. Y. College of Physicians and Surgeons. From Dr. Torrey.

A Discourse by Rev. John Noyes, at Norfield, May 29, 1836, at the close of the 50th year of his Ministry.

Dennis' Silk Manual, in 3 parts. R. I., 1839. By J. Dennis Jr.

A Discourse on the Federative System of the United States; by Prof. B. Tucker, of William and Mary's College. Richmond, 1839.

An Address delivered before the Philomathian Society, of Mount St. Mary's College, Emmetsburg, Va., by E. Lynch, Esq.

An Address before the Eumenean and Philanthropic Societies of Davidson College, N. C., by Rev. P. I. Sparrord, A. M. Raleigh, 1839.

Catalogue of Historical, Theological and Embellished Books sold at auction in N. Y., Oct. 18, 1839; by and from Bangs, Richards & Platt.

Poems by William Thompson Bacon. New Haven, B. & W. Noyes. From the Author.

Annual Report of the Trustees and Visitors of the Common Schools of Cincinnati, from E. P. Langdon, Esq.

#### NEWSPAPERS.—FOREIGN.

The Liverpool Journal of Oct. 12th, containing an account of a new mode of transferring and copying copper-plate and other Engravings by Voltaic agency.

Port of Spain Gazette, with a notice of Yale Coll. Med. Institution. July 5, 1839.

The Athenæum Journal, Nos. 619, 620 and 621, for Sept. 7th, 14th and 21st, containing Reports of the recent Meeting of the British Association. From Rev. S. Wood, Canterbury, England.

NEWSPAPERS.—DOMESTIC.

Weekly True American. New Orleans. Several Nos.

Troy Weekly Post. Aug. '39—Economy of Fuel.

Youth's Companion. Boston, April, 1839. Two Nos.

Miner's Journal, and Pottsville General Advertiser. Sat. Oct. 26, 1839.

Louisville Price Current of Sept. 28, 1839, with Advt. of Louisville Med. School.

Chicago American of Sept. 13, 1839, with Notice, by Mr. T. Bassnett, of the Aurora Borealis seen at Ottawa, Sept 3d. From Mr. B.

New York Journal of Commerce, Sept. 2d, 1839.

Philadelphia Public Ledger of several dates.

Litchfield Enquirer, Sept. 12, 1839. Account of Meteors on the 10th of August.

Hartford Daily Courant of Aug. 29, 1839, with a Table of the Time of Flowering of various Plants in Indiana.

Iowa Territorial Gazette of Aug. 17, 1839.

Le Courier des Etats-Unis Semdi 21 Septembre, 1839.



ACKNOWLEDGMENTS TO CORRESPONDENTS, FRIENDS  
AND STRANGERS.

*Remarks.*—This method of acknowledgment has been adopted, because it is not always practicable to write letters, where they might be reasonably expected; and still more difficult is it to prepare and insert in this Journal, notices of all the books, pamphlets, &c., which are kindly presented, even in cases, where such notices, critical or commendatory, would be appropriate; for it is often equally impossible to command the time requisite to frame them, or even to read the works; still, judicious remarks, from other hands, would usually find both acceptance and insertion.

In public, it is rarely proper to advert to personal concerns; to excuse, for instance, any apparent neglect of courtesy, by pleading the unintermitting pressure of labor, and the numerous calls of our fellow-men for information, advice, or assistance, in lines of duty, with which they presume us to be acquainted.

The apology, implied in this remark, is drawn from us, that we may not seem inattentive to the civilities of many respectable persons, authors, editors, publishers, and others, both at home and abroad. It is still our endeavor to reply to all letters which appear to require an answer; although, as a substitute, many acknowledgments are made in these pages, which may sometimes be, in part, retrospective.—*Eds.*

SCIENCE.—FOREIGN.

Transactions of the Royal Society of Edinburgh, Vol. XIV, pt. 1. 4to. Edin. 1839. From the Society.

Proceedings of the Royal Society of Edinburgh, Nos. 13, 14, 15. 8vo. 1838-9. From the Society.

Astronomische Nachrichten, No. 385. From Counsellor Schumacher of Altona, through Messrs. Nestler & Melle, Hamburg, with numerous prospectuses, &c., of German works.

Annalen der Physik und Chemie: herausgegeben zu Berlin von J. C. Poggendorff. 1838, 12 Nos., and 1839, Nos. 1 to 7 inclus. Leipzig. 8vo. From the Editor, in exchange.

Arsberättelse om Framstegen i Fysik och Kemi, afgifven den 31 Mars, 1837, af Jac. Berzelius, K. V. Acad. Sec. Stockholm, 1837. 8vo.

Arsberättelse om Botaniska Arbeten och Upptäckter för år 1836, afgifven den 31 Mars, 1837, af Joh. Em. Wikström. Stockholm, 1838. 8vo.

Arsberättelse om Technologiens framsteg, afgifven den 31 Mars, 1837, af G. E. Pasch. Stockholm, 1837. 8vo.

Kongl. Vetenskaps-Academiens Handlingar för år 1837. Stockholm, 1838. 8vo. These four last from M. Berzelius.

Neues Jahrbuch für Mineralogie, Geognosie, Geologie und Petrefaktenkunde, herausgegeben von Leonhard and Bronn. Stuttgart, 1839. Jahrgang. From the Editors.

Society for the encouragement of Arts, Manufactures, and Commerce premiums for 1838-39, 1839-40. From the Society.

Proceedings of the Scientific Society of London; embracing communications and papers read from November, 1838, to June, 1839. Part of Vol. I. 8vo. pp. 38. From the Society.

Regulations and Bye-Laws of the Scientific Society of London. 8vo. pp. 8. From the Society.

Petrifactions recueillies en Amérique par M. Alexandre de Humboldt, et par M. Chas. Degenhardt, decrites par Léopold de Buch. Berlin, 1839. Elephant folio, with two tables of plates. Twenty copies received from the Author, for distribution among scientific bodies in the United States.

On the Tubular Cavities filled with gravel and sand, called Sand-pipes, in the Chalk near Norwich, Eng. By and from Chas. Lyell, Esq.

Proceedings of the Geological Society, Lond. Nos. 63 and 64.

#### SCIENCE.—DOMESTIC.

Crania Americana, or a comparative view of the skulls of various Aboriginal Nations of North and South America: by S. G. Morton M. D., &c.; with 73 plates. folio, Philad., 1839. From the Author.

A Treatise on Malignant Pustule or Charbon. By and from Prof. Wm. M. Carpenter, M. D., Jackson College, La.

Consumption curable, and the manner in which Nature as well as remedial Art operates in effecting a healing process in cases of Consumption, &c. ; by Francis H. Ramadge, M. D. First American, from the third London edition. 8vo.

Prospectus and Engineer's Report relating to the city of Cairo, incorporated by the State of Illinois. St. Louis, 1839. From Wm. Strickland, Esq., Philad.

The Maryland Medical and Surgical Journal, and Official Organ of the Medical Department of the Army and Navy of the United States. Vol. I, No. 1, pp. 136. Baltimore.

A Monograph of the Limniades and other Fresh Water Univalve Shells of North America. By S. S. Haldeman, M. A. N. S. Specimen No. Philad. From the Author.

The Electro-Magnet and Mechanics' Intelligencer. Published by Thomas Davenport, and *printed on a Press propelled by Electro-Magnetism*. New York, Jan. 25, 1840. Vol. I, No. 2. From the Editor.

On the Origin and Progress of Galvanism or Voltaic Electricity. By Robert Hare, M. D. 8vo., pp. 80. One for B. Silliman, Jun. From the Author.

Notes on the *Locusta Septentrionalis decem-septima*. By Nathaniel Potter, M. D., Prof. of Theory and Practice of Medicine, Univ. Md. Baltimore. 8vo. pp. 27, with a plate. From the Author.

MISCELLANEOUS.—FOREIGN—BOOKS AND NEWSPAPERS.

La Boisa, Matamoros, Nov. 1, 1839. From Mr. S. F. Plimpton.

La Société Archéologique d'Athènes ; Doings of the third session of the Archæological Society of Athens, with the discourse of Mr. I. Rizo Nerulos, President of the Society, and a list of the members. French and modern Greek. 18mo. pp. 45. Athens, 1839. From G. A. Perdicaris, Esq.

Poems and Translations ; including the first four books of Ovid's *Fasti*, etc. By John Taylor, Esq. Liverpool, 1839. R. 8vo. For Yale College Library.

Catalogue of Old Books for 1839, for sale by Longman & Co. London. 8vo. From Wiley & Putnam, N. Y.

## NEWSPAPERS.—DOMESTIC.

Journal of Commerce, Nov. 21. From G. S. Silliman.

Marietta Intelligencer, Nov. 7, with Met. Reg. From Dr. Hildreth.

Peru Gazette, Indiana, Nov. 30 and Dec. 7, 1839. With a notice of the climate of Indiana. From H. Waldo.

Oneida Whig, Utica, N. Y., Dec. 17, 1839, on the tides in different latitudes, and on the Gulf Stream.

Iowa Territorial Gazette and Burlington Advertiser. Nov. 9, 1839, and Jan. 18, 1840, containing the Governor's Message. From W. S. Scarborough.

New York Gazette and General Advertiser, Feb. 14, 1840, with a notice of this Journal. From B. D. S., Esq.

Boston Weekly Magazine; by D. H. Ela and J. B. Hall, Vol. II, No. 25, with notice of Catlin's Journey to Coteau des Prairies.

Lancaster Intelligencer and Journal, Phil., Feb. 18, 1840, with notice of Buckingham's Lectures.

Republican Standard, Bridgeport, Ct., Feb. 12 and 16, Nos. 27 and 28, with Nos. 16 and 17, on Natural History. By and from Rev. James H. Linsley.

## MISCELLANEOUS.—DOMESTIC.

Catalogue of N. Y. Theological Seminary. Jan., 1840. From Mr. C. S. Lyman.

Address before the American Whig and Cliosophic Societies of the College of New Jersey, Sept. 24, 1839. By Aaron O. Dayton, Esq. From E. W.

Remarks upon Mr. Binney's letter of Jan. 3, 1840, to the President of the Councils of Philad. By the writer of the letter. 8vo.

Fifty third Semi-annual Report of the Council of the American Antiquarian Society, May 29, 1839. 8vo. Worcester, Mass.

Catalogue of the Western Reserve College, Hudson, Ohio, 1839-40. From Prof. S. St. John. 2 copies.

Annual Address to candidates for Degrees and Licenses in the Medical Institution of Yale College, January 21, 1840. By D. T. Brainard, M. D. 8vo. New Haven.

A Visit to Thirteen Asylums for the Insane in Europe, with Statistics; by Pliny Earle, M. D. Philad., 1839. From the Author.

Extracts from the Correspondence of the Amer. Bible Society.  
No. 33, Jan., 1840.

Catalogue of rare, curious, and valuable Books, &c., to be sold  
at auction in N. Y. by Bangs & Co.

"The duty of the educated young men of this country." An  
Address by the Rev. J. Sparrow, A. M., of Davidson College, N.  
C. Raleigh, N. C. From the Author.

Southern Cabinet of Agriculture, Horticulture, &c., edited by J.  
D. Legare. Vol. I, Nos. 1 and 2, January, 1840. Charleston,  
S. C. From the Editor.

Steam Engines. A letter from the Secretary of the Treasury,  
being Doc. No. 21, 25th Congress, 3d session. From Hon. Wm.  
L. Storrs, M. C.

Supplementary Catalogue of Books belonging to the Mercantile  
Library Association, N. Y. From the Directors, 1840.

The 19th Annual Report of the Mercantile Library Association.

"Growth of the Mind," by Sampson Reed. From the Author.

The culture of the Beet and manufacture of Beet Sugar; by Da-  
vid L. Childs. From H. Colman.

Boston Journal of Natural History, Vol. III, Nos. 1 and 2, 1840.

Fourteenth Annual Report of the Prison Discipline Society.

New York Journal of Medicine and Surgery. No. 2, October,  
1839.

American Railroad Journal. Feb. 1840.

American Journal of the Medical Sciences, February, 1840.

Address on African Colonization. From R. R. Gurley.

Address of the Hon. Judge Buel before the Agricultural and Hor-  
ticultural Societies of New Haven, Sept. 25, 1839.

American Journal of Pharmacy, January, 1840.

Dr. Codman's Election Sermon. From the Author, 1840.

Pacific Steam Navigation.

Address by Mr. Buckingham in defense of his Lectures on Pales-  
tine, against the Criticisms of the Rev. Eli Smith. From the Au-  
thor.

Jewett's Advertiser, January, 1840.

Mr. Gillett's Sermon at the funeral of the Rev. Matthew Noyes.

Catalogue of Books and Stationery, for sale by Richard Griffin,  
& Co.

American Repertory of Arts, Sciences, and Manufactures, &c. Edited by J. J. Mapes, Prof. Chem., etc. 8vo. New York. Nos. 1 and 2.

Memoirs of the most Eminent Mechanics ; also, lives of distinguished European Mechanics ; together with a collection of Anecdotes, Descriptions, etc., relating to the Mechanic Arts ; by Henry Howe. New York. 12mo. pp. 482. 1840. From the Author.

Supreme Court of the United States. S. Bartlett Stone *ads.* The United States of America. Argument for Defendant, by Mr. G. Sullivan. New York. 8vo. pp. 21.

Catalogue of the Officers and Students in Union College, 1839-40. From Jno. Pearson.

The Mercy of God—a Centurial Sermon on the Revival of Religion, A. D. 1740. Inscribed to the memory of the Rev. Nathan Strong, D. D. ; by Thomas Williams. From the Author.

The Domestic Chaplain ; by Thomas Williams. 12mo. Hartford. From the Author.

Constitution and By-Laws of the American Statistical Association, with a list of the Officers, Fellows, and Members, and an Address. Boston. From the Association.

Proceedings of the Mechanics' and Manufacturers' Convention, held at Middletown, Feb. 27, 1840.

Twenty third Annual Report of the American Colonization Society. January, 1840. Washington City. From F. A. Clark.

Laws and Regulations of Washington College, Lexington, Va., 1839. From Jno. Echols.

Travels in South Eastern Asia, &c. ; by Howard Malcom. 2 vols. 12mo. Boston, 1839. From Messrs. Gould, Kendall & Lincoln.

Speech of Mr. John Davis, of Mass., on the Sub-treasury bill, delivered in the Senate of the U. S. Jan. 23, 1840. From Joseph Trumbull, Esq.

Letter of the Hon. Hugh L. White to the Legislature of Tenn. From the same.

Speech delivered before the Young Men's Democratic Convention at Hartford, Feb. 18, 1840 ; by George Bancroft, Esq.

Portrait of the late Hon. Jesse Buel.

Twenty third Annual Report of the American Education Society. May, 1839. Boston. From the Rev. Dr. Cogswell.

A Letter on Slavery, addressed to Hon. Henry Clay. By a Slaveholder. 12mo.

Circular of Rutgers' Female Institute, N. Y. 1840.

Catalogue of Mercantile Library Association, New York, 1840. From the Association.

Seventh Annual Report of the State Lunatic Hospital at Worcester, Mass. From Dr. Woodward, the Author and Superintendent.

SPECIMENS.—FOREIGN.

An Ibis from Egyptian Catacombs, from Capt. Boerum, U. S. N. Portion of a tree fern from Tabiti. From J. D. Dana.

Cubical crystals of Metallic Titanium, from Merthyr Tydvill furnace, Eng. From Prof. C. U. Shepard.

Sulphate of Alumina, containing sulphuric acid, phosphoric acid, alumina, and magnesia: a new mineral. From Dr. A. A. Hayes, Roxbury Lab. Mass. Obtained from Iquique, S. A.

Portion of one of the Meteorites which fell in the Cold Bokkeveld, Cape of Good Hope, Oct. 13, 1838. From Isaac Chase, Esq., U. S. Consul, Cape of Good Hope. (See Vol. xxxvii, p. 190, this Journal.)

Magnificent Casts in plaster, of *Ichthyosaurus medius*, and of *I. communis*. From S. Stutchbury, Esq., Curator of Bristol Institution, Eng.

A box of Chalk Fossils from S. E. of England. From Rev. Frederick Bakewell, late of England, now of Pittsburgh.

SPECIMENS.—DOMESTIC.

Galena, from Middletown, Ct. Through Prof. Chas. Hooker.

Arsenical Zinc. From Messrs. Wilcox & Prior.

A specimen of Masonite, a new mineral found in R. I. From Chas. T. Jackson, M. D., Geological Surveyor of the State.

Portion of the meteoric iron from Claiborne, Ala. (Analyzed by Dr. Chas. T. Jackson, Vol. xxxiv, p. 332.) From Dr. Jackson.

Fragments of the meteoric iron from Ashville, Buncombe county, N. C. (Described by Prof. C. U. Shepard, Vol. xxxvi, p. 81.)

A recent specimen of the Sula Bassana of Brisson, (Gannet of Wilson's list.) From Rev. Jas. H. Linsley, for Yale Nat. Hist. Society.

# TELESCOPES

AND OTHER

## PHILOSOPHICAL APPARATUS.

THE subscriber will execute orders for Newtonian, Gregorian, and Herschelian Telescopes, Micrometers, and other Philosophical Instruments. Having had some experience in this business, he is prepared to say, that all articles manufactured by him shall give satisfaction.

He will also make to order Flutes, Clarionets, &c.

All kinds of repairing done at reasonable rates.

Orders addressed to *G. N. Munger*, Orange street, New Haven, Ct., will be faithfully executed.

References, {  
Prof. D. OLMSTED,  
Prof. B. SILLIMAN,  
Mr. E. P. MASON, Y. C.  
Mr. B. SILLIMAN, JR.

March, 1840.



THE  
AMERICAN JOURNAL  
OF  
SCIENCE AND ARTS.

CONDUCTED BY

BENJAMIN SILLIMAN, M. D. LL. D.

Prof. Chem., Min., &c. in Yale Coll.; Cor. Mem. Soc. Arts, Man. and Com., Cor. Mem. Met. Soc., and For. Mem. Geol. Soc., Hon. Mem. Br. and For. Abor. Protec. Soc., and of Scien. Soc., London; Mem. Geol. Soc., and Hon. Mem. Lin. and Statis. Soc., Paris; Mem. Roy. Min. Soc., Dresden; Nat. Hist. Soc., Halle; Hon. Mem. Agric. Soc., Bavaria; Imp. Agric. Soc., Moscow; Nat. Hist. Soc., Belfast, Ire.; Phil. and Lit. Soc., Bristol, Eng.; Hon. Mem. Roy. Sussex Inst., Brighton, Eng.; Cor. Mem. of the Nat. Hist. Soc., and of the Archæological Soc., Athens, Greece; Lit. and Hist. Soc., Quebec; Mem. of various Lit. and Scien. Soc. in the U. States.

AIDED BY

BENJAMIN SILLIMAN, JR., A. B.

Assistant in the department of Chemistry, Mineralogy and Geology in Yale College; Cor. Mem. of the Meteorological Soc., London; Sec. of the Yale Nat. Hist. Soc.; Mem. of the Conn. Acad. of Arts and Sci.; Cor. Mem. of the Lyceum of Natural History, New York; of the Boston Society of Natural History, &c.

VOL. XXXVIII.—No. 1.—JANUARY, 1840-<sup>1839</sup>  
FOR OCTOBER, NOVEMBER, AND DECEMBER, 1839.

NEW HAVEN:

Sold by A. H. MALTBY and B. & W. NOYES.—Philadelphia, CAREY & HART and J. S. LITTELL.—Baltimore, Md., N. HICKMAN.—New York, CARVILL & Co., No. 108 Broadway, and G. S. SILLIMAN, No. 44 William St.—Boston, C. C. LITTLE & Co.—London, JAMES S. HODSON, No. 112 Fleet St., and WILEY & PUTNAM, 35 Paternoster Row.—Paris, J. B. BAILLIÈRE, Libraire, Rue de L'Ecole-de-Médecine, No. 13 bis.—Hamburgh, Messrs. NESTLER & MELLE.

PRINTED BY B. L. HAMLEN.

Published at New Haven, Jan. 1, 1840.



*J. Silliman's Case*

THE  
**AMERICAN JOURNAL**  
OF  
**SCIENCE AND ARTS.**

CONDUCTED BY

**BENJAMIN SILLIMAN, M. D. LL. D.**

Prof. Chem., Min., &c. in Yale Coll.; Cor. Mem. Soc. Arts, Man. and Com., Cor. Mem. Met. Soc., and For. Mem. Geol. Soc., Hon. Mem. Br. and For. Abor. Protec. Soc., and of Scien. Soc., London; Mem. Geol. Soc., and Hon. Mem. Lin. and Statis. Socs., Paris; Mem. Roy. Min. Soc., Dresden; Nat. Hist. Soc., Halle; Hon. Mem. Agric. Soc., Bavaria; Imp. Agric. Soc., Moscow; Nat. Hist. Soc., Belfast, Ire.; Phil. and Lit. Soc., Bristol, Eng.; Hon. Mem. Roy. Sussex Inst., Brighton, Eng.; Cor. Mem. of the Nat. Hist. Soc., and of the Archæological Soc., Athens, Greece; Lit. and Hist. Soc., Quebec; Mem. of various Lit. and Scien. Soc. in the U. States.

AIDED BY

**BENJAMIN SILLIMAN, JR., A. B.**

Assistant in the department of Chemistry, Mineralogy and Geology in Yale College; Cor. Mem. of the Meteorological Soc., London; Sec. of the Yale Nat. Hist. Soc.; Mem. of the Conn. Acad. of Arts and Sci.; Cor. Mem. of the Lyceum of Natural History, New York; of the Boston Society of Natural History, &c.

VOL. XXXVIII.—No. 2.—APRIL, 1840.  
FOR JANUARY, FEBRUARY, AND MARCH, 1840.

NEW HAVEN:

Sold by A. H. MALTBY and B. & W. NOYES.—*Philadelphia*, CAREY & HART and J. S. LITTELL.—*Baltimore, Md.*, N. HICKMAN.—*New York*, CARVILL & Co., No. 108 Broadway, and G. S. SILLIMAN, No. 44 William St.—*Boston*, C. C. LITTLE & Co.—*London*, JAMES S. HODSON, No. 112 Fleet St., and WILEY & PUTNAM, 35 Paternoster Row.—*Paris*, J. B. BAILLIÈRE, Libraire, Rue de L'Ecole-do-Médecine, No. 13 bis.—*Hamburgh*, Messrs. NESTLER & MELLE.

PRINTED BY B. L. HAMLIN.

Published at New Haven, April 6, 1840.









## THE AMERICAN JOURNAL, & C.—AGENTS.

<p><b>MAINE.</b>  <b>SACO,</b> Rufus Nichols.  <b>PORTLAND,</b> Colman, Holden, &amp; Co.  <b>NEW HAMPSHIRE.</b>  <b>Dart. CoH. HANOVER,</b> { Prof. Oliver P. Hubbard.</p> <p><b>MASSACHUSETTS.</b>  <b>NEWBURYPORT,</b> Charles Whipple.  <b>BOSTON,</b> { Otis Broaders &amp; Co.                    { Weeks Jordan &amp; Co.  <b>SALEM,</b> Henry Whipple.  <b>NEW BEDFORD,</b> William C. Taber.  <b>AMHEBST,</b> J. S. &amp; C. Adams.  <b>WORCESTER,</b> { Dorr, Howland, &amp; Co.                    { Clarendon Harris.  <b>LOWELL,</b> D. Bixby.</p> <p><b>RHODE ISLAND.</b>  <b>PROVIDENCE,</b> B. Cranston &amp; Co.</p> <p><b>CONNECTICUT.</b>  <b>HARTFORD,</b> Canfield &amp; Robins.  <b>NORWICH,</b> Thomas Robinson.  <b>MIDDLETOWN,</b> Luke C. Lyman.</p> <p><b>NEW YORK.</b>  <b>NEW YORK,</b> A. T. Goodrich.  <b>WEST POINT,</b> John DeWitt.  <b>NEWBURGH,</b> H. P. Benham.  <b>ALBANY,</b> W. C. Little.  <b>TROY,</b> Elias Gates.  <b>IITACA,</b> D. D. Spencer.  <b>LITTLE FALLS,</b> Edward M. Griffing</p>	<p><b>ROCHESTER,</b> Hoyt, Porter &amp; Co.  <b>BUFFALO,</b> O. G. Steele &amp; Co.</p> <p><b>PENNSYLVANIA.</b>  <b>PITTSBURGH,</b> John J. Kay &amp; Co.</p> <p><b>MARYLAND.</b>  <b>BALTIMORE,</b> N. Hickman.</p> <p><b>DISTRICT OF COLUMBIA.</b>  <b>WASHINGTON,</b> Frank Taylor.</p> <p><b>NORTH CAROLINA.</b>  <b>CHAPEL-HILL,</b> Prof. F. Mitchell.</p> <p><b>SOUTH CAROLINA.</b>  <b>CHARLESTON,</b> { John P. Beile.                    { Ebenezer Thayer.</p> <p><b>VIRGINIA.</b>  <b>RICHMOND,</b> R. I. Smith &amp; Co.  <b>WHEELING,</b> J. Fisher &amp; Sons.  <b>NORFOLK,</b> Richard Worthington.</p> <p><b>OHIO.</b>  <b>COLUMBUS,</b> I. N. Whiting.</p> <p><b>GEORGIA.</b>  <b>SAVANNAH,</b> Wm. T. Williams.  <b>AUGUSTA,</b> Th. I. Wray.  <b>COLUMBUS,</b> J. C. Plant &amp; Co.</p> <p><b>TENNESSEE.</b>  <b>NASHVILLE,</b> Wm. A. Eichbaum.</p> <p><b>ALABAMA.</b>  <b>HUNTSVILLE,</b> Irby &amp; Smith.</p> <p><b>MISSISSIPPI.</b>  <b>GRAND GULF,</b> Wm. M. Smyth.</p> <p><b>CANADA.</b>  <b>QUEBEC,</b> Samuel Neilson.</p>
--	---

### TERMS.

Six dollars per annum; published in four Quarterly numbers, making two volumes a year, of from eight to nine hundred pages for both volumes, which are fully illustrated by plates.

☞ Terms of credit to general agents, six months from the publication of No. 1, of each volume.

*The Editor will draw on the agents, semi-annually, i. e. on the publication of No. 2 of each Vol., payable, six months from the publication of No. 1, in all cases, where payment is not otherwise provided for.*

Remittances may be made through postmasters: sums of \$5 or \$10 are convenient, as they can be credited *in account*.

Money remitted will in all cases be acknowledged by a bill and receipt in the next No. of the Journal or by letter: if no such paper is received, it may be presumed that the remittance has miscarried, (a very rare occurrence.)

*Complete sets, now 37 vols., are furnished at a suitable discount.*

The expense of this Journal being greater, and the patronage less than that of the literary journals, the price is necessarily one dollar more per annum.

### TO CORRESPONDENTS.

This work is most safely and expeditiously transmitted to distant subscribers *by mail*. This No. contains 13½ sheets; postage, under 100 miles, 20½ cents, over 100 miles, 34½ cents.

The titles of communications and of their authors, to be fully given.

When extra copies are desired, the notice should be placed at the head of the MS.

Notice always to be sent of discontinuance, removals and deaths of subscribers.

Return proofs, not to be sealed, or inscribed with any thing except corrections.

Notice to be given when communications are intended, also, for other Journals, or have been already published in them.

373

*J. R. Mayhew*







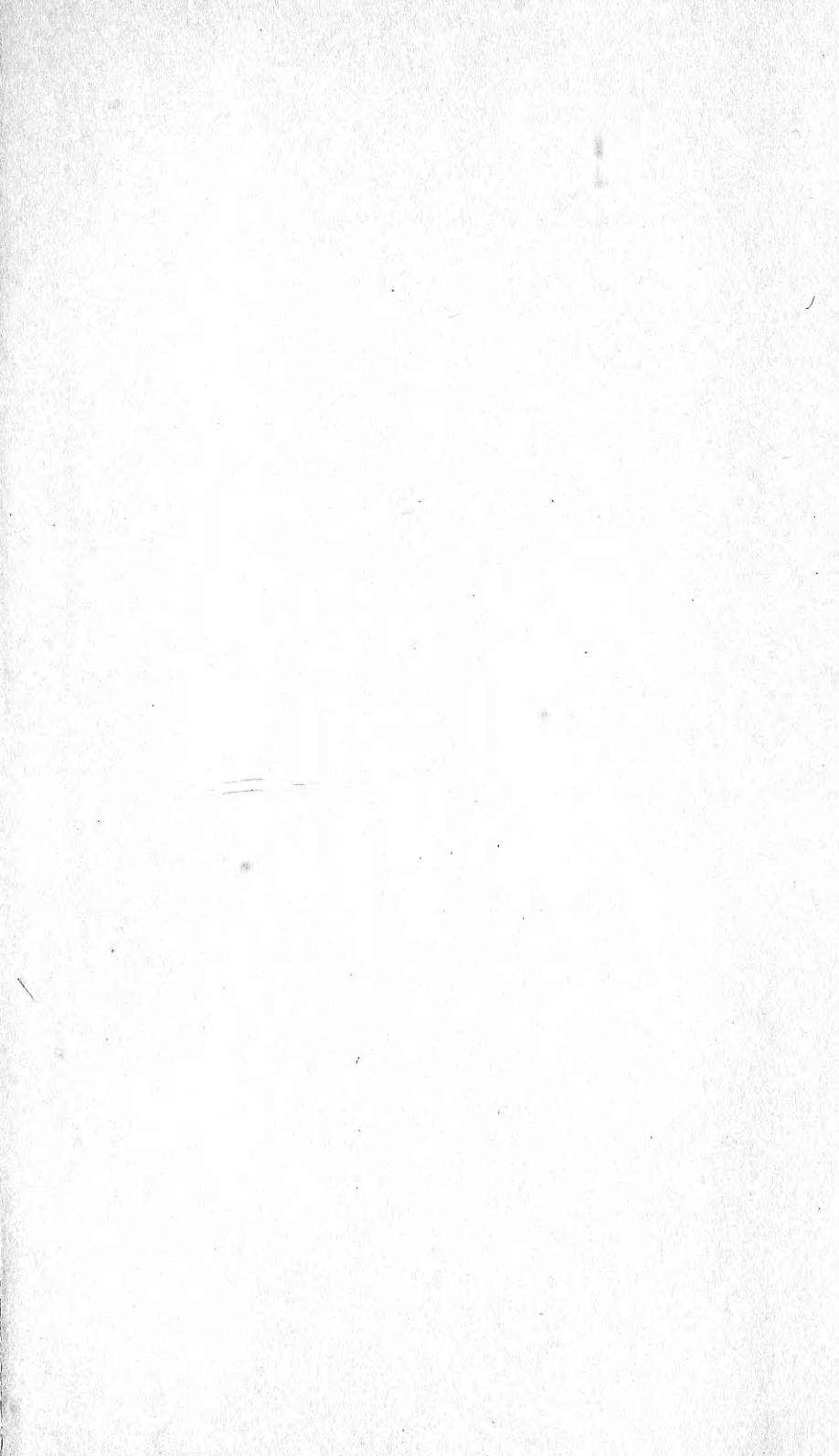

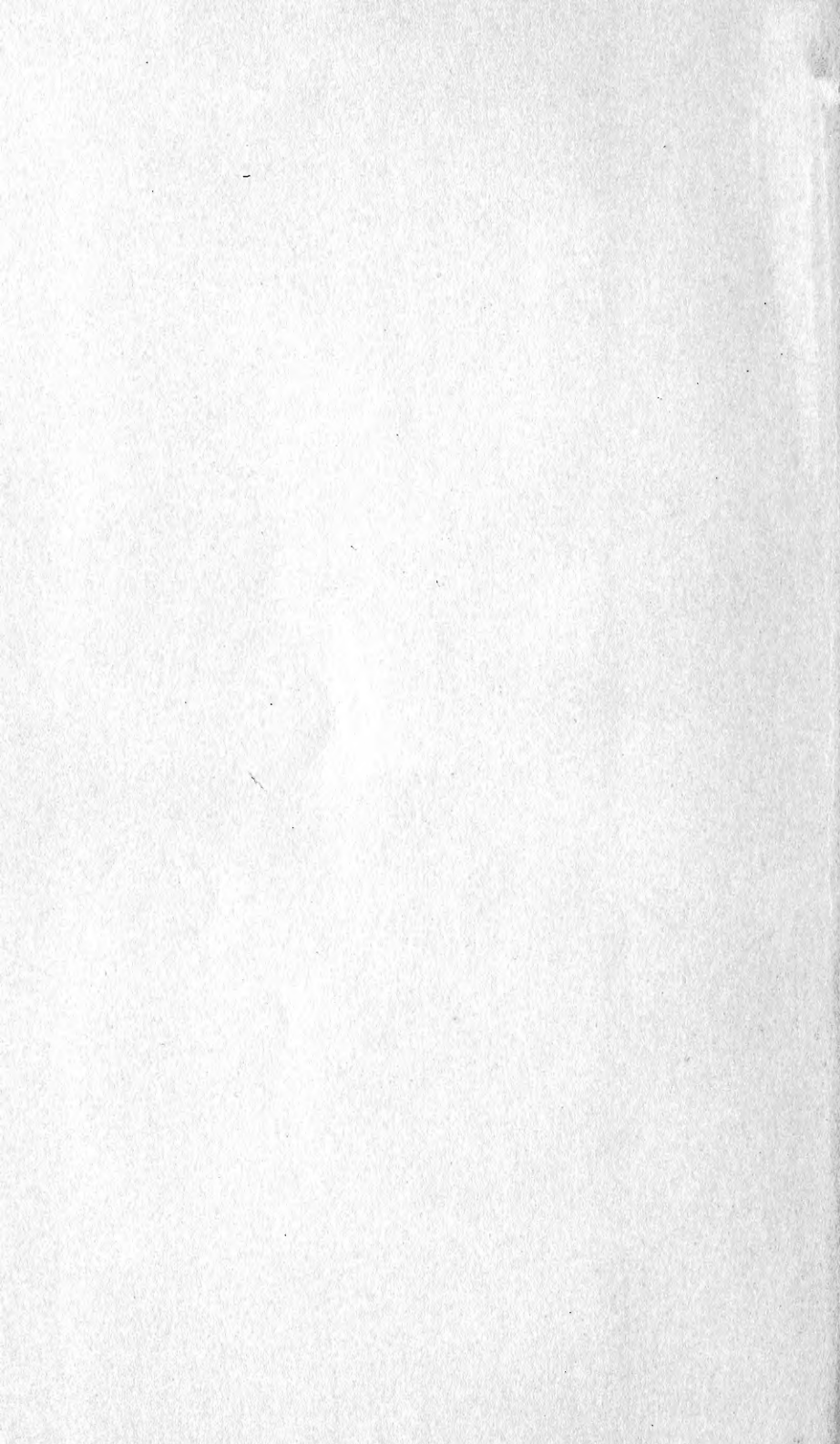

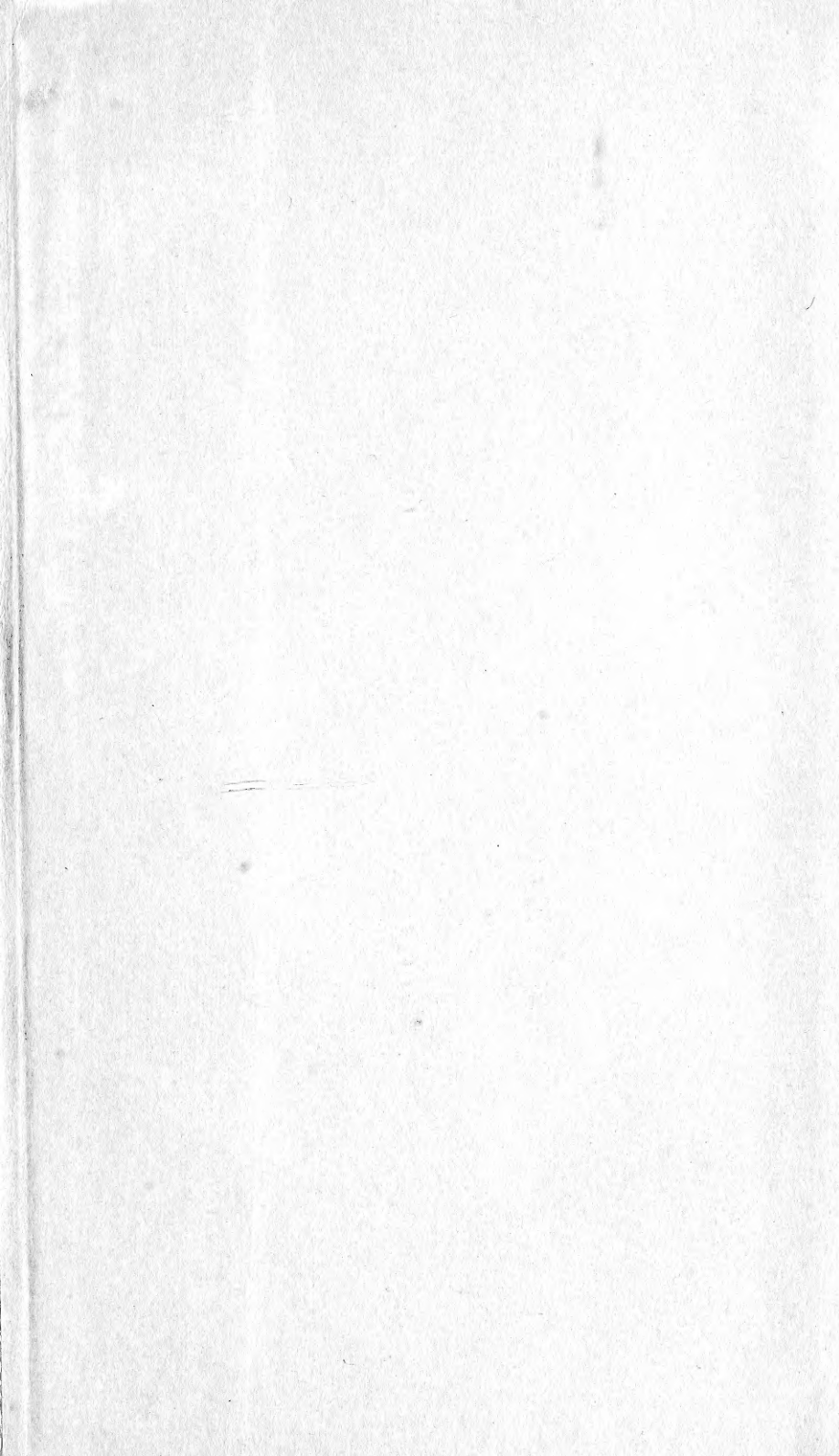

SMITHSONIAN INSTITUTION LIBRARIES



3 9088 01298 4381