





DR. WM. C. KRAUSS.

Biol
A

THE AMERICAN

MONTHLY

MICROSCOPICAL JOURNAL:

(CONTAINING

CONTRIBUTIONS TO BIOLOGY)

VOLUME XVII.

FOR

1896.

FOUNDED IN 1880, BY ROMYN HITCHCOCK, F. R. M. S.
PUBLISHED SINCE 1887, BY CHAS. W. SMILEY,
WASHINGTON, D. C.

611521

7.7.55

QH

201

A35

v.17

LIST OF ILLUSTRATIONS.

Portrait of Dr. Wm. C. Krauss (frontispiece).....	1
New Tube for the Culture of Anaerobic Micro-organisms (1 figure)....	8
New Species from Barbadoes (1 figure).....	25
Infusoria for Identification (1 figure).....	26
Portrait of Prof. A. Clifford Mercer, M. D., F. R. M. S., (frontispiece)...	42
Cicada Septendecim its Mouth Parts and Terminal Armor (5 figures)...	46
New Species from Barbadoes (3 figures).....	58, 59, 60
New Genus from Barbadoes (1 figure).....	61
Portrait of Robert B. Tolles.....	65
Symbiosis, or, Partnerships in Plant-Life (frontispiece).....	74
New Genus from Barbadoes (1 figure).....	97
New Species from Barbadoes (1 figure).....	98
Method of improving Cheap Microscopes (1 figure).....	101
Transverse Section of Squash (Cucurbita) Vine (frontispiece).....	113
New Way of Marking Objectives (1 figure).....	137
New Genus from Barbadoes (1 figure).....	138
Novel Microscope and Mechanical Stage (4 figures).....	145
Senega root, Cross Sections and Structure of <i>Triosteum perfoliatum</i> (frontispiece).....	153
Nature and Manufacture of Bacterial Products (5 figures).....	156
Two New Species from Barbadoes (2 figures).....	161, 162
New Genus from Barbadoes (1 figure).....	163
New Species from Barbadoes (1 figure).....	164
Cover-Glass Forceps (2 figures).....	182
Photomicrographic Apparatus Arranged for Use with Oil Light (frontis- piece).....	193
Apparatus Arranged for Photomicrography with Acecylene Light(1 figure)	195
Gonococci in Urethral Pus (1 figure).....	197
Colony of <i>Staphylococcus pyrogenes aureus</i> floating on liquified Gelatin (1 figure).....	199
Giant-cell sarcoma (1 figure).....	201
Klebs-Loeffler bacillus (1 figure).....	203
Typhoid bacillus (1 figure).....	205
Influenza bacillus (1 figure).....	211
New microscope (1 figure).....	217
Portrait of Arthur Mead Edwards, M. D. (frontispiece).....	227
New Species from Barbadoes (1 figure).....	241
Bifurcated Double-ended Crystal from Asthmatic Sputum (1 figure).....	242
Portrait of Prof. Charles Wesley Smiley (frontispiece).....	259
Development of a free Swimming Medusa (11 figures) one in text 291,	293
Cystin (10 figures).....	297
New Species of <i>Tenia</i> (2 figures).....	306
Crystals from "Vaseline-Cocaine" (1 figure).....	308
San Jose Scale (frontispiece, 1 figure).....	324
San Jose Scale (7 other figures).....	324, 325, 326, 327, 328, 329, 330
Photo-micrographic Apparatus (frontispiece).....	367

THE AMERICAN
MONTHLY
MICROSCOPICAL JOURNAL.

VOL. XVII.

JANUARY, 1896.

No. 1.

Dr. William C. Krauss.

WITH FRONTISPIECE.

The maxim that a prophet is not without honor save in his own country has been often quoted to represent men of various professions, but will not apply in the case of the representative whose portrait appears above, for where he spent his childhood and youth and received his education in the arts and sciences preparatory to a higher plane of active life ameliorating the sufferings of humanity, he is highly honored by his former associates and citizens of his native town. William Christopher Krauss was born in Attica, N. Y., October 15th, 1863, and is the son of Andrew and Magdalena Krauss. He entered the Attica Union School in 1870 and graduated as valedictorian of his class in 1880. He entered Cornell University, Ithaca, N. Y., in the ensuing autumn, taking a scientific course and received the Horace K. White prize in veterinary science in 1883; he graduated in 1884, receiving the degree "Bachelor of Science" and a two years' certificate for extra work done in the Medical Preparatory Course, special final honors in anatomy and the publication of his graduating thesis "On the nervous system of the head of the larva of *Corydalus cornutus*, Linn.," by the faculty—in "Psyche," a well known entomological journal. Young Krauss then entered the Bellevue Hospital Medical College in New York City that fall and graduated as Doctor in Medicine in 1886, standing second

in the honor class. He then acted as interne in the Bellevue Hospital until autumn when he sailed for Germany and entered the University of Munich in the winter of 1886-7, and was assistant physician in the Royal Women's hospital during the following summer. It was at Munich, celebrated in song, that Dr. Krauss' parents visited him and together they traveled about Germany, visiting all the important cities of the "Fatherland." In the fall of '87, he entered the noted University at Berlin, where he devoted himself particularly to the study of the nervous diseases, and while here contributed several articles on his "specialty," to the leading medical journals of Germany and acted as special correspondent to the Buffalo Medical and Surgical Journal. Dr. Krauss graduated from the University of Berlin in the summer of 1888, with the degree Doctor of Medicine, receiving the standing "*Magna Cum Laude*," at the head of his class. He then entered the University of Paris in the autumn of '88, and visited London Medical Schools in the spring of '89. Having thus acquired a medical knowledge in its various relations which but few have attained at his age, he sailed from Hamburg the latter part of May, 1889, to meet again, after a few eventful years, his friends at the home of his earlier years. He soon located at 382 Virginia street, Buffalo, N. Y., where he has established a good practice—popular in his profession, yet not forgetting his parents in Attica, to whom he devotes his Sabbaths, and enjoys social relations under the parental roof. In Buffalo Dr. Krauss is associated with the Niagara University Medical College, lecturer on Pathology, and was recently appointed non resident lecturer at Cornell University, his special field being the nervous system. Dr. K. enjoys the distinction of being the second Cornell graduate in the department of Natural History who has acted in this capacity. As a journalist he is associate

editor of the Buffalo Medical and Surgical Journal, of the *Neurologisches Central Blatt* published at Berlin, Germany, of the *Journal of Nervous Mental Diseases* published at New York, of the *Revue Internationale de Bibliographie Medicale*, of Paris, France; and of "Modern Medicine," of Battle Creek, Mich. He is Pathologist to the Hospital of the Sisters of Charity, Buffalo, and was recently elected a member of the American Neurological Association at its meeting in Philadelphia. He has published 55 scientific papers, many of which have been translated in French and German and some in the Italian, Spanish and Russian languages.

He is President of the Attica Union School Alumni Association, an honor justly deserved for conduct and scholarship when a student in the school. Dr. Krauss, as a gentleman and scholar as well as a first class professional, has won high social relations, not only in Attica and Buffalo, but also in foreign countries where he has had an opportunity of forming an acquaintance.

Dr. Krauss is associated with the Niagara University Medical College, formerly as Professor of Pathology, now as Professor of Nervous Diseases. He was non-resident lecturer at Cornell University, Ithaca, N. Y., in 1890; and a contributor to the Wilder Quarter-Century book.

Societies.—Fellow of the Royal Microscopical Society of London; member of the American Microscopical Society since 1890. He has contributed to its proceedings each year since his election and was awarded the prize for the best series of mounted slides in 1893, and for the best series of Photomicrographs in 1894; Member of the Buffalo Microscopical Club and its President 1892-93; Fellow of the American Neurological Association; member of the New York State Medical Society, of the Medical Association of Central New York and editor of its proceedings 1894 and 1895, which were first brought out through his activity; Honorary member of the Lake Erie

Medical Society; member of the Erie County Medical Society; one of the founders and first secretary of the Buffalo Academy of Medicine 1892-94; Secretary of the Buffalo Obstetrical Society 1890-92; member of the Buffalo Medical Club, also of the Buffalo Liberal and University Clubs, Hospital Associations, Neurologist of the Erie County Hospital, Buffalo Hospital of the Sisters of Charity; Asylum and hospital of the Sisters of St. Francis, and Lexington Heights Hospital. Pathologist to the Charity Eye, Ear and Throat Dispensary and of the Grove Eye and Ear Hospital.

Comparative Morphology of the Brain of the Soft-shelled Turtle and the English Sparrow.

BY SUSANNA PHELPS GAGE,

ITHACA, N. Y.

The points touched upon in this paper are :

1. The importance of comparing through all stages of development widely different forms of brains in order to gain from exaggerated form and specialized function more light upon the truths of morphology and evolution.

2. The overlapping and crowding of parts of the brain in these, which are, in comparison with others of the same groups, highly specialized forms.

3. A degenerate condition of the olfactory lobes resulting in union due to crowding, not to a crossing of fibers from one lobe to the other. It is a feature incident to other specializations.

4. Although the parts connected with vision in the sparrow are highly developed, the union of the gemina across the meson by a relatively small commissure would indicate an independence of action of the two sides in contrast with the condition in the turtle and other forms where the connection between the two sides is far more intimate.

5. The tip of the snout is a more important tactile organ in the turtle than in the sparrow, as indicated by the large branch of the fifth nerve distributed to it in the former.

6. The eighth nerve has reached a higher development in the sparrow than in the turtle as indicated by its intimate connection with its opposite across the meson and its apparent connection through the auditory eminence with the column-like peduncles of the cerebellum, which in their turn form a large commissural connection in the cerebellum. These complicated and extensive structural developments and relations of these parts are probably associated with higher and more complex functions than the simpler conditions in the turtle.

7. The flocculus of the sparrow is probably homologous with the organ of the same name in man, and has a proton in the turtle and alligator. The pit in the skull for the reception of the flocculus is formed before the flocculus has grown sufficiently to enter it.

8. Twenty-six nidi and more than thirty fiber tracts with their commissural connections were found in the turtle and many apparent homologues were recognized in the sparrow. Especially in the turtle there is not the continuity of nerve tracts which one is led to believe occurs in mammals, but there is rather a more or less independent, overlapping series of tracts.

9. The pons is not present.

10. In the sparrow a large fiber tract from the mesal wall of the cerebrum strongly suggests the fornicolumn of mammals, but it has more extensive relations.

11. The conclusion is adopted that the so called callosum of birds and reptiles is the rudiment of a fornicommissure with a few fibers which may be truly callosal.

12. A metapore was not demonstrated in either the sparrow or soft-shelled turtle, although the tel is very

much attenuated in the position usually assigned to the metapore.

13. The metaplexus is apparently formed by crowding a ∇ -shaped membrane between two nearly parallel edges of the cerebellum and the oblongata.

14. The roof of the epicæle is at first a membrane. The union of the lateral halves of the cerebellum across the meson is secondary, the connecting membrane being replaced by a mesal lophius.

15. The widely divaricated condition of the gemina in birds is not due to crowding by the cerebrum and cerebellum but to their intrinsic growth begun before any crowding could occur.

16. There is suggested the possible identity of the double sulcus ventrad of the postcommissure with the pair of lateral outgrowths occurring caudad of the epiphysis, discovered by Loey.

17. The diaplexus of the turtle consists, in large part, of foldings of the membrane at either side of the meson. In this respect it has a closer relationship with the mammalian type than the mesal plexus of either the bird or the Amphibia.

18. In both turtle and sparrow, the paratela; occupying the rima or interval between the fimbria and the tenial edge of the striatum, it is morphologically a part of the roof of the prosocæle.

19. Various pockets of endyma were found upon the meson which have great significance for morphology, but are physiologically of slight importance. Among these pockets is the paraphysis found in the adult *Amyda* and in the embryo sparrow.

20. In *Amphibia*, turtle and sparrow, a transection of the hemicerebrum shows essentially a delta form. Caudad of the rima the three limbs are: (1.) The ventral or striatal; (2) the lateral or pallial; (3) the mesal. The

first two form segments extending from the caudal tip to the olfactory lobes. The rima divides the mesal segment into two parts, the dorsal or hippocampal and the ventral or tenial. At the porta the tenial unites with the thalamus. Cephalad of the porta, the hippocampal, unites with an outgrowth of the terma, the termatic segment; so that in the cephalic part of the brain the same complete delta form is re-established.

21. Sulci which enter the porta indicate that the hippocampal, termatic, striatal and tenial segments of the cerebrum have a representative in the mesal wall of the aula cephalic part of the third ventricle).

22. In both the sparrow and the turtle the striatal limb of the delta has a secondary thickening which is comparable with the caudatum of mammals.

23. The porta of the embryo sparrow is bifurcated by the intrusion of the caudatum into the aula. In the adult this intrusion is crowded into insignificance by surrounding parts. The two sulci of the aula which enter these parts of the porta can be traced upon the wall of the paracœle, one extending cephalad and the other caudad. On the aulic surface these sulci pass ventrad with no appearance of turning caudad to form the aulix or sulcus of Monro as the theory of his would seem to demand. Comparable sulci entering the porta were found in the turtle although the caudatum does not intrude into the aula.

24. The significance of other sulci was considered. (1) Those which indicate the boundary of a primal mesal membrane; as in cerebellum, and at the crista; (2) those occurring at the edge of solid parietes as in the formation of parts of the oblongata as shown by His or of the cortex of the cerebellum as shown by Herrick; (3) those occurring in more solid parts and whose walls finally coalesce to form a cell nidus.

A New Tube for the Culture of Anaerobic Micro-organisms.

Read Before La Societe D'Hygiene by Ferdinand Jean, director of the Society Laboratory.

The apparatus which I have the honor of presenting consists of a test tube 15 millimetres in diameter and 12 or 13 centimetres in length and having the mouth narrowed and closed with a ground glass stopper. A small

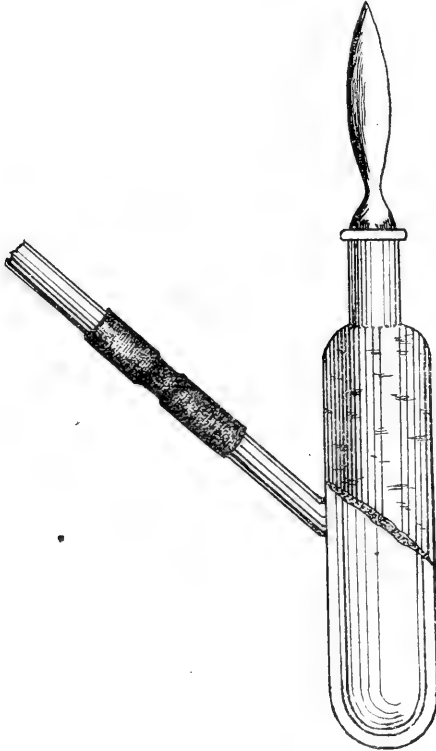

glass tube, the end of which has been drawn out and closed, in a Bunsen burner, is attached about half way down the principal tube so as to form an angle of 25° .

The uncorked tube, being held vertically, is filled to depth of two centimetres above the lateral tube with the liquified nutritive gelatine. There it is heated in a

solution of sea salt and water until the whole apparatus is sterilized.

After some minutes boiling and while the steam is passing off abundantly, close the tube with a cork which has been previously coated with vaseline and sterilized by a vapor bath. Then take it quickly from the salt water.

Now place the tube upon a little support in an inclined position with the mouth down and solidify the gelatine with cold water.

When ready to fertilize the tube, attach the small tube, by means of a rubber piping, thoroughly sterilized, to the tube of a bell glass filled with hydrogen; then with the pincers break off the closed end. The tube being filled with hydrogen, pinch the rubber tube, detach the bell glass, and quickly close the rubber tube with a glass stopper which has been carefully sterilized.

To fertilize the gelatine, remove carefully the ground glass, cork and introduce the culture by picking with a platinum wire, being careful not to penetrate below the upper film of gelatine, and then close the tube with the stopper.

Suggestions Regarding Microscopical Societies.

BY V. A. LATHAM,

CHICAGO, ILL.

Regarding membership in Societies, I am of opinion many people join for the sake of the name and care nothing for the work. At the present time the vital question is: how shall we make our Society a successful one? That something ought to be done is certain—but how? Speaking generally of scientific societies in all parts and in all branches, I would state that they require a thorough turning out and a new start. The meetings are not such

that a busy worker cares at the end of a hard day's work to go to them.

- (1.) Because often they are inconveniently situated.
- (2.) Members come or meetings begin after time.
- (3.) Arranged so late that suburbanites have to leave in the midst of a discussion or miss the last train.
- (4.) Business is not so well conducted as it might be and speakers brought to time.
- (5.) Papers are often not particularly adapted for the Society or only of slight interest to the majority.
- (6.) That the subject has to be discussed off-hand and few people are ready to do that quickly and well.
- (7.) That free discussion in some instances has to be limited on account of length of paper or business.
- (8.) Lack of practical work in societies.
- (9.) Danger of "clerkism."
- (10.) The lack of a good microscopical loan and reference library and cabinet.

The exact way to secure a better attendance and more interest is first to offer some advantage, the next to secure working people for the society and exclude those who will not work or contribute and avoid such members.

The old saying is true—we cannot please all but we can a few and that few will help and do it willingly. A few suggestions I would offer for society work in general.

If the essayist be chosen long enough, let him or one of the programme committee secure debates on the question. All papers when possible should be illustrated by photographs, preparations, and if possible methods should be shown and criticism offered.

Once a year an annual Soiree should be held and a well known but excellent popular lecturer secured to give a short address, illustrating with the lantern and specimens. After the lecture a social looking over of specimens, discussing what was seen, modes of staining and

preparation. An opening meeting should take the form of an Exhibition and *Conversazione* and ladies and friends be invited.

Material for mounting might be distributed amongst the members by those who can prepare it and in this way a very nice cabinet of reference specimens could be made by each member, instead of buying poor specimens. A library should be formed and books issued, for many members are not rich enough to secure all journals and books necessary. A slide cabinet from which specimens might be drawn to study and compare with. This is especially useful in adulterations of food, in Foraminifera, Embryology, Wood Sections, etc., etc.

Exchanges from societies and gifts from publishers and editors can be obtained without much difficulty. A mounting section should be attached, to which the older children could be associate members and gain help in preparing their Biological High School work. Many are also able to make nice collections of Micro-fungi, Mosses, Pond life, etc., etc., The course may be arranged to cover the three kingdoms.

1. Lecture and lesson, say Histologic Demonstration. The structure, chemistry and physics of the vegetable and animal cell and mounting specimens, testing with various reagents.

2. Demonstrations in illumination of objects with the various Substage Condensers.

3. Illustrated with the Oxy-Hydrogen lantern and experiments, composition of blood, its physical and chemical properties.

5. Lesson on staining, fixing and counting blood by Ehrlich, Biondi, Plehn, logwood, eosin, etc.

6. Various mounting media as C. Balsam, C. B. in solvents, Farrant, Dama, glycerine, acetate potassium, sol. of sodium, fluo-silicate, glycerine jelly, and their advantages.

7. Dry and opaque mounting.
8. The lantern Microscope Projection.
9. Dissection of fresh water mussel.
10. Cutting material in paraffin. Single and serial sections.
11. Celloidon,—Freezing.
12. Selections of foraminifera.
13. Selections of diatoms.
14. Cutting vegetable sections.
15. Mounting in fluids.
16. Cell making.
17. Ringing.
18. Mechanism of the Microscope.
19. Use of high power and their illumination.
20. Mounting in Balsam, with or without pressure—
Insect.
21. Injecting.
22. Camera Lucida and Drawing.
23. Analysis Spectrum.

During the summer afternoons—especially Saturday half-days—members should meet and take train for good fielding and hunting ground chosen by experts in the vicinity and show how to hunt for pond life, diatoms, algae, mosses, micro-fungi, botanical, etc., and then take supper and have a social evening and then take train home.

The publication of the meetings. Some of the work should be printed in some one of the papers and notice of excursions printed there. In this way friends are made, health gained, Science becomes a pleasure and a gain. Hours of winter or rainy day amusements. Teachers' work lightened because some know a good field for Amœbae, another for Volvox, another for Hydræ and yet another for Micro-Fungi and from the young mounters, we get our expert workers developed and who become the machine and pillars of the Society

I would suggest a subject say as an example and then have criticism.

Mode of using Eosin and its results be given in Histology and Pathology.

- A. Chemistry and varieties.
 - B. Solubilities in alc. H_2O .
 - C. Staining with H_2O . Sol.
Washing mount.
 - D. St. c. Alc. Sol. Mode of after treatment.
 - E. Results in Vegetable
 - F. " " Pathology
 - G. " " Histology
- } Tissues.
- H. Results for Blood of H_2O . Sol.
 - I. Results for Blood of Alc. Sol.
 - J. Literature.
 - K. Discussion.
-

A Modern Microscopic Objective.

BY HENRY ORFORD.

The objective has been ever a source of discussion for microscopists, and also the most difficult part of the instrument with which the optician has to deal. Years back, when the instrument was known only to a few scientists, the question of the construction of the objective was taken up, and many related untenable theories were advanced. Such is the diffraction theory. If this is correct, as some prominent microscopists still believe, all the previous impressions of the older optical principles must be disregarded, also all the writings of the optical physicist, before the diffraction theory became floated, must be put down as useless.

Dr. Goring pointed out that a larger lens, meaning one with more aperture, would separate the minute markings of scales on a test slide, and that he could get better results with an unachromatized objective of larger

aperture than he could with the achromatic systems of small aperture of that day. And since that time there has been an ever-increasing desire to enlarge the aperture of objectives. It was soon found out, however, that with every degree of enlarged aperture attempted, the delicacy of the aberrations to be corrected were also enormously increased. So that the computation of a modern objective is truly a gigantic undertaking.

Some years later a fluid was suggested to be used between the anterior lens and the cover glass, to prevent the great loss of light due to refraction. And I believe Mr. Tolles constructed lenses with which he used balsam as the immersing medium. Before this, however, Powell and Lealand had constructed very fine water immersion lenses. Since Dr. Abbe's adoption of cedar oil this has generally come into use, and other immersion fluids, some of which possibly have special uses, have been gradually discontinued. Cedar oil was adopted by Dr. Abbe only after exhaustive experiment, and it stands without a rival in dispersive suitability.

For the purpose of vision an image must be formed on the retina of the eye, and the purpose of the compound microscope is to form an enlarged image of minute structures that are indistinguishable by the unaided eye. Images are formed by rays, and every single ray has the power of forming an image. If such were not the case the lens would have no image-forming power itself.

To show this make the pinhole experiment. Light a candle in a dark room. Arrange a sheet of cardboard two feet distant, and between the two put a blackened card punctured with a pinhole. We see then an inverted image of the flame on the white card. If we make the hole in the card larger, we get a brighter but no longer a sharp image, because now it is really a number of images, formed by rays that cross at different points of

the larger hole. These rays of light, each having an image-forming power when passing through a lens, are all converged together to a focus, and the image formed will, of course, be many times brighter than that of the single ray which passed through the blackened card. The lens then determines the place where the cones of diverging rays from an object shall begin to converge, and its position marks the place where refraction occurs, and also marks the point where the rays cross and invert the image. So the objective only converges and combines masses of rays, each one of which has the power of forming an image. It is thus obvious that the increased aperture of a lens means greater illumination. As stated before, Dr. Goring found better resolution with an unachromatized combination of large aperture than with an achromatic system of small aperture.

The relation between aperture and resolution was shown by a simple experiment of Lord Raleigh. Each person was furnished with the apparatus required. It consisted of a piece of fine wire gauze, and a black card with two pinholes, one very small, and the other made with a thick pin. Holding the gauze to the light and looking at it through the small pinhole, gradually moving it further off, at a certain distance the meshes would become invisible. Moving the card along till the larger pinhole was in front and close to the eye, instantly the meshes would become visible again. It will be seen at once that the greater aperture allowed to the eye brought them into view.

That it was not merely more light that brought the image of the meshes distinctly to the eye can instantly be proved by another simple experiment. Get a piece of blackened glass, and make two scratches on it about 1-16 of an inch long, one vertical and the other horizontal. Hold the gauze so that the wires are horizontal and ver-

tical to the scratches on the glass, and, when the proper distance is found, it will be seen the vertical scratch will not show the vertical wires, but will clearly show the horizontal ones, whilst the horizontal scratch will only show the vertical wires. The amount of light that passes through each scratch is exactly the same. So it will be seen it is the aperture diameter, which crosses the wires, that determines the distance at which they can be resolved. We then see that the rays form the image, and the aperture determines the resolution. This is the same whether applied to a deep microscope objective, resolving a fine diatom, or to a telescope dividing a double star. And whether the diffraction theory does or does not apply to either of these cases, the very same numerical law of relation between aperture and resolution applies to all.

Every microscopist knows the Abbe diffraction theory, and how it took the microscopical world by storm; and also how the theory has been successively modified, as error after error has been demonstrated. Abbe maintained that the image was not dioptrically formed, but was an interference image. This he demonstrated with a fine diatom of about 93,000 striations to the inch, using a lens of 1.26 N. A., and very oblique illumination, till the narrow pencil he used appeared on the margin of the back of the lens. On the opposite side of the lens appeared a blue light, and when this was covered up every vestige of markings disappeared, and only the shell of the diatom was seen. By his excessive oblique light he had increased the aperture of his lens, but directly his narrow cone was interfered with all benefit was lost again. Not so with a wide cone. I have many times put a ring around the back of a lens, and allowing the central and most marginal rays only to enter the microscope, even when half of the few marginal rays were obstructed, the markings of the image yet remained.

One thing the diffraction theory did, it settled forever striving after useless magnifying power in objectives; such as 1-40 and 1-50 of very small aperture, and led opticians to construct lower powers 1-8 and 1-12, of large aperture, from which more could be gained.

That the true resolution of an object is affected by a wide cone instead of a narrow one is now beyond question, consequently the laws of optics are just in the same place as when demonstrated by the old writers. But having this extreme oblique illumination and resolving of the striæ is a true image formed, such as can be obtained with a dioptric or wide cone? It will be found both by observation and measurement that the diffraction image is utterly false. The striations are seen as considerably finer than the true structure, also markings are shown of an elongated form. The diffraction spectra can only be shown by very narrow pencils of light. And the narrower the pencil the sharper the so-called image. But to get a true image we must employ a large cone. We saw with the pinhole that a ray formed an image; but that image had no focus. When we put a lens in its place there is a definite focus, because, at one point only, a diverging cone of rays from a point in the object is converged into another cone, whose apex is as small and sharp an image of the point as the aperture and correction permit.

Any such image, formed by rays first diverging from a point, and then converged by the corrected refraction of a lens to the image point, is a dioptric image, and every real microscope image is dioptric. What we want is an objective that will give a true dioptric image coupled with a good condenser having an aplanatic cone. With these the narrow cone theory is intolerable. Given objectives and condensers good enough, the best results in definition and resolution of fine structure have been with wide cones.

As a manufacturer of lenses of some years standing, as well as a worker with a microscope, I have had ample opportunities to carry out many experiments, which are almost impossible for the ordinary microscopist to imagine, and I have also had free access to almost any lens of other makers which I desired to examine. A microscope objective then should have larger aperture, but that aperture is worse than useless unless it is properly corrected.

Some time since I carried out a series of experiments with the aperture of lenses relating to corrections. I constructed a lens of 1.30 N. A., and at the back fitted an iris diaphragm, which could cut out all the marginal rays. Trying it on a test diatom I found no difference appeared when I cut the aperture down to 1.1 N. A. Below that the minute markings disappeared. The objective showed the markings just as well with the aperture of 1.1 N. A., as with 1.30 N. A., so of course it proved that the marginal rays were not sufficiently corrected. I may say that this could only be observed when using a condenser with an aplanatic cone. When used with an Abbe condenser, with its enormous aberration, these facts were indistinguishable. Correcting the lens yet farther, and using a perfectly achromatized condenser, the image was remarkable.

The fact was soon impressed on me that for very fine resolution aperture is useless unless it is corrected in all its zones. Otherwise it had better be cut away. For as cones are enlarged, faults of objectives are revealed, and as the objective is more perfectly corrected faults in the cone stand out more clearly. Consequently for high resolution the solid cone will no longer suffice.

With increased and perfectly corrected aperture, the flatness of field should be as important to the maker. But this is very difficult to correct, and it has always been taken for granted that definition and flatness were incompatible. A glance at my objectives will be a proof to the contrary.—*Journal N. Y. Mic. Society.*

Classification of the Radiolaria: Key to the Species of Barbadoes.

By REV. FRED'K B. CARTER.

MONTCLAIR, N. J.

Continued from p. 213, July, 1895, and Concluded.

154. SETHOCYRTIS.

- Shell bottle-shaped, smooth ; mouth nearly as broad as thorax canerina
- Shell pear-shaped, thorny ; mouth $\frac{1}{2}$ as broad as thorax diomedis
- Shell pear-shaped, spiny ; mouth $\frac{1}{3}$ as broad as thorax menelai

155. SETHOCORYS.

- Shell slenderly ovate, smooth, cephalis ovate ; mouth $\frac{1}{2}$ as broad as thorax
armadillo

156. LOPHOPHÆNA.

- Horns not connected, bristle-shaped, about as long as radius of cephalis
galea
- Horns not connected, stout, conical ; about as long as diameter of cephalis
radians
- Horns connected, conical, about as long as diameter of cephalis...circumtexta

157. DICTYOCEPHALUS.

- Length of the two joints 5-12, cephalis campanulate urceolus
- Length of the 2 joints 5-10, cephalis ovate-conical excellens
- Length of the 2 joints 4-6, cephalis ovate crassiceps

158. SETHOCAPSA.

- Shell smooth ; cephalis with small conical horn of $\frac{1}{3}$ the length.....lagena
- Shell smooth ; cephalis with large pyramidal horn of twice the length
nidus
- Shell smooth ; cephalis with internal septum of 2 crossed beams
staurocephala
- Shell spiny ; cephalis with conical horn of the same length bulla

159. DICOLOCAPSA.

- Shell papillate, thick walled ; cephalis flat, hemispherical platycephala

160. PTEROCORYS.

- Cephalis with one horn twice the length ; thorax with angular wings of
same length.....barbadeusis
- Cephalis with one horn three times the length ; thorax with conical
wings twice the length.....apis
- Cephalis with one horn twice the length, thorax with conical wings $\frac{1}{2}$
the length of shell.....melitta
- Cephalis with one horn of same length, thorax with conical wings as
long as the cephalis.....turgida
- Cephalis with several horns, thorax with short conical wings.....zittelii

161. THEOPODIUM.

Shell 3-sided pyramidal, rough, without external strictures.....pyramidale

162. PTEROCANIUM.

Thorax and abdomen with small circular pores, densely crowded together.....contiguum

163. PTEROCODON.

Shell campanulate, mouth with corona of 12-15 feet.....campana

164. PODOCYRTIS.

Feet cylindrical, as long as the abdomen, little divergentattenuata

Feet conical, about as long as the thorax, divergentconica

Feet pyramidal, divergent, as long as the cephalis.conulus

Feet triangular, short, pores 3 times as broad in abdomen as in thorax
brevipes

Feet slightly divergent, short, pores 4-6 times as broad in abdomen as
in thorax.....collaris

Feet nearly parallel, pores 5 times as broad in abdomen as in thorax
schomburgkii

Feet triangular, stout, divergent, pores 4-6 times as broad in abdomen
as in thoraxventricosa

Feet triangular, short, cephalis with cylindrical horn nearly as long as
the shell.....euceros

Feet s-shaped, cephalis with stout conical horn.....centriscus

Feet s-shaped, cephalis with cylindrical horn longer than the shell
princeps

Feet short, thick, bent outwards, abdomen urn-shaped.....urceolata

Feet conical, slender, divergent, abdomen nearly cylindricalehrenbergii

Feet spindle-shaped, slender, divergent, abdomen inflatedargulus

Feet shovel-shaped, triangular, convergent, length of joints 1-3-1.....papalis

Feet shovel-shaped, semicircular, convergent, length of joints 2-9-4
mitrella

Feet shovel-shaped, slightly divergent, length of joints 1-2-3.....mitra

Feet shovel-shaped, triangular, nearly vertical, length of joints 1-3-4
argus

Feet shovel-shaped, nearly vertical, length of joints 1-2-6eulophos

Feet shovel-shaped, convergent, length of joints 1-2-4.....sintosa

Feet shovel-shaped, convergent, length of joints 2-3-6.....floribunda

Feet shovel-shaped, convergent, very small, length of joints 1-4-5ampla

Feet shovel-shaped, convergent, very small, length of joints 1-3-3.....nana

Feet shovel-shaped, convergent, short and broad, length of joints 2-5-8
lyæa

Feet shovel-shaped, nearly vertical, short, length of joints 2-5-5bromia

Feet conical, slightly convergent, small, length of joints 1-2-4tripus

Feet sub-cylindrical, curved, thin, length of joints 1-2-4.....tracantha

165. THYRSOCYRTIS.

Shell conical, feet divergent..... rhizodon
 Shell pear-shaped, feet cylindrical, parallel rhizopus
 Shell campanulate-conical, feet cylindrical, s-shaped radicata

166. DICTYPODIUM.

Feet fenestrated throughout, diverging, pores in thorax and abdomen
 small eurylophos
 Feet fenestrated throughout, diverging, pores in thorax and abdomen
 large..... oxylophos
 Feet fenestrated at end, nearly vertical, s-shaped cothurnatum

167. LITHORNITHIUM.

Thorax with 3 broad triangular wings of $\frac{1}{2}$ the length foveolatum

168. THEOPERA.

Shell 3-sided pyramidal, wings broad and long..... pyramis
 Shell slenderly ovate, wings prolonged into slender spines..... luscinia

169. RHOPALOCANIUM

Shell nearly spindle-shaped, abdomen inversely conical..... ornatum
 Shell nearly ovate, abdomen inversely campanulate prolonged into tube
 pythia

170. LITHOCHYTRIS.

Feet solid, abdomen without prominent edges..... tripodium
 Feet fenestrated, abdomen with sharp prominent edges..... pileata
 Feet fenestrated, abdomen with rounded edges pyramidalis
 Feet fenestrated, abdomen without prominent edges. vespertilio

171. PHORMOCYRTIS.

Shell smooth, cephalis with pyramidal horn of the same length..... embolum
 Shell rough, cephalis with cylindrical horn about as long as the shell
 longicornis

172. ALACORYS.

Peristome with four feet tetracantha
 Peristome with five feet..... pentacantha
 Peristome with six feet..... hexapleura
 Peristome with eight feet..... aculeata
 Peristome with nine feet..... gigas
 Peristome with twelve feet..... dodecantha
 Peristome with eighteen feet, shell rough carcinus
 Peristome with 18-24 feet, shell smooth ornata

173. CYCLADOPHORA.

Abdomen with 6 ribs, shell lantern shaped, with 2 sharp strictures
 hexapleura
 Abdomen with 6 ribs, shell pyramidal, with 2 slight strictures... pyramidalis
 Abdomen with 6 ribs, shell spiny, with 2 deep strictures..... spinosa
 Abdomen with 9 ribs nonagona
 Abdomen dilated, with 15-20 divergent ribs..... campanula

Pores disposed in oblique rowsdoliolum
 Pores in thorax in oblique, in abdomen in transverse rowscingulata

183. THEOCORYS.

Cephalis with slightly curved horn, half as long as the shellscolopax
 Cephalis with cylindrical horn, half as long as the shellbachabunda
 Cephalis with short oblique, conical hornattenuata
 Cephalis with oblique pyramidal horn of same lengthobliqua
 Cephalis with conical horn 3 times the lengthalauda
 Cephalis with conical horn of same lengthsphaerophila
 Cephalis with cylindrical horn twice the lengthtuberculata

184. LOPHOCORYS

Cephalis with 1 pyramidal and 3 small hornsacanthocephala
 Cephalis with 2 pyramidal hornsbicornis

185. THEOCAMPE.

Pores in thorax in alternating, in abdomen in 5-6 transverse rowspirum
 Pores in transverse rows, 3 in cephalis, 6 in thorax, 3 in abdomennucula
 Pores in cephalis and thorax in oblique, in abdomen in 10-12 transverse
 rowsovulum
 Pores quincuncially disposed, in abdomen 3 times as broad as in thorax
versipellis
 Pores oblique in cephalis and thorax, abdomen with longitudinal ribs
gemmata
 Pores quincuncial, cephalis half hidden in thoraxcryptocephala

186. THEOCAPSA.

Shell conical, cephalis with horn 3 times the lengthrathkei
 Shell pear-shaped, cephalis with horn of same lengthsarsii

187. TRICOLOCAPSA.

Thorax smaller than abdomen, shell with 2 indistinct stricturesbrownii

188. STICHOPILIUM.

Shell with 6 joints, thorax with 3 long wings or spinesmacropterum

189. PTEROPILIUM.

Third joints with 3 ribs prolonged into latticed wingssphinx
 Second joint with 3 ribs prolonged into wings with few poresbombus

190. ARTOPERA.

Second and third joints with 3 wings, fourth with pyramidal spineloxia

191. ARTOPHORMIS.

Nine ribs prolonged into 9 feetbarbadensis

192. LITHOSTROBUS.

Shell smooth, with 6-8 slight stricturespicus
 Shell thorny, with 5-7 slight stricturesargus
 Shell smooth, with 4-6 deep stricturesacuminatus
 Shell smooth, with 3-4 deep stricturesmicroporus

193. DICTYOMITRA.

Shell with 6-8 deep strictures, joints nearly equal in length articulata

194. ARTOSTROBUS.

Shell with 8-10 internal annular septa, abdomen with 6-8 joints.elegans

195. LITHOMITRA.

Shell slightly dilated, on each joint a single row of pores pachyderma

Shell nearly cylindrical, on each joint a single row of pores, joints

broader and shorter than in the preceding..... acephala

Shell sub-cylindrical. thorax with 2-3 rows of pores..... lineata

Shell diminishing slightly toward both ends, on each joint a single row •
of pores descending obliquely..... eruca

196. EUCYRTIDIUM.

Shell with 4 joints, cephalis with club-shaped, spinulate or branched

horn..... anthophorum

Shell with 5 joints, cephalis with conical horn eruca

Shell with 6 joints, cephalis hyaline, with conical horn montiparum

197. EUSYRINGIUM.

Shell thick-walled, cephalis with conical horn siphon

Shell thin-walled, cephalis with pyramidal horn fistuligerum

198. SIPHOCAMPE.

Abdomen with spirally convoluted ribs spiralis

199. LITHOCAMPE.

Shell spindle-shaped, with 6 joints equal in length radicula

Shell club-shaped or ovate, with 6 joints of different lengths..... clava

200. STICHOCAPSA.

Shell pear-shaped with 3 internal septal rings pyriformis

Shell pear-shaped with 5 internal septal rings..... hexacola

Shell pear-shaped with 8 internal septal rings..... compacta

Shell spindle-shaped with 4-5 slight strictures. radicula

201. ARTOCAPSA.

Shell spindle-shaped, smooth, with 3 sharp strictures. quadricamera

ERRATA.

In July Number, 1895.

Page 206.

In genera 79 and 84, for "butschlu" read "butschlii."

Page 207.

In genus 94, for "didicerus" read "didiceros."

In genus 98, for "Deudrosphyris" read "Dendrosphyris," for "dirrhiga" read
"dirrhiza."

In genus 100, for "articulate" read "articulata."

In genus 102, for "atenchus" read "ateuchus."

Page 208.

In genus 103, for "Clatharospyris" read "Clathrospyris."

In genus 108, for "enpetala" read "eupetala."

Page 209.

In family 17, for "Cortin" read "Cortina."

Page 212.

In genus 149, for "trangular" read "triangular."

Radiolaria: A New Species from Barbadoes.

REV. FRED'K. B. CARTER.

MONTCLAIR, N. J.

Pentinastrum pentacephaleum, U. Sp.

All five arms equal, club shaped, at their egg-shaped distal end twice as broad as at their base, and armed with a strong conical spine. Several smaller spines on the border of the patagium which is complete, not quite fill-

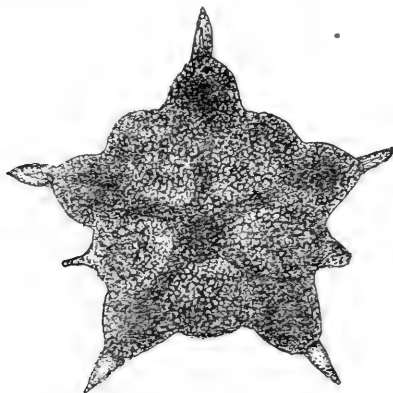

ing up the interbrachial spaces. Resembles very closely *Pentinastrum goniaster*, Haeckel, from which it differs mainly in not forming such a regular pentagium and having spines on the patagium.

Dimensions.—Radius of each arm 0.19; basal breadth, 0.03; distal breadth, 0.006; radius of the central disk, 0.025.

Habitat.—Fossil on the rocks of Barbadoes.

This form was found by Mr. H. J. Sutton of Philadelphia, Pa., who took the photograph from which the drawing accompanying this description was made.

Infusoria for Identification.

Last Spring I caught a small mud turtle about two or three inches in diameter. Around the edge of its shell was a white fringe. Upon examination, this fringe turned out to be animals. I kept the turtle, and in a short time these animals covered his entire body, except his upper

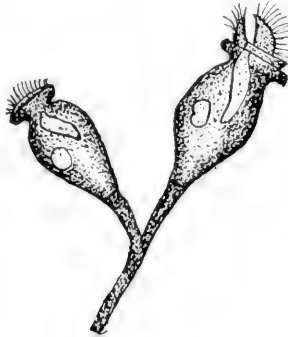

and lower shells ; they covered his neck and head, feet and legs and even his tail.

They were colorless and were on a straight stem, cilia were only around the mouth. They seemed to increase by binary subdivision, there being usually 2, 4 or 8 animals on a stem.

I think that they attached themselves to the turtle so as to be carried from place to place in order to get food. Can anyone tell me from this slight description what the name of this Infusoria is ?

EDITORIAL.

Microscopical Journalism.—We have been favored with an announcement from one of the leading microscope makers of the United States, that its house will proceed very soon to establish a monthly periodical and that it will spare neither pains nor expense to procure the highest quality of contributions.

The object in view is not entirely to supply a public want but to enable the house to advertise its own goods. The primary object is advertising, but the advertisements of rival concerns will be excluded of course. The house has approached us with a proposition that we exchange advertisements.

Under this plan we are to advertise not simply their periodical but necessarily their business without pay. They are to advertise our periodicals without pay. To us it can only mean the securing of a few new subscribers, since we already have a large part of the microscopical subscribers on our list. To them it means securing access to all of our subscribers, and advertising their goods free of cost—the saving of the money which they have heretofore paid us. If our subscribers would generally go over to the new periodical of course we should find ourselves in a bad predicament. There are some people who go rushing from periodical to periodical and our record of their exploits is amusing. After an absence of one or two years during which they have taken a 25-cent or 50-cent microscopical “magazine,” they come back inquiring whether they can get our back numbers with which to complete their files.

The history of such periodicals has been of much interest. The 50-cent magazine started almost two years ago has collapsed and been merged with botany, ornithology, herpetology, conchology, etc., etc.

The 25-cent magazine has lived many years and in spite of a tremendous amount of advertising which a Philadelphia optical house has done by means of it, the house has been compelled to suspend payments and make a piteous appeal to all its creditors—throughout the world—to grant an extension and to accept instalment payments at six-month intervals. That house had the assurance years ago to ask us to grant them an

exchange advertisement. We declined and have never regretted doing so.

The pound rate law under which we secure a very low rate of postage on our periodicals, was framed to benefit the people and to aid legitimate journalism.

When a house selling microscopes comes forward to publish a periodical, ostensibly to benefit the people but really to scatter its own advertisements at pound rates it does a dishonest thing and disaster is sure to come—as sure as night to follow day.

People in other lines of business understand these principles. Thousands of houses contract for advertising by the wholesale. The money they spend would support several class journals. Why do they not establish such journals and drive to the wall their competitors since they have such superior conditions for so doing? The money spent annually by Charles Marchand, whose advertisement appears on our cover, amounts to more than \$50,000 and is distributed to nearly all of the 200 medical periodicals of the United States. He could afford to publish a medical journal that would exceed all others in its literary merits, for the sake of covering page after page with his own advertisements, but he has sense enough to scent the disaster sure to overtake dishonesty. He will do nothing of the sort. The great success that his remedies are meeting proves his wisdom in patronizing legitimate journalism and in refraining from setting up a competing periodical and then asking medical journals to give him free advertising under the misnomer of “exchange.”

Had the Philadelphia house alluded to pursued a similar policy and refrained from putting out insignificant twenty-five cent collections of clippings to float advertisements; and had it been as conscientious in all other respects, it would never have found itself in the humiliating scrape from which it has struggled for two years to extricate itself by cutting prices and under-selling other people.

Curiously, one of the concerns that has been injured somewhat by said price-cutting but that has not been as yet compelled to assign is tempted to imitate those Philadelphia people by setting up a class magazine, primarily to advertise

and secondarily to publish articles. In due time, though perhaps not till it has wrought considerable injury, misfortunes will overtake them, coming from sources unconnected with those whom they have wronged, and they will either wonder why they suffer at all or will be entirely content to explain it as due to "tariff legislation," or to the poor condition of business throughout the country.

Not American.—On page 402 of our December issue we published a letter from Miss V. A. Latham. We had asked her as well as all the other officers of the American Microscopical Society to contribute her views regarding any ways in which we might advance the interests of the Society.

In reply she took occasion to say: "I do not approve of the Journals over here at all. The *MICROSCOPE* as edited by Manton was one of the most valuable periodicals going but now there is not a decent one existing."

In a footnote we thought best to remind the reader of a possible reason why American periodicals are so poor, by saying:

"It will be borne in mind that Miss Latham is one of the editors of an English microscopical periodical and that she, an American, sends most of her contributions abroad to be published."

We are consequently in receipt of the following request, with which we are pleased to comply.

"Will you kindly make an early correction in your Journal and oblige. In the footnote on page 402 you make the statement I am an American. That is far from being a disgrace and I feel honored by the same, but in the first place every one has a right to contribute wheresoever he will, and again I beg to state that I am NOT an American but distinctly English, that is if a wandering person like myself can claim any residence."

We therefore ask the members of the American Microscopical Society who at their Ithaca meeting elected Miss Latham as one of their officers and to whom we have appealed for co-operation in advancing the interests of the American Society, to please note that Miss Latham quite emphatically wishes it understood that she is NOT an American."

If there are any more officers of the American Society who are not Americans we will afford them space in which to say so in case they desire it to be known.

MICROSCOPICAL MANIPULATION.

A New Method of Staining Flagella.—Loeffler's method of staining flagella is probably the one most commonly and generally employed. This consists in treating the bacteria to be stained with a mordant made up of tannic acid and ferrous sulphate, and then staining the bacteria with a solution of an anilin color in water.

I have devised a method which is simple, and in my hands, much more reliable and easier of execution. * It is as simple as the staining of bacteria with ordinary carbol-fuchsin, and I have stained over fifty preparations of flagellated micro-organisms, each time demonstrating the flagella most satisfactorily.

The method consists in the use of but a single solution, which is at once mordant and stain. The solution should be made in two parts, which are filtered and mixed.

A.

Saturated aqueous solution of alum . . .	10 c.cm.
Saturated alcoholic solution of gentian-violet . . .	1 c.cm.

B.

Tannic acid	1 gm.
Distilled water	10 c.cm.

The solution should be made with cold water, and immediately after mixing the stain is ready for use.

The cover-slip is to be carefully cleaned, the grease being burned off in a flame, and after it has cooled the bacteria are spread upon it, well diluted in water, care being taken to exclude culture medium. After the preparation has been thoroughly dried in the air it should be held over the flame with the fingers, as Loeffler has directed. Afterward the stain is gradually poured on the slip and heated gently, bringing the fluid almost to a boil; the slip covered with the hot stain should then be laid aside for one minute, then washed in water and mounted.

Upon examination, the bacteria, both isolated and in clumps, will, if motile, be found to have the flagella clearly and delicately defined. In the middle of the cover-slip, as well as around the edges, the bacteria will be found equally well

stained; the clumps being surrounded by a zone of delicate fringing flagella, each being well stained and distinctly outlined from its fellows.

If a clean preparation is desired, the stain, after mixing, may be filtered, but I have found that the most reliable method is to use the unfiltered stain. In the case of the former a clear field is produced without the detritus, etc., precipitated on the glass around the micro-organisms; and all the flagella are stained, but not so distinctly as with the unfiltered solution.

If the filtered stain is used, a second stain of anilin water containing gentian-violet had better be used, which should be applied but a moment and then washed off, thus leaving a clean field, showing only the bacteria lightly stained, with their flagella still more lightly colored.

In examining the different bacteria, I have found that the bacillus of typhoid fever, the colon-bacillus, the cholera-bacillus, and the bacillus of hog-cholera, each stained well by this method, and without the addition of any acid or alkali to the mordant, such as Loeffler uses.

The bacillus of typhoid fever showed the flagella most beautifully, and there seemed one flagellum to each cell that stained more deeply than the others and appeared larger and stronger.

As to the keeping qualities of the stain I have not fully ascertained, but presumably it should be mixed daily to yield the best results.—R. I. PITTFIELD, M. D., in *The Medical News*.

Borax Carmine as a Staining Fluid.—P. W. Squire, in the "Pharmaceutical Journal," says: The use of aqueous borax carmine, followed by washings with alcohol, is generally accompanied by the precipitation of the coloring matter in the cavity of the cell, and whilst recommending an alcoholic solution of borax carmine, he states that with the formula in use for animal histology, the desired result is only obtained with extreme slowness. His solution, which is stated to give good results in favorable cases in a minimum of ten minutes, is made as follows: Powdered carmine, 2 grammes; borate of sodium, 8 grammes; alcohol (70°), 200 grammes. The ingredients are heated together in a flask for twenty minutes, using an upright condenser to prevent loss of alcohol. The use of alcoholic borax carmine for staining vegetable tissues is not new;

the application of Grenacher's solution for this purpose is published in 'Methods and Formulæ' (Squire), 1892, and sections stained as there described were exhibited by me at the Pharmaceutical Society's evening meeting in February, 1893. I have recently made comparative trials by staining different kinds of vegetable tissues with the solution recommended by M. Radais alongside of Grenacher's solution, and another to be described later. The Radais solution was certainly not quicker in action, and the staining was not so good as with the other two. His formula given above yields a turbid liquid, which on standing for a short time deposits a considerable quantity of sediment and after filtration the solution is comparatively pale in color. The borax is less soluble in that strength of alcohol, and therefore cannot form with carmine such a deeply colored solution as with a weaker spirit.

To test the quantity of dissolved matter, 10 c. c. of each solution in turn was placed in a platinum basin and evaporated on a water bath until the residue ceased to lose weight. The percentage of alcohol is given by volume for comparison with Radais formula, Grenacher's solution, containing 40 per cent. (by volume) alcohol, yielded .171 gramme. Another solution (see below), containing 50 per cent. (by volume) alcohol, yielded .147 gramme. Radais' solution, containing 70 per cent. (by volume) alcohol, yielded .052 gramme. Borax and carmine dissolve readily in the water, but when a large porportion of strong alcohol is added precipitation occurs, and this takes place to a considerable extent after the alcohol exceeds about 50 per cent. (by volume) of the whole.

This has also a bearing on the alcohol washing after the carmine bath. If sections be placed in aqueous borax carmine, or even Grenacher's solution, and after staining be transferred direct to 70 per cent or stronger alcohol, there is danger of carmine deposits in or upon the tissues, but if excess of stain be removed by just rinsing the sections in distilled water previous to their removal into alcohol, the danger is removed. It is always much safer to take this precaution, but the tissues must not remain more than a few seconds in the water, else the stain may be removed.

The more strongly alcoholic solution than that known as

Grenacher's, and which I have alluded to above, is made as follows:—Carmine 3 grammes; borax, 4 grammes; distilled water, 85 c. c.; rectified spirit, 115 c. c. Dissolve the borax in the water, add the carmine, and heat in a flask until the mixture just boils. Cool the solution, and add gradually the rectified spirit; after twenty-four hours, filter. This method obviates any necessity for an upright condenser. At first sight the borax would appear to be in excess, but the proportions given are necessary to dissolve the carmine. The solution stains well, and is sufficiently alcoholic for most purposes.

I have gone into this matter somewhat fully, for although there are many far better nuclear stains, notably hæmatoxylin and some aniline dyes, there is none as good as borax carmine for staining cellulose.

Note on a Spirit-Proof Micro-Cement.—Every one here will know the great importance of a thoroughly reliable cement for fluid mounts. All cements which become quite dry and hard in time are then also slightly porous, and allow the fluid to evaporate slowly through the pores. Asphalt, on this account, is quite useless for fluid mounts, and even Miller's caoutchouc cement can only be depended upon for a time. After a few years it becomes quite dry, and sooner or later an air bubble appears in the mount.

It is my pleasure this evening to announce the discovery of a cement which is not only reliable for objects in watery fluids, but which will also keep in permanently strong and even absolute alcohol. I do not mean to imply, however, that I have myself discovered the cement in question. I have only discovered its existence, which seems almost as great a merit, for it has been used by some for the last fifteen or sixteen years, and yet the fact of its existence has not penetrated to our Microscopical Societies in London. Dr. Dallinger's "Carpenter" recommends the periodical addition of a layer of cement to prevent its becoming quite dry, and only knows Lovett's, a very troublesome cement for spirit mounts. Mr. Bolles Lee, in his latest (1893) edition of the "Microtometist's Vade Mecum," says, in speaking of alcohol as a preservative fluid: "Not very recommendable for mounting, as if taken weak it is not a very efficient preservative, and if taken strong it attacks the cement of the mount s."

The cement which I wish to bring before you is called Clarke's Cement, and has been used by Mr. Thos. Clarke, of Birmingham, for the last sixteen years for mounting objects in methylated spirit, and his slides are quite good and sound now. I have here a slide of *Leptodorahyalina* mounted in alcohol by this gentleman in 1887, or eight years ago, and it is perfect at present. This is sufficient proof that the cement is reliable for spirit mounts, and, of course, also for all watery fluids. It is black, and used like asphalt. The diluting fluid is turpentine or benzole, both of which dissolve it very readily. It sets quickly, but takes two or three weeks to get sufficiently dry for handling the slides. It is very tenacious and never becomes quite hard and brittle. I usually fix the cover glass of fluid-cells with thickened Miller's cement, and when dry make a ring of Clarke's cement over that. Of course with alcohol mounts Miller's cement cannot be used, and the cell can be made, and must be closed with Clarke's cement alone. It is best to use the smallest oil-color sable brush, putting on the cement very gradually and little at a time. The brush can be washed out from time to time in some benzole kept for the purpose in a separate little bottle.

The composition of the cement is quite unknown to me and is a trade secret. The cement itself can be obtained from Mr. Thos. Bolton, 25 Balsall Heath Road, Birmingham.—CHAS. F. ROUSSELET, F. R. M. S., in "Journal of the Queckett Micros. Club."

Technique for the Examination of Skin Bacteria.—The important work done by Unna in the development of measures for the study of the bacteria of the skin in pathological conditions, has thrown great light upon the etiology of various dermal affections, the causes of which were formerly very obscure. Previous to the improvements made by Unna, iodine and various decolorizing solutions were employed. The method recommended by Unna is termed by him the "para rose-aniline-iodine method." The difficulty formerly experienced was in removing the iodine coloring matter without decolorizing the microbe. An advantage was found in using a mixture of aniline oil with acid pigments, instead of aniline oil alone. Unna prefers orange eoecene and picric acid. By the aid of this method it is possible to obtain and decolorize masses of dermal structures and

crusts without decolorizing the micro-organisms which they contain, so that it is possible to demonstrate the organisms *in situ*, thus showing their mode of growth, and thus to study the natural cultures of these germs. This method of investigation is particularly adapted to such diseases as eczema, psoriasis, pityriasis, versicola, eryphema, impetigo, etc.

The details of the method are as follows: Place a piece of zinc plaster upon the portion of the skin to be examined, pressing gently with the hand for a few minutes. When the plaster is removed, a portion of the diseased product will be found adhering to it, and with the various structures remaining in their normal relations to each other. A bit of plaster with the specimen adhering to it may be dried and laid aside for future examination, or may be examined at once, being first placed in a bath of benzine, by which the specimen is separated from the plaster, and, as it floats away, may be easily removed with a few particles of zinc adhering. These are removed by immersing the specimen in absolute alcohol acidulated with hydrochloric acid. When the particles of zinc have been wholly dissolved, the specimen is transferred to water, in which it swells up and becomes capable of absorbing the coloring matters.

Placing the specimen upon an object carrier, the particles are first covered with a solution of gentian violet dropped upon it with a glass rod. The gentian violet is made by adding to twenty minims of alcoholic solution of gentian violet ten minims of ammoniated lime water. In fifteen or twenty minutes the staining is completed, when the excess of fluid is removed by means of blotting-paper, and the specimen is dried.

Next apply a few drops of a solution consisting of equal parts of a five per cent solution of iodine of potash and peroxide of hydrogen for two or three minutes. Dry the section with blotting-paper, cover with an aniline mixture,—either picro-aniline or eocene-aniline, and watch the decolorizing process as it slowly progresses. At least two hours will be required to complete the decolorization; a longer time does no harm. If but a small quantity of the acid is added to the aniline mixture, the specimen may with advantage be left in the solution over night. Clear specimens are obtained in this way. Unna recommends the following formulæ:—

{	Aniline oil,	10.0
{	Picro-aniline solution,	0.001
{	Aniline oil,	10.0
{	Eocene-aniline solution,	0.201

If any part of the preparation acquires too strong a yellow or red color, this may be removed by immersion for half an hour in pure aniline.

A completely decolorized background facilitates an examination of the micro-organism. If it is desirable to examine a specimen of leucocytes, the staining should be preceded by immersion in carmine or hematoxylin solution. If a diffuse counterstain is desired, the specimen should, first of all, be immersed in an aqua solution of eocene. The eocene coloration disappears during the violet staining process, but reappears after treatment with picro-aniline or eocene-aniline solution.

This stain does not work well in crusts thicker than a visiting card. Masses thicker than this should be cut in flat sections. Sections are made by placing the air-dried crusts in a block of wood and covering with dilute celloidine. After fifteen minutes the whole is immersed in six per cent alcohol for fifteen minutes, and is then ready for cutting. The staining is then done without dissolving the celloidine.

If a leucocyte nucleus stain is first employed, the sections should be immersed for five minutes in Grubler's picro-cochineal solution, and then thoroughly rinsed in water to remove the excess of picric acid before employing the bacteria stain. Sections of hair, comedones, warts, hypertrophied skin, and all horny tissues may be examined for micro-organisms by this same method.—*Modern Medicine*.

Micro-photographic Drawings.—Unna, the eminent dermatologist of Hamburg, suggested in 1892 a method of making reproductions of micro-organisms which is much superior to the ordinary methods of either drawing or photography, combining the accuracy of the latter with the clearness and comprehensiveness of the former. The method is as follows :

From properly stained specimens negatives are made. From these negatives light prints are made in soft paper, upon which it is possible to either draw or paint without further preparation. The photographs thus obtained give only the outlines of

the object or a skeleton of the picture which it is intended to produce. By the aid of the micrometer screen of the microscope, the appearance presented in the several strata of the specimen may be easily sketched in by an artist. A more complete picture may be reproduced by the half-tone process, and thus better results obtained than are possible by either drawing or photography alone.—*Modern Medicine.*

BIOLOGICAL NOTES.

An Atlas of Nerve Cells, By M. Allen Starr, M. D., Ph.D., is in press. It is the object of this atlas to present to students and teachers of histology a series of photographs showing the appearance of the cells which form the central nervous system, as seen under the microscope. These photographs have been made possible by the use of the method of staining invented by Professor Camillo Golgi of Turin. This method has revealed many facts hitherto unknown, and has given a conception of the structure and connections of the nerve cells both novel and important. In the light of these facts, it has been necessary to discard many of the views previously taught by anatomists, and to revise some of the physiological and pathological data supposed to be fundamental.

The nervous system is now known to be composed of a vast number of independent units, called *neurons*, which consists of a cell body with two varieties of branches, called *dendrites* and *neuraxons*. The cell bodies vary in size, shape, and appearance; their dendrites, formerly known as protoplasmic processes, present great differences in form, length, and manner of subdivision; their neuraxons, formerly called axis cylinder processes, and believed to have no branches, are now known to give off many little collateral offshoots as important as the main trunk.

The arrangements of these neurons varies greatly in different parts of the nervous system. In the spinal cord they are collected into groups arranged in a long cylindrical column. In the cerebral axis they are scattered among the various nerve tracts as well as collected into separate groups. In the basal ganglia they are gathered into large masses separable into divis-

ions. In the cortex of the cerebrum and cerebellum they are spread out into thin but very extensive layers containing a great variety of cells. The inter-relations of these neurons is also a subject of importance which recent researches have demonstrated satisfactorily for the first time. The old theory that the processes of adjacent cells join together, forming everywhere a fine network of nerve fibres within the gray matter, has been discarded. For the method of Golgi has shown that each cell is an independent entity, its branches and sub-branches of both varieties preserving their identity from origin to ending, interlacing, it may be, with those of other cells, as the branches of trees in a forest may interlace, but as really distinct and separable from each other as are those trees with their twigs and leaves.

Examination of "Foul" Sea Water.—Stroke and deep inoculations were made in agar and gelatine tubes, and kept at 19–20° C., at which temperature all the following observations were made. The growths were all aerobic, being visible along the stroke in 24 hours faintly. The organisms were found to be mixed, and plate cultivations on gelatine for purposes of isolation were made in the usual way. After several transfers from plates to tubes, and from tubes to plates, isolation was effected. Two kinds were occasional, and probably adventitious. Three kinds were persistent.

The two occasional kinds were:—

1. A straight rod, motile during the first day, rapidly liquefying gelatine; soon becoming motionless, and breaking up into spores, with a putrid smell.
2. Small round organisms, motile to some extent, with a movement like Brownian movement, breaking up into spores, and liquefying gelatine rapidly, with a putrid smell.

These were not observed further.

The three persistent kinds were all rounded bodies, of which tube cultivations on agar are produced. They all liquefy gelatine slowly. The tubes are marked respectively "Star," "White," and "Yellow."

No. 1, "Star," cultivated on a plate at 19–20°.

In 24 hours showed no visible growth. In 36 hours there appeared numerous whitish spots, plainly visible under a 1 in.

glass. In two-and-a-half days the spots were visible to the naked eye, and in three days these had developed into star-shaped colonies, whitish, and so far without perceptibly liquefying the medium.

The colonies at first grow from one or two round organisms, which increase irregularly by budding. They are about 1-7000 in. in diameter, some as large as 1-5000. As soon as these are numerous enough to form a crowded cluster of perhaps 20 to 30, the colony throws out numerous arms of hyaline matter radially, and these keep on increasing in length. Along the arms appear many (say a dozen or two) nuclear spots, not at regular intervals or in regular lines, but here and there, sometimes two or more side by side, and distributed in the direction of the length of the arm. These nuclei grow into round bodies like the parent, and of the same size, then arrange themselves gradually in the direction of the length of the arm or ray, and finally, as the medium liquefies, after about five or six days, or less, separate.

Neither in the resulting nor any other liquid medium have I seen the star-shaped colony. In liquid the organisms divide irregularly by fission or external budding, and in a few hours break up into masses of minute spores. This organism is at no time motile, and except in the case of the radial processes above described, retains, as an individual, its rounded form.

No. 2 "White" } These are not visible on the plate for about
No. 3 "Yellow" } 36 hours. The colonies then appear as white
or yellow rounded (sometimes kidney-shaped) spots, which gradually increase in size. In some of them the edge is definitely marked by a surrounding ring of organisms, packed closely and regularly. In others the edge shows no such bounding ring, and is fissured. These do not break up, are not confluent, and consist of masses of extremely minute rounded bodies. On being placed in a liquid medium they multiply rapidly and irregularly.

These two kinds are so similar, except in color, and the difference in color is so slight in the earlier stages of growth, that it is not easy, especially by artificial light, to distinguish them. They are non-motile, aerobic, and liquefy gelatine but slowly.

A temporary absence during the growth on the plates when I

had at last got them separated prevented my being ready with more than the above very incomplete observations as to these last two kinds. They are now, as will be seen, well differentiated in the tubes shown, and are ready for further investigation.

The hanging drop cultures, one of each of the three kinds shown herewith, are taken from the respective tubes, and are about 24 hours old.

The media have all been slightly alkaline. Trials were made on agar and gelatine media, in which fish was used instead of meat, but without any difference in the result.—WALTER P. SHADBOLT in "Journal of the Queckett Micros. Club."

BACTERIOLOGY.

Staining Bacillus Tuberculosis in Milk.—While milk is one of the most common sources of infection in typhoid and tuberculosis, from its composition, unfortunately, it is very difficult to demonstrate the presence of these micro-organisms in any given sample. May's process of precipitation of the casein is very unsatisfactory, and in lieu thereof a writer in the *Monitore de Farmacisti* suggests saponification of the fat globules by the following process: A drop of milk is placed on a glass slip and two or three times its volume of a 1-per-cent solution of sodium carbonate is added, and the fluids mixed with the aid of a platinum wire. The slip is then cautiously held over the flame of an alcohol lamp and the liquid slowly evaporated to dryness. During the evaporation the butter particles are saponified, leaving a thin layer of dessicated soap on the slip. The subsequent treatment is identical with the usual process (staining with fuchsin, etc.). Rapid coloration with intense solutions is preferable to the slower methods.



A. CLIFFORD MERCER.

THE AMERICAN
MONTHLY
MICROSCOPICAL JOURNAL.

VOL. XVII

FEBRUARY, 1896.

No. 2.

Professor Alfred Clifford Mercer, M. D., F. R. M. S.
PRESIDENT OF THE AMERICAN MICROSCOPICAL SOCIETY.

WITH FRONTISPIECE.

It is a source of congratulation that the JOURNAL is able to present its readers with the portrait and a biographical sketch of the President of the American Microscopical Society, Professor Alfred Clifford Mercer, M. D., F. R. M. S. He was born in Syracuse, N. Y., July 5, 1855. His father, Dr. Alfred Mercer, was, so far as is known, the first physician to use the microscope professionally in central New York. The old Spencer stand with its beautiful and well preserved objectives, made about 1863, still serves its owner for the office study of pathological fluids. Thus surrounded by the microscopical influences of his father's office, enjoying the acquaintance of the famous optician, Charles A. Spencer, and Spencer's Syracuse friend, Willard Twitchell, it was only natural that very early there was awakened in the boy the keenest interest in the microscope and its revelations. In the Syracuse high school in 1874 and 1875 an added interest in this and in photography developed under the practical teaching of Dr. Walter A. Brownell. From this period may be dated Dr. Mercer's career in photo-micrography, the first apparatus being constructed by Chas. A. Spencer after Mercer's drawings. His interest in photo-micrography has never flagged and many

members of the American Microscopical Society feel under deep obligation to him for help and suggestion. He has not only used this beautiful art for scientific purposes but has made excellent use of it in demonstrating the truth of his conclusions in courts of justice.

After receiving the degree of M. D. from the Syracuse University in 1878, he spent about two and one-half years in St. Thomas Hospital and Medical School in London, England, where he was a pupil in pathology of Dr. W. S. Greenfield, now professor of pathology in the University of Edinburgh. After becoming assistant to Dr. Greenfield in the Brown Institution, Dr. Mercer cut and mounted the first sections of tuberculous joints studied in England and furnished the material described by Mr. John Croft in Vol. xxxii (1881) of the transactions of the Pathological Society of London.

While in London he became acquainted with Dr. Lionel S. Beale, and revised for him "Part V., On taking Photographs of Microscopic Objects" of his well known book, "How to work with the Microscope." On Dr. Beale's nomination he was made a fellow of the Royal Microscopical Society. He found a warm personal friend in the late Dr. John Matthews, editor of the second edition of the "Preparation and Mounting of Microscopical Objects," by Thomas Davis, and always recalls with gratitude the demonstration Mr. John E. Ingpen gave him of the Abbe diffraction theory of microscopic vision. This was before the theory had become generally known to the microscopical world.

During this period and a subsequent visit to London for professional study, Dr. Mercer had the good fortune to be brought in friendly relations with Dr. R. L. Maddox, Mr. E. M. Nelson and Mr. Andrew Pringle, England's most skillful photo-micrographers. With a mind prepared and open as was Dr. Mercer's the association with

these masters of the photo-micrographic art could only be productive of good, and our own country has been the gainer thereby, for Dr. Mercer is most generous in freely giving. To Dr. Maddox, the discoverer of the present dry plate process in photography, he is indebted for a share of the suggestive, helpful and generous correspondence with which that Nestor of photomicrography has, for many years, favored his fellow workers on both sides of the Atlantic—with its warmth of friendship and stimulus to progressive work.

On returning to Syracuse in 1880, Dr. Mercer became instructor in histology and curator in the college of medicine of the Syracuse University; in 1884 he became lecturer in pathological histology and in 1886 he was appointed professor of pathology. Several years later he resigned this professorship, but in 1894 accepted the chair of "Clinical Pediatrics" which position he now holds, together with that of treasurer of the college and several appointments in the hospitals of Syracuse. He was health officer in his native city for three years (1883-1885) and edited the first three annual reports of the local board of health. He has been active in the practice of his profession and has prepared papers which find an honored place in the medical literature of the country. He has served in various positions of honor and trust in medical societies thus showing that he possesses the esteem and confidence of his professional brethren. While he fills an honored place in the medical profession and his main energy and work lie in that direction his interests are very broad, and he has a keen appreciation of the ultimate gain to medicine of the pursuit of pure science, although the connection may seem remote to those who cannot see the invisible threads that bind all truth into a harmonious whole. He has also a keen love of nature for her own sake, and while studying for his

degree in medicine took up the microscopical study of the mosses as a part of the work of the Syracuse Botanical Club, and later was elected an honorary member of that club. During the years 1882-84 he was president of the Microscopical Club of Central New York. He is a corresponding member of the Rochester Academy of Sciences and is an active member of the Syracuse Camera Club. He became a member of the American Microscopical Society under its earlier name (American Society of Microscopists) in 1882. He has attended the majority of the annual meetings since then, often as the writer well knows at considerable inconvenience. He has furnished articles to the Journal of the Royal Microscopical Society and to photographic journals, and in nearly every volume of the proceedings of the society of which he is now president may be found one or more articles from his pen. The article in the proceedings for 1886 "Photo-micrograph *versus* Micro-photograph," furnished the information on which the definitions of the words in the Century Dictionary and in Dr. G. M. Gould's Illustrated Dictionary of Medicine are founded. The Syracuse solid watch glass for microscopical purposes designed by him finally solved the problem of a watch glass for the microscopist and there is hardly a histological or microscopical laboratory in the country that does not count these watch glasses as an indispensable part of its equipment.

From the above it is seen that the President of the American Microscopical Society has the esteem and confidence of the great Medical Profession, that his sympathies are broad, that he has been a friend and active member of the society for many years, and in entrusting him with its highest official position the society congratulates itself upon having a wise and earnest leader, a leader whose enthusiasm and willingness to work for

the Society will guarantee that there shall be no decline, but that with the efficient aid of his fellow officers and the loyal support of the members, the Society will take another upward stride this year and more fully become than ever before what it was originally designed to be—a source of help and encouragement to both beginners and advanced workers with the microscope.—S. H. G.

Cicada Septendecim its Mouth Parts and Terminal Armor.

J. D. HYATT.

NEW ROCHELLE, N. Y.

Member of the American Microscopical Society.

The long subterranean life, and regular periodic appearance of this insect, at intervals of exactly seventeen years, are characteristics in themselves so remarkable in insect life, as to render the appearance of the so-called seventeen year locust a matter of special interest, and a careful microscopical examination of the mechanism of some parts of its anatomy will reveal several features no less curious and interesting.

The fact that it has been generally known as a locust has connected it in the popular mind with the destructive insect of that name, and upon the advent of the harmless Cicada, its appearance in such immense multitudes, is sure to create in the minds of the farming people apprehensions for the safety of their crops, and fruit-trees, and some of the newspapers, whose editors and reporters are more desirous of creating a sensation than of spreading a correct knowledge of entomology, contribute not a little toward increasing the alarm by publishing hearsay, or purely fictitious, accounts of ravages done.

During the visit of the brood of 1894 some of the New York papers added a new sensation to the current reports, respecting its alleged depredations upon fruit and

forest trees, by publishing circumstantial accounts of persons "fatally poisoned by the bite and sting of the seventeen year locust."

Some eighteen years ago I became greatly interested in a study of the sting of the Honey Bee, the results of which were published in the Quarterly MICROSCOPICAL JOURNAL, and seeing these newspaper reports, I was naturally interested in making an examination of the

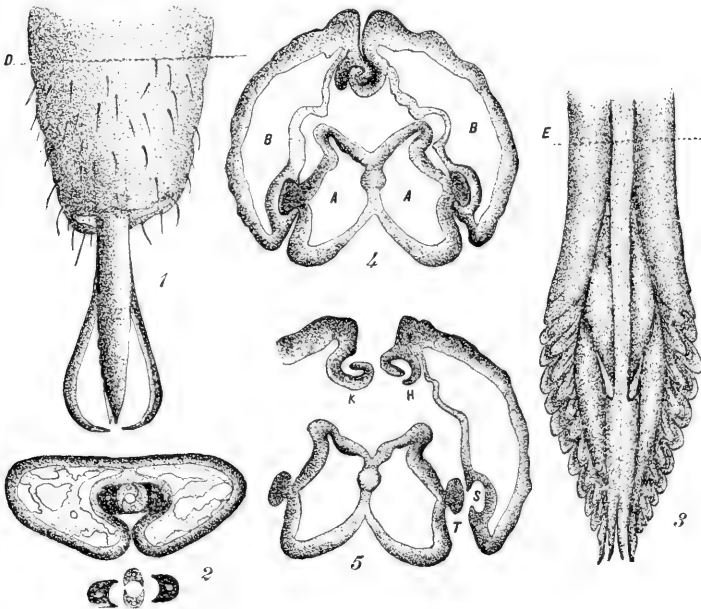

armor by means of which the Cicada accomplished such alleged fatal effects.

Cicada septendecim belongs to the natural order of insects called Hemiptera, which is not at all related to the destructive family of locusts, or grasshoppers, and its mouth parts are, in a general way, typical of the order to which it belongs, being drawn out into a long and extremely slender stylet or sucking tube, enclosed nearly to its point in the broad labium.

Figure 1 is a greatly enlarged view of the end of this labium or lip, with the projecting setæ which constitute the sucking tube, and this as may be seen consists of four pieces, the two outer ones being curved nearly to the form of hooks, while the two intermediate pieces are straight and terminate in extremely sharp points.

The two exterior pieces serve as hooks, or anchors which being inserted into the bark or leaf of a tree furnish a leverage for forcing in the two interior lancets, which together form a sucking tube through which the juices of plants, on which these insects are said to live may be drawn.

Figure 2 represents a transverse section through the abium, as at the dotted line d, in fig. 1, and shows in what curious manner the four setæ, which are grooved on the inner side, form a tube when held together by the muscular labium, which is wrapped closely around them. Sections of these four pieces as they appear when separated, are shown below in the same figure. Each of these has a minute tube through it, which would hardly seem to be of much use, considering the size of the insect, and its food requirements, for the main tube in the center is scarcely more than the one-thousandth of an inch in diameter, while the outer diameter of the whole four pieces constituting the stylet is exactly one-three-hundredth of an inch, or about the same as that of a rather fine human hair.

How much injury might possibly be done by these insects during their short lives, by sucking the juices of plants through such minute tubes is, notwithstanding their great numbers, a question, but I have never been able to discover one in the act of feeding, although I watched great numbers of them, on cherry, pear and other trees, and was equally unable to discover any injury to the fruit or foliage of such trees later in the sea-

son. In fact I think they take very little, if any, food after reaching the winged state.

The ovipositor is an instrument used by the female for making incisions in the twigs of trees in which to deposit her eggs. It is about three-tenths of an inch in length and is attached to the hinder extremity of the under side of the abdomen, and protected by lying in a longitudinal groove into which it fits like a surgical instrument in its case. It consists of three parts; two blades, furnished with saws at their extremity, where they are considerably enlarged and a central piece, called by some a sheath, but which is nearly enclosed by the two exterior saw-blades. The extremity of all three is shown in figure 3, which represents them as seen from the under, (outer) side, each saw blade carries on its inner side a tube, (oviduct), which opens on the inner side near the extremity of the saw (o, o, figure 3) by a kind of flap through which the eggs are extruded. These saws are a microscopical study, for while figure 3 fairly represents the appearance on the under side, in which view the saw-teeth are seen to consist inwardly of a row of hooks pointing in a direction opposite the extremity, and laterally of rounded teeth with extremely sharp edges directed backward, or toward the end of the saw. If examined from the opposite side, the teeth resemble those of a file, arranged obliquely and spirally from a line along the center outward over the sides. When one of the ovipositors is detached, and a lateral view is taken, the same spiral arrangement of teeth is seen, with a set of sharp hooks on the outer side pointing in an opposite direction to the knife-edged teeth seen in figure 3.

In cutting a channel for her eggs the insect closes her legs around the twig and forcing the ovipositor saws beneath the bark and into the soft sap wood, works them backwards and forwards, cutting loose but not removing

the wood fiber. In doing this the broad end of the central piece which lies between the saws causes them to spread as they are extended, so that two grooves are cut at once, lying in a v shaped direction from the entrance, and leaving a ridge of solid wood between the two. After finishing the cut, which is about three-tenths of an inch in length, she withdraws the ovipositor, and again forcing it in at the first entrance proceeds to deposit her eggs, which are placed very symmetrically in a direction oblique to the middle partition, a little cavity being cut for each egg, into which it exactly fits. The eggs are about fifteen in number in each groove, and about fifteen minutes is occupied in the whole operation.

When one set of grooves has been stocked with eggs, she moves forward about half an inch, and begins another and so continues until her whole stock of eggs is disposed of.

I have before me a branch containing twenty-one consecutive cuts, evidently made by the same insect, and holding probably, more than 600 eggs.

The extremely curious mechanism by means of which these processes are accomplished will be easily understood by inspecting figure 4, which is a transverse section of the three parts constituting the ovipositor, cut at the dotted line *e*.

The central piece, *a, a*, would seem to be a pair of tubes somewhat triangular in shape, and firmly cemented together in the middle. These cannot be separated, and the tubes have no outlet at the extremity, where the central piece ends in two, extremely hard, sharp and solid points, as seen in the figure, which no doubt serve an important purpose in cutting the channels for the eggs.

On each side are seen sections of the two ovipositors *b, b*, which are bounded on their exterior sides by a hard chitinous frame, extending for a short space up the in-

terior where it then thins out into a semi-transparent, muscular or contractile tissue, to its connection with the opposite side of the ovipositor, thus forming a tube through which the eggs are extruded.

Along each side of the middle piece extends a "T" shaped rail, better shown in figure 5, r; this figure being the same as 4 with the parts separated.

While the insect is engaged in the act of sawing, the ovipositors slide backward and forward on these T shaped rails, being held in place and guided by the central piece or so-called sheath, which as shown in section is trussed in such a manner, that it might serve as a model of rigidity combined with lightness and strength.

But the most unique feature of this beautiful piece of mechanism is shown in the pair of hooks seen in the upper part of figure 4, or more distinctly in figure 5, *h*, *k*, where they are separated. (This drawing is the same as part of figure 4 but in separating the parts on the slide they were turned over and thus reversed).

In viewing these sections there is seen an outer branch *h*, figure 5, resembling a thumb which closes over the opposing hook thus enabling it to maintain a firm hold.

These hooks, as seen in section, are of course folds along the whole length of the ovipositors which enable the insect to hold these two margins together, or at will to separate them, as it must necessarily do in cutting the two diverging grooves.

The figures here given were traced under the camera lucida, and shaded from their appearance under the microscope.

Should any amateur microscopist desire to test his skill at section-cutting, I would recommend him to try the mouth parts of a dry Cicada, and make a section that will leave all the parts in their natural position.

From what I observed during the visit of the 1894 brood

I suspect that there is a difference of habit in broods that appear in different years, or in different places.

Harris states that the female, after depositing her eggs, goes back on the branch and saws it partly off, so that the leaves die and the end of the branch breaks off and soon drops to the ground, and I have in former years seen the same thing myself, but during this visit, although the woods near this place were swarming with them, and hardly a branch of any kind of deciduous tree could be found that was not filled with eggs, no dead leaves were to be seen except upon the beech the outer branches of which were so small that the numerous cuts nearly girdled them. There were certainly no cuts made across the branches below the eggs.

Another curious circumstance connected with the appearance of these insects of which I have not seen mention made, is the most remarkable unanimity with which they came forth from their underground residences.

Is it possible that such an innumerable multitude, scattered over several square miles in extent, as in this vicinity, and living under varying conditions of food, temperature, moisture, &c., for seventeen years, should reach the mature state and undergo their last metamorphosis on almost exactly the same day, or do they have some system of underground telegraphy, or psychologic mind-reading by which there is a general understanding that all shall leave their subterranean abodes at once. Certain it is that in this neighborhood, on the 24th day of May, nobody had noticed their appearance, but on the 25th everybody knew they were here and the woods resounded with the music of their drums.

Remember the meeting of the American Microscopical Society at Pittsburg.

Fossil Marine Bacillariaceæ on Long Island, N. Y.

By ARTHUR M. EDWARDS, M. D.

NEWARK, N. J.

The occurrence of fossil marine Bacillariaceæ on Long Island, N. Y., was looked for by Diatomists for a long time. Ever since they were found at Atlantic City, N. J., by L. Woolman they have been sought for on Staten Island, N. Y., and on Martha's Vineyard, Mass., and at Coney Island, Long Island, N. Y., in vain. Three years ago I searched the sands of Coney Island and although an opening had been made to dig for the railroad, a soil was turned up which looked like the promised thing, but it was not Bacillarian. I kept a sharp lookout and whenever I could went down there from where I resided, but openings were not made through the white siliceous sand of the islands and promontories of Long Island. I visited Staten Island several times always in search for the "Infusorial earth." It is true that at a place known as Folley's on South Beach, Staten Island, N. Y., they were digging a dyke through the marsh. It was over two feet deep and I got the clay from the bottom and searched it by means of the microscope. It was Bacillarian but the forms in it were not marine enough to satisfy me. It was a grey mud and although it seemed lower than the Newark meadows, which I thought was raised coast, it did resemble the Infusorial earth I was in search of at New Haven. The blue clay from the bottom of the hollows was more promising but I placed it in the lower raised coast period, the Champlain (with a query). At Pamrapo, New York harbor, the mud was grey clay and seemed to be the same. Until this summer I have not found the fossil marine Bacillariaceæ, the "Infusorial earth," any farther North than Atlantic City, N. J. When building the tunnel that it is intended to connect Hoboken, N. J., with New York they came upon a grey

clay at thirty feet down. This was also marine but I put it in the Champlain, also. On Sunday the 11th of August, 1895, I went for an outing down to Rockaway Beach, Long Island, N. Y. I had several things in view when doing so. Of course I wanted to get away from the heat of the city and visit the sea beach. The wild rush of water on the beach had a marked reason to draw me. But more powerful than any other, the desire to search for natural phenomena was uppermost in my mind. I knew we would go by rail through the country to the beach, through the marine of the ice period and perhaps we would search the soil beneath the sand for "Infusorial earth." We sped along seeing a kettle-hole by the Lutheran cemetery that contained Bacillariaceæ but we did not stop then to gather the clay there. As we approached the station known as Brooklyn Hills we cut through high hills which I saw then and afterwards made up of moraine, steep, mostly gravel with a white clay of about three feet thickness on top. This clay I recognized as belonging to the iceberg period the same as we had in New Jersey and on Manhattan Island and which makes the bottom of the glacial clay, Lacustrine sedimentary deposits of Diatomaceæ. In this moraine I afterwards got a small, distinctly striated, boulder and near the bottom of the hill. About twelve feet from the bottom was a grey clay with Hematite nodules in it, Cretaceous clay no doubt. Then the country became flat without a hill at all, and sloping gradually down to the salt water which came into the station known as Aqueduct. Cretaceous clay underlies the country here doubtless, but covered up by glacial moraine. At Aqueduct the railroad runs out on tressels to Rockaway, which is a sandy promontory pointing to the South and makes one of the islands or promontories which line the coast from Cape Cod, Mass., to Florida. They are known in Florida as

Keys the most southern of which is Key West. I wandered South on the promontory of Rockaway, but found nothing but white siliceous sand. They were not digging anywhere that I could find. I wandered North in the direction of Far Rockaway where the land became higher and was covered by the white "iceberg clay which evidently came from the Northwest. At Auverne they had been digging a ditch on the opposite side of the promontory to the Atlantic ocean, on Jamaica Bay. The digging was over six feet deep because I who am six feet tall, could not see over the top of the ditch. They had thrown out some iceberg clay and below that some greyish clay without any stones in it. I saw at once that it was different in character from the soil in the marshes which I had learned belonged to the raised coast or Champlain period. I took some home and examined it and came to the conclusion it was perhaps Pliocene Tertiary belonging to the Neocene period. At last I had found what I wanted. We will find the Miocene if it exists there between Auverne and Aqueduct and I mean to look for it.

I cleaned some of the Pliocene clay and found the following marine forms of Bacillariaceæ and Dictyocha, which are Radiolaria, in it. Some few forms escaped me but will be found hereafter.

- Achnanthes subsessilis*, C. G. E.
- Actinocyclus ehrenbergii*, J. R.
- Actinoptychus undulatus*, C. G. E.
- Auliscus cœlatus*, J. W. B.
- " *pruinus*, J. W. B.
- " *radiatus*, J. W. B.
- Aulacodiscus germanicus*, C. G. E.
- Amphora ovalis*, F. T. K.
- Amphiprora elegans*, W. S.
- " *navicularis*, C. G. E.
- " *pulchra*, J. W. B.

- Biddulphia aurita, A. B.
 " pulchella, G.
 " rhombus, W. S.
Cerataulus radiata, J. R.
 " smithii, J. R.
 " turgida, W. S.
Coscinodiscus asteromphalus, C. G. E.
 " excentricus, C. G. E.
 " subtilus, C. G. E.
 " lineatus, C. G. E.
 " nodulorum, A. G.
 " nitidus, W. G.
Cocconeis scutellum, C. G. E.
Cyclotella striata, F. T. K.
Dieladia mitra, J. W. B.
Doryphora amphiceros, F. J. K.
Epithemia turgida, F. J. K.
 " musculus, F. T. K.
Eunotia monodon, C. G. E.
Eunotiogramma amphioxys, C. G. E.
Fragillaria pacifica, A. Z. G.
Grammatophora marina, F. T. K.
Hyalodiscus franklinii, C. G. E.
 " stelliger, J. W. B.
Isthmia enervis, C. G. E.
Melosira sulcata, C. G. E.
Navicula clathrata, A. G.
 " didyma, C. G. E.
 " elliptica, F. J. K.
 " hennedii, W. S.
 " humerosa, A. B.
 " lacustris, W. S.
 " lata, A. B.
 " peregrina, F. J. K.
 " permagna, J. W. B.
 " viridis, C. G. E.

- Nitzschia accuminata*, W. S.
 “ *balanotis*, A. G.
 “ *sigma*, F. T. K.
 “ *tryblionella*, H.
Pleurosigma angulata, W. S.
 “ *balticum*, C. G. E.
Pyxilla? *baltica*, A. G.
Pyxidicula compressa, J. W. B.
Rhabdonema arcuatum, F. J. K.
Roicosphenia curvata, F. T. K.
Scoliopleura tumida, L. R.
Schizonema foetida, J. E. S.
Stauroneis aspera, C. G. E.
 “ *birostris*, C. G. E.
Stephanopyxis appendiculata, C. G. E.
 “ *turris*, J. R.
Surirella febigeri, F. W. L.
 “ *striatula*, B. V.
Synedra affinis, F. T. K.
Terpsinoe americana, J. W. B.
Triceratium alternans, J. W. B.
 “ *favus*, C. G. E.
 “ *maculatum*, F. T. K.
 “ *punctatum*, T. B.

These are all the Bacillariaceæ that I have detected up to this time. There are several forms of *Dictyocha* a genus of *Radiolaria* present also. And what I consider a new genus of Bacillariaceæ which I have called *Ancile radiata*. It is free and found rarely in the salt water in Jamiaca Bay, Rockaway. But of this I shall speak hereafter. Mr. W. A. Terry says he has found broken fragments of a *Brunia* but this I myself have not seen, although common in a deposit which I will also describe hereafter taken at fifteen feet from the surface at Hoboken, N. J.

I, another day, visited Coney Island, N. Y., and searched for “Infusorial earth” and this time was fortunate

enough to find it at Sheephead Bay which is a village just on the Long Island side of Coney Island Creek. It was a greyish colored clay one foot underneath the sand taken at low water about eight feet from the surface of the soil.

At Canarsie Landing, which is on Jamaica Bay between Coney Island and Auverne, I did not find the "Infusorial earth" but I was there a very short time. I did find glacial phenomena and indication of the elevation of the coast but of those I shall not speak now as they are not microscopical. But the finding of the fossil marine Bacillariaceæ belonging to the Neocene period is a part. Perhaps they will be found inland on Long Island hereafter.

Radiolaria: A New Species from Barbados.

REV. FRED'K. B. CARTER.

MONTCLAIR, N. J.

Amphirrhopalum bifidum, n. sp.

Both arms equal, in the proximal part simple, in the distal part widely forked; distal end of each branch blunt (with terminal spine?). Axis of the branches straight.

Dimensions.—Radius of the arms 0.18; basal breadth 0.11; breadth of the bifurcation 0.14.

Habitat.—Fossil in the rocks of Barbadoes.

This genus has not hitherto been discovered in Barbados, the definition of which is as follows:

Porodiscida with two chambered arms, opposite in one axis, without a patagium; one arm or both forked at the distal end (Haeck.). The other known species, of which there are five, are from the Pacific and Indian Oceans.

Thus far only one specimen of the new species has been observed and that, as shown in the drawing, is im-

perfect, a branch of one of the arms having been broken off. It is a question also whether the branches are armed with terminal spines, for two of the branches lack them, and while the third shows it in the drawing, in the original the end of the branch is covered by another radiolarian form which makes it difficult to decide whether what is seen is a spine on the end of the branch

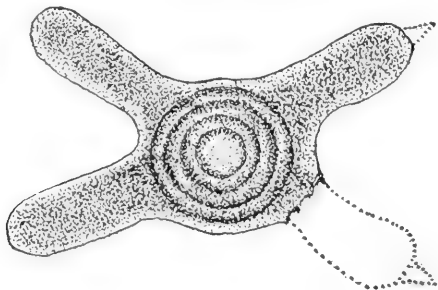

or a portion of the interior skeleton of the form which obscures it. Of all the species known this has the widest and by far the deepest fission of the two opposite arms. The finder of this form, who has thus added not only a new species to the genus but a new genus to the list of the genera from Barbados, was Dr. O. H. Hubbard of Walpole, Mass.

Radiolaria; a new Species from Barbados.

HARRY J. SUTTON,

PHILADELPHIA, PA.

Pentinastrum irregulare, n. sp.

Arms unequal; two slightly longer than the others, twice as long as broad, at their base two-fifths as broad as at their rounded distal end, which bears a terminal spine.

The diameter of the central disk is less than half the length of the arms. The angles between the arms are

unequal and filled up by an incomplete patagium, with straight or slightly rounded edges, which extends to the middle of the broadest part of the distal ends.

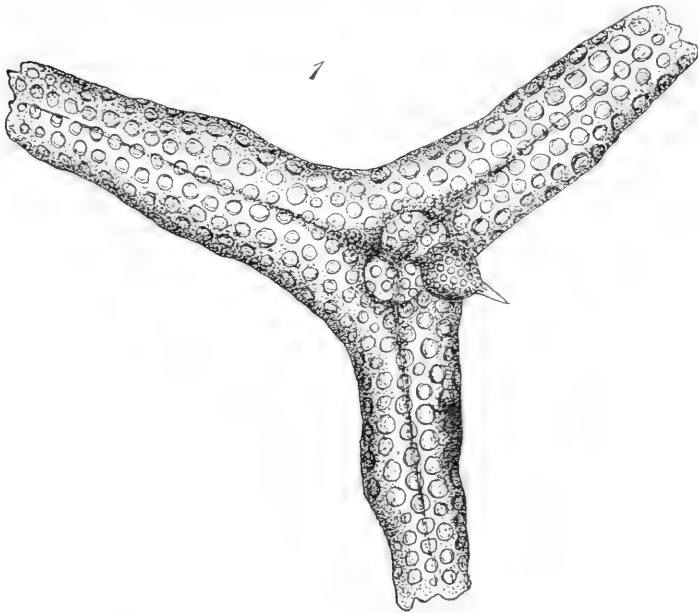

Dimensions.—Radius of longer arms (without terminal spine.)	0.15	m.m.
Breadth at their base	0.03	“
Distal breadth	0.06	“
Radius of central disk	0.03	“

Habitat.—Fossil in the rocks of Barbados.

Rhopalastrum(?) anomalum, n. sp.

Distance between paired arms about nine-tenths (9-10) as large as their distance from the odd arm. All three arms wedge-shaped, gradually diminishing in breadth from base to the distal part; odd arm somewhat larger and broader at the base than the paired arms. In place of central disk, two parallel lobes surmounted by a sec-

ond globular joint which extends between the paired arms and bears a bristle-shaped spine.

Dimensions:—

Radius of the odd arm	0.17	m m.
Radius of the paired arms	0.12	"
Basal breadth of the paired arms	0.05	"
Distal breadth	0.03	"

Habitat:—Fossil in the rocks of Barbados.

A duplicate of this form has been found by Rev. Fred. B. Carter and as his form is *identical*, it is hardly probable that the *second globular joint* could be one of the

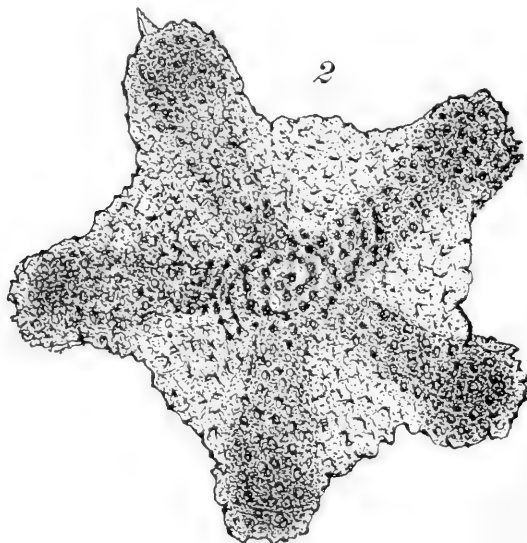

Cyrtida accidentally embedded in the shell. The presence of this appendage makes it doubtful if it belongs to the genus *Rhopalastrum*. If it does not belong to this genus, not only is the species new, but the genus, is *new* to *Barbados*.

Radiolaria; a new Genus from Barbados.

HARRY J. SUTTON.

PHILADELPHIA, PA.

Phacotriactis, n. gen.

Definition.—*Phacodiscida* with double medullary shell, and with three radial spines on the margin of the disk, placed in the equatorial plain.

Phacotriactis triangula, n. sp.

Disk triangular with smooth surface and smooth margin about three times as broad as the outer medullary shell.

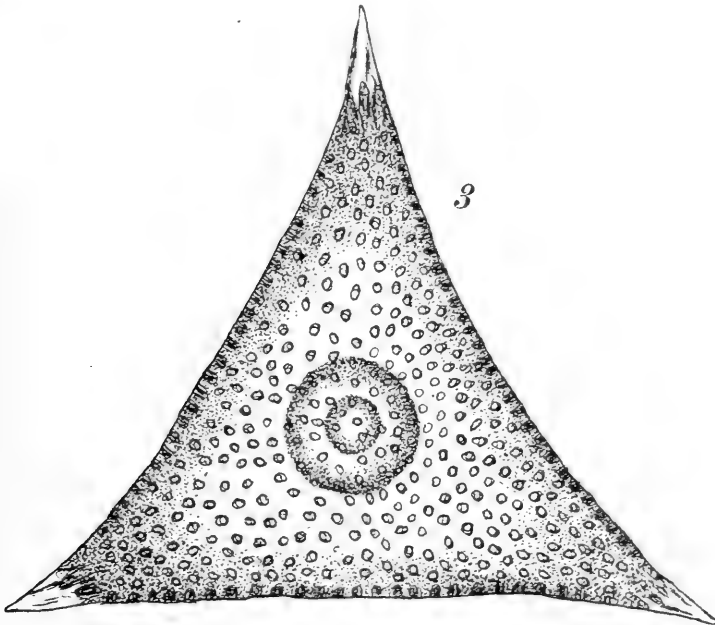

Pores irregular, circular, 22 to 24 on the diameter of the disk. Three radial spines of equal size and equidistant. Spines conical, slightly furrowed and very short, being

prolongations of the corners of the shell, which form an equilateral triangle with slightly concave sides.

Dimensions.—Diameter of disk (measured from base of spine to middle of opposite side) 0.21; of the outer medullary shell 0.06; of the inner 0.015; pores 0.005.

Habitat.—Fossil in the rocks of Barbados.

Radiolaria from Barbados: a Correction.

REV. FREDERICK B. CARTER.

MONTCLAIR, N. J.

In the description of a new species of *Pentinastrum* in the January number of the *JOURNAL* there were several typographical errors. The name of the species should be *Pentacephalum*, not *Putacephaleun*, and U. SP. should be n. sp. (new species). Whereas the patagium is said to be "complete," it should read "incomplete." And below, "regular pentagium" should be "regular pentagon."

In the dimensions, the distal breadth should be 0.06, not 0.006. And the habitat should read, Fossil "in," not "on," the rocks of Barbados.

Parrots Convey Pnuemonia.—Mention has been made of late regarding the spread in Paris of a mysterious disease which was supposed to have been communicated to human beings through some imported parrots. This disease has lately appeared at Versailles, and at Maisons Lafitte several deaths have occurred, not only among the purchasers of the contaminated birds, but among their neighbors who had been in contact with them. M. Nocard has now made experiments with the wings of birds which died during the journey from Buenos Ayres to Havre; fragments of the humeral medulla were placed in a cultivation medium. The next day he detected the presence of a virulent microbe. Fowls, mice, guinea-pigs, and rabbits inoculated with the microbe died in less than forty-eight hours. A parrot was infected and died from the contamination of wings placed in his cage.—*Science Siftings.*

A New Method of Making and Finishing Wax-Cells.

M. PFLAUM,

PITTSBURGH, PA.

Member of the American Microscopical Society.

After several years' testing, the following described method of making wax-cells has answered every demand, whether for fluid or dry mounting.

So that the wax better adhere, a ring of asphalt (in benzole) cement, wider than the intended ring, is first drawn upon the slide. It is best to have such ringed slides in stock so that the asphalt has thoroughly set and seasoned. A mixture of wax and paraffin, in equal parts, is obtained by melting to a boil, and with it, upon the turn table, a cell drawn of whatever depth required, and immediately well covered with the asphalt cement, with special care to cover the inner and outer edges nearest the glass, so that the wax is enclosed on all sides by the cement. The paraffin hardening the wax, and the wax making the paraffin less brittle, make together a cell which will resist any change of temperature; the asphalt is used as an additional precaution in that direction.

Such cells, of various depths, should be kept on hand for thorough drying, the longer the better, to guard against any possible shrinkage; for which, however, there is in this cell very little danger. For mounting, whether dry or fluid, the crest of the cell should be covered with a very thin ring of the same mixture of wax and paraffin, and the cover-glass firmly pressed down on it. Mounts in such cells, with glycerin as a medium, have proved of easy manipulation and in every respect satisfactory.

After the cover-glass is in position, the following method of finishing the slide is recommended.

As the wax-cell has been enclosed with a benzole cement, the cover-glass should be fastened with a cement

having a different solvent. Shellac (in alcohol) serves this purpose best. This would finish the slide. If, however, it is desired to make the slide still more permanent, as an object of beauty, the following described process will well repay the additional labor. After the shellac has well dried, put on a ring of zinc-white cement entirely enclosing the shellac, and, within a few minutes, before the zinc has fully set, ring it with any color of King's lacquer (I have tried no others) in any manner taste might direct. The lacquer unites with the zinc, and gives it the appearance of porcelain. Around the cover-glass, and around the cell on the slide, draw a ring of bronze paint. This will hide any defects in ringing and give the slide a very handsome appearance, with, after some practice, really little extra work.

EDITORIAL.

A Monument Proposed to Robert B. Tolles.—If we mistake not, an effort was made a few years ago by Microscopists to collect some money for a monument but without much success. Much more recently a movement was started by Mr. Bohne in New Orleans but was shortly transferred to Boston as being a more suitable point from which to communicate with those interested. At the September meeting of the New England Association of Opticians, a committee which had been previously appointed, reported in favor of the project. After a discussion, the recommendations of the committee were adopted and in accordance therewith a permanent committee consisting of Messrs. A. G. Barber, A. G. McKenzie, B. V. Howe, E. G. Worthley and W. J. Donovan was appointed to correspond with Opticians, Medical Practitioners, Microscopical Societies and Optical Journals in the United States in the hope of receiving subscriptions. A small number of subscriptions were taken at the same meeting.

As expressing the sense of the association it was voted "That it is the sense of the New England Association of Opticians,

that proper recognition ought to be made of the services of Robert B. Tolles in the interest of optics and that a worthy monument be erected to his memory by the Optical Fraternity not only of New England but throughout the country and that as an association and as individuals we pledge our assistance and support." It was hoped that all opticians would join in this effort to erect a suitable monument over the grave in Mount Auburn Cemetery which is as yet unmarked by even a headstone.

Having received a subscription blank from the treasurer, Mr. B. V. Howe, of 106 Tremont street, Boston, we opened communi-



cation with him and in reply he says: "I am very much pleased to learn that you take such interest in the matter. We are now considering the advisability of approaching the microscopists in a general way. Mr. Chas. X. Dalton who is the successor of Mr. Tolles in the optical business has issued circulars of appeal to many of his acquaintance in the Boston Microscopical Society."

Dr. Ephraim Cutter of New York has also distributed circulars among his acquaintances. He has offered to give a lecture in the town where Mr. Tolles was born in order to assist the project. He also is willing to lecture in Boston and exhibit the 1-75th objective. It is not supposed that money enough

to build the monument will be immediately forthcoming. The committee think that their patience will last for several years if necessary. About 140 dollars are now in hand.

We shall be pleased to hear from the microscopists regarding the matter and we sincerely trust that they will wish to participate in the memorial.

MICROSCOPICAL APPARATUS.

W. Watson & Sons' New "Parachromatic" Substage Condenser.—This condenser has a total aperture of 1.0 N. A. and has an extremely large Aplanatic Aperture, exceeding .90 N. A. Its power is 2.7 in. and with the front lens removed 4-10 in. It is mounted with Iris Diaphragm and Revolving Carrier for Stops for dark ground and oblique illumination. The Iris Diaphragm is divided so as to indicate the N. A. at which the condenser is employed. The diameter of the back lens is 5-8 in. Price complete \$18.75.

Aplanatic Magnifiers.—In addition to W. Watson & Sons' well known regular series they are making Mr. E. M. Nelson's new form, magnifying 15 diameters, which gives great working distance and large aperture. It is believed to be unequalled by any similar lens for working qualities. The price in German Silver mount pocket form is \$3.87. For dissecting, in wooden box the price is \$3.62.

BIOLOGICAL NOTES.

Objections to the Cell Theory.—Adam Sedgwick some time ago published a paper in the *Quarterly Journal of Microscopical Science*, in which he called attention to the apparent inadequacy of the cell theory, and recent criticism of his position in the matter has induced him to state it more fully in the same publication. He holds with Sachs and others that the phenomenon of cell formation is not of primary significance, but "merely one of the numerous expressions of the formative forces which reside in all matter." The cell theory asserts that the Metazoa are aggregations or colonies of individuals called cells, and de-

rived from a single primitive individual—the ovum—by successive cell divisions ; that the meaning of this mode of origin is given by the evolution theory and that the development of the higher animals is a recapitulation of the development of the race. Mr. Sedgwick's work, however, has led him to doubt the validity of this view of the Metazoon body, and he is inclined to attribute a number of errors in descriptions of embryonic processes to the dominating influence of the cell theory in its modern form. A theory which leads to obvious errors must, he thinks, be wrong, but he has not yet arrived at conclusions which enable him to formulate any satisfactory alternative hypothesis with regard to the meaning of the predominance of the structure called cellular.

In reference to this matter it is pointed out in *Natural Science* that, in the older botanical text books, the plant unit is the "cell"—a cellulose chamber inclosing protoplasm and cell sap—an aggregation of such cells forming a tissue. According to modern ideas, however, the unit is a mass of protoplasm in which is embedded a nucleus. This unit or "energid" is the starting point of every plant. It may grow and divide repeatedly without the separation of the resulting daughter units by partition walls, a large number of nuclei being embedded in a general mass of protoplasm contained within a common membrane, as in *Vaucheria* and *Mucor*. In *Cladophora*, again, incomplete septation is illustrated, and where the completely septate form prevails, the protoplasmic units, though separated, are probably not isolated by the cell walls. The cell has come to be regarded, then, as a mere inclosure of the protoplasm, necessitated by increase in size, differentiation and need for support. Modern attention is being more and more concentrated upon the nucleus. Thus, whereas Weismann originally spoke of "germ cells," he now speaks of "germ plasma," meaning by that nuclear matter ; and the continuation of the germ plasma means for him the continuity of nuclear matter, rather than the existence of a chain of cell division, of which the successive generations are pendants. Indeed, recent work generally seems to support Mr. Sedgwick "in attaching little importance to the frequent division of protoplasm into areas round nuclei, but increasing importance to the presence in so-called multi-cellular organisms of localized foci which multiply by division."—*Am. Druggist*.

The Microscopic Examination of Opium.—Dr. Mjoen (Ann. de Pharm. and B. and C. D.) has examined 60 samples of opium from the collections in the Pharmaceutical Institutes at Berne and Vienna. From a consideration of his results, he states that the microscope gives the means of determining the origin of the opium as far as Asia Minor, Persia or India are concerned. He gives the following characteristics of the various groups :

- | | | | |
|--|---|---|------------------|
| 1. Containing cellular debris of the epidermis of the pericarp of the fruit..... | } | Smyrna.
Constantinople.
Salonica.
Cleremont. | |
| No starch present..... | | | |
| 2. Complete absence of such epidermal debris | } | Persia. | |
| Much starch present | | | |
| • Absence of the epidermal debris..... | } | Malwa
Patna
Benares
Punjaub. | } Indian Opiums. |
| No starch present..... | | | |

Dietrich has examined 43 samples from the Institute at Vienna, with the following results :

- | | | |
|--------|------|---------------------------|
| 1..... | 9.0 | ..13.0 per cent morphine. |
| 2..... | 4.0 | .. 6.0 per cent morphine. |
| 3..... | 0.45 | ..14.4 per cent morphine. |

BACTERIOLOGY.

Ripening of Cheese.—Winkler has made some very careful studies of Duclaux's species of *Tyrothrix*. He concludes that it is probable that peptonizing bacteria are the chief factors in the ripening of cheese, but in hard cheese lactic acid species are always more abundant. A probable explanation of this is that possibly peptonizing bacteria in cheese are changed from peptonizing to lactic acid, e. g., they have the power of developing lactic acid in a stronger degree. Some of the species of *Tyrothrix* (*T. tenuis*) resemble potato bacillus. All are more or less peptonizing in milk. Butyric acid is only produced by a few. Milk sugar favors growth in most, but it appears to retard peptonizing. Duclaux's specie of *Tyrothrix* are bacilli, often attaining considerable length, produce spores very readily and these can only be destroyed by heating for a short time between 100–150° C. The paper is accompanied by two fine plates. (Centralblatt f. Bakt. u. Parasiten Runde, Zweite Abth. I. 618, 657).

Growth of Bacteria at Low Temperature.—It is a well known fact that many bacteria will retain their vitality at comparatively low temperatures. Havemann however finds that a number of micro-organisms are capable of growing at 7° C. Complete cessation of growth at this temperature occurs in Typhoid fever bacillus, *Streptococcus Erysipelatis*, and *Spirillum cholera Asiaticae*. A number of organisms in the soil are capable of growing at 0° C (Centralblatt f. Bakt. u. Parasiten Runde, XVIII, 497.)

Antitoxin Treatment.—Experiments with diphtheria antitoxins in both Europe and America continue to show favorable results. Dr. Paquin has announced favorable results in treating tuberculosis with antitoxin. Mr. Roger (Centralblatt f. Bakt. u. Parasiten Runde, XVIII, 637) has obtained most satisfactory results in treating patients suffering with puerperal fever and erysipelas by using streptococcus serum. Decided improvements occurred in patients a few hours after injection. Klemperer and Levy express themselves highly satisfied in the treatment of typhoid fever with a serum obtained from a dog, this animal showing a large amount of natural immunity. The dog received large amount of virulent culture and thus increased the potency of the serum. Experiments with guinea pigs and mice indicated favorable results. In doses of 5 ccm. one author's showed no indications of poisoning. Five cases of typhoid fever were treated, the patients receiving 60 ccm. injected subcutaneously. All followed a mild course and recovered. Treatment was made during the first week of the disease. (Centralblatt f. Bakt. u. Parasiten Runde, XVIII, p. 148.)

MEDICAL MICROSCOPY.

The Microscopic Diagnosis of Diphtheria by a New Staining-Method.—Dr. H. C. Crouch of Denver, Colo., says that diphtheria bacilli, as seen in preparations from cultures, vary in size, the larger ones particularly presenting characteristic features in the way of club-shaped ends and irregular staining, but all forms showing a tendency to the alteration of deeply and lightly stained portions. In addition to this, and distinct

from it, are certain round or oval bodies which may be made apparent by certain methods, the existence of which was brought to our attention by Babes, Neisser and Ernst. The method pursued by the last was to stain strongly with hot methylene blue, and follow with bismarck-brown. These bodies would be blue, the rest of the bacillus being brown. Dr. Crouch had been investigating the feasibility of employing this peculiarity of the diphtheria-bacillus to differentiate it from other bacilli found in the mouth, and with a degree of success beyond expectation. He had found, likewise, simpler methods of staining and peculiarities that he believed to have escaped attention hitherto.

If a fresh serum-culture is stained momentarily with a one per cent solution of methyl-green, it is often possible to bring out these bodies without further treatment. Treated thus they present the appearance of reddish granules in a faintly green bacillus, usually one at each end. By staining with methyl-green more strongly and following with methylene-blue, bacillus with red dots resembling spores will be seen. These bodies have apparently a peculiar affinity for methyl-green, with which they enter into a chemical combination, resulting in change of color from green to red. Dr. Crouch had consequently employed methyl-green for their detection. By adding other colors the penetration of the methyl-green may be increased, and a double stain obtained immediately. Dahlia had been found most useful, employed in the following proportions: One part of one per cent dahlia in water, five parts one per cent methyl-green, and four parts water. If either color predominates in the stain too decidedly the other color is cautiously added until the desired result, as tested on the bacilli from a culture, is obtained.

The stain works instantaneously, and if too deep the effect is not obtained. In such a case the cover-glass may be treated quickly with bismarck-brown, which replaces the dahlia in the body of the bacillus, leaving the bodies described standing out in contrast. Dr. Crouch had tested this method in a large number of cases during the last six or eight months, and had never failed to find the result of the culture positive when he found these forms present in the cover-glass examination. In one case in which he had diagnosticated diphtheria the first cul-

ture was unsuccessful, but the second culture confirmed the diagnosis, which fact seemed to indicate that the direct examination should always have its place in addition to the culture.

These bodies are not considered to have any connection with spores, in spite of their superficial resemblance. They are found in the greatest numbers in young, freshly growing cultures and are much less abundant in older cultures. They may be readily detected in cultures only a few hours old, and thus made use of to confirm a diagnosis earlier than the full development of the culture. That they are not degenerative forms is evident from the same considerations. Dr. Crouch inclines to attribute a nuclear nature to them, and proposes the name nucleoid bodies. They are evidently connected with the active growth and are absent in the resting-forms, suggesting thus the resemblance with indirect cell-division. Being particularly abundant during the earlier and more rapid growth, they are readily found in the earlier stages of the disease, and from the ease with which they may be brought out, they acquire a very great practical importance in the microscopic diagnosis of diphtheria.—*American Druggist*.

MICROSCOPICAL SOCIETIES.

Queckett Microscopical Club.—The 328th ordinary meeting of this club was held on Friday, Jan. 17th, at 20 Hanover-square, W., Mr. E. M. Nelson, F. R. M. S., president, in the chair. The minutes of the preceding meeting were read and confirmed, and other formal business gone through. The Secretary gave notice of a proposed revision of Rule 7, which would be submitted at the next annual general meeting. The list of nominations for president and officers for the ensuing year, as made by the committee, was read as follow:—President, Mr. J. G. Waller, F. S. A.; vice-presidents, Mr. Nelson, F. R. M. S., Dr. Dallinger, F. R. S., Mr. Michael, Pres. R. M. S., Mr. E. T. Newton, F. R. S. The other officers as before, and as auditors of accounts, Messrs. W. I. Chapman and J. Mason Allen. To fill four vacancies on the committee, Messrs. Hem-bry, Ingpen, Western, and Scourfield were nominated by the members.

Mr. T. Charters White gave an exhibition with the lantern of a large number of photographic slides, taken by himself, and including a wide range of subjects. At its conclusion, a very cordial vote of thanks was passed to Mr. White for his display.

The usual announcements were then made, and the proceedings terminated. The annual meeting for the elections, president's address, and other business will be held on Friday, Feb. 21st.

LETTERS TO THE EDITOR.

The Robert B. Tolles Monument.—The New England Association of Opticians has appointed a committee with the view to having a petrous memorial erected to Robert B. Tolles. He lies buried at Mount Auburn, Cambridge, Mass., monumentless. The committee thinks that \$500.00 will suffice. \$150.00 have been subscribed. Small donations of \$1.00 are acceptable.

In their opinion, a man who so honored as optician, his profession, his birth place, his country and his age, deserves a remembrancer which shall serve as a stimulus to those who come after him, to go and do likewise. It is desired to respectfully call the attention of microscopists in their associated and individual capacities to co-operate in this worthy work. If thought advisable microscopical soirees might be held to collect funds for the Tolles monument. Knowledge which can be acquired in no other way can be imparted and made to yield an equivalent for this purpose.

Increased interest can be excited in the instruments of precision which are the delightful and inspiring means whereby human beings become more intimately acquainted with the surprisingly beautiful environments which the creator has placed around them. These efforts may do something to hasten the time when microscopes shall become as common as pianos and organs. The microscope is as much an instrument of eye music as pianos are of ear music. Such a soiree is now contemplated to be held in Boston.

I write by request of the Committee, whose treasurer is Mr. B. V. Howe, 106 Tremont street, Boston. Ephraim Cutter,
120 Broadway, New York, Feb. 24th, 1896.

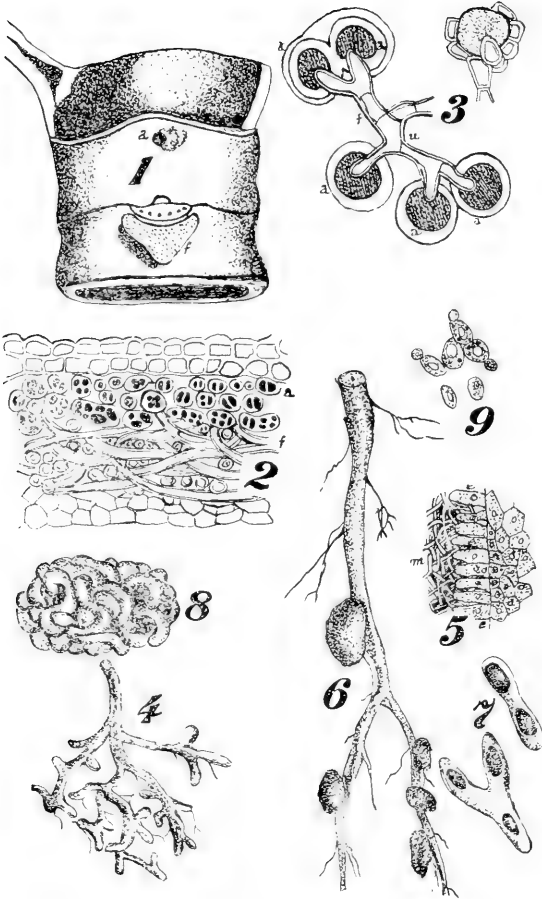

SYMBIOSIS: OR. PARTNERSHIPS IN PLANT LIFE.

THE AMERICAN MONTHLY MICROSCOPICAL JOURNAL.

VOL. XVII.

MARCH, 1896.

No. 3.

Symbiosis: or, Partnerships in Plant-Life.

BY PROFESSOR WEISS.

WITH FRONTISPIECE.

From Proceedings Manchester Microscopical Society.

So much has been said and written about the keen competition of plants and animals in the great struggle for existence that we are apt to picture the organic world as a huge battlefield in which each individual is waging war against the rest of the organic world. There is no doubt some truth in such a view as this, still it represents anything but the whole truth. The struggle for existence, we are told, grows more and more pronounced the closer allied the organisms are. In animals of the same species therefore, competition should be most pronounced; yet that is not always the case, for we find that many species are of gregarious habit, a habit which would be detrimental where struggle for existence is

LIST OF ILLUSTRATIONS.

- | | |
|---|---|
| (1) Portion of stem of <i>Cecropia</i> showing hollow stem which is inhabited by ants, and aperture (<i>a</i>) through which they make their entrance, (<i>f</i>) triangular patch bearing the food bodies. | (4) Root of a tree affected by a micorhiza, and thus curiously altered in shape. |
| (2) Section of a lichen showing the algal cells (<i>a</i>) which are surrounded by the threads of the fungus (<i>f</i>). | (5) Threads of micorhiza (<i>m</i>) making their way in between the epidermis cells (<i>c</i>) of a root. |
| (3) Fungal threads of a lichen (<i>f</i>) capturing algal cells (<i>a</i>) for the formation of a new lichen-cell. | (6) Root of a leguminous plant with root tubercules. |
| (2 and 3) After Sachs. | (7) Bacteroids from a root-tubercle. |
| | (8) Bacterium vermiforme of the ginger-beer plant. |
| | (9) <i>Saccharomyces pyriformis</i> of the ginger-beer plant. |

very keen. We know of instances in almost every group of animals, where some dominating instinct will keep animals together in thousands and even millions, although separately they would have much more chance of obtaining their proper food supply. I need only remind you for a moment of the flights of locusts, the shoals of herrings and mackerels, and the armies of lemmings travelling enormous distances in search of food.

Again, in others the instinct of preservation of the species seems to be stronger than the instinct of self-preservation, and we find communities organized, chiefly among the insects; here the life of the individual is sunk in favor of the life of the community, and, as in the case of the bees, the workers will toil and die in the service of their queen. But indeed in all gregarious animals the instinct of mutual aid is often developed out of the instinct of self-preservation, for they have learnt that united they stand while divided they fall, and so danger is often averted by a combined assault on the enemy.

Such instincts, however, we cannot look for in the unreasoning vegetable kingdom, or even in the lower classes of the animals in which no central nervous system has as yet been evolved, and still some most remarkable instances of collective life are found in some of these groups. What for instance are we to think of the apparent unity of impulse and life of such a compound Ascidian as *Pyrosoma*, or of a polyzoon like *Cristatella*, and finally how are we to look upon a compound hydrozoon like *Physophora*, in which each individual or person has a different function assigned to it? Must we look upon these as single individuals, or as a number associated together as it were in partnership, sharing the profits made by the whole number?

Partnerships they may be called, but the partnerships which I wish to speak about are of a different nature, for

they are partnerships formed, not between individuals of the same species as in the cases previously mentioned, but between organisms of the most diverse kinds associated together for defensive or profit-sharing purposes.

In the animal kingdom one of the most remarkable, and perhaps the best known example, is the association of a sea-anemone with a hermit-crab, a defensive alliance of as great an importance as the Triple Alliance itself.

The hermit-crab (*Pagurus striatus*) carries generally on its back, or rather on the whelk-shell which it inhabits, three or four large anemones (*Adamsia rondeletii*). It would seem at first a great kindness on the part of the crab to carry about these bulky and helpless individuals, but the soft-bodied hermit-crab is very glad of an additional protection to the old whelk-shell, and the anemones, though so soft-bodied and apparently defenceless, are provided with most formidable organs of defence, in the form of stinging-cells, with which they, like the jelly-fish, keep most foes at bay, and when located on the back of the hermit's shell they serve to keep its enemies too at a distance. In return for this service the anemone receives a distinct benefit in being taken about to new feeding grounds, and, as it is exceedingly voracious, it is delighted to be carried in search of its prey. So both parties are pleased; the hermit-crab to so great an extent that, when it moves into a larger shell, it carefully detaches, by gentle and persuasive pressure of its claws, the sea-anemone from the old shell and plants it on the new abode.

Here then we have a partnership between two individuals of the animal world, a partnership which is of very common occurrence. It will seem perhaps strange to you to imagine such a defensive league formed between a plant and an animal, and yet a number of such associations are known.

Take, for instance, the large group of myrmecophilous, that is, ant-loving plants. Here we find bushes and trees harboring armies of ants, which they not only feed with nectar secreted by various organs, but which they house in convenient cavities within their tissues. In the curious trumpet-tree of the West Indies and tropical America (*Cecropia adenopus*) each hollow node of the stem forms a chamber in which a number of these honey-loving ants make their nest, a small aperture at the side of the tree giving them free access to this chamber. This aperture, however, is not formed by the plant, it is only indicated to the ants by a slight depression, a special thin portion of the wall, through which the ants eat their way into the hollow stem. Thus the plant is preserved from giving shelter to insects which might misuse the hospitality of the plant. The honey-loving ants alone are taught by some curious "instinct" that a chamber exists for their reception, and thence they make their way. (Fig. 1.)

At the base of the leaf-stalk will be seen a curious triangular fleshy-looking patch, which is found to produce numberless small food-containing bodies, which are, in fact, the inducement held out to the ants to take up their residence in the hollows of the tree. At first sight it would seem as if all the advantages to be gained were on the side of the ants, and we are inclined to ask, what advantage can there be to the tree to entertain and feed these armies of insects? We look eagerly for some advantage, for we have been taught by all our observations that in plants at least there is no spark of altruism, and that whatever they do they do with a view to benefiting themselves. It was the careful observations of Belt and Fritz Müller on the living trees which led to the solution of this curious problem. It is well known that in tropical countries the leaf-eating ants are per-

haps the greatest scourge to vegetation, and an army of these will destroy in a single night the entire foliage of a tree. Now any such attack upon a trumpet-tree rouses, not only the anger of the honey-eating ants which are being fed at its expense, but calls forth their instinct of self-preservation, for upon the welfare of their host plant depends their own life. Hence they constitute themselves a defending force, and in the fight between the two armies of ants which ensues, they are generally victorious, perhaps because they are fighting for house and home, while the intruders have only come for plunder.

The mutual advantage then is clearly established by the observation of these spirited encounters, and we have here an explanation for many of those nectaries which are found, not inside the flowers, but on leaves and leaf-stalks, and have hence been termed extra-floral nectaries.

But the trumpet-tree is not the only tree supplied with ants; many acacias allow ants to make their home in their hollow spines, which are found at the base of the leaf, and are indeed the transformed stipules of those leaves. *Myrmecodia* again has the lower portion of its stem curiously swollen up, and in this dilated portion run large and intricate galleries, which are peopled with ants, enticed into these chambers and fed by the plant.

Then we have curious instances in which, for a time at least, plants will give protection and food to an animal for some benefit derived from it, not in the form of protection from attacks, but usually by securing the fertilisation of its ovules. Fertilisation of plants by the agency of insects takes place to a large extent; the pollen of one flower is carried by insects, such as bees and moths, to the stigma of another flower, which is then said to be pollinated, and further changes in the pollen-grain lead to the fertilisation of the ovules contained within the ovary. It is for the purpose of attracting these insect-

agents of fertilisation that the plants lay themselves out to produce conspicuously-brilliant or sweetly-smelling flowers indicative of the honey which the insects will find there. In some few cases, however, the plants do not merely attract the passing insects, but they will give them temporary lodging, allowing indeed the eggs to hatch and the larvæ to develop within their ovary. These instances we must look upon as temporary symbiosis.

This is the case in the barren fig (*Caprificus*), in which a species of wasp habitually lays its eggs in the ovaries of the female flowers, which are situated at the base of a flask-shaped receptacle. In these infected ovaries the eggs are hatched, and the larvæ feed on the developing ovules, which, however, are killed by them. When the insect is fully developed and has attained the wing-bearing stage, it leaves the flask-shaped receptacle, but not without carrying away some pollen from the male flowers, which are situated near the mouth of the flask, and with which they fertilise the flowers of the next. So for the sake of some ovaries bearing fruit the others are sacrificed, and the mutual benefit satisfies the partners.

In the edible fig no such breeding of wasps can take place, as the ovaries are better protected, and resist the attacks of the mother wasp. How then are their flowers fertilized? They cannot fertilize themselves, for the male and female flowers ripen at different times. Formerly it was thought that some mysterious influence passed from the barren fig to the edible fig, and hence branches of the former were hung up on the ordinary fig trees, an act which was termed caprification.

Now, however, we know that this mysterious influence is none other than the passage of wasps from the barren fig carrying pollen to the edible fig with intent to lay

their eggs in its ovaries, which intention is frustrated by the resistance of the ovary wall.

A more curious instance still is that of the fertilisation of the flower of the *Yucca*, a large liliaceous plant by a small moth *Yuccasella*. This moth first lays some two or three eggs in the ovary of a flower, and then, with a special pretensile organ carried under its proboscis, fetches some pollen from the anthers and plasters it on the sticky stigma. The result is that the ovules are fertilised and increase rapidly in size, serving as food for the young larvæ. About twenty or more such ovules will be devoured, but as about 200 will ripen in all it is obvious that the plant is not by any means a loser by this transaction, and that ensuring fertilisation with the loss of a few ovules is better than risking the chances of not being fertilised at all.

Now let us turn for a moment from partnerships in which plants are the chief or sleeping partners and animals are the working partners, to a few instances in which the animal is chief partner, or practically the employer, giving to the plant protection, and perhaps also a small amount of wages for work done.

Most of you will know the fresh-water sponge, *Spongilla*, or perhaps even more may have seen the fresh-water polyp (*Hydra viridis*). Now both the fresh water sponge and the fresh-water polyp are colored green, not the same animal green color you find in the parrot's feathers for instance, but a color of the same nature as that which you find in trees and grass, and which has been called chlorophyll or leaf-green. Now there is no reason whatever why animals should not possess this color, which is so useful to plants and enables them to live, so to speak, on air, that is to assimilate the carbon contained in the air; but I will not here enter into a discussion on this point, nor dispute the right of *Euglena*,

Protooccus, or Volvox being considered as animals, but I will maintain, and I take my stand on the observations of very eminent botanists, that both in Spongilla and Hydra the green color which is present, is due to the symbiosis of small green algæ with the sponge and polyp in question. In these two animals the green color is contained in the form of round green corpuscles. These green bodies were formerly looked upon as equivalent to the chlorophyll corpuscles of the flowering plants; but it has recently been shown that they are surrounded by a vegetable cell wall, and finally Beyerinck was able after overcoming many difficulties, to cultivate them independently, and has thus proved that they are in fact small green algæ (to which he has given the name of Zoochlorella) living within the cells of the sponge or polyp. The advantage to the animal is obvious. The small algæ are able to form starch and hence sugar from the carbonic acid dissolved in the water, and this we know can transfuse through the cell wall of the algæ into the animal body.

The only advantage that can apparently accrue to the algæ is the fixity of abode, an advantage one would not have considered very important to so small a plant which has so many free living allies. We cannot, however, at present, fathom all the desires of these small unicellular plants.

In the case of some Turbellarians, according to Hanstein, the Zoochlorellæ have undergone a degeneration and have lost their cell wall, so that they are now quite dependent on the animal and cannot be cultivated independently.

A perfectly similar case to the occurrence of green algæ in Spongilla and Hydra we find if we leave the animal kingdom out of consideration altogether, and this points to the fact that these small green algæ lend themselves very readily to such partnerships, or are very willing to

do assimilatory work if they can insure a comfortable and secure abode.

You all, I am sure, know that group of plants to which the name of lichens is given. Many of them form flat growths of various colors, covering rocks and tree trunks, others hang in festoons from the dead branches of firs, or form coral or moss-like growths upon the ground. The so-called cup moss, for instance, has really no affinities at all with mosses, but is a true lichen. But what then is a true lichen? Well a lichen is really a firm or partnership consisting of the working partner in the form of a green alga and a sleeping partner, who protects the alga by surrounding it with innumerable threads or hyphæ, and these hyphæ tell us that this second portion is of the nature of a fungus.

That, indeed, is the case, and in a section taken through a portion of a lichen you will see the green algal cells lying imbedded in a mass of threads cut through in all directions, and representing the filaments or hyphæ as they are called of the fungus. (Fig. 2). A fungus, as you see, is devoid of the green color or chlorophyll—the chlorophyll which enables all green plants to take a large amount of their nourishment—all the carbon they need in fact, from the atmosphere, and to build up with its help starch, which forms the starting point of other organic substances. Fungi therefore are unable to do this, and hence they lead either a saprophytic life, living on decaying organic matter, or a parastic life, preying on living animals or plants.

In the group of the lichens however the fungus cannot actually be said to have taken to either of these forms of life. Here though the fungus makes use of the starch and sugar formed by the green algal cells, it does not in any way damage or destroy the alga, but lives peaceably together with it, fostering it in fact, for its

own existence depends on the welfare of the alga. The alga is not so completely overgrown as to keep out the light, which would of course render it perfectly useless, but is kept well lighted and is allowed to grow and multiply, so that the fungus too may increase in size.

I have no doubt some of you will ridicule the idea of calling this arrangement a partnership, especially as it is known that many of the different forms of algæ which are constituents of various lichens can perfectly well lead an independent existence, and the advantage from the protection of the fungus would therefore seem to be a myth. Many might prefer to look upon the fungus as a tyrannical employer of labor, crushing the independence of the working algæ, and binding them, not with protective filaments, but with despotic chains.

When reproductive cells are produced by such a fungus they capture their working partners, or shall we call them their slaves, by throwing out filaments, which finally entirely enclose the algal cells. (Fig. 3.) This is the beginning of the symbiosis, but once started the fungus generally takes care that it shall continue. Thus when the lichen gives off its vegetative spores it practically surrounds a few algal cells with hyphæ and rounds the whole off into a spherical mass called a soredium, the enormous quantities of which in some lichens cover the growth with a powdery-looking substance.

Let us now take another case of symbiosis between a green plant and fungus. If you were to examine the rootlets of almost any of our trees, such as the oak or the beech, you would find them clothed in many places with a mass of white or glistening hyphæ, so thickly surrounded in fact that the hyphæ form a dense felt-work completely covering the rootlets, which usually become short and thick and tend to branch considerably. (Fig.

4.) To this mass of hyphæ the name of mycorrhiza was given, and it was looked upon first as a parasite and then as a symbiotic fungus. Let us now look carefully at the conditions of growth and we shall then see that we are dealing with a case very different from that of the lichens. We have, it is true, a fungus associated with a green plant, but here a large green flowering plant, which would not let itself be entirely overcome by a small fungus. The fungus too lives under different conditions. It is not growing on arid rocks or trees, but usually in decaying vegetable matter, the fallen leaves of the tree, which would enable it, as it is of a saprophytic nature, to live independently. The flowering plants, on the other hand, cannot, as a rule, make use of decaying vegetable matter. They feed on organic salts, which they take up, dissolved in water, by their thin root hairs.

In the cases however in which the roots are infested with a mycorrhiza, they are so completely covered in, even up to the tip, that they develop no root hairs at all. How then can they absorb nutriment? Well, as a matter of fact, they may be said to be fed by the mycorrhiza. On the outside of the felting formed by the fungus, numbers of hyphæ can be seen making their way in all directions among the decaying leaf-mould, and fixing themselves just like the root hairs of the tree would do to particles of the soil. On the inside, where the mycorrhiza touches the root, the hyphæ will be seen making their way between the epidermal cells, which should have grown out into root hairs. (Fig. 5.) These epidermal cells no doubt absorb food matter from the fungus which the latter, saprophyte that it is, has been able to obtain from the decaying mass of leaves. That this is the case, and that the trees really derive much nourishment from the mycorrhiza, has been proved by experiments such as germinating beeches in pure leaf-mould, when the

seedlings soon perish, whereas those provided with mycorrhiza will all thrive. Similarly by other experiments it has been proved that it is from the leaf-mould that the mycorrhiza gains its food, and that mycorrhiza is not formed if the plants are grown in sand watered with the substances used for the growth of the seedling.

Here then we have exactly the reverse of what took place in the case of the lichens. Here the advantage would seem to be chiefly on the side of the green plant and not on the side of the fungus, which can itself derive all its nutriment from the surrounding soil, while the green plant would not be able to get much nourishment from this decaying vegetable mould. Indeed the seedlings of oaks and beeches when they germinate in their natural conditions in the forest would all die if it were not for the mycorrhiza which, until their roots have penetrated the layers upon layers of dead leaves and have reached the soil proper, supplies them with all the nourishment they need.

The yellow Bird's Nest orchis (*Monotropa*) grows under exactly these conditions too, and its curious interlacing root system, which has often the appearance of a bird's nest, is also covered with a mycorrhiza. This mycorrhiza nourishes it so efficiently that the *Monotropa* has been able to dispense with its green leaves entirely, and its stock is only covered with a number of yellow scales. This of course points also to its long standing association with a mycorrhiza, for such an essential characteristic as chlorophyll is not readily lost in the evolution of a plant.

It was the absence of the green color which had led to the supposition that *Monotropa* was parasitic on the roots of trees, whereas if parasitic at all, it is parasitic on a fungus. But as it is the mycorrhiza which seeks out the Bird's Nest orchis, we must assume that the fungus too derives some benefit from this association, though at pres-

ent we cannot point out any distinct advantage which might be gained by this partnership.

A number of bog and heath-growing plants illustrate a very interesting form of symbiosis, if it is rightly called so. The roots of such plants as the heather (*Erica*) and the crowberry (*Empetrum*), for example, have associated with them, in fact within their cells, the hyphæ of a fungus, which we here also call mycorrhiza, though it is as yet unknown to what fungus the hyphæ belong. They occur in quite young cells and from a dense convoluted mass, sending out one or more threads into the surrounding soil, whence, no doubt, they derive some of their nourishment. That the plant makes use of this is beyond all doubt, for one after another these epidermal cells empty the fungal threads of all their contents, and in the older portions of the root nothing but the empty hyphæ of the fungus will be seen. These roots seem, therefore, to entice the fungus in and then destroy it and live on its contents.

Symbiosis this is called, but whether the fungus would give it that name I would not like to say.

In some cases it is not the epidermal, but several cortical layers which take part in this exploitation of the micorhiza. That however some mutual benefit does probably take place may be assumed from the fact that it has been impossible to grow the fungus independently of the devouring green plant.

Another form of root symbiosis is that encountered in the group of the leguminosæ, or the pea-tribe.

On the roots of these you will notice curious swellings, the nature of which was long a puzzle to botanists, but which, though irregularly placed, were of constant occurrence. (Fig. 6.) Their development was watched, and then it was observed that a fungal spore attached itself to one of the root-hairs, and gave rise to a hypha which

pierced the hair and grew down it into the tissues of the root. Where it came into contact with the cells these became curiously modified, the protoplasm becoming denser and more granular. At the same time the cells increased in size and divided rapidly, causing that portion of the root to swell up and form the root tubercles so characteristic of the leguminous plants. If older tubercles are examined they will be seen to contain in their cells large numbers of curiously-shaped micro-organisms, to which the name of bacterioids has been given. (Fig. 7.) These bacterioids contain the spores, which are liberated when the roots decay, and then the spore can again infect the root hair.

Of what benefit now are these small bacterioids to the pea or bean which contains them in its roots? Well, it has been found by experiments made both in this country and abroad that the bacterioids are able to make use of the nitrogen contained in the air, and to build up with it nitrogenous compounds which become stored up in the tubercles. Ordinary plants cannot make use of any of the nitrogen of the atmosphere, but only of nitrates contained in the soil; hence farmers are constantly adding nitrates in the form of manure to their fields.

Leguminous crops, however, can flourish in a soil devoid of nitrates, provided the bacterioids are present to absorb and transform the nitrogen of the air. Hence in the rotation of crops leguminous plants are exceedingly important, for not only will they flourish on soil impoverished by former crops, but they enrich the soil they grow in, for when the roots decay the nitrogenous compounds contained in the tubercles are liberated, and serve as food for the crop which is to follow. These bacterioids are therefore useful in a high degree to the pea or bean, and indirectly to the farmer if he knows his business. The bacterioids, on the other hand, may not only find a

secure place in the cells for their development and increase, but they probably make use of the products of assimilation of the green plant, make use of the organic substances which they, being devoid of chlorophyll, cannot form.

I have now come to the last case of the symbiosis of plants with which I shall deal. It is one which is of interest, both from the fact that it is the most recently discovered case, and also because it is the only case so far on record in which we have a symbiosis of two small colorless organisms, both belonging to the group of fungi.

Some of you may perhaps have heard of the ginger-beer plant. It is not a tree from which gingerbeer runs on making an incision, nor is that popular beverage derived from its fruits, but it is like the vinegar plant, a yeast-like growth which causes fermentation. The gingerbeer plant is said to have been introduced into England by soldiers returning from the Crimean war, but of that we have not sufficient evidence. This yeast-like plant has the appearance of small convoluted masses, and by making cultures of it a number of constituents can be distinguished belonging both to the yeast-like fungi and to the group of bacteria. But of all these organisms two only are essential for the pure fermentation, a yeast (*Saccharomyces pyriformis*) and a bacterium (*B. vermiformis*). This bacterium has received its name from its curious twisted growth, encased in a gelatinous coat, the whole resembling somewhat a wriggling worm. The yeast is a small unicellular fungus growing by methods of budding. (Figs. 7 and 8.)

But these organisms are not so remarkable for their shape, as for the fact that neither flourishes in the absence of the other. It seems probable that the fermentative action of the yeast liberates some waste product

which is inimical to the further growth of the yeast, a phenomenon which is of frequent occurrence. But the bacterium is able to make use of and hence remove this substance, thus stimulating the yeast to renewed activity. At all events some such action must, we presume, take place, and this curious double fermentative of the two organisms, each benefiting the other, has rightly been termed symbiotic fermentation.

Thus we have not only in the animal kingdom, as between animals and plants, associations of mutual benefit, but this interaction extends to the vegetable kingdom too; and here we find colorless plants, called fungi, forming a league with green self-supporting plants, and these often dependent on the intervention of the fungi, as in the case of the micorhizæ-bearing trees and shrubs.

That we are not always able to point out all the advantages gained from such symbiosis is due to a lack of knowledge regarding the requirements of some of these lowly groups of plants, and should stimulate all of us to further research in this field. The facts, and the interpretation of these facts, which I have brought before you herein will, I hope, arouse in some of you an interest in these problems of vegetable economics and sociology, and lead you to take some part in this fascinating study of symbiosis.

Bacteria of School-rooms.—Ruete and Enoch have made an investigation of germs found in school-rooms. A maximum number of over 3,000,000 living germs per ccm., a minimum number of 1500 per ccm. and an average of 268,000 per ccm. of air were found of the 18 species described, but one was found pathogenic for mice, guinea pigs, and rabbits. The quantitative determinations were made by passing a measured amount of air through liquified gelatine (Centralblatt f. Bakt. u Parasiten Runde, XVIII, 128).

Bacteriologic Results From Mechanical Filtration.

BY GARDNER T. SWARTS, M. D.

Secretary of the State Board of Health.

PROVIDENCE, R. I.

At the last meeting of this association* at Montreal the statement was made in the report of the committee on water supplies that no data had been available to show that filtration by the so-called mechanical methods was successful in removing bacteria. The writer at that time referred to experiments which had been made in the city of Providence, R. I. in order to determine this question for the purpose of establishing a plant capable of filtering 15,000,000 gallons daily if the experiments were successful.

The figures showing these results were not at that time available, and as they never have been published and as no experiments of a similar character have been made, it seems desirable to place these facts before the Association, inasmuch as many municipalities are agitated over the advisability of introducing the so-called natural or sand-bed filtration or mechanical filtration.

The mechanical form of filter used in the experiments was of the type in which quartz or sand is used as a supporting bed to a film of precipitated coagulant or fixative of organic matter, produced by the introduction into the water, before filtering, of some chemical such as iron or alum; a filter which is also cleansed by means of a reversed current of the water passed through the filter assisted by the use of a rake made to revolve in the bed of the quartz while the washing is being done.

The filters used in this line of experiments were two of the natural sand-bed form imitating the usual filter bed.

*The American Public Health Association, meeting held in 1895 at Denver, Colo.

The mechanical form was represented by one of the New York Filter Company's filters and one of the so-called Morrison filters. After the first seven months the sand filters were discontinued, it having been satisfactorily ascertained that the length of run was much less than the mechanical filter before the bed became clogged and the rate of flow in the natural bed was but 30,000,000 gallons per acre in twenty-four hours, while the mechanical filter was run at the rate of 125,000,000 gallons per acre in twenty-four hours. The efficiency of removal of bacteria was not as high, and the results were variable, either as the result of cracks in the filter or from some unknown cause. Although both of these natural filtration beds were constructed exactly alike, the results from the second were much poorer than from the first. When the natural bed was transformed or assisted by the addition of alum, thus converting it into a mechanical filter, the removal of bacteria was increased to nearly the same as on the Morrison filter, but the length of the run was correspondingly decreased.

The sand used in the natural beds was a natural river sand, not over sharp, while the sand used in the mechanical filter was crushed quartz having sharp edges.

In the beginning of the experiments, the New York filter gave such varied and unreliable results that its use was abandoned, while the so-called Morrison filter was continued in use during the whole series of experiments, which lasted for a period of about ten months, the working of the mechanical parts of the filter being perfectly satisfactory and the results obtained being successful.

The filter bed used in this mechanical filter was two feet and ten inches in depth, supported upon a base of iron with circular perforations of about 4 inches in size, which were covered with screens. The crushed quartz used was the "effective size" of 0.59 millimeters. The filter was

washed by a reverse current which caused the quartz to boil. The agitation and friction of the particles were increased by means of a rake with long teeth which revolved about a central column in the filter; the rake penetrating the bed by a screw motion from top to bottom.

From the various kinds of coagulant or precipitant used, basic sulphate of alumina was selected as being the most satisfactory and effective and was used in all the experiments mentioned. The amount of alumina used was $\frac{1}{2}$ grain to the gallon of water filtered, a lesser quantity failing to satisfactorily remove the organisms. The amount of $\frac{3}{4}$ or one grain per gallon did not increase the removal of the bacteria, while the efficiency of the filter was greatly decreased by reducing the amount of the flow through the filtered bed.

The alumina was applied in a free flow at the beginning of a run by pouring into the filter, as the water entered, a pint of the coagulant containing about 911 grains of sulphate of alumina for an average flow of 128,000,000 gallons per acre. The solution was made by adding one part of the alumina to six parts of water; as a result of this addition there forms a white flocculent precipitate over the surface of the grains of quartz and is the actual medium through which the filtration takes place, the quartz serving merely as a supporting bed or sieve. It required about six minutes to form this layer. When applied at the rate of a drop at a time and not in a "free flow" it required about a half an hour before the filtering layer would be formed. As soon as the filtering layer was formed the alum solution was dropped in continuously during the run from a regular stop at the rate of a drop a second. The effect of the presence of this layer was to reduce the head or pressure .28 of a foot for 128,000,000 gallons per acre. The depth of the water above the bed at the commencement of the run was nine inches; the average length of the run was about eighteen hours.

Under these conditions it was determined how long after the commencement of the run the filtering ability was at a maximum and also the capacity of the filtering media to remove organisms and also the possibility of removing organisms foreign to river water and simulating pathogenic bacteria in their life history. In this last experiment the Cruikshank bacillus and bacillus prodigiosus were used, since from their pathogenic properties they could be readily distinguished from the water bacteria.

For an understanding of the proportion of bacteria found in the applied water and the number to be found in the filter water, table No. 3 of the report is here appended.

As a result of the whole series of experiments the totals shown in table No. 9 will give an idea of the averages. In consideration of this table, it must be remembered that the introduction of only one result, which may be far below the average, will readily reduce what would otherwise be a most favorable average, to a lower point. This one result might occur from a temporary contamination of the effluent pipes at the time of collecting the sample, and which might not represent the exact results of filtration.

During the application of the cultures of bacillus prodigiosus in large quantities suspended in the nutrient media, the numbers of the common water bacteria materially increased in the effluent, the particles of quartz becoming covered with a slimy brownish deposit. Unsuccessful efforts were made to cleanse the quartz of this growth by steaming and boiling the quartz for one hour. Finally on the application of a solution of one pint of caustic soda to twenty-four parts of water and steaming, the normal white color of the quartz returned. The efficiency of the filter was raised by this process of cleans-

TABLE NO. 3.—FILTRATION EXPERIMENTS.—MORRISON'S FILTER.

Growth of about ninety hours, of water bacteria in the sample of applied and filtered water which were taken at the same hour; which was one hour or more after the water commenced to flow from the filter.

Date.	Gallons of Water Filtered per acre per Twenty-four Hours.	Bacteria per Cubic Centimeter.		Per Cent. of the Applied Bacteria Removed.	Average Percentage of the Applied Bacteria Removed.	Grains of Sulphate of Alumina Added.
		In Applied Water.	In Filtered Water.			
1893						
July						
20	122,000,000	2,000	11	99.5		0.75
21	122,000,000	9,477	16	99.8		0.90
Oct.					99.5	
3	125,000,000	905	6	99.3	(By totals, 99.6)	0.60
4	128,000,000	610	2	99.7		0.58
5	131,000,000	4,002	25	99.4		0.55
17	125,000,000	6,175	26	99.6		0.57
27	122,000,000	9,700	41	99.6		0.61
30	128,000,000	1,700	7	99.6		0.56
31	131,000,000	400	9	97.8		0.59
Nov.						
1	132,000,000	15,112	19	99.9		0.61
2	123,000,000	6,950	26	99.6		0.81
3	122,000,000	9,400	50	99.5		0.84
4	132,000,000	3,400	63	98.1		1.20
9	125,000,000	2,200	26	98.8	99.2	0.60
11	125,000,000	3,650	25	99.3	(By total, 99.5)	0.82

COMMENCED TO USE THE BACILLUS PRODIGIOSUS.

Nov.						
23	120,000,000	15,850	218	98.6		0.60
24	132,000,000	7,600	364	95.2		0.59
Dec.						
2	128,000,000	4,900	190	96.1		0.75
4	128,000,000	4,475	91	98.0		0.60
1894						
Jan.						
2	132,000,000	2,150	94	95.6		0.85
3	137,000,000	2,000	118	94.1		0.84
4	134,000,000	2,275	44	98.1		0.85
5	130,000,000	1,925	60	96.9	96.1	0.82
8	130,000,000	2,375	184	92.3	(By totals, 96.9)	0.58

CEASED TO USE BACCILLUS PRODIGIOSUS.

Jan.						
9	130,000,000	1,850	54	97.1		0.60
10	134,000,000	800	28	96.5		0.84
11	130,000,000	750	20	97.3		0.61
12	132,000,000	350	52	85.1		0.81
13	132,000,000	600	36	94.0		0.72
15	134,000,000	925	88	90.5		0.84
16	134,000,000	375	44	88.3		0.58
17	130,000,000	2,150	64	97.0		0.82
18	134,000,000	1,500	62	95.9		0.54
19	136,000,000	1,450	80	94.5		0.83
20	130,000,000	2,800	58	97.9		0.72
22	132,000,000	3,350	62	98.1	94.6	0.85
23	132,000,000	2,300	64	97.2	(By totals, 96.3)	0.80

WASHED FILTER BED WITH CAUSTIC SODA.

Jan.						
24	128,000,000	2,100	6	99.7		0.60
25	125,000,000	2,225	18	99.2		0.82
26	128,000,000	4,650	54	98.8		0.58
27	128,000,000	4,875	72	98.5		0.58
29	128,000,000	1,575	82	94.8	98.2	0.59
30	130,000,000	1,400	28	98.0	(By totals, 98.5)	0.58

ing from 92.8 per cent. to 98.8 per cent. As to the mooted dangers attending the use of alum in the applied water and which is held up as a warning by the opponents of mechanical filtration, this much may be said in reference to this series of experiments :

While it was necessary to add half a grain of sulphate of alumina per gallon of water filtered in order to obtain the most satisfactory results, yet upon comparison by the most careful chemical tests of the water applied to the filter and that of the effluent, there was found to be less alum in the filtered water than in the river water itself.

Inquiry from numerous manufacturers using alum as precipitant in various quantities in excess of the amount used in the experiments, revealed in no instance any incrustation or scaling in the boilers where such filtered water had been used. Communications with various boiler insurance companies elicited no report of scaling where such water was used. There is no recorded instance where alum-treated water as a drinking water has produced any ill effects upon the consumers.

This work was done by order of the City Council of the city of Providence and under the direction of a commission consisting of the Superintendent of Health, the City Engineer and the Commissioner of Public Works. The immediate supervision of the operation was under the supervision of Dr. C. V. Chapin, the Superintendent of Health and a member of this Association, while the application of the various tests was made under the direction of Mr. Edmund B. Weston, C. E., from whose compilations and reports these abstracts have been taken. Most of the bacteriological work was done by the writer.

Inasmuch as the writer, as well as every person connected with the experiments, commenced the investigation with the firm belief that successful mechanical filtration was not possible from a bacteriologic view, it

must be stated now, after examination of these figures, that mechanical filtration under these conditions can be firmly indorsed.

Cocaine in the Study of Pond-Life.

H. N. CONSER.

Member of American Microscopical Society.

SUNBURY, PA.

Hydrochlorate of cocaine as a narcotic for forms of aquatic life has a special value in the study of bryozoans and the encased rotifers. Quick-killing methods cannot be used where the contractile organs are so well protected as in these forms, neither can the narcotics that kill, for they often allow disorganization of cilia and tentacles before other parts of the organism are sufficiently benumbed.

The method I have found most satisfactory and certain with the fresh water Bryozoa is as follows: Several colonies are placed in a solid watch glass with 5 cc. of water, and as soon as the animals have expanded, one or two centigrams of cocaine is dropped on the edge of the water at two or three distant points. In fifteen minutes the narcotic influence is sufficient, as can be tested by touching the tentacles with a needle. One per cent chromic acid is now poured in to fill the watch glass and left to act for half an hour or more when it is nearly all withdrawn and water substituted. This process is repeated in half an hour and alcohol to form about twenty-five per cent added to the water, the strength of alcohol is increased by the addition of ninety-five per cent until eighty per cent is reached. By this means the chromic acid is washed out and the hardening accomplished so gradually that no distortions occur. For staining, borax-carminé or alcoholic-cochineal is used. The clearing must be gradual and is best accomplished by adding oil of lavender to the ninety-five per cent alcohol in which

the animals are kept, and after an hour, bringing them into oil of lavender from which, after perfect clearing, they are mounted in balsam.

The three swimming rotifers readily succumb to the influence of cocaine, but the family Melicertadæ hold out a long time against it. A method for these is like that for the bryozoans with the exceptions that only sufficient water to cover the colony well need be used, the quantity of cocaine must be relatively large, and when all movements cease, killing may be done with twenty per cent formalin, for chromic acid precipitates cocaine, when present in any considerable quantity. An after treatment with chromic acid in one-half per cent seems to give better hardening than formalin alone. When a colony of the Melicertadæ are subjected for fifteen minutes to a half-per cent cocaine solution and then transferred to another watch glass with pond water, the individual rotifers come out of the tubes and attach themselves hydralike to the bottom of the glass in perfect condition for study, saving the trouble of freeing the animals from the tubes with needles.

Radiolaria; a new Genus from Barbados.

REV. FRED'K B. CARTER.

MONTCLAIR, N. J.

Staurococcura, n. gen.

Definition.—*Coccodiscida* with four chambered arms on the margin of the circular or quadrangular disk, crossed in two equatorial diameters, connected by a spongy patagium. Medullary shell double.

Staurococcura quarternaria, n. sp.

Phacoid shell quadrangular, twice as broad as the outer and six times as broad as the inner medullary shell, with seven pores on its radius. Arms club-shaped, two

and a half times as long as the diameter of the phacoid shell, and in the outer part about two-thirds as broad as the latter, at the base about one-third as broad; their rounded distal end armed with a strong pyramidal terminal spine. Patagium incomplete, enveloping only the

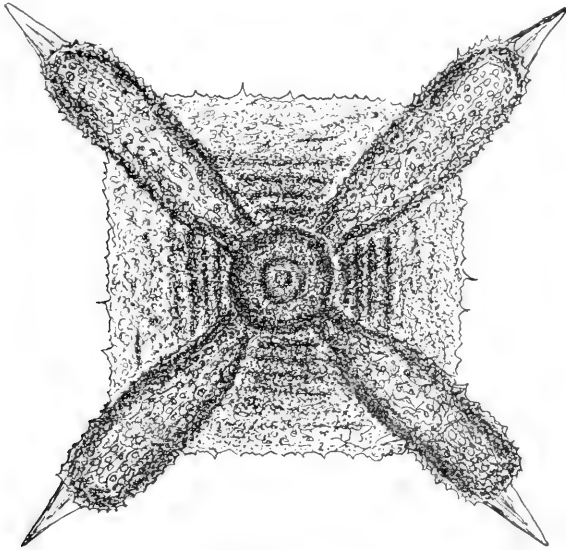

basal half of the arms, with five rectilinear parallel rows of chambers forming a square.

Dimensions.—Diameter of the phacoid shell 0.09; of the outer medullary shell 0.045, of the inner 0.015; length of the arms 0.25; greatest breadth, 0.075.

Habitat—Fossil in the rocks of Barbados.

Starch-Grains.—To recognize starch-grains, the best way is to place a drop of dilute aqueous solution of iodine in iodide of potassium in the water on the slide; the starch is colored blue. Of course, the polariscope may be used instead, but the first process is very convenient, as it gives a blue color, and the polariscope can be used as a confirming test.—*The International Journal of Microscopy.*

Radiolaria: A New Species.

REV. FRED'K B. CARTER,

MONTCLAIR, N. J.

Astractura digitata, n. sp.

Phacoid shell twice as broad as the medullary shell, with seven pores on its radius, without chambered ring. Arms finger-shaped, about as long as broad at the base,

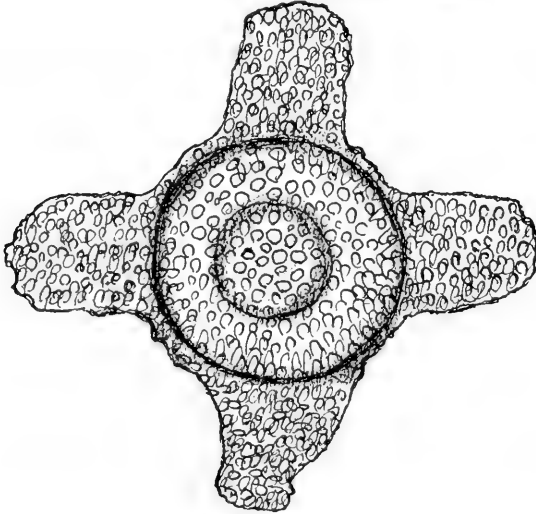

at the rounded distal end about three-fourths as broad.

Dimensions.—Diameter of the phacoid shell 0.11, of the medullary shell 0.055; length of the arms 0.06, basal breadth 0.056, distal breadth 0.046.

Habitat.—Fossil in the rocks of Barbados.

Appendicitis.—P. Blakiston, Son & Co., of Philadelphia, announce a book on "Appendicitis," by John B. Deaver, M. D., Assistant Professor of applied Anatomy, University of Pennsylvania; Assistant Surgeon to the German Hospital, etc. The book will be arranged in a practical and systematic manner. The History, Etiology, Symptoms, Diagnosis, Operative Treatment, Prognosis, and Complications of this disease will be given in the order named. It will contain about forty illustrations of methods of procedure in operating, and typical pathological conditions of the Appendix, the latter being printed in colors.

List of Microscopes and Exhibits.

BY THE NEW BRITAIN SCIENTIFIC ASSOCIATION.

November 19, 1895.

1. With Zentmayer's Army Hospital—(1) Leaf of Fuchsia, showing Raphides and Spiral Cells. (2) Seed of *Paulonia imperialis*. (3) Pollen, Cotton.—Rev. I. F. Stidham.
2. With Zentmayer's Histological—(1) Leaf of Nettle, showing Stinging Hairs. (2) Seed of Chickweed. (3.) Pollen Sunflower. Rev. I. F. Stidham.
3. With Wales' New Working—(1) Stellate Hairs on leaf of *Dentzia scabra*. (2) Fructification of fern. (3) Pollen, Japan Lily—Rev. I. F. Stidham.
4. With Bausch & Lomb's Student—(1) Louse from Pig. (2) Palate of Periwinkle. (3) Pigeon-post film—W. A. House.
5. With Bausch & Lomb's Library—(1) Louse from Human Head. (2) Palate of *Fulgar carica*. (3) Photographs of the Moon—T. E. Hall.
6. With Bausch & Lomb's Family—(1) Parasite from Fly. (2) Palate of common Slug. (3) Photograph, Niagara Falls—F. A. Pelton.
7. With F. Leitz—(1) Type Slide, 50 Diatoms. (2) Foraminifera from Ireland. (3) Fibres of Italian Flax—William R. Stone.
8. With Bausch & Lomb's Student—(1) Diatoms, *Arachnoidiscus* Ehr. in situ. (2) *Polycistina* from Barbados. (3) Fibres of Cotton—Wm. R. Stone.
9. With Bausch & Lomb's Investigator—(1) Fossil Diatoms, New Britain deposit. (2) *Globigerina* Ooze from 1950 fathoms depth. (3) Fibres of Silk and Wool—William R. Stone.
10. With Beck's New National— Circulation of Blood in Foot of Frog—Miss Caroline T. Robbins.
11. With F. Leitz—(1) Section of Scalp. (2) Section of Skin, showing Pores and Glands. (3) Section of Tooth—Miss Caroline T. Robbins.
12. With Zentmayer's Histological—(1) Wing of Butterfly. (2) Vase, and Bouquet made of Butterfly Scales and Diatoms. (3) Rosette 240 Diatoms etc.—Miss Mary E. Goodrich.
13. With Bausch & Lomb's Investigator—(1) Section of Spine of *Echinus*. (2) Section of Coal, showing Fossils. (3) Spiracle of *Dytiscus*—Prof. J. H. Peck.
14. With French—(1) Skin of Holothurian. (2) Crystal bearing Mica. (3) Wings of Honey Bee—Prof. J. H. Peck.
15. With Bausch & Lomb's Family—(1) Type slide of Holothuride. (2) Section of Pitchstone. (3) Gizzard of Cricket—C. W. Marshall.
16. With Bausch & Lomb's Model—(1) Spines of Starfish. (2) Gold Sand from California. (3) Fern Crystals of Silver.—Joseph Sayers.
17. With Bausch & Lomb's Library—(1) Section of Fossil coniferous Wood. (2) Longitudinal section of mahogany. (3) Longitudinal section of Pine—Joseph Sayers.
18. With French—(1) Eye of Fly. (2) Proboscis of Butterfly. 3. Plant Louse—Walter L. Williams.

19. With Acme, No. 4—(1) Section of Cartilage. (2) Blood Corpuscles, Amphiuma. (3) Section showing structure of Muscle—Dr. G. J. Holmes.
20. With Bausch & Lomb's Harvard—(1) Section showing Ossification of Cartilage. (2) Blood Corpuscles, Alligator. (3) Section showing structure of Nerve—Dr. G. J. Holmes.
21. With Bausch & Lomb's Model—(1) Section of Bone. (2) Blood Corpuscles, Human. (3) Section showing structure of Brain—Dr. G. J. Holmes.
22. With Bausch & Lomb's Universal—(1) Mineral section, Wavellite, with Polarized Light. (2) Japanese Sketch, made of Butterfly Scales. (3) Skin of Sole—A. L. Wiard.
23. With Zentmayer's Army Hospital—(1) Mineral section, Porphyritic Basalt, with Polarized Light. (2) Section of Chalcedony, with Polarized Light. (3) Young Oysters—M. S. Wiard.
24. With French—(1) Transverse section of stem of Lime. (2) Transverse section of Petiole of Pond Lilly. (3) Young Starfish—M. S. Wiard.
25. With Wales' New Working—Living objects in Water—A. N. Lewis.
26. With Wales' New Working—Living objects in Water—C. M. Burgess.

EDITORIAL.

Proportion of Instruments in Use.—A soiree is a pretty good place at which to observe the kind of instruments in use by the local scientists. An illustration of this is just at hand in the case of the exhibits made by the New Britain Scientific Association, where we find the number of instruments credited to each maker was as follows:

Bausch & Lomb, 12.
 Zentmayer, 4.
 Wales, 3.
 French, 3.
 F. Leitz, 2.
 Beck, 1.
 Acme, 1.

It must be very gratifying to Bausch & Lomb to find that their instruments represent forty-six per cent of the total.

The Philadelphia concern which is notorious for cut rates and clearance catalogues came very near not being represented at all.

Watson & Sons of London, do not happen to be represented in the list. We trust our New Britain friends will not forget the high-grade of workmanship for which the Watsons are

noted, and the fact that they are now sending instruments into this country every month. There ought to be at least one of them in New Britain.

MICROSCOPICAL APPARATUS.

An Effective Method of Improving Cheap Microscopes.

—The purchase of a first-class microscope is not possible, unfortunately, to many persons with limited purses. Those who have spare time and hand-cunning may, however, overcome

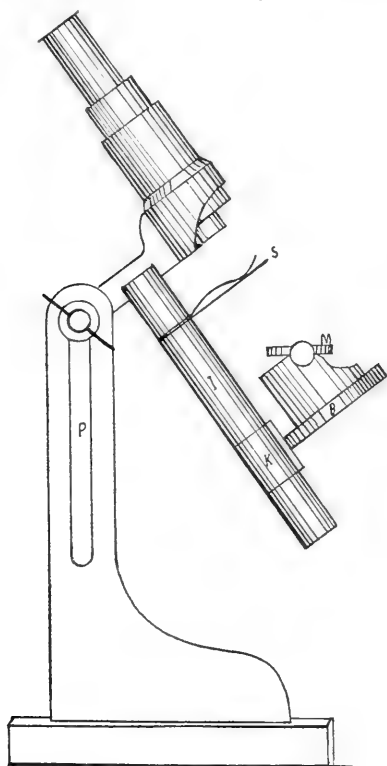

this initial difficulty to a great extent, and to help people of this class to help themselves this design is submitted.

The instrument here dealt with is one of the class sold by the instrument makers as a "Student's Microscope," and is suitable for beginners. In its original form it is in one piece with the

base, B, on which it stands vertically. It is sometimes fitted with lens powers of 8, 12, and 16 diameters, the latter of which is probably its limit for non-achromatic lenses. But, of course, the design is suitable for any similar body, however high class. It is quite free from vibration, and admits of the body being raised or lowered, and also swivelled in any direction; and the same remarks apply to the mirror or condenser fitted beneath the stage. For those who could afterwards get a better instrument, this one need not be discarded, for it will always be found highly useful for viewing the general structure and beauty of small insects, the parts of plants, and for a host of other purposes. The smoker may test his tobacco for adulteration, and the housewife her flour, oatmeal, etc., for mites.

A few glass cells should be built for properly viewing live insects. This may be done by cutting off short pieces of 3-16 in. glass tube, and, after carefully rubbing the ends down flat and parallel on sandstone with water, cementing them to slips of glass with Canada balsam; a loose slip of glass being used to confine the insect within the cell, where all its motions may be watched. For objects not requiring the light through them, a dead black slide should be used. In the outer corner of the stage there is a $\frac{1}{8}$ -in. hole, to which may be fastened a simple swivel for a stage forceps. A small drawing-pen makes a very fair substitute for a stage forceps.

But to return to the "Student's Microscope." Cut off the mirror portion from the lens portion, and to the latter solder or sweat neatly a brass armpiece of the form shown, and having a hole in the centre of end through which the screwed pin is passed to clamp it in any position to the slotted upright of stand. The stand and upright may be made of brass or of wrought iron, the stand (which is square) having a groove formed in its upper surface into which the foot of upright is fitted and soldered, or, better still, brazed, if the means are available. On to the arm is fitted and soldered the stem, I, which is a bit of brass tubing, and on stem, I, is fitted and soldered the stage, S, which is of 1-16 in. brass and fitted with steel or spring brass clips to hold the slides.

The mirror portion should now be dealt with. Drill a small hole through the base ring, B, and rivet a short piece of thin

brass tube, κ , to it, first interposing a stiffening piece of a sufficient thickness to bring the mirror's centre line true to centre line of lenses. Then solder the whole together neatly, the rivet serving to hold in position. The piece κ is then sprung on to the stem, ι , where, if properly fitted, it will hold the mirror in whatever position placed. To ensure this, the piece should be cut from a tube a little smaller in diameter than the stem, ι , and put on a mandrel and well planished on the outside with a hammer-nose or planisher; then it will hold admirably, and may be slipped off or on at will.

The slot, ρ , is also very handy for attaching the arm of a condenser or a candle-holder for night work. All essential measurements may be taken from the scale. The under side of stage, and that portion of its upper surface beyond the glass slides, should be coated with a dull black, and if the stand, upright, and arm are painted with a dark enamel paint, the whole thing will have a very neat appearance.

Care must taken in staining the stand upright, etc., not to set up cross reflections that would confuse the light on the field, and care must also be exercised to get the field hole in stage coincident with axis of microscope. If the stand is made of brass, it should be cleaned up nicely and bronzed.—*Work.*

MICROSCOPICAL MANIPULATION.

Preparing the Ovaries of *Scilla patula*.—Miss Lily H. Huie finds that the best method for preparing the ovaries of *S. patula*, in order to demonstrate the protein crystalloids, is by first fixing in Mann's Watery Corrosive Fluid. "To a boiling 0.75 per cent. common salt solution, sublimate is added to saturation (12 grm. for 100 cc.). The solution is then allowed to cool, when crystals of sublimate make their appearance. Preserve the solution without decanting.—*M. Heidenhain.*

Martin Heidenhain's corrosive sublimate

solution	100 cc.
Picric Acid	1 grm.
Tanaic Acid	1 grm.

"The tissues were carefully dehydrated and taken through chloroform into paraffin, and serial sections cut not thicker

than 2-3 Micron. . . The paraffin sections were spread out on warm water (40-45° C), after Gulland, and fixed to the slide by Mann's albumen method, and then stained in Mann's methylblau-eosin mixture as follows:—

Requisites.—The staining fluid:—

- | | |
|--|-------------------|
| a.—1 per cent. methylblau in distilled water | . 35 cc. |
| 1 per cent. water-soluble eosin in distilled water | 45 cc. |
| Distilled water | 100 cc. |
| b.—1 per cent. caustic soda in absolute alcohol. | |

The Methylwasserblau was obtained from Dr. Grubler, Leipzig.

Method.

- 1.—Stain for twenty-four hours.
- 2.—Rinse the dark-blue sections in ordinary water.
- 3.—Dehydrate thoroughly with absolute alcohol.
- 4.—Transfer the slide to a vessel containing: Absolute alcohol, 30 cc., and 1 per cent. caustic soda solution in absolute alcohol, 4 drops. Wait till sections are of a rust color.
- 5.—Remove all traces of caustic soda with absolute alcohol.
- 6.—Rinse sections in ordinary water for one minute. Red clouds are given off and the sections become bluish.
- 7.—Place slides for two minutes into water slightly acidified with acetic acid. This is done to deepen and fully restore the blue color, and also to fix the eosin.
- 8.—Dehydrate, clear with xylol (not clove oil), and mount in turpentine balsam."—*The International Journal of Microscopy.*

BACTERIOLOGY.

Bacteria of the Intestinal Canal.—Drs. Gilbert and Domini recently reported to the Biological Society of Paris, the results of an interesting experiment, the purpose of which was to determine the influence of purgatives in the elimination of microbes from the alimentary canal. Half an ounce of sulphate of soda and an equal quantity of magnesium sulphate were administered to a healthy adult in the morning before breakfast.

The bowels were evacuated six times during the day, the total weight of the fecal matter passed being 1.5 kilograms (3.3 pounds). The number of microbes contained in each milligram of fecal matter was found to be 272,253, and the total number evacuated during the day was 411,000,000,000. The number of microbes normally contained in the fecal matter of the person examined was found to be 67,000 per milligram, and the number eliminated in twenty-four hours, 12,000,000,000. The purgation, therefore, resulted in the discharge of thirty-four times the usual number of germs. The day following, the microbes found in the fecal matter was about double the ordinary number; and on the second day the fecal matter was normal in quantity, while the number of germs was only 1350 per milligram, or 580,500,000 in all,—less than one twentieth the normal amount, and one seven-hundredth the amount discharged on the day of purgation.

A continuous milk diet was shown to have a decided action in reducing the number of microbes in the feces. This effect, however, was not manifested until the end of the fifth day after beginning an exclusive milk diet. The action of purgatives in disinfecting the alimentary canal was prompt, but ephemeral. The only way in which intestinal asepsis can be maintained is by an aseptic dietary. The writer has found granose, zwieback, and other thoroughly sterilized farinaceous foods extremely valuable for this purpose, as they establish complete asepsis of the stomach.

The subject of intestinal asepsis is one generally recognized as of great importance. In the opinion of the writer it is one of the most important questions in the domain of rational medicine. The observations of Bouchard, Dana, and various other investigators have clearly shown that ptomaines absorbed from the alimentary canal are probably the chief cause of degenerations of the liver, kidneys, the central nervous system, and other portions of the body which have so long baffled medical skill. The renowned Dujardin-Beaumetz, during the last few years of his life, constantly called the attention of the profession to the importance of an aseptic or antiseptic dietary in the treatment of a large variety of chronic disorders, especially Bright's disease, diabetes, and other maladies involving the eliminative organs. Glenard has likewise emphasized the ne-

cessity for a strict observance of asepsis in the dietary of persons suffering from dilatation of the stomach.

A dietary of milk foods and farinaceous foods is unquestionably best suited for the establishment of asepsis in the alimentary tract. The most forcible objection which can be brought against the use of flesh foods, fish, oysters, and cheese, is the readiness with which these substances undergo decomposition in the alimentary canal, and the excellent culture medium thus presented for the development of microbes and their characteristic ptomaines.—*Modern Medicine*.

Bacterial Origin of Eclampsia.—Leusden (in *Virchow's Archiv.* Bd. cxl, iii, H. 1), after examining the various organs of two cases in which eclampsia occurred, says: "I have found nothing which indicates the infectious (bacterial) origin of puerperal eclampsia. The probability is that a toxic substance circulating in the blood is the cause of the eclamptic attacks. The changes in the kidneys are the principal organic lesions. The embolism in the lungs of the placental giant cells is only an accidental coincidence. There are no emboli containing liver cells. The minute necrotic changes in the parenchyma of the liver in both cases could not be connected with the cause of eclampsia. The hyaline (fibrous) thrombi of the lung and liver capillaries are the result of secondary uræmic changes, and are independent of the eclampsia.—*Canada Medical Record*.

MEDICAL MICROSCOPY.

Influence of Lecithin on the Growth of Organisms.—Experiments with dogs and other animals show that subcutaneous injections of lecithin increase notably the number of red corpuscles in the blood. They rise to 800,000 or a million and more above the normal, and the hemoglobin is also increased. This improved condition of the blood comes immediately and lasts a long while. The scientists who have made a special study of this subject are Danilewsky, Selenski and Sostin, and their report to the Academie des Sciences is full of interest. Experiments on the egg and larvæ of frogs showed that it produced an extraordinary growth in the tadpoles, and these tadpoles

showed much less pigment than the others. Lecithin does not act like a food. It is not an organo-plastic substance. It increases the assimilation of the food, and has a direct stimulating influence of great importance on the processes of multiplication among the cellular elements. The improvement of the blood, we know, is the most important condition to stimulate the growth of the organism, that is, the multiplication of its morphologic elements and their development. And this lecithin accomplished in these experiments.—*Semaine Medicale*.

The Culture Tube in Diagnosis of Diphtheria.—We notice that some of our contemporaries are speaking contemptuously of the culture tube as a method of diagnosis in diphtheria, and some of the more foolish are intimating that we will soon do away with microbes and go back to the good old style. It is true that some modifications have been made in the method by which bacteriological diagnosis of diphtheria is made, but the value of the method is none the less great. It is now, we believe, conceded that if the cultures obtained from the throats which are supposed to have diphtheria contain no bacillus either identical with or resembling that of the Klebs-Loeffler bacillus, the case is not one of diphtheria. If, however, these organisms are found, it is not possible to make a diagnosis at once of diphtheria, without inoculations, for there is a non-virulent bacillus which in all respects resembles morphologically the true bacillus. If, however, in connection with this bacillus there are clinical symptoms of diphtheria, then the diagnosis is practically certain. Thus, the bacteriological methods have both a positive and a negative value that is extremely great.—*Medical Record*.

DIATOMS.

Diatomology as an Aid to Geology.—By M. J. Tempere. Who would maintain at the present time that the study of Diatoms is of small importance, and not recognise that as much and even more than any branch of Cryptogamia it has a right to be classed among those which can powerfully aid the researches into the secrets of Nature that are the most difficult of solution?

Diatomology exists. It is a science which nevertheless has not received the unanimous sanction of learned men, for in the best treatises of Botany there is scarcely any mention of Diatoms and of their importance in Nature.

The study of Algæ in general, of Mosses, Fungi, and of Lichens, is honored everywhere. There is not a university, a faculty, or a large school, that does not reckon among its savants those who occupy themselves with the different branches of cryptogamic botany; but of Diatoms, none!—at least in France, for among foreigners I could mention many, among whom are two of our collaborators.

The reasons that I have heard given as an excuse for this neglect appears to me so ill-founded that they are hardly worth noticing; some of them even appear to me to be only the expression of one who will not discuss the question.

In our last number I mentioned the observation made by Prof. P. T. Cleve, of Upsala, on the identity of the species found on the coast of Greenland and on the north of Asia, giving rise to the idea of a current between the two opposite points, and thus aiding the solution of a hydrographical problem.

To-day, by the reading of a brochure having the title, Preliminary Report on the Physical Geography of the Littorian Sea, by Henry Munthe (a work published in the Bulletin of the Geological Society of Upsala, No. 3, Vol. II., 1894), I have seen with pleasure that at length a geological savant, not content to borrow from Palæontology for proofs in aid of his deductions, relating to the successive changes to which the Baltic Sea has been subjected, has appealed to Diatomology by requesting our colleague, Prof. P. T. Cleve, to study the species contained in those beds which present distinct characters of these transformations, so that he may be able to add another proof to those which he has already obtained.

Already for some time researches and comparative studies have been undertaken by a certain number of diatomists with this object in view, and I am certain that from these studies the importance of Diatomology will result, and that one day they will place it in the first rank.

The recent labors of Dr. P. Miguel have evidently contributed much to this end, in offering to diatomists new methods

of study, which enable them to follow the different phases of the life of these organisms, their transformations, and to compare that which they can obtain in their laboratories with that which Nature presents.—*The International Journal of Microscopy.*

MICROSCOPICAL SOCIETIES.

Quekett Microscope Club.

January 17.—Mr. Nelson exhibited a triplet magnifier, constructed on a formula of his own by Messrs. Watson, giving an amplification of 141-2 with a working distance of 1-2 in. Mr. Karop said he had been given an opportunity of examining this lens, and for sharpness of definition it was certainly one of the very best he had seen.

Mr. F. Orfeur exhibited and described a compound substage apparatus, which permitted of every modification of aperture, arrangement of diaphragms and spots, besides colour and polarising effects. The apparatus was discussed by the president and others.

A paper entitle "Notes on Some Florideæ," by Mr. T. H. Buffham, was, in the absence of the author, taken as read.

The Microscopical Society of Utah.

January 11th, 1895.—The Microscopical Society of Utah was organized with a membership of about twenty. Previous to this time much microscopical work had been done in Utah, but each microscopist had worked alone, and hence much of the good which comes from association was lost.

The membership of the society comprises members of the faculty of the University of Utah, physicians residing in various parts of Utah, public school teachers and a few business men and women.

At the time of organization the following officers were elected: James E. Talmage, President of the University of Utah, President; Dr. Chas. F. Wilcox of Salt Lake City, Vice-President; Miss Amelia E. Brotherhood, Instructor in Art, University of Utah, Secretary; and Prof. C. A. Whiting of the University of Utah, Treasurer and Curator. At the annual

meeting held October 11th, all of these officers were re-elected. The regular meetings are held monthly, and special working sessions are occasionally held at which practical instruction is given in the technique of the microscope, and in mounting sections for examination.

Since its organization many valuable papers relating to microscopy have been presented. Among these may be named: "Tyndale and the Germ Theory of Disease," "The Microscope in the Diagnosis of Disease," "The Microscopy of the Nerves," "The Microscope in Mineralogy and Lithology," "The Technique of Mounting Animal Tissue," "A Stereopticon exhibition of Microscopical Preparations," "Reptilian Blood," and several other papers of similar trend.

Through the kindness of the University authorities the Society is granted the use of ample rooms in the University of Utah and the use of many fine microscopes belonging to that institution.

The Society is continually increasing in membership, and its career of usefulness in stimulating scientific investigation has only begun.

If its present condition is an indication of its future course, The Microscopical Society of Utah will be an important factor in shaping the scientific thought of the new state of Utah.

C. A. WHITING.

Lincoln Microscopical Club.

January 29th, 1896.—The Secretary was directed to renew subscriptions to the following periodicals: THE MICROSCOPE, Zeitschrift für Wissenschaftliche Mikroskope, Zeitschrift für Angewandte Mikoskopie, Journal of the Quekett Club.

Officers were elected as follows: President, Dr. C. E. Bessey; Vice-president, Prof. E. H. Barbour; Treasurer, Mr. J. S. Dalls; Secretary, Mr. Ronersound; Members of Executive Committee, Dr. Philbrick and Mr. F. E. Clements.

Dr. Bessey exhibited a small microtome by Reichert and explained its construction and working.

Mr. Dalls showed further slides illustrating the Brownian movement. His slides showed that the movement was largely due to bacteria, there being no movement in slides where precautions were taken in sterilizing.

Dr. Ward exhibited slides of *Doliolum*, one of the Tunicates.

Mr. Clements showed a modification of the Schultze dehydrating apparatus.

ROSCOE POUND,
Secretary.

NEW PUBLICATIONS.

Immunity protective inoculation in infectious diseases and serum-therapy.—325 pp. New York; Wm. Wood & Co., 1895.

Dr. Sternberg is well known as an author on bacteriological subjects. This new work bears out the reputation of the author as a close student of literature and as an observer as to practical details. The volume is indeed timely for so much has been written on the subject of serum-therapy and antitoxins, so much of the literature is scattered, and much of it will not bear close scrutiny. Dr. Sternberg has done well in sifting the matter thoroughly and giving the practitioner reliable data, which he may use in practice.

He considers first the subject of natural immunity, and all students will agree with him when he says "No questions in general biology are more interesting, or more important from a practical point of view than those which relate to the susceptibility of certain animals to the pathogenic action of certain species of bacteria, and the immunity, natural or acquired, from such pathogenic action which is possessed in other animals." The following facts are set down, that young animals are more susceptible than older ones, race immunity—in the immune animal, multiplication does not occur, or is restricted to a local invasion of limited extent, and in which after a time the resource of nature suffice to destroy the parasitic invader.

These "resources of nature" upon which natural immunity depends are available for the prevention of infection but they may be neutralized by various agencies. Naturally immune animals may be infected by adding certain substances to pathogenic bacteria. Natural immunity may be explained—first Phagocytosis; second, action of blood serum and other organic liquids upon bacteria. Acquired immunity may depend on the development of antitoxins in the body of the immune animal. There

is also a tolerance which may be acquired when large doses of certain medicines are used or in the case of arsenic. In the second part of the book, special attention is given to protective inoculation and serum-therapy. The infectious diseases considered are anthrax, chicken cholera, cholera, diphtheria, foot-and mouth disease, glanders, hog cholera, hog erysipelas, hydrophobia, influenza, influenza of horses, pleuro-pneumonia of cattle, pneumonia, rinderpest, smallpox, swine plague, streptococcus infection, symptomatic anthrax, tetanus, tuberculosis, typhoid fever and yellow fever.

Tables are given to show the value of antitoxin treatment of diphtheria from various sources. The results are certainly highly gratifying.

Dont's for Consumptives, or the Scientific Management of Pulmonary Tuberculosis.—This is the title of a book which, under the authorship of Dr. Charles Wilson Ingraham, will soon (about Feb. 10th) be issued by the Medical Reporter Publishing Co. of Rochester, N. Y. The complete work of 35 chapters is devoted to the general management of Pulmonary Invalids, no reference whatever being made to drug treatments. The object of the author is to supply the Physician with a practical work, and at the same time, by eliminating technical terms, reduce the text within the easy comprehension of the intelligent patient. The author claims that "a good understanding of his condition is the best remedy for the Consumptive." With this book in the hands of his patient the physician will be relieved of a multitude of details which attach to the successful management of such cases. Special attention has been given those chapters pertaining to the destruction of tubercular infection. The book will be printed on 72-pound antique book paper, bound in cloth (imitation morocco), with title in gold leaf. Price, \$1.75.

The Best Waters to Drink.—By Ephraim Cutter, M.D., 12 pp., 1896.

After giving many reasons why water is the best fluid for man to drink, it is claimed that: (1) Well-water free from contamination is *good*, (2) Spring-water away from man is *better*, and (3) Aerated distilled water is *best*. Reasons are given for this preference.

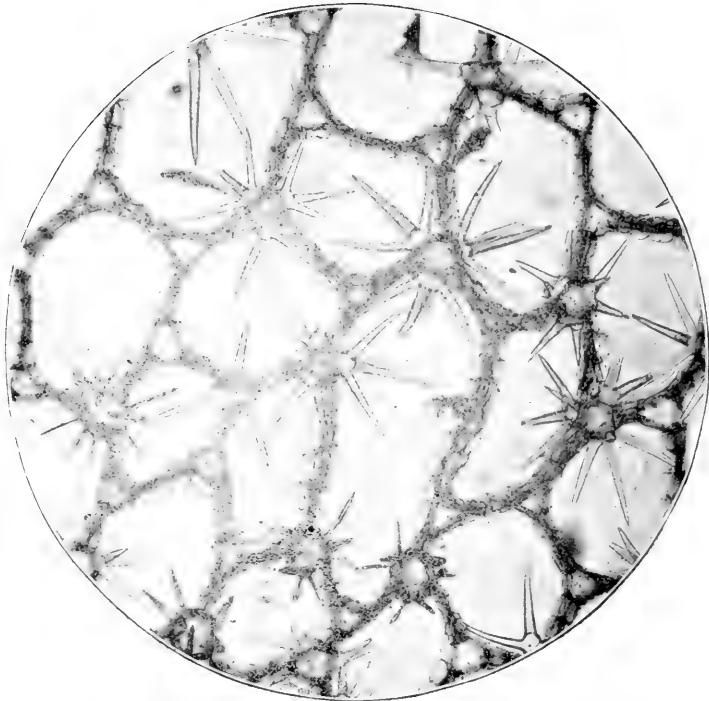

TRANSVERSE SECTION OF SQUASH (CUCURBITA) VINE,

x 65 DIAMETERS.

THE AMERICAN
MONTHLY
MICROSCOPICAL JOURNAL.

VOL. XVIII.

APRIL, 1896.

No. 4.

The Development of Photomicrographic Negatives.

BY DR. W. C. BORDEN, U. S. ARMY.

Fellow of the Royal Microscopical Society.

[WITH FRONTISPIECE.]

The development of the exposed plate is one of the most important steps in the photomicrographic process. However well the illumination may be arranged and however carefully the adjustments and exposure may have been made, the process will fail of successful or perfect result, by poor, or imperfect development of the latent image.

In almost all photomicrographic work contrast has to be sought for and next after detail and sharpness, or rather in conjunction with them, contrast is necessary in the negative to give a print having the requisite clearness.

To obtain detail a proper objective must be combined with suitable substage illumination. The light must be accurately focussed on the object by the substage condenser and the aperture of the latter must bear proper relation to the aperture of the objective. With detail obtained, sharpness is had by not extending the angle of light from the substage condenser beyond a degree necessary to show the detail and by accurately focussing the image on the camera screen.

In addition, a suitable plate must be used, and, if nec-

essary, a light filter of a color complimentary to that of the object; provided the latter is colored, as are histological or pathological sections or stained bacteria. Orthochromatic plates only, are suitable for photomicrography. Of these I have obtained best results with the Cramer rapid "Isochromatic." These plates when properly developed give excellent contrast and gradation.

Of the different reducing agents hydrochinone, either alone, or combined with eikonogen or metol, preferably the latter, is best for bringing out the latent image. Hydrochinone is slow in action but has the quality of producing clearness and contrast. Metol is more rapid and when used with hydrochinone starts the development and brings out the detail quickly—density being gained afterward by the combined action of it and the hydrochinone. A most important element in a formula for photomicrographic development is potassium bromide. This salt has the quality of preventing chemical fog, of somewhat restraining development, and of causing the details to appear in the relative order in which they have been produced by light intensity. With no potassium bromide and with a developer reasonably strong in alkali, all parts of the image, even those least impressed by light, appear practically together. With bromide added, this action may be modified from slight to a great retardation of the less impressed parts according to the amount of the bromide introduced. Practically, about one-half grain to the ounce of mixed developer is sufficient to restrain development, to cause the gradations to appear in proper order, and to prevent chemical fog even during prolonged development.

The complete formula is as follows :

No. 1.	Water, hot, distilled or boiled.....	250. c. c.
	Sodium sulphite	200 grammes.
	Potassium bromide.....	0.5 "
	Hydrochinone	1.5 "
	Metol.....	1.5 "
	Cool before using.	

No. 2.	Sodium Carbonate.....	15 grammes.
	Water	250 c. c.
	Use equal parts of No. 1 and No. 2.	

Development should proceed slowly and gradually and should be continued until sufficient density is obtained. Frequently all the detail appears while the plate is still quite thin and the novice is apt to fear a flat plate and remove it from the developer before development is completed. This is to be avoided, for density is necessary, and if after it is obtained the fixed plate has the parts clogged which should be clear, the exposure has been too long and another should be made. A thin plate, in photomicrography, after prolonged development generally means under exposure even if all details are present.

The image should not appear too quickly after the developer has been applied. Frequently with objects of little contrast the exposure has to be shortened as much as possible in order that contrast may be obtained, and in such cases, the image may not appear for a minute or two and development may have to be prolonged for fifteen or twenty minutes. A small box with a easily removable cover which will exclude all light should always be at hand on the developing table. In this the developing tray may be placed and left for some time in case of slow development. This allows the operator to leave the developing room and proceed with other work, or make another exposure, while development is going on. A cardboard or other cover for the developing tray should be at hand to place over the tray during the development of orthochromatic plates for they are somewhat sensitive to ruby light and should be guarded from it as much as possible during development. It is best to place them in the tray and flow the developer over them at some distance from the light, then cover them and not examine or expose them to the light longer, or more frequently, then necessary.

For a dark room light, an artificial one is best as it is always of equal intensity and is available at all times, night or day. The Carbutt "Multum in Parvo" lantern is excellent, as it furnishes abundant light and has two side doors, one opening directly to the lamp by which contact lantern slide exposures may be made, and another having an opal glass which is excellent for examining the fixed negatives.

For a fixing solution, a plain solution of sodium hyposulphite in water answers well, but one having chrome alum as an ingredient is better. Carbutt's formula is a most excellent one. It appears to have a slight clearing action, due probably to its removing staining if present; and as it hardens the film, the negative is easier to handle, particularly during warm weather. Its composition is as follows:

Sulphuric Acid.....	2 c. c.
Sodium Hyposulphite.....	240 grammes
Sodium Sulphite.....	30 "
Chrome Alum.....	15 "
Water.....	1000 c. c.

This fixing bath keeps well and may be used repeatedly.

After thorough fixing, washing, and drying, the process is completed so far as the negative is concerned, except in a few special cases where reduction or intensification is required. These processes should be avoided whenever possible and should only be necessary in the case of objects especially difficult to photograph. It is frequently the case that a first exposure does not give an entirely satisfactory negative. When this occurs, instead of attempting to better the poor negative by reduction or intensification, another exposure should be made of shorter or longer duration as indicated by the first negative, and a better or perfect result can thus usually be obtained. With some difficult subjects, however, no attention to exposure or subsequent careful development

will give a negative of proper contrast for printing purposes. This is the case with objects having but little contrast between their different parts, or those colored objects in which the coloring is so faint that they fail to absorb a sufficient number of the impinging rays and consequently transmit so many that there is nearly as much effect produced on the plate by the rays that pass through them as by those which pass by them.

To photograph such objects, it is necessary to make a short exposure and to stop the development as soon as the details appear and before any trace of a reduction of the silver compounds appear in those places which should appear clear in the negative and, after fixing and washing, to intensify the negative so that sufficient contrast may be had for printing. Of the various intensifying methods that by bichloride of mercury and aqua ammonia is the best. The fixed and thoroughly washed plate is placed in an aqueous saturated solution of bichloride of mercury until sufficient density is obtained, then thoroughly washed to remove every trace of bichloride, after which it is placed in dilute aqua ammonia to blacken, and again thoroughly washed.

While in the bichloride, density is best judged by viewing the plate by transmitted light, remembering that the plates will be somewhat denser after passing through the ammonia solution. The strength of the ammonia solution does not matter materially. Where the action of the bichloride has been prolonged, it is necessary to use very strong aqua ammonia to blacken the plate entirely.

In some cases reduction of a too dense negative may be required, or it may be necessary to reduce a negative in order to clear it before intensification. This is best done by placing the plate in a solution of sodium hyposulphite of ordinary strength to which a few grains of potassium ferricyanide have been recently added. The rapidity of the reduction depends upon the amount of ferri-

cyanide and the plate must be carefully watched during the process that the reduction may not be carried too far. By reduction, or intensification, or by employing both one after the other, a negative may sometimes be obtained from an object so difficult that the simple process of exposure and development will not suffice. But these processes should only be resorted to when strictly indicated and after different lengths of exposure and careful adjustment of the substage illumination have failed to give the required result.

In photomicrography, arrangement of the light and adjustment of the substage condensers are of primary importance and unless the details of their arrangement are mastered, no attention to development, or subsequent doctoring of the negatives, will give good results. But with these understood, the limit of their effectiveness will be known and when this is reached, the chemistry of the photographic process may be resorted to with profit.

The Practical Results of Bacteriological Researches.

BY GEORGE M. STERNBERG, M. D., LL. D.,

SURGEON GENERAL, U. S. A.

Gentlemen: In selecting a subject for my presidential address I have thought it best to restrict myself to that branch of biological science with which I am most familiar; and, as a technical paper might prove uninteresting to many of those who constitute my present audience, I have chosen a title for my address which will enable me to speak in a general way of the development of our knowledge relating to the low vegetable organisms known as bacteria, and the practical results which have been the outcome of researches commenced in the first instance solely on account of their scientific interest.

Attention was first prominently called to the bacteria

by the investigations relating to spontaneous generation. It was generally believed prior to the researches of Spallanzini, in 1776, that the development of micro-organisms in boiled organic fluids exposed to the air was by heterogenesis. Spallanzini showed by experiment that in some instances putrescible liquids when boiled and kept in hermetically sealed flasks could be preserved indefinitely without undergoing change. But he was not always successful in this experiment. Bastian, and other supporters of the theory of heterogenesis, at a later date, repeated these experiments with similar results, and maintained that when a development of micro-organisms occurred in a boiled fluid contained in a hermetically sealed flask it would only be by spontaneous generation. But Pasteur, in 1860, gave the true explanation of the appearance of living bacteria under such conditions. He proved that when development occurs it is because the organic liquid has not been completely sterilized, and that certain micro-organisms (spores of bacilli) withstand the boiling temperature, especially when they are suspended in a liquid having an alkaline reaction. At the present day this question is regarded as definitely settled, at least so far as known conditions are concerned; and we have an exact experimental knowledge of the thermal death-point of many micro-organisms of this class.

The principal pathogenic bacteria are destroyed at temperatures much below the boiling point of water. Thus, in experiments made by the present speaker in 1885 it was ascertained that the cholera spirillum is destroyed by ten minutes' exposure to a temperature of 52° C.; the typhoid bacillus by 56°; the micrococcus of pneumonia by 52°; the streptococcus of erysipelas (*S pyogenes*) by 54°; etc. According to Loeffler, the bacillus of glanders is destroyed in ten minutes by a temperature of

55° C.; the bacillus of diphtheria by 60°. The experiments of Yersin show that the tubercle bacillus does not survive exposure for ten minutes to a temperature of 70° C. The practical value of such knowledge is apparent. Articles of clothing infected with many of the pathogenic bacteria mentioned would be speedily disinfected by immersion in water heated to 70° C. or above and water or milk recently heated to the same temperature would evidently be without danger so far as infection by these "disease germs" is concerned. The recommendation of sanitarians that water or milk or food suspected of being contaminated by pathogenic bacteria should be exposed to a boiling temperature before it is used is based upon the experimental data referred to; and the knowledge that organic liquids can be sterilized by heat constitutes the foundation upon which the bacteriology of the present day has been established. To obtain reliable information with reference to the biological characters of any particular micro-organism it is necessary to experiment with pure cultures, and this requires a sterile culture medium.

It is hardly necessary to call attention to the fact that an immense industry in the preservation of food products depends upon the sterilization of these products by heat, and their preservation in hermetically sealed receptacles.

When Pasteur demonstrated the fact that sterile organic liquids, when protected by a sterilized cotton air filter, can be kept indefinitely without undergoing any putrefactive or fermentative change, he also proved that such changes are due to the presence of micro-organisms; and, extending his investigations, he found that certain definite kinds of change are due to particular species of low organisms. Thus the alcoholic fermentation of a saccharine liquid was found to be due to a torula (*Torula cerevisia*), the acetic fermentation of an alcoholic liquid

to a bacterial ferment (*Pasteur's Mycoderma aceti*), etc. Subsequent researches show that alcoholic fermentation may be induced by several species of torula, and even by certain bacteria; while the number of bacterial ferments now known to science is very considerable and is constantly being added to. Among the most important of these we may mention the *Bacillus acidi lactici*, which is the usual cause of the acid fermentation of milk; the various anaërobic bacilli which gives rise to the formation of butyric acid in solutions containing starch, dextrin sugar, or salts of lactic acid; the bacteria which cause the alkaline fermentation of urine; those which produce marsh gas by the fermentation of cellulose; those which effect the decomposition of albumen, with an evolution of hydrosulphuric acid; those which give rise to the putrefactive decomposition of organic material, the number of which is very large; the bacteria in the soil which reduce nitrates with liberation of ammonia and free nitrogen, and those which oxidize ammonia. The study of these bacterial ferments is still being vigorously prosecuted, and practical results of importance in agriculture and the arts have already been attained. In the future we may look for numerous additions to these practical applications of our knowledge. The use of pure cultures for producing useful fermentations must give the best result with the least liability to loss of material from the presence of undesirable species. It is known that the flavor of butter and of different kinds of cheese is due to various bacterial ferments, and there is good reason to suppose that a better product and greater uniformity would be attained by the use of pure cultures of the species upon which special flavors depend. I understand that in this country quite a number of dairies are now using pure cultures of a certain bacillus (*Bacillus 41* of Conn) for giving flavor to their product. It is prob-

able that similar methods will soon be introduced in the cheese-making industry. A recent English publication, which I have not yet seen, is entitled Bread, Bakehouses, and Bacteria. It will, no doubt, be found to contain information of practical value to those engaged in bread-making.

Pasteur's studies relating to the micro-organisms causing abnormal and injurious fermentations in wines, the results of which he published in 1886 (*Etudes sur le Vin, ses Maladies*, etc.), have resulted in an enormous saving to the wine-making industry in France and other countries where wine is produced upon a large scale; and his investigations relating to the cause and prevention of the infectious diseases of the silkworm, which threatened to destroy the silk industry in France, have resulted in even greater benefits to the material interests of his country and of the world (published in 1870).

Agricultural chemists predict that in the near future cultures of the nitrifying bacteria of the soil will be made on a large scale for the use of farmers, who will add them to manures for the purposes of fixing the ammonia, or perhaps will distribute them directly upon the soil. Should this prove to be a successful and economic procedure, the extent of the interests involved will make it a "practical result" of the first importance. Another application of our recently acquired knowledge which has already proved useful to farmers in certain parts of Europe relates to the destruction of field mice by distributing in the grain fields bread moistened with a culture of a bacillus which causes a fatal infectious disease among these little animals.

In Greece, in Hungary, and in other parts of Europe the quantity of grain consumed by field mice constitutes a very serious loss. Recent experiments made with cultures of two different bacilli (*Bacillus typhi murium* of

Löffler and the bacillus of Lasar) show that it is practicable to destroy these pests, in the fields where their depredations are committed, in the manner indicated. Mice which consume the bread moistened with cultures of one of the pathogenic bacilli referred to die within a short time from general infection, and their bodies are consumed by other mice, which also become infected. Thus a veritable epidemic is induced by which their numbers are very materially reduced.

This leads us to the subject of the prevention of infectious diseases among domestic animals. We have now a precise knowledge of the specific infectious agents ("germs") in the diseases of this class which have caused the greatest losses. The most important of these are anthrax, glanders, tuberculosis, infectious pleuropneumonia, swine plague, hog cholera, hog erysipelas, and fowl cholera. All of these have been proved to be due to bacterial parasites, the morphological and biological characters of which are now well known. The infectious agent and usual mode of infection being known in any given disease, we have a scientific basis for measures of prophylaxis. These naturally include the destruction of the specific micro-organism to which the disease is due wherever it may be found. An enormous amount of experimental work has been done for the purpose of determining the comparative value of disinfecting agents and the practical advantages of each, having in view questions relating to cost, stability, solubility, odor, toxic properties, etc., also to the difference in resisting power of different pathogenic bacteria, the presence or absence of spores, the character of the material with which they are associated, etc. As a result of this extensive laboratory work our knowledge with reference to the efficiency and availability of agents of this class is very complete, and enables those who are familiar with the experimental evidence to formulat  rules for the destruction of the

various pathogenic bacteria wherever they may be found. The infected animal is itself a focus of infection which under certain circumstances had better be destroyed *in toto*, the individual being sacrificed and the body put out of the way of doing harm by means of cremation or burial. Under other circumstances it may be sufficient to isolate the infected animal and to disinfect all discharges containing the pathogenic germ and all objects contaminated by such discharges. By such measures the extension of epidemic diseases fatal to domestic animals may usually be arrested. But it may happen that the extent of the epidemic prevalence and the number of animals already exposed to infection make these measures inadequate or difficult of execution. In this case we have, for certain diseases, another method of prophylaxis which has been extensively employed with excellent results. I refer to the method of protective inoculations, which we owe largely to the genius and patient researches of the distinguished French chemist Pasteur and his pupils.

Toussaint, a pioneer in researches relating to protective inoculations, has a short paper in the *Comptes-Rendus* of the French Academy of Sciences of July 12, 1880, entitled Immunity from Anthrax (*charbon*) acquired as a Result of Protective Inoculations.

In this paper he announces his discovery of the important fact that the anthrax bacillus does not form spores in the tissues or liquids of the body of an infected animal, but multiplies alone by binary division: "*Sa multiplication se fait toujours par une division du mycelium.*"

In the same communication he reports his success in conferring immunity upon five sheep by means of protective inoculations, and also upon four young dogs. We must therefore accord him the priority in the publication

of experimental data demonstrating the practicability of accomplishing this result.

In a communication made to the French Academy of Sciences, September 27, 1880, Pasteur gave an account of an experiment made July 14, 1879, upon two cows, which in connection with a subsequent experiment made August 6, upon four cows, led him to the conclusion that a single attack of anthrax protects from subsequent attacks.

The next important steps in the line of experimental research leading to protective inoculations in the disease under consideration were reported by Pasteur in his communication to the French Academy made at the *seance* of February 28, 1881 (with the collaboration of Chamberland and Roux), entitled *De l'Attenuation des Virus et de leur Retour a la Virulence*. In this connection Pasteur announces his discovery of the fact that when cultivated at a temperature of 42° to 43° C. the anthrax bacillus no longer forms spores and rapidly loses its virulence.

In a later communication (March 21, 1881) Pasteur says that he has found by experiment that when attenuated varieties of the anthrax bacillus form spores, these again reproduce the same pathogenic variety, so cultures of each degree of attenuation can be maintained indefinitely.

On June 13, 1881, Pasteur communicated the results of his famous experiment at Pouilly-le-Fort, near Melun. He says :

“On the 5th of May, 1881, we inoculated, by means of a Pravaz syringe, twenty-four sheep, one goat, and six cows, each animal with five drops of an attenuated culture of the anthrax bacillus. On the 17th of May we reinoculated these animals with a second virus, also attenuated, but more virulent than the first.

“On the 31st of May we proceeded to make a very virulent inoculation in order to test the efficacy of the pre-

ventive inoculations made on the 5th and 7th of May. For this experiment we inoculated the thirty vaccinated animals, and also twenty-four sheep, one goat, and four cows which had not received any previous treatment.

“The very virulent virus used on the 31st of May was obtained from spores preserved in my laboratory since the 21st of March, 1877.

“In order to make the experiments more comparable, we inoculated alternately a vaccinated and a non-vaccinated animal. When the operation was finished, all those present were invited to reassemble on June 2d—i. e., forty-eight hours after the virulent inoculation was made.

“Upon the arrival of the visitors on June 2d, all were astonished at the result. The twenty-four sheep, the goat, and the six cows which had received the attenuated virus all presented the appearance of health. On the contrary, twenty of the sheep and the goat which had not been vaccinated were already dead of anthrax; two more of the non-vaccinated sheep died before the eyes of the spectators, and the last of the series expired before the end of the day. The non vaccinated cows were not dead. We had previously proved that the cows are less subject than sheep to die of anthrax. But all had an extensive œdema at the point of inoculation, behind the shoulder. Certain of these œdematous swellings increased during the following days to such dimensions that they contained several litres of liquid, deforming the animal. One of them even nearly touched the earth. The temperature of these cows was elevated 3° C. The vaccinated cows did not experience any elevation of temperature, or tumefaction, or the slightest loss of appetite. The success, therefore, was as complete for the cows as for the sheep.”

Subsequent experience has fully established the value of protective inoculations in this disease, and the method

of Pasteur has been practiced on a large scale in France, Austria, Russia, and Switzerland.

The results of anthrax inoculations made in France by Pasteur's method during twelve years were summarized by Chamberland in 1894. The veterinarians who made the inoculations were each year called upon to answer the following questions: 1. Number of animals inoculated. 2. Number of deaths from first inoculation. 3. Number of animals dying within twelve days after the second inoculation. 4. Number of animals dying of anthrax within a year after protective inoculations. 5. The yearly average loss before inoculations were practiced. The total number of animals inoculated during the period to which this report refers was 1,788,677 sheep and 200,962 cattle. The average annual loss before these protective inoculations were practiced is said to have been about ten per cent for sheep and five per cent for cattle. The total mortality from this disease among inoculated animals, including that resulting from the inoculations, was 0.94 per cent for sheep and 0.34 per cent for cattle. Chamberland estimates that the total saving as a result of the inoculations practiced has been five million francs for sheep and two million francs for cattle.

Podmolnoff gives the following summary of results obtained in 1892 and 1893 in the government of Kherson (Russia): Number of sheep inoculated, 67,176; loss, 294=0.43 per cent. Number of horses inoculated, 1,452; loss 8. Number of cattle inoculated, 3,652; loss 2. The conclusion is reached that Pasteur's method of inoculation affords an immunity against infection with virulent anthrax bacilli in greater amounts than could ever occur under natural conditions.

Another disease in which inoculations have been practiced on a large scale is erysipelas of swine (*Rouget* of French authors), which prevails extensively in France and

other parts of Europe. Pasteur's first studies relating to the ætiology of *rouget* were made in collaboration with Chamberland, Roux, and Thuillier in 1882. Pasteur found that the virulence of his cultures was increased by passing them through pigeons and diminished by passing them through rabbits. By a series of inoculations in rabbits he obtained an attenuated virus suitable for protective inoculations in swine. In practice he recommended the use of a mild virus first, and after an interval of twelve days of a stronger virus. These inoculations have been extensively practiced in France, and the fact that immunity may be established in this way is well demonstrated.

In a paper published in 1894 Chamberland states that in the preceeding seven years, during which time protective inoculations had been practiced in France on a large scale, the mortality from *rouget* had been reduced to 1.45 per cent, whereas before these inoculations were practiced the mortality from this disease was about twenty per cent.

Hutyra has given the following statistics of inoculations made in Hungary during the year 1889 with "vacines" obtained from the Pasteur laboratory in Vienna: 48,637 pigs were inoculated on 117 different farms. Of these, 143 (0.29 per cent) died between the first and second inoculations. After the second inoculation 59 animals died (0.1 one per cent). During the year following the inoculations 1,082 inoculated pigs died of *Rothlauf*. Before the inoculations the annual loss in the same localities is said to have been from ten to thirty per cent.

In a communication (1894) to the Central Society of Veterinary Medicine (of France), Arloing claims that he has demonstrated the ætiological relation of a bacillus first described by him in 1889 (*Pneumobacillus liquefaciens bovis*) to the infectious disease of cattle known as pleuro-pneumonia. The demonstration was not complete

until recently, because of failure to reproduce the disease by inoculation with a pure culture of the bacillus.

Although this demonstration is of such recent date, protective inoculations against this disease have long been successfully practiced. For this purpose serum obtained from the lungs of an animal recently dead has been employed this having been proved by experiment to be infectious material, although the exact nature of the infectious agent present in it was not determined.

In the Bulletin of the Central Society of Veterinary Medicine of May 24, 1894, M. Robcis reports the results of inoculations made with cultures of Arloing's *Pneumobacillus liquefaciens bovis*, and with injections of pulmonary serum. His statistics with reference to the last-mentioned "legal" inoculations he has obtained from official documents relating to the Department of the Seine.

The total number of infected localities in this department during the years 1885 to 1891 was 1,253; total number of contaminated animals, 18,356; total number inoculated, 18,359; total number of deaths prior to inoculation, 1,753; total number of deaths after inoculation, 2,741; total number of deaths due to the inoculation, 94; total percentage of mortality, 22.8 per cent. After discussing these and other statistics Robcis arrives at the conclusion that Arloing's method of preventive inoculations with cultures of the *Pneumobacillus liquefaciens bovis* gives better results than the legal method with serum from an infected animal, the total loss among animals exposed to contagion not being over twelve to fourteen per cent.

In the infectious disease of cattle known under the names of "black leg," "quarter evil," or symptomatic anthrax, protective inoculations have also been practiced with success. The disease prevails during the summer months in various parts of Europe, and to some extent in the United States. It is characterized by the appearance

of irregular, emphysematous swellings of the subcutaneous tissues and muscles, especially over the quarters. The muscles in the affected areas have a dark color and contain a bloody serum in which the bacillus is found to which the disease is due. This is an anaerobic bacillus which forms large oval spores.

The ætiology of the disease was first clearly established by the researches of Arloing, Cornevin, and Thomas (1880 to 1883).

Strebel, in 1885, published the results of protective inoculations made in Switzerland in 1884. The inoculations were made in the end of the tail with two "vaccines," with an interval between the two of from nine to fourteen days. The vaccines were prepared by exposure to heat, as recommended by Arloing, Cornevin, and Thomas. The most favorable season for inoculations was found to be the spring, and the most favorable age of cattle for inoculation from five months to two years.

In seven Swiss cantons 2,199 cattle were inoculated; 1,810 inoculations were made among animals which were exposed in dangerously infected pastures. Of these but two died, one two months and the other four months after the protective inoculations. Among 908 inoculated cattle, which were pastured with 1,650 others not inoculated, the mortality was 0.22 per cent, while the loss among the latter was 6.1 per cent. The following year (1885), according to Strebel, the number of inoculations, exclusive of those made in the canton of Bern, was 35,000. The losses among inoculated animals are reported as having been about five times less than among those not protected in this way.

Note.—We are indebted to the Editor of *Popular Science Monthly* for permission to reproduce the above part of Dr. Sternberg's address, the balance of which will be found in the April number of the P. S. M.

Special Staining Methods in Microscopy, Relative to Animal Tissues and Cells.

3. THE SPECIFIC STAINING OF SMOOTH-MUSCLE FIBRES. By DR. P. G. UNNA, Hamburg. Translated from the German by GEO. W. CALE, M. D., F. R. M. S. (London), St. Louis.

The smooth-muscle fibres are in general easily recognized in the skin without specific stain. The thickest series of layers, much longer, clearer, almost structureless spindles with long, little staff-like nuclei to larger spindle or ribbon-formed, give the characteristic picture of the smooth-muscle as well in a longitudinal as in a cross section, which should not be confused with the before mentioned longitudinal and cross sections of adjacent normal collagen bundles. Add to this, that the usual nuclear stains (hæmatoxylin, picro-carmin) show the smooth-muscle plainly, even when markedly carried-out shading of the colors do not show sharply (gray-blue and yellow against bluish-white and red), so that up to this time there appeared no necessity for a sharper characterization of skin muscles.

But for all the more difficult problems another specific staining method must be sought for these parts of the skin. As such I will mention, for example, for the normal anatomy of the skin, the questionable existence of the smooth-muscle fibres in the middle layer of the hair follicle, in the walls of the cutaneous vessels, and the demonstration of the musculature of the sweat coils, for the differentiation of the smooth-muscle and connective tissue fibres on the inside of the walls of hypertrophic and atrophic sub-cutaneous vessels, as well as myomata, certain neuromata (painful tubercles) and nevi. But when it is necessary to employ such methods for such disputed questions, there can be no reason why they should not be used in all instances, especially in such cases in which the

only question is in regard to smooth-muscle fibres. For they will not only show more exactly and more sharply the surroundings of the muscle fasciculi and their relations with the neighboring tissue, but will also render easier the finding of displaced muscle fasciculi in the collagen tissues through the contrast staining. Finally, such stains are only applicable to such in which the pictures of the genesis and the regressive metamorphosis of the muscular spindles are to be given.

In the article published before I have taken occasion to give two coloring methods by which the collagen and muscle fibres could be differentiated; the methylin-blue-orcein method, and the acid fuchsin-picric method. By the first I have the muscle a weak bluish in contrast to the strong red collagen fibres, the better shown the longer one has previously stained with methylin-blue. We have also the methylin-blue which colors the collagen fibres and holds better than the decolorized neutral orcein solution. Consequently it shows greater basophilic properties than the latter and remains more tenaciously in the protoplasm than in the collagen. We are forced to draw the same conclusions from the results of the acid fuchsin-picric method, though we are here concerned with only two acid stains, which are dissolved in the tissues. The differentiation depends upon the difference in intensity of the (acid) stains, and the weaker picric acid takes possession of the basophilic substances (protoplasm, muscle substance) while the acidophylic parts (collagen, nuclei) take up with alacrity the stronger acid fuchsin. These methods also show here by means of the methyl-blue and orcein methods; muscle with protoplasm gives the same contrast stain with collagen.

In addition to these known methods I have found a way of developing the metylin-blue, which brings out sharply the muscle in collagen tissue in the simplest manner. The methyl-blue in the tissue is fixed by means of

permanganate of potassium when the whole changes at once into a violet, but the protoplasm and muscle bundles are so strongly colored that it becomes necessary to decolorize with acid-salt alcohol without decolorizing the last named tissue. This change may be utilized in order to decolorize the collagen tissues which are not so much affected by methyl-blue, and this shows a picture of the smooth muscles and protoplasm in deep violet on a colorless background. This methyl-blue-potassium permanganate alcoholic treatment of the skin muscles is carried out in the following manner :

The section is put for ten minutes in the polychrome methyl-blue solution, then washed in water, then put for 10 minutes in a 1 per cent solution of permanganate of potassium, fixed, and lastly washed in water again and decolorized in acid alcohol (1 per cent HCl) until the collagen background shows itself white. Here follows a washing in absolute alcohol, then cleared in oil and mounted in balsam.

A cell and cell-like substances show in such preparations an equal violet color. The epidermis as well as the prickle cells are too deeply stained to permit this structure to be well recognized ; but all delicate parts of this nature, the coil glands, the blood-vessels, capillaries, all connective tissue cells and lastly the muscles, are sharply defined against the unstained collagen, and at the same time permit their structure, especially the cell walls, such as the contours of the muscle spindles, to appear clearly. In addition to the deep staining of the cell nuclei and muscles, the method furnishes in this respect very useful general pictures.

As important as the differentiation of collagen is that of elastin, on account of the exact functional relations between elastin and muscle substance: in all cases in which elastin is not specifically stained will it be seen in the color of the collagen and not in that of muscle sub-

stance, as it is ranged next to collagen in its acidophilous character, and chiefly it will not be distinguishable from collagen. On this account it will be found necessary in all cases, even in those in which unfortunately a strong separation of collagen from smooth-muscle is sought, to seriously stain in a permanent manner the elastin by means of the well-known quick staining in acid orcein solution. For the methods which have been given, the simple methyl-blue or orcein method are not available for this combination, as the muscles do not assume the blue color in double orcein applications. On the other hand the methyl-blue-permanganate alcohol method and the acid fuchsin-picric method are especially applicable. In this latter combination it will be found advantageous to follow the elastin staining with a hematoxylin nucleus stain. Then, even if the nuclei appear red, after my simple acid fuchsin-picric method, they suffer somewhat from a stronger picric treatment, and a hematoxylin stain improves the sharpness of the picture materially. These two methods can be supplemented any desired manner. For whilst the last named four-color method is limited, as for example in hypertrophic changes of vessels through the sharp contrast between red, yellow and brown, very marked showing with low powers, the first named two-color method furnishes more transparent and better pictures for study with higher powers; and this the more so because the contours of the elementary parts appear more distinctly.

I. DEMONSTRATION OF SMOOTH-MUSCLE IN COLLAGEN.

(a) *Methylene-blue and Orcein Method.*

1. Polychrome methylene-blue solution, $\frac{1}{2}$ hour or longer.
2. Water.
3. N. Spirituous orcein solution (1 per cent), 15 minutes.
4. Absolute alcohol, oil, balsam.

Collagen, orcein red; muscle, protoplasm, bluish; keratin, nuclei, plasma cell, blue; prickle cells, methylene red.

(b) *Acid Fuchsin-Picric Method.*

1. 2 per cent acid fuchsin solution, 5 minutes.
2. Water.
3. Concentrated watery solution of picric acid, 1 minute.
4. Concentrated spiritous solution of picric acid, 1 minute.
5. Absolute alcohol, oil, balsam.

Collagen, keratin, nuclei, red; muscle, protoplasm yellow.

(c) *Methylene-Blue-Permanganate of Potassium, Mur-
iatic Acid-Alcohol Method.*

1. Polychrome methylene-blue, 10 minutes.
2. Water.
3. 1 per cent solution of permanganate, 10 minutes.
4. Water.
5. Acid alcohol (1 per cent HCl), 10 minutes.
6. Absolute alcohol, oil, balsam.

Collagen, decolorized; muscle, protoplasm, nuclei, violet.

II. COMPARISON OF SMOOTH MUSCLE WITH COLLAGEN AND
ELASTIN.

(d) *Acid Orcein-Hematin-Acid Fuchsin-Picric Method.*

1. Acid orcein solution, 10 minutes while being heated.
2. Wash in diute spirits.
3. Strong hematin solution, 10 minutes.
4. Decolorization of the collagen in acid alcohol a few seconds.
5. Water.
6. 2 per cent acid fuchsin solution, 5 minutes.
7. Concentrated watery solution of picric acid, 2 minutes.

8. Concentrated spirituous solution of picric acid, 2 minutes.

9. Absolute alcohol, oil, balsam.

Elastin, orcein, brown; collagen, acid-fuchsin, red; muscles, protoplasm, yellow; nuclei, grey-violet.

(e) *Acid Orcein-Methylene Blue-Permanganate of Potassium Acid-Alcohol Method.*

1. Acid orcein solution, 10 minutes while being heated.

2. Wash in dilute spirits.

3. Water.

4. Polychrome methylene-blue solution, 10 minutes

5. Water.

6. 1 per cent solution of permanganate, 10 minutes.

7. Water.

8. Acid alcohol, 10 minutes.

9. Water.

10. Absolute alcohol, oil, balsam.

Elastin, orcein, brown; collagen, decolorized; muscle, protoplasm, nuclei, violet.—*St. Louis Medical Journal.*

A New Way of Marking Objectives.

WILLIAM C. KRAUSS, M. D., F. R. M. S.

Secretary of American Microscopical Society.

BUFFALO, N. Y.

That every microscopist in demonstrating to his classes in histology or pathology has been annoyed in determining the focus of the various objectives when a nose-piece is used, no one will dare contradict. The small letters or figures, designating the focus, engraved on the body of the objective have often to be sought for with great vexation, necessitating at times the removal of the lens from the nose-piece, or in revolving the lens or nose-piece so that the number will be discernable. Sometimes

the microscope must be upturned or the investigator is obliged to place his head on the level with the table, thereby upsetting re-agent bottles or provoking other mirth and mischief before he is enabled to focus his tube correctly and with safety on some valuable slide. This has been the writer's experience, and now that he has finally and so simply solved this perplexing question, submits his discovery to the society, with considerable feeling of pride and gratification.

On the diaphragm in the large part of the objective, or the end that is screwed to the nose-piece, the design-

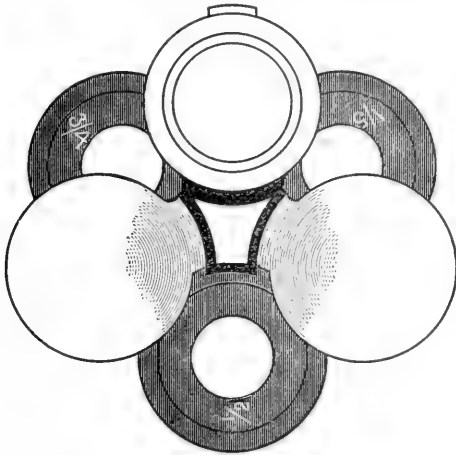

nation of the lens may be engraved, so that when the nose-piece is revolved the designation of the various lenses will be at once visible. The investigator with one eye at the ocular, need not change his position in bringing all the lenses under the body tube, but can with the other eye see the lens as it swings into place, and can focus with coarse and fine adjustment accordingly. The writer has been well pleased with the focal lengths of the Zeiss objectives, necessitating but one focusing for all the different lenses, especially of the dry system. Working with

these lenses, marked as I have indicated, on a triple or quadruple nose-piece, is not only a pleasure, but a great convenience.

The accompanying illustration which is purely diagrammatical, represents a triple nose-piece with the objectives $\frac{1}{2}$, $\frac{3}{4}$ and 1-5 attached removed from the body tube. The nose-piece is so revolved that all the upper surfaces of the lenses are visible, disclosing their designation.

Radiolaria: A New Genus from Barbados.

HARRY J. SUTTON.

PHILADELPHIA, PA.

Astrococcura. n. gen.

Definition.—*Coccodiscida* with four chambered arms on the margin of the circular or quadrangular disk, crossed in two equatorial diameters, without a connecting patagium. Medullary shell double.

Astrococcura concinna, n. sp.

Phacoid shell twice as broad as the outer and four

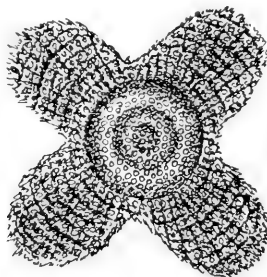

times as broad as the inner medullary shell, with ten pores on its radius, surrounded by one perfect chambered ring. Arms fingered-shaped, as long as broad at the base, at the rounded distal ends about three-fourths as broad.

Dimensions.—Diameter of the phacoid shell 0.12, of the outer medullary shell 0.06, of the inner 0.03; length of the arms 0.09, basal breadth 6.09, distal breadth 0.0675.

Habitat.—Fossil in the rocks of Barbados.

NOTE.—On pages 59 and 60 of the JOURNAL for February are described and illustrated two new species. Figure 1 is *Rhopalastrum anomalum* and Figure 2 shows *Pentinastrum irregulare*. From the position of the figures, one might infer the opposite to be the case. Hence attention is hereby called to it.

On Distinguishing Minerals.

BY MELVILLE ATWOOD.

[Report of paper read before the San Francisco Microscopical Society.]

Many years ago he had found considerable difficulty in determining, with any degree of accuracy, the hardness of minerals, the scale of hardness then in use, and probably still at many colleges, being a small box containing samples of the different minerals and a penknife. The knife was seldom hard enough to scratch wolfram, representing 5 in the scale. To the prospector or miner it is of the greatest importance to be able by some means to determine the degree of hardness. Many fragments of corundum and quartz have been sent long distances to have them determined, the sender thinking them diamonds.

Mr. Atwood had found, after many trials, the easiest mode of determining hardness was to have the minerals representing the various degrees mounted something like a writing diamond. For this purpose you break the corundum, topaz, etc., into small fragments, and after selecting those with fine, sharp points, proceed to mount them in the following manner: Take a small rubber-tipped pencil and extract the rubber from it. Then with

a spirit lamp melt some lapidary's cement into the vacant space; with a small pair of plyers take the fragments of minerals, heat one end, and insert it into the cement. While the cement is warm, by wetting your finger, you can mold it into any shape you please and when cold, if properly done, it will harden and answer just as well as if set in metal, with the advantage that you can renew it at any time in a few moments.

In the examination of rocks the specimen selected should have a good fresh surface of fracture, of a size about 3 by 5 inches, and $1\frac{1}{2}$ inches thick. With a trimming hammer prepare the narrow face or edge, so that by rubbing it on emery blocks you can get an even surface or polish on it. Then heat the specimen so you can hardly handle it. When in that condition rub Canada balsam on half the polished surface. When cold it will harden so that you can handle it without injury. By this method the different constituents of the rock are much better seen, and the inspection of the outer surface, viewed as an opaque object with a common magnifier, say of three diameters, set in a spectacle frame, gives all the information ordinarily required by the mining engineer. The even surface not covered by the balsam can then have the hardness of the different crystalized minerals to be seen on it easily determined, and also tested with acids, applying the same with a pointed glass rod dipped in the acid. The action, if any, can be seen, and also the smallest scratch, when testing for hardness, will be made visible.

The use of the lenses mounted in a spectacle frame Mr. Attwood strongly recommended to the miner or geologist in the field, as it is scarcely possible to examine the streaks of minerals, when they occur in very minute crystals and keep the lens in focus when holding it in one hand and working for the scale of hardness with the other.

Mr. Attwood had mounted for examination under the microscope a small fragment of what is called "carbonate," or diamond carbon. Bahia, Brazil, produced at one time large quantities of the carbonate.

Its hardness is identical with the white diamond, and in structure it is porous, so much that it resembles pumice stone. The fragment he had mounted was taken from the Yellow Jacket diamond drill, at Virginia City, Nevada. The drill penetrated the rock below the gold and silver ores of the Comstock lode at a depth of over 4,000 feet, when they met with hot water.

Should the minerals forming the rock be too small to be seen with the common lens, a microscopic section will have to be cut. The process is a simple one, but requires patient and skillful treatment to produce a section thin enough for a full view of its structure. Mr. Attwood had two sections thus prepared from the hanging wall of the Keystone mine, Amador county, at the thousand-foot level, one to show color and texture, the other to be examined by polarized light.

Altogether the demonstration was a good one, and the paper was attentively listened to.

EDITORIAL.

Transactions of the American Microscopical Society for 1895.—This volume, consisting of 376 pp. and numerous plates, reached us on February 15, 1896. It relates to the meeting of August 21 to 23, 1895. It has therefore taken about seven months to publish it. This is probably as prompt as it has ever been done, and reflects credit upon the Secretary, Dr. Wm. C. Krauss, who has had the matter in charge. Under the recent scheme of quarterly installments, the first part usually required six or seven months, the second part several more and the third or fourth parts ran down upon the following meeting. It will be seen that Dr. Krauss has issued the entire publica-

tion in one part consuming about the same time that the first "Quarterly" has heretofore required.

The return to the original plan of publishing all the papers in one volume is of course wise. Every one must see that to be so. The following facts culled from the Treasurer's report still further emphasize it.

Of part 1, 1892, there are 185 copies left on hand.

Of part 3, 1892, there are 276 copies left on hand.

Of part 1 and 2, 1893, there are but 53 copies left.

Of part 4, 1893, there are 152 copies on hand.

In all probability the excess of 91 odd copies (1892) and of 99 odd copies (1893) will prove utterly useless and eventually go for waste paper. Such is the result of issuing the proceedings in parts and scattering them regardless of the need of matching up sets. It takes a good deal of carefulness to keep periodicals properly matched up and a society cannot get that care taken for it. Hence, the society finds itself now encumbered with 236 copies of the 1887 volume but it has only 6 copies of the volume for 1884. As the demand for back volumes will be mostly for sets the extra copies for 1887 are mostly deadwood. They should however be presented to public libraries throughout the country, selecting such as have funds with which to do binding and cataloging.

The list of names of members contained in this volume includes 278 persons. A proposition to print but 300 copies was lost and 500 ordered. This will leave about 200 copies to go into storage.

Although the list gives 278 names, the Treasurer's report shows that but 203 paid dues for 1895. If only those who pay dues receive the publication there will be nearly 300 copies for storage.

The volume for 1895 has been printed and distributed to from 203 to 278 members. The papers were studiously withheld from publication until the volume could be gotten out. Now that it is out, the monthlies are at liberty to copy such papers as they desire to send to their subscribers. It is difficult for us to know what to do. We have about a thousand readers who are not members of the society and who presumably would like to get the information, but here it comes to us in a

lump—nearly 400 pages. Probably we can reprint the short papers one or two at a time and let the long ones be buried in the hands of the 203 to 278 members, most of whom will never find time to read them.

Ought not all friends of microscopy to consider this condition of affairs and to advise with us and with the influential members of the society regarding the wise course to pursue? If we could be furnished with the manuscripts as fast as they are ready commencing immediately after the meeting, we could lay the whole matter before our much larger constituency sooner than the society can do it through the proceedings. But of course this would render the annual volume unnecessary.

But to come to the volume itself. It is creditable in every way. It opens with the address of the president, S. H. Gage, which we have already published. Over 60 pages are consumed with the secretary's minutes of the meeting. These contain the comments of members upon the papers read as well as the discussions of business. When the society shall have relegated its business affairs to a council or governing board and thus eliminated talk about such things from its sessions it will have taken a long step in advance of its present attitude. There is always talk over items of business which is not worth publishing—so of the stereotyped addresses of welcome and of thanks. They must be spoken but not necessarily printed.

Of the specific papers, we will speak later.

MICROSCOPICAL APPARATUS.

On A Novel Microscope and Mechanical Stage.—I am now reminded of my promise, made some weeks ago, to describe in the "E.M." a new form of microscope recently constructed by myself. At present I am much pressed for time, and seldom come up to London, and therefore cannot conveniently exhibit the instrument.

The original intention was to make up, entirely by means of lathe-work, a simple form of microscope for a child's use; but, after commencing, certain alterations suggested themselves,

which are embodied in the instrument now shown in Fig. 1. The base is a heavy, circular ring turned in the lathe, both inside and out. On the face of the periphery is cast a boss, having a slanting top. The pillar which carries the stage and arm has its end faced to a similar angle, so that when the pillar is vertical it stands at right angles to the base. A square-shouldered screw passes through the ring-base, and is tapped into the bottom of the pillar. Great care must be taken that the line of this screw is exactly square with the facets. A centre for drilling the pillar to can be found on the stage-plate; but for the ring-base it will be advisable to fix it on a sloping piece of wood, attached to the face-plate of the lathe at a suitable angle, and drill the hole through while running, using a countersink, or pin-drill, for the square head of the screw; or it may be worth while to turn a flat-end cylinder of boxwood, with a central hole to fit, and serve as a guide for a twist-drill, this guide to be clamped or cemented in place on the flat. This will insure the hole being drilled upright therewith.

The microscope is shown in Fig. 1 in the vertical position; but if we turn the base round to the place shown by the dotted line, the pillar inclines backwards to an angle of about 50° , which is suitable for observation while the user is seated. The base coming behind affords a firm support against any overhang. This movement is easier to make, and less cumbrous, than the usual cradle-joint. The pillar is drilled through its axis down near to the base, and finished with a rose or cylinder-bit, so as to get a true and smooth hole. Into this it fitted a round rod, carrying the arm at the top, so as to slide smoothly without any shake. The back of this rod is cut into a rack, raised and lowered as usual by a pinion with two milled heads. In the top of the pillar is fixed the arm carrying the body through the socket-guide. However well a coarse focussing arrangement, consisting of a side-racked tube or body sliding in a socket, may appear to act while highly-polished just as it leaves the optician's hand, it will not continue to do so, for when it becomes tarnished the extra friction causes a nasty cross-strain damaging to rack and pinion. If the sliding-tube is moved by an equal force across the centre, the strain is equalised. This is effected in this microscope by the arm at the top of the racked rod, which ends in a horseshoe form, embracing the two

sides of the tubes, with pins projecting from the body through slits in the outer socket, and entering into spans in the arm ends. The outer socket is also slit through its length in front, to allow the fine movement bracket to pass through. We thus have a semicircular bearing behind for the body-tube with two elastic strips in front to keep it in place.

This arrangement brings the focussing milled heads and the two of the stage movements conveniently close together. At

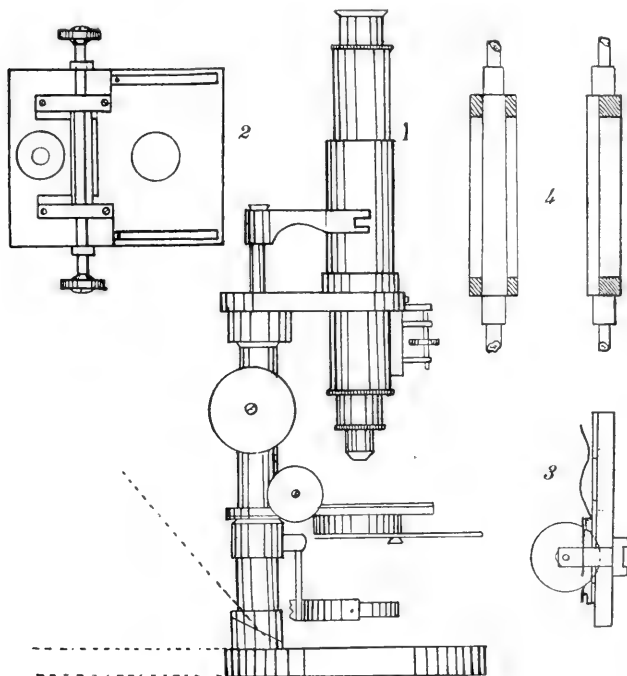

first there was no intention of adopting a fine motion, but the present one is simple and very effective. The bane of most fine movements is tight fitting, which is particularly necessary when the barbarous plan is adopted of raising the whole weight of the body and its attachments to obtain this motion; also a fine motion is sometimes subject to derangement by the lever (if such is used). The present fine motion consists of an inner piece of tube carrying the object-glass, and fitted so loosely that it easily drops out with its own weight; its range is limited by

one screw at the back near the bottom, passing through a slot in the shell-tube. Surrounding this is a light wire spiral spring pressing on the screwhead and against a fixed stud above it. In front of the fine-motion tube is screwed an angle-piece projecting out and bearing on the point of the fine-motion screw. We have thus a down-pressure at the back of the tube and a bearing in front. All this tends to keep the fine-motion tube up to its bed at opposite places, front and back, so that no amount of wear can ever cause the arrangement to get slack.

The steel screw of 80 threads to the inch is carried by a staple. It is tapped into the lower arm, but the upper blank end passes through the top. Its pointed end bears onto a hard steel flat let into the fine-motion arm. The milled head within the staple is merely screwed hard on to the fine thread. Where the inner tube bears it may be very slightly eased off at the middle to avoid the possibility of rocking sideways; this does not occur. The motion is perfect, and sensitive to the slightest touch.

I now refer to the stage. As this may be considered the most important feature, I append separate illustrations. However well some may say that they can manage to move an object-slide about with the fingers, to the majority of us this is a tantalising and clumsy operation, and nearly everyone must appreciate the luxury of a mechanical stage with rectangular movements. In cheap microscopes this is prohibitive, on the score of expense. Some of the old stages, with their rectilinear slides, set-screws, and adjusting slips, are more appropriate for a lathe slide-rest than for a mere carrier for a weight of a fraction of an ounce. Fig. 2 is a plan of the stage half the size of the original. It consists merely of a plane rectangular base-plate, with the top perfectly flat, and perforated with two holes. One embraces the pillar; the other is ledged for carrying the diaphragm plate, or substage illuminators, &c. The top or moving plate (shown shaded) has two horns extending back, allowing room between for sufficient range clear of the pillar. Close to the outer edge of these horns are screwed two pieces of fine rack, 1 3/8-in. long. The final screwing down of these must be deferred till the pinion is set in its bearings, in order to set the top plate in exact parallelism with the lower one. Having thus two racks spread some distance apart, each actuated by the same pinion, a perfectly straight movement is obtained fore

and aft. The side movement is obtained as follows:—A suitable length of pinion wire has a piece of brass tube pushed on tight midway. The ends of this are turned away so that it just fits between the inner sides of the two parallel racks. The exterior of the tube is turned and polished quite true. Now mark off the pinion wire to the outside of the racks, and turn all the teeth away right to the ends. Make these blanks quite parallel and polish them nicely. All this is best done with a clock-maker's hollow centre turn, worked with a bow, in a manner familiar to experts: these polished ends pass through suitable angle bearings, screwed up from beneath the stage, as shown in side view Fig. 3. What we now require is to keep the top plate down in contact with the bottom one, by a fine elastic pressure. The pinion is set in its bearings, and properly geared with the rack at a sufficient height to allow a thin hammered brass spring to be inserted beneath;—this is bowed up so as to bear up in the middle of the brass pinion-sheath; the ends consequently press down on the two sides of the upper plate. To keep this spring in place two blocks are fixed to the ends, rising a little above the centre of the pinion-sheath, and cut out so as to embrace it as shown in plan and side view, Fig. 4, in which the under curved black line shows the spring. No oil must be applied to this stage, and the lower surface of the top plate must be quite flat with the under one. Turning with a good slide-rest will effect this, and finish by stoning over. The surfaces may be smeared with blacklead.

As to the two outside milled heads, they are simply driven on to the ends of the pinions, which are very slightly tapered, and held up by fine screws tapped therein.

At first sight it might be inferred that the sliding transverse movement would not harmonise with the rack-and-pinion one; but the first trial will prove that this is not the case. The erratic movements of an aquatic animalcule can be followed up at once with perfect ease;—in fact it acts as easily (at least, in my hands) as any other rectilinear mechanical stage. The movement is too simple to be misunderstood; but I trust that I have been sufficiently explicit.—F. H. Wenham, in *English Mechanic*.

MICROSCOPICAL MANIPULATION.

Determination of Falsifications of Ground Black Pepper.—To demonstrate the presence of ground olive kernels, almond and other nutshells in black pepper, Martelli extols the method of Weisner for the micro-chemical demonstration of lignin by the aid of phloroglucin. He dissolves about 1 gm. of that substance in from 50 to 60 ccm. of hydrochloric acid of 1.10 by digesting for twenty-four to forty-eight hours. In a small, shallow porcelain dish about 50 cgm. of the suspected pepper is placed and moistened with the turbid phloroglucin solution and the dish is carefully heated over a spirit lamp until fumes of the acid are given off. Examination under the microscope will then show such falsifications, if they exist, colored in a strong cherry red, while the pepper is colored a yellow or a reddish brown. If much of the contaminating material be present, this differentiation will be plain to the unaided eye. On levigation and decantation the foreign material may be isolated and will show as a red violet color.—*National Druggist.*

BACTERIOLOGY.

Importance of Chemistry in the Diagnosis of Bacteria.—Dr. Fritz Kiessling calls attention to the importance of this subject. It is a well known fact that the differentiation of the colon bacillus from the typhoid fever germ offered, serious difficulties till Dr. Theobald Smith used the fermentation-tube test in differential diagnosis. Dr. Kiessling calls attention to such well-known physiological properties as peptonizing of gelatin and blood serum. Such products of vital activity as the coloring of the medium as is *Bacillus pyocyaneus* Attention is called to acid and alkaline curdling of milk. Species that have the power of reducing nitrates to nitrites, the production of indol. Phenol is another common product. The production of acids and alkaline substances, scatol, kreatine. Acid or alkaline condition of the medium is important. Kiessling mentions many other substances that must be taken into account for special organisms. (Pharmaceutische Rundschau, XIII, 266.)

Bacillus ramosus.—Prof. H. Marshall Ward in the fourth report of the Royal Society's research water committee gives an extended and full account of the life history of this water organism. The organism runs through its entire life-history from the germination of the spore to spore formation in from thirty to sixty hours at ordinary temperature. Prof. Ward calls attention to the want of care used by bacteriologists in looking up the synonymy of species they study. Exposure to direct sunlight kills both spores and filaments. Spores are killed or retarded by the blue violet rays apart from any temperature effect. (Proc. Roy. Soc., lviii, pp. 265-468.)

BIOLOGICAL NOTES.

The Vegetations of Solutions.—M. Barnouvin has in the *Repertoire de Pharmacie* for December an interesting little memoir with the title *Vegetations des Solutés* on the subject of certain vegetable growths found in a saturated aqueous solution of quinine valerianate which had been standing for about a month.

These vegetations presented the appearance of little greyish white flocculent masses dispersed throughout the liquid. Examined under the microscope with an amplification of 590 diameters, these flocculi presented the following appearance, certain of which are of considerable interest:

The structure consisted of numerous filaments, which were nearly colorless, some of them being nicely reticulated or cloisonated, while others were continuous, and the greater part of them containing spherical or ovoid spores of a blackish hue, with sharply defined contours and apparently homogeneous contents. Here and there the mycelium tubules bore sprouts, the latter terminating in spores of similar characteristics. Amid the filaments were numerous free spores, some solitary, while others were united two by two. They were, in fact, in the process of germination.

This disposition of spores in the interior of filaments is a very remarkable phenomenon. The reproductive organs in this instance answer to the chlamydo-spores of the *Mucorinæ*, to which family the vegetations of quinine valerianate belong. The

greater part of the spores are, in fact, mycelian chlamydo-spores, but some of them are also analogous to aërian chlamydo-spores, both forms being presented by certain *Mucorinæ*. We must admit, therefore, with M. Van Tieghem, that the two species of asexual spores are of one and the same origin.

The main importance of M. Barnouvin's observations is that the chlamydic form is not usually found in hydrolates (distilled watery solutions) and the question is—does it occur more frequently in aqueous solutions (not formed by distillation)? It is probable that in all cases the poverty of aqueous distillates in the matter of nutritive elements is the obstacle to the development of these particular organs of reproduction.—*National Druggist*.

MEDICAL MICROSCOPY.

Simplification of the Examination for Tubercle Bacilli.

—Professor Rindfleisch, of Wurzburg, says in the *Deutsche Medizinische Wochenschrift* that the bacilli are found in greatest numbers in the liquid and not in the masses of mucus of the sputum, and advises the following method for their demonstration: Dip a camel's hair pencil in water so as to moisten it well and press out surplus water. With this stir the sputum well and on withdrawing it, although nothing will apparently cling to it, it will be full of bacilli (if they are present in the sputum). With it stroke the cover glass lightly, so as to make an uniform coating over it. Of course, a new pencil must be used for each operation, as it has been found practically impossible, without a disproportionate amount of labor, to free the pencil from traces of the bacilli, which might invalidate subsequent examinations.—*National Druggist*.

Fluorescent Bacteria.—*Bacillus pyocyaneus*, *B. syncyanum*, *B. fluorescens tenuis* and several others, studied by K. Thumm oxidize grape sugar to acid which is neutralized by the ammonia formed later. (Jour. Roy. Mic. Soc., 1896, Pt. 6, 672.)

MICROSCOPICAL SOCIETIES.**Sheffield Microscopical Society.**

Mr. Chas. Hoole assisted by Mr. Harrow, the curator of the Sheffield Botanical Gardens, delivered a lecture to the members of the above Society on the "History, Cultivation, and Microscopic Structure of the *Victoria regia*." Mr. A. H. Allen, F.I.C., F.C.S., President of the Society, occupied the chair. The lecture throughout was of the most attractive character. An interesting point brought out was that the under surface of the leaves of this royal plant were of a deep crimson color, and it has recently been proved that the effect of this is to change light rays into heat rays, and thus materially add to the maintenance of the internal temperature, which is so essential to the plant. After the lecture, Mr. Hoole, by the aid of a number of microscopes, kindly lent by Mr. Newsholme, showed a large number of microscopical sections taken from all parts of the plant. The warmest thanks of the Society were subsequently conveyed to Mr. Hoole and Mr. Harrow.—*Pharmaceutical Journal*.

Quekett Microscopical Club.

The 339th ordinary meeting of this Club was held on Friday, Feb. 21st, at 20 Hanover-square, Mr. E. M. Nelson, F. R. M. S., president, in the chair.

Mr. Karop said he was sure that every member present would hear with profound regret of the death of Mr. T. H. Buffham, intelligence of which had only just reached the committee, although it occurred, he understood, on the 9th inst. Mr. Buffham was a most excellent and careful observer, and made particular study of the Marine Algæ; he had, as they knew, contributed many valuable papers on the reproductive organs of the Floridæ and the conjugation of diatoms, and his loss to the Club would be severely felt.

The usual announcements were then made, and the special business of the annual general meeting proceeded with.

The President appointed Messrs. Burton and Macer scrutineers, and ballot was taken for president, officers, and four members of committee. Having received their report, the President

declared that the names on the printed list had been duly elected.

The proposed amendment of Rule 7 of the Club's by-laws, notice of which was read at the previous meeting, was put from the chair, and carried unanimously.

The Secretary read the 30th annual report of the committee, and the Treasurer his annual statement of income and expenditure, signed by the auditors as correct.

Dr. Measures moved that the report and balance sheet, as read, be adopted. This was seconded by Mr. Neville, put, and carried.

The President then delivered the customary address, dealing with the improvements in the microscope and its accessories during the past twelve months, and with the theory of the Herschelian doublet, the homogeneous immersion objective, and other optical matters.

At its conclusion, Mr. Michael moved a vote of thanks to the President for his address and for his great services to the Club during the three years he had held office as chairman. This was seconded by Mr. Hardy, put, and carried with applause.

Mr. Nelson, having expressed his acknowledgement of the vote just passed, handed over the chair to his successor, Mr. J. G. Waller, F.S.A., who briefly returned thanks for the honor they had done him in making him their president.

The usual vote of thanks to the auditors and scrutineers, committee, and officers were accorded, and the proceedings terminated.—*English Mechanic*.

Lincoln Microscope Club.

February 20. Dr. Bessey delivered the President's address on "The Use of the Microscope in Nebraska." He stated that about 300 microscopes were in use in education in the state, and that of 47 high schools in the state, 23 have one or more microscopes. The highest number of microscopes owned by any high school in the state is eleven. Most of them own six. The West is not behind the East in seizing upon the latest and best methods of instruction.

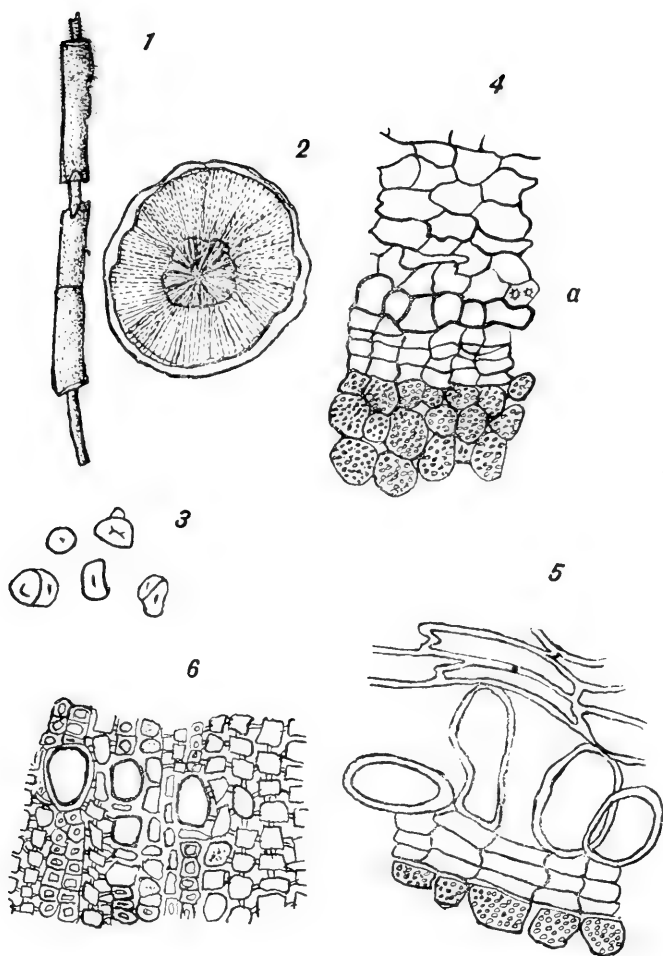

THE ROOT. CROSS SECTION AND MICROSCOPIC STRUCTURE
OF *TRIOSTEUM PERFOLIATUM*.

THE AMERICAN
MONTHLY
MICROSCOPICAL JOURNAL.

VOL. XVIII.

MAY, 1896.

No. 5

A New Adulteration of Senega Root.

BY C. HARTWICH.

[WITH FRONTISPIECE.]

In the early part of 1894, Ad. Andree, in Hanover, drew attention to an interesting adulteration found in senega root imported from New York, the drug containing nearly 25 per cent of a foreign root which he referred to *Richardsonia scabra*. The structure of the drug, however, showed this identification to be incorrect; the starch in the two roots differed in character, and in the *Richardsonia* the oxalate of calcium assumed the form of raphides, whilst in the adulteration referred to it is present as cluster crystals. Hartwich believes the root to be that of *Triosteum perfoliatum*, L., Caprifoliaceæ, which has recently appeared as ipecacuanha. Externally the roots showed the greatest similarity, and the histological and chemical examination proved their identity.

Triosteum perfoliatum is indigenous to the eastern and southeastern United States, and might therefore easily be collected with senega, although the two plants are very different in appearance. *Triosteum* is a scrub with a thick knotty rhizome, from which arise several stems reaching nearly three feet in height; it is known in America as tinker's weed, bastard ipecac, etc., and is used somewhat extensively as an antipyretic, purgative and emetic.

The drug consists of a yellowish-brown or dark-brown bent, knotty rhizome, to the sides and under surface of

which are attached numerous roots, generally not over $\frac{1}{2}$ cm. thick, and often much thinner; these are lighter in color than the root-stock, show here and there transverse fissures (Fig. 1), and resemble many varieties of false ipecacuanha, especially *Richardsonia*. In general appearance it is so like senega, that its presence seems to have been overlooked; it differs, however, in the absence of a keel.

The structure of the root is very characteristic. A transverse section (Fig. 2) exhibits a radiate wood without pith and a cortex, in which a narrow pale outer portion can be easily distinguished from a darker inner part. Next to the cork is a layer of large compressed cells (primary bark), containing here and there a cluster crystal of calcium oxalate. Between this and the secondary bark is a layer of four or five rows of cork cells, the outer of which have undergone an unusual radial elongation (Figs. 4 and 5), in consequence of which the primary bark has become compressed, and is eventually thrown off. The cortex contains numerous cluster-crystals of calcium oxalate and starch in compound or simple grains reaching .015 mm. in length (Fig. 3). The wood is remarkable for the fact that the medullary rays are lignified, whilst in the xylem rays only the middle lamella yields the lignin reaction.

The *Triosteum* root contains an alkaloid which Andree considered identical with emetine. Hartwich, however, was unable to obtain the characteristic reaction with hydrochloric acid and chlorinated lime, and concludes, therefore, that the alkaloid is not emetine.—Abstract of a paper in the *Archiv. d. Pharm.*

Anthrax in Fox.—Prof. Bujuid reports that a fox kept in a cage for some months and fed on a rabbit dead of anthrax took the disease and died on the third day. Cultures made from the clotted blood and of the heart and other gave anthrax bacilli. (Centralblatt f. Bakt. u Parasitenk.)

The Nature and Manufacture of Bacterial Products.

By E. M. HOUGHTON, Ph. G., M. D.

DETROIT, MICH.

There is a growing demand among pharmacists for more information regarding the origin, properties and processes of manufacture of the various bacterial products that are creating so much interest among all classes of people, with special reference to those employed as therapeutic agents. The purpose of this paper is to give in a general way the more important facts relating to the microscopical slides, culture media, toxins, antitoxins, and other products of this nature that are found on the market.

The origin of all these preparations is those minute, unicellular, vegetable organisms we call bacteria, which are species of fungi very closely related to yeast and molds. So inconceivably small are these forms of life that, according to the estimate of Bujwid, eight billions of pus-germs weigh but a single milligram. Had we an instrument capable of magnifying a man of average stature in the same proportion as we do bacteria to study their characteristics, he would appear about four times as large as Mount Washington. We might almost compare them in size to the chemist's atoms; indeed, until a few years since, we knew far more about atoms than we did about germs. Now, owing to improved methods of microscopical study, we are enabled to observe many phases in the cycle of life of these microscopic plants.

Scientists have classified bacteria in various ways. The most important classification is based on form, and presents three great classes: micrococci, bacilli, and spirilli.

The micrococci are spherical germs, which, according to grouping, are given more comprehensive names. When occurring singly or in irregular masses (Fig 1) we

call them staphylococci; an example of these is furnished by the ordinary pus-germs. When in groups of two, they are termed diplococci (Fig 2); perhaps the most important illustration of this class is the germ of pneumonia. When occurring in chains or threads containing many cells, the name streptococcus (Fig. 3) is given; as the streptococcus of erysipelas or tonsillitis. Then again, from division in three directions, we may get little square

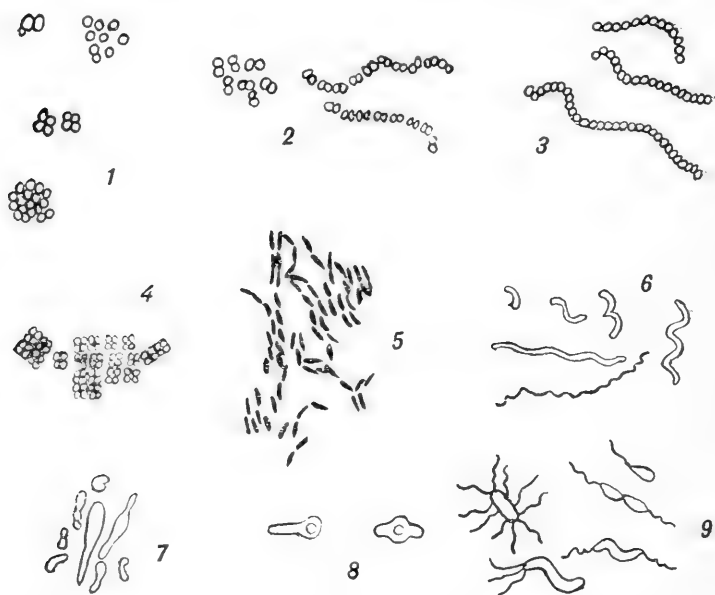

packages of germs: these are called sarcines (Fig. 4); many of our harmless water bacteria form groups in this way. The second class, called bacilli (the word bacillus means "a small rod"—see Fig. 5), may occur in dense masses or singly, as with the tubercle bacilli, typhoid fever and many of the other common pathogenic bacteria. Again, they may form long threads, as is noticed with anthrax germs, which, until Pasteur's discoveries a few years ago, threatened to annihilate all the herds of Europe. Bacilli may be short or long, thick or slender,

with rounded or with blunt ends. In fact, the structure may be varied in innumerable ways.

The third class, but a few species of which have been studied, may occur as bent rods or comma-shaped organisms when found singly, or, when growing out into threads, may have a spiral or corkscrew appearance (see Fig. 6) The most important germ of this class thus far studied is the spirillum of Asiatic cholera.

No hard and fast lines can be drawn, as all these classes gradually merge one into the other. Grouping and form of all kinds of bacteria are affected to greater or less extent by variations in food and environment. In old cultures, or where the conditions are unfavorable for development, we frequently have irregular non-typical germs. These are spoken of as involution forms (Fig. 7). Some germs also develop spores (Fig. 8), corresponding to the seeds of higher plants, which may give the germ an atypical appearance; a very good illustration is the bacillus of tetanus, or lockjaw, in which the spore occurs at one end of the rod, giving the appearance, in stained specimens, of short pins.

One of the most important properties of bacteria, from the biologist's point of view, is the facility with which their protoplasm combines with the basic anilin colors, thereby enabling the observer to study the form and size of the organism with ease and distinctness. In some cases, such as of tubercle bacilli, this reaction is very characteristic when some special stain is employed.

Stained microscopical preparations of the most important disease-germs, by which to verify their own mounts, are being called for by that class of physicians who have not had the privilege of laboratory instruction, but are alive to the necessity of using all the means within their grasp of making as early and accurate diagnoses of their cases as possible.

Notwithstanding the many and extensive researches

made, very little is known of the structure of bacteria, except that they have a cell-membrane, enclosing transparent and apparently structureless protoplasm. They probably, like other cells, contain a nucleus. Some forms, like the diplococcus of pneumonia, have outside the true cell-membrane a jelly-like substance that in stained specimens shows as an unstained halo. Only a few of the micrococci have the power of spontaneous motion, while many of the bacilli and spirilli by means of one or more flagella, or whips, are very active; the bacilli of typhoid fever is a good example and possesses several whips (Fig. 9).

Bacteria generally multiply by fission; that is, a constriction occurs in the middle, transverse to the long diameter, which gradually grows deeper until division takes place at that point. If the division is incomplete, we have chains formed. Under favorable conditions division may take place as often as once in fifteen minutes. A simple calculation will show what an immense number of germs would thus be generated in a few hours. The progeny of each separate germ, when grown upon the surface of solid culture media, is called a colony; and usually appears when the colonies are scattered as a small circular speck. It may have a sharp or an irregular border, as seen through a microscope.

Bacteria can grow only in the presence of moisture at certain temperatures, and when supplied with proper food. As they do not contain chlorophyll, they cannot assimilate carbon dioxide, as do the higher plants, and light hinders their growth to a great extent—hence the prevalence of disease in dark, damp houses. Most forms of bacteria require oxygen and obtain it from the air. Some species, such as the bacillus of tetanus or lockjaw, will not develop in the presence of air, but obtain the oxygen required for the elaboration of their products from the food material supplied them, in the same way as

carbon and nitrogen are obtained. Most saprophytic bacteria, as the ordinary germs of putrefaction, grow best at 25° to 30° C., while the optimum temperature for the parasitic varieties is that of the animal body in which they are found. Extreme cold does not destroy bacteria, but all are destroyed by a temperature of 100 C. maintained for some time. Some bacteria will develop readily in a slightly acid culture medium, while other forms will not grow if the least trace of acid be present.

Germs causing disease in animals are called pathogenic, and almost invariably require neutral or slightly alkaline materials for food. In order to obtain satisfactory knowledge of the biological characteristics of bacteria, they must be grown in various ways. A great variety of substances have been used as food for bacteria, some are natural, others artificial. Of the varieties of pabulum the most important is blood-serum, obtained under aseptic conditions from the blood of slaughtered animals. This serum may be coagulated by heat, when it is known as Koch's blood-serum, or, if a small amount of beef bouillon is added, and then coagulated, it is called Loeffler's blood-serum, which is used very extensively by health boards in many of our larger cities for growing diphtheria germs. Potatoes are frequently used, and are very useful for bringing out the biological characteristics of "surface growths," of some forms of bacteria. Other tuberous roots, milk, cooked fish, etc., may be used. Usually, however, artificial materials are employed in the laboratory: beef bouillon, containing 1 to 2 per cent peptone and $\frac{1}{2}$ per cent sodium chloride, is generally the basis. In the manufacturing laboratory, broth of this kind is used almost entirely for growing the various toxins used for immunizing the animals which produce the antitoxins. To the beef bouillon may be added from 10 to 20 per cent gelatin, which forms the plain or nutrient gelatin, used very extensively for making Stich or puncture cultures.

Various other substances may be added to the gelatin: of these glucose and litmus are the most important. For surface cultures 2 per cent agar (a dried sea-plant closely related to Irish moss, and found off the coast of East Asia) is added to the beef bouillon. The nearly transparent jelly formed by this mixture remains solid at all temperatures required for bacterial growth; consequently it is used very largely in propagating pathogenic germs that require a high temperature for their development. Glucose, glycerin and many other substances may be added to the plain agar, as desired by the experimenter. The glycerin-agar is perhaps the most important, and it is used very extensively for growing the bacillus of tuberculosis.

One of the most important points to be determined in making up all kinds of culture media is the amount of alkali to be added. For ordinary work 1 cc. should require about 0.18 cc. of N-20 sodium-hydrate solution to make it neutral when phenolphthalein is used as an indicator, and will be slightly alkaline when tested with litmus.

All artificial and most natural culture media, after being filled into the sterilized test-tubes (which are then plugged with cotton), must undergo fractional sterilization—that is, be heated for about thirty minutes on several successive days in live, flowing steam, which destroys all forms of life. If the media is to be used at once, the cotton plugs which prevent germs from passing into the tube will be sufficient protection, but if the tubes are to be kept for any time, or placed on the market, the protruding portion of the plug must be cut off, and the tubes capped with some preparation, as rubber, sealing-wax, etc., to prevent evaporation. In this work extreme care must be taken, else many of the tubes will be found infected within a few days. Even when the greatest pains have been taken, an occasional tube will show development. On no account should the tubes, after they have

been sterilized, be opened until the consumer is ready to use them, as contamination will almost invariably take place.

Some houses are listing as many as twenty different varieties of culture media, at a very low price. These are a great convenience to the investigator, relieving him of the trouble of preparing his own material.—*Bulletin of Pharmacy*.

Radiolaria; Two new Species from Barbados.

By HARRY J. SUTTON,

PHILADELPHIA, PA.

Staurococcura loculata, n. sp.

Phacoid shell three times as broad as the outer and eight times as broad as the inner medullary shell, with spongy surface, pores indistinct. Arms paddle-shaped, one and one-half times as long as the phacoid shell and

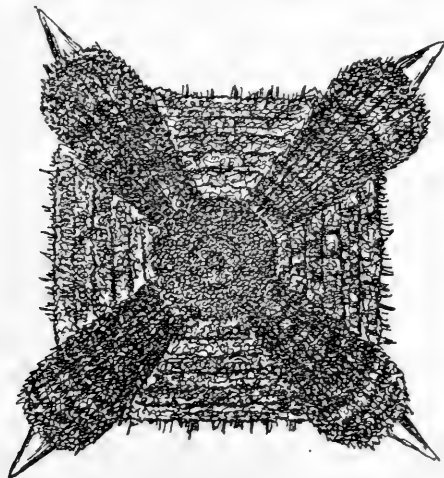

about four times as long as the phacoid shell and about four times as long as broad at the base, with pyramidal terminal spines at the distal ends, all spines

of the same length. Patagium incomplete but enveloping three-fourths of the arms, with six rectilinear parallel rows of chambers.

Dimensions: Diameter of phacoid shell 0.12, of the outer medullary shell 0.04, of the inner 0.015; length of the arms 0.18, basal breadth 0.06, distal breadth 0.10.

Habitat. Fossil in the rocks of Barbados.

Staurococcura cuneata, n. sp.

Phacoid shell about three times as broad as the outer, and eight times as broad as the inner medullary shell, with seven pores on the radius. Arms wedge shaped,

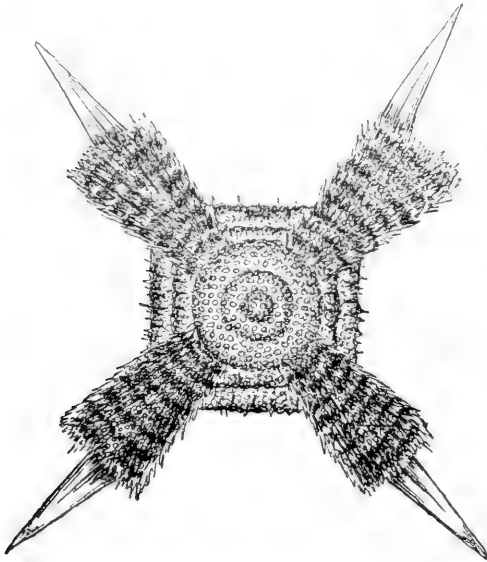

somewhat longer than the phacoid shell, with strong pyramidal terminal spine at the distal end. Two of the spines in one axis longer than the other two, nearly equaling in length the radius of the arms, and one of them in line on one side with the side of the arm bearing it. Patagium incomplete, enveloping only a small por-

tion of the arms, with two rectilinear parallel rows of chambers.

Dimensions: Diameter of phacoid shell 0.12, of the outer medullary shell 0.04; of the inner 0.015; length of the arms 0.165, basal breadth 0.045, distal breadth 0.09.

Habitat. Fossil in the rocks of Barbados.

Radiolaria; A new Genus and new Species.

BY REV. FRED'K B. CARTER,

MONTCLAIR, N. J.

Dicoccura, n. gen.

Definition:—*Coccodiscida* with two opposite chambered arms on the margin of the circular disk, without a connecting patagium. Medullary shell double.

Dicoccura brevibrachia, n. sp.

Phacoid shell two and a half times as broad as the outer and about seven times as broad as the inner medullary shell, with eight pores on its radius. Arms shorter than the diameter of the phacoid shell, slightly longer than

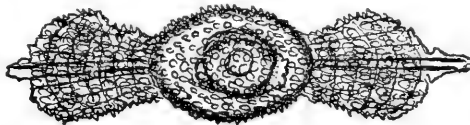

broad at the broadest part, at the base half as broad as long, at the blunt distal end rounded. Both poles of the common axis of the arms bear a strong terminal spine.

Dimensions:—Diameter of the phacoid shell 0.10, of the outer medullary shell 0.04, of the inner 0.014; length of the arms (without terminal spines) 0.08, basal breadth 0.04, distal breadth 0.066.

Habitat:—Fossil in the rocks of Barbados.

Note:—The basal and distal breadths are only approximate as the form was measured in side or three-quarter view.

Staurococcura clavigera, n. sp.

Phacoid shell a little more than twice as broad as the outer and four times as broad as the inner medullary shell, with spongy surface, pores indistinct. Arms club-shaped, not quite as long as the diameter of the phacoid shell, with short pyramidal terminal spine at the distal end, all spines of same length, two of them in one axis being off the middle of the ends of the arms on opposite sides.

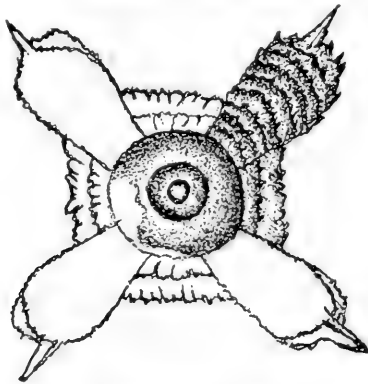

Patagium incomplete, enveloping only a small portion of the arms, with two rectilinear parallel rows of chambers.

Dimensions:—Diameter of the placoid shell 0.135, of the outer medullary shell 0.06, of the inner 0.03; length of the arms 0.12, basal breadth 0.04, distal breadth 0.075.

Habitat:—Fossil in the rocks of Barbados.

Note:—The name of the species of *Staurococcura* described on p. 96 of the March number of the JOURNAL should read *quaternaria* not *quarternaria* as three printed.

Microscopic Fixing Solution.—Zenker recommends (Munch, med. Woch.) the following fixing material for vegetable tissue; it penetrates the tissue readily without producing any shrinking: Distilled water, 100 parts; mercuric chloride, 5 parts; bichromate of potassium, 2.5 parts; sulphate of sodium, 1 part; glacial acetic acid, 5 parts.—Druggist's Circular.

Diatoms Found in a Fresh-water Deposit from Jones- port, Maine.

BY A. B. AUBERT,

ORONO, MAINE.

The deposit is of a light brown color consisting of fine sand, silt and diatoms. It is entirely modern, being in process of formation at present and greatly resembles the deposits so abundant in New England.

The list given below is by no means a complete one and only comprises those forms which are fairly abundant. I owe this specimen to the kindness of Mr. L. H. Merrill, of the Maine Experiment Station.

RAPHIDIEÆ.

- Amphora ovalis, Kutz.
- " affinis, W. Sm.
- Cymbella gasteroides, Kutz,
- " ehrenbergii, Kutz.
- " cuspidata, Kutz.
- " affinis, Kutz.
- " gracilis, Kutz.
- " cistula, Hemp.
- " heteropleura, Kutz.
- Encyonema caespitosum, Kutz.
- Stauroneis phoenicenteron, Ehr.
- " " var Baileyii.
- " acuta, W. Sm.
- " acuta, a very elongated variety.
- " anceps, Ehr.
- " punctata, Kutz.
- Navicula brebissonii, Kutz.
- " lata, Ehr.
- " nobilis, Kutz, type and vars.
- " major, Kutz.
- " viridis, Kutz.
- " divergens, W. Sm.
- " semen, Ehr.
- " amphigomphus, Ehr.
- " elliptica, Kutz.
- " iridis, var, Ehr.
- " tenella, Breb.
- " affinis, Ehr.

- Navicula amphirhynchus*, Ehr.
 " *cuspidata*, Kutz.
 " *gibba*, Kutz.
 " *polyonea*, Breb.
 " *inflata*, Grun.
 " *mesolepta*, Ehr.
 " *stauroneiformis*, Lewis.
 " *gigas*, Kutz.
 " *tumescens*, Grun.
 " *radiosa*, Kutz.
 " *gracilis*, Ehr.
 " *columnaris*, Ehr.

A *Navicula* very similar to figures of *Navicula incompta*, Lewis, but somewhat more elongate, striation fine, probably a variety, is more or less abundantly found.

- Gomphonema capitatum*, Ehr.
 " *olivaceum*, Lyng.
 " *acuminatum*, var. *coronata*, Ehr.
 " *vibrio*, Ehr.
 " *dichotomum*, Kutz.
Achnanthes exilis, Kutz.
 " *subsessilis*, Kutz.
 " *lanceolata*, Breb.

PSEUDO-RAPHIDIEÆ.

- Eunotia praerupta*, Ehr.
 " " var. *monodon*.
 " *major*, and vars. Rabb.
 " *arcus*, var. *plicata*, J. B and Fr. Heri.
 " *arcus*, Ehr.
 " *bidentula*.
 " *tridentula*.
 " *robusta*, var. *diadema*, Ehr.
Himantidium pectinale, Kutz.
 " " var. *minus*.
 " " var. *undulatum*.

Synedra ulna, Ehr.

- " " var. *vitrea*.

Meridion constrictum, Ralfs.

Tabellaria fenestrata, Kutz.

- " *focculosa*, Kutz.

Sarirella craticula, Ehr.

Nitzschia brebissonii, Kutz.

- " *sigmoidea*, Nitz.

" *amphioxys*, Ehr.

" *spectabilis*, Ralfs.

Comparison of the Fleischl, the Gowers and the Specific Gravity Methods of Determining the Percentage of Haemoglobin in the Blood for Clinical Purposes.

F. C. BUSCH, B. S.; A. T. KERR, JR., B. S.,

BUFFALO, N. Y.

Members of the American Microscopical Society.

Each year the importance of the clinical examination of the blood is becoming better recognized. In this examination there are two points to be ascertained which are generally acknowledged. These are, the percentage of hæmoglobin and the number and kind of red and white blood corpuscles.

For determining the hæmoglobin there are several methods. The hæmometer of Fleischl, the hæmoglobino-meter of Gowers and the spectroscopic method of Henocque, are fairly well known. None of the above methods employ the microscope, but a determination of the hæmoglobin is so intimately connected with a microscopical examination of the corpuscles of the blood, that we feel justified in presenting this paper.

It is recognized that there is a relation between the specific gravity of the blood and its percentage of hæmoglobin. Hammerschlag has constructed a table giving the hæmoglobin percentages corresponding to the different specific gravities of the blood.

Under the direction of Dr. Williams, professor of pathology in the university of Buffalo, we have made observations upon over 100 patients in the Buffalo General, the Erie County and the State hospitals.

In these observations we have compared the specific gravity method of Hammerschlag with the hæmoglobino-meter of Gowers and the hæmometer of Fleischl.

Fleischl's hæmometer consists of a colored wedge, with a graduated scale attached; a well with two compartments, one for pure water and the other for diluted blood;

and a capillary pipette for measuring the blood. The blood obtained, by puncturing the finger, is drawn by capillarity into the pipette, from which it is washed into one of the chambers of the well.

Here it is thoroughly mixed with the water. Both compartments are then filled with water and the well is covered by a glass plate. The well is placed upon the stand so that the compartment filled with distilled water is over the colored wedge. This is moved by a screw until its color corresponds to that of the diluted blood in the other compartment. The percentage of hæmoglobin is then read off from the attached scale. In using the Fleischl, artificial light is necessary, daylight being excluded.

The hæmoglobinometer of Gowers is usually manufactured with but one colored tube, which is for use with daylight. There is another form in which there are two tubes, one for use with daylight and the other for artificial light. The one which we have used is of the former kind. It consists of a sealed tube filled with a glycerine-jelly solution of carmine and picro-carmine of the color of a one-per-cent solution of normal blood; another tube of the same diameter to hold the blood to be tested; a pipette graduated to 20 cu. mm. and a stand to hold the two tubes, side by side. The blood measured in the pipette is mixed with a small quantity of water in the graduated tube; water is then added until the dilution corresponds in color to that of the standard solution in the other tube. In making the comparison it is necessary to hold the instrument against a white background, opposite the source of light or directly between the eye and the window.

The method which we have used for determining the specific gravity, and thus the hæmoglobin of the blood, is not so well known as the above and will therefore bear a more detailed description. It is one used by

Hammerschlag and depends upon the well-known physical principle that a body which will float indifferently in a liquid is of the same specific gravity as that liquid. For this purpose, two liquids are taken, one of a higher and the other of a lower specific gravity than that of the blood, with neither of which it will mix. The necessary apparatus consists of a hydrometer, hydrometer jar, chloroform and benzole.

In using this method, the finger is pricked and the blood thus obtained is introduced into a mixture of chloroform and benzole in the hydrometer jar. The drop of blood, since it will not mix with either chloroform or benzole, retains its spherical form. If the drop sinks the mixture is too light and must be made heavier by adding chloroform. If it rises the mixture is too heavy and must be made lighter by adding benzole. By carefully adding one or the other a point is reached where the drop of blood will neither rise nor sink, but will float indifferently in the mixture. At this point the specific gravity of the blood is the same as that of the mixture. By means of the hydrometer we can obtain the specific gravity of the mixture and thus at the same time that of the blood.

It is desirable to use a medium-sized drop of blood and it is better not to divide this into several. Care must be taken, however, to mix the liquids thoroughly by stirring with the glass rod. In order to facilitate mixing, it is well, when the liquid is too heavy, to add an excess of benzole and bring it back to the desired point by adding chloroform. The latter being heavier, sinks and thus mixes more readily with the mixture.

We have found it convenient to obtain the blood from the palmar surface of the middle finger of the left hand, and have used, for this purpose, an ordinary sharp-pointed steel pen with one nib broken off. A new pen may be used for every test and should be sterilized by heat. The

finger also should be washed with some antiseptic, in order to take every precaution against infection. This method of obtaining the blood was used by us for the three instruments.

For introducing the blood into the chloroform-benzole mixture, a pipette of fine calibre may be used. A sufficient quantity of blood is drawn into this and expelled in the middle of the mixture. Care should be taken that all of the blood is not blown out, but that some remains in the tip of the pipette. That which has been expelled will usually adhere to the pipette as a large drop and must be shaken loose. By thus holding back a small portion of blood, the liability of mixing air with the drop is avoided as much as possible.

E. Lloyd Jones, of Cambridge University, uses a modification of the method of Prof. Roy. This, which depends upon the same principle as the preceding, consists in the use of numerous solutions of glycerine and water, the specific gravities of which are known and which are successfully tried until one is obtained corresponding in specific gravity to that of the blood.

His apparatus consists of twenty to twenty-five one-ounce glass bottles filled with standard solutions of glycerine and water, differing one from the other by .001 of specific gravity; a number of fine glass pipettes drawn out to a point and bent at right angles near the tip; a cylindrical glass jar of about one dram capacity; and a number of clean, sharp suture needles. After puncturing the finger on the dorsal aspect near the root of the nail, the blood which exudes of itself or after the finger has been quickly squeezed, is drawn into one of the pipettes. This is introduced into one of the standard solutions and the blood gently blown out. The solution chosen is of high or low specific gravity according to the appearance of the patient. The bent point of the pipette prevents

the blood from being given an impetus up or down when blown from the end.

According to whether the specific gravity of the blood is equal to, greater, or less than that of the solution, it will pursue a horizontal course, sink or rise. By trying a number of solutions one may be found in which the blood neither rises nor sinks, or two are found in one of which it rises and in the other sinks. In the last case the specific gravity of the blood is between the two.

In our experience with the Gowers' instrument, we have found it very unsatisfactory. It is often quite impossible to get the tint of the diluted blood to correspond to that of the standard one-per-cent solution. Even when this is attained, a difference in shade may be produced by looking at the instrument somewhat from the side instead of straight from in front; by holding the paper for reflection farther away from or nearer to the instrument; by holding the instrument between the eye and the window or by moving farther away from the window. In the last case, in several instances, the differences produced by moving twenty feet away from the source of light, was fifteen per cent, the blood requiring to be more diluted when farther from the window and thus giving a higher reading. These tests were made in a hospital ward on a day of average brightness. Therefore it may be seen that in addition to the other sources of error, the nature of the day, whether it be bright or cloudy, will make an appreciable difference.

We have frequently disagreed in our readings of the same test in both Fleischl and Gowers and others also have differed from us as to when the proper shade was attained. In using the Fleischl instruments, in comparison in the same cases, we have generally found a difference in reading between the two. In thirty per cent of these comparisons the difference was as much as ten per

cent. We have also found that in one-fifth of our cases we disagree in our readings of the same instrument.

We have found it a great inconvenience in making bedside tests in a hospital ward, to run to some other part of the ward or building (to a dark room). In order to obviate this difficulty we have adopted the following device: This consists in our instrument bag-fitted with a cardboard cover; at one end of this a hole is cut for the passage of a lamp chimney; at the other end a small hole for looking through the well of the instrument, and at one side of this a window with a flap for inserting the hand to move the wedge.

Hammerschlag's method has the advantage that there is no color test. Every one must agree as to whether the drop rises or sinks or stays where placed. It is also very inexpensive, all that is necessary being a hydrometer jar, chloroform and benzole. The method of Roy and Jones necessitates keeping on hand a large number of solutions which require careful standardization and must be re-standardized at frequent intervals. Although this method may be better where a large number of cases are to be examined in a short time, yet for the ordinary observer who uses a method of this kind less often and upon a small number of cases, the one which we have used seems preferable.

In both methods, Hammerschlag and Jones have found that there is no appreciable difference due to variations of temperature in the room.

The results which we have obtained in making parallel tests with the above described methods, may be summarized as follows:

The readings of the Fleischl ran as a rule from ten to fifteen per cent lower than the percentage estimated from the specific gravity. The readings of the Gowers ran a few per cent lower than the specific. The Gowers' instrument is liable to an error of at least fifteen per

cent depending upon the intensity of the light. The Fleischl instrument is liable to an error of about ten per cent. In the specific-gravity method there is liability of error from two sources. The drop of blood may adhere to the sides of the jar, or some air may become mixed with it. These errors in the specific-gravity method are reduced to a minimum by careful manipulation.

The greatest error in this last method may be due to the table, since of the cases from which Hammerschlag constructed his table, a great number were primary anæmias and chloroses. For these his table would probably be more accurate than for our cases, as all the anæmias which we examined were secondary. Our cases were taken as ordinarily found in hospital wards, both medical and surgical, and covered a wide range of diseases.

We are convinced from the experience of others and from our own observations that all of these methods are liable to considerable error. Osler says that the error in the Fleischl instrument may not be more than two per cent in blood, which is nearly normal, but cites Neubert and Letzius as having shown that in a much impoverished blood the error may be as much as twenty per cent.

The specific-gravity method has the advantage of cheapness and convenience; of taking but little blood, and of not being a color test. This last is of the most importance since the accuracy of the test does not depend so much upon the judgment of the individual, and makes it practical for observers who lack sufficient appreciation of colors and shades.

In following up a case with a color test, an error of five per cent too low might be made at the first reading, and one of five per cent too high at the second and the patient be supposed to have improved to that extent, when, in reality, his condition had remained unaltered. With

the specific-gravity method this error is less likely to occur.

It has been found that while the specific gravity may vary at different times of the day, being influenced by sleep, food, drink, exercise, etc., the hæmoglobin, under similar conditions, varies also.

*From the Laboratory of Pathology,
University of Buffalo.
August 21, 1895.*

On the Flagella of Motile Bacteria.

BY VERANUS A. MOORE.

WASHINGTON, D. C.

Members of the American Microscopical Society.

During the past three years several new methods of demonstrating flagella have been announced. Up to the present, however, a perfectly satisfactory process has not been devised and the results obtained by different workers have been in many instances quite contradictory. The efforts to fix upon the flagella specific characters have also failed, although much advance has been made in that direction.

THE NATURE OF THE FLAGELLA.

Notwithstanding the somewhat definite results which have been obtained in reference to the structure of the flagella, it appears to be of the highest importance that their nature should be more fully determined before they are accepted as constant and integral parts in the morphology of individual bacteria. The examination of a large number of preparations stained by the same method, and frequently a single specimen, will reveal quite different appearances. In some instances, and in my experience on a large majority of the bacilli, the flagella appear as appendages radiating from the body (nucleus according to Bütschli) of the organism. I have occasionally observed

a narrow unstained or more feebly-tinted band separating the body of the organism from a deeply-stained ring of which the flagella appeared to be projections. This capsule-like appearance has been illustrated by several observers. Bütschli, Zettnow and others hold that the part of the bacillus which is easily brought out by the ordinary staining methods is the nucleus only, and that the additional portion of the organism demonstrated by Loeffler's method is plasma which surrounds the nucleus. Hæckle, on the other hand, states that they have no nuclei. For this and other reasons he refers bacteria to the animal kingdom, placing them in the first class of Archezoa.

Farrier has recently published a series of interesting experiences in which he shows that flagella on a single species of bacteria—as determined by the study of several forms—are subject to variations according to the conditions under which the organism is cultivated. Thus he found that *Bacillus coli communis*, cultivated at the temperature of the body, possessed several flagella, but when grown at a much higher temperature (46°C. maximum temperature for this bacillus) flagella could not be detected. If grown at 44°C. a few of the individual bacteria possessed these appendages. The age of the culture and the presence of a non-fatal quantity of an antiseptic in the culture media were likewise found to have appreciable effects. He states that this pleomorphism is due to their protoplasmic nature; the hypothesis assumed being that when the bacteria are subjected to degenerative agencies, such as high temperatures or antiseptics, the plasma contracts in a ball-shaped mass (presumably about the organism), but when the bacillus is again brought under favorable conditions the plasma resumes its motile form.

Accepting this explanation, it is difficult to understand why the motile bacteria possessed of capsules such as

Micrococcus lanceolatus are not, under certain conditions motile, or why the methods employed satisfactorily in staining the capsule will not act as well in bringing out the flagella. I have tried repeatedly to stain the flagella after these methods, but more particularly the one used by Prof. Welch in staining the capsule on *Micrococcus lanceolatus*, but invariably the results have been negative. Why there should be such a marked difference between the motile and non-motile forms in the reaction of the "capsular" plasma to staining fluid has not yet been explained.

I have sought for an explanation of the structure of the flagella-producing substance in the cilia or flagella of the zoospores found in certain of the fungi, but thus far my efforts have not been rewarded, although much assistance may be obtained from a study of those forms. It is quite probable that certain observed phenomena, especially in reference to the free flagella and the formation of the rings and hooks frequently observed both on the distal ends of the flagella, and separated from them, may be explained by the same theories as those of zoospores. There are two views as to the disposition of the flagella of swarm spores. One is that they are cast off, and the other that they are absorbed into the body of the spore. Rothert shows, in a recent article, that both views are correct. "In the second swarm stage of saprolegnia and in the peronosporæ, the flagella are either cast off as soon as the spores come to rest, or soon after, or else they remain attached to the spore indefinitely even after germination.

In the first swarm stage of saprolegnia, however, he found, to his surprise, that they are uniformly drawn back into the body of the protoplasm, the withdrawal being slow at first, and then quite rapid. The loops are formed either while the flagella are attached to the spores, or after they are cast off." He suggests the possibility that the flagella are formed out of special cytoplasm existing

only in small quantities. It is highly probable from certain opinions and results herein cited, that there is a close resemblance between the flagella of bacteria and those of the swarm spores.

The observations of Stocklin and Bunge that several bacilli are sometimes included within the same capsule from the periphery of which flagella radiate is exceedingly interesting. This phenomenon is explained in two ways, one that the surrounding plasma of two or more bacilli runs together, thus enclosing the bacilli in a common capsule, and the other is that the variable number of bacilli included within the same capsule is due to the multiplication of the organism within the capsule. These observations strengthen the hypothesis that bacteria have nuclei and surrounding plasma.

EDITORIAL.

Passing Slides Through a Custom House.—I have today spent three half-hours at the Georgetown Custom House getting a lot of slides which Mr. Hornell had sent me. If any private concern did business in the style in which Dorsey Claggett, Collector for the District of Columbia, does business, that concern would go bankrupt in a very short time. But I must say first that not an unpleasant word was uttered on either side, though I claim some virtue for not freeing my mind regarding some of the absurd things that transpired.

My slides were invoiced at £2.10.0 and as "natural history specimens." I was politely offered a seat while a hunt was made for the box, which was not found till after some search. An employe cut open the package and threw away the string and seal without saying to me "by your leave." I think the law permits me to open the package for their inspection.

"Oh! mounted slides," said the clerk who forthwith made out a bill for

DUTY ON \$12.00 @ 35 PER CENT \$4.20

and asked me to write my name in approval thereof. I declined, and appealed to the Collector, who presented himself. This I did, notwithstanding my belief that a Collector knows absolutely nothing, whatever is known in the C. H. being known by the subordinates. This was the signal for four or five clerks to rally to the support of the figure-head whose only claim to office so far as I know is his knowledge of ward politics.

To my emphatic statement that I knew these objects entitled to free entry and that scores of lots of such goods were entering free all over the country, one of the by-standing mouthpieces of the collector proposed that I pay the duty and go into an effort to get this great and glorious humbug of a Customs service to pay it back to me. Think of a collection agent on being told that his claim was baseless saying such rot even to women and children! And Dorsey Claggett did not correct his over zealous clerk. I did. I said that I supposed the Collector wished to ascertain his duty and perform it properly without complicating matters in that way. He consented to be flattered in this manner. Thereupon the law was brought out and here is the clause under which the bill had been made out :

SCHEDULE B., § 102.—GLASS AND GLASSWARE.—“ All stained or painted glass windows, or parts thereof, and all mirrors not exceeding in size 144 sq. inches with or without frames or cases, and all manufactures of glass, or of which glass is the component of chief value, not specifically provided for in this Act, thirty-five per centum ad valorem.”

The glass in this lot of slides is not worth over one dollar. If they are to be taxed as “manufactures of glass or of which glass is the component of chief value,” then an honest collector would appraise the goods at their value as manufactured glass or at about one dollar ; but this incompetent (I will not say dishonest) man took the invoiced price of \$11.71 as *slides* and put the 35 per cent *glass* tax on it! Then he had the gall to ask me to pay it and try to see if I could get it back again.

I then informed the crowd that I claimed free entry under Schedule A, ¶ 625, which declares free of duty.—

“Specimens of natural history, botany, and mineralogy when imported for cabinets or as objects of science and not for sale.”

But, said the oracle, these are microscopic slides and not specimens of natural history. I asked Politician Claggett if he doubted their being specimens of natural history and he said he doubted it. He said, however, that if I would come again in a few days they would meanwhile look into the matter and decide. I remarked on the inconvenience they were putting me to on account not of mine but of their ignorance. A brilliant clerk then quoted this part of the law:

“Microscope slides with mounted specimens of anatomy as N. E. manufactured articles, twenty per centum ad valorem.”

If I could not pay 35 per cent perhaps to get away from these quibblers I would pay 20 per cent? Oh! no. I was not claiming specimen of anatomy.

Then decisions were sought for and one made in 1892, was read to me at full length by the Honorable Collector himself who mispronounced but one word in the feat. The decision was to effect that an anatomical specimen could not be encased in a glass slide and that to claim slides as anatomical specimens would not hold.

The Collector's law clerk apologized by saying that there were later decisions but that “they had not had time to get them together.” A new oracle next appeared and said in all the sincerity of ignorance: “These slides do not contain the real objects, but only prints or casts, as it were, of the natural history objects.” Hence, slides are not free under the clause cited. The Collector then looked at the transverse section of a stem under a microscope and declared it his opinion that it was only a print. He thereupon moistened a rubber eraser with ink, made a print with it on paper and said that was the way he supposed what he had seen under the microscope was made. His oracle

said that casts and prints were dutiable. I got warm enough to challenge them to find a single microscopist or microscopical slide to back up this absurdity and I told the oracle, who said that he had served under the previous administration, that he must pardon me for telling him he was grossly ignorant of the subject.

The collector said he would inform himself in the next few days. Would I come again? I said he ought to take the trouble to send the goods to me when he had satisfied all his curiosities in the matter. Thereupon a clerk appeared with the following decision:

(*Synopsis No. 15310—G. A. 2744*).

Specimens of Natural History on Microscope Slides, free.

Before the U. S. General Appraisers at New York, August 21, 1894.

In the matter of the protest, 23416 b—149, of Dr. Mathias Cook against the decision of the collector of Customs at Albany, N. Y., as to the rate and amount of duties chargeable on certain specimens of natural history, imported per U. S. mail, June 20, 1894.

OPINION BY WILKINSON, GENERAL APPRAISER.

The articles are diatoms, spiculas, foraminiferas, and polycistines mounted on microscope slides. They were assessed for duty at 60% under ¶ 108 N. T. and are claimed to be exempt from duty as specimens of natural history under ¶ 712.

From inquiry at the American Museum of Natural History, we learn that the common, if not the only, way of preparing and preserving minute objects of this character is on microscope slides.

We find that the goods are specimens of natural history imported as objects of science and sustain the protest.

(Synopsis of the decisions of the Treasury Department, and Board of U. S. General Appraisers on the construction of the tariff, navigation and other laws for the year ending Dec. 31, 1894, p. 730).

The clerk "guessed" that Collector Dorsey Claggett might admit my slides under that decision free of duty. The other clerks acquiesced. Claggett said not a word but went away. In due time I was presented with the following bill:

Storage, labor and drayage.....	.10
Blanks25
Overtime of officers.....	.00
	—
	.35

I was much surprised that no charge was made for the time of four clerks an hour each. It certainly was overtime and excess of zeal.

My impressions are that this was a deliberate attempt to impose a swindle upon me and that the law clerk knew from the beginning, of the decision he finally produced. A less careful person might have been blackmailed into paying the \$4.20. Had I shown any temper or impoliteness, especially to "his Honor," they could have pestered me for weeks over the matter and until I had got the attention of the Secretary of the Treasury and his order to over rule their absurd decisions. It is perhaps impolitic for me to publish these facts. In case these people get another lot of goods for me they will have it in their power to annoy me very much.

This is, however, my second experience with them. A year or more ago, Watson & Sons of London sent an electrotype which had cost them 87 cents. It was stopped in the mails and held by the Custom House. A great ado was made over it. Not one of the officials then present knew what to call it and one of them with it in his fingers asked me if it was not a lithograph! Its value was in any event too small to be dutiable but I was put to quite a loss of time and patience. The ignorance of these people seems stupendous and they appear to rely on customers to give themselves away and to furnish implements with which to persecute them. This is the worst governed country among the leading nations of the earth say Andrew D. White and others. My own observations at home and abroad confirm the view.

Finally, if you import slides be very cautious or the Customs people will worry the life out of you. Be sure to have the decision quoted above; plant yourself against all delays, concessions, and foolishness. Go and vote for the party that is out of power so that there may be a new set of fool-officials as soon as possible. When we decide to do as Great Britain does,—collect all our revenue off of tobacco, wine, perfumery and a few of the simplest objects of luxury we may be free from supporting in public office ignorant hoards of superfluous politicians and probably not till then.—C. W. S,

Second Pan-American Medical Congress.—The dates assigned for the meeting in the city of Mexico are Nov. 16—19, 1896. Those who desire full information regarding it should read the medical periodicals which are printing the Special Regulations or should address Dr. Chas. A. L. Reed, East Walnut Hills, Cincinnati, Ohio.

Especially those who intend to present papers need to know the rules relating thereto. All papers must be presented in writing and abstracts must be furnished to the secretary on August first.

MICROSCOPICAL APPARATUS.

Cover-Glass Forceps.—To those who are familiar with microscopic technique the following illustrations of a cover-glass forceps devised by me are self-explanatory. Clinical microscopy demands the simplest as well as the most rapid methods consistent with accuracy. None of the many

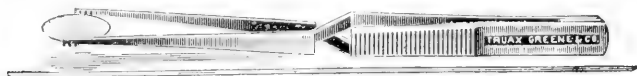

cover-glass forceps now in use are adapted to modern microscopic work. For staining sputum, pus, blood, etc., the complete process, from fixing to placing of cover-glass on slide, may be carried out while cover-glass is held in forceps.

The following advantages are claimed for these forceps:

1. The cover-glass while on its flat side can be rapidly picked up from any surface whether glass, marble, wood or

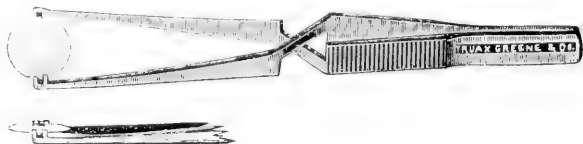

- paper.
2. The cover-glass is held level, firmly and anatomically.
3. No possibility of cover-glass slipping out of or breaking while held in forceps.
4. Hands of operators

are kept free from stains and acids. 5. The edge of only cover-glass being grasped and held by forceps, admits of the whole surface of the cover-glass being stained. 6. Cover-glass can be drained by placing forceps on the side.

These cover-glass forceps are manufactured and sold by Chas. Truax, Green and Co., of Chicago. Every pair of forceps, if properly made, possesses the above mentioned advantages over the clumsy forceps formerly used.—Journal of American Medical Association.

MICROSCOPICAL MANIPULATION.

New Method of Preparing Culture Media.—The attention of all bacteriologists is earnestly invited to the following method, which we sincerely recommend:

Dr. J. Lorrain Smith points out the difficulty bacteriologists have to contend with in the fact that the composition of many of the media used for cultivations of pathogenic microbes differ so widely from that of the blood and other fluids found in the animal tissues. He describes a method by which media can be prepared directly from these fluids by a process which reduces the difficulties of manipulation to a minimum.

Break up the white of a hen's egg with an egg-beater till it loses its consistency; add 40 per cent of water and mix well; pass the mixture through muslin to remove any shreds of insoluble material; add 0.1 per cent of caustic soda, and solidify in the autoclave. With a little care in clearing it a jelly of egg-white can be obtained which closely resembles gelatin in consistency. Substances like glucose can be added if desired.

A large variety of bacteria have been found to grow on this medium with readiness.—Langsdale's Lancet.

Simplifying the Examination for Tubercle Bacilli.—Prof. Rindfleisch states (*Deutsche Med. Woch.*) that tubercle bacilli are found in greatest number in the liquid, and not in masses of mucus of the sputum, and recommends the following method for their detection: Dip a camel's

hair pencil in water so as to moisten it well, and press out the surplus water. With this stir the sputum thoroughly and on withdrawing it, although nothing will apparently cling to it, it will be full of bacilli, if they are present in the sputum. With it stroke the cover glass lightly, so as to make a uniform coating over it. Of course a new pencil must be used for each operation, as it has been found practically impossible to free the pencil from traces of bacilli, which might invalidate subsequent examinations.—Druggist's Circular.

BACTERIOLOGY.

The Effect of the "X" Rays upon Micro-Organisms.—The assertion that the "X" rays may have some therapeutic value, and may perhaps modify the course of disease when passed through the body, has been made by a number of persons, and it is a claim which may easily be misused by the charlatan. Dr. T. G. Lyon of London recently made some experiments on the influence of these rays in cultivations of diphtheria bacilli. They were exposed in the incubators for twelve hours to the "X" rays. The bacilli continued to grow and were not in the least modified by the conditions to which they were subjected.—Medical Record.

Bacteria in Milk.—At a recent meeting of the Edinburgh Royal Society, a communication on bacteria in milk as supplied in Edinburgh, and the relative efficiency of different methods for their removal, by Dr. Hunter Stewart and Dr. J. Buchanan Young, was read by the former. Dr. Hunter Stewart said that in all civilised countries the Legislature had taken steps to prevent the watering of milk; but perhaps it was of greater importance that children as well as adults should be preserved from those diseases which were produced by the presence of micro-organisms in milk. Cowhouses in this country were not kept with that careful and punctilious cleanliness with which they were kept in Holland and Denmark. The

animals were not groomed, the cowsheds were not flushed with water so often as they ought to be; the hands and clothing of the milkers were not properly attended to, nor were the teats of the udder cleaned. In November, 1894, experiments were begun in Edinburgh, and continued until now. More than 300 samples of milk were examined from 50 dairies, widely scattered over the city. It was found that at three hours after milking there were, on an average per cubic centimetre, in winter 24,700 bacteria, in spring and early summer 44,000, and in late summer and autumn 173,000. It was found that in dairies supplied by milk from the country the average number of micro-organisms five hours after milking was 41,000 per cubic centimetre, while in dairies supplied by milk from town dairies the average was 352,000 per cubic centimetre. This fact illustrated the importance of having cowsheds outside of the city. In discussing the various methods of sterilising milk, it was pointed out that the great objection to the use of sterilised milk was the change of its flavor and, according to many, its decreased digestibility. The conclusions were that milk kept for one hour at 212 degrees, in bottles hermetically sealed remained sterile for more than a month, and was quite sweet and palatable, though it had a boiled taste; that milk heated by means of Dr. Cathcart's apparatus remained quite sterile for forty-eight hours, though the boiled taste was marked; that milk kept for thirty minutes at 158 degrees, Fahr., was quite sterile at the end of twenty-four hours, and contained very few microbes at the end of forty-eight hours. In all these three methods the micro-organisms of tubercle and diphtheria were certainly killed. Scalding at 176 degrees, Fahr., with every precaution, kept the milk sterile for twenty-four hours; but in carrying out this process on a large scale, there was considerable risk of post-scalding contamination, so that there was no guarantee that the bacillus of tubercle and diphtheria, if present, was destroyed.—English Mechanic.

The Fate of Micro-organisms in Inspired Air.—Thompson and Hewlett (British Medical Journal, Jan. 18, 1896)

gave a preliminary report on the fate of micro-organisms in inspired air. The following experiment shows that certain bacteria deposited on the Schneiderian membrane are rapidly removed: Cultures were prepared from the vibrissæ and mucous lining of the nose. No red growth developed, so the bacillus prodigiosus was absent. A looped needleful of a pure culture of the bacillus prodigiosus was then deposited on a spot on the septum, and cultures were made from this spot and its neighborhood at intervals up to two hours. The cultures gave a gradually diminishing number of the bacilli, until after eighty minutes frequently no growth occurred, while after two hours no trace of the bacillus prodigiosus could be detected. The authors state that their recent experiments show that nearly all the organisms in inspired air are arrested before reaching the naso-pharynx.—Medicine.

Diphtheria Antitoxin in France.—Henri Monod states that during the first six months the diminution of death rate was 65.6 per cent in 108 cities in France, having a population of over 20,000. From 1884-1894, the average number of deaths was 2,627 (*La France Medicale*, 12-20-95.) Dr. P. Palet from his observations in diphtheritic wards in Lyons, also finds that it has notably lessened the number of deaths. Its action is more prompt when treatment is commenced at the beginning. As a prophylaxis it has been made in doses of from 1 to 2 cc.; it causes no inconvenience except the temporary eruption (*l.c.* 1-24-96.)

Antifebrile Reaction of Tuberculin.—Dr. Lussen as a result of some tuberculin tests, thinks that this agent has an antifebrile action in cases where there is febrile condition without the presence of tuberculosis, and further a sedative action upon the lungs. The substance is perfectly harmless unless tuberculosis is present. (*The Journal of Comparative Medicine and Veterinary Archives*, XVII, 299.)

Micrococcus Lanceolatus.—Divers organisms are associated with pus formation. This organism ranks third in the production of human inflammations, osteomyelitis, pe-

riostitis, labor pneumonia, broncho-pneumonia, arthritis, abscesses in parotid and thyroid glands, in the kidney and liver, Dr. J. H. Etheridge reports three cases of ovarian abscesses formed by it. (The American Journal of Medical Science, CXL, 377.)

Black Death.—Ketasalo has ascertained that the "black death" amongst animals in Hong Kong is due to a bacillus which causes a septicaemia attacking the lymphatic system, the spleen, and it might therefore easily be mistaken with anthrax in animals. The bacillus is rounded at the ends, colors with the usual aniline dyes, more deeply stains at the end than in the middle. The organism may be found in the blood. The organism occurs in man, mice, rats, swine, and the spread of the disease in China is to be accounted for solely on the filthy habits of the Chinese. Clothes are not changed or washed for years. Chinese frequently herd together with their swine. The disease may be contracted by eating diseased meat. (Veterinary Journal, XLII, 311.)

Germ Content of Air.—Prof. H. L. Bolley in a paper on cleanliness in handling milk, says bacteriological considerations tell us that gelatin plate $3\frac{1}{2}$ inches exposed to air one minute contained the following number of germs.

Ordinary living room five minutes after sweeping 543 germs, eight species. (Fargo.)

In open meadow, when quiet, 6 germs, two species. (Madison, Wis.)

Open meadow October, quiet, 8, three species.

College cow stable between the cows after feeding time, October, 570, eleven species. (Madison, Wis.)

University creamery and cheese factory, pasteurization room, after scrubbing, August 21, 5 germs, three species. (Madison.)

Refrigerator, store room temperature 40, F. one species. (Madison, Wis.) (Bull, 21, N. Dakota, Agr. Exp. Sta.)

Bacteria in Milk.—Prof. H. L. Bolley, finds the following number of germs per cc. in milk, July 16, at Madison, Wis.

Full mixed morning and evening milk 33 patrons, separated, sweet, 8,999,801. July 17, same milk on ice one day after addition of formalin 1-500, sweet 1,439,820. Same as last but four days on ice, sweet, 15,339,040. Fargo, N. D., full mixed milk of 11 cans, cultures made immediately 85,-254. (Bull. 21, N. D., Agr. Exp. Sta.)

Schizomycetes—Dr. W. Migula treats the Schizomycetes in “die Naturlichen Pflanzfamilien.” He notes that they are mostly colorless, some are slightly rose or green colored. Spores are of two kinds arthrospores and melospores in addition to the ordinary vegetative propagation. The chlamydobacteriaceae produce gonidia as in Cladotrix, Phragmidotrix, Thiothrix and Streptothrix. The gonidia germinate soon after leaving the mother plant. He has made some changes in nomenclature. It is wrong to base genera on biological characters as Photobacterium, Nitrosomonas, etc. Bacteria are divided into five families: 1 Coccaceae, 2 Bacteriaceae, 3 Spirillaceae; 4 Chlamydobacteriaceae, 5 Beggiatoaceae.

Some of the old genera as Staphylococcus is no longer retained but the Staphylococcus aureus becomes Micrococcus pyogenes aureus Parset et Rosenbach. In the second family three genera are distinguished, Bacterium, Bacillus, Pseudomonas. The genus Bacterium is without motion. Bacillus anthracis becomes Bacterium anthracis (Koch et Cohn) Migula, B. tuberculosis, Bact. tuberculosis (Koch) Migula. The cholera spirillum is called Microspira comma (R. Koch) Schroter. The work is accompanied with excellent figures but our only wish is that it could have been more extended.

Bacteria in Excrement of Bovines.—Dr. E. Wuthrich and Dr. E. v. Freudenreich who have studied the influence of feeds on the bacterial contents of excrement of bovines state that hay contains 7,500,000 germs per grain, one-fourth of these organism were Bacillus subtilis. Sour potatoes had 5,000,000 germs per gram, 10,000 of these were Hay bacillus, (B. subtilis). Malt contained 375,000,000 germs per gram. In the latter, Bacillus lactis aerogenes was common.

In all of these feeds there was a notable increase in the number of organisms. The animals fed with hay the number of *B. subtilis* colonies found varied from 1,800,000 to 7,200,000 per gram. The colon bacillus was always present. The number of organisms found in excreta when hay was fed varied from 20,675,000—375,000,000. Grass 1,800,000—10,000,000. Sour potatoes 7,062,500—23,125,000. What appeared to be *Bacillus lactis aerogenes* in malt was destroyed in the digestive tract. (Centralblatt f. Bakt. u Parasitenk. II abth. 873.)

MEDICAL MICROSCOPY.

The Tuberculous Handkerchief.—Cornet it was who first, in an effective way, brought evidence of the great part which the sputum of the consumptive plays in spreading lung-tuberculosis, when the sputum is permitted to dry and to become reduced to dust. He showed also how the consumptive's handkerchief reinfects the patient himself and endangers his associates. As Dr. Jaeger, of Stuttgart, says:

“And now what is the further fate of this suspicious article? As would be done with the clothing of typhoid or cholera patients, it is not put into a solution of carbolic acid, but it is folded together and carefully kept until, after several or many days' use, it becomes a cloacal miniature, a nidus, of the most dangerous of germs. Further, when it is to be retired for a while, it is not disinfected, but the careful housewife preserves the costly fabric, the precious piece of embroidered linen, until—she counts the wash for the laundry. The dried handkerchief is then torn open, a cloud of dust is whirled into the air, and with the dust the disease germs which bid defiance to drying.”

The Microscope in Surgery.—Dr. Senn in a recent work on tumors states that the microscope is not so serviceable in diagnosing tumors as many suppose, and cites as an instance the late Emperor Frederick of Germany. Small

pieces of tumor or scrapings of tissue should not be sent to the pathologist simply to see what the microscope will reveal or what the pathologist knows. The object is to obtain a correct diagnosis, and to this end as large a piece of tumor as possible should be sent for examination. It should be accompanied with a history of the case and all other points, such as site, character of growth, etc. In this way the microscope usually decides when the appearance to the naked eye throws doubt on the character of the tumor.—Medical Record.

PHARMACEUTICAL.

The Microscope as an Advertiser.—Druggist Stedem, of Philadelphia, contends that much advertising benefit can be derived from proper microscopical exhibitions in the pharmacy. He hesitated for a long time, fearing that meddlers would try to tinker with the apparatus, but finally picked out a strong instrument—his next best microscope—and placed it in the window, protected only by the sign, “Look, but please don’t touch.” During the two months which followed, only one person of all the hundreds taking a peep, put a finger on the adjustment. Mr. Stedem first took up the ordinary house-fly, and week by week showed legs, feet, head, wings and body. The display aroused much interest, especially among school children. He is now preparing slides of other insects, and purposes displaying them in a still more powerful instrument.

Mr. Stedem’s idea is capital, and may be developed further. For example: so much is written nowadays about disease germs, what is to hinder the display of the diphtheria germ, the bacillus of typhoid fever, of tuberculosis, etc.? Many objects of popular interest may thus be exhibited under the microscope, and the advertising benefit ought to be considerable.—Bulletin of Pharmacy.

MICROSCOPICAL SOCIETIES.**Quekett Microscopical Club.**

The 340th ordinary meeting of this club was held on Friday, March 20th, Mr. J. G. Waller, president in the chair. The minutes of the preceding meeting were read and confirmed, ballot for new members taken, the additions to the library announced. Mr. Rousselet read a paper "on *Rattula collaris*, and other Rotifers." Mr. E. B. Green read a further "Note on Root-Hairs," accompanied by some beautiful drawings, which he presented to the club. In answer to questions Mr. Green said all his observations had been made on common plants; no greenhouse was required, and he had contrived a small case holding about 20 pots which would stand in any window, and by means of which his experiments could easily be repeated and extended. Mr. Karop gave an account of the life-history of the Mycetozoa, illustrating his remarks by colored diagrams and black-board drawings. After noting the literature of this interesting subject, he recommended every intending observer to procure Mr. Lister's "Guide to the Brit. Mycetozoa," published by the trustees of the British Museum, and to be had at South Kensington, or of the authorized booksellers, price 3d. It contained a list of all the known indigenous species, and was well illustrated. The secretary said that as the first Friday in April was Good Friday, the usual conversational meeting would, of course, not be held. The next ordinary meeting was on Friday, April 17th, and on the 18th, an excursion to the Royal Botanic Gardens.

The 341st ordinary meeting of this club was held on Friday, April 17th. Mr. E. M. Nelson, exhibited and described a new doublet bull's eye which Mr. Baker had made to his formula, giving a minimum of spherical aberration. By projecting the image of a lamp flame on a wall he showed that the usual "fluffy" margin was very materially reduced, and he thought where it was necessary to fill a large field

with light as free as possible from spherical aberration, as, for instance, in photography, this form would answer every requirement. Mr. R. T. Lewis read a note on a stridulating organ in a species of ant *Streblognathus athiopicus*, from South Africa, accompanied by specimens, microscopical preparations, and some beautiful drawings. He said that although sound-producing organs were known to occur in several kinds of ants, the present one differed materially in structure, and so far appeared unique. When captured the insect gave an audible "squeak." It was a formidable-looking creature, black, and nearly one in. in length, and it appeared to have a wide distribution in South Africa.

On May 2nd, 16th, and 30th there will be excursions for collecting purposes to Esher, Totteridge, and Epping Forest on these dates respectively.

NEW PUBLICATIONS.

"Keil's Medical, Pharmaceutical and Dental Directory."—George Keil, Editor, Philadelphia, announces the early publication (fourth edition) of "Keil's Medical, Pharmaceutical and Dental Register-Directory and Intelligencer," for Pennsylvania, New York, New Jersey, Maryland, Delaware and District of Columbia. Its list of National colleges, State hospitals, homes, dispensaries, societies, and post-office addresses of physicians, druggists and dentists, school of graduation and year, all the latest laws in these States, will be complete to date of issue, as a personal canvass will be made for data. It is the only Directory published for above-named States, registering graduates of all schools, physicians, druggists and dentists, and imparting all information needed by the professions mentioned in their daily practice. No effort will be spared to make the Directory complete, and the information accurate and reliable in the minutest detail belonging to the domain of medical, pharmaceutical and dental professions. An experience of thirty years is sufficient guarantee that all subjects will be properly treated in this DIRECTORY. The names in large cities, in addition to being in alphabetical order, will be numerically arranged by streets, also an alphabetical list of names of the whole Directory, giving the page of each; these features will no doubt be appreciated.

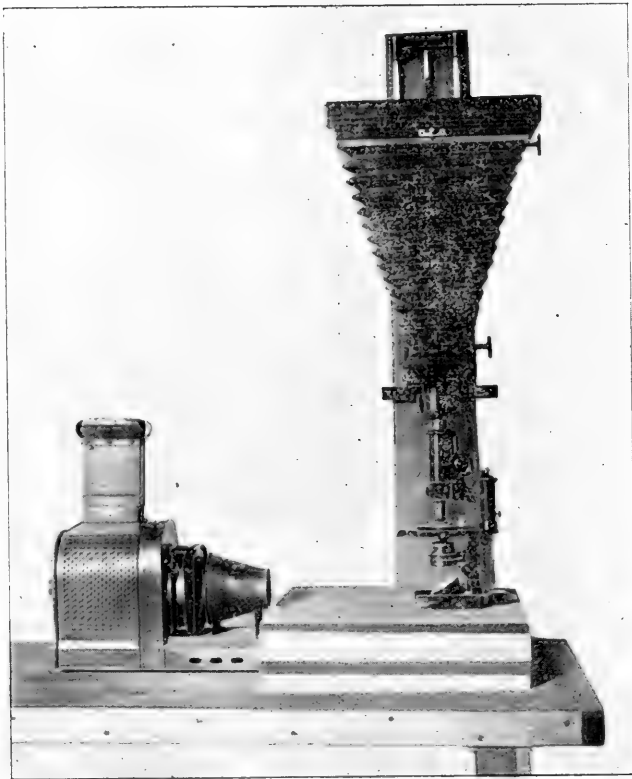

FIG. 1.—PHOTOMICROGRAPHIC APPARATUS ARRANGED
FOR USE WITH OIL LIGHT.

By courtesy of Medical Record.

THE AMERICAN
MONTHLY
MICROSCOPICAL JOURNAL.

VOL. XVIII.

JUNE, 1896.

No. 6

Practical Photomicrography.

By W. C. BORDEN, M. D., F. R. M. S.,

CAPTAIN, MEDICAL DEPARTMENT, U. S. ARMY.

WITH FRONTISPIECE.

With the extensive use of the microscope in medicine and scientific research the need has been felt of obtaining exact pictorial record of many of the objects seen. Drawings, either free-hand or by aid of the camera lucida, are extensively used, but they are of necessity always more or less diagrammatic and often fail to give the necessary exactness, both from the impossibility of eliminating the personal equation of the draughtsman and from inability to reproduce the appearance of organic structure by line and stipple. Photographic processes, on the other hand give pictures which in detail of form and structure are second only to the objects themselves; and the value of good photomicrographs as aids in teaching and for comparison, for future reference, and for publication, is generally accepted as unequalled, and their use is becoming more and more common.

But the extensive use of photomicrography has been prevented by several causes. These causes are complexity of apparatus, supposed difficulty of technique, difficulty of obtaining proper and always available light, and supposed large amount of time consumed. In view of these objections and of the value of the results obtained, all simplifications of technique and apparatus

are of value and for the practical and more general application of photomicrography, while the results must be of the best, the time consumed must be small, the manipulations must be simple, and the apparatus must be one with which photographs can be taken at any time.

In the early days of photography, when the wet plate only was available, sunlight was necessary to photographic processes, and the traditions derived from its use cause many still to consider it essential to the production of high-class photomicrographs. With the introduction of the dry plate, artificial light became available, and in spite of its small actinic power, relative to that of the sun, certain advantages connected with its use have given it many advocates. It is not necessary to enter into an extensive comparison of the relative optical, visual, and actinic value of sun and artificial light. Much has been written in favor of one and derogatory to the other. The fact remains that equally good work has been done with both. But for practical work artificial light has many advantages. Sunlight is uncertain; it varies in intensity from hour to hour of the day and with the time of year. It is apt to be obscured for days together or by passing clouds at critical moments, and, at most, is available but for a few hours of the twenty-four. Also, the sun is constantly changing its position relative to the instrument, and when used for all except the highest power of the microscope, its image when focused on the plane of the object covers too small a field, and the heat and undesired colored rays have to be filtered out with light and heat filters. It is true that the latter disadvantages can be overcome by suitable but complicated apparatus, but the great objection of unavailability, except at uncertain times, still remains, and in consequence when sunlight is depended on, many valuable records are lost from inability to photograph objects at once after their observation. For these reasons sunlight is not available

for practical work. Practical work requires a steady, always available light, and these requirements can only be met by some form of artificial light.



Fig. 2.—Apparatus arranged for photomicrography with acetylene light. To show the acetylene burner it is placed outside the lantern. The camera is racked up so that the operator may arrange the object and substage.

By courtesy of Medical Record.

Artificial light being necessary, the question of kind arises. So far as results are concerned almost any form may be used, provided it is properly used. Most of the

objections made to artificial light have arisen from its improper employment. The main requirements in the light are simplicity and ease of manipulation. These combined with proper adjustment will give an effective light. The electric light, the oxyhydrogen light, the magnesium light, gas light, oil light, and, latest, acetylene light, have all been employed for photomicrographic purposes. The electric, oxyhydrogen, and magnesium lights all require rather complex apparatus, and they are all open to this objection, together with certain other objections pertaining to each. Of the magnesium light it may be said that no practical apparatus for its production has been devised. Electric light necessitates connection with an electric plant. It is expensive and the apparatus required is complicated. In the form of the arc light it gives a very satisfactory and powerful light, and it is probably the best form of artificial light for large institutions when used in the manner hereafter described for oil and acetylene light and with heat filter added. Aside from its power, second only to sunlight, it possesses no advantage over cheaper and more easily handled lights. The oxyhydrogen light is expensive and is troublesome to manage. It requires a complicated apparatus and does not give a light of sufficiently greater power over oil, gas, or acetylene to compensate for the trouble involved in its management.

For practical work there remain, therefore, oil, gas, and acetylene light. These are all easy to manage, they are best used in a similar manner, with similar apparatus, and for advantages of cheapness, steadiness, and controllability are unsurpassed. They differ in illuminating and actinic power, oil light being lowest, and acetylene light highest. Oil and gas light are of very nearly equal power, but they have not generally been considered powerful enough except for low and medium powers.

This objection does not obtain when these lights are properly used or when used with orthochromatic plates. The ordinary commercial dry plates are mainly sensitive only to the more actinic rays of the violet end of the spectrum, and oil and gas light being deficient in these rays, photography with such plates and yellow-rayed light necessitates long exposure and generally gives im-

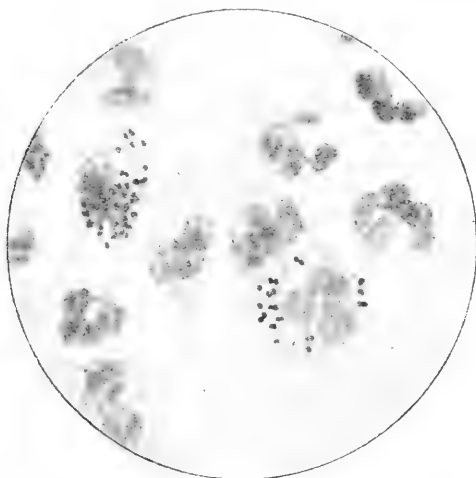

Fig. 3.—Gonococci in urethral pus. $\times 1,200$ diameters. Exposed two minutes to acetylene light with yellow-light filter, using Zeiss' two millimetre apochromatic objective, projection eyepiece No. 4, and with Abbe achromatic condenser in substage. The preparation was double stained with methyl-blue and eosin. The gonococci and cell nuclei being of a color complementary to that of the light filter are indistinct; the cell bodies being of a similar color to the screen, are indistinctly photographed.

By courtesy of Medical Record.

perfect results.' As with sunlight, the difference between the visual and actinic focus enters as a disturbing factor, necessitating troublesome and uncertain adjustments or the employment of specially constructed objectives. Also the violet sensitive plate, owing to the like actinic coloring of many stained objects, often fails in development to give sufficient contrast for printing purposes. The ortho-

chromatic plate does away with all these difficulties, arising as they do from complex conditions of differing visual and actinic focus, of working objectives not suitable for photography, and of plates sensitive to the light rays of the wrong end of the spectrum. The orthochromatic plate is sensitive to yellow light. In artificial light, oil and gas light especially, yellow rays predominate, and when such light is used the projected image is mainly formed by yellow rays, and if the image is received on a plate sensitive to yellow, the visual and actinic focus will coincide with any objective, whether it is specially corrected for photomicrography or not. Also the yellow sensitive plate is so actinically sensitive to the yellow light that proper molecular change is produced in its silver compounds, causing in development sufficient contrast with almost if not quite all stained objects and so greatly shortening the exposure that it compares favorably with those made by sunlight. For these reasons oil, gas, or acetylene light, properly used in combination with orthochromatic plates, gives the important necessity, an always available light, and one which is at the same time cheap, steady, easy to manage, and which can be used with ordinary working objectives with the certainty that if they give sharp visual definition they will give good definition photographically.

The remaining desideratum is an apparatus which shall be so simple and easy to manage that it can be connected with the microscope and the projected image photographed with little trouble and with a minimum expenditure of time.

The following is descriptive of an apparatus and method which have been adopted by the writer after much experience in photomicrography. The means and method are believed to be sufficiently simple and effective to warrant the assumption that by them photomicrography may be employed for practical work.

The apparatus consists of a camera hung in a vertical position, of a microscope with substage attachments, objectives and eyepieces, and a stereopticon, such as is used with oil light for projection purposes, in which is placed an oil lamp, or gas or acetylene burner. This apparatus is secured on a low strongly built table, and should either be in the laboratory or in a convenient adjoining room. This furthers its practical use, for when in working a field is found a photograph which is desired, the

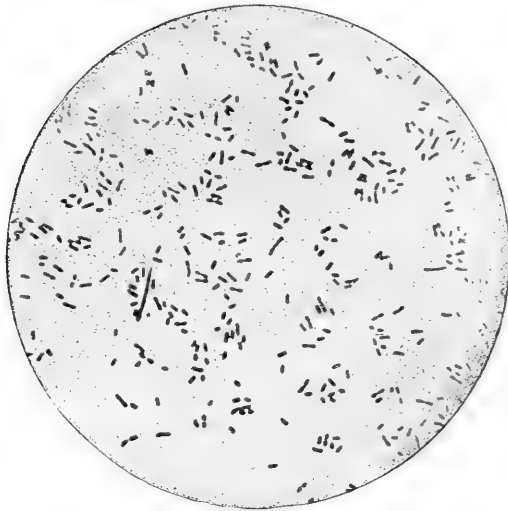

Fig. 4.—Colony of *staphylococcus pyogenes aureus* floating on liquefied gelatin. $\times 30$ diameters. Exposed twenty seconds to oil light, using Beck one-inch objective; no eyepiece or substage condenser.

By courtesy of Medical Record.

microscope has only to be carried to the apparatus, placed in position, the light lighted, adjustments made, and the camera racked into position. With a conveniently placed dark room, the whole photographic operation will take but a few minutes. The working microscope should always be used for photography. By using the same microscope for both purposes the trouble and loss of time

incident to changing the slide from one stand to another and refinding a given field is avoided. Every worker, especially in bacteriology, knows the difficulty and time spent in refinding a field once lost. The microscope stand may be of any well-constructed form. Any stand which can be depended upon for clinical or laboratory work can be used for photomicrography. For all-around photographic work it should have a substage ring and adapter for using objectives as substage condensers. A mechanical stage is convenient but not necessary. The microscope is used in the upright position. This position rather than the horizontal is to be preferred for several reasons. The upright position is necessary when movable objects, as colonies of bacteria floating on liquefied gelatin (Fig. 4), are to be photographed, or when, as in clinical photomicrography, photographs have to be made of urinary deposits. In bacteriological work, when bacteria are stained on the cover glass and examined or photographed before the balsam is dry, the cover is apt to slip if the microscope is used horizontally; but this does not occur with the microscope used vertically.

The horizontal position and long extension of camera is necessary for some classes of work, particularly when large pictures have to be taken and when it is desired to obtain high amplification by extension of camera rather than by high eyepiecing, or when test diatoms have to be photographed with very high amplifications. For practical work, however, up to amplifications of one thousand diameters, and for photographs for illustration or reproduction, which are seldom required of over three and one-half or four inches in diameter, the upright position of microscope and camera is much to be preferred, on account of its ease of application and practical advantages.

The vertical position of the microscope necessitates a similar position for the camera. To allow easy working distance the camera is hung on a rackwork attached to a

rigid upright, which is placed to the right of the microscope so that it will be out of the way while working. Both the upper and lower ends of the camera are movable on the rackwork. The upper end which carries the screen and the plate holder is movable, in order that different amplifications within limits may be obtained with the same

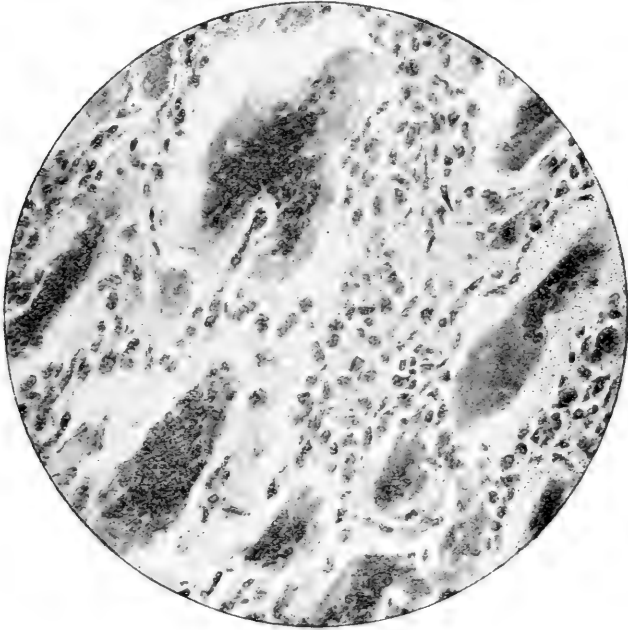

Fig. 5.—Giant-cell sarcoma. $\times 275$ diameters. Section stained with borax carmine. Exposed twenty seconds to acetylene light, using Beck $\frac{1}{8}$ inch objective, working eyepiece A, and Bausch & Lomb $\frac{2}{3}$ -inch objective in substage.

By courtesy of Medical Record.

objectives. The lower end is movable that it may be racked up out of the way and allow the operator to manipulate the microscope before attaching the camera (Fig. 2). This is a great advantage, for the operator can seat himself at the instrument, adjust the object to the centre

of the field, focus and adjust the substage, and arrange the illumination easily and effectively.

The camera bellows has an extension of two feet measured from the eyepiece of the microscope to the ground glass. This with a continental-model stand, a two-millimetre objective and projection, or working eyepiece No. 4, gives an amplification of one thousand diameters. With lower objectives and less extension of bellows amplifications ranging down to five diameters may be obtained. In focusing the operator can, by standing on a low box, observe the image on the ground glass and manipulate the fine adjustments of the microscope without using a focusing rod, though a suitable rod with cord passing around the milled head of the fine-adjustment screw can be easily attached to the upright if desired.

THE LIGHT.—A good and efficient light may be obtained by using an oil lamp, or gas or acetylene burner, properly adjusted in the body of a projection stereopticon with the projection ocular removed.

Of the three acetylene is much the best, and for illuminating and actinic power, combined with simplicity of apparatus and management, it is the best artificial light now obtainable for use in photomicrography. It can be easily and safely generated and stored ready for use, its making and use necessitating little if any more trouble than is connected with keeping an oil lamp in order. After experience with sunlight and various artificial lights I until recently settled down to the use of an oil lamp, believing it or gas to give when properly used the best light for practical purposes. Recently I have been using acetylene generated and burned in an apparatus furnished by a concern in Chicago, Ill., and find it unequalled for practical work.

The gas is generated in a small generator and burned in a small burner placed in the lantern body (Fig. 2). If ordinary illuminating gas is used the burner is placed in

the lantern in the same way, and when oil is employed a tri-wick lamp with only the middle wick lighted is used in the lantern. The large double condensers of the lantern serve to concentrate the light, while the double lantern body prevents the radiation of heat to the microscope and shuts off all radiating light. These are great advantages, for not only is the illumination improved by the concentration of light but the microscope does not

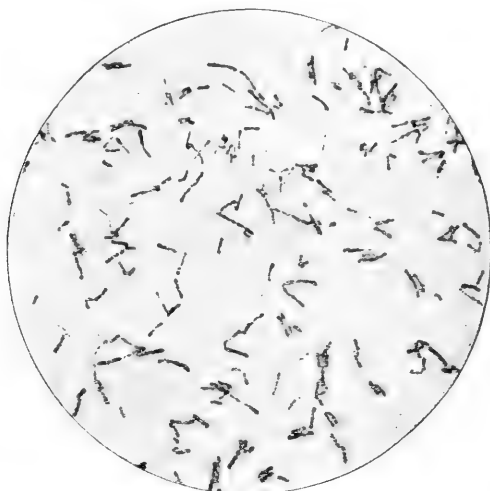

Fig. 6.—Klebs-Loeffler bacillus, grown on blood serum, stained with Loeffler's methyl blue. $\times 1,000$ diameters. Exposed two minutes to oil light with yellow-light filter, using Zeiss' two-millimetre apochromatic objective, projection ocular No. 4, and Abbe condenser in substage.

By courtesy of Medical Record.

become heated, and if the room can be darkened, as it should be, by adjustable window shades, the absence of extraneous light greatly facilitates focusing on the camera screen. This method of using oil or gas light renders them sufficiently powerful for practical purposes and with acetylene gives great illuminating and actinic power. With oil light used without a light filter, bacteria can be photographed with amplifications of one thousand diam-

eters with exposures of from one and one-half to three minutes. Oil and gas lights are themselves so yellow that with them light filters are only required when photographing very difficult objects, such as methyl-blue stained gonococci or Klebs-Loeffler bacilli (Fig. 6). When a light filter is used, a light yellow one of an aqueous solution of bichromate of potash placed in a glass trough gives excellent results. With it, exposure is somewhat lengthened, being from three to five minutes for amplifications of one thousand diameters.

With acetylene light a light filter is more frequently required. This is due to the greater whiteness of the light and its consequent effect when transmitted through actinic-colored objects. With it most stained sections of tissue photograph well without a filter, the exposure required being very short, usually varying from five to thirty seconds. When a light filter is used the exposure is lengthened, but is short compared with that required with oil or gas light, being about two minutes for amplifications of one thousand diameters (Fig. 3). A good filter for acetylene light is made by dissolving ten grams of potassium bichromate in two hundred cubic centimetres of water and using at a thickness of three centimeters in a parallel-sided glass trough.

ADJUSTMENT OF THE APPARATUS.—The camera being hung on the rackwork, the microscope is placed beneath it and the lantern is fixed about twelve inches in front of the microscope, with its central long axis in a plane which extends through the centre of the microscope mirror, the substage condenser, the objective, ocular, and centre of camera.

The light (oil, gas, or acetylene) being lighted and placed in the lantern, a stage micrometer is placed on the microscope stage and a medium-power objective and eyepiece are attached to the microscope. Light from the lantern is reflected on the micrometer by the mirror of

the microscope. The observer accurately centres the micrometer rulings, then removes the eyepiece and projects the image of the micrometer rulings on the camera screen. The microscope is then moved to such position that the centre of the projected micrometer image is exactly in the centre of the screen. This position of the microscope is marked once for all, and whenever afterward the microscope is placed in the same position the

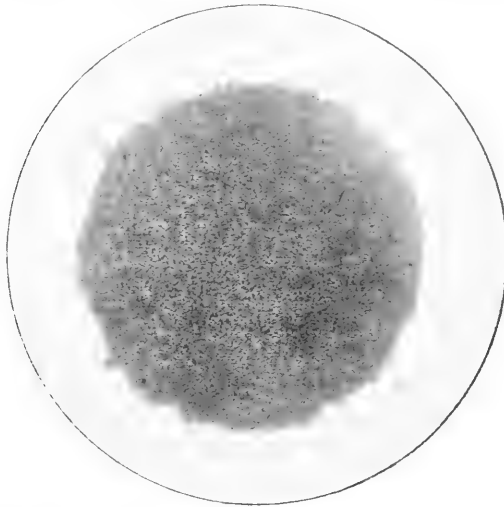

Fig. 7.—Typhoid bacillus, grown on glycerin agar, stained with carbol fuchsin. $\times 1000$ diameters. Exposed two minutes to oil light, using Bausch & Lomb 1-12-inch oil-immersion objectives, amplifier in draw tube, and Bausch & Lomb 1-5-inch objective in substage.

By courtesy of Medical Record.

centre of the object will be projected on the centre of the screen. The position of the lantern directly in front of the microscope should also be marked.

ADJUSTMENT OF THE LIGHT.—Proper adjustment of the light is very important in working with artificial light, for upon this its efficiency depends. It must be properly placed relative to the lantern condensers and the light from them must be properly concentrated upon the ob-

ject. In photographing with all but the lowest powers some form of substage condenser is necessary. This is due to the fact that the light must be focused on the object to give proper definition. In working with objectives of from eight millimeters up to but not including oil-immersion objectives, it will be found advantageous to use objectives of lower power as substage condensers, for if so used in ordinary observations they greatly improve the definition of objects. In fact, it may be laid down as a general rule that whatever gives the best microscopic definition will give the sharpest photographic image. Consequently in high-power work it will seldom be necessary to change the microscope attachments when a photograph is to be taken, for in bacteriological work the ordinary Abbe condenser which gives good definitions will, when properly adjusted, give good photographic definitions, statements to the contrary notwithstanding.

To adjust the light and substage condenser proceed as follows: With microscope and lantern in position and substage condenser centred, place the light to be used inside the lantern body, place an opal or ground glass between lamp and microscope, attach a low power objective, and, seated at the microscope, focus the objective accurately on the object. The opal glass is used to reduce the light which otherwise might injure the observer's eye. The ground glass is then removed, a fine wire screen placed close against the front of the lantern condenser, and by means of the substage condenser an image of the screen is projected on the object. The screen is then removed and a white card held above the eyepiece of the microscope with one hand, while with the other the light is moved about inside the lantern body until the image of the light projected on the card appears oval in form and equally brilliant in all parts. If the light is placed too near the condensers, there will be dark

spaces on each side of the illuminated field; if too far away, the centre of the field only will be bright. If the light is a point or small disc the properly illuminated field will appear perfectly round; with the elongated oil or acetylene flame it will appear oval. The light once properly placed should be fixed for future work.

With the light fixed and position of microscope determined, the operation of photographing is comparatively simple. When the observer finds a field which he desires to photograph, the microscope is carried from the working-table to that of the apparatus, placed in the marked position, and the light lighted. The operator then seats himself at the microscope, attaches the proper objective and substage attachments, focuses the former on the object and the latter on the wire screen placed against the lantern condenser, removes the screen, substitutes the opal glass, and, if using an Abbe condenser, opens or closes the condenser until the sharpest visual definition of the object is obtained. The opal glass is then removed and if required a light filter is placed between the lantern and microscope. The working eyepiece is then removed, a projection eyepiece inserted or an amplifier placed in the draw tube, or, if it is desired to use the objective alone, a tube of black paper, to prevent reflection, is placed in the tube of the microscope. The camera is then attached to the microscope and the projected image focused on the camera screen, preparatory to exposure.

In regard to the method of projection of the image much has been written regarding the relative value of using the objective alone, or with an amplifier in the draw tube, or with the ordinary working eyepieces or projection eyepieces of Zeiss. Practically, for all except the highest-power diatom method, equally good results can be obtained by either method, though where much work is to be done there are some advantages in the use of the projection eyepieces.

For photographing the projected image orthochromatic plates should be used. Of these I have used the Cramer rapid "isochromatic" exclusively, though probably other makes of orthochromatic plates might be found to work equally well. Certainly the "isochromatic" work so well that there is no necessity for going through the trouble of orthochromatizing plates one's self.

In developing I have obtained best results with formulas in which hydrochinone alone or with some other reducing agent is used. The following give clear negatives of sufficient contrast and graduation :

No. 1

Water.....	300
Sodium sulphite	25
Potassium bromide.....	0.5
Hydrochinone	1.5
Methol.....	1.5

No. 2

Water	15
Sodium carbonate.....	300

Use equal parts of No. 1. and No. 2.

Development should proceed slowly and should be continued until sufficient density is obtained. Rapid development and removal from the developer before sufficiently density is obtained are to be particularly avoided in photomicrographic development.

A few reproduced photomicrographs are given in illustration of the methods outlined. They have been selected as representing ordinary practical work with different objectives and lights and with different means of projection and substage attachments.

Leprosy is said to be spreading in the Russian Baltic provinces with alarming virulence. Several hundred persons are said to be afflicted with the disease, and the Livonian Diet has just taken measures for isolating them at the cost of the State.

Influenza in Infants and Children.

SOME DIAGNOSTIC AND THERAPEUTIC HINTS.

By L. FISCHER, M. D.

At various times, and chiefly when pneumonia and diphtheria and other infectious diseases predominate, we find a series of symptoms which frequently baffle the physician. Moreover, they simulate, by the pains in the limbs, muscular rheumatism; the catarrhal, gastric and enteric symptoms will simulate gastroenteritis, or the coryza and cough will remind the attendant of the onset of either measles or a severe form of bronchitis, possibly pneumonia. It is very infectious, the period of incubation very short, and, unlike most infectious diseases, one contact does not protect from subsequent epidemics; that is, relapses are common.

The mortality is exceedingly high; the disease is exceedingly contagious and is frequently transmitted from an adult to the children in the immediate neighborhood, sometimes on the same day or within two or three days after one member has been stricken.

The disease is caused by a micro-organism which has been designated the "influenza bacillus," and has been described by R. Pfeiffer in the *Zeitschrift für Hygiene und Infections-Krankheiten*, No. 13, and can be cultivated on agar containing hæmoglobin. The bacillus is found in the blood of infected children, also in the expectorations—chiefly, however, from the nose, throat and lungs.

This germ was simultaneously discovered by Canon in 1892. It is a small, specific organism, about the same diameter as the bacillus of mouse septicæmia, but only about half as long. They are usually solitary, but may be united in chains of three or four elements. They stain rather poorly, excepting with such concentrated penetrating stains as carbol-fuchsin and alkaline methylene

blue, and even with these the bacilli stain more deeply at the ends than in the middle, so that they appear something like diplococci.

For the demonstration of the bacilli in the blood, Canon recommends a rather complicated method. The blood is spread upon clean cover glasses in the usual way, thoroughly dried and then fixed by immersion in absolute alcohol for five minutes. The stain which seems best is Czenzynke.

R	Concentrated solution methylene blue	40	parts.
	0.5 per cent solution eosine in 70 per cent		
	alcohol.....	20	“
	Distilled water.....	40	“

The cover glasses are immersed in this solution and kept in the incubator from three to six hours, after which they are washed in water, dried and then mounted in Canada balsam.

By this method the erythrocytes are stained red, the leucocytes blue, and the bacillus, which is also blue, appears as a short rod, or even as a dumb-bell. The bacillus does not grow in gelatine or upon ordinary agar.

We encounter quite a difficulty to describe a certain set of symptoms, for the type of the attack varies from time to time in different localities, so that we rely in the diagnosis of this disease on various factors, chiefly the one that influenza is epidemic at the time, and perhaps that other members of the household have suffered. The diagnosis must therefore be made by a process of exclusion in very young infants.

We need not be surprised to find various types of this disease in infancy; as previously mentioned in this paper, namely, the form known as gastro-enteric type and the pulmonary type, for we find that the ordinary so-called pneumonia diplococcus can and frequently does cause at one time an otitis, at other times a meningitis.

It is in this manner that the influenza bacillus some-

time infects and affects the pulmonary regions, causing either a malignant form of so-called epidemic bronchitis or a pneumonia, and at other times it will affect the gastro-enteric system.

The only pulmonary symptom is fever, the temperature rising to 102° and even 105° F. The child is heavy and drowsy, and appears to have pain in the limbs. This condition lasts in all a day or two, the temperature sinks, and the child is well again.

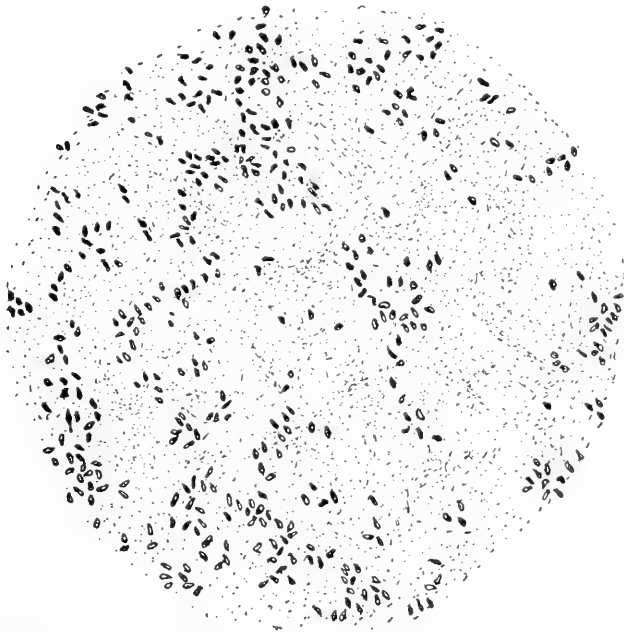

This is in the simple form of influenza, but if we have a more protracted course the temperature may keep on rising in the evening, falling in the morning, for a week or two weeks at times before reaching normal.

In the worst forms we may have an attack ushered in with a convulsion, with vomiting; severe meningeal symptoms may manifest themselves, and finally the child recovers without leaving any trace of this infection, so

that these cases are really very puzzling, especially those in which we have a rise and fall of temperature, with either mild pulmonary or moderate gastric-enteritic complications.

Older children have attacks similar to those witnessed in adults, that is, the neuralgic pains are less marked, but there is headache, at times rigors. The attack is always sudden, the temperature running up to 103° F or more, sore throat, headache, the conjunctivæ are injected sometimes there is an earache. Frequently the tonsils are enlarged and covered with small follicular points resembling diphtheria. At times the glands may be enlarged in the neck secondary to the tonsilitis. An interesting point is the fact that frequently an eruption similar to scarlet fever is present, and it is very hard to differentiate it unless we are positive of the existence of an epidemic of influenza, and furthermore that the rash disappears in a short time. Retro-pharyngeal abscess is a very frequent sequel to influenza. So also have I seen several cases of empyæma secondary to a severe attack of the grippe.

Let me illustrate. A child, R. F., seven months old, was attended by Dr. A. Bienenstock on March 9, with a diarrhœa and an acute bronchial catarrh. Two days later he found the lower lobe of the left lung consolidated, the bronchi full of mucus. The treatment ordered did not relieve the engorgement of the lungs. The child did not improve, but had a coryza, cough, suffused eyes, temperature 101.6°; as Dr. Bienenstock told me, had all the appearances of a child about to develop measles. But an additional symptom; wherever the child was touched it commenced to scream.

I saw this case in consultation with Dr. Bienenstock, and found the entire left lobe consolidated, and diagnosed influenza of the pulmonary type. I ordered salicylate of soda 3.0 with essence of pepsin 60 0, a teaspoonful every

two hours. This child recovered in a few days, but an older child there developed similar symptoms of coryza, cough, pains, tenderness of being handled, anorexia, suffused eyes, and besides abdominal pains.

The interesting fact about these two children would hardly be made clear but for the point that the mother had been suffering with headache, coryza, pains in the limbs and back, for about a week. It was self-evident from the influenza present that the mother had infected the child, and about two days later the older child was infected from either mother or its youngest sister.

Such cases can be enumerated by the dozens. On March 4 I saw a case, in consultation with Dr. Samuel Friedman, which was characteristic of a most malignant type of influenza, complicated by a pneumonia and also by a typical meningitis; child about two years old.

Two days later, through the courtesy of Dr. L. Kohn, I saw in consultation a case of a mild type of a catarrh which extended from the nose and throat into the bronchi, simulating a croupous bronchitis, really a malignant form of influenza. Such cases occur so frequently that we must differentiate carefully, and sometimes resort to the process of exclusion in making the diagnosis.

The treatment of influenza is very simple, in fact really symptomatic. I invariably resort in all cases of influenza to the stimulating effect of a mustard foot-bath, by taking about an ounce of the strongest mustard, immersing it in water of about 90° F., bathing the feet and constantly raising the temperature of the water by the addition of hotter water until the temperature reaches 110° F.; in all I bathe about five minutes. The bath should be followed by gentle friction of the extremities, and they must be carefully enveloped in hot towels or blankets. In addition to this, it is a good plan to aid diaphoresis by giving liquor ammonii acetatis, the ordinary spiritus mindereri, a teaspoonful every two or three hours for

children one to two years old; one-half the quantity for children below that age. The drug most favored by me is salicylate of soda. This I have given one grain for each year every two or three hours, depending on the urgency of the symptoms, so that a child five years old would receive five grains every two or three hours, and a child ten years old ten grains every two or three hours.

The ordinary rules of therapeutics apply as well in influenza as they do in all diseases. Thus, for example, the alimentary tract must be kept perfectly clean, and if there is not a good movement once in twenty-four hours the compound infusion of senna should be given to a child in doses of three or four teaspoonfuls in three or four hours, and if this is followed by copious stools, then an enema consisting of a half teacup of glycerine and one-half teacup of warm water should be administered quite high into the rectum. By placing the child on its side this can be easily accomplished.

The diet should be very bland, and solid food excluded through the course of an attack of influenza. The best mode of feeding is to give concentrated soups, farinaceous food, soft eggs, oysters, milk, broths, koumyss, and if the vital powers are considerably reduced, then Rudisch's sarco peptones or Valentine's meat juice, given preferably in soups or milk, should be administered.

For the severe pains in the limbs, I have found gentle massage beneficial, in some cases with vaseline, in others with alcohol, using the massage two or three times a day over the back, arms and legs.

Whilst stimulation is not called for, it is a wise plan to administer alcohol occasionally. But if the pulse is feeble, then I have seen good results following the administration of one-half teaspoonful of whiskey in a teacupful of boiled milk, with the addition of the yolk of a raw egg in sugar. This milk punch, as it were, can be given in doses of two or three teaspoonfuls, ice-cold.

In other cases Tokay wine may be required, and in influenza more than in any other disease we find that it is necessary to individualize the treatment.—*Clinical Recorder*.

Twelfth Annual Exhibition of the Washington Microscopical Society, May 12, 1896.

LIST OF EXHIBITS.

- Dr. G. G. Acker—Human muscle (voluntary). Injected lung (human).
 Dr. W. W. Alleger—Bacteriological exhibit (motile and non-motile forms).
 Dr. E. A. Balloch—Fœtal blood. (Showing nucleated red corpuscles).
 Dr. F. V. Brooks—Merexide.
 Mr. H. H. Brown—Six slides illustrating human eye. Bacteria. Section of wood. Section of rock.
 Dr. C. T. Caldwell—Plated horse hair, onyx and quinine crystals; pigment cells in skin or frog.
 Mr. F. T. Chapman—Electric spark, representing 1-150th of a horsepower.
 Mr. P. C. Clafin—Pond life; life in stagnant water; diatoms.
 Dr. A. B. Coolidge—Transverse section of spinal cord (human).
 Mr. H. H. Doubleday—Circulation of blood in tail of fish; Brazilian chalcidony (polarized); sori of ferns, showing development; seed of orchids.
 Mr. O. C. Fox—Roling sand (polarized).
 Dr. E. A. Gibbs—(Studies in Marine zoology); Coelenterata (Sertularia pumila, Obelia geniculata); Mollusca; (Creseis acicula); Crustacea, (larva of Scyllarus aretus); Vertebrata. (Amphioxus lanceolatus.)
 Mr. John Grinstead—Vorticellæ.
 Dr. H. H. Hawxhurst—Urinary casts (Bright's disease).
 Dr. E. F. King—Leukæmic blood; human blood, normal (stained).
 Dr. D. S. Lamb—Human kidney (double stained).
 Dr. J. Melvin Lamb and Dr. Collins Marshall.—12 slides showing embryo, 52 days' development. (56 mm. length, sections 1-1000 inch).
 Mr. J. E. Maulding—blood, necturus (double stained).
 Dr. F. E. Maxey—Blood, amphiuma (double stained).
 Mr. S. W. Mellotte—Foot of human embryo (4 weeks).
 Mr. L. M. Mooers—Circulation of blood; microphotograph, "The creed."
 Dr. V. A. Moore—Blood of pigeon, showing spindle-shaped bodies in white corpuscles.
 Dr. G. N. Perry—Transverse section of bone.
 Dr. Robert Reyburn—Hæmatozoon (malaria) in human red corpuscles; living eggs of water snail.

Dr. Henry A. Robbins—Intestine; injected and stained.

Dr. Harry W. Rollings—Pneumonia; liver of frog; lung of frog; intestine of frog; kidney of rabbit; ear of kitten. Injected and stained.

Mr. W. Schneider—Stomach (human), stained.

Dr. W. H. Seaman—Stem-sections of leanas.

Dr. H. M. Smith—Trichinæ in human muscles; anthracosis(carbon deposit in human lung).

Dr. Louis P. Smith—Sarcoma of soft palate.

Dr. J. T. Sothoron—Foraminifera.

Mr. Jose M. Yznaga—Section of human skin (triple stain).

The officers of the Society are: Dr. Collins Marshall, President. Hon. A. A. Adee, Vice-President. Mr. H. H. Doubleday, Corresponding Secretary. Mr. L. M. Mooers, Recording Secretary. Dr. E. A. Balloch, Treasurer. Dr. W. H. Seaman, Curator.

EDITORIAL.

“**Slide.**”—The French speaking microscopists have recently adopted the English word *slide*, M. C. Schlumberger, among others, using it in “Le Micrographe Preparateur” for May and June. Formerly they used the word *porte objet* which means object carrier.

“**Urine.**”—If, upon a microscopic examination of a saccharine urine, there be no casts, the case may be classed as one of the so-called harmless cases of Diabetes, but even in this case no assurances of safety should be given. But if casts are abundant, the prognosis is very grave.

Scientific Instruments and the Tariff.—The United States circuit court of appeals holds, in the case of United States v. Presbyterian Hospital, decided Jan. 16, 1896, that it does not follow that because articles are made for the use of physicians and surgeons in the practice of their profession that they are scientific instruments within the meaning of the term as used in the tariff law. The court says that the term “scientific instrument” does not describe one appertaining to any particular vocation or profession. It suggests an instrument which is something other than a mere mechanical tool or appliance, however peculiarly adapted to use it may be in scientific

labors: one which, because it embodies some scientific conception, would attract the interest of learned minds; something as distinct from the ordinary mechanical instrument as is the scientific toy from ordinary toys. What is or is not such an instrument, in cases arising under the statute, is to be determined as a question of fact, according to the nature of the thing itself, and not necessarily according to the nature of the use for which it is primarily designed or in which it is principally employed. Ordinary metal tubes, a wire mask covered with flannel, and glass tubes for holding wound catgut, imported for use in clinics and training schools the court does not consider attain to the dignity of "scientific instruments."

MICROSCOPICAL APPARATUS.

A New Microscope.—The stand is made entirely of brass, highly finished, with graduated-draw tube, nickel-plated. The Base is solid brass (not filled), extra large and

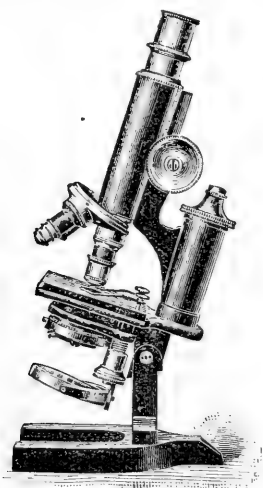

heavy thus rendering the instrument perfectly stable. The Stage is also extra large, 9.5 x 8.5 centimeters, of hard rubber, firmly vulcanized and bolted to heavy brass stage-

bed .5 millimeters thick. The action and arrangement of the sub-stage is clearly shown by the cut and is of the most improved pattern, fitted with an adjusting screw of fine pitch admitting of the most delicate adjustment, of condenser. The mirror is two sided plane and concave, and adjustable in all directions. Condenser, of large size of the double lens system, fitted with Iris Diaphragm and capable of furnishing light of sufficient angle and intensity *to bring out the full efficiency* of the finest oil immersion lenses. A ring is provided below the iris diaphragm into which a blue or ground glass may be slipped when artificial light is used. Coarse adjustment by rack and pinion. The rack is of the finest workmanship, with teeth cut at an angle. Adjusting screws are provided to take up and wear that may be caused by long continued use of the instrument. The fine adjustment is by micrometer screw.

The eye pieces and objectives furnished with this stand are Reichert's standard quality. For sale by Richards & Co., limited.

MICROSCOPICAL MANIPULATION.

Gold and Bronze Paints.—The liquid employed with which to mix the bronze powders (which can be bought of all grades and shades of color) is, for ordinary indoor work dextrin (400 g.), containing potassium bichromate (1 g.) and sufficient water. Use 65 g. of bronze powder. For more permanent work dilute water-glass may be used. Borax-shellac solution, mixed with one-third alcohol, also is used, something like this: Bronze powder, 55 parts; alcohol, 10 parts; borax-shellac solution, 25 parts. Or dissolve a dammar in benzol and neutralize with solution of potassa by shaking together and allowing to separate.

Aquarium Cement.—A good cement for fastening the glass sides into the frame for an aquarium may be made by melting together in an iron vessel 1 pound of gutta-percha and 2 pounds of common pitch. The Techno-Chemical Receipt Book gives the following: Mix 9 parts of

litharge, 9 parts of fine white sand, 9 parts of plaster paris, and 1 part of linseed oil; then add some drying oil. This cement must stand several hours before using. It becomes very hard, and serves both for sweet and salt water tanks, but is best for the latter.—W. Druggist.

BACTERIOLOGY.

Flies Carriers of Germs.—As far back as 1886, Hoffman demonstrated the presence of tubercule bacilli in the bodies of flies captured in a room occupied by a consumptive. The droppings of the flies were full of the bacilli, which were shown by experiment to be fully virulent.

Six years later Mr. A. Coppen-Jones, of Switzerland, by employing cultures of chromogenic bacteria, proved that infection can be, and actually is, carried, not only in the bodies of flies, but also by their feet. In one experiment, pieces of a culture of the bacilli prodigiosus were mixed in a mortar with some highly tuberculous sputum, in such a way that stained preparations showed these two varieties of microbes to be present in about equal numbers. Flies were allowed to light on the sputum, and, after they had flown about for a time, were permitted to walk across the surface of sterilized potatoes. In forty-eight hours numerous colonies of the bacillus prodigiosus made their appearance.

From this result we can reasonably conclude that flies are a constant source of infection. More especially is this the case in those warm countries where germ growth and decomposition are favored, and where no means whatever are employed to exclude flies from living rooms.—Pacific Record.

The Transmission of Microbian Disease through the Medium of Books.—M. du Cazal and M. Catrin recently published in the *Annals de l'Institut Pasteur* the result of a series of experiments for the purpose of determining to what extent microbial disease is transmitted by books,

He found positive evidence of the transmission of streptococcus, pneumococcus, and Löffler's diphtheritic bacillus. It was found impossible to transmit tuberculosis to animals by means of paper heavily charged with Koch's bacillus, — a curious fact, the explanation of which does not yet appear. The observations were also negative as regards the typhoid bacillus. According to the *Revue Internal de Med. et de Chir.*, the typhoid bacillus may be distinguished in the evacuations and secretions, and differentiated from the coli bacillus within twenty-four to forty-eight hours by the following method described by Elsner: A culture medium is prepared by means of gelatin boiled with a decoction of potato, to which is added a solution of soda in sufficient quantity to produce a degree of acidity equal to that of Holtz's medium. This solution is filtered and sterilized. The liquid is then poured into Eslen and Meyer's tubes, and completed by the addition of iodide of potassium, in the proportion of one part to one hundred. The culture is then inoculated, and poured out on plates. The bacillus coli and the typhoid bacillus are the only microbes which will grow in this medium. Within twenty-four hours colonies of bacilli coli appear in luxuriant brownish growths; twenty-four hours later the typhoid bacillus develops. This germ is easily distinguished as small, finely granulated, transparent points.

Bacteriological Investigations into the Etiology of Keratitis and Conjunctivitis Eczematosa and Corneal Ulcers.—Bach (*Arch. f. Ophthalm.*, xli, 2), draws the following conclusions from his investigations (*N. Y. Med. Jour.*):

1. Eczematous inflammations of the eye are caused by pyogenic micro-organisms, especially the staphylo-coccus pyogenes aureus.

2. In recent processes the particular microbe can generally be demonstrated.

3. By implantation of pyogenic bacteria typical artificial phlyctenules can be produced in the cornea and conjunctiva.

4. The eczematous processes frequently coexisting in other parts of the body can be traced to the same cause,

5. Hence there is a direct connection between eczema of the eyes and of other parts of the body.

6. With a similar etiology of corneal ulcers, those ulcers situated in the central parts of the cornea are much more unfavorable in prognosis than those elsewhere, as there is almost always inflammation of the iris and the ciliary body present.

Micro-Organisms in the Blood of Scarlatina.—Dr. Crajkowski secured blood from scarlatina patients by a needle prick of the ear, and from it made cultures and cover-glass preparations (University Medical Magazine). The culture media used were glycerin agar, agar with hæmatogen, blood serum, gelatin, bouillon, serous transudate from the peritoneum and from the tunica vaginalis testis. The cover-glass specimens were dried, fixed, and stained in Chencinski's mixture. These specimens showed micro-organisms in the form of diplococci. They were found in relatively small numbers—one or two in a field of vision—and generally occurred singly, though sometimes in twos or short chains. They were never seen in the blood corpuscles. The shape of the individual was oval, though with ordinary magnification no difference between the diameters could be observed. They were not stained by ordinary methods and decolorized readily when stained by Gram's method. The specimen from fresh blood had a surrounding capsule which was absent in the dried form. The growth of the organisms on culture media was carefully studied. Upon the solid culture media it was very slow. Upon all the solid media the colonies appear under the microscope as minute dewdrop-like points measuring one-half by one-half millimetre and not becoming confluent for months. The organisms continued vital upon the solid media for from three to four months if protected from drying. In liquid culture media, especially in bouillon, the organisms formed a yellowish-white, finely granular, light precipitate at the bottom of the glass. The inoculation of the organisms beneath the skin and into the blood of rabbits was without result. Inoculated mice died in three days with the cocci distributed through the blood.

A Study of the Infectiousness of the Dust in the Adirondack Cottage Sanitarium.—Irwin H Hance (*Canadian Practitioner*, January, 1896) gives a very interesting *resume* of the literature bearing upon the infectious character of tuberculosis, and relates some instructive experiments upon the subject. These were done at the request and under the supervision of Dr. Trudeau, at the Saranac Laboratory, and consisted of inoculations, into the subcutaneous tissues of guinea-pigs, of suspension of dust from the various buildings and cottages of the Sanitarium. A total of eighty-one inoculations was made, all but eight of which gave a negative result. Three of the animals died of rapid acute infections; the remaining five fatal cases were infected with tuberculosis. They all occurred among the ten animals which were inoculated with dust from the "Red Cottage," which had been occupied by the sickest patients and by one who was notoriously careless as to spitting about the cottage.

The author seems justified in concluding that the freedom from infectious material of the dust from sixteen out of seventeen buildings tested is due to strict measures in disposing of sputum. The patients are carefully instructed concerning the disposal of their sputum, and close supervision of them is maintained. The pasteboard cuspidors are burned daily, as are the Japanese napkins as soon as possible after using. Paper napkins are used in the infirmary in hemorrhage cases or where patients are too feeble to get up on their elbows so as to use a cuspidor. These are used but once, then placed in a pasteboard receptacle and soon after burned. In addition to these measures, the author insists upon general good hygiene, etc. These results show that buildings may be occupied by consumptives for years and still be uncontaminated by infectious material if the discharge of bacilli from the patient be properly cared for.

Defective Sanitation in Italy.—According to Professor Bodio, of 8,254 communities in Italy, 1,454 have no supply of pure water, and 4,877 no regular sewage system.

BIOLOGICAL NOTES.

Plant Lungs.—One of the prettiest microscopical studies is the examination of the lungs of a plant. Most people do not know a plant has lungs, but it has, and its lungs are in its leaves. Examined through a high power microscope, every leaf will show thousands upon thousands of openings, infinitely small, of course, but each provided with lips which, in many species, are continually opening and closing.

MEDICAL MICROSCOPY.

Coffee and Disease Germs.—A year ago, a Russian bacteriologist made some experiments for the purpose of determining the influence of coffee in destroying disease germs. The conclusion was that coffee is to some degree a disinfectant. The disinfectant properties of coffee depend, however, not upon the active principle of coffee, or caffeine, which it contains, but upon the substances developed in the roasting of the coffee. It was found that the various substitutes for coffee are also germicides, and, like it, develop disinfectant properties during the roasting process. A watery infusion of either coffee or its substitutes was found to be capable of killing the germs of cholera within a few hours, and of typhoid fever in a somewhat longer time.

The conclusion should not, however, be drawn from these statements that either coffee or its substitutes are to be considered of value on account of their slight antiseptic properties, as too long a time is required for the destruction of germs by them.—Modern Medicine.

The Influence of Surrounding Micro-Organisms on the Cholera Vibrio.—Senarelli found cholera vibrios in the water supply of both Versailles and St. Cloud. The former place is practically immune from cholera, but the latter is not so to the same degree. Seeking for an explanation of the difference between the two cities in this

respect, Metchnikoff obtained from some preserved choleric dejecta, colonies identical with those of the cholera vibrio, but differing in that they grow only at temperatures beneath 30 degrees C., give no indol reaction, and are not pathogenic to animals.

These organisms were sown in gelatin plates but refused to grow. The plates were then exposed to the air, and a number of other organisms fell on them. Most of these had no effect upon the cholera vibrios, but some sarcinæ, and especially some yeasts, influenced their growth very markedly, so that if Metchnikoff wished to revive a vibrio that would not grow, he inoculated along with it certain other micro-organisms, and obtained the desired result. A sarcina, a torula, and a non-liquefying bacillus were isolated, all of which favor the growth of the vibrio, while there are others which certainly hinder its development.

One may conclude, therefore, that the cholera bacillus is considerably modified by the micro-organisms which surround it, and that immunity or susceptibility, in the case of cholera, depends largely upon the other microbes in the intestinal canal.—Pacific Record.

Small-Pox in New Orleans.—The Medical and Surgical Journal of New Orleans says that small-pox has been prevalent in that city for the past two years, new cases occurring through the coming to the city of unprotected blacks from the country parishes. The board of health is hampered in its efforts to stamp out the disease by a lack of funds, and the journal calls upon the profession of the State to advocate general vaccination of unprotected persons, so that the supply, which now keeps up the disease in New Orleans may be cut off.

Diphtheria was the cause of over fourteen thousand deaths in Vienna during twenty five years from 1870 to 1894 inclusive.

Black Plague is said to have appeared in Yokohama. Three cases are reported by cable, in two of which the patients have died. They were both Chinamen.

MICROSCOPICAL SOCIETIES.**Quekett Microscopical Club.**

Friday, May 15.—The 342nd ordinary meeting of this club was held at 20 Hanover-square, Mr. J. G. Waller, F.S.A., President, in the chair. The minutes of the preceding meeting were read and confirmed, ballot for new members taken, the additions to the library announced, and other formal business gone through.

Mr. Miles exhibited specimens of Aulacodisci from Sendai, in Japan, one of which, *A. giganteus*, was in almost perfect condition, which is rarely the case. Mr. Enock read a note on two aquatic Hymenoptera—viz., *Prestwichia aquatica* and *Caraphractus cinctus*. The former was the first time of capture since 1862, by Sir J. Lubbock. Mr. Enock also gave his reasons for suppressing the name *Polynema natans*, as it had been clearly proved by the late Mr. F. Walker that it was identical with *C. cinctus* of Halliday. Mr. Nunney gave an account of certain disc-like bodies he had found on the stigmal vein of the wing of a Chalcid fly, and the matter was discussed by Mr. Ingpen and Mr. Michael. Mr. Nelson exhibited a portable microscope, designed, he believed, by Dr. Ross, and made by Mr. Baker. He also read a paper on "Correcting Errors in Camera Drawings." Mr. Karop read a note on "Illuminating Objects with Low Powers by Artificial Light." Votes of thanks were passed for these several communications. Announcement of the meetings and excursions for the ensuing month was then made, and the proceedings terminated. The next ordinary meeting will be held on June 19.

Sheffield Microscopical Society.

April 17.—The members of this Society held what is termed a practical night at the Rutland Institute, Fargate. Mr. Bernard H. Hoole gave a short demonstration on "Dark Ground Illumination as applied to the Microscope," and exhibited a number of views of marine zoophytes and diatoms.

PERSONALS.

Geo. M. Lawrence of Warsaw, N. Y., is a dealer in microscopes, accessories, and microscopic objects.

T. G. Lee, M. D., is professor of Histology and Embryology in the University of Minnesota, Minneapolis, Minn.

NEW PUBLICATIONS.

The Primary Factors of Organic Evolution.—E. H. Cope, Ph.D. Chicago: The Open Court Publishing Co. In publishing this neat octavo volume of over 500 pp., Dr. Cope has made quite a valuable addition to the literature pertaining to the problem of evolution of the animal kingdom. The book is divided into three parts, showing the nature of variation, causes of variation and "The Inheritance of Variation." The deductions made are carefully drawn and brought to a final conclusion with infinite exactness. Over 100 illustrations embellish the work.

The Bacillus of Chancroid.—Colombini has been working on this subject, and publishes his results in a pamphlet. He finds that the bacillus of Ducrey and the streptobacillus of Unna are one and the same organism, characterized by being found in chains, by staining chiefly at the ends and not in the centre, by being decolorized by Gram's or Kuhne's method, by the difficulty of obtaining pure culture since a suitable nutritive medium could not be found, and by the rounded ends of the individual bacilli. The best staining agent was methylene blue. Inoculation into animals was uniformly negative. The bacillus is rarely found in bubonic pus.

Defective Sanitation in Italy.—According to Professor Bodio, of 8,254 communities in Italy, 1,454 have no supply of pure water, and 4,877 no regular sewage system.



A. M. EDWARDS, M. D.

THE AMERICAN
MONTHLY
MICROSCOPICAL JOURNAL.

VOL. XVIII.

JULY, 1896.

No. 7

Sketch of the Life of Arthur Mead Edwards, M. D.

BY C. W. SMILEY.

[WITH FRONTISPIECE.]

Professor Edwards was born in 1836 and is consequently in his sixty-first year. His father, Charles Edwards, was an English lawyer,—his mother a descendant of Sir James Edward Smith, the first president and founder of the Linnæan Society.

Dr. Edwards was early interested in chemistry and became professor of Chemistry and Microscopy in the Women's Medical College, New York, and in the College of Pharmacy in New York. He lectured in chemistry at Dartmouth College.

He studied geology under Professor Agassiz, botany under Professors Gray and Torrey at Harvard and Columbia. He became assistant to the latter in the College of Physicians and Surgeons, New York. He also studied geology under Professor Newberry, after which he was assistant in chemistry to Professors St. John, LeConte and Doremus.

He was attached to the Northwest Boundary Survey as assistant in microscopy to Mr. George Gibbs. Latter he assisted Prof. J. D. Whitney in the State Geological Survey of California and he aided Professor C. H. Hitchcock in the Geological Survey of New Hampshire.

Dr. Edwards founded the American Microscopical

Society in New York long before the present national society by that name had commenced operations and he was its first president.

He went to California in 1877 to study diatoms collected by the State Geological Survey and by the Northwest Boundary Survey, but was prevented from completing the work. He lived at Berkeley, Cal., two years, fell sick, came East, leaving specimens and books to the San Francisco Microscopical Society.

He has since lived in Newark, N. J. His publications, largely microscopical, are to be found in the Transactions of the Lyceum of Natural History of New York, in the transactions of the San Francisco Microscopical Society; in the Journal of the Quekett Club, in the proceedings of the Boston Society of Natural History, in nature in the Quarterly Journal of Microscopy, in the Microscope, and in this JOURNAL. He has also published "The Natural History of the Diatomaceæ."

A New Form of Analytical Procedure Applicable to the Study of Diatomaceous and Other Clayey Deposits.

BY K. M. CUNNINGHAM,

MOBILE, ALA.

Towards the completion of the second decade of my career in studying that branch of microscopy, whose useful results are recorded as belonging to the department of Micro-Geology, I have been accustomed to avail myself of certain useful expedients which were gradually devised and evolved by myself. They are a necessary sequence of attempts to obtain the best results from difficult diatom or other fossil organic-bearing material. As the outcome of the line of experimentation followed and fully mastered, I have been enabled to reduce my acquired experiences to a set of rules, or process methods. They may be communicable to anyone who may not have

had sufficient previous experience or who may be on the verge of entering into this class of investigation so that they may readily overcome the difficulties ordinarily offering in such cases.

In the first decade of my study the numerous samples or specimens of diatom-bearing clays which passed through my hands were treated, and acceptable results were obtained, by the universally known methods of washing in water and treatment in acids, concentration, etc. In my later experience I have struck deposits of such a character that it was impracticable, or even impossible to reduce or eliminate the clay matrices so as to get a rich concentration of the contained fossil organisms by any acid form of treatment. I then devised the method of clay elimination by the trituration or rubbing method, which gives unvarying results so far as relates to the fossil contents of any clays thus far examined. In an attempt to outline the method, it will be necessary at the outset to mention a few requisites essential to the process. The first requisite is to provide a piece of rather stiff rubber belting, having the dimensions of from six to nine inches in length, by some five or six inches in width. Eventually all samples of clay to be treated are laid thereon as a support.

The preliminary step in the cleaning is begun by taking a small piece of the material, of about a half cubic inch in bulk or smaller, wetting, softening and breaking it down in a small quantity of water to a pasty condition, which will partially liberate the heavier sediments and retain in suspension the clayey or lighter portions. The vessel in which this is done (say a common china soap bowl) is then filled up with water and the lighter portion gradually poured off, retaining the heavier sediment; the initial pressures used in breaking down the clay are in the thumb and finger-tips of the hand and afterwards the ball of the thumb is used in tritulating the clay on

the bottom and sides of the soap-bowl. After each filling up and pouring off of the water, the trituration must be renewed to remove another increment of clay at each pouring off, which will be liberated from the heavier sediment at each filling up with water. If at this stage a small test should be made, the presence of unreduced particles of clay would still mask the fossil contents, and for this reason it would then be necessary to pour off as much water as possible, at the same time collecting the sediment into the smallest compass in the bowl, held slanting; at which point the further precaution should be taken of removing a few more drops of water from the mass. The next step is to have at hand a piece of common blotting or bibulous paper upon which the sediment is decanted; the blotting paper will at once absorb the remainder of the water, leaving a little cake or pellet on the paper, freed from any excess of water. This pellet is then removed by slipping a knife blade under it and depositing the same on the middle of the rubber strip, next with a rubbing and spreading pressure exerted by the ball of the thumb, the pellet of clay is continuously trituated by straight strokes over the major part of the surface of the rubber pad or square. When this rubbing (gathering together) and re-rubbing has been kept up for a sufficient time, it will be noted that the material has again apparently returned to a liquid condition and the minute lumpy particles have been dissipated.

The material is again transferred to the soapbowl to which at first a rather small quantity of water is added, so that the pasty mass may be distributed evenly in the water by the finger. The bowl is then filled with water and the decantation or pouring off resumed, and it will then be noted that the remaining sediment is distinctly visible through the small quantity of water retained and an absence of further milkiness on an additional agitation

of the bowl. A stage will then have been reached where no further pouring in or off of water will be required. The results up to this point have eliminated all of the undesired clay or aluminous products and left behind the desired organic fossils, largely mixed with sand grains. Since this last condition is somewhat objectionable, it then becomes necessary by some concentration process to remove the desired fossils from the sand as fully as possible. This need then causes one to resort to the concentration method customary in removing the diatoms from recent fresh water and marine muds or clays. This procedure is familiar to everyone who has given any attention to the cleaning of diatoms. To conduct this concentration successfully it is usually necessary to have relatively shallow dishlike vessels of glass or porcelain, of either square or round contours. Square is preferable, as the concentrated particles may be directed to a corner and drawn off by tip of index finger contact, or with a pipette. When this is successfully done the objectionable sand is left towards the rear of the diatoms, spiculæ, etc., and may be rejected as practically barren of forms.

The manipulation properly conducted, should be that form of motion, comprised in a continuous twirling motion of the contents of the glass, while holding the glass slightly slanting, and giving it an occasional jerk backwards, so as to project the discoidal and other forms forward. This method used with the marine clays drives millions of the diatoms forward and out of the sandy sediment, but also carries with it all of the vegetable debris usually burned out or carbonized during acid treatment.

At this point it may not be inappropriate to introduce, by way of diversion, an important expedient in the concentration of diatoms as devised and utilized by myself, useful in more general cases and of more frequent utility.

Assuming that a concentration of a recent marine diatom-bearing material had been made: say, of a gulf or marsh deposit, by the process cited above. In this case, nearly all of the vegetable debris, including carbonized lignitic matter, would come over or out, along with the diatoms. There would occur a difficulty in reducing all of the carbonized material in the boiling acids, and the effort should be made in advance to eliminate this form of debris.

The following method will obviate this source of trouble: For the purpose it is necessary to have available for use, one or more of the small thin, well known, wooden butter-holders or a hemispherical rubber cup. These vessels have round bottoms and usually when partially filled with a liquid, sit level. The diatomaceous material as roughly concentrated or freed from most of the sand is transferred to the wooden bowl. The bowl is supported on a small plate of window glass to enable it to turn readily and the bowl is then given a smart flip with the tip of the index finger, when it will spin rapidly around a few times. The contained liquid will rise or flare up centrifugally, and spread around the sides, and the heavier sand and vegetable debris will settle back at once, leaving a cloud of diatoms floating, or in suspension. The bowl is then quickly tilted so as to throw the cloud of diatoms towards the edge of the bowl, when several pipettes full of liquid may be quickly removed; this spinning around of the bowl is repeated until it is judged that the diatoms have been separated by gravity gradations from the heavier sediments.

If the desirable material thus separated is allowed to settle in a suitable holder, and the excess of water then removed, and the diatoms deposited as a drop on a piece of good blotting paper, a ball of diatom material will be thus at once secured; and may be dried immediately over an argand lamp, and when the ball is dried and

deposited on a simple glass slide and touched with the finger, it will fall to dust. If this dust is distributed over the slip by gentle tapping, and the surplus of diatom powder is removed by tilting the slip, a thin, uniform; evenly distributed layer of the largest and smallest in the material will be found studding the slide in extreme profusion. If this slide is then covered with a thin cover glass, to which a drop of balsam has been applied, a slide for study is thus perfected containing every form characteristic of the deposit. I have found this to be a direct and satisfactory process dispensing with the use of acid treatment. One can prove the utility of the method of separation or concentration by this modified form of mechanical whirling at the same time getting rid of the heavier sand and vegetable matter, otherwise difficult to eliminate by acid treatment. When the whirling principle is fully mastered, as outlined above, the secret of successful concentration is within one's grasp. All other accessory steps in diatom preparation present no special difficulties of manipulation that cannot be readily overcome.

In order to illustrate the working advantages of the analytical methods herein outlined, a reference to some very recent study results conducted by employing the processes already given in detail, I might recite that on the occasion of the proposed Southern States Exposition to be held at Chicago, but which has since been postponed indefinitely, it had been the intention, to have the varied mineral resources of the State of Alabama fully represented. In accordance with this plan, I was entrusted with the duty of collecting such minerals as were peculiar to south-western Alabama and south-eastern Mississippi. The exhibits were to be made jointly by the geological department of the state and the Mobile and Ohio Railroad land department. While on this mission in the field, I had opportunity to visit and study

a considerable area of the tertiary sedimentary formations, all of which are of special interest to students of micro-geology or to the general microscopist. There is a strip of territory occupying fully one-third of the Southern portion of the states of Alabama and Mississippi and extending to the shores of the Gulf of Mexico, which is now known to furnish inexhaustible fields of strata made up in greater or less degrees of richness of microzoan remains. There are foraminifera, radiolarians, sponge spicules; diatoms of marine origin, spines and tests of micro-echinodermata, corallines and lignitic strata containing the resinous spores characteristic of the fern vegetation. There are also mineral grain inclusions of various kinds, the result of the decomposition of the archaic or primary formations as silex, mica, alumina, tourmaline, zircon, magnetite, greensand, pyrite, selenite and fossil resinous granules, phosphatized bones of various extinct fossil vertebrates, sharks' teeth of minute size, etc.

While investigating the formations for a few days at Enterprise, Miss., I very promptly determined three characteristic stratified deposits of microscopic interest; the first being at the level of the water in the Chickasawhay River, at a point a little south of a new steam saw mill in process of erection and which will remain a permanent land mark from which to locate the deposit. At this point a particularly tough and close grained bluish clay shelves into the water abruptly. This material when tested right on the spot by the trituration method, showed that it was a deposit of marine fossil diatoms corresponding to the recent existing species found in the clays of the bays bordering the Gulf. There were large and small species of *coscinodiscus*, *actinoptychus*, *actinocyclus*, *melosira* and *triceratium* with a sprinkling of radiolarian forms. This clay breaks up into cubical

blocks and when dry is quite indurated, but it yields to the trituration treatment, giving the discoidal diatoms as clear and as transparent as glass, with the specific reticulation quite distinct. At another point two miles north of Enterprise at the Okatibbee Creek iron railroad bridge in the south bank of the creek, and in its bed samples of a clay that falls to peices on wetting yielded an abundance of radiolarian forms comprised under a few genera and species having their spines intact. These forms might be removed pure by millions by a simple washing process, the clay being of that texture as not to require trituration for reduction of the aluminous matrix. The diatoms in this deposit were not abundant but were associated in small numbers with the other organisms.

But at another point at the base of the bridge pier an outcrop of sandy stratified clay reduced very easily in water gave a characteristic showing of marine discoidal diatoms with few radiolarians

In addition to the diatomaceous and radiolarian beds, there were deposits of calcareous marls at many points in the vicinage of Enterprise, which deposits are usually void of any silicious micro-organisms but furnish green-sand casts of interest in their peculiar structure, and also of foraminiferal shells. The marl deposits are rather coarse in texture and on their weathered surfaces thousands of discoidal echinoderms are scattered which show microscopic ornamentation on their white surfaces.

In a previous article in the *JOURNAL* in relation to the radiolarian deposits of Ala. and Miss., I alluded to an extensive formation a few miles north of Enterprise, as being a typical illustration of the Radiolarian formation (Buhrstone; Eocene). During the month of May, of this year, I was enabled to examine this point, which is locally known as "White Bluff" or the flag station known

as Basic City. The bluff is not an adjunct to a river bank, but more particularly the result of a side hill cutting to make track room for two parallel railroad tracks passing that point. The bluff-like aspect is preserved for about a mile. Along the face of this cutting at a height of about ten feet above the level of the road-bed a soft stratum of finely laminated clay proved to be very rich in diatomaceous and radiolarian forms as well as foraminifera, the most interesting peculiarity of the stratum being in the richness of a single specie of triceratium, hundreds of them showing up in a small cleaning by the trituration method of treatment. The other forms were mostly species of coscinodiscus fully preserving their sculptural markings. The contents of the strata above and below this soft thinly laminated stratum were more of radiolarian forms than diatoms. During the superficial examination of the various alternating layers of the formation but one single large specimen of a nautilus was found, in a fine state of preservation, and this one, found by the mere chance of a slab of the radiolarian chalk splitting open while lifting it up. For economic purposes as a source of silicious clays, the strata are of unlimited extent, being above fifty feet in height and of indefinite extension. This marine deposit of silicious and aluminous clays rests conformably upon a thick stratum of coarse greens and marl. By the trituration process an unlimited quantity of radiolarian, diatomaceous forms and sponge spicules may be removed for appropriate study.

At Boyce, a few miles south of Enterprise, an extensive formation of a cretaceous rock is found which is locally quarried by the aid of cross cut saws and is found to be universally used for the construction of very durable chimneys and fire places within the whole area occupied by the white limestone formation. Any piece of this chalklike chimney rock may be softened by soaking in

water and be crushed to a powder by the pressure of the hand and when further reduced by the trituration process yields millions of beautiful foraminifera of many species, all of microscopic size.

On a former occasion I had the pleasure of communicating to this JOURNAL the results of some micro-studies of the marl beds of this same vicinity in which I called attention to the occurrence of minute ornate calcareous glassy plates, anchors and wheels, such as are now derived from the cuticle or epidermis of the holothurians of existing seas, but I have found it practically a hopeless task to find in such calcareous marls any traces of silicious fossil remains.

What has already preceded would cover all of interest to the microscopist as noted in this area; traversed by the Mobile and Ohio Railroad. On my return from this trip I next visited the territory northwards of Mobile on the line of the Mobile and Birmingham Railroad for a further collecting of mineral specimens. This opportunity enabled me to study a somewhat similar series of deposits as were found in Mississippi. In the vicinity of Jackson, Clarke Co., Alabama, outcrops of the white chalky limestone, locally known as "Chimney Rock" and the marl deposits were duly studied. I secured samples of an indurated clay from the lowest stratum of the outcrops in a deep ravine; as the descent from the adjacent hills led down for about a hundred or more feet. Afterwards in submitting the material found here to the trituration process, I determined that here was a horizon where silicious and calcareous micro-organisms had simultaneously flourished and had left their so-far indestructible remains in evidence of their former life.

In this silicious marl stratum, I found associated foraminifera of many species, diatoms of the discoidal and triangular forms, radiolaria and microscopic echinus spines

and spicules of sponges, richly intermixed and by the manipulatory process recounted herein, the diatomaceous forms were removed in sufficient quantities for study purposes. The phenomena of metamorphisation are well shown in this deposit, as in the trituration process among the larger *coscinodiscus* forms that come through, a few interlacing natural crystal plates embrace and hold together across the central portion of the disc, leaving interspaces between the plates. While many of the discs have the metallic or coppery aspect of mineral pyrite; others have embedded in their texture minute spherules of pyrite, which appear as black spots by transmitted light but golden by condensed surface light. The foraminiferal shells have also undergone the change from carbonate of lime to a mineral no longer soluble in acids, and tending more to a silicified product. In cases the crystallization has obliterated the reticular marking of the discs, while others have preserved the hexagonal areolation enabling the species to be readily recognized.

At St. Stephens, Ala., on the Tombigbee River, I secured large blocks of the coraline white friable limestone already celebrated in geology as a locality where the chalky strata are made up of the large and conspicuous foraminifera. *Orbitoides mantellii* imbedded in a matrix of microscopic corals, the foraminifera in this deposit yielding silicious casts or molds of the internal chambers of the shells, after dissolving away the shell of lime carbonate. In a more northerly direction, a further extension of this chimney rock exists around the town of Suggsville, also in Clarke Co., where I was enabled to observe quantities of fossilized nodules known as coprolites, which weather out of the soft rock, and when found in economic quantities are valuable on account of their phosphatic nature. From these nodules thin transparent sections may be made, showing the coprolites to be an aggregation of foraminiferal bodies ranging down

to the smallest of sizes. Trituration of the lignitic clays or shales of this same locality yield the spores of vegetation similar to that of the shales of the carboniferous formation and coal strata. All of the various kinds of chalky strata in this area yield by the same treatment the foraminiferal bodies in illimitable numbers. At Safford, a station still higher up on the railroad and on the southern limits of the cretaceous horizon, fine specimens were secured of true chalk, being the north American equivalent of the British chalk, and this also by trituration yields foraminifera in a different state of aggregation from that of the chimney rock area.

The matrix in which the foraminifera are embedded is a mass of the minute amphidiscs or coccodiscs first studied and referred to by Dr. Ehrenberg as characteristic of the European chalk area or of the chalk of the cliffs of Dover and Brighton in England. The analytical methods which have been outlined herein are with equal facility applied to clays or soft mineral deposits, as some clearly defined mineral sediment of one kind or another will be with certainty demonstrated. The writer has had satisfactory returns through the method on such diverse materials as the coal shales of the carboniferous period; the silicious sinter, or dust strata derived from volcanic action in past time, the burned shales of bituminous or anthracite coals, and in the lignite clays, kaolin clays, common plastic clays, the phosphatic diatomaceous marine fossil clays of Florida, and the fresh water lacustrine fossil deposits, and marine deposits. If one character of contents is destroyed, something else of interest is unmasked, or made perceptible in its stead. The area in Alabama and Mississippi of which I have made allusion to herein had already received the attention of distinguished geologists, partly directly on the ground, or partly by correspon-

dence. Harper's Geology of Mississippi in the notes therein, refers to the labors of D'Orbigny and Dr. Ehrenberg in relation to some of the characters of the cretaceous formations that he was occupied with, while it is also known that Charles Lyell, afterwards known as Sir Charles, Alexander Winchell and Toumey had personally visited this territory in antebellum days, while the distinctively micro-geological character of what is known about the Tertiary sedimentary deposits was inaugurated by myself with the encouragement and approval of the present State Geologist of Alabama, Dr. Eugene A. Smith, and in the Alabama Gulf coastal plain Geological Report for the year 1894 appears for the first time a discussion of the microscopical characters of the formations in Southern Alabama, which also covers the distribution of the chalk in the central portion of the state. The relatively limited record therein made lays a foundation stratum upon which others can build an extension, when the science of the microscope shall be applied to geological problems as modern civilization may advance and scientific culture shall expand beyond its present bounds. After having on these two trips found such treasures of microzoan fossils in such variety, I conceived the idea of securing for free distribution at the proposed exposition, previously referred to, to all microscopists, students of geology or mineral collectors; as well as cement or ceramic manufacturers, liberal specimens of these various mineral deposits, so as to enable them to become familiar with these southern deposits of both scientific and economic interest, but unfortunately the failure to hold the exposition frustrated the intention as well as the idea.

Typhoid Fever caused thirty-six per cent of the deaths among the British troops in India during the year 1894.

Radiolaria, a New Species.

REV. FRED'K B. CARTER,

MONTCLAIR, N. J.

Stauralastrum trispinosum, N. Sp.

Arms four times as long as broad at their base, at their distal end triangular in shape, two and a half times as broad as at their base; their distal breadth two and a half times as large as the diameter of the central disk, which exhibits two to three rings. Arms enlarged at

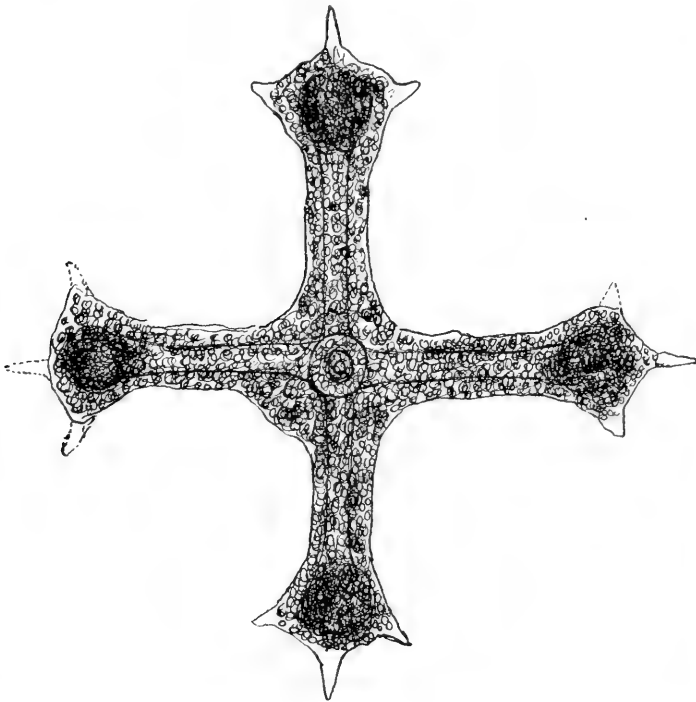

both basal and distal ends. On the end of each arm three strong conical spines, one in the middle and one on either side, the latter two so placed that if their edges were produced the resulting form would be a triangle.

Dimensions.—Radius of each arm (without terminal

spine) 0.24, basal breadth (at beginning of enlargement) 0.06, terminal breadth (including side spines) 0.15.

Habitat.—Fossil in the rocks of Barbados.

Bifurcated Double-ended Crystal From Asthmatic Sputum

EPHRAIM CUTTER, M. D., LL. D.

NEW YORK CITY.

Twelve years ago or more, in studying the kinship of asthma and hay fever I encountered this crystal in the expectoration of the late Col. W. T. Holt of Denver Colo. It differs from any I have met with. The artist has given merely the outlines. The double terminals were round like needles. The angles at the center were beautiful right angles as accurately shown in fig 1. Thickness of crystal about the distance between the angles. Color white with a tinge of cream tint. Chemical nature unknown. The ends remind us of uric acid but in a 43 years acquaintance I never saw uric acid with a re-entrant angle, going ahead of cholesterine.

To the clinician, the technical nature of this crystal is not absolutely necessary though desirable. The surgeon

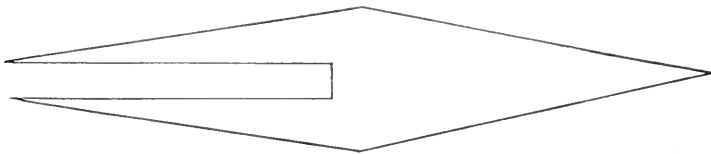

cutting for stone is most concerned in the removal—the analysis comes later.

For more than 30 years the morphology of sputum has been studied in America. The number and variety of sputum gravelly matters found is surprising. It seems as if every gravel-stone or crystal found in human urine and dung was also found in the sputum. Crystals of oxalate of lime, phosphate of lime, triple phosphate and cystine uric acid, etc., are met with in perfection.

Often the abundance is so great and the deposition so quick that the lung gravels are found in fine granules. Sometimes in broken massive crystals. Sometimes so large as when voided they have been mistaken for a necrosed rib! The granular forms are taken in by the mucous corpuscles which thereby are distended into giant cells, and thus more readily are expectorated than the unencysted granules which catch in the walls of the respiratory tract. This shows nature's beneficence to aid the expulsion of lung gravels. These gravels throw light on the **DIAGNOSIS OF ASTHMA**. If the physical impinging of a cambric needle on the back of one's hand twenty times a minute for days, weeks, months and years would be deemed sufficient for oversensitive nerves (hyperæsthesia), with spasm and irritability of muscles near point of contact, why should not the sputal acicular crystals, whose points are sharper than the finest cambric needle as the latter is sharper than a crow bar—impinging at every breath on the circular muscular fibers of the bronchial tubes, cause spasms and contraction, impeding the breath as is the case in asthma? For one I can reply, that I have had a case of asthma of 26 years standing, cured when these gravels were removed and not before.

2. Hay fever sputa show the same gravels and is an æstival form of asthma (Salisbury).

3. The fallacy of asthma cures by change of climate.

The man whence the crystal in Fig. 1. came, was an old patient of mine who went to Colorado to live on account of asthma. While there he had no asthma. Returning to New York his asthma returned. In other words something in Colorado enabled him to bear his load of gravel without an explosion. Or to use another simile, he was loaded like a gun, ready to go off, but in Colorado the trigger was not pulled! It is wonderful how the system tolerates foreign bodies. But there is

no real cure for asthma, unless the lungs are unloaded of their gravel and stay so. The microscope alone can tell the riddance.

Coughs are relieved by removing gravel from the lungs, when not enough to cause asthma. The point is that some coughs are caused by the irritation of the lung gravel and nature's trying to get rid of it. I have seen such cases cured by removing the gravel on the same principle as surgeons treat foreign bodies. Coughs seem more common in England than here. I think the climate is less to blame than the gravel. Distilled water makes the best cough drops in such cases by dissolving the gravel.

If anyone will take the pains to look at the beautiful cuts of sputum, drawn thirty years ago, in "Alimentation and Disease," J. H. Vail & Co., New York, they will see that Dr. Salisbury is the pioneer as to these lung gravels.

New York, May 4, 1896.

Meteoric Paper.

BY ARTHUR M. EDWARDS, M. D.,

NEWARK, N. J.

Whilst investigating the trap rocks on the Wahchu-ing or Orange Mountain, N. J., I lately came across the dry bed of a stream that had flowed down the rocks in a break in them and left by its drying a mass of whitish paper-like material on the stones. It was not the first time I had met with the substance. About thirty years back I had first seen it on the shores of New England and subsequently covering the meadows back of Hoboken, N. J. But this was fresh water and I determined to gather it and when at home view it by means of the microscope. For I hold it to be the duty of the observer of nature to turn his microscope to account on all occasions.

In places where the bed was soil, *Lobelia cardinalis*, *L.* and *Chelone glabra*, *L.* were in blossom. The cardinal flower was in abundance and the bright red blossoms seemed to pick it out from a distance and show it to be one of the most beautiful even more so than the cultivated flowers of our gardens. I thought how the bee and other insects that pick it out for fertilizing could see it from a great distance, especially when contrasted with the green of the leaves surrounding it and be guided to it by its brilliant flowers. The chelone is white, purple and can not be distinguished for afar. Still it can be found by insects and its closed flower be opened by the bee. The meteoric paper, so called, is described by Ehrenberg in a paper read before the Akademie of Berlin, in 1839, entitled Ueber das, 1686, in Cur-land vom Himmel gefall, Meteorpapier und seine Zusammensetzung aus conferren u. Infusorien (Diatomee und Desmidiën.)

An interesting vegetable production, having a deceptive appearance and resembling white glove leather and was found on a meadow that had evidently been overflowed by a brook near a wire factory at Schwartzenburg, in the Erzgebirge in Germany. A green strong substance grew where the sun shone in the meadow; which the water being slowly let off, deposited itself on the grass and when dried became colorless. It might be removed in large pieces. On the inner side, which was in contact with the water, it has a lively green color and green leaves are distinguishable which have formed the leather-like substance. The outside of this natural production resembles soft dressed glove leather, or fine paper, the printing kind; and is shining, smooth to the touch, and of the toughness of common wrapping paper. Ehrenberg submitted this meadow leather to a microscopic examination, and found it to consist of confervæ, form-

ing together a compact felt, bleached by the sun on the upper surface. It included some fallen tree leaves and some blades of glass. Among the confervæ lie scattered a number of the siliceous infusoria, he calls them, but we know them to be Bacillaria or Diatomaceæ. There were sixteen different sorts or species, belonging to six genera. There were also three sorts of infusoria with membranous shields, and dried specimens of another kind. The bacillaria and infusoria were not completely dry and could be revived. Some years ago, Ehrenberg submitted to the Academy of Sciences in Berlin, a piece of natural wadding or flannel a foot and a half square which consisted of bacillariaceæ, called them infusoria and conferræ, which were found to the extent of several hundred square feet, near Sabor, in Siberia, which formed after an inundation. This substance was analagous to the "meadow leather" which I have already alluded to, but it is far more surprising from its occurrence in such an immense mass. The flannel in this case, like the former, was chiefly composed of unramified branches of a conferva which he called conferva rivularis, interwoven with fifteen species of bacillariaceæ.

On January 31, 1637, a great mass of paper-like black substance was said to fall with a violent snow storm from the atmosphere, near the village of Randen in Courland. This meteoric substance was described and figured in 1636-1638 and was considered by M. Von Grotthus, who after a chemical analysis decided it to be a meteoric mass. M. Von Bergelius also analyzed it and could not discover the nickel said to be contained in it. Then Von Grotthus revoked his opinion and said he was mistaken as to the nickel. Nickel made it meteoric of course. It is mentioned in Chladni's work on meteors and appears as an aerophyte in Nees Von Esenbeek's valuable appendix to R. Brown's "Botan Schriften." Ehrenberg has

examined this substance, some of which is contained in the Berlin Museum (also in Chaldni's collection) microscopically. He found the whole to consist evidently of a compact smoothed mass of confervæ and about twenty nine well preserved forms of the called infusoria. There were eight kinds of siliceous shells, or bacillariaceæ, the others having those which are soft or membranous. These infusoria have now been preserved nearly two hundred years. The mass may have been raised by a storm from Courland and was not meteoric, and was merely carried away, but may have also come from a far distant district. The original locality of the substance neither the atmosphere nor America; but most probably either East Russia or Courland. The forms are cosmopolitan.

In the Orange specimen I found of course confervæ with the usual fresh water bacillariaceæ.

EDITORIAL.

By the kindness of Mr. Bryce Scott of New Brunswick, we have a supply of Barbadoes earth containing radiolaria for distribution. Send stamped envelope.

The Missouri Botanical Garden.—The seventh annual report of the Missouri Botanical Garden, recently issued, contains many scientific papers and the administrative reports for 1895. It is stated that about one-third more people visited the garden than during the previous year, on one day over 30,000 persons having been counted. The herbarium has been increased by the incorporation of ten thousand sheets of specimens and now comprises 242,000 specimens, besides over 4,000 slides, wood specimens, etc. The library has been increased by 3,036 books and pamphlets during the year, so that it consists now of 10,030 pamphlets and 9,619 volumes.

Women in Science.—In the Latin nations, women never have obtained celebrity in the studies of applied sciences, where the laboratory is of constant use; but in England the names of women from time to time appear on the first page of very valuable books or at the end of very technical articles published in the best scientific papers. It is a typical manifestation of the difference of races.

Epithelium in Urine.—Under the microscope this is seen as irregularly shaped bodies.

Blood in Urine.—May be suspected if the urine has a smoky or reddish-brown appearance, and may usually be detected in a satisfactory manner by the microscope showing blood corpuscles (these often do not show their characteristic biconcave appearance).

Bulletin de la Societe Belge de Geologie de Paleontologie et d'Hydrologie (Brussels.)—We have just received the volume of proceedings for 1894 of the above named society. It is invaluable for the student, as the scientific communications were all made by the best Belgian authorities. The book is illustrated with a number of plates and maps.

Watson & Son informs us that the medical men and hospitals in England are taking up the Rontgen Ray process with great avidity and it has shed light on many obscure bone disease cases.

They will send particulars of the apparatus necessary, instructions for working, and price list in case it may be of interest to any one. Write them a postal card.

Field Flowers.—This is the title given to a beautiful book containing some of the most popular poems of Eugene Field. Thirty artists, the leading illustrators of America have very kindly donated their services in illustrating the work throughout. The book is published for the purpose of creating a fund, the proceeds of which will be equally divided between the family of the poet and the fund for the erection of a monument to his memory. Price \$1.00; ten cents additional for postage. Address Eugene Field Monument Souvenir Fund, 180 Monroe street, Chicago.

Practical Photomicrography, a Correction.—W. C. Borden asks us to correct an error which appeared in his article "Practical Photomicrography" published in the *JOURNAL* for June, 1896. The description of fig. 4, page 199, and fig. 7, page 205, should be transposed. Fig. 4 is a photomicrograph of Typhoid bacillus x 1000 diameters and fig. 7, one of a colony of *Staphylococcus pyogenes aureus* x 30 diameters. Also under Fig. 3 it should be stated that the gonococci and cell nuclei are distinct, not indistinct.

MICROSCOPICAL MANIPULATION.

For Clearing Vegetable Sections.—We have found purified oil of turpentine far superior to clove oil as a cleanser of vegetable sections. In looking over a lot of several hundred old slides recently, the superior beauty of those prepared with turpentine oil was apparent at a glance.—*Nat. Druggist*.

Good Liquid Cement.—The following is said to make an excellent liquid cement :—To a solution of chloral hydrate in water dissolve gelatine to the required consistency. The cement thus made is said to have great adhesiveness and to remain indefinitely unchanged. Ordinary glue may be used instead of the more expensive gelatine; it is equally strong.

Mounting Specimens.—While using Dr. Dudgeon's pocket Sphygmograph, I was greatly struck by the good background produced by holding enamelled paper over the flame of burning camphor until it became coated with soot.

The tracings of the needle were also very white and well defined. This led me to think that it might be applicable for opaque mounting, and peculiarly suited for mounting many species in numbered spaces on our slide. I tried it and found it to work very well. The following is the process I have found most successful:—The paper is first gummed to a slip of thin card, and after it is dry held over

the flame of burning camphor until the surface is evenly coated.

I found it tedious to rule each line separately, so I hit on a plan which has proved very successful. I took a paper of pins, and after selecting an even row I gummed it to a glass slip, and fixed a handle to the other side of the slip. By this means I could rule all the parallel lines at one stroke, and by another stroke all the lines at right angles to these, thus dividing the slide into equal spaces.

The spaces can then be numbered with a mounted needle. A weak solution of shellac in spirit should then be poured over the blackened surface and allowed to dry, when it will be found quite fast. The specimens may then be stuck on in the ordinary way with gum.

The gum I use is a mixture of equal parts of gum arabic and tragacanth dissolved in cold water with a little glycerine, and the whole evaporated in a small ointment-pot and kept dry. A drop of water placed on the surface of the gum will dissolve enough for a slide in a few seconds, This combination neither breaks the specimens nor lets them get loose.—*Postal Journal*.

Batrachospermum. To Mount.—I have found no difficulty in perserving *Batrachospermum* in glycerine by Hautzsch's method. Hautzsch's fluid consists of a mixture of alcohol, 3 parts; distilled water, 2 parts; and glycerine, 1 part. This is nearly of the same specific gravity as water. The specimen is floated in a cell filled with this fluid, and set by, lightly covered to keep out dust. The spirit and water gradually evaporate and leave the glycerine behind. In this way the water in the texture of the plant is gradually replaced by glycerine, and we avoid that shrinking from exosmosis which takes place when the specimen is suddenly transferred from water to a dense fluid like glycerine.—*Postal Journal*.

Oxalic Acid For Preserving The Color of Dried Plants.—The importance of a well-selected herbarium is known to every botanist of the present day. It presents to him the most important specimens of the flora so far as

known, and the better the specimens are preserved, the more valuable the collection. A very important, if not the most important, question is, how to preserve the natural color of the foliage as well as the color of the petals.

No doubt, the rapidity with which the plant is dried greatly influences the preservation of the natural color; but in the course of time the great majority will fade, while others acquire different shades, some turn black, some brown and various other colors. This last change of color frequently takes place while the plant is being dried, and more rarely later on.

Not only the leaves, but the petals of most flowers change in the same way, thus lowering the value of the specimen to a considerable extent.

Nienhaus published in the *Schweizerische Wochenschrift für Chemie und Pharmacie* his experience with oxalic acid as a preserving agent of the color of petals of dried plants. His theory was that ammonia in the air caused the fading of the color, and that it would be neutralized by this acid; therefore, he recommended that the plant be dried between filter-paper, which had previously been saturated in a 1-per-cent solution of the chemical and then dried. Nienhaus experimented with the petals of papaver rhoeas, and was very successful. According to some American writers, who have repeated his experiments, the results were entirely negative.

Since then I have had occasion to study the value of Nienhaus' process, and have found that not only the petals are well preserved, but that a 3-per-cent solution will also preserve the color of the leaves. In the hope that the results may be of interest to collectors of plants, I think it proper to bring it to their notice.

Several specimens, which had been dried by the aid of 1-per-cent. oxalic acid, did not give me as good results as I had hoped to obtain, and I then determined to study the value of different strengths of the solution, and find out which would be most suitable to be employed in average cases. For this purpose I saturated some gray felt paper

with solution of oxalic acid, varying in strengths from 1 to 5 per cent, and dried.

Leaves of different texture were selected, dried between the thus prepared paper at ordinary temperature, changing paper once in twenty-four hour.

Leaves of a thin texture were well preserved with a 2-per cent solution; not so well with that of 1 per cent. Those dried between 3 to 5 per cent paper did not differ materially in appearance from those dried with that of 2-per cent strength.

Leaves of a thick texture were best preserved with 3 per cent of the acid, although the 4 and 5 per cent solutions showed no disadvantage.

The leaves of aquatic plants were best preserved with 2 or 3 per cent of acid; the 1-per cent specimens turned dark, and with 4 or 5 per cent they were almost black in one case, while in other aquatics I could observe no difference between any of the specimens; they all had kept well.

These results suggested to me that paper saturated with a 3-per-cent solution of oxalic acid might be used with more advantage for the majority of plants than a 1-per-cent solution, as recommended by Nienhaus. It is not unlikely that the kind of drying-paper used influences the results to some extent. Nienhaus recommended filter-paper to be employed; in fact, the heavy felt paper mostly employed in this country is not often used in Germany for drying purposes; the botanists there prefer a very much thinner gray paper.

In almost all cases where a 3-per-cent solution of oxalic acid was employed, I have obtained satisfactory and encouraging results, except with some members of the umbelliferae, which turned dark when thus treated. I had not the opportunity of making further experiments with them, and do not know their behavior when dried in paper without the aid of oxalic acid. The leaves of *Phytolacca decandra*, under ordinary circumstances, turned to a very dark color; when dried by the aid of a 3-per-cent solution of

oxalic acid they remain green. The leaves of geranium maculatum commonly turn reddish-brown; when preserved with 3-per-cent of the acid they remain green. The leaves and petals of baptisia tinctoria almost invariably turn black when dried in the ordinary way; when preserved with 3-per-cent oxalic acid, the change is much less pronounced and the petals remain yellow. In all specimens the colors of the petals was unchanged.

The results which I have obtained by this process lead me to the conclusion that it may be employed with decided advantage in almost all cases, and I will briefly state the method I have employed:

Heavy gray felt paper was thoroughly saturated with a 3-per-cent solution of oxalic acid, and dried. This, when done at ordinary summer temperature, required about twelve hours. Directly between the thus prepared paper I placed the plant; in case the petals were very delicate, they were protected by a very thin piece of paper to prevent imprints from the rough felt paper. The latter was changed once in twenty-four or thirty-six hours, until the plant was thoroughly dried, and it was then mounted in the ordinary way. If possible, the plants should be placed in the press at the time of collection, or carried in an air-tight box and moistened before pressing.

Up to the present date I have not had the opportunity of studying by experiments to what extent plant colors are really injured by ammonia, but I hope to be able to report upon this question at a subsequent date.—*American Journal of Pharmacy*.

BACTERIOLOGY.

Marsh Fever.—M. A. Laveran presented a paper at the Academy of Science, Paris, in which he stated that although the presence of amoeba in the blood during marsh fever is now well established, there is hardly any ground for the assumption of a distinct species peculiar to each variety of the disease, one for tertiary ague, another for quaternary ague, and a third giving rise to an irregu-

lar fever. This statement is supported from microscopical as well as clinical observation.

Avian Tuberculosis.—According to the *Revue Veterinaire*, MM. Cadiot, Gilbert, and Rogers conclude from their researches that the bacillus of avian tuberculosis and that of mammals are two varieties of the same species. It is possible to transform one into the other. Avian tuberculosis is easily inoculated into the rabbit, but not so readily into the guinea pig. After having been grown in mammals, it may become very active for the guinea pig, at the same time losing some of its pathogenic powers for the birds.

Products of *Pneumobacillus* of Friedlander.—The products of this organism according to Grimbert are ethyl-alcohol, acetic acid, laevolactic acid, and succinic acid. In glucose, galactose, arabinose, mannite, and glycerine this organism produces lavelactic acid, while saccharose, lactose, and maltose give both succinic acid and laevolactic acid. In dulcite, dextrin and potato it produces only succinic acid.—*Ann. Institute Pasteur*.

Bacteriology of Air Passages.—In an article read before the Academy of Medicine, April 7th, by Dr. W. H. Thomson, he quotes from Dr. St. Clair Thomson and Dr. R. T. Hewlett, of the Bacteriology Department of the British Institute of Preventive Medicine, to the section on pathology at the last annual meeting of the British Medical Association, which led to special research as to the fate of micro-organisms in inspired air. They calculate that the lowest estimate of organisms inhaled every hour would be fifteen hundred, but in London atmosphere it must be common for fourteen thousand organisms to pass into the nasal cavities during one hour's tranquil breathing. Beginning with the trachea, they found that the mucus derived from the trachea of all animals recently killed in the laboratory was always sterile. The mucus membrane of a healthy nose only exceptionally shows any micro-organisms whatever. The interior of the great majority of normal nasal cavities is perfectly aseptic. The vestibule of the nares,

the vibrissæ lining them, and all crusts forming there are generally swarming with bacteria. The vibrissæ seem to act as a filter, and a large number of microbes meet their fate in the moist meshes of the hair which fringes the vestibule. This arrangement not only arrests the ingress of germs; but by the action of ciliated epithelium those which have penetrated into the nose are rapidly ejected.—*Medical Record*.

Microbe of Scurvy.—Teste and Beri (*Gaz. degli Osped.*) have isolated from a fragment of tissue taken from the gum of a scorbutic patient, a micro-organism which they believe to be the cause of scurvy. The microbe is round, stains in all the aniline dyes, but resists Gram's stain. Its cultures liquefy gelatin, and give rise to a sawdust-like deposit. Guinea-pigs and rabbits inoculated with these cultures have a rise of temperature, and the microscopy shows hemorrhagic stains in various parts of the body, and nodules of connective tissue, new formation. The above results were obtained in three out of four experiments. In the fourth, the authors attribute the negative results to the fact that the patient had improved considerably under treatment.

Microbic Origin of Rickets.—Microli (*Gaz. Med. di Torino*) believes that this disease is caused by the effect of ordinary pyogenic organisms upon the osseous and nervous system. Clinically he finds support for this theory in the fact that rickets develops independently of social conditions. It frequently begins with eczema, boils, or intestinal catarrh; occasionally occurs epidermically, and is accompanied with fever, polyarthritic and bone pains, hydrocephalus, marasmus, and paresis of lower extremities. Pyogenic organisms have been found in the bones and central nervous system of rickety children. Experimental injections of pyogens into the bones and epiphysical cartilages of young rabbits produced in some cases common osteomyelitis, but in other cases an osteomyelitis without traces of suppuration, with hypertrophy of cartilages analogous to that of rickets and marasmus.

Germs in Mother's Milk.—Cohen and Neumann found germs in healthy breast-milk, even after taking every antiseptic precaution in relation to the nipples. Honigmann, Knochenstein, and Pallecke have observed pus-producing germs in the milk of a large proportion of nursing women.—*Modern Medicine.*

MEDICAL MICROSCOPY.

Heredity of Acquired Immunity.—Vaillard concludes from his work on immunity that the mother only is in a position to communicate immunity to her progeny; the father never transmits immunity to his progeny; the immunity received from the parent is always of brief duration; it is retained only during the first months of life.—Ann. Institute Pasteur.

A New Serum For The Treatment of Infectious Diseases.—REKOWSKI (quoted by the *Journal of Cutaneous and Genito-Urinary Diseases*, March, 1896) states that antitoxin contained in the blood-serum of an animal into which bacterial toxins of diphtheria or tetanus have been injected is the product of a special irritation of the cell molecules by the toxins. But this special irritation can be brought about, not only by toxins, but also by some chemical substances, and in that supposition lies the explanation of the well known clinical properties of mercury, salicylate of sodium, and quinine, in syphilis, acute rheumatism, and malaria. Acting upon this theory, the author injected into a horse once a week and afterward twice a week thirty centigrammes of the following emulsion of mercury:

Hydrarg. salicyl., 1 Gm.;

Vaselin. liquidi, 10 Cc.

M. et ft. emulsio.

In the blood-serum of the animal very slight traces of mercury could be found.

He injected ten cubic centimeters of the blood-serum every three days in the glutei of patients affected with secondary and tertiary symptoms. The gummata disappeared and open sores healed after three or four injections.

The same results were obtained by Drs. Hilyn and Wreden (Kiew).

The author gave a horse thirty centigrammes of arsenic per day (forty-five grammes in all). In the blood, hardly noticeable traces of arsenic could be discovered. He injected ten cubic centimeters of the blood-serum of that horse twice a week into two patients afflicted with cancer of the face, and after six weeks noticed a remarkable improvement.

Serum Treatment of Diphtheria in Cracow.—Dr. Stapa has presented to the Cracow Medical Society a report of the results obtained by the serum treatment of diphtheria in the Children's Hospital of that city. During the year 1895 the number of children subjected to it was 258. Of these the mortality was 22 per cent. This compares very favorably with the mortality in the ten previous years, which was as high as 56.3 per cent., there being 709 deaths out of a total of 1,354 patients who were treated by other methods. Laryngeal croup occurred in 160 cases, and a rash having the appearance of scarlet fever and lasting from two to sixteen days in fifty-eight cases. It was noticed that certain samples always produced rash. No effect on the occurrence of albuminaria by the serum could be shown.—Medical Journal.

RECENT PUBLICATIONS.

Modern Microscopy.—Bailliere, Tindall & Cox, London, have put on the market a second edition of "Modern Microscopy," a handbook for beginners, combining: (1). The Microscope, and instructions for its use, by M. J. Cross; (2) Microscopic objects: How prepared and mounted, by Martin J. Cole. The subject-matter has been thoroughly revised and additional information on methods of manipulation has been introduced. This new edition will be found very useful to the beginner.

The Crambidæ of North America.—The Massachusetts Agricultural College published, January, 1896, a very inter-

esting work on "The Crambidae of North America," by C. H. Fernald, A. M., Ph. D. It is a ninety-three page pamphlet where the family Crambidae, its distribution, its natural enemies, its history, the enemies of these insects, etc., are perfectly described. The book is made additionally valuable by the addition of six plates in colors and three in black and white.

Microscopical Studies in Botany.—This is the name of a new periodical published in Jersey, by James Hornell, director of Jersey Biological Station. The price is 3s. 6d. post free. The annual subscription (post free) is 8s; or inclusive of 50 illustrative microscopical preparations, 21s, post free. This magazine is made interesting on account of original photomicrographs accompanying the subjects described. Thus vol. 1, part 2, for March, 1896, contains ten of these beautiful photos.

Asiatic Cholera in India.—Mr. E. H. Hankin is the author of a book on "Cholera in India Cantonments, and how to deal with it." The work consists chiefly in giving directions for preventing the disease. The author has had an excellent opportunity for study during the various recent outbreaks in India. The properties of the cholera microbes as given by Mr. Hankin are as follows: first, organism when outside of the human body, only lives and reproduces in water; second, it is so small that it cannot be removed by filtration through ordinary domestic filters; third, it is easily destroyed by boiling; fourth, it is easily killed by dessication; fifth, it is very sensitive to acids; sixth, it varies in virulence; seventh, its growth is favored by the presence of small amounts of common salts and nitrates.

Books May Carry Contagion.—It is generally admitted that books may carry contagion. Drs. DuCazal and Catrin obtained positive results with Streptococcus, Pneumococcus and Bacillus diphtheria. Negative results were obtained with Bacillus tuberculosis and Bacillus typhosus.—Ann. Institute Pasteur.



CHAS. W. SMILEY.

THE AMERICAN
MONTHLY
MICROSCOPICAL JOURNAL.

VOL. XVIII.

AUGUST, 1896.

No. 8

Professor Charles Wesley Smiley.

BY RENE SAMSON.

(WITH FRONTISPIECE.)

For some time this JOURNAL has been publishing the portraits and autobiographies of prominent writers whose articles appear from time to time in these pages. We take advantage of Mr. Smiley's four months' absence in Europe to add a sketch of his life to the list.

Professor Charles Wesley Smiley was born September 10, 1846, at Fitchburg, Mass. He attended Fitchburg High School, Wilbraham Academy, Vermont Conference Academy, Montpelier, Vt., Fort Edward Collegiate Institute. In 1874 he graduated from the Wesleyan University with all the honors.

He afterwards taught in Centenary Collegiate Institute, Hackettstown, N. J., in Drew Seminary and Female College, Carmel, N. Y.

In 1877, leaving teaching for literary work and Psi Upsilon fraternity work, he remained at Madison, N. J. During two years there he published "Songs of the Psi Upsilon Fraternity," "Record of the Forty-fourth Annual Convention of the Psi Upsilon Fraternity," "The Oration and Poem of the Forty-fourth Convention," "Record of the Forty-fifth Annual Convention" of the same, and also of the Forty-sixth and the Forty-seventh, and "Catalogue of the Psi Upsilon Fraternity."

These two years of editorial work brought him into

prominence and he was called to Washington as chief clerk of the Fishery Investigation of the Tenth Census; then raised to the position of Chief of the Division of Records and Publications of the United States Fish Commission, and editor of the Annual Reports and Bulletins. For the Eleventh Census his services were again called for and he was named Special Agent in charge of the Fishing Industry and Chief of Division of the United States Census office. The most important writings of Professor Smiley published during those years are: "The Spanish Mackerel and its Artificial Propagation," "Changes in the Fisheries of the Great Lakes," "Removal of Bass from Indiana to North Carolina by the United States Fish Commission," "Results of Planting Shad in the Muskingum River," "The proposed use of Steamers in the Mackerel Fishery," "Descriptive List of the Publications of the United States Fish Commission."

I find Professor Smiley's name as editor on the "Berean Bible Lessons" and the "Berean Tract" from 1875 to 1878 and on the "Diamond" in 1880. He is also the author of the pamphlet "Altruism Considered Economically."

Since 1887 Prof. Smiley has been the editor and proprietor of this Journal and since 1891 of the Microscope.

He is a member of many scientific societies, among them, the American Association for the Advancement of Science, the American Fish Cultural Association, the Philosophical Society of Washington, D. C., the Biological Society and the Anthropological Society, also of Washington.

Professor Smiley of late years spends each summer abroad; in 1891 he travelled in England and France; in 1892 he visited Scotland, London and Paris; in 1895 he spent the summer in Switzerland with a brief stay in Holland, Belgium and the Rhine Valley. This year he went to Switzerland, passing through Belgium and going up the Rhine.

Studies in Elementary Biology.

BY HENRY L. OSBORN,

HAMLINE UNIVERSITY, SAINT PAUL, MINNESOTA.

These studies are intended to point the way upon easily accessible material to some of the fundamental facts about the cell. A much larger range of subjects and more detailed and exhaustive studies on each one would undoubtedly add much to the intelligent grasp of the student, but with a clear and distinct knowledge of the points made in this article it will be found that the difficult subject of the cell will receive considerable illumination. The article is not designed to supply general information about the cell, but to suggest and direct convenient topics for investigation in the laboratory. It is expected that such laboratory work will be accompanied by the study of some such text as Parker's Elementary Biology, in which the correlated general information can be found. In view of the fact that there are already a great many similar manuals in existence I can only urge as an excuse for sending out still another that I find that many cases have come under my instruction which call for a shorter course than any of which I at present know.

PART I.

1. THE POTATO TUBER.—Examine a whole potato and determine whether there is any law shown in the location of the *buds* or *eyes*, and whether you can recognize opposite *ends*. If there are scars on the surface, determine whether they too are definitely located. Compare a number of different specimens of the potato, to decide whether the law prevails in all as to the location of the buds. Draw a spiral line around the specimen passing through all the buds, noting that they occur at equal angles; number them in order, beginning at the

base of the series and then note that the buds in line over each other are in similar numerical series. Does difference in shape or size of specimens affect the law of position of the buds? Compare the potato with twigs of shrubs or trees, and with convenient herbaceous stems, and notice: that all have a definite law ruling the location of the leaf or flower buds, the law differs with different kinds, the buds are closer as you approach the apex of the stem. The potato is thus comparable with other stems; it is in fact a modified stem growing beneath the ground, and used in the economy of the plant for the storage of *starch*.—The definiteness of location of the parts of a living being is in general called *symmetry*, a review of animals and plants will convince you that it is a very general law and that only slight departures from symmetry are commonly if ever met with. Draw views showing as many as possible of these points.

2. TISSUES OF THE POTATO.—Cut as thin a slice as possible completely across the specimen in the level of one of the buds, examine this carefully, using the hand lens and recognize that it is composed of three different kinds of material, *tissues*, viz.:—(1) the *bark*, a thin brown outer layer commonly called the skin; (2) a thin layer everywhere parallel with the bark except at the level of the bud, where it runs to the bud and enters it, the *fibro-vascular* tissue; and (3) the *parenchyma*, filling in all of the remainder of the specimen.—Cross-sections of herbaceous stems, e. g., that of the geranium, will show the same layers, the parenchyma or *pith* is however relatively much less extensive. Draw a general view of the section.

3. CELLS OF THE POTATO.—Cut a thin section of a small part of the potato, passing through all of the different tissues, the slice must be thin enough to see

through with the microscope, it can be cut with a razor or very sharp scapel, the blade well flooded with water. Cut a number of sections to get practice, and float them as cut into a watch-glass, taking to care that you are able to recognize the exact location of the parts of the section in the potato. Select the thinnest and transfer it to the center of a slide, examine it uncovered l. p. to recognize its parts and draw, then cover it with strong iodine solution and let it stand for several minutes. Now wash out all the iodine that will come away, add a drop of water and cover and examine with the low power. You will now find that the parenchyma is all stained blue, while bark and the fibro-vascular tissue are colored brown. Iodine stains starch blue, while it stains cellulose and protoplasm brown, thus you learn that the parenchyma is largely starch. Examine the different parts of the section with the higher power, noting that starch is in oval grains and embraced by a net-work of *cell-walls*, which stains with the iodine with difficulty, they are composed of the substance *cellulose*; (where the starch grains are not inside of cells, it is because they have escaped in the process of making the section.) Examine the cells in the level of the bark and see that some of them are deeply stained brown, note their shape and position, distance from the surface and from the parenchyma, note in some the more densely stained, round *nucleus*, and search for some in which a few grains of starch can be seen in process of formation, determine their exact location in the cell and draw them. Examine also the fibro-vascular tissue and distinguish certain spiral structures; they are cells which have thickened walls used for support.

If it is desired to do so you can preserve the section temporarily by draining off as much as possible of the water and replacing it with glycerine; or a more per-

manent mount can be made with glycerine jelly, the latter is melted and then applied in the same way as glycerine. All preserved specimens should be labeled so as to record their history as fully as possible.

4. EPIDERMIS OF THE ONION is an easy object on which to demonstrate protoplasm in the cell. *Protoplasm* is a semi-fluid finely-granular material contained in all living cells; the practical biologist must learn as early as possible to recognize it, and distinguish it from the other cell contents if there are any. To see it, take an onion and carefully remove a small bit of the skin on the glistening surface of one of the inner leaves and mount it in water. In contrast with the potato the onion is a very short stem whose leaves are close together and modified for the storage of starch. Care must be taken to get only the outer layer of skin. Study the piece and note the forms of the cells, select one for careful study and carefully locate the granular matter, *protoplasm*, on its surface; and the round granular *nucleus*; note also the thickness of its wall; does the centre of the cell contain protoplasm? Remove the cover glass and stain well with iodine, wash out and cover and then re-examine, the *protoplasm and nucleus* ought, if successful, to be stained; do you find any evidence of the presence of starch? Make another mount and in this case apply 10 per cent nitric acid to the cells, wash, cover and examine and you will see that now the centre of the cell is occupied with granular material and the surface is clear, the water that before occupied the centre has been drawn out and the protoplasm has shrunken away from the wall into the centre of the cell. Record this and all your observations by careful drawings, in which each cell is accurately represented, and fully index.

5. MAMMALIAN LIVER.*—We have now seen that plants

*If sections of the liver are not available, other animal tissues will serve.

are composed of cells, and studied some of them, animal organs are likewise so made up. The cells of animal tissues are so small and their walls are so delicate that it is not possible to demonstrate them directly from fresh material as in the case of plants, but the tissue must first be carefully preserved and then sections must be prepared from it. Study the whole section with the low power and demonstrate a general type of hepatic strict liver tissue and besides certain other slices of ducts, vessels, etc.; which latter may be ignored. Examine the liver cells and determine their form and mutual relation. Do they come in contact with their kind on all slides? Are they all of exactly the same shape and size? Can you recognize a distinct wall, and is it thick, or thin? How does the wall compare with that of the onion cell or of cells in the potato? Is the cell filled with granular stainable protoplasm? Is there a nucleus? Do you find a definite wall bounding the nucleus? Has it a definite content? Does the content appear to be of a protoplasmic nature? Can you recognize distinct parts *nucleoli* in the nucleus? Find a place in the section which adequately illustrates the these points and make an exact drawing of it.

6. SUMMARY OF PART I.—Review all the studies thus far made and test the following statements, using them as evidence: The cell is a minute object, composed of protoplasm, it has a definitely shaped nucleus, and is enclosed by a wall which may be either thick, in plant cells, or thin and flexible, in animal cells. Cells are massed in great numbers and thus compose the tissues of living objects, the grouping of which gives the object as it is known to us through our ordinary senses. In scientific language a part composed of tissues of an animal or a plant is an “organ.” The arrangement of the tissues and organs of living things always obeys a certain law peculiar to each being or group, called its “symmetry,” beings may vary inside of narrow limits, and in

fact no two are exactly alike, but still the law of symmetry plainly dominates their structures. Cite evidences of this law of symmetry from animals or plants at large.—Can you find anything comparable with it in minerals?

PART II.—UNI-CELLULAR ANIMALS.

7. AMOEBA.—The properties of protoplasm and of the cell can be best studied by taking up first the uni-cellular and simplest beings, though in many of them there are specializations which must be excluded from our general notion of either protoplasm or the cell. Amoeba is found on the scum on the leaves of water plants, it can often be found in water containing dying and decomposing Spirogyra or other Algae, it must be examined with the high power. It is translucent, irregular and changing in outline and faintly granular. A specimen should be kept under continuous observation for at least an hour, the slide being moved to compensate for its progression. First observe its changing outline, the thrusting out of *pseudopodia* which are motile and some of which increase while others diminish, the creature flowing out into them. Make a series of drawings to show the form at successive equal intervals of time. Study and determine that the substance presents a thinner clearer *ectoplasm* on the outside, and an inner *endoplasm*, the latter being occupied by variously shaped objects, *food vacuoles*, some of which can perhaps be recognized as microscopic plants which have been swallowed to serve as food. You should also be able to distinguish in the endoplasm minute brightly shining *fat droplets*. Locate also the *contractile vacuole*, a clear spherical space in the endoplasm, and watch to see that it contracts and reappears in the same place at regular intervals; determine the rythm. There is a *nucleus* in the centre of the body, but it is not generally visible in

a live specimen. There are a number of different species of *Amoeba*, if you can find more than one, compare and draw them all.

8. PHYSIOLOGY OF AMOEBÆ.—It is not easy to demonstrate all of the functions of the cell upon *Amoeba*, but a summary of them may be conveniently made here and as many of them should be observed as possible. It is often impossible to find specimens that illustrate desired points at a given time, but they are often met incidentally while in the pursuit of other items, and can then be watched. The most conspicuous function of *Amoeba* is *motion*. This takes several forms, such as (1) *cyclosis*, or the circulation of the protoplasm; (2) *contraction* of the vacuole; and (3) *locomotion*—by means of the pseudopodia. A careful study of the latter will show that it is in the ectoplasm that the motion takes place first, the endoplasm flowing into it as the pseudopodium enlarges. Occasionally you can catch a specimen in the act of *engulphing* his food; this takes place by the formation of a pocket in the ectoplasm which gradually encloses the food and finally shuts it into the endoplasm. After a time the indigestible residue of the food is rejected by the inverse process. There is no definite part used in either of these processes. It is the general belief of biologists that *Amoeba* has powers of *sensation*, but the illustration of this can be better made on *Paramecium* and *Vorticella*. Occasionally specimens of *Amoeba* are found that appear to have a line crossing them in the middle. These ought to be kept in sight and after a brief interval you will find that the line deepens till it cuts the animal in two; it is by this process of *fission*, a mode of the general function of *reproduction*, that *Amoeba* multiplies. The two small *Amoebæ* feed and grow to the size of the original and then the process repeats itself. It should be remem-

bered that Amoeba acquires additional interest from the fact that the white-corpuscles of the blood are similar to it in form and mode of locomotion, as well as many other cells in the bodies of various higher animals.

9. CELL-WALL AND NUCLEUS OF AMOEBÆ.—Irrigate a mount with Amoeba in the centre of the field of view with iodine. If successful in keeping the specimen from being washed away you will see that it stains with the iodine and thus your belief in its protoplasmic nature is corroborated, and the *nucleus* will now become visible. Can you recognize any definite *cell wall*? Mount a fresh slide, find and centre another specimen, and irrigate with a dilute 1-per cent. acetic acid; watch the specimen as it feels the reagent; it will shrink; and then the cell protoplasm, *cytoplasm*, will become transparent while the *nucleoplasm* will become denser.

10. PARAMAECIUM.—The “slipper animalcule” can nearly always be found in water in which organic material has been macerating for a few days. Mount a drop of such water and search for a specimen; it is best if possible to find one which is entangled in fibres which will embarrass its movement. Keep a specimen under observation for a long time; as you get accustomed to it the quick motions will be less bothersome. Determine the following anatomical points: the shape is definite, and, if the animal for a moment loses it, it at once returns to that shape; locate on one side a funnel-shaped passage leading into the body, the *gullet*; locate the general covering of *cilia* with which the animal is clothed. Can you see any in the gullet? Can you decide that there is a particular direction of movement preferred by the specimen, is this general for all you can find? Make a drawing and indicate the direction of motion. Examine the interior, and recognize the numerous *food vacuoles*; are they found in all parts of the

animal? Locate two *contractile vacuoles*; what is their rythm? Do both contract at once? (There is a central rod-shaped nucleus not easily seen in living animals.) In looking through large numbers of P. you are sure to find some in the act of *fission*; such should be carefully drawn and followed through the process.

11. ACTION OF REAGENTS ON PARAMAECIUM.—Irrigate a mount of Paramecium with iodine, it will kill the animal, at once arresting the cilia and showing them clearly. By its action on the body it will demonstrate its protoplasmic nature. It may also demonstrate the nucleus, but not if the specimen is too thick. Irrigate another mount with 5 per cent acetic acid: this may enable you to see the nucleus.

12. POTENCY OF DRUGS AS TESTED ON PARAMAECIUM.—Examine Paramecium in a watch glass, *l. p.*,* watch the motions and try to decide whether they seem to indicate control on the part of the animal, *automatism*. Add a drop of a known strength of corrosive sublimate to a known amount of fluid containing Paramecium and ascertain whether it is fatal to Paramecium. If it is, repeat the experiment, using a weaker solution of the corrosive. Keep this up till you determine the percentage of corrosive in water which is just barely fatal to Paramecium. Determine the same percentage for acetic acid, also for alcohol. Can you infer that drugs have varying power to affect cells?

13. VORTICELLA.—Search on the threads of fresh-water algæ for Vorticella, study the colony *l. p.* and then study individuals, *h. p.*, distinguish the long slender contractile *stem* attached below and bearing on its summit the bell-shaped *body*; locate the *peristome* or rim of the bell, and determine that it is ciliated; do you find cilia in any other part of the body? Note the *epistome* closing the

* *l. p.* and *h. p.* indicate low and high powers respectively.

end of the body, and at one point in it and above the peristome the funnel-shaped *gullet* running down into the body and closed below. Locate inside the body the numerous *food-vacuoles*, and a single *contractile vacuole*. Study the end of the gullet and note the gathering particles there of food, keep watch and after a time you will see them constricted off and become one of the food-vacuoles. The *nucleus* is a curved rod on the side of the body opposite the mouth, it can best be seen after treatment with reagents. Study the stem carefully to locate the *spiral thread* inside it, it is this which by its contraction coils the stem; how does this benefit Vorticella?

14. PHYSIOLOGY OF VORTICELLA.—*Cyclosis* or the circulation in the protoplasm of Vorticella can often be seen by the motion among the vacuoles; the constant action of the cilia is another form of motion; the contraction and expansion of the stem and body are also of this class of functions; a careful series of drawings should be made to show the steps in the process of contraction and expansion. Jar the slide and you will see that the animal responds by a complete responsive shrinkage of the stem and body. This is the function of *irritability*, and the jar would be called a *stimulus*. Can you determine that Vorticella is sensitive to all changes in its surroundings? A current of very weak acid will cause it to contract and strong acid will always kill it in the contracted condition. The form of stimulus that most commonly affects V. is contact with other motile animals in its vicinity. *Fission* takes place in Vorticella, it may take place in either a longitudinal or a transverse plane, different stages of it or the entire process should if possible be observed. In some cases after fission one of the parts unites with another Vorticella and the two fuse to form a single body, *conjugation*. It seems that this pro-

cess of conjugation restores the waning power of fission.

15. STENTOR.—The “trumpet animalcule” should be examined if obtainable, and compared with *Paramecium* and *Vorticella*. It stands in an intermediate position, having a stem functioning like that of *Vorticella* but not differentiated from the rest of the body. There is a spiral row of large cilia at the broad end leading to the gullet. Specimens can sometimes be found undergoing transverse fission.

16. SUMMARY OF THE UNICELLULAR ANIMALS.—The study of the Protozoa, the branch of the animal kingdom in which these forms are placed, furnishes some data for a general notion of the animal cell. They are all minute masses of protoplasm, having a nucleus, but not having a rigid cell-wall; they all have powers similar in kind to those of animals at large, which may be stated as: (1) power of feeding and nourishing the body; (2) power of motion and sensation; (3) power of reproduction. All of these powers are automatic, i. e., they are under the control of the animal. All these animals live in water containing living beings, principally plants, and they have no power to thrive in clear water, that is to say they have no power to make complex chemical compounds such as compose the protoplasm of which they are composed, from the simple carbon-dioxyd and ammonia that are to be found in rain-water.

PART III.—SIMPLE CHLOROPHYLL-CONTAINING PLANTS.

17. *PROTOCOCCUS* is a green growth found on bark of trees and fence-boards in half shaded places. A small particle of it should be mounted in water; gently tapping the cover glass will disperse a number of minute green masses, *colonies* of P.; large single cells should also be studied. Stain a mount with iodine to test for protoplasm; how does the green colored material stain? The

green color is due to *chlorophyll*; it is the same substance as that found in the leaves of higher plants, and has important relations to the chemical changes in plants. Can you recognize a nucleus in the large cells? Test to see if it stains deeply with iodine. Can you prove the presence of a definite and strong cell-wall? It is composed of cellulose (to prove this, stain with iodine and then with strong sulphuric acid; it becomes blue). Study different colonies, noting exactly the size and position of the component cells, and attempting to decide the way in which they have been formed. Do division lines fall in several different planes? What sort of a form would result from the continued division of the cells if they did not become separated? Treat some *Protococcus* with strong alcohol, noting the green color which is imparted to the latter, then examine to note that the chlorophyll has been dissolved, now stain and show that protoplasm is left, filling the cell. If possible study the motile stage of *Protococcus* and recognize the flagella (see Parker for details.)

18. SPIROGYRA.—Mount pieces of the filaments of *spirogyra* in water and study single filaments. Decide whether they branch; locate the cells; are all of the same shape and size? Do you find any indication of the formation of cells by fission? Examine a single cell; locate its side and end walls, and determine their thickness; locate the *chlorophyll band*; is it a spiral? Is it in the centre or on the wall of the cell? Follow its winding by focusing. How many spiral bands do you find? Is the number the same in all the cells of the same filament? Does it vary in different filaments. Do they pass from one cell to the next? Note the *crenated margin* of the band, and the numerous denser green globules, *pyrenoids*. Locate the pyrenoids carefully in an exact drawing of one cell. Search through the cell for protoplasm, locate the

nucleus in the centre of the cell and the strands of protoplasm running from it to the protoplasm on the wall.— Watch the strands for Cyclosis.

Irrigate a water mount with 10 per cent. nitric acid and watch a cell; you will see the protoplasm including the bands shrink away and occupy the centre of the cell. Stain another water mount with iodine and by its help locate the protoplasm of the cell. Mount a portion of Spirogyra which has been preserved in alcohol during the act of *conjugation*, locate first ordinary cells, their contents shrunken by the action of the alcohol. Then find filaments in which the cells are connected and study all the different stages in the process of conjugation from the first appearance of the lateral growth to the fusion of these and the transfer of the cell contents from one cell to the other, the formation of the *zygo-spore*. Find cases of *parthenogenesis*. Can you find zygospores formed between cells of the same filament? Record all your observation by means of fully indexed drawings.

18b. CYCLOSIS. The cyclosis in the protoplasm of a cell can be seen best in the hairs of the stamens of *Tradescantia*, but they are visible in similar hairs of other plants, and show well in the leaves of the water-plant *Eledone*, where the chlorophyll grains are carried in the circulation. A cell should be selected for study and the process watched long enough to enable you to determine the courses of the currents in the various parts of the cell; drawings should be made indicating the direction of the currents by means of arrows.

19. OSCILLARIA.—If this alga is at hand, mount and study its filaments, locating the shapes and positions of its cells; but especially studying them to see the *movements* of the filaments. These are both motions of oscillation or a lateral swaying, whence its name, and motions in the long axis of the filament.

20. BRANCHING ALGÆ.—Mount and examine pieces of a branching alga in water, study it to distinguish the cells, then study them in turn and attempt to decide by what steps of cell division the aggregate has been built up. Do all cells branch? Do branches arise at any particular part of the branching cells? Does more than one branch arise from the same cell? Are all the cells alike, or can you find cells that are forming spores? If so, where are they located? Can you find any of the spores in the act of developing? How does a spore differ from an ordinary cell?

21. NUTRITION IN THE CHLOROPHYLLOGENOUS PLANTS.—All of the plants just mentioned can and generally do grow in clear rain water. There is no evidence that any of them require organic food to sustain their life. Though they are constantly building up protoplasm and growing they do not get this from ready-made supplies but form it from carbon-dioxyd, ammonia and water, which abound where they live. They require sunlight and chlorophyll, to enable them to carry on their chemical operations. How does this compare with nutrition in animals as shown by the Protozoa? Read on the function of *chlorophyll*.

PART IV. NON-CHLOROPHYLLOGENOUS PLANTS.

22. YEAST.—Mount a small particle taken from a cake of “compressed yeast,” add water and thin it considerably, and examine uncovered. You will find a multitude of exceedingly minute oval objects and fewer larger oval ones. Add a drop of iodine and examine, you will now be able to recognize the large ovals as grains of starch, the small ones by their brown stain as yeast cells.

Mount a drop of yeast from a vessel containing Pasteur’s solution, in which yeast has been actively growing, thin with water and cover, examine, *h. p.*, and find

colonies consisting of varying numbers of yeast cells; take care not to confuse single cells merely in mechanical contact with cells that are really in vital relation. Study different colonies and note the exact size and position of its different members. Do the colonies furnish any evidence by which to decide on the mode of reproduction of the cell? This mode differs how from *fission*? It is called *gemmation* or *budding*. Do you find any symmetry in yeast? Do the new cells tend to arise at definite points on their progenitors? Note that both gemmation and fission take place without the intervention of other cells. It is called the *asexual* mode of reproduction. What other mode of asexual reproduction have you noticed? How do they differ from conjugation. Examine for comparison yeast which has been standing an equal time in pure water; do you find any indication of growth?

Stain a colony with iodine, and study the cells with the strongest magnifying power at your command. Examine the oldest cell of a colony and locate in it a clear space—the *vacuole* surrounded by protoplasm. Examine cells of different ages, and determine whether a vacuole is found in all. Why does the vacuole change from light to dark in different focal levels? In some cells you will find minute *droplets of fat*. Do you find any *chlorophyll*? Can you find a *nucleus*? How do you know that the vacuole is not a nucleus? Is the vacuole exactly comparable with anything found in previous studies? Can you recognize a cell-wall? Is it thick or thin, and is it rigid or flexible? Mount and examine some dead yeast, the cell contents have disappeared, leaving an empty cell, the wall can now be seen. Sometimes you can burst yeast cells by pressure and get views of the fractured wall and escaping protoplasm. This can be facilitated by staining.

23. PENICILLIUM.—Examine a series of vessels contain-

ing Pasteur's fluid in which the conidia of *Penicillium* have been sown at different times. Compare them with a vessel in which conidia have been sown merely in water. Note the white spots, *colonies*, which appear on the surface of Pasteur's fluid, their daily increase in diameter, the appearance of a greenish spot in the centre of each and its increase in size; the fusion of the colonies as they reach each other to form a mat, *mycelium*, gradually growing denser and completely covering the culture fluid; the formation on older mycelia of a greenish dust, *conidia*, which can easily be blown into air. Note that the color is a bluish green, not identical with the color of chlorophyll.

Mount a very small colony, or a piece cut out of a larger one and examine first uncovered, *l. p.*, you can recognize the fine branching fibers, *hyphae*, of which it is composed; some of these stand upright and carry a broom-shaped portion bearing the greenish powdery *conidia*. With needles tease the fibres apart, replace the water with 50 per cent alcohol, cover and examine, *h. p.*, search for single fibres and study them. Make an iodine stained mount, and study that in connection, using it for comparison with the other. Determine first the shapes and positions of the cells. Do you find cross walls? Do the cells branch? At what part of the cell does the branch arise? Is the cell filled with protoplasm, or are there *vacuoles*? Do you find *fat droplets*? Can you find any *nucleus*? Is there any indication of the presence of *chlorophyll*? Is there any indication of a *cell-wall*? Study the termination of hyphae and compare them with the older portions of the same? What similarities and differences can you find?

Find the broom-shaped growth at the tips of some of the hyphae, it is the part devoted to the production of *conidia*. Locate the string of conidia. How many are there in a row? Are all of the same size? Do the rows

branch? Can you recognize a connection between the conidia? Which conidia do you think are the youngest, and why? Determine the relation between the row of conidia and the hyphae, are there several to each hyphae? Recognize the branching cells which connect with the hyphae, and the slender tips, *sterigmata*, which bear the conidia.

Sow a few conidia in a nutrient medium on a slide, set aside for a few hours in a warm moist place and then examine; you will find the conidia germinating, hyphae of various lengths being sent out from the spherical spore or conidium.

24. GENERAL SUMMARY.—What evidence can you cite from the facts thus far learned bearing on the following points:

(1) Cells not supplied with chlorophyll and not exposed to the action of sun-light require to be supplied with prepared nutriment, and cannot thrive in rain-water, while chlorophyll containing cells in the sunlight can make food from the simple compounds found in rain water.

(2) Motion and sensation, while not absolutely confined to animal cells, are decidedly characteristic of them and commonly nearly or quite wanting in plants.

(3) Cell growth and reproduction are characteristic of all cells, both animal and plant, and in either may take place by budding or fission.

(4) Reproduction may produce either solitary cells, which may be either simple or complex, or it may produce groups of cells in which the cells may be either all similar, or with some differentiation, or with considerable differentiation. That is, single cells may retain their individuality or they may become subordinate members of larger organizations.

PART V. NUCLEAR DIVISION.*

25. KARYOKINESIS.†—After the forms and functions of the cell have to some extent been enquired into, the biologist should attempt to become acquainted with the structure and activities which have become known in regard to the nucleus itself. Of late years a very great amount of attention has been directed to the study of the nucleus, and a great deal has been found out that was entirely unknown even so recently as ten years ago. This has been the result of improved technique, and of the improved objectives.

At first the section as a whole should be studied so as to locate the cells, then the nuclei should be closely examined with the highest magnifying power you can command till they can be clearly distinguished into two sorts: (a) *the resting nucleus* (b) *the active nucleus*. The resting nuclei are likely to be in the majority, they resemble the nuclei of ordinary fully differentiated cells. In them recognize: (1) the *nuclear membrane*, a fine unbounding line; (2) the *chromatine*, deeply stained grains scattered through the interior of the nucleus; (3) the *achromatine*, the non-stained remainder of the content of the nucleus. Make an indexed drawing of several resting nuclei.

The dividing nuclei will be seen in various stages of the act, and various drawings should be made in a series to show the different steps of the process according to your idea of them. In the most favorable cases where the act is well advanced you will recognize a great un-

*Favorable material is furnished for nuclear study from almost any developing tissue, either animal or plant, the growing tips of union roots, the spermary of the Cray-Fish, developing eggs of fish and other animals are among the suitable objects for this work. The material must be very carefully fixed with Flemming's fluid, then stained, and very thin sections cut from material imbedded in paraffine.

†See Wilson, Atlas of Fertilization. Macmillan, 1896.

likeness to the resting nucleus. The *chromatine* is now in the form of loops, of which there are two sets at opposite ends of the cell; the number of loops in each set should be counted and their location shown; the *nuclear membrane* has disappeared; there are fibres running through the chromatine and converging beyond at a point, *nuclear spindle*, at which in favorable cases a minute particle, the *centrosome*, can be seen. Lines can be seen to radiate from the centrosome into the cytoplasm as well as into the nucleus proper. After these points have been seen, you should examine other stages, you will if successful be able to determine (1) that the nuclear spindle forms very early, before the nucleus has changed, (2) that the chromatine takes the form of loops of a certain number, (3) that these are later separated into the two sets already mentioned which form the foundation of the new nuclei that are in process of formation, (4) and pull more or more widely apart. Still later than this, the spindle disappears and a nuclear membrane again distinctly surrounds the two new nuclei, each of which now contains an equal portion of the original chromatine. A large number of different dividing nuclei should be examined and drawn and their relation in point of time be carefully determined. (Besides this "indirect" mode of nuclear division, the nuclei of certain cells divide "directly," that is, there are no spindle or chromatine loops, but the nuclear membrane simply constricts in the middle and thus two are formed from one, as in typical cell division.)

PART VI. CONDITIONS OF CELL-LIFE, (YEAST.)

The cell being a living object reacts directly to its surroundings. By studying this reaction the effects of various conditions upon cell life can be inferred. Yeast appears on the whole to furnish advantages for experimentation, since it is always easy to get a supply through the commercial use of the fresh yeast cake. The test of its activity is the number of generations of buds produced in a given time, it being assumed

that most of the cells in the yeast cake are in a similar condition at the outset. It is of course necessary in examining different cultures of yeast to make sure that there is no mixing of different lots, and that enough different slides are examined to eliminate exceptional cases. It is important that all cultures be made under conditions that are uniform except as to the one condition which is being investigated, and in every case a standard control culture under the most favorable conditions should be made and examined as the basis of comparison.

26. **FOOD OF YEAST.**—Cultivate at 32 C. for 12 hours equal amounts of yeast in : (a) distilled or hydrant water; (b) Pasteur's solution without sugar; (c) sugar without the rest of Pasteur's solution ; (d) Pasteur's solution.* Make careful examinations of all four and determine by means of the growth of the colonies which is the best food. Carefully study the composition of Pasteur's solution and consider the inference that can be drawn from this experiment with reference to the nutrition of a non-chlorophyll-containing cell. Could Amoeba thrive in Pasteur's solution ?

26 b. **GAS PRODUCED BY GROWTH OF YEAST.**—Cultivate yeast in closed flask and collect the gases from it in a jar of water—test the gas thus obtained : first by lowering a lighted match or candle in it, noting that it will not support combustion ; and then prove by means of baryta water that the gas is carbon-dioxyd.

27. **TEMPERATURE.**—Cultivate for eight hours in Pasteur's solution equal amounts of yeast, at the following different temperatures, viz. : (a) 18 C. ; (b) 32 C. ; (c) 40 C. ; compare these and determine which is the most favorable temperature ; (d) place a portion of yeast in Pasteur's solution and heat slowly to boiling, then cool to 32 and keep at that temperature for eight hours and then examine to determine the effect, by comparison, with the best of the three preceding ; (e)

*For the formula for making Pasteur's solution, See Parker's Elementary Biology.

freeze a sample of yeast in Pasteur's solution, then thaw out gently and slowly raise to 32 C. and cultivate it for eight hours, after which determine the effects of freezing, first whether fatal, second whether harmful at all.

28. LIGHT vs. DARKNESS.—Cultivate at 32° C. in Pasteur's solution, two lots of yeast, one in a closed oven from access to the light, the other in the light; after cultivation of 8–12 hours, study and determine whether light plays any perceptible part in the cell life of the yeast cell.

29. EFFECTS OF DRUGS —This study has for its object to determine whether the presence of minute traces of various drugs affect cell life, and whether some drugs are more powerful than others. The method is to add to an optimal culture varied amounts of these drugs and then after several hours of cultivation to study their effects. A control culture must in each case be made for comparison, in which none of the drug is placed. Any or all of the following are suggested:

(a) CORROSIVE SUBLIMATE in distilled water. Yeast in Pasteur's solution in following ratios, viz.:—(1) 1 : 5000 ; (2) 1 : 10000 ; (3) 1 : 15000 ; (4) 1 : 20000 ; (5) 1 : 50000. Determine whether yeast is able to live in any of these, also whether it is killed instantly or after initial steps of growth have taken place.

(b) CARBOLIC ACID in Pasteur's solution with yeast, determine effects of following ratios, viz.: (1) 1 : 5000 ; (2) 1 : 2000 ; (3) 1 : 1000 ; (4) 1 : 500.

(c) ALCOHOL—(1) 1 : 100 ; (2) 5 : 100 ; (3) 10 : 100 ; (4) 20 : 100.

(d) PROBLEMS. Determine the ratio of different drugs and compare with the above, testing to find the amount the presence of which will arrest the growth or activity of the cell. Some or all of the following can be used, PRUSSIC ACID ; ARSENIC ; OIL OF CLOVES.

30. VITALITY.—Cultivate under optimal conditions a

lot of yeast which is known to have been dried for several months or even years. Determine whether it is still alive, and note, if it is shown to be so, that this proves that dryness is not fatal to yeast cells, also that life may be suspended for an interval of time and then its activities may be resumed. Can you think of parallel cases among plants: e. g., seeds and animals ?

APPENDIX.—SIMPLE METHODS FOR MOUNTING IN CANADA BALSAM.—(a) *Entire Objects*.—Small objects or organs of large objects such as hydroids, polyzoa, small crustacea, small plants, can be mounted in balsam if desired; a simple method is as follows: (1) If there be any cellular material present the specimen must first be *preserved*, a convenient general method being as follows. (1) Immerse in ten times the objects bulk of saturated aqueous solution of corrosive sublimate $\frac{1}{2}$ hour; (2) Wash in running water $\frac{1}{2}$ hour; (3) Transfer to 30 per cent alcohol 20 minutes; (4) Thence to 50 per cent alcohol 20 minutes; (5) Thence to 70 per cent alcohol 24 hours. This method is suitable for small objects in which it is not desired to bring out the finer nuclear figures. The preserved specimen should be stained as follows: (1) Immerse in borax carmine (or any other good stain) for 24 hours; (2) Transfer to a clearing fluid made by adding 2 parts of hydrochloric acid to 98 parts of 50 per cent alcohol and change so long as the clearing fluid extracts any color from the specimens. After staining the object must be completely dehydrated—This is done by passing it through 70, 95 and absolute alcohol, leaving it in each from 10 to 30 minutes or even longer according to size. While in absolute alcohol it must be carefully stoppered, especially when the atmosphere is very moist. After the water is thoroughly removed the specimen can be placed in oil of cloves or turpentine, till it becomes thoroughly trans-

lucent, when it can be mounted on a slide, enclosed in a cell, if thick, or surrounded by bits of glass, the superfluous oil removed as far as possible with a bit of blotting paper and replaced with Canada balsam which has been dried and dissolved in benzole or chloroform.

b. Sections.—Sections are made from objects which have first been preserved according to the method given above or some kindred method. The tissues to be sectionized may be held in the hand or in pith, in which case the very sharp razor blade is well flooded with alcohol and as thin a slice as possible is cut and floated off into a glass disk. It is then put through the course given above.

A finer method for section cutting, giving the finest sections, but only possible after considerable experience, is that of embedding the object in paraffine. The steps in this process are as follows, the object already adequately preserved and stained as described above and thoroughly dehydrated by passing through absolute alcohol is: (1) Soaked in chloroform (or turpentine or cedar oil) till the alcohol is thoroughly removed (6 to 12 hours), then transferred to a solution of paraffine in the same kind of oil for an equal time; removed thence and soaked in pure paraffine melted in a bath over steam

The heat in this bath must not reach 60° C. Should be only sufficient to barely melt the paraffine. When the last traces of chloroform (or other oil) are completely driven off by heat the specimen is placed in a mould and surrounded by melted paraffine which cools and hardens around it. Sections cut from this are run through turpentine to dissolve the paraffine and mounted in Canada balsam.

Whooping Cough Bacillus.—Kourlov has been investigating the saliva of whooping cough patients, and has found in every case and in them alone, a certain special, spore-forming, ciliated amœba, which he suggests may be the cause of the disease.—Bulletin Medical.

EDITORIAL.

General Index.—This General Index is received with very much pleasure by the subscribers. Dr. R. H. W. says: "It is excellent, and evidently cost you a great deal of labor, it adds greatly to the value of the set of books."

Walter White Objects.—Prof. L. W. C. writes: "Will you please send me as full a list as you have in stock of the Walter White objects. A friend of mine has been recently mounting some of them in my laboratory and I like them so well that I want to secure all that I can get."

The A. E. T. A.—The Sixth Annual Meeting of The American Electro-Therapeutic Association will be held on Tuesday and Wednesday, September 29th and 30th, and Thursday, October 1st, 1896, in Allston Hall, The Studio Building, on Clarendon Street, near St. James Avenue, Boston, Mass.

Prof. A. E. Dolbear, Tuft's College, Mass., is the Chairman of the Committee of Arrangements.

Dr. W. H. White, 222 Marlborough Street, Boston, Mass., is the Vice-Chairman of the Committee of Arrangements.

Dr. Frederick H. Morse, Melrose, Mass., is the Chairman of the Committee on Exhibitions.

The next annual meeting promises to be a greater success than any former one. Great interest is shown in all quarters; a large attendance is promised. Many candidates of national reputation are proposed for membership, so that the amendment to increase the limit of members becomes a necessity. The best talent has already announced papers, a larger number than ever before, at this early date; material almost sufficient to make a programme for the session of unusual interest. There will be two discussions of importance in electro-therapeutics, interesting reports of all standing committees, several scientific lectures on the first evening, with demonstrations and stereoscopic views (including the Roentgen X

Rays, and electric principles in the treatment of diseases), given by well known scientists.

The Committee of Arrangements has surprises in store for the social element in the way of receptions and excursions.

The exhibition promises to be a good feature and of more than usual interest.

Pasteur's Nonsense.—Such is the title of a short article published in the *Medical Age*, August 10th. The author, Dr. J. J. Lawrence, thinks that Pasteur was the most colossal humbug of this age. He (Pasteur) fathered a theory which switched the medical profession off the broad avenue of therapeutic, along which it was making such gratifying progress, on the blind siding of bacteriology. The doctor says that: "Pasteur was not a great man, nor even a learned man, but he was gifted with great shrewdness and that he obtained all his success by being backed up by governmental endorsement." Dr. J. J. Lawrence cannot find any good in Pasteur's works.

Well, we shall advise him to take up the study of bacteriology and to follow the way opened by Pasteur and in which so many men have acquired world-wide reputation.

Also, we would like to tell him that the words of the poet are of very little use to the student of technical science.

The Laryngoscope.—We have just received No. 1, vol. 1, of the *Laryngoscope*, a journal devoted entirely to the consideration of diseases of the nose, throat and ear. It is a monthly and it is published in St. Louis, Mo.—*Scientific American*.

The 50th anniversary number of the *Scientific American*, just out, is a handsome and valuable publication of 72 pp. It reviews the progress of the past 50 years in the various sciences and industrial arts; and the various articles by the best scientific writers of the day are racily reviewed and richly illustrated. The editors have accomplished the difficult task of presenting a compendium of information that shall be at once historical, technical and popular. The story of the half century's

growth is in itself a veritable compendium of valuable scientific information for future reference. Price 10 cents per copy.

International Bacteriologic "Concours."—As a memorial to Pasteur, the Circulo Medico Argentino of Buenos Aires, offers prizes of \$400 and \$200 for the best original and unpublished bacteriologic investigations or studies reported to the President, Senor Gregorio Aroz Alfaro, before May 31, 1897. The reports to be in Spanish or French. For further particulars see the *Cronico Medica* of Lima, April 15.

MICROSCOPICAL MANIPULATION.

Rapid Method for Microscopical Preparations.—Thelwall Thomas tells (*Lancet*) of the rapid preparation of specimens for the microscope by the use of formaldehyde in 4 per cent solutions, which harden in a few hours any piece of tumor or tissue placed in them. This solution freezes on an ether-microtome, and the sections, after immersion in methylated spirit, can be readily stained with hematoxylin. During the past twelve months he has cut sections (over one hundred) of every tumor or tissue the day after its removal by the surgeon.

Note on the Permanent Staining of Ringworm Fungus.—H. G. Adamson (*Brit. Jour. Dermat.*), for the staining of the ringworm fungus, combines the caustic potash solution with the ordinary staining method. Dr. Adamson claims that the keratin nature of the horny tissues is lost by the use of the caustic potash, and that decolorization takes place as in non-horny epithelial tissues (*Am. Med.-Surg. Bull.*) The details are as follows: 1. 5-per cent.-10-per cent. solution of caustic potash on the slide for ten to thirty minutes. 2. Wash 15 per cent. alcohol in water. 3. Dry the slide, and, in the case of scales, fix by passing through the flame. 5. Stain in gentian-anilin-violet (made in the usual way by the addition of a few drops of saturated alcoholic solution of gentian-violet to anilin-water),

fifteen to sixty minutes. 5. In Gram's iodine solution one to five minutes. 6. Decolorize in anilin-oil two or three hours or longer. 7. Remove anilin-oil by blotting-paper, mount in Canada balsam.—*St. Louis Med. and Surgical Jour.*

A New Method for Estimating Filicic Acid. Dr. Kraft has devised the following method of determining the quantity of filicic acid present in extract of male fern: Five gm. of the extract are shaken with a solution of 2 gm. of potassium carbonate and 40 gm. of water and 60 gm. of 95 per cent. alcohol for one-quarter of an hour. Eighty-three gm. of the mixture are filtered off immediately into a separatory funnel, and to this 9 gm. of diluted hydrochloric acid, 50 gm. of ether and 35 gm. of water are added and the whole shaken. The aqueo-alcoholic layer is drawn off, the ethereal solution is again washed with 35 gm. of water, the water evaporated and the ethereal solution distilled off in a tarred 100 ccm. Erlenmeyer flask, and finally evaporated down to at least 2 gm. by means of a hand bellows. The residue is dissolved in 1.5 gm. of hot anyl alcohol, 5 gm. of methyl alcohol added and the whole then slowly precipitated by the gradual addition of 25 gm. of methyl alcohol. The whole is then kept over night in a closed receptacle in a cellar, filtered through a tarred filter, the precipitate washed with 10 ccm. of methyl alcohol at 60 to 70 per cent. until the residue shows no loss on heating. The filicic acid thus obtained amounts to about 4 per cent. of the extract.—*American Druggist.*

BACTERIOLOGY.

Typhoid Bacilli in Pus.—Sudeck. (Munchener Med. Wochenschrift, No. 21, May 26, 1896.) In an ovarian cyst containing thick pus and occurring in a woman who had had typhoid fever seven weeks previously, Sudeck was able to demonstrate the typhoid bacillus both in stained specimen and through culture. In the pyogenic membrane, however, diplococci were found and therefore the author rightly infers that the typhoid bacilli may stand in no etiologic relation to the abscess, but are there concomi-

tantly without action. The pyogenic properties of the typhoid bacillus are not established by finding the germ in pus.

Do Flies Spread Tuberculosis?—Dr. W. R. Aylett, (Virginia Med. Semi-monthly, June 26, 1896) gives details of investigation: "I smeared a cover-glass with sputum from a well advanced case of tuberculosis and placed it upon clean sheet of paper, placing around it seven or eight clean covers. The paper and covers were then placed where flies could have ready access and soon quite a number were feeding on the sputum. An inverted tumbler was lowered over them, making them prisoners without their knowledge. One of the prisoners soon deposited a 'speck' on one of the clean covers. To prevent this becoming contaminated by their feet, I removed it at once. Within an hour or two all of my covers were specked. The covers were then put through the regular cover-slip preparation, carbo-fuchsin being used for the bacilli, with methylene blue as a contrast stain. On microscopic examination, the specks were found to contain from one to three thousand bacilli tuberculosis each. I have not yet tested the virulence of bacilli so obtained, but they show no signs of disintegration, seem as perfect and stain as readily as those from pure cultures."

MEDICAL MICROSCOPY.

Non-excretion of Pathogenic microbes with the Perspiration.—Krikliwy describes in *Wratsch*, Nos. 8 to 10, his experience with cats inoculated with anthrax bacilli and then injected with pilocarpin. Microscopic examination of the profuse sweat induced was entirely negative in any discovery of the bacilli, although they were found in the blood and tissues.

Antidiphtheritic Serum Administered by Rectal Injection.—Dr. Chantemesse, of the Pasteur Institute of Paris, has advised the exhibition of diphtherical antitoxin by rectal injection instead of subcutaneously. He has used

this method in twenty cases, and believes that the fluid is easily and quickly absorbed. The bowel is first washed out by a simple enema, and then by means of an ordinary enema syringe and a gum-elastic catheter of medium size and about twenty centimeters long, the serum is introduced into the rectum. The method causes neither pain nor any unpleasant effects. The curative effect seems to be as certain as when the antitoxin is given by hypodermic injection. There is no need, so far as Dr. Chantemesse's experience goes, for any increase of dose when the serum is administered by the rectum. In severe cases of erysipelas he has injected into the rectum 200 to 300 cubic centimeters of the Marmorek serum. This quantity was readily absorbed and caused no ill effects. In applying this serum locally he adds five parts of lanolin to one part of the serum; pain, swelling and redness are thereby greatly reduced.—
Ex.

Suppurative Nephritis.—V. Wunschheim (*Ztschr. für Heilk.*, bd. xv, pp. 287-401), from a study of cases of suppurative nephritis, concludes as follows:

1. Suppurative pyelonephritis is caused in the great majority of cases by the bacillus coli communis, and in a minority of cases by the proteus vulgaris or by the common pyogenic cocci.
2. In cases caused by the common pyogenic cocci, pyemia almost invariably supervenes.
3. The pyelonephritis caused by the staphylococci and streptococci differs not only in the subsequent pyemia, but also in a greater destruction of tissue and an absence of local proliferation.
4. It is not probable that typical ascending pyelonephritis can also become descending.

MICROSCOPICAL SOCIETIES.

American Postal Microscopical Club.

During the season now closing, the circuits have received about the usual number of boxes, including those now in transit; and, notwithstanding the great and partly unavoidable difficulties of the case, this service at-

tained, owing to the considerate and often generous exertions of members, and to the efficient supervision and assistance of the secretary, Dr. Shanks, at least an average success. After the boxes have completed their present circuits, there will be the usual rest until fall.

Owing to the amount of time demanded by other and more urgent details of club administration, the publication of the report has been necessarily deferred until after vacation.

San Diego Microscopical Society.

At one of the last meetings of that society, held at the residence of Dr. B. F. Gamber, a permanent organization was effected, and the following officers elected to serve for the ensuing year; President, Dr. B. F. Gamber; vice-president, D. Cleveland; recording secretary, Will H. Holcomb; corresponding secretary, Dr. Joseph Rodes; treasurer, Philip Morse.

A specimen of a beautiful species of alga, found in the fresh waters of the San Diego Flume was made the subject of investigation and study by the society. A finely prepared and mounted specimen of cyclops, a minute fresh water copepod of the genus cyclopidae, taken from the Flume water, was exhibited by Dr. Gamber. This curious form of life, as observed through the splendid instrument at the rooms of the society, does not fail to command the attention of all present at the meetings of the society. Its kite-shaped body and tail, cumbersome antennae, and one eye, makes it as formidable an object in microscopical life as were the one-eyed giants to the races of men described in the Homeric legend. A cyclops is said to produce four and one half billion offspring annually.

Micrometallography, as its name implies, deals with the microscopic examination of sections of metals. It promises to be of great practical use to the metal worker, for by its means those mysterious fractures in steel, with which every engineer is familiar, are explained. Under the microscope the steel used by engineers can be thoroughly and carefully examined, and the steel "cells" tested. Flaws in the interior of metals can be detected by the microscope, and thus many accidents can be prevented.

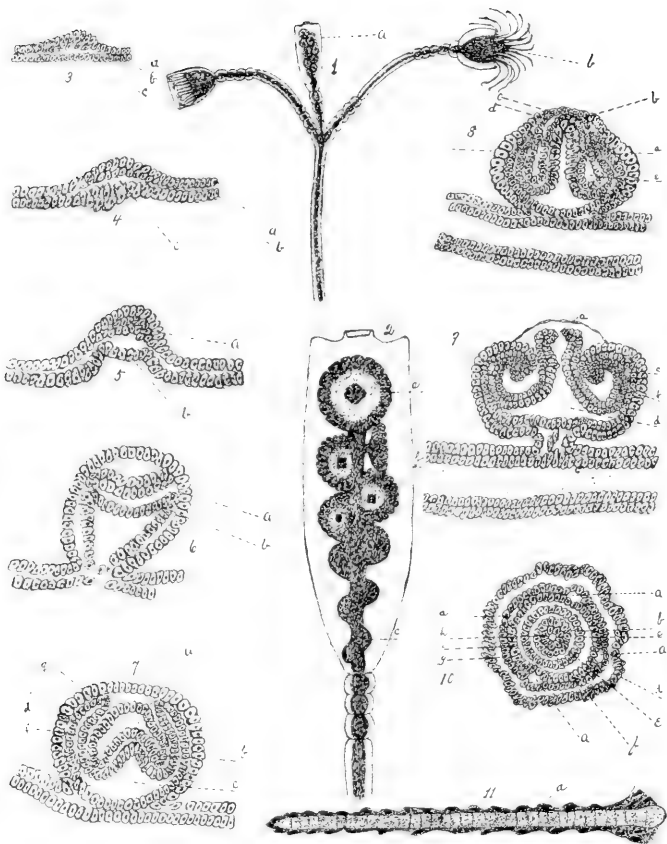

DEVELOPMENT OF A FREE SWIMMING MEDUSA.

THE AMERICAN

MONTHLY

MICROSCOPICAL JOURNAL.

VOL. XVIII.

SEPTEMBER, 1896.

No. 9

The Development of the Free-Swimming Medusæ of *Obelia* *Commissuralis*.

By GEORGE W. NORTON,

MIDDLETOWN, CONN.

The development of the bell-shaped medusæ has been quite completely worked out, while that of the saucer-shaped medusæ, such as is found among the Campanularian hydroids, has been studied but comparatively little. The development, however, of the Campanularian jelly fish, forms a no less interesting and instructive line of study than that of their bell-shaped relatives, and especially is this true if we make a comparative study of the development of the two and note wherein they agree and differ in their mode of development.

EXPLANATION OF THE PLATES

Fig. 1. A branch of a hydromedusarium. (a) the reproductive calycele.

Fig. 2. The reproductive calycele highly magnified. (a) the medusa. (b) the calycele. (c) a young bud.

Fig. 3. A section through a medusa bed in an early stage. (a) the ectoderm. (b) the endoderm. (c) thickening of the ectoderm.

Fig. 4. A section through a bud more advanced. (a, b, c) the same as in fig. 3.

Fig. 5. A later stage of the bud shown in fig. 4. (a) the cells forming from the ectoderm. (b) the same as in fig. 3.

Fig. 6. A later stage of the bud shown in fig. 5. (a) ectodermal cells arranged in two layers. (b) the same as in fig. 3.

Fig. 7. A more advanced stage of the bud shown in fig. 6. (a) the sub-umbrella cavity. (b) the proboscis. (c) the stomach. (d, e) the endoderm.

Fig. 8. A further development of the same bud. (b) the proboscis. (c, d) the ectoder-

mal layers which break through and form the opening to the sub-umbrella cavity. (e) the sub-umbrella cavity.

Fig. 9. The medusa ready to break loose from the manubrium of the calycele. (a) the mouth. (b) the tentacle. (c) the circular canal. (d) the stomach.

Fig. 10. A cross section of the bud in fig. 8 as indicated by a. (a) the radial canals. (b, c, d) ectodermal layers. (e) the mouth or œsophagus. (f) the sub-umbrella cavity. (g, h, i) the endodermal layers.

Fig. 11. A fresh tentacle highly magnified (a) the thread cells.

Fig. 12. A medusa at time of birth. The tentacles are here represented to be much shorter than they should be to be in proportion with the rest of the body. (a) a tentacle. (b) a radial canal. (c) the circular canal. (d) the mouth. (e) the proboscis. (f) an octocyst. (g) the sub-umbrella cavity.

The object of this paper is simply to show the development of one of the free-swimming Campanularian medusæ—that of *Obelia commissuralis*, while no attempt is made to describe the sexual method by which the medusæ give rise to the hydroidal forms.

This particular specie is found growing along the rocky shores of the Atlantic Ocean, from Nova Scotia to Charlestown, South Carolina, attached to stones or sea-weeds of various sorts. The material for this work was found growing on the ropes attached to lobster pots which were set near the Biological Laboratory, Cold Spring Harbor, Long Island. On these ropes the hydroids were found growing luxuriantly, even to a considerable depth below the surface of the water. The material having been collected, four different fixing solutions were made use of in preserving it, Corrosive Sublimate, Perenyé's Fluid, Fleming's Solution, and Picro-sulphuric Acid. The latter proved the most satisfactory, preserving the tissues so as to show the cellular structure very distinctly. The material having been treated with these various fixing solutions, was than preserved in alcohol, and later the development was made out by staining and cutting sections according to the usual method.

The reproductive organ of *Obelia* consists of a reproductive calycle (fig. 1, a) which occupies the forks of branches and is composed of a horny sheath (fig. 2, b) which surrounds a central portion, the manubrium. The manubrium, in accordance with the general structure of the Coelenterates, is composed of two cellular layers, the ectoderm and the endoderm and on this manubrium the medusæ are developed by a process of budding. The first step to be noticed in the development is a slight thickening of the ectodermal layer of cells (fig. 3, c) on one side of the manubrium of the calycle. Soon, however, both ectoderm and endoderm push out from the axis of the man-

ubrium at the place of ectodermal thickening and form a bud (fig. 5) while at the same time the ectodermal thickening is still further increased by the formation of new cells (a)—these cells being formed from the ectoderm alone. The bud continues its growth till it becomes decidedly pear shaped (fig. 6) and the mass of ectodermal cells has become arranged in two layers (a) which have almost entirely separated from the ectoderm. The endoderm has also

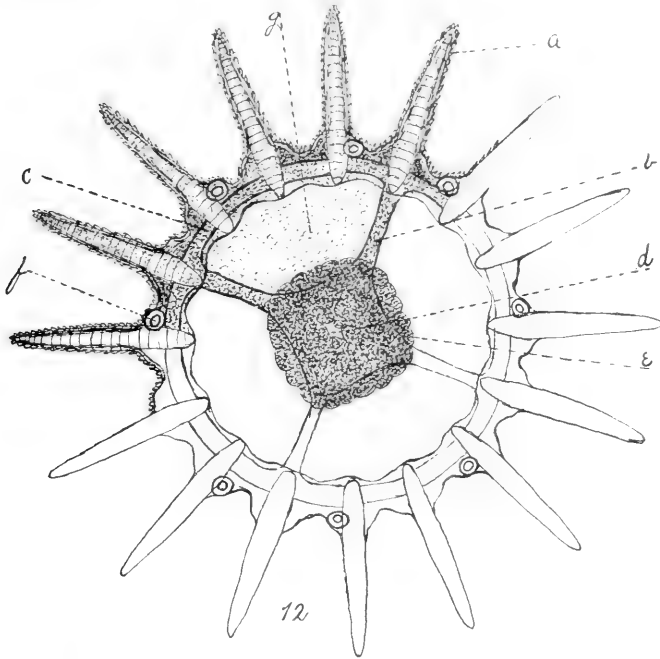

grown out into the bud, forming a sort of cup. At the next step (fig. 7), we find several marked changes. The shape of the bud has changed from its pear-shape to nearly spherical. The two cell layers of ectodermal origin have become separated, forming a cavity (a) which subsequently becomes what corresponds to the bell-shaped cavity in the bell-shaped medusæ of the Tubularian

hydroid. The endoderm (d, e) has now grown out around the edge of the bud, forming a deep cup, and has also made an evagination (b) which is the beginning of the proboscis. The two endodermal layers (d, e) forming the cup, remain, for a time, entirely separate. Subsequently these two layers grow together with the exception, first, of the large four-cornered cavity (c) which becomes the stomach, secondly, of the four radial canals (fig. 10, a), and thirdly the circular canal (fig. 9, c) which is connected with the stomach by the radial canals. The bud now changes from a nearly spherical shape to a broadly discoid form (fig. 8) and here seems to be the beginning of an important step, which is the gradual broadening of the developing bud to form the Campanularian medusa, instead of retaining its spherical form and developing into the Tubularian medusa. The proboscis (b) has now become much more prominent; while at the same time, the two ectodermal layers (c, d) have become thinner over the proboscis and subsequently break through, forming the opening to what corresponds to the bell-cavity of the Tubularian Medusa, or the sub-umbrella cavity. We now have the sub-umbrella cavity lined with a layer of cells of ectodermal origin. This layer unites with the ectoderm of the outside of the bud, thereby forming the edge of the disk which surrounds the sub-umbrella cavity. We thus have one continuous layer of ectodermal cells covering the outside of the bud and lining the sub-umbrella cavity. The tentacles make their appearance as buds (fig. 9, b) on the edge of the disk. These buds are outgrowths of both ectoderm and endoderm, so that the tentacles contain both the ectodermal and endodermal cell layers. As the tentacles grow they curl inwardly upon themselves, so that, until the time of birth, they appear as broad crenulations (fig. 2, a). The mouth also makes its appearance by virtue of a separation of the cells (a) at the end of the proboscis.

The bud is now ready to begin its free existence as a medusa; and by a few vigorous contractions, breaks its connection with the manubrium and passes out at the end of the calycle. In the very act of extrusion, its disk expands and the tentacles unroll, so that, by the time the medusa is free from the calycle, it is fully expanded and begins at once the act of swimming. At birth the medusa, has sixteen tentacles (fig. 12, a) of which one is opposite each of the four radial canals and three others are arranged at equal distances in each space between any two of these four. There is the sub-umbrella cavity (g) in the centre of which is the proboscis (e) and in the centre of this we find the mouth (d) which opens into the stomach—a four-sided digestive cavity, from each corner of which a radial canal (b) extends outward. These canals extend nearly to the edge of the disk, where they connect with the circular canal (c) which passes through the entire circuit of the margin. Through these canals a constant circulation of water is kept up by means of large vibratile cilia. There are also eight otocysts (f) at the bases of the eight tentacles which stand one on each side of the four radial canals. They are circular in outline and contain in their centre a highly refractive body. As to the development of these I was able to make out practically nothing.

The development of the Campanularian medusa resembles in many respects that of the Tubularian medusa. This is evident from a comparison of these figures with those by Korschelt and Heider in their Text Book of Embryology, fig. 16. The sub-umbrella cavity of the one is formed in almost identically the same way as the bell-cavity of the other. The same is also true of the radial canals, the circular canal, the proboscis, and the stomach. The important difference in the development of the two is the gradual change in the form of the

Campanularian bud from nearly spherical to a broadly discoid form, which results in the flat, saucer-shaped Campanularian medusa, instead of the bell-shaped Tubularian medusa.

CYSTIN.

By E. CUTTER, M. D.,

NEW YORK.

Cystin is not so rare as thought. It is of clinical importance. A variety of rheumatism is called "cystinic" because cystin predominates in the blood, and rheumatism is a "gravel of blood" (Salisbury).

Cystin is also found in urine and sputum. It is $C_6H_{12}N_2S_2O_4$, and is to be regarded as a sulphur carbohydrate with N. It is probably a normal body if kept in solution in the blood by plenty of water being supplied to the system. It is to be eliminated in the urine, feces, sweat, and expeoration in solution. When, from absence of sufficient water or other reasons, it is concentrated and crystalized into flat hexagons with a thickness of about one-eighth of its diameter, sometimes with slightly irregular or anfractuons outlines, sometimes with a hilus, sometimes with section cut out as a piece of pie is cut. Color, white. Sometimes found alone, but oftener associated with other blood, urinal, sweat, or sputal crystals, with hyaline, blue, bronze, emerald-green, ruby-red, pigmental matters, which are to be expected when enough water is not drank or when waters loaded with salts are imbibed. But cases where cystin is found oftenest are those in which sulphur has largely entered as food, i. e., yolks of eggs. Or, to put it the other way, when patients have eaten the yolks of eggs they present cystin in their blood or urine.

Recently I found cystin in the blood of a tuberculous lady to whom yolks had been forbidden. Asked if she

had not eaten yolks in the whites of eggs ordered, she said "yes." The same day a lady treated for the pres-
tages of fatty degeneration showed cystin in her blood. She confessed to eating yolks.

Lately also my son, Dr. J. A. Cutter, had a case of cystinic rheumatism traced to eating yolks of eggs largely, against orders to the contrary. But yolks of eggs must not be judged to have a monopoly of cystinic formations. Some years ago a middle-aged man applied for relief from sciatica. His blood showed cystin as seen in Fig. 1. I forgot about the urine. But yolks were not food fac-

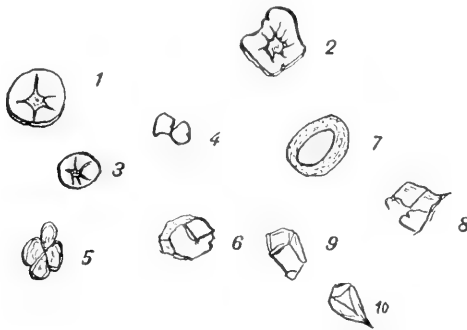

tors. He was put on hot water and plenty of lemon juice. The next day the cystin was gone from his blood and the sciatica with it. The physical characters of cystin reasonably explain the pains, swelling and tenderness of the parts affected.

PRINCIPLES OF FORMATION.

From the above they may be inferred as

1. Lack of menstruum in food.
2. Sulphur in excess in food.
3. Lack of elimination.
4. Retention.

TREATMENT.

1. Supply menstruum in abundance. Distilled water

is the best, as it has no saline bodies to directly diminish its solvest powers.

2. Lemon juice.

3. Remove sulphur foods as far as possible. This is stopping causes and shows the close relation of dietetics to the practice of medicine as curative or detective.

4. Elimination, as indicated, is secured by the plentiful use of hot water, one pint one hour before meals and on going to bed, by hot, dry or vapor baths and by keeping the cystin in solution so that it will exosmose into the "primae viae" for expulsion. Solid bodies must generally be liquefied before elimination. If we can judge from experience, lemon juice is the best solvent of cystin. Saline eliminants are not desirable, because there are too many salts in crystal already, and saline eliminants only add to the load already too burdensome to be borne.

On the Application of a Recently Isolated Abrasive Substance to the Study of Hard Mineral Substances and Metals.

BY K. M. CUNNINGHAM,

MOBILE, ALA.

As an introduction to the subject matter of the above title, it may be appropriate to refer to the fascinative power associated with the hope of an artificial synthesis, or production of the diamond in the modern laboratory, as contradistinguished from its past production in nature's laboratory. And among all who have been allured by the alchemy of this hope, many have eagerly sought its solution, by operating on the various forms of natural or artificial carbonaceous matter; but apparently in vain. But if electrolytic chemistry has thus far failed to produce pure crystallized carbon, it has nevertheless, in the fruitless search, given to science and the arts, many useful substances; more and more approaching to the char-

acters of the coveted diamond; and even at the present time we are apprised that M. Henri Moissan of Paris, has produced by the electrolytic union of boracic acid and carbon, a mineral substance, which proves to be the hardest known substance in nature, as it readily wears away the diamond heretofore known as at the head of the list of minerals in hardness, and that the new mineral substance may be produced in commercial quantities; but as it is likely to remain for a considerable period or lapse of time a mineral curiosity, not readily accessible to the working world, we can at least congratulate M. Moissan on his success in its production as a mineralogical novelty. Previous to the announcement of M. Moissan's various electrolytical furnace products, a new abrasive substance had already been heralded, far and wide, as the discovery of an American citizen. This substance became known under the trade name of carborundum, and was promptly introduced among the trades heretofore using emery and corundum as being in some cases superior in its cutting or abrading qualities. This material proved to be a result of an electrolytical union of Silex, Alumina and Carbon; and presenting itself in the shape of very small crystals of a distinct crystallographic system, of bluish and greenish hues. The discoverer of this new substance protected his process by a patent, and thus put it on a commercial basis. After the new substance had been announced as a candidate for public favor, I became very much interested in it, and finally became aware of its character and properties, as adapted to dental tools, and of its remarkable efficiency in cutting away the enamel of teeth. For several years previous to the announcement of the production of Carborundum, I had at intervals studied the products resulting from the electric combustion of carbon rods, in the hope of detecting some interesting microscopic char-

acters, if any such there might have been; but most of these studies were ineffectual until, about the month of July of the past year, I took the matter up again and finally succeeded in solving the mystery that had evaded my previous attempts. The cue by which I unlocked the secret, came about in this wise. It occurred to me to trim down on a glass slip the burned end of a carbon point, and over this dust rapidly stroking the back edge of a pocket knife blade, during the experiment I noted a peculiar frictional effect arise in driving the blade through the carbon powder, and on submitting the slide thus traversed by the strokes to the microscope I saw that many fine lines were traced in the body of the glass as if cut with a diamond splinter. Further expanding this idea, I also remembered that a black carbon dust was periodically brushed out of the globes by the lamp trimmers on their daily rounds, so I thought that I would also examine this dust material under the microscope. With this in view I engaged a lamp trimmer to secure for me a sample of the carbon dust, brushed away daily as of no value, in return for which service a small gratuity was given. I thus secured several pounds of the dust, and was thus enabled to study it from numerous points of view. I found the material to be made up of minute coke debris, and myriads of minute glassy spherules, black, opaque limpidly transparent.

I found that the glass-like spherules if rolled between glass slips under good pressure, were seen to be plowed up as if by a snow plow, a ridge of snowy white glass powder being left in the wake of the rolling spherule under pressure. I then conceived the idea of testing the powder's abrading action on hard flint-like minerals. For this purpose I made use of a small fragment of an emery wheel heretofore used when preparing surfaces on the fossiliferous limestone or soft rock material.

I poured a quantity of the carbon dust on the emery plate and added some water and selected a piece of granite to test its cutting qualities, finding that the granite was quickly abraded.

I next tested it with a specimen of flint, and found that the results were as remarkable as with the granite. I next ascertained that the same dust would also give a finished mirrored polish to the flint and granite specimens. After having ascertained the feasibility of the material, I immediately secured specimens of all of the various kinds of hard minerals, such as are brought into any maritime port, as ballast from other distant ports, and testing them rapidly in succession, I found that all known accessible rock specimens were tractable to this treatment, and as a result of these experimental tests and trials I was enabled to study several varieties of the granitic rocks, serpentine, copper, iron and nickel slags; glass, flints, agates, basalt, porphyry, carborundum wheels; trachytes, cherts, the silicified fossiliferous pebbles, and silicified woods peculiar to the sub-carboniferous formations of Alabama; the hematite ores, silicified vertebral bones, phosphatic flints of Florida; the various metals as iron and steel, etc., so that I then realized that this simple analytical method might be practically applied to the study of all minerals and metals with the possible exception of the diamond itself. During a part of these initial experiences I used as a grinding or polishing support one of the squared, tempered steel plates used in the chalk engraving process, and found that the polishing power of the material had turned the steel plates into a perfectly reflecting face mirror. In the internal structure of flints as polished by the means noted herein, one may note the large variety of organic remains, as foraminifera, radiolarian like forms, sponge spicules, reticulated spongy structures, Zanthidian and other bodies.

In the calcedonized flints, there can be observed the peculiar lobulated concretionary strial or parallel wavy bands and capsular bodies. In the flint-like phosphatized pebbles of the Florida phosphate area, we can discern an aggregation of foraminiferal remains, ranging in size to the most minute and in the Jasperized gravels of North Alabama, the polished surfaces permit the sponge spicules and radiolarian like spherules to be readily seen. In the opalized radiolarian clays of Mississippi and Alabama, we can also find the evidence of radiolarians, foraminifera and sponge spicules. Polished faces on the silicio-calcareous cement stones of Sendai, Japan; and of Jutland enables various phases of diatom structure to be seen therein.

In my earlier efforts to obtain some knowledge of rock structure with the aid of the microscope I confined my efforts to the strata of fossiliferous origin, such as the chalks, and crystalline limestones; oolitic strata, and other easily reduced rocks, and during the pursuit of this research, I made unlimited studies from every available source, overlooking the harder series of rocks of igneous and metamorphosed origin, chiefly on account of the apparent difficulties to be overcome in their preparation, as for example, the necessity of having diamond treated saws to slit the harder rocks into thinnish plates, and the labor of reducing the slips to the requisite thinness, and giving the required polish to both faces, and for these reasons I gave very little experimental attention to the subject, but contented myself with securing and examining the commercial preparations, the product of the lapidary's art; so that nearly every variety of mineral of a fossiliferous nature that came into my possession was subjected to study whenever the simpler expedients were applicable, and matters were allowed to stand at this stage until I worked out the properties of the spherule

dust of silicic carbide, as produced by the electrical destruction of artificially prepared carbon rods, and when by its application, I became enabled to dominate every hard substance in nature, with the exception of the diamond itself, I deemed my experiences as of such a novel character and of sufficient general interest to communicate them, for the benefit of all who are interested in the microscopic study of Mineralogy.

During a collateral study of a pseudo-meteoric iron. I was enabled to make some interesting studies of both black and white diamond, by fracturing, and by polarization, and otherwise, the results of which study present much of microscopic interest, not hitherto published in our Journals devoted to microscopic science; and in connection with the subject of rock study, I might relate that while in Amsterdam, Holland, in the summer of 1887, I paid a florin for a half carat of diamond dust, while visiting the largest diamond cutting house in that city. The proprietor also brought me a 62 carat diamond just finished by them and laughingly remarked that he would sell it to Mr. Gould of the U. S., when I pleasantly retorted, that we called him "Jay Gould." I carried the sample of diamond dust in my pocket book for five years expecting to be able to use it at some future time and finally, when I became actively engaged in the study of the structure of the real diamond, the long preserved diamond dust could not be found, but with "Silicon Carbide" available everywhere, diamond dust will not possess the same interest as it formerly did for abrading or cutting purposes.

In conclusion, the requisites for the analytical adaptation of the facts already enlarged upon herein, are relatively few and inexpensive, as a fragment of a common half inch thick emery wheel, having a surface allowing an oval sweep of five or six inches, a few pieces of com-

mon ground glass, some of the "Carbon dust" to be secured direct from any trimmers of globe arc lights in any town where the arc system is used. The minerals to be studied are surfaced down on the emery slab, with the aid of water and the "Carbon dust," the coarse scratches to be removed by gentle rubbing on the same slab, and the polish to be given by transferring a little of the pasty liquid from the emery slab, to the ground surface of the piece of glass; the specimen must then be rubbed with a circular or straight motion until the polish comes up on the specimen, which takes but a few moments to do.

Another way to give the finishing polish, is to proceed as follows: secure a piece of window glass eight inches by ten and pour a considerable quantity of the carbon dust on the glass. Spread the same all over the glass; next let all of the powder slide off of the glass, and tap the glass to detach all that will fall off, it will then be observed that there remains an exceedingly fine layer of the dust on the glass, which dust must be brushed together by a small roll of cloth; this dust when deposited on a piece of ground glass or a thin piece of smooth sheet iron, is moistened with a drop of water and the mineral to receive the polish is rubbed with circular or straight motions until a sufficient polish is attained.

A point is usually reached in polishing where a sort of suction contact is noted, and the moisture disappears, when the polishing force is acting best. Should the polishing film become dry while polishing, breathe once or twice on the dry film and the polishing force is revived, as a very little moisture seems to be necessary all the time. Any person who will make the simplest effort to follow the above instructions will have success after an hour's trial and will then have a key to an indefinite amount of intellectual and scientific pleasure awaiting him in the field of Micro-Mineralogy.

From five to ten minutes' labor will suffice to prepare almost any specimen of mineral or metal for inspection under any microscope that will admit of a beam of condensed direct light being used between the lens and the polished surface, where the specimens are too thick for permitting the use of transmitted light.

A New Species of Tenia.

Dr. H. B. Ward, University of Nebraska, reports a new species of human tape-worm (*Western Medical Review*) to which he gives the name *Tenia confusa*. His description of the parasite is as follows: Thus far only two specimens of this species have been seen, and both were taken from residents of Lincoln. One of them has been almost entirely destroyed in making slides and sections, but the other is still nearly entire, and from it were taken the general measurements which are given in the following: The total length of this specimen must have been about 500 cm. The terminal proglottids, just ready to be separated, are from 5 to 3.5 mm. in width. They are, as represented in Fig. 1, of nearly uniform breadth throughout their entire length, save that close to the end a prominent widening is found, to which the subsequent proglottid is attached. The sexual pores is easily seen, though it does not project markedly beyond the margin of the segment. One meter anterior to the end of the specimen the proglottids measure 15 mm. long and 7.5 mm. wide, and a meter further anterior they are just about 9 mm. square. In the anterior third of the worm the segments are 4.5 mm. long by 3.5 mm. wide, and near the anterior end 1 to 1.2 mm. long by 0.8 to 1 mm. wide. In general then, it may be said to be much slenderer than *Taenia saginata*, never attaining the broad form which is so striking near the middle of the chain in specimens of this latter species. Cross sections show that the new form is

much less muscular, and in fact more like *Taenia solium*, from which it differs, however, in many evident respects. A positive diagnosis of the species may be made from these terminal segments alone, by the size and shape, which, as the table appended to the article shows, are sufficiently unlike corresponding parts in the two familiar forms of *Taenia* to be distinguished without great difficulty.

The most striking peculiarity of the new species, however, is the head. Unfortunately, this was present only in one specimen. The long, very slender neck has no region which fails to show the boundary lines of the pro-



FIG. 1.—Two segments from end of chain. *Taenia confusa* n. p. Nine-tenths natural size (Original.)

FIG. 2.—Head of *Taenia confusa* n. sp. Highly magnified, \times about 125. Drawn with Abbe camera. Leitz Oc. 2, Obj. 5. (Original.)

glottids. It is crowned by a small head (Fig. 2), which measures only 0.3 mm. in diameter. The four suckers are distinct, but not prominent, and produce no apparent break in the outline of the head. Most striking, however even under a low power, is the rostellum, which lies drawn into a pit at the anterior apex of the head. It is thimble-shaped and measures 0.05 mm. wide by 0.07 mm.

long; it is covered by six or seven rows of minute hooks which decrease in size from the apex of the structure toward the base. Owing to the thickness of the muscular mass about the hooks and to their diminutive size, it was not possible in the single specimen to determine exactly their size and shape. One recognizes, however, without difficulty, the clear, highly refractive appearance characteristic of such chitinous structures. The diminutive size of the head led me at first to suspect that it was altogether lacking in this specimen. It is probable that the rostellum, with its mass of hooks, gives a firm hold on the intestinal wall of the host, and the parasite may be evacuated only with great difficulty. Accurate diagnosis and records of methods employed in removing the worm are necessary to determine the effect of the ordinary remedies on this new species. It is by no means certain that it will yield to the same treatment as the well known species.

A table of measurements for the three species of *Taenia* which are found as adults in the human alimentary canal, is appended for convenience in diagnosis. The measurements for the familiar species are taken from Leuckart. The specific name *confusa* is proposed for this new form:

	T. con- fusa.	T. sagi- nata.	T. so- lium.
Length of entire specimen.....	5 m.	4-8 m.	2-3 m.
	mm.	mm.	mm.
Length of terminal proglottids.....	27-35	18-20	10-12
Width of terminal proglottids.....	5-3.5		
Greatest width of chain	8-9	12-13	7-8
Diameter of head	0.3	1.5-2	1
Diameter of suckers.....	0.12-0.15		

Typhoid Germs in Ice.—The military officers at Rennes (Medical Press and Circular) have recently suffered from a typhoid epidemic, which has been traced to the ice which was used to cool the champagne at a banquet. The ice had been taken from a neighboring river at a point where the town sewers empty.

The Insolubility of Cocaine in Vaseline and Lard.

By C. EDWARD SAGE, F. C. S.

Being requested to make a 5 per cent. solution of cocaine in adepsine oil recently, it was found that the alkaloid was scarcely soluble in that liquid except at the temperature of a water bath, and even then it took some time to dissolve, and on cooling the alkaloid crystallised out again.

The 'Extra Pharmacopœia' states that cocaine is soluble 1 in 20 of vaseline, and I have many times prepared such an ointment, but the fact that the alkaloid crystallised out from adepsine oil when dissolved in it in the same proportion suggested the microscopical examination of some "vaseline-cocaine" 1 in 20, with the result that it was found to consist of a mass of minute crystals interspersed with vaseline.

The accompanying drawing shows the appearance of a thin layer when examined by means of a $\frac{1}{4}$ in. objective.

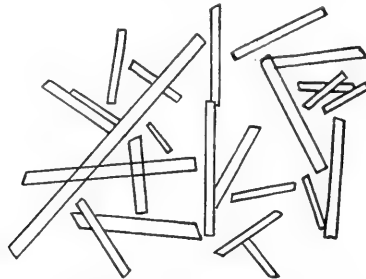

Crystals from "Vaseline-Cocaine," 1 in 20. ($\frac{1}{4}$ inch objective.)

The vaseline used for preparing the ointment showed no crystals when examined in the same manner, and a chemical examination of the cocaine used showed it to be pure.

An ointment was made of the same strength with lard, and directly it was set it was examined microscopically, and showed no signs of any crystals of cocaine, but after

standing two hours the alkaloid began to crystallise out in well defined crystals.

A solution in olive oil and one in castor oil was also made, and these were found to be perfectly stable.

From these results it seems that neither vaseline or lard is a suitable solvent for the preparation of an ointment of cocaine, and that the idea that such a preparation was better than one containing the hydrochlorate dissolved in a little water and rubbed up with the fat is fallacious.—*Pharmaceutical Journal*.

EDITORIAL.

Correspondence with Editors.—Many people wonder why editors do not always answer promptly every communication sent them. Hardly any one but an editor can understand why. It is this. An editor's mail consists of literally thousands of items, all of which are suggestive and he would like to respond in almost every instance. The only reason he does not is the physical impossibility to do so. Many an editor burns midnight oil without even then catching up. The piles grow bigger as days go by and something gets buried deeper and deeper. If he does not know without inquiry what to answer, that constitutes an added cause of "neglect." Few periodicals can afford the necessary clerical help for doing up every day's mail as soon as received.

There are some things which correspondents could do to make replies surer. A self-addressed postal card, with the question written on it is very likely to get returned at once. Enclosing a self-addressed envelope works well if what is to be returned in it is printed matter, but if a letter must be written, that is not so sure because the thing to say may be uncertain, when letter and envelope will go aside to wait future opportunity to look it up.

Don't be sensitive about the business or lack of conciliatory phrases in an editor's reply. Don't suspect him of

concealments or imagine that he feels unkindly. He simply lacks time to express to you all these things.

A Monument to Pasteur.—It has been decided to erect, in one of the principal squares in Paris, a monument to the memory of Pasteur, and that this shall be done by voluntary subscriptions obtained in all civilized nations.

The Paris committee has therefore authorized the organization of a committee for the United States in order to give the people an opportunity to assist in erecting this tribute of appreciation. This committee for the United States is as follows:

Dr. D. E. Salmon, Chairman, Chief of the Bureau of Animal Industry.

Dr. E. A. Schweinitz, Secretary, President of and representing the Chemical Society of Washington, Chief Chemist Biochemic Laboratory.

Dr. G. Brown Goode, Treasurer, Assistant Secretary of the Smithsonian Institution, Dr. George M. Sternberg, Surgeon General, U. S. Army.

Dr. J. Rufus Tryon, Surgeon General U. S. Navy.

Dr. J. Walter Wyman, Surgeon General, U. S. Marine Hospital Service.

Prof. S. F. Emmons, U. S. Geological Survey, representing the Geological Society.

Prof. Lester F. Ward, President of and representing the Anthropological Society of Washington.

Dr. William B. French, Representing the Medical Society of the District of Columbia.

Hon. Gardiner G. Hubbard, President of and representing the National Geographic Society.

Mr. C. L. Marlatt, Assistant Entmologist, U. S. Department of Agriculture, representing the Entomological Society.

Dr. Ch. Wardell Stiles, Zoologist, U. S. Bureau of Animal Industry, representing the Biological Society of Washington.

The members of this committee will be glad to receive and transmit any funds that may be raised. They supply

subscription blanks, which when filled will be forwarded to Paris for preservation.

Slide Cabinet.—The readers of the JOURNAL will be glad to know that a new slide cabinet has been put on the market by Wagenfuehr & Hillig, 506 Olive Street, St. Louis, Mo. We have just received one sample from the makers and we find it clean, light and strong and we recommend it, for it is cheap. This cabinet containing twenty trays of six slides each is sent on receipt of eighty cents, to any part of the country.

American Microscopical Society.—The nineteenth annual meeting of the American Microscopical Society was held at Pittsburg, on August 18, 19, 20, 1896, under the presidency of A. C. Mercer, of Syracuse. An address of welcome was delivered by Dr. W. J. Holland, chancellor of the Western University. Among the papers read were the following: "Comparative Histology," by Prof. Edith J. Claypole; "Courses in Histology and Methods of Conducting Them," by Prof. S. H. Gage, of Ithaca; "Photomicrography by the Use of an Ordinary Objective Practically Considered, with Specimens of Work," by Thomas J. Bray, of Warren, O. "On Astronomical Pholographs, with Photomicrographic Apparatus," showing pictures of a partial eclipse of the sun taken on an eight-inch focus, by President Mereer; "The Antivivisection Bill," by Pierre A. Fish, of Chicago; "The Acetylene Lights as Applied to Photomicroscopy," by William H. Walmsley, of Chicago; "What is the Best Method of Teaching Micro-Science in Medical Schools?" by Dr. Vida A. Latham, of Chicago; "The Structure of the Teeth and Spines of Some Fossil Fishes, Mazada and Ctena Canthus," by Prof. E. W. Claypole, of Akron, O.; "The Development of the Brain in Soft-Shell Turtles," by Susanna Phelps Gage, of Ithaca, N. Y.; "The Rotifera in Sandusky Bay," by Prof. E. W. Claypole, of Akron, and D. S. Kellicott, of Columbus, O.; "On the Public Water Supply for Small Towns," by Dr. M. A. Veeder, of Lyons, N. Y.; "The Requisites of a Pure Water Supply," by Dr. William C. Krauss, of Buffalo, N. Y.

MICROSCOPICAL MANIPULATION.

On the use of Turpentine in Microscopic Work.—Having lost several carefully prepared specimens of insects by using as a final clearing agent the ordinary turpentine of the shops, I was led to inquire into the matter, when I found that the trade article is not the turpentine referred to in Davis' "Practical Microscopy," p. 415, and Carpenter's "The Microscope," pp. 441 and 442 (1891 edition). It is the natural balsam which flows from the trees that is referred to, and not the distilled extract sold as turpentine or oil of tunpentine.

The following definition is taken from Cooley's "Cyclopædia of Practical Receipts" (1892 edition), p. 1720:—"Turpentine, Turpentin, Terebinthina—an oleo-resin flowing from the trunk (the bark being removed) of *Pinus palustris*, *P. taeda*, *P. sylvestris*, and various species of *Pinus* and *Abies*. It is viscid, of the consistence of honey, and transparent. By distillation it is resolved into oil of turpentine, which passes over into the receiver, and into resin, which remains in the still. Bordeaux, or French, turpentine is from *P. maritima*. Chian turpentine is from *P. terebinthus*. It is pale, aromatic, fragrant, and has a warm taste devoid of bitterness. It is much adulterated, and a fictitious article is very generally sold for it. Venice turpentine is the liquid resinous exudation from the *Abies larix*. It is sweeter and less resinous tasted than common turpentine, but is now scarcely ever met with in trade. That of the shops is wholly a fictitious article."

In Carpenter, p. 442 (1891 edition), it is stated that the natural balsam has a peculiar power of rendering the chitinous textures of insects transparent.—*Victorian Naturalist*.

Counting Blood-Corpuscles.—Dr. Judson Daland, of Philadelphia, has invented an instrument for counting blood-corpuscles, which works on the centrifugal-force principle, and accomplishes the measurement by means of comparative bulks. A quantity of blood is placed in a finely graduated tube and the latter revolved at a speed of

about 1,000 revolutions a minute. The corpuscles divide by force of gravity, and form on the sides of the tube in easily traceable divisions of red corpuscles, white corpuscles and serum. The new method permits of larger, and, consequently, more representative quantitative examinations being used in experimenting, besides doing away with actual microscopic counting.—(Physician and Surgeon.)

BACTERIOLOGY.

Bacteria of the Vagina.—Dr. Chas. Jewett has been studying the bacteria of the vagina in the newly born, and summarizes his conclusions as follows:—

1. The vagina remains sterile for at least two hours after birth. From this time until the third day micro-organisms may or may not be detected; the number of cases where bacteria are found, gradually increases as time goes on, and the bacteria-free secretions diminish. After the third day micro-organisms are always present in the secretion of the vagina.

2. Pathogenic organisms are relatively frequent; staphylococcus pyogenes albus and aureus are observed in four per cent. of the cases; streptococci, in 14.6 per cent. of the cases.—Modern Medicine.

Antitoxic Serum in Small-pox.—M. and A. Beclere recently communicated to the Academy of Medicine, Paris, the result of observations made by them, which indicate the probability that they have discovered a means of treating small-pox by an antitoxic serum with the same degree of success that has attended the treatment of diphtheria. The serum is obtained from the blood of vaccinated animals, and is used in the same manner as the antitoxic serum which is employed in the treatment of diphtheria.

Bacteriological Etiology of the Different Forms of Acute Conjunctivitis.—This exhaustive article is of interest as giving a fair indication of our present knowledge of the subject.

Taking the various forms of conjunctivitis seriatim, they start as follows:

1. Acute contagious conjunctivitis of the catarrhal type—A very small specific bacillus has been found, which was discovered by Koch in Egypt and Weeks of America.

This disease is quite distinct from the simple catarrhal non-infectious conjunctivitis.

2. Gonorrhoeic form—The presence of the gonococcus is the characteristic.

3. Diphtheritic form—True diphtheria bacillus present, and its presence is main diagnostic point to distinguish it from the pseudo membranous form of conjunctivitis. Again it is only in the true form that the anti-diphtheritic serum acts.

3. Paralysis of the superior oblique, following aural suppuration has been reported by Moos.

4. Gelle reports unilateral pupillary disturbance from irritation in the outer and middle ear. Mydriasis (temporary), following operation on ear, aural inflammation, and also from rarefaction or condensation of air in an ear with intact membrana tympani.

Hereditary Tuberculosis.—Bolognesi (These de Doct., Paris) has examined for tubercle bacilli the placentae from thirteen tubercular women, and in several cases the organs of the fetus. Once tubercle bacilli were found in the blood of the mother. In eight cases where the fetus was born dead, or died in a short time, the organs were examined histologically and by inoculation of animals for tubercle bacilli. One hundred and nineteen guinea-pigs were inoculated with the various materials, and also eleven rabbits. Of these, two guinea-pigs inoculated with a placenta from one case died. From these results, together with the experience of former workers, the author concludes that the inheritance of tuberculosis from the side of the mother is usually a disposition (“*heredopredisposition*”), while the direct transfer of the bacilli (“*heredo-contagion*”) occurs but rarely. This latter may take place (1) if there is miliary tuberculosis of the mother,

with tubercle bacilli in the blood; (2) if there is placental tuberculosis which has produced such lesions that the passage of the bacilli is no more prevented; (3) if there is uterine tuberculosis which favors the occurrence of placental tuberculosis; (4) if the amniotic fluid contains bacilli and be swallowed by the fetus.—*Medicine.*

Landry's Paralysis.—Dr. Pierre Marie (La France Med.) communicated the observation of a young groom who died with typical symptoms of Landry's acute ascending paralysis. The autopsy revealed a hemorrhagic softening of the gray substance in the anterior horns. Therefore, the lesion was central, and not peripheral, as maintained by certain authors. Microbes were found, and in the cervical and dorsal region they were present in almost pure cultures. Artificial cultures were not made, but, morphologically, the microbe resembled the bacillus anthracis.

Diagnosing Typhoid Bacilli.—Lazarus has made a clinical test of Elsner's method of diagnosing typhoid bacilli. He adds one per cent. of potassium iodide to Holz's acidulated potato-gelatin. Upon this medium the bacterium *coli* develops rapidly, forming at the end of forty-eight hours coarsely granular brown colonies. The typhoid bacillus, on the other hand, grows more slowly; the colonies at the end of forty-eight hours appearing like small, glistening drops of water with very minute granulations.

The stools of five patients with typhoid gave positive results during the first, second and third weeks of the disease. After the subsidence of fever, bacilli were occasionally found, in one case as late as forty-one days after defervescence. Repeated examinations are necessary, as negative results were shown at times to be false by positive findings at a second examination. In one case of typhoid, where remittent fever persisted, the bacilli were found in the stools even up to the ninth week. Negative results were always obtained in patients suffering from non-typhoidal disease of the intestines.—*Medicine.*

MEDICAL MICROSCOPY.

Examination of the Urine.—I know from personal experience that fully ninety per cent. of the physicians in general practice with whom I am acquainted either do not know how to examine urine or do not do so. I have been told by men old in the profession that they never looked through a microscope. For these there is the excuse of lack of education in the use of the microscope, but there is not the shadow of an excuse for the young man who once told me that he had graduated six years before and found it unnecessary to use his microscope in general practice.—*University Medical Magazine.*

The Blood in General Paralysis.—Dr. Joseph A. Capps summarizes his researches as follows: In general paralysis, 1, the hemoglobin and red corpuscles are always diminished; 2, the specific gravity falls slightly below the normal; 3, most cases show a slight leucocytosis, amounting on an average to about 22 per cent. above the normal. Early cases may have no leucocytosis whatever. 4, in the differential count a decrease is found in the lymphocytes along with a marked increase in the large mononuclear cells. The eosinophiles in a few cases are very numerous. In convulsions and apoplectic attacks, 1, The red corpuscles and hemoglobin are usually increased at the time of a convulsion. During an apoplectic attack of long duration they are both somewhat diminished. 2, the specific gravity is variable, sometimes increasing, sometimes diminishing at the time of an attack; 3, there is a leucocytosis after convulsion and apoplectic attacks, which is as sudden as it is usually pronounced. It certainly does not appear until within a very short time preceding the convulsion, probably not before it actually takes place; 4, the degree of leucocytosis and the period of its continuance, as a rule, vary directly with the length and severity of the attack; 5, in the production of the leucocytosis the large mononuclear cells are increased relatively more than any other variety; 6, the fact after convulsions and apoplectic

attacks in general paralysis there is not only an increase in the number of white cells but a change in their character, as shown by the differential count, and at times abnormal cells appear, is an argument against the theory that leucocytosis is merely a change in the distribution of the white corpuscles.—The Am. Jour. of Medical Science.

Filariae in the Blood.—At a meeting of the Practitioners' Society, of New York, Dr. F. P. Henry, of Philadelphia, related the case, which occurred in a female, aged twenty-nine, who in early life had lived in South Carolina and Florida and had never been outside the United States (*Med. Rec.*). It was, therefore, an indigenous case, the first one in Philadelphia; the infection had probably occurred about the age of twelve; the chyluria first manifested itself shortly after normal labor. The filariæ were present in the blood of the mother alone, not in the milk, nor in the blood of the infant. They were not very numerous, and were present at night only. The urine was repeatedly examined, but only once contained filariæ. These showed remarkable vitality under cold and heat, and one specimen under the cover glass showed movements after ten days.

Regarding treatment, Dr. Henry said that thymol and quinine had no effect on the disease. The same was true of methylene blue, which has been reported of value in one case by Flint. In this regard his observation was in accord with that of Lavarán.

Dr. Henry referred to Manton's writings, wherein it is stated that the embryo came from an adult parasite over an inch long, located perhaps in the thoracic duct; that the mosquito became infected and alighted on water, and that it was by drinking the infected water that man became infected. There were three forms—the diurnal, the nocturnal, and the persistent.

Dr. Henry thought it possible for this affection to become indigenous to Philadelphia and other sections of our country, although the likelihood of so large a body of water as the Schuylkill containing a sufficient number of the par-

asites to infect many of those who drank of it was not great. As a precaution the water could be filtered. The author thought it would be undesirable, if practicable, to kill the mother parasite in the patient's system, as this would result in fatal abscess.

Dr. Andrew H. Smith, of New York, mentioned a case in which the filariæ were found in the blood both day and night, but they were always dead.

Dr. Henry could offer no reason why the filariæ should have been dead unless compressed under the cover glass.

Plasmodia Malaria.—*Plasmodium malarial* was first discovered by Leveson, a French army surgeon, in 1880, and after him Morcheafava, Celli, Golgi, Guarnieri, and of America Councilman and Osler. They are most in unison in their belief that a peculiar micro-organism is in the blood in nearly all cases of malaria, and only peculiar to that disease.

The writer made his first attempt less than two years ago to properly prepare a specimen for examination. I met with failure in the start, but was rewarded in the end by finding exactly what my superiors had intended to teach me, so I endeavor to furnish the readers with my method of procedure.

According to my own experiments, and others, the proper time to obtain the blood is about one hour after temperature begins to rise. However, very beneficial forms may be obtained after about four hours, but it seems that the plasmodia are most plentiful when the temperature begins to rise.

After thoroughly cleaning the finger tip, the blood is withdrawn by a small lancet or, better still, a surgeon's needle, which of course should be sterile. The first drop should be smeared with the needle over finger, which forms a serum coat and a very small drop is then brought in contact with the center of a slip which has been previously closed in strong sulphuric acid for two hours. Wash in flowing water one hour or more, then place the slips in glacial acetic acid for at least an hour. Wash in water as before

and place in 95 per cent of alcohol, after which they may be dried with a linen handkerchief which is well worn, but perfectly clean, or an old silk handkerchief answers the purpose well. Slides should be kept in a dust proof receptacle and cover glasses should be treated the same as slips.

Immediately after placing small drop of blood on slip, which is held in the left hand with your right hand, bring the edge of another slip in contact rather gently, but firm enough to spread the fresh blood thin enough so each individual capsule can be seen distinctly. With a little practice this can be very nicely done from the time of transfer of blood to slide, and spreading should be quite short, as evaporation rather interferes with the process.

Fix the specimen with a solution composed of absolute alcohol one ounce; ether three ounces. Do not rinse, but stain with 1 per cent eosine in 60 per cent. alcohol for fifty seconds to one minute. Wash gently with clean water and dry with, or rather between, bibulous paper. If you care to counter-stain, Loeffler's alkaline methyl blue will serve the purpose, or any of the aniline dyes will do, but not so clearly stain. The specimen should be now gently washed, dried and examined in water. If worthy of preservation dehydrate with alcohol, then dry as before and mount in balsam.

The plasmodia will be stained blue if Loeffler's alkaline methyl blue is used, and the pigment will appear as rather a brown, while the red blood corpuscle itself appears quite red.

The only required apparatus is an ordinary microscope with a 1-12 immersion lens, or, in case you have a low-power objective, very satisfactory results may be obtained by using a high eye piece. I use a No. 3 and 4 eye piece, with $\frac{1}{2}$ inch objective and an Abbe condenser.—*Langsdale's Lancet.*

Serum Injection in Acute Rheumatism.—Weiss (*Central. f. inn. Med.*) observes that it has been proved that blood serum taken from individuals convalescent from a disease is able to protect animals against the infection in

question. This principle has already been applied to influence or cut short disease in man, The author has thus treated 10 cases in Drasche's clinic, the serum being obtained from patients who had just passed through an attack of rheumatic fever. No specific curative action could be proved to exist, although in some cases after two or three injections the disease ended in an unusually short time. In the 10 cases 22 injections were given, and on 9 occasions a favorable effect was noted both as regards swelling in the joints and pain. In 6 cases no result was visible, and in another 3 an apparent increase in the disease occurred. A fall of temperature through 1 to 1½ degrees C. occurred with sweating in those cases influenced by the treatment, whereas, where no effect was visible, no fall of temperature occurred. Six to 10 grammes of the serum were used on an average, 18 to 20 grammes being employed in 2 cases. In 1 case, in which an exacerbation of the disease occurred after the injection, a subacute attack developed into an acute polyarthritis. With so few cases no conclusions can be drawn, but even in cases where a beneficial effect was obtained the inflammatory symptoms reappeared later. In 2 cases the author injected albumoses, three injections of somatose being given in one case, and two in another, with positive results, but here again the effect was a passing one. In these injections two results may be obtained:

1. A specific one.
2. A general action upon the whole individual.

The author thinks that the latter occurred in his cases; naturally, the joints being a place of least resistance were most affected.

MICROSCOPICAL NOTES.

French Method of Purifying Water.—The French Academy of Sciences appears to endorse the new method of purifying water by permanganate of lime and bioxide of manganese. According to this method the permanganate of lime, coming in contact with organic matter and micro-organisms, destroys them and decomposes itself in-

to oxygen, oxide of manganese and lime. Then, to carry off the surplus of permanganate and complete the purification, the water is poured over bioxide of manganese; oxygen in the nascent state is thus freed and it burns up any remaining germs. There remains in the apparatus, then, inferior oxides of manganese, which hasten to reoxidize themselves and furnish again a certain quantity of bioxide of manganese; the water, as thus finally purified, contains a little lime in the form of a bicarbonate and traces of oxygenated water. A very small quantity of permanganate of lime is used in this process, and, if practicable on a large scale, is of great importance. Water having 100,000 colonies of microbes can thus be purified, it is stated, and ice placed in water with permanganate of lime is also quickly sterilized.—Sanitarian.

Enzym in Malt.—Linter observed that dextrose was formed by the action of malt extract or precipitated diastase on starch. As Morris has denied the presence of glucose in malt, the author undertook an investigation to determine the presence of a dextrose-forming enzym in malt and the conditions under which it acts. The results were as follows:

(1) Malt contains dextrose, sucrose, probably levulose, but no maltose.

(2) The absolute and relative amounts of dextrose and sucrose are very variable.

(3) In malt extracts (prepared at 15 degrees and 55 degrees) no ferment which inverts sucrose was found.

(4) Malt contains a dextrose-forming ferment which seems to act most energetically at 55 degrees.

(5) Roasting changes the reducing sugars in malt to products having a smaller reducing power.—*Experiment Station Record*.

On the Enzyma of Some Yeasts.—The bottom yeasts (type Froberg and Saag) contain an enzym which breaks up melibiose while the surface yeasts of the same type have no appreciable action. As the latter contains considerable invertin, this result was a direct contradiction of

Scheibler and Nittelmaier's statement that melibiose is completely split up by the continued action of invertin. The experiments were therefore repeated, and it was found that even large amounts of very active invertin had no action on melibiose.—*Experiment Station Record*.

RECENT PUBLICATIONS.

The Primary Factors of Organic Evolution, By E. D. Cope, Ph. D.—The present book is an attempt to select from the mass of facts accumulated by biologists, those which, in the author's opinion, throw a clear light on the problem of organic evolution, and especially that of the animal kingdom. As the actual lines of descent can be finally demonstrated chiefly from paleontologic research he has drawn a large part of the evidence from this source. Of course, the restriction imposed by limited space has compelled the omission of a great many facts which have an important bearing on the problem. He has preferred the paleontologic evidence for another reason. Darwin and the writers of his immediate school have drawn most of their evidence from facts which are embraced in the science of œcology. Weismann and writers of his type draw most of their evidence from the science of embryology. The mass of facts recently brought to light in the field of paleontology, especially in the United States, remained to be presented, and the evidence they contain interwoven with that derived from the sources mentioned. If the present work has any merit, it is derived from the fact that the basis of the argument is the paleontologic record.

An Illustrated Flora.—Chas. Scribner's sons, New York, have just published the Illustrated Flora of the Northern States and Canada, westward to the 102d meridian, including Kansas and Nebraska, by Prof. N. L. Britton of Columbia University, N. Y., and Hon. Addison Brown, with the assistance of specialists in various groups. Volume 1, neatly bound in cloth, containing 612 pages. Royal 8 Vo. illustrated with 1425 uncolored figured species is sold for \$3.00. Vols II and III completing the work will appear during 1897.



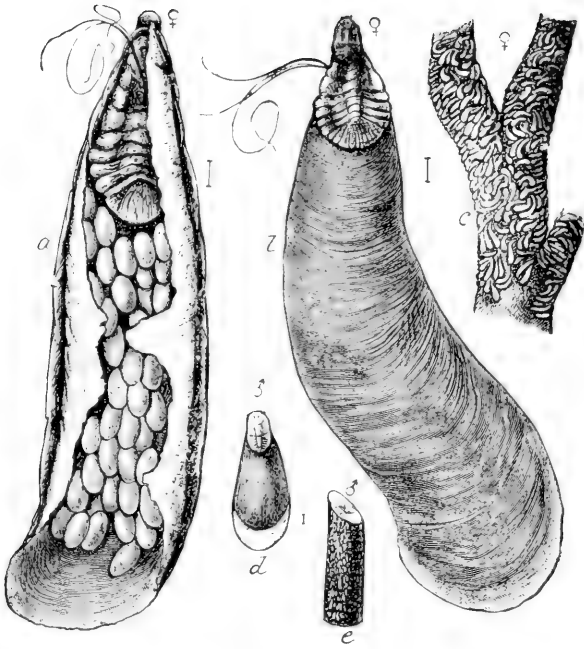

FIGURE 1.

Mytilaspis pomorum or Oyster Shell Bark Louse: a, female scale from below showing eggs; b, same form above, greatly enlarged; c, female scales; d, male scale—enlarged; e, male scales on twig—natural size.

THE AMERICAN

MONTHLY

MICROSCOPICAL JOURNAL.

VOL. XVIII.

OCTOBER, 1896.

No. 10

The San Jose Scale.

BY CHRYSANTHEMUM.

WITH FRONTISPIECE.

This scale, which is now being distributed over widely separated sections of the United States, was first noticed in San Jose in 1893 and named "Aspidiotus pernicious." Instead of being oblong, like most of our native scales it is in general appearance nearly round and flat, of a dirty gray color, with a black spot in the center. If the scales are lifted with a knife the insect itself, if alive, will be seen as a yellow speck, if dead it is usually brown in color. It is about one-eighth inch in diameter and when numerous give the tree the appearance of having been washed with lime and soot.

The life of this insect, with the exception of a few hours of active larval existence, and an equally brief winged existence in the mature male, is passed under the protection of a waxy scale and under this they spend the winter. Early in April the males emerge, and by the middle of May the overwintered females mature and begin to give birth to living young. In this respect they differ from most other scale insects. With the Oyster Shell Bark Louse, if one of the scales be lifted, the shriveled body of the mother will be found in the more pointed portion of the scale while the remainder will be filled with eggs (figs. 1 and 2). This is also the case with the Scurfy Bark Louse (figs. 3 and 4). Notice also the difference in the shape of the scales in each insect. Ordinarily eggs

are deposited beneath the scale, which in time hatch, and the young larvæ make their escape and migrate to different parts of the plant. In the San Jose scale the eggs are fairly well formed, a few at a time, in the body of the mother (fig. 8). What takes the place of the egg shell consists of a very delicate and thin membrane—the amnion, which encloses the developing larvæ and which at the time of birth is cast off, and remains at-

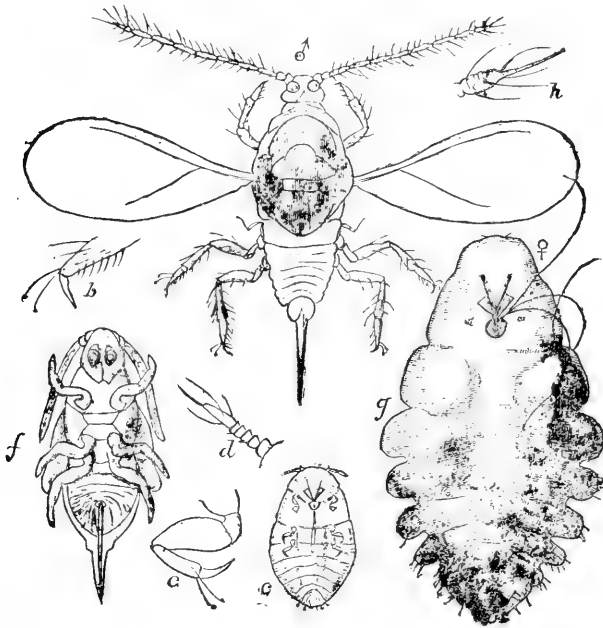

FIGURE 2.

Mytilaspis pomorum: a, adult male; b, foot of same; c, young larva; d, antennæ of same; e, adult female taken from scale;—a, c, e, greatly enlarged; b, d, still more enlarged.

tached to or partly within the oviduct. The amnion is probably pushed out by the next larva in turn. Each female gives birth to from 9 to 10 larvæ in twenty four hours and as this extends over a period of six weeks it leads to a very confusing intermingling of generations and renders it difficult to make observations, but by iso-

lating individuals the development has been most carefully traced.

After being expelled, the larva remains motionless for a little while, with antennæ and legs folded beneath the body. It soon hardens enough to run about, and forcing its way from the parent scale, it travels over the plant to find a suitable place to settle. The newly born larva (fig. 6.) is a microscopic creature of pale orange color with long oval body having six legs and two feelers. The long thread-like proboscis with which it sucks the juices of plants is doubled on itself and lies in a cavity in the body, only a tip projecting.

After crawling about for a few hours the larva settles

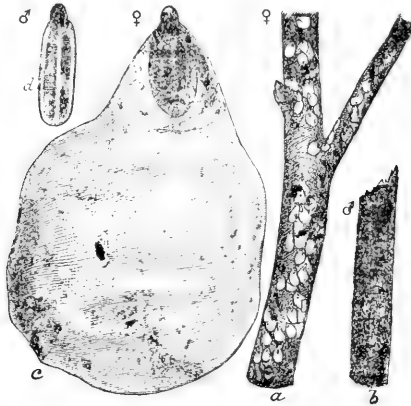

FIGURE 3.

Chionaspis furfurus or Scurfy Bark Louse: a, c, females; b, d, males—a, b, natural size; c, d, enlarged.

down and slowly works its long bristle-like sucking beak through the bark, folds its legs and antennæ beneath its body and contracts to a nearly circular form. The secretion which forms the scale now begins to exude from all parts of the body in the form of very minute white fibrous waxy filaments (fig. 6) which rapidly become more numerous and dense. At first the orange color shows through this waxy covering, but within two days' time

the insect is entirely concealed by the scale, which is now a grayish yellow color and has a central nipple or tuft. The scale is formed by the slow melting together of the filaments of wax. As the scale grows older it turns darker, the central nipple remaining light until fully developed.

The male and female scales are exactly alike in size,

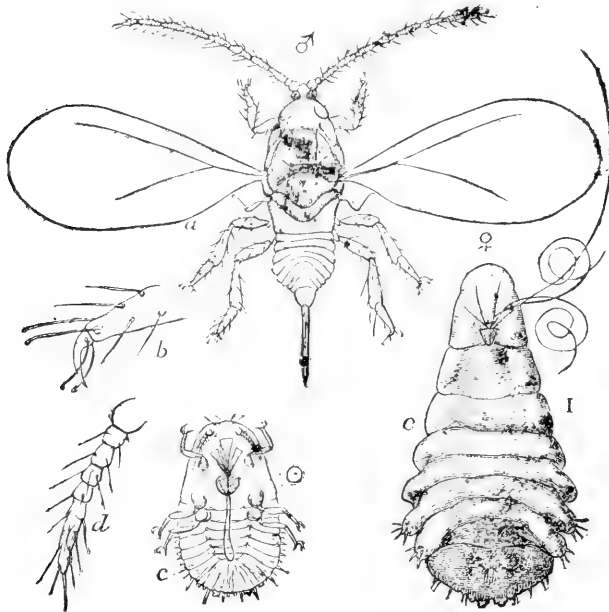

FIGURE 4.

Chionaspis furfurus: Adult male from above; b, foot; h, tip of antennae of same; c, larva; d, antennae; e, leg of same; f, pupa; g, adult female removed from scale—all enlarged; b, d, e, h, much more than the others.

color and shape until after the first molt, which occurs twelve days after the larva emerges. They now lose all resemblance to each other. The males are rather larger than the females, and have large purple eyes, while the females have lost their eyes entirely. The legs and antennae have disappeared in both sexes. The males are elongate and pyriform, while the females are almost cir-

cular, amounting practically to a flattened sac with indistinct segmentation, and without organs, except a long sucking bristle springing from near the center beneath. The color of both sexes is light lemon yellow. The scales are at this time of a decidedly grayish tint, overcast somewhat with yellow.

Eighteen days from birth the males change to the first pupal condition, the scales becoming an elongate oval, the cast larval skin showing near the anterior end. The male pro-pupæ are very pale yellow, with legs and antennæ (which have reappeared) together with two of the terminal segments, colorless. The eyes are dark purple

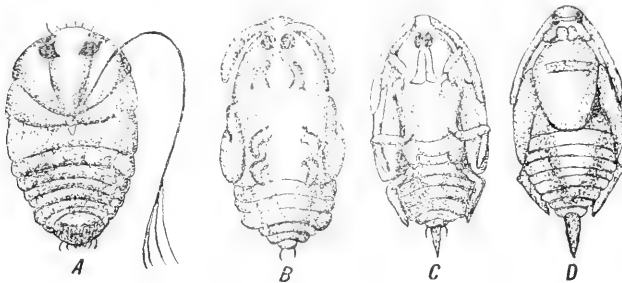

FIGURE 5.

Aspidiotus perniciosus: Development of male insect; a, ventral view of larva after first molt; b, same, after second or pro-pupa stage; c and d true pupa, ventral and dorsal views.

and placed close together. The antennæ are stout and bent closely along the side of the body as far as the first pair of legs where they curve inward. Prominent wing pads extend along the sides of the body, the terminal segment bears two short spines (fig. 5).

The female undergoes a second molt about twenty days from the larva. She is still yellow in color, of circular form, the greatest diameter being 0.56 mm. The sucking bristles are very prominent. The last segment at this stage has practically the characters of the mature female, as follows (fig. 8): There are two pairs of lobes, the terminal ones largest and nearly three times as

broad as the other lobes. Terminal lobes are rounded at the apex and are distinctly notched near the middle of the external edge. The second pair of lobes is smaller and narrower and is also notched externally. Between the first and second lobe on either side is a small spine and two or three such spines are just back of the second lobe, while back of these are three stout teeth, curving anteriorly (fig. 8, d.) A still smaller blunt tooth sometimes occurs near the middle of the lateral margin. The segmentation of the body at this stage is quite distinct. At each

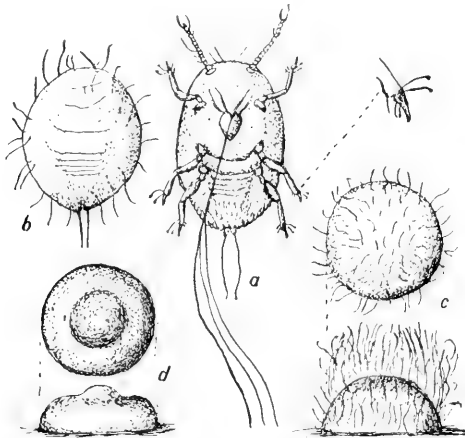

FIGURE 6.

Aspidiotus perniciosus or San Jose Scale: Young larva and developing scale a, ventral view of larva, showing sucking beak with setae separated, with enlarged tarsal claw at right; b, dorsal view of same, somewhat contracted, with the first waxy filaments appearing; c, dorsal and lateral views of the same, still more contracted, illustrating still further development of wax secretion; d, later stage of the same, dorsal and lateral views of the same, showing matting of wax secretions and first form of young scale—all greatly enlarged.

molt the old skin splits around the edge of the body, the upper half adhering to the covering scale and the lower forming a sort of ventral scale next to the bark. This form of molting is common to scales of this kind.

At this stage the male scales are more yellowish than the females. The effect of the sucking of the insects is now quite apparent on the young growth, causing the bark to assume a purplish hue for some distance around

the central portion, contrasting strongly with the natural reddish green of the uninjured bark. With the second molt the females do not change materially. They retain their yellow color. The sucking bristles are extremely long, two or three times the length of the insect's body.

About twenty days from birth the male insect transforms to the true pupa (fig. 5, c. d.) The true pupa is pale yellow, sometimes purplish, darkest about the base of the abdomen. The head, antennæ, legs, wing pads and style are well formed, but almost colorless. The antennæ reach as far back as the second pair of legs and are not curved under, as formerly, but lie close to the sides of the body

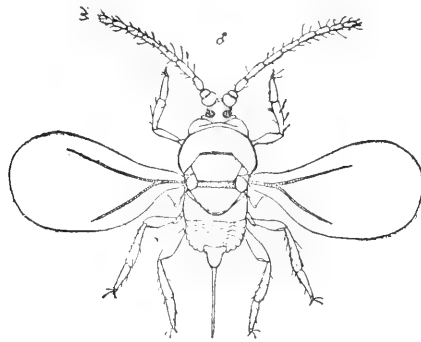

FIGURE 7.

Aspidiotus perniciosus: Adult male.

with the ends free. The first pair of legs are held forward, reaching slightly beyond the eyes, the middle femora projecting somewhat beyond the margin of the abdomen. The hind legs are inclined backward and reach to the end of the body. The style is rounded at tip, conical and about as long as the posterior tibiae.

At twenty-four to twenty-six days from birth, the male matures and backs out from the rear end of its scale. They issue chiefly at night. The mature male (fig. 7) appears as a delicate two-winged fly with long feelers and a single style projecting from the end of the body. The

head is darker than the rest of the body, the eyes are dark purple, and the antennæ, legs, and style are smoky. The wings are iridescent with yellow and green.

Thirty days from birth the females are full grown and the young may be seen within their bodies, (fig. 8) each enclosed in a thin membrane. At from thirty-three to forty days the young begin to make their appearance at Washington, D. C., four full generations being developed in a

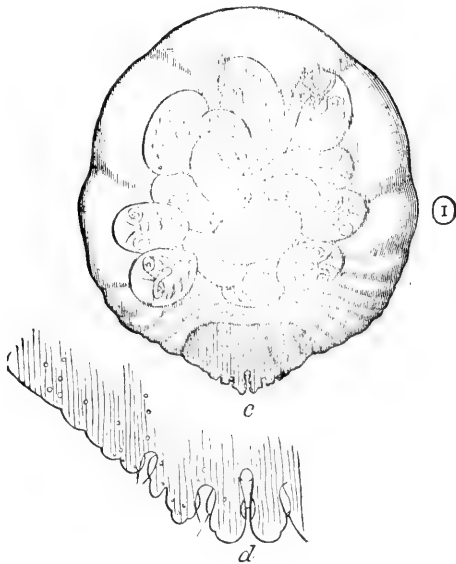

FIGURE 8.

Aspidiotus perniciosus. c, adult female removed from scale, showing embryonic young; d anal plate.

single summer. It will be seen that they are very prolific, a female, it has been estimated, sometimes has as many as 3,216,080,400 descendants in a season, and a single female gives birth to from forty to five hundred and eighty-six in a life-time. We are indebted to the kindness of Mr. L. O. Howard, U. S. Department of Agriculture, Division of Entomology for facts contained in this article.

The American Blood Test For Cattle Tuberculosis.

BY EPHRAIM CUTTER, M. D., LL. D.,

NEW YORK.

1. THE APPEARANCES OF BLOOD IN HEALTHY CATTLE.

Oxford Co., Maine, is a dairy farm. The inhabitants are pure English blood, indeed purer English than those living in Great Britain.

Intelligent care watches over the kine of Oxford Co., Me. Hence this locality was selected as giving the best standard of kine fed on natural, not artificially prepared foods, living in pastures well watered, with good herbage. The following notes are submitted, of examinations of blood supposed healthy.

SERIES I.

Buckfield, Me., kine of Mr. Conant, 1895, July 31. Assistance of Dr. J. F. De Costa, now of Rumford Falls, Me., and Mr. Conant.

1 Stall fed bull. (a) Crenated red corpuscles. (b) Serum in excess. (c) Crystals of the triple phosphate of ammonia, magnesia and soda. (d) No signs of tuberculosis.

a and *b* were due to the mode of collecting the blood, punctures not quite deep enough. The extraordinary thick fibrous structure of the bull's skin, with a puncture entirely sufficient for the average human being, merely allowed the serum to filter through with a moiety of the red and white corpuscles. It is possible that kine have more sensitive skins than most are aware of, as I have noticed that some kine cringe when approached by unknown persons. In these studies I have sought to modify this bovine fear by having those herdsman present whom the cattle know.

2 One year old Jersey bull, grass fed. Healthy blood.

3 Cow common breed. Two samples examined. Mor-

phology of healthy blood save triple phosphate crystals in each sample.

4 Cow. Healthy blood.

5 Cow. " "

6 Cow eight years old, normal, some free oil globules and crystals.

7 Cow. Only serum could be had from first specimen. With deeper perforation the second specimen was normal.

8 Cow eleven years old. Normal save crystals and emboli of massive fibrin filaments concreted.

9 Full blood Jersey cow, six years old. Normal save crystals.

10 Cow three years old, (common breed.) Normal.

11 Cow seven years old. Normal.

12 Cow ten years old. Normal save crystals.

13 Cow two years old. Normal.

14 Cow three years old. Normal.

15 Cow seven years old. Full blood Jersey, normal.

SERIES II.

Mr. William Berry's herd. Hebron, Me.

1, 2, 3, 4. Cows common breed. Normal.

5 Cow nine years old. No tuberculosis. Crystals and huddling of red corpuscles. Rheumatism.

6 Cow nine years old. After removing scarificator blood came in drops; unusual thing in kine. Thrombi, crystals, huddling of red corpuscles. Rheumatism, not tuberculous.

7 Cow five years old. Normal.

8 Cow four years old. Normal.

9 Cow four years old. Blood has a tendency to huddle—non-tuberculous.

10 Cow eight years old. Normal.

11 Cow eight years old. Thrombus, crystals, huddling blood. Rheumatism. No tuberculosis.

12 Cow four years old. Serum in excess. Normal.

- 13 Cow six years old. Blood corpuseles huddle as in rheumatism. Non-tuberculous.
- 14 Cow ten years old. Blood normal.
- 15 Cow four years old. Blood normal save crystals.
- 16 Aug. 7, 1895. Heifer two years old. Same vinegar yeast and crystals. Tuberculous.
- 17 Cow. Free oil and crystals in blood, no tuberculosis.
- 18 Cow. Normal blood.
- 19 Cow. Normal blood.
- 20 Cow nine years old. Blood contains masses of fat resembling thrombi, otherwise normal.
- 21 Cow nine years old. Blood normal.
- 22 Cow eight years old. Blood normal.
- 23 Cow eight years old. Blood normal.
- 24 Cow nine years old. Blood normal.
- 25 Cow nine years old. Blood normal.
- 26 Cow nine years old. Blood normal.

SERIES III.

Herd of Mr. A. B. Parker, Green, Me., Aug. 5, 1895.

- 1 One year old heifer. Blood normal save crystals.
- 2 Cow nine years old. Triple phosphates, crystals, enlarged white blood corpuscles. Thrombi several. Non-tuberculous. Asthmatic three months ago.
- 3 Cow four years old, thoroughbred Jersey; finely normal throughout.
- 4 Cow five years old. Normal blood.
- 5 Cow four years old. Normal blood.
- 6 Bull two years old. Normal blood.

SERIES IV.

Hon. Solon Chase's herd of milch kine. Chace's Mills, Me., Aug. 14, 1895.

- 1, 2, 3; 4, 5, 6, 7, 8, 9. All normal.
- 10 Normal save crystals and ridged huddled blood. No tubercle.

SERIES V.

Herd of Dana H. & Howard D. Fish, Keene's Mills, Me., Aug. 16, 1895.

1, 2, 3, 4, 5, 6, 7, 8. Normal kine.

9 One single mycoderma aceti or vinegar yeast with massive fibrin filaments, red corpuscles normal. Tuberculous.

Aug. 17. Observation as to No. 9 confirmed. The Messrs. Fish said she had been sick and kept on bad fodder before they bought her.

10 Cow. Rheumatic with triple phosphates, crystals and massive fibrin filaments, otherwise normal.

11 Cow. Normal save oil in blood.

12 Cow twelve years old. Healthy.

13 Cow. Healthy.

14 Cow. Healthy, with some spore collects.

15 Cow. No tubercles, but rheumatism with automobile copper colored spores like crypta syphilitica, common in man, but thus observed in kine for the first time.

16, 17, 18, 19, 20. All healthy.

SERIES VI.

Hon. Z. A. Gilbert, Greene, Me., Aug. 20, 1895.

Cows 1, 2, 3, 4, 5, 6, 7. Rheumatic.

Cows 9, 10. Healthy as to tuberculosis.

SERIES VII.

Supt. J. H. Conant, Turner, Me., Aug. 20, 1895.

1 Cow. Healthy blood.

SERIES VIII.

Prof. A. H. Bradford, Turner Center, Me., Aug. 22, 1895.

1 Cow. Blood normal.

2 Cow. Probably tuberculous.

3 Cow. Healthy.

4 Cow. Healthy.

5 Cow. Healthy.

SERIES IX.

Herd of F. A. Ricker, Turner Center, Me., Aug. 21, 1895.

1 Cow examined was thought to be tuberculous, but on second examination next day did not appear to be. Spores and spore collects of mycoderma aceti were thought to be due to intestinal fermentation from constipation as in mankind some times.

2, 3, 4, 5, 6, 7, 8. Normal.

SERIES X.

Herd of Mr. Phillips, Turner Center, Me., Aug. 21, 1895.

1, 2, 3, 4, all normal save in 4, masses of blue and green pigment matter were found in the blood, as they are found in the blood of man in connection with fatty degeneration and rheumatism. They were exactly like what is found in the morphology of human blood.

SERIES XI.

Heifer owned and kept by Mr. E. B. Terrell, 165th street and Mott avenue, New York. Fed on hay, grass and grain. Blood proved to be normal. 1895.

SERIES XII.

Herd of F. Homer Foster, B. S., Andover, Mass., Jan. 29, 1891. Morphological blood examination. Query, are they tuberculous?

No. 1 Cow Minnie. Supposed to have tuberculosis. Red corpuscles distinct, crenated, segregate, no nummulation. White corpuscles; not numerous, much enlarged; nucleus in most.

Serum. Fibrin filaments not marked. A few spores. Decision. Behaviour not tuberculous.

Remarks. Nov. 7, 1895. This cow found not tuberculous.

No. 2. Heifer Felice. Same as No. 1. Considerable masses of stellurin.

Remarks. Same as No. 1.

No. 3. Cow. Nell of Vale. Same as No. 1 save the presence of large rheumatic fibrin filaments.

Remarks. Same as No. 1.

No. 4. Cow Princess. Same as No. 1 save that there were skeins of fibrin filaments.

No. 5. Cow Buttercup. Normal.

No. 5. Cow Bramble. Normal.

No. 7. Cow Clover. Masses of vinegar yeast, mycoderma aceti. Behaviour of red corpuscles normal.

Remarks. This cow proved tuberculous.

No. 8. Bull Thesus. Same as No. 1 save the presence of fibrin filaments.

No. 9. Heifer Kate. Normal except fibrin filaments and crystals. Rheumatism.

No. 10. Heifer Melia. Normal.

Summary. 116 Kine.

Tuberculosis was found in four cases; rheumatism in twenty-six cases; thrombosis in four cases; signs of fatty degeneration, three cases; blue and green pigments same as in fatty and fibroid degeneration in man, one case. The object of these examinations was to find out how the blood of so-called healthy kine appeared to one who had studied the morphology of human blood for thirty years. The presence of crystals of stellurine, triple phosphates of lime, magnesia and soda, etc., of rigid, ropy, sticky, red corpuscles; of massive fibrin filaments which are found in thrombosis and embolism; of free oil and pigment; was an unexpected surprise. A very interesting, important and practically useful field thus is opened for veterinary exploration and study. Cattle die suddenly of heart diseases, thrombosis, fatty heart, etc.

II. THE APPEARANCES OF BLOOD IN TUBERCULOUS CATTLE AND TESTS.

The appearances of blood in kine at Knacher's yard, condemned to die on account of tuberculosis, by the New York state commission of Veterinary Surgeons.

Present Dr. Austin Peters, Mass., Dr. Johnson, New York city, Dr. Curtis and by invitation E. Cutter, Greenbush, New York, Dec. 16, 1892.

No. 1 Old bull. Capillary blood from smooth skin beneath the tail, showed spores and spore collects of mycoderma aceti or vinégar yeast. Otherwise normal. Pronounced by me tuberculosis.

Per Contra. The veterinary gentlemen noted the post-mortem appearances in all these cases, and to make no mistakes the written results were exchanged with mine some two weeks later.

The following is the veterinary report: "No. 1 Bull. Tuberculosis of both lungs (extensive) and mediastinal lymphatic glands."

Remarks. This is a wonderful report; when it is known that the bull could not be felled by repeated blows of an ax, and with difficulty killed by revolver shots at ranges of about an arm's length. The bull showed a marvelous vitality, which would have stood in good avail, had he been treated for cure. His difficult death should encourage efforts to cure such cases. Had we such vital resistance in human cases we could make a better showing.

No. 2 Cow. Specimen not well collected, due to the thickness of skin, exposure to cold and raw atmosphere, shrinking from the fear of the kine in their unwonted environments. They acted as if they knew something was wrong. They tried to escape and run away. I have noticed this condition in other cases, the contraction acting like a sieve to restrain the red blood corpuscles and suffer the serum to flow only. Still there were found a few collections of mycoderma aceti and some masses of colloid.

I called the case pretubercular, i. e., where tuberculosis is in the pre-stage, before the lungs are broken down.

"No. 2 Cow. Tuberculosis of both lungs and mediastinal lymphatics, but not so badly diseased as No. 1." Veterinarian report.

"No. 3 Cow. Only a few single spores of mycoderma aceti were found; not a very decisive case, but put down as pretuberculosis possibly."—E. Cutter.

"No. 3 Cow. Found only a pharyngeal abscess, presumably tuberculous."—Veterinarian report.

"No. 4 Cow. A few spore collects. Some massive broken crystals indicating rheumatism."—E. Cutter.

"No. 4 Cow. A very old cow. Tuberculosis in both lungs. Well marked in the right, slight in the left."—Veterinarian report

"No. 5 Cow. A few segregate individual spores of mycoderma aceti. White corpuscles enlarged. Doubtful. Specimen spoiled by heat of lamp accidentally."—E. Cutter.

"No. 5 Cow you mark doubtful I think her trouble was only bronchitis of left lung."—Veterinarian report.

"No. 6 Cow. A few discrete single spores. Two or three spore collects. Amyloid body(?); crystals. Morphology of blood otherwise normal. Suggests pretuberculous."—E. Cutter.

"No. 6 Cow. Tuberculosis both lungs, but not very extensive."—Veterinarian report.

"No. 7 Cow. A very few spore collects, not typical. Otherwise normal. May be pretuberculous."—E. Cutter.

"No. 7 Cow. Tuberculosis both lungs, also a little pus in left forequarter of udder."—Veterinarian report.

"No. 8 Cow. Red corpuscles normal. White corpuscles enlarged and show entophytal vegetation. Some few spore collects and single spores. Pretubercular I should think."—E. Cutter.

"No. 8 Cow. A few tubercles in both lungs and also in mediastinal lymphatics."—Veterinarian report.

"No. 9 Cow. Red corpuscles attempt nummulation. One or two typical spore collects. No fibrin filaments. Enlarged white corpuscles. Some segregate spores. Not a typical case. Pretuberculous."—E. Cutter.

"No. 9 Cow. Had only a very few tuberculous nodules in lungs, but quite large abscess in the udder."—Veterinarian report.

"No. 10 Cow. One typical spore collect. Enlarged white corpuscles. Abundant single and double spores, tuberculous. Fibrin filaments not seen. No crowding of red corpuscles. Indeed the behavior of the red corpuscles in all these kine, differs from the behavior of the red corpuscles in man in tuberculosis. Also the fibrin filamentation differs. So far as these cases go, only the spores and spore collects are visible and significant."—E. Cutter.

"No. 10 An old cow, was in life a doubtful case to me, yet on post mortem showed much more tuberculosis than I expected."—Veterinarian report.

"At first study this may not appear so satisfactory to you as it is: All the cases you called "pretubercular" had tuberculous deposits in the lungs, but the satisfactory part comes in when we compare your notes with the extent to which the animals were diseased."

"Your No. 1. The bull you say was decidedly tuberculous, and he was.

"No. 2 Was worse than your notes state.

"No. 3 You say not decisive, and she had only a pharyngeal abscess.

"No. 4 Was not a bad case though well marked.

"No. 5 You call doubtful and so she proved to be on post mortem.

"No. 6 Was not a bad case although well marked.

"Nos. 7 and 8. You call the same, and they were much alike even to roan color.

"No. 9. You say, 'not a typical case;' it was not, there being only a very few small nodules in the lungs, but a large abscess in the udder.

"No. 10 You call 'tuberculous' and she was worse than I expected.

"Your 'pretubercular' cases were not as bad as your tubercular. You are right on the doubtful ones.

Yours truly, AUSTIN PETERS.

CASE II. Heifer pronounced to be badly tuberculous. I could find nothing abnormal, nor did the post mortemists.

There were other cases all like the above. When the great difficulty of the physical exploration of the thoraces of the kine is kept in mind, it is a wonder that there were no more mistakes made.

For example, one old cow who had wheezy breath, did not furnish any sign of tuberculosis by blood examination, and after death her lesion was proved to be a contracted trachea from traumatism.

The writer acknowledges his indebtedness to the kindness of the veterinary surgeons, and thanks them for their courtesy.

III. COMPARISON WITH TUBERCULOUS BLOOD IN MANKIND.

a. Morphology of the Blood in Health in Man. After Salisbury.

Blood from Capillaries. Color; bright, fresh, clear, ruddy, strong. Clotting rapid and firm: Red corpuscles arrange themselves in nummulations, or are scattered evenly over the field. Normal in size. Non-adhesive. Central depression well marked on both sides; periphery well rounded, clean cut. Hold coloring matter firmly. Pass readily to and fro through the fibrin filaments.

Appear fresh and fair, giving an appearance of health, like a rosy cheeked maiden full of life. White corpuscles normal in size. Not enlarged by internal collections of foreign bodies. Amœboid movements strong or not. Proportion one to three hundred of red corpuscles. Consistence good. Not sticky. Color a clean white. Freely moving at will. Serum clear and free at first sight from any form. After five minutes, most delicate semi-transparent fibrin filaments appear, forming a very light network in the field, which offers no obstacle to the passage of the corpuscles. There should be no spores or vegetation in healthy serum, though they may be found by very minute examination, or by letting the blood stand for several days in closely stopped phials at a temperature of from 60 to 75° Fahrenheit. This is not saying that spores and filaments cannot be found in blood of persons calling themselves healthy—for some diseases exist in a latent condition, like rheumatism, syphilis, cystinæmia and consumption. I have met with people who, on finding vegetations in their blood, have decided not to accept the evidence because they deemed themselves healthy. Again it is difficult to find a perfectly healthy person in the community; this was made public during the "late unpleasantness," when drafts were made for soldiers. The blood evidences must be taken in connection with that of the other physical signs. The morphology of healthy blood is a most rigid test, and in delicacy and far reaching goes beyond any of the other physical signs.

b. Morphology of the Blood in Consumption of the Lungs. After Salisbury.

Use. In diagnosis, exceeding in value auscultation and percussion, because it detects consumption of the lungs before there is any lesion of them. To show the

real progress of the case by the substitution of the morphology of health more or less, to show when the patients have lapsed in the treatment by eating forbidden food, and to show when there is a real cure. To repeat, most valuable of all to make a diagnosis of consumption with as much certainty as it is possible in human affairs, and by removing the uncertainty, sometimes dreadful, of the diagnosis that accompanies the conventional first stages of consumption of the lungs.

“This value is so great that it is more than a warrant for this publication to be made. It is hardly possible to overestimate the importance of this department of physical exploration.

“First or Incubative Stage. Red blood corpuscles are less in number,ropy and sticky, more or less, but not much changed otherwise.

“Second Stage of Transmission. 1. Red Corpuscles. Color, pale, non-lustrous, not clear cut, not ruddy. Consistence, sticky, adhesive. Coating of neurine removed. Not so numerous as in normal blood. Owing to the increased size and strength of the fibrin and the stickiness, they form in ridges, rows, but not so marked as in rheumatic blood. They accumulate in aggregations of confused masses, like droves of frightened sheep. They adhere to each other, and are rotten, as it were, in texture. 2. White corpuscles. Enlarged and extended by the mycoderma aceti or spores of vinegar yeast, that are transmitted into the blood stream from the intestines. 3. Serum. More or less filled with the spores of mycoderma aceti or vinegar yeast. These occur either singly or in masses of spores, which is the common form in which they are found, wherever vinegar is produced. The fibrin filaments are larger, stronger, more massive than in health, and form under the microscope a thick network which is larger, stronger and more marked in

direct proportion to the severity of the disease or the amount of accumulation. Besides, the serum is apt to be of a dirty ash color. The sticky white corpuscles, the massive fibrin filaments in skeins, and the yeast spores alone or combined, form aggregations, masses, collects, thrombi, and emboli which block up the blood vessels of the lungs soonest, because exposed to cold air, the most of any viscus; the blood vessels contract, and thus arrest the thrombi and form a heterologous deposit, which is called tubercle.

“The Third Stage, or Stage of Tubercular Deposit. These deposits increase so long as vitality subsists in the tubercle and surroundings. When the vitality ceases, the tubercle softens or breaks down. Sometimes if the process is very slow, and life slightly inheres in it, the proximate tissues undergo fatty infiltration, which preserves it from readily breaking down. The morphology of the blood is the same for the second and third stages of consumption.

“Fourth Stage. Interstitial Death. Morphology of the blood in this stage is the same as in the second and third, save that it becomes more impoverished. The Red Corpuscles are thinner, paler, much lessened in number, increased in adhesiveness, stickiness and poverty. Devoid more or less of neurine. The white corpuscles are fewer in number, more enlarged; often ragged and rough. Distended with spores of *mycoderma aceti*, more adhesive and sticky. The serum. Fibrin filaments are thickened, stronger, more massive and more skeins of them present. The collects of *mycoderma aceti* are very much larger and more numerous; in moribund cases, I have seen them so large as almost to fill the field of the microscope. They present anfractuous edges and amœboid prolongations, giving them a weird, bizarre aspect which, under the circumstances have a portentous aspect,

for the larger and more numerous the spore collects of mycoderma aceti are, the more dangerous the case."

c. Comparison of Kine Blood and Human Blood.

1. The morphology of normal blood of kine exactly corresponds with that of man as given above.

2. The morphology of tuberculous blood in kine is not the same as in man so far as these observations go. Differences as follows: (a) Red corpuscles act normally. (b) Fibrin filaments are not massive and numerous.

Similarities of kine tuberculous blood to that of man.

(a) White corpuscles enlarged often more than in man. (b) The mycoderma aceti or vinegar yeast is present as in man.

Indeed it was on this yeast that I made the diagnoses which were better than the average prognostications. As noted, it occurs as single, double and multiple spores; in large snow-white masses of fusiform shape, sometimes in large abundance just as in man. They are unmistakable, positive. Have been found reliable evidence for many years.

IV. ADVANTAGES OF THIS BLOOD MORPHOLOGICAL TEST OVER TUBERCULIN.

1. It is simple, readily learned, easily applied.

2. It introduces no diseased matter into the blood to set up efforts to expel diseased tissues (not to stop causes), which efforts of expulsion cause fever.

3. It allows the diagnosis of the pretubercular stage and the cure of the cattle; tuberculin is of no value except when there is actual disease and breaking down of the lungs.

4. It does not involve the loss of the kine.

5. It is always good so long as pre-tuberculosis or tuberculosis exists; and as in man, is of immense value in making negative diagnoses when neither tuberculosis nor pre-tuberculosis exist.

6. The amount of the yeast spores present is a sort of measure of the amount of the lesion; the more the disease the more the yeast.

6. It can be applied often and harmlessly.

8. It is common sense in principle, as it treats of causes, while tuberculin treats only with results, influencing causes not one particle.

9. Even if time shows that the writer has overestimated the value of this test, it is the best means of detecting tuberculosis and pre-tuberculosis in man and kine.

V. IMPORTANCE OF SUBJECT.

It is of importance to have healthy kine, but we do not believe all the sensational reports as to the communication of tuberculosis to man from cows, for if true we should almost all be dead. The evidence is overwhelming that tuberculosis comes from food, in excess and long continued, which either before or after ingestion undergoes the acetic acid fermentation. It is not the place here to enter into this, but it may suffice to say that food of kine or man undergoing the alcoholic and vinegary fermentation is most favorable for tubercle. The ordinary silo seems to be the most favorable method to obtain such food. The fact that tuberculosis in cows is most prevalent where ensilage, brewers' grains and forced feeding are used; the fact that bovine tuberculosis has only come into prominence since such feeds have been used; the facts that alcoholic and vinegar yeast are found in abundance in silo food, and are found in the blood of tuberculous kine; the fact that hogs kept on distillery still contracted tuberculosis, all these show that the farmer must take other views than those that now obtain. The farmer today is like the man in Pilgrim's Progress, pouring water on a fire that will not go out because some one behind him is pouring on oil; killing tuberculous cattle and feeding the newly bought kine with sour foods will not

extinguish tuberculosis from his herd. In conclusion, I wish to thank the veterinarians and all who have made these studies possible.

A Growing Cell.

BY ARTHUR M. EDWARDS, M. D.,

NEWARK, N. J.

Hamilton L. Smith is the name of a person that all the older microscopists were glad to have known and we who were intimate with him must regret that the Societies and Journals know him so seldom now. Diatoms were the source of unmixed pleasure then and his magnificent collection, containing that of de Brebisson also, often yielded treasures to the anxious seekers after knowledge. It is gone now into the hands of another who it is hoped will contribute some of its beauties to the world at large. Professor Smith is busy with electricity he tells me and neglects his microscope. Perhaps his growing slide has also grown dusty and is out of use.

But I was working then at living diatoms and have been working at them till now for we are never too old to learn and the problems of life still remain uncompleted. I then made a growing slide of glass which I thought was just as good as Smith's. At least it answered the purpose and as it never has been described I wish to describe it now. It was made for me by that ingenious mechanic George Wales, who is in New Jersey and making camera lenses.

But what I have got to say is about the growing cell. The majority of microscopists at the time of which I am speaking, that is about thirty years ago, were Diatomists, that is to say they studied the shells of Bacillariaceæ to see if they could by the use of the lenses then made bring out the markings on *Pleurosigma angulata*, *Amphipleura pellucida* and other fine-lined diatoms. They also worked

at the central rays of light on the Podura scale to bring them out. And microscope makers, or rather the makers of objectives, Charles Spencer, Robert B. Tolles and William Wales in this country; Powell, Lealand, Smith and Beck in Europe, were then prominent. Charles Spencer was the prince and was followed close after by Robert B. Tollés.

We had diatoms on the slides, as *Pleurosigma angulatum*, and we had them living, but how to study them and keep them living was a problem. Prof. Smith made an ingenious contrivance for keeping them alive and studying them whilst so alive and it was known as a growing cell. Growing cells had been made in England, but none of them were trustworthy. Smith's answered the purpose admirably, only there was one defect. It had to be made with too many joints, which soldered with a cement would leak and let the water out just at the time when it was wanted. So I propounded to George Wales what I wanted and this was the result.

A piece of plate glass about a quarter of an inch thick was taken. It was three inches square. In the centre by means of a lathe set with a brass cylinder and fed with water and emery, a hole was cut about two inches in diameter. The mode by which it is cut is known to those who use a lathe and is by soldering the plate glass on another plate of glass and holding it against the revolving cylinders. In this manner the glass plate is bored with a hole through it. It is then taken off the plate it was fastened on and cleaned. This forms the box of the growing cell. A bottom is formed of plate glass, three inches square but only ordinary plate glass. It may be about one sixteenth of an inch thick. It is soldered to the bottom of the cell ordinarily. But sometimes I find it is not necessary to solder it. It keeps in place without so doing. The solder or cement is rubber cement or

something that is easily applied, as alcohol; benzine or turpentine is not used in the cell. Any cement will do. The cover is of ordinary plate glass but loose on the cell. It has a minute hole drilled in it near the bottom of the cell to form a communication for the water in the body of the cell to the cover of the object. This is an ordinary round cover placed upon the plate glass and with the water containing the Bacillariaceæ in it.

To use the growing cell it is placed on the stage of the microscope, which is inclined at the ordinary angle. Then the object, as the Bacillaria, is viewed with the objective. As the water evaporates around the cover, a space of air accumulates in the upper part of the growing cell and water must be added to make it up. This can be done by moving the upper plate glass having the object on it to one side. With this contrivance I have kept Bacillariaceæ under observation for a long time, a week or more. But I do not see why it cannot be kept in operation indefinitely. As the water evaporates of course it must be supplied, or it may have salt water added until it becomes salter and salter and at last it may become brine and Bacillariaceæ, or in fact any object may be observed growing in water from ordinary fresh water to brine. I have in this manner made some interesting experiments which I will detail hereafter.

Lately I have been experimenting with the growing cell and wanting something that is better, or rather that does not require removal by sliding off the upper plate glass to introduce new water, as salt water. To observe the actions of the change of water from fresh to salt on Bacillariaceæ, I have used the following contrivance. This I find better still than my growing cell, which has but two joints whilst Smith's has six. I use a bottle of two or four drachms capacity. It has flat sides so that the upper plate glass is done away with and a small hole is bored in it to let the water communicate with the in-

terior and the Bacillariaceæ. It has the lower side cemented by gum thus or balsam, though gum thus is best, to an ordinary slide which is placed on the stage of the microscope. The bottle is an ordinary one and can be gotten easily. It is also corked, with a rubber cork, and can thus have the water supplied. The small hole can be bored, by using a small rat-tail file wet with spirits of turpentine and one can with ease bore a hole smaller or larger as wanted. I now have an excellent growing slide that answers every purpose and can be employed for Bacillariaceæ or larger objects as desired.

Special Staining Methods in Microscopy, Relative to Animal Tissues and Cells.

4. THE SPECIFIC STAINING OF MAST-CELL NUCLEI.*

By Dr. P. G. Unna, Hamburg. Translated from the German by Geo. W. Cole, M. D., F. R. M. S. (London), St. Louis.

It may perhaps appear unnecessary, in our series of articles on staining technique, to make especial mention of the mast-cells. For, in spite of the increased interest of a negative sort which these have gained since the bacteriological era in our science, if one but looks to the histological text-books for references, it will be seen that the teachings of Ehrlich are always given as the only method of demonstrating the mast-cells. The latter still appears to suffice for all that could be desired as a differential stain. Ehrlich, as is known, stains slowly in acetic acid, or in acetic acid and glycerine, together with a weakened solution of the basic dye, dahlia. While the bleaching reaches all the parts of the tissues—the protoplasm, nuclei, intercellular substance—whereby the mast-

* Mast-cells are cells filled with basophile granules, found in the connective tissue and in foci of chronic inflammation.

cell nuclei are themselves more intensely charged with the coloring matter, and the cells themselves contained therein, and they appear isolated therefrom by their weakly-colored surroundings, it is then proven that, as the mast-cell nuclei are stained a clear reddish color, just in this proportion will the surrounding parts retain their color. Certainly this contributes much to make the mast-cells quickly and easily recognized under difficult circumstances. It is therefore not to be wondered at that those colors have been preferred which tend to produce metachromasia, especially methylene blue (red mast-cells) and saffronin (orange colored mast-cells.)

Thus the staining of the mast-cell nuclei takes place gradually by means of a metachromatic stain. Our entire energies are bent, however, in the production of the most available staining mixtures which render possible a differential staining of the tissues; and these staining mixtures, which have been given us by nature, are those which have usually been considered as simple colors; but those which, through the metachromasia of individual tissue elements show that they are actually color mixtures and contain valuable by-products, are mostly overlooked. Indeed it has appeared probable to me, through long use of the polychrome methylene blue solution, that this last contains by-products which produce the metachromasia (here methylene red). At the same time the colors more easily taken up bring forth the same elements, since their chief coloring matter (here methylene blue) is strengthened and are also necessary for the quantitative effect. If, for example, the cause of the stronger staining of the mast-cells with basic aniline coloring resided only in the attraction of the nuclei for basic stains, so would this necessarily appear in the decolorization of over-stained sections with various simple solutions (alcohol, glycerine). But it is well known that

only the decolorization with acids demonstrates the mast-cells with certainty and in an easy manner in over-stained sections. I therefore consider it more probable that the acids in the nuclei of the mast-cells fix an acid-coloring component (here methylene red) which, on its part, fixes the basic, chief coloring constituent (here methylene blue); and these acids, on this account, decolorize the remaining color constituents because they have not at the same time attracted the (acid) coloring constituents, such as methylene red.

While I have found the violet in methylene blue a valuable coloring material I have obtained as a by-product in some solutions, methylene red and my polychrome methylene blue solution (Grübler) present through this the most different varieties of protoplasm and, at the same time, the nuclei of mast-cells with a specific red color. This secondary effect of the polychrome methylene blue solution proves its value because it made the differential diagnosis of mast-cells (red) and plasma-cells (blue) a very easy matter. Both kinds of cells are usually easy to distinguish by other characteristics; but there are isolated ones in which the differential diagnosis cannot be easily made without this differential stain.

Wherein then is the advantage of this differential staining of mast-cells over that of the metachromatic methods which have been used heretofore? In the purity and absorption of color, so that no one can doubt whether a given nucleus belongs to a mast-cell or not. Only in the staining have we saturated red alongside of a saturated blue, while by methods of metachromasia heretofore used they were seen only occasionally, and accordingly well pronounced the stronger the entire section was stained. We have here, in each individual case, an intense and clear stain of mast-cell nuclei (red) with just as deep a staining of all the remaining tissues (partly

blue and partly violet). There especially does not exist any transition from red to violet, but rather a marked contrast made by both colors; never can a strong-overstained violet connective tissue cell be confounded with a red nucleated mast-cell. Above all there comes in here, in order to bring out this ideal staining of mast-cells, certain methods of bleaching which I will only indicate as I have thoroughly described them in my article on the staining of the protoplasm of connective tissue cells, namely: the decolorization by means of (1) glycerine-ether mixture and (2) neutral alcoholic orcein solution.

These have the particular advantage over the methods heretofore used, in that they coincide with the demonstration of the protoplasm (1 and 2) and collagen (2) in the tissues. We therefore use no other staining solution or method of staining, for in this way we always get the mast-cells stained in a most beautiful and precise manner when the necessary staining is made in regard to protoplasm and collagen. Naturally, these methods of decolorizing are not the only ones which are practiced on such sections as have been over-stained by means of the polychrome methylene blue solution. All acids and most salts cause the mast-cells, after treatment with alcohol, to appear more or less red, and the number of such methods is legion. But whoever desires to save time, and material will prefer this method above all others, as it brings out so many valuable details and requires so little time.

Yet, there are some cases in which a specific staining, according to the original method of Ehrlich, deserves the preference. There are certain cases in which we are concerned less with the examination of individual mast-cells than with the finding of all isolated mast-cell nuclei, whether it be that these, as in the different dermatoses (carcinoma, urticaria, pigmentosa) have entered into the

covering epithelium or have overrun the collagen tissue of the muscles of the skin. In such cases the nuclei naturally appear just so much clearer the more the remaining tissue is decolorized.

Such a demonstration of mast-cell nuclei can be very easily combined with the methylene blue staining method. Either color slowly in a weakened solution, or decolorize the over-stained sections in glycerine, ether solution or mineral acid. As a bleaching addition to the polychrome methylene blue solution alum has shown itself valuable. We put as much alum as can be held on the point of a knife in a saucer of staining solution and leave the sections therein for an hour or even over night. They are then, after a washing with water, put directly in absolute alcohol, oil and balsam. The nuclei themselves are very plain; the mast-cell nuclei are dark, cherry red, and the remaining tissue is pale blue. For demonstrating the isolated mast-cell nuclei in tissue there is no surer method than that by means of decolorizing with the above mentioned mixture of glycerine and ether. We allow the sections to remain in the undiluted mixture until they are of a clear blue color; then wash them in water and put them in alcohol, oil and balsam. One is always sure by this method of decolorizing to extract all the blue from the nuclei without damaging the red color. In the second place, we can take into consideration the mineral acids, and we have found the best to be nitric and hydrochloric. The section is first put in a five-per-cent nitrate of potash solution for from twenty to thirty seconds in a saucer, and then from ten to twenty seconds in a saucer with a few drops of acid alcohol; then in absolute alcohol, etc. Simple acid decolorization generally leaves still a faint trace of blue in the nuclei.

But at the same time that isolation of the mast-cell

nuclei by subsequent decolorization is accomplished all collagenous tissue and protoplasm are bleached, only the nuclei retain somewhat more of the blue than by the alum method. On the other hand, the red nuclei stand out so plainly that one cannot miss them even with a low power.

In the following list I give the methods in use in my laboratory for staining with polychrome methylene blue:

I.

Metachromatic Staining of Mast-Cells, especially in connection with Plasma Cells and Protoplasm.

(a) 1. Stain in polychrome methylene blue solution (Gruebler) from one-quarter hour to one night.

2. Decolorize in a mixture of a few drops of glycerine-ether solution in a saucer of water.

3. Thorough washing in water.

4. Absolute alcohol, oil of bergamot, and balsam.

(b) 1. Stain in polychrome methylene blue solution for from five to fifteen minutes.

2. Wash in water.

3. Decolorize and wash in one-quarter per cent of alcoholic neutral solution of orcein (Gruebler) about one-quarter hour.

4. Absolute alcohol, oil, balsam.

II.

Isolated Metachromatic Staining of Mast-Cells in very Weakly-Stained Tissue.

(a) 1. Staining in polychrome methylene blue solution with a knife point of alum in a saucer of coloring solution three hours to one night.

2. Wash in water.

3. Decolorize in glycerine-ether solution for from five to ten minutes.

4. Prolonged washing in water.

5. Absolute alcohol, oil and balsam.—*St. Louis Medical and Surgical Journal.*

EDITORIAL.

For Histology's Sake.—We notice that our good friend, Dr. V. A. Moore said at the meeting of the American Microscopical Society: "I believe in histology for histology's sake and in bacteriology for bacteriology's sake. Teach truth for truth's sake."

The atmosphere of Washington is full of this kind of talk and the idea animates much of our government work. We regard it as grossly pernicious. It leads to misappropriation of government funds and makes narrow minded specialists.

We have here a Fish Commission which during the past twenty-five years has expended some money in a practical manner but also much for "pure science"—they have studied fishes "for ichthyology's sake." The practical results attained could have been accomplished with a quarter of the money, and the Ichthyologists care little for the fishermen of the country.

We have here botanists who love botany simply for what truth they can find by its study and they never turn out practical results. We have astronomers who wish with government money to search comets and do such things as gratify insatiable curiosity but are of no consequence to the people at large. We have vivisectionists who cut up, after murdering, innocent animals in their pursuit of theories which they are pleased to call "pure science." They have no end in view except "anatomy's sake" or "bacteriology's sake."

The knowledge of many kinds of truth is today useless simply because there is no call for its practical application. Astronomical truths are of no account to Dr. Moore because he is not in a profession to apply them to the happiness or mental progress of mankind. If the pursuit for astronomy's sake is wise, it should make no difference to Dr. Moore whether he spends his time in it or in histology. In one case as in the other he gratifies his doctrine; truth for truth's sake.

There is a narrow line of research which he alludes to as the truth which has "use one can turn into dollars." Of course he who seeks only such truth as his fancy tells him will coin into money for his personal benefit, lives a narrow and selfish life. But he who studies histology utterly regardless of practical application, i. e., "for histology's sake" has placed himself at the opposite extreme, and lost all wisdom which in our days as in former times lies at the golden mean.

Were Dr. Moore to devote ten years to bacteriology solely for bacteriology's sake, let him tell us on what principles he would choose his experiments. All value or use humanitarian being dismissed from consideration why do one thing rather than another? He can only reply: "Do what bids fair to yield the largest increment to abstract knowledge." His time being thus absorbed in the abstract, humanity is suffering for the facts not covered by the scientist's ambition.

Such doings have caused the crusade by certain humanitarians against vivisection. We hold that all vivisection that has humanity's relief in view is proper and that only such is proper. Vivisection for truth's sake is simply barbarous.

Last winter we were so unfortunate as to have an anti-vivisection bill reported favorably in the United States Senate. It is likely to become a law. We have no one on the face of the earth to thank for this unwise and wholesale restriction except the people who like our friend want to vivisect for vivisection's sake, who want to take animal life not in search of truth which one can turn into health or dollars, but who want unlimited chance to cut and slash simply and solely "for truth's sake," simply to add isolated facts to our abstract knowledge of anatomy, of the use of drugs, of biology, of bacteriology, or of some other "ology."

In place of Dr. Moore's creed let him substitute this: "I believe in histology for humanity's sake and in bacteriology for humanity's sake, and in truth simply so far as it can contribute to the progress of the human race." There

is little research that he may properly wish to make that cannot be comprehended in this creed. There is truth the knowledge of which is a curse—not a blessing.

MICROSCOPICAL MANIPULATION.

Preparing Malarial Blood-Films.—The following method of preparing films of malarial blood will be appreciated by those who have practical experience of the ordinary methods of making cover-glass films. Besides ease and rapidity the method has other and obvious advantages.

A nurse is instructed to cleanse with spirits of wine or ether as many microscope slips as are likely to be required, and to place them, arranged in one or more rows, on the table near the patient. Three or four oblong slips of very fine clean tissue paper, one and one-half by five-eighths inch, are also prepared. The patient's finger is cleansed and pricked in the usual way. A droplet of blood about one-sixteenth inch in diameter is then expressed from the puncture and taken up, by touching it with one of the papers, the blood being supplied about one-half inch from the end of the paper. The charged surface of the paper is then placed upon a glass slip rather towards one end. In a second or two the blood will have run out in a thin film between paper and slip. When this has taken place—not before—the paper is drawn along the surface of the glass. The same paper, without recharging, is placed in a similar way on a second slip, on a third, on a fourth, and so on. When exhausted, the paper is recharged from the finger as many times as may be found necessary. In this way fifty or one hundred exquisitely fine films may be prepared in five or six minutes. Labels are then attached, and the slides stored away to await convenience. Before proceeding to stain, the blood is fixed in a little absolute alcohol on the films. The slides are then dried, and stained by the borax (five per cent.) methylene blue (one-half per cent.), a few drops of the solution being applied for about half a minute. After washing and drying, cover-glass

with xylol balsam are applied. The result is excellent. If one wishes to search for crescents, a good plan is to make the film fairly thick, to fix with alcohol, and then to wash out the hæmoglobin with very weak acetic acid, two or three drops to the ounce of water. The now colorless film is again washed, stained with methylene blue, and mounted in xylol balsam in the usual way. The field not being obscured by blood-corpuscles, the large amount of blood which this method of preparation enables us to pass rapidly in review greatly favors the quick finding of any crescents that may be present. The same method of preparing blood films is equally applicable for the demonstration of other blood parasites.—British Medical Journal.

Preservation of Microscopic Specimens.—Tores describes a method, which he has tested for a year and a half, of preserving organs and tissues so that they retain the color they had when fresh. He finds that five to ten parts of a forty-per-cent. solution of formalin alone cause the organs after a time to assume a tint which differs very considerably from the natural color, but that if, instead of water for diluting the commercial formalin solution, a solution of one part common salt, two parts of magnesium sulphate, two parts sodium sulphate in one hundred parts of water be used, the color of the blood is well preserved. Further, material preserved in such a solution is better adapted for subsequent microscopic examination, since the protoplasm of the cell is less altered and the nucleus stains better and more deeply. The method he adopts is as follows: The material must be not too long washed in water, and should be left in the formalin solution for a period depending upon their size and thickness. A kidney or spleen requires two days immersion, and the solution should be changed once or twice, or until the formalin solution no longer gives a dirty brownish-red color. Care must be taken to bring all portions of the object into contact with the solution, and the object must be given the shade which it is to retain permanently, since the formalin solution causes it to assume a consistency such

that its shape cannot afterwards be modified. In the formalin solution the organs change color and become of a dirty bluish gray. On now placing them in ninety-five per cent. alcohol the normal color returns. Before permanently placing the organ in alcohol it must be washed with alcohol until the latter no longer becomes cloudy.

The material must not be washed with water; it is left in alcohol for varying time until the normal color has again fully returned; if left longer the alcohol removes the color. For a kidney or spleen twenty-four hours will be sufficient. The permanent preserving fluid is equal parts of glycerin and water; the material floats at first, but sinks later; the color is now at its best; after a little time the fluid becomes yellowish and requires renewal. Tissues so preserved have not undergone the slightest alteration in color during nine months. The method is not applicable to the preservation of other color than that of blood; thus icteric liver is well shown.—*Int. Med. Magazine.*

Microscopic Objects.—Thin sections of hard substances are made by cementing them to glass with Canada balsam, or on an oil-stone with water, then softening the cement with heat, and turning them over and treating the other side in the same way. They are then polished, if desired, with putty-powder on silk, cloth, or leather.—*English Mechanic.*

Urinary Examinations.—Dr. Lichty (*Medical News*) holds that: 1. A continued low specific gravity must be looked upon with grave suspicion, until it can be proved beyond a doubt that the kidneys are normal. 2. In nephritis, especially of the chronic interstitial type, it may happen that at times during the greater part of the disease the urine may contain no albumen that can be detected. 3. Casts may be present in the urine when it is impossible to detect any albumen by the usual tests. 4. Casts are very easily destroyed in the urine by bacteria during the process of fermentation, and unless the examination is made within an hour or two after the urine is passed, the failure to find casts does not prove the non-existence

of nephritis. The urine should be more frequently examined, especially after sickness.

BACTERIOLOGY.

Black Death.—Kitasato has ascertained that the "black death" is due to a bacillus which causes a septicæmia attacking the lymphatic system, the spleen, and might therefore easily be confounded with anthrax. The bacillus is rounded at the ends, colors with the usual aniline dyes, more deeply stains at the end than in the middle; may be found in the blood, occurs in man, mice, rats and swine, and may be contracted by eating the diseased flesh of such animals.

Excretion of Micro-Organism.—Biedl and R. Kruas record their experiments into the excretion of micro-organism by the glandular organs. Previously they have shown that micro organisms present in the blood are excreted by normal kidneys, the urine being free from albumen or blood. They thus conclude that micro-organisms can pass through healthy blood vessels. They have now investigated the functions of the liver and submaxillary gland in this respect, cultures of the staphylococcus being injected into the blood. Almost all authors agree that the liver can excrete micro-organisms, but no certainty exists as to the manner of the excretion. In the first set of experiments the gall bladder was opened with the usual precautions immediately after death. They found negative results in two out of four experiments, but this method is not adequate. In another series of experiments the bile was inoculated directly into the nutrient media, a cannula having been placed in the bile passages. In the case of the submaxillary gland a cannula was placed in the duct, and the same method followed. In all of the three cases the staphylococcus was obtained from the bile, but the results were always negative in five cases where the submaxillary secretion was investigated. The micro-organisms were shown to be cautiously excreted in the bile

during one and a half to two hours while the experiment lasted. The authors conclude that as in the case of the kidneys the excretion of micro-organisms is a formal function of the liver. During one to two hours micro-organisms circulating in the blood were, however, not excreted by the submaxillary gland. Whether the difference thus present between the liver and the submaxillary gland. is due to the difference in their structure is left an open question.—Medical Review.

MEDICAL MICROSCOPY.

Antitoxin Serum in Smallpox.—M. and A. Bechlere communicated to the Academy of Medicine, Paris, the result of observations made by them, which indicate the probability that they have discovered a means of successfully treating smallpox by an antitoxic serum. The serum is obtained from the blood of vaccinated animals, and is used in the same manner as the antitoxic serum which is employed in the treatment of diphtheria.

The Action of Tricresol on some Pathogenic Microbes.
—The *Presse medicale* for October 3d contains an abstract of an article by Dr. O. Bronstein, which was published in the *Meditszinskoie Obozrenie*, 1896, No. 7. The experimental researches of the author concerning the action of tricresol were carried out on the following bacterial varieties: The staphylococcus, the streptococcus, Eberth's bacillus, the comma bacillus, the comma bacillus of cholera, and the bacillus of glanders. The result of his experiments showed that a solution of tricresol in the proportion of one in a thousand, acting for two or three days, had a bacterial action on all these organisms except the pyocyanic bacillus. In order to kill the streptococcus a solution of one in two thousand was sufficient, and to destroy the diphtheria bacillus, a solution of one in two thousand five hundred. A one-per-cent. solution killed the typhoid bacillus, the staphylococcus, and the streptococcus in five minutes; the bacillus of cholera, glanders, and of diphtheria in three

minutes, and the pyocyanic bacillus in ten minutes. The non-bactericidal solutions, however, hindered the culture of bacteria. The author thinks that tricresol is a very powerful antiseptic, since a one-per-cent. solution is as energetic as a three-per-cent. solution of carbolic acid. It is at the same time relatively less dangerous, for according to Hammerl, the toxicity of carbolic acid is four times as great as that of tricresol.—*N. Y. Medical Journal*.

The Dirty Sponge.—Professor Lang, of Vienna, declares that sponges, owing to the impossibility of destroying germs in them, have long since been banished from the surgeon's table, and should also be excluded from the bathroom and washstand.

Possibilities of Contagion from Venereal Diseases in Railway Cars.—Dr. Tomas Noriega, of the State of Chiapas, Mexico, read a paper before the American Public Health Association, in which he cited the case of a married man, thirty years of age, who arose from his berth in a Pullman car and, as was his custom, wash his face in the lavatory. Two days thereafter he felt the first symptoms of purulent ophthalmia, for which he consulted a physician. The patient was treated energetically, but in spite of all efforts the right eye was lost. Other similar cases were reported.

Tuberculosis and Telephone.—It is said that Vienna physicians have traced cases of tuberculosis and other contagious diseases to the use of public telephones, and the suggestion is made that a sponge with a solution of carbolic acid be kept in every station for a daily cleaning of the apparatus.

MICROSCOPICAL SOCIETIES.

Microscopical Societies.

Postal Club.—After the usual summer vacation, the circulation is now being resumed. Any changes of address, or other business concerning the membership or circuits, should be reported at once.

Last season the work done by and for the members was of at least average amount and quality; and, with the careful and generous assistance of all, it is hoped to attain still better results.

Owing to the retirement of many circuit boxes, which are no longer available except for new circuits, a new set is needed for immediate use, and collecting boxes will be started at once. As the success of the present season will depend largely on the use of these contributions, members are kindly requested to have the slides selected, and their notes ready to copy into the Note-books on arrival, so that the boxes can go forward without delay. Slides without ideas in them, or accompanying notes, are of little use. Members not wholly familiar with the subject are requested to consult carefully all the suggestions in the circular on Contribution of Slides on page 3 of the Report of the Club last published, in 1895.

Members whose subscription is not fully paid, will greatly oblige by remitting for present use, to the President, R. H. Ward, M. D., 53 Fourth St., Troy, N. Y.

MICROSCOPICAL NOTES.

French Congress of Medicine.—French Congress of Medicine will be held at Montpellier in 1898, during the Easter holidays, under the Presidency of Prof. Bernheim, of Nancy. The annual Congress of French Alienists and Neurologists will be held at Toulouse in 1897.

Hayden Memorial Geological Fund.—Mrs. Emma W. Hayden has given to the Academy of Natural Sciences of Philadelphia, in trust, the sum of \$2,500 to be known as the Hayden Memorial Geological Fund in commemoration of her husband, the late Prof. Ferdinand V. Hayden, M. D., L.L. D. According to the terms of the trust, a bronze medal and the balance of the interest arising from the fund are to be awarded annually for the best publication, exploration, discovery or research in the sciences of geology and paleontology, or in such particular branches there-

of as may be designated. The award and all matters connected therewith are to be determined by a committee to be selected in an appropriate manner by the Academy. The recognition is not confined to naturalists.

Prof. Moissan.—Prof. Henri Moissan, the well-known chemist, who fills the chair of toxicology in the Paris school of Pharmacy, arrived in this country September 20th. He comes to represent the University of France at the celebration of the 150th anniversary of Princeton College, October 20th.

PERSONALS.

A building 25x97 feet for the Massachusetts General Hospital, Boston, at a cost of over \$20,000, will soon be ready for use. It includes well fitted laboratories of chemistry, bacteriology and histology.

The next meeting of the American Association for the Advancement of Science will be held in Detroit (1897). Dr. Wolcott Gibbs of Newport, is the new president.

The proceedings of the Academy of Natural Sciences of Philadelphia, contains the biographical sketch of John Adam Ryder, by Harrison Allen, M. D., and the list of his published scientific papers by H. F. Moore, Ph. D.

The officers of Section G. of the A. A. A. S. for the next year are G. F. Atkinson, Vice-President; F. C. Newcombe, Secretary.

The officers of the Botanical Club for the next year are S. M. Tracy, President; L. R. Jones, Vice-President; E. S. Burgess, Secretary.

Professor A. N. Prentiss, formerly professor of Botany at Cornell University died at his home in Ithaca, Aug. 14.

A Post Graduate course of bacteriology has been established at the Sidney University, N. S. W.

CORRESPONDENCE.

THE MICROSCOPICAL PUB. CO., Gentlemen:—All of our subscriptions were placed through a subscription agency, and we suppose yours was included among the others.

The agency has recently failed and thrown our subscription account into considerable confusion. As soon as the affairs are straightened out I will see that your account is made right. Yours most cordially, C. B. T.

We shall not comment on this letter, we shall simply repeat our advice: Send your subscription directly to the Microscopical Pub. Co., Washington, D.C. or if you choose to have an agent, take one of the old and reputable publishers.

RECENT PUBLICATIONS.

Ernst Mach's Popular Scientific Lectures.—The Open Court Publishing Co., Chicago, have just issued in their Religion of Science Library a cheap edition of Professor Mach's Popular Scientific Lectures, which were remarkably well received on their first appearance. Professor Mach was formerly Professor of Physics in Prague, but has recently been called to a chair of philosophy in Vienna.

The Keating Wheel Co., Holyoke, Mass., is just now sending out a beautiful art catalogue containing a complete description of their bicycles. It will be sent free to any subscriber of this paper who shall send a postal card to the above address.

Die Mikrotechnik der thierischen Morphologie. Eine kritische Darstellung der mikroskopischen Untersuchungsmethoden. Von Dr. Med. STEFAN APATHY, Professor der Zoologie und vergleichenden Anatomie an der Universitat Kolozsvar. Erste Abtheilung. Mit 10 Abbildungen in Holzschnitt. Braunschweig: Harald Bruhn, 1896 (New York: Gustav E. Stechert). Pp. 322.

AN exhaustive and critical review of this important work

is almost impossible within the limits of a journal. The work is so stupendous and opens up such a vast field of study and observation that a mere mention of its scope must suffice.

The author gives, in the first place, a minute historical survey of every method intended for the microscopic study of animal tissues. This is followed by a discussion as to the purpose of each method and of its worth at the present day. An exact description of each procedure, with reference to the effect of the agents used upon the chemical and physical properties of the object to be examined, is next brought to view. This is followed in turn by a consideration of the changes produced in specimens by certain agents employed, with reference to an improvement or a possible improvement in the technics.

The special part of the work is arranged under fourteen heads, and the entire process, from the securing of the specimen to its ultimate disposition, cut, stained, and mounted, is minutely described. Free criticism of methods of technics abound, with suggestions for improvement. Volume I closes with a critical bibliography of the various methods now and formerly in vogue for the examination of microscopic specimens, arranged alphabetically and with marginal dates.

This book is no text-book. It will if its author's intentions do not miscarry, be the foundation of microscopic technics which shall be based on a thorough understanding of methods employed, their purpose, their history, and their real value. With the addition of the second volume, which is promised within a year, we are certain of a work that will be indispensable to the student, the biologist, the histologist, and the worker with the microscope, whoever he may be.

Typhoid Germs in Ice.—The military officers at Rennes (Medical Press and Circular) have recently suffered from a typhoid epidemic, which has been traced to the ice which was used to cool the champagne at a banquet. The ice had been taken from a neighboring river at a point where the town sewers empty.

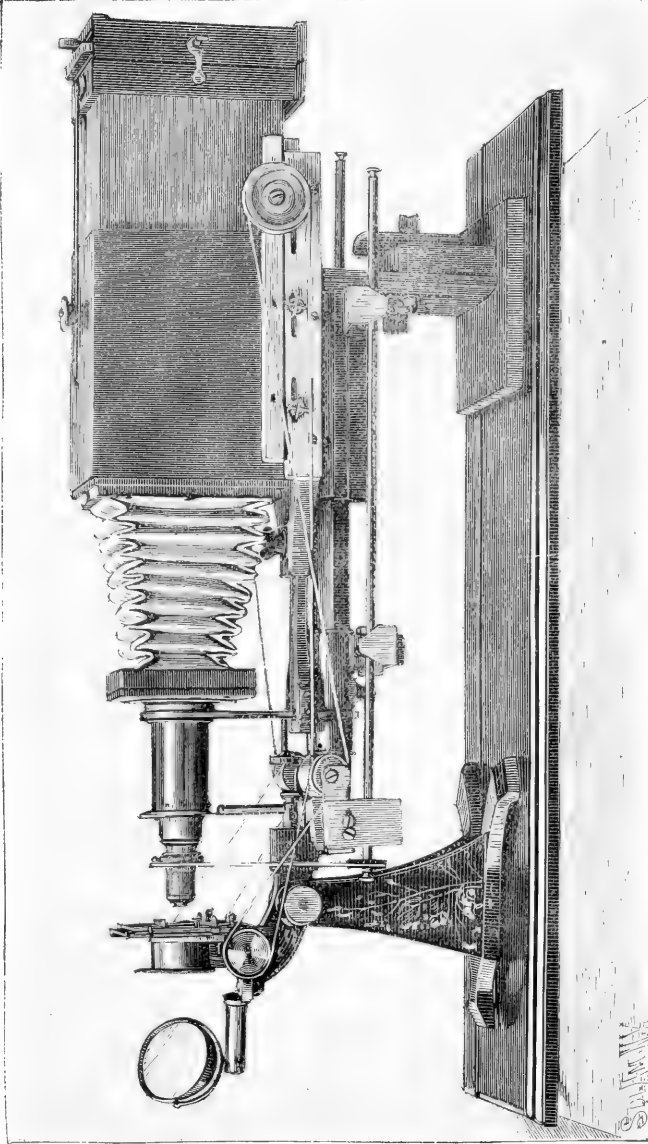

PHOTO-MICROGRAPHIC APPARATUS

SWANSON

THE AMERICAN

MONTHLY

MICROSCOPICAL JOURNAL.

VOL. XVII.

NOVEMBER, 1896.

No. 11

Camera for Producing Enlarged Images of Microscopic Objects.*

WITH FRONTISPIECE.

Owing to the improvements in microscope objectives and in photography, it is practicable to produce magnified photographic images of microscopical objects which are not only interesting to the microscopist, but are also of importance to the pathologist and histologist in making a record.

We illustrate photo-micrographic apparatus recently completed by Mr. O. G. Mason, microscopist of Bellevue Hospital, and for many years secretary of the American Microscopical Society.

This apparatus will receive an objective of any power and produces images on a $3\frac{1}{2}$ by $4\frac{1}{2}$ plate. The apparatus is very compact, being only about two feet in length. It is all mounted on a single base board, so that it may be removed bodily if it becomes necessary to shift its position.

The camera box is rigidly attached to the standard of a microscope of the usual form, so that the box can be placed horizontally or inclined at any desired angle. Adjustments are made which provide for any required distance between the objective and the sensitive plate, so that the desired amplification may be readily secured.

Cut kindly loaned by Editors of Scientific American.

The mechanical stage is operated by the small chains which extend along the sides of the frame of the apparatus, and the rotation of the objective, polariscope, etc., and the focusing are effected by rods extended toward the rear of the camera box. With these adjustments the operator seated at the camera can manipulate the instrument for focusing or searching the field for any particular object.

The instrument has been used for making negatives showing objects with a magnification of 15,000 times. All the parts are made adjustable for wear and atmospheric changes and for adaptation to various classes of work.

This photomicrographic apparatus forms an important part of the equipment of the laboratory of microscopy of Bellevue Hospital.

Address of Welcome to the American Microscopical Society
Upon its Assembling in Carnegie Library Pittsburg,
Pa., August 18, 1896.

BY REV. W. J. HOLLAND.

Chancellor of the Western University of Pa.

PITTSBURG, PA.

It is a very great pleasure to me on behalf of the local scientific societies and the citizens of this town to extend to you on this occasion a most cordial welcome. Hospitality, as you all know, is an ancient grace and virtue, and I have heard it said by Pittsburgers that they excel in this virtue, and I, in fact, have heard others that have been in Pittsburg venture to intimate that the claim is just. There have been some historic interruptions to the hospitalities shown by Pittsburgers, notably when General Braddock kept the Indians on the other side of the Monongahela River during the French and Indian War.

But away back in the days when Queen Aliquippa entertained George Washington, running down to the present time, there has been a courtesy shown to the strangers, save and except when Captain William Trent, about 1772, acted rudely to the Indians who were rude to the Englishman, General Braddock. But these are all facts known to history, and the people of the present day may be relied on to accord to you in their homes and in all the relations you may meet them a hospitality that will be personal. I welcome you as representatives of the learned of the nineteenth century. It is said of the most famous of the ancient Hebrew kings, accounted the wisest of his day, that "he spoke of trees from the cedar which is in Lebanon to the hyssop which springeth from the wall; he spoke also of beasts, creeping things (reptiles) and fishes." From this you will observe that King Solomon's knowledge was confined in botany to the phenogams and that his knowledge of histology extended no further than to the lower vertebrates. He knew nothing of spores and bacteria; all the wonders of mycetology and cryptogamic life were hidden from him. He knew nothing of the protozoa and the myriad forms of microscopic life with which you are familiar, representing the wonderful advancement of modern science achieved through the microscope. I welcome you as those who are wiser than Solomon, and who know more than the ancients, and trust from intercourse with you to add to the stores of knowledge. I welcome you as friends of humanity. People sometimes wonder why men should spend their time investigating mere minute organisms, spending months and hundreds of dollars. From the peculiarly economic standpoint, the investigator himself reaps very little return in fame or wealth, but the pathway is broadened and made plain to discoveries which enrich the world. You are a representatives of those who with the microscope have carried our knowledge downward into

the deep, while the astronomer gazing upward has made his way. Nature is most to be admired in things that are least known.

I welcome you to this ancient city, the city of industries in which you will find anything that you wish to see, from a beautiful spectroscope, perfect in all its adjustments, to the grosser parts of such a mechanism as the man-of-war; where we make anything from a tack to a locomotive or an ocean steamer. I welcome you to a city in which we have something more than industries. Standing on the companionway of a steamer a few days ago, I overheard a young lady say, "Where are those people from?" Her escort replied, "From Pittsburg." She said, "Where they have nothing but smoke and money." We have a great deal of smoke at times and there is a little money to be picked up in odd nooks and corners, I am told by some. But we have other things. This beautiful building, the gift of one of our citizens, the home of art and science; the extensive park and conservatory. We have schools, colleges, hospitals and churches and learned societies and all those things that go to make the city a desirable place of residence in spite of its smoke. We have something better—a disposition to grow in knowledge and to make advancement in all lines open to us.

In the name of my fellow-citizens and the Iron City Microscopical Society I extend to you all a most hearty welcome.

Rhizopods, the Lowest Forms of Life.

BY ARTHUR M. EDWARDS, M. D.

NEWARK, N. J.

Dr. Carpenter says, "it is a tendency common to all observers, and not by any means peculiar to microscopists, to describe what they believe and infer rather than

what they actually witness." That is to say we see a thing, therefore, it is, without reasoning at all about it. This is a common mode of stating a thing, but when we reason we know and what we know we state, with a query.

Rhizopods are minute specks of protoplasm, rarely just visible to the eye, though some are invisible and it requires the highest power and the nicest manipulation to even see them at all. They are seen everywhere and at every season and in all the rocks. For they are and were the "physical basis of life" as Huxley tersely put it.

I shall use for my text Dr. Joseph Leidy's Fresh-water Rhizopods of North America, as that gives graphic and late researches on the minute and beautiful organisms which I am about to describe. Dr. Leidy quotes Dr. Carpenter's remarks which I have given above. But as I have said this quality is common to every one. We think we see and therefore do not trouble ourselves to reason about things that are going on around us. We are selfish. It is much easier to say what we think we see than what we do see. It is easy to repeat what is told us without taking the trouble to find things out for ourselves. From the first comes the general run of men. From the second comes the doubter and the agnostic, the enquirer. By far the minority. But as in all things, the minority rules and time shows what is the true way of viewing things. The simplest kinds of Rhizopods are unprovided with a protection to their soft part. They are in fact formless masses of Protoplasm. And this protoplasm is exactly the same in plants, protista, and animals. The motile jelly of the Rhizopod is thought to be of the nature of the elementary basis of organic bodies in general. It is known as protoplasm, from the Greek signifying first and I mould: That is to say the primitive material from which organic bodies are moulded. Its resemblance in motile power to muscular tissue, or the

flesh of more complex animals, led the French naturalist, who was the first to indicate the true nature of the Rhizopods, to give it the name of sarcode, from the Greek signifying flesh and form. But I think it can not be too strongly impressed on the minds of the readers that the sarcode of the Rhizopods and the protoplasm of all living things not only look like but are the same thing. Dr. Carpenter says "if the views which I have expressed as to the nature and relations of their living substance be correct, that substance does not present such differentiation as is necessary to constitute what is commonly understood as organization" even of the lowest degree and simplest kind; so that the physiologist has here a case in which those vital operations which he is accustomed to see carried on by an elaborate apparatus, are performed without any special instruments whatever—a little particle of apparently homogeneous jelly changing itself into a greater variety of forms than the fabled Proteus, laying hold of its food without members, swallowing without a mouth, digesting it without a stomach, appropriating its nutritious material without absorbent vessels or a circulating system moving from place to place without muscles, feeling (if it has any power to do so) without nerves, propagating itself without genital apparatus,—and not only this, but in many instances forming shelly coverings of a symmetry and complexity not surpassed by those of any testaceous animals."

The Rhizopod moves by protruding some of its protoplasm about by means of portions which are known as pseudopods from the Greek signifying false feet, for they take the place of feet. These pseudopods are extremely delicate. They often branch and assume a more or less move-like appearance, whence Dujardin gave them the name of Rhizopods. As Dr. Leidy says "It appears from the researches, especially of British authorities, such as

Carpenter, Williamson, Wallich, Brady, Parker and Jones that the members of the class are infinitely variable, and that indeed no absolute distinctions of species and genera exist, such as appear more definitely to characterize the higher forms of animal life. My own investigations rather confirm this view, and, under the circumstances, we can only regard the more conspicuous and prevailing forms as so many nominal species, in likeness with the species of higher organic forms, more or less intimately related, and by intermediate forms or varieties merging into one another. So that in them species do not exist—only forms, and so it is with the larger forms of animal and vegetable life. Species, as they are called, change and from what we know of ancient life on the earth it began with Rhizopods such as now exist and grew up more and more complex until we have man.

Bacteriology of the Normal Conjunctiva.*

BY CHARLES J. FOOTE, M. D.

NEW HAVEN, CONN.

The object of reporting the few bacteriological experiments which are recorded below will be better understood if they are taken in connection with and as supplementary to the paper of Dr. Wilson.

Our purpose in making the experiments was, if possible, to throw some light on the causes of suppuration after cataract extraction.

Our method of examination consisted in smearing over the surface of a slant tube of agar a particle of conjunctival secretion which had been removed with a sterilized cotton swab or a loop of platinum wire.

Agar was used as a culture medium, because we desired to study only those bacteria which grow at 37° C.

*Read before the section on ophthalmology of the New York Academy of Medicine, October 21, 1895.

After sowing the agar tubes they were kept in the incubator for several days at a temperature of 37° C. According to this method ninety-two eyes were examined, one tube culture being made from each eye. Of these ninety-two tubes, fifty-three showed one or more colonies of bacteria, while the rest of the tubes (thirty-nine) were sterile. By this I do not mean to imply that the conjunctivæ of the thirty-nine eyes were sterile, but only that such small portion of the secretion as was removed by the platinum loop was sterile. In the fifty-three tubes containing bacteria, some eight or ten different kinds of bacteria were found. In twenty-two cases the staphylococcus epidermidis albus was present; in five pyogenes citreus; in one case pyogenes aureus; in one case the bacillus subtilis; in eight cases a large bacillus growing with small delicate translucent colonies on agar, kind not identified; in one case streptococcus pyogenes. The sources from which these bacteria infected the conjunctivæ may perhaps be named as follows in the order of importance:

1st. The edges of the lids and the mouths of the Meibomian glands.

2d. Unclean hands.

3d. The air.

4th. Infected nasal fossæ.

In the case of the normal conjunctiva the last is probably not an important source of infection, since the current of secretion is constantly downward into the nose. Bach, after injecting cultures of bacteria into the nasal fossæ, was unable to find that they ever made their way into the conjunctival sac.

On the many kinds of bacteria (twenty-six species) which have been found in the normal conjunctiva, only three have been proved to be pathogenic to man. These are the staphylococcus pyogenes aureus, the staphylococcus albus, and the streptococcus pyogenes. It is

obvious that the mere presence of even these in the normal conjunctiva does no harm. A bouillon culture of the staphylococcus aureus has been dropped into the conjunctival sac of man without producing inflammation (Bach), and even in injured eyes these bacteria often seem to do no harm, as may be seen from some later experiments in which the staphylococcus aureus was found in considerable numbers in the dressings of eyes which had been operated on for cataract and yet no suppuration occurred after the operation. But in spite of these facts it is well to remember that a purulent infiltration of the cornea and panophthalmitis result when the staphylococcus aureus is inoculated upon the surface of the cornea of a rabbit with an instrument infected with the staphylococcus aureus, panophthalmitis develops in thirty hours. The same result occurs also at the end of seventy-two hours even with the staphylococcus albus. Moreover, in man the staphylococcus aureus and albus seem to play an important part in many disastrous processes occurring in the eye. Thus, the aureus seems to be a very important if not the sole factor in many cases of panophthalmitis and phlyctenular conjunctivitis.

These two series of facts illustrating the harmfulness and harmlessness of the staphylococcus aureus and albus can be harmonized only by referring them to a varying vitality of tissues in different patients or to a varying virulence of the bacteria.

Next an attempt was made to determine whether age influenced the kind and number of bacteria in the conjunctiva. For this purpose the eyes of twenty old people, ten children, and forty-six young adults were examined. Thirty-three per cent of the tubes from young adults were sterile; thirty per cent of the tubes from old people were sterile; fifty per cent of the tubes from children were sterile. The percentage of sterile tubes from adults and old people was about the same

while there seemed to be somewhat less infection in children's eyes.

Cultures were also made from the conjunctiva as soon as possible after rising in the morning and again at evening. The eyes of eighteen persons were examined in the morning soon after rising and the same eyes were examined again at night. In this way it was found that of the morning tubes only two were sterile, while of the night tubes nine were sterile. It would seem probable, then, that the natural cleansing of the eye by the lachrymal secretion is more efficient during waking hours. An attempt was then made to sterilize the eyes of six patients. The process of sterilization consisted merely in washing the eye, in three cases with boric acid (one drachm to one ounce) and in three other cases with bichloride of mercury, 1 to 5,000.

After cleansing, the eyes were bandaged with sterilized cotton for twenty-four hours. The bandages were then taken off and cultures made from the conjunctivæ.

Of the three eyes washed with boric acid, all tubes showed colonies which were nearly all of the staphylococcus albus. Of the tubes obtained from those eyes washed with bichloride, one was sterile and the other two infected. The colonies present in these cases were also of the staphylococcus albus. Thus, in an attempt to sterilize the conjunctivæ in six cases, only one case proved successful.

Inasmuch as a certain proportion of tubes remain sterile after inoculation from the normal conjunctiva without sterilization, it seems doubtful whether the attempted sterilization was of any value at all. Bach's results were somewhat more favorable than mine, he rendering sixteen cases sterile out of forty-two attempts. Washing the conjunctiva cannot be depended on as a means of sterilization. A boric-acid washing probably has no more value than washing with sterilized salt solution.

The process is merely a mechanical cleansing, and not a sterilization with a germicidal fluid. Inasmuch as the orifices of the Meibomian glands and the edges of the lids are fruitful sources of infection to the conjunctivæ, these especially should receive a cleansing either mechanical or germicidal before an operation.

Dressings over the eye furnish the necessary heat and moisture for bacterial growth. To determine how far an aseptic dressing placed over the eye affords a good breeding-place for bacteria, twenty dressings were examined. Nine of these came from eyes that had been operated on and eleven from eyes that had not been operated on, but had been merely bandaged with sterilized dressings for twenty-four hours. All of these dressings contained large numbers of bacteria. Those in the dressings from the operated eyes differed little in respect to the number and kind of bacteria from those in the non-operated eyes. The staphylococcus albus was present in thirteen dressings in large numbers, and in four of the dressings the aureus was also found in considerable numbers, yet in none of the operated eyes was there any suppuration after the operation. The aureus was present in three of the bandages from operated eyes and in one of the bandages from non-operated eyes.

Aseptic dressings should be applied only where the wound or area of application is aseptic. Antiseptic dressings would seem better to use over the eyes, as the dressings are applied to an infected area.

Incidentally, while making these examinations, cultures were also made from six cases of phlyctenular conjunctivitis, three cases of catarrhal conjunctivitis, and four cases of ulcerative keratitis. Three tubes from the cases of phlyctenular conjunctivitis were sterile, possibly because the cases were in the later stages of the disease. The three remaining tubes gave pure cultures of the staphylococcus aureus.

Of the cases of catarrhal conjunctivitis, one showed a few bacilli of a kind not identified, one was sterile, and one gave a culture of Fraenkel's diplococcus.

Of the four cases of ulcerative keratitis, tubes from three were sterile. Cultures of the staphylococcus albus developed in the remaining one.—*Medical Record*.

Some Aqueous Media for Preserving Algae for Class Material.

W. A. SETCHELL, AND W. J. V. OSTERHOUT,

BERKELEY, CAL., AND PROVIDENCE, R. I.

There are ordinarily two difficulties in the way of introducing a careful study of the various marine and fresh water algae into a course in cryptogamic botany. The first of these is the obtaining of the material, and the second is preserving the material which may be obtained in such a fashion that it can be placed before the student in a condition to be readily examined and studied with nearly as satisfactory results as those afforded by the fresh material of the same forms.

The first difficulty can be overcome more or less readily. Fresh water species are more or less abundant in our ponds, brooks and rivers, and the increasing facility of access to the sea brings the marine forms within the reach of many. Especially do the facilities offered by the marine laboratories, such as those at Cold Spring Harbor, N. Y., at Woods Holl, Mass., and at Pacific Grove, Cal., afford an opportunity for the teacher of botany not only to become acquainted with the algal forms and their use in the class room, but also to obtain and preserve a good supply of desirable species in the very best condition possible. Under the auspices of the Marine Biological Laboratory at Woods Holl, a department of Laboratory Supply has been in successful operation for several years, and from it all necessary botanical mater-

ial may be very satisfactorily and economically obtained.

The old method of preserving in strong alcohol shrivelled the specimens to such an extent that the use of strong swelling reagents (alkalies or acids) was necessary to show anything like the proper degree of detail of structure, and while these methods were good for the ordinary tougher species, and when applied by students of some experience, yet they were very unsatisfactory when applied to the more delicate forms or when used by the more inexperienced manipulators.

The use of the weaker alcohol, 50-70 per cent according to the particular specimen to be preserved, was better yet proved decidedly unsatisfactory for the more delicate forms.

The ordinary English method of fixing in a saturated solution of picric acid and preserving in strong alcohol is a very good one, especially for specimens to be imbedded in paraffin or for special work in connection with particular problems. Better still is fixing in some special solution such as a saturated solution of picric acid, 0.5-1 per cent chromic acid, Perenyi's fluid, Hermann's mixture, etc., and transferring through the ordinary grades of alcohol, or by dialysis, up to 70 per cent strength and preserving in that.

Such material is in excellent condition for imbedding in paraffin or celloidin, but for the ordinary class work, for manipulation by the student himself, the specimens must generally be transferred again to water.

But the preparation by these methods of material for a large class is often a considerable task. The more delicate forms too are seldom in a thoroughly satisfactory condition.

It has been found to facilitate the class-work on all the cryptogams very much to use freezing methods in the preparation of sections for the class, and either to have

the sections cut by an assistant or by different members of the class at different times. A description of a convenient freezing device and methods of imbedding in aqueous media will be published by one of us in the next number of this journal.

Freezing methods and the preservation of natural form and size of the different parts with as little change as possible have rendered it very desirable that aqueous media be employed if possible for preserving fluids.

A number of fluids have been subject to experiment by the writers for about three years, particularly upon the abundant materials of all groups of algæ obtained at the Marine Biological Laboratory at Woods Holl, Mass. It is thought by the writers that these notes of their experience, while containing nothing especially new, may serve as useful hints to those who have before them the problem of providing and preserving cryptogams for laboratory purposes.

CHROME ALUM.—This substance was used by Guignard for fixing various Laminariaceæ for the purpose of investigating the structure and development of the mucilage ducts. Later it has been tested at the Biological Station at Helgoland by Lotsy upon the red algæ particularly as to the preservation of the cell-structure.

The writers have used one per cent chrome alum in either distilled water or sea water carefully filtered through sand, according to the different habitat, for about four years. The algæ, carefully selected and washed free from dirt and debris, have been placed in it at once and preserved in it until needed for examination. The cell structure is well preserved in all cases. Very little washing is needed afterwards to allow staining by any of the ordinary staining reagents. Gelatinous intercellular substances, whether soft or more cartilaginous, are rendered firm but not especially opaque by treatment with it. Cyanophyceæ, Chlorophyceæ, and Rhodophy-

ceæ do very well indeed. Phæophyceæ, almost without exception, are rendered brittle in a short time, but while this renders them troublesome to manage, yet specimens prepared in this way and soaked out in water are excellent for study by crushing methods. It is the intercellular substance that is rendered brittle and such forms as species of *Leathesia*, *Mesogloia*, *Laminaria*, etc., when crushed, spread out and show the cell structure and cell arrangement in a very satisfactory fashion. The color is not retained perfectly, but is ordinarily retained more than by any other of the media we have tried.

The Chlorophyceæ lose all of their green, or nearly all. The Cyanophyceæ and Rhodophyceæ often retain considerable (especially if kept away from the light), generally at least enough to assist materially in the examination of the chromatophores, while the Phæophyceæ lose very little of their intensity. Specimens preserved in chrome alum must be kept in glass-stoppered jars, carefully closed, as the solution is liable to become invaded by various molds. A little finely divided camphor-gum at the top will prevent this, as will also a small quantity of formalin. Chrome alum solution has a certain corrosive action upon metals; so that metal tops to the preserving jars should be avoided, and specimens to be sectioned free-hand or with the freezing microtome methods, should have at least the greater part of the alum removed by washing.

One per cent chrome alum is also an excellent preserving fluid for use with fungi of the various groups, for the mosses, for ferns and for flowering plants, better in all cases than the strong alcohol commonly used, but probably not superior to the various percentages of formalin, except in the case of gelatinous forms. *Spirogyra* cells keep well in 1 per cent chrome alum, the chromatophores, pyrenoids, nuclei and protoplasmic sac and threads showing very well indeed. Specimens kept in a

cork-stoppered bottle in chrome alum showed a very distinct dark steel-blue stain affecting the nucleolus most, the nucleus and the chromatophores; and this remained after washing in water, dehydrating, and mounting in Canada balsam.

With chrome alum, as well as all other preserving media, a fairly large proportion of fluid should be used.

FORMALIN.—Formalin, formalose, or 40 per cent formaldehyde, according to the trade name, has in the last two years become very popular with both zoologists and botanists. It is not necessary for us to go into the literature, but we have found that the 1 to 2 per cent solution of the formalin (1 to 2cc formalin in 99 to 98cc distilled water or sea water) makes a solution sufficiently powerful to kill, fix, and preserve any ordinary vegetable tissue. While the color fades more rapidly than with chrome alum, the cell contents are preserved equally well. For Phæophyceæ, a 2 per cent formalin solution is the very best fluid which we have tried. Cyanophyceæ preserve their structure but not the gelatinous matrix so well, since this is liable to shrink under the influence of formalin. Delicate Rhodophyceæ, such as *Griffithsia*, *Callithamnion*, *Dasya*, etc., keep their full form better than in any other fluid. Chlorophyceæ do equally well. Formalin solutions containing organic materials become acid after a short time and this may tend to alter the cell-contents or the intercellular substance slightly, but in preparations kept for nearly two years this is not sufficiently marked to be especially noticeable. Formalin in the same percentages works excellently for fungi and the higher plants. Toadstools are preserved in their natural shapes and in more or less of their natural colors according to the species.

CAMPHOR WATER.—Camphor-gum is sparingly soluble in water, but the solution is very prejudicial to the life of micro-organisms. Camphorated water is very useful

when considerable collections have been made and cannot be examined for several hours. In such cases small pieces of camphor-gum strewn in the water help to keep the algæ from putrefying until they can be studied or properly sorted and preserved. Formalin is useful also for this purpose, but the acidity produced changes the color quicker than is the case in camphorated water. For preserving Cyanophyceæ, camphor water keeps the cell structure well if present in large volume, proportional to the amount of material, but the coloring matter is soon dissolved. Chlorophyceæ, Phæophyceæ and Rhodophyceæ, if well sorted and cleaned, are well preserved in abundance of the fluid, even the finer details of cell structure being preserved perfectly. But perhaps the most important use of camphor water is to preserve specimens already fixed by other fluids. Specimens of the larger Rhodophyceæ, killed and fixed in concentrated aqueous solution of picric acid are preserved to especial advantage in camphor water; as one of us has experienced in special work upon *Rhabdonia tenera* Ag.

SUMMARY OF RESULTS.—*Cyanophyceæ* are best prepared with a solution containing 1 per cent chrome alum and one per cent formalin. This solution renders the gelatinous sheath and matrices firm, keeps the cell contents in a very natural condition, and retains in most cases the colors in their ordinary tints. One to two per cent formalin solution preserves the cell contents very well indeed, but does not keep the color well, or the softer gelatinous sheath and matrices. Camphor water is not very favorable for many blue-greens. Many species must needs be preserved in mass, and are associated with many bacteria and the camphor solution is hardly strong enough to wrestle successfully with the latter.

Chlorophyceæ are very satisfactorily preserved in any of these media. Chrome alum is to be preferred in most cases, but some species are rendered very brittle as, *e. g.*,

membranaceous forms like *Ulva lactena*. Such forms are of course better if placed in simple formalin solution.

Phacophyceæ do well when placed immediately in 1 per cent formalin in salt water. The larger forms are better fixed in 1 per cent chrome alum for a few hours (3-6) and then preserved in 2 per cent formalin solution of camphor water. But specimens for crushing may be allowed to remain indefinitely in the chrome alum solution.

Rhodophyceæ. The coarser forms may be put into any one of the three solutions and be in very excellent condition; chrome alum preserves more color than formalin or camphor water. For the finer study, specimens are best left in a concentrated solution of picric acid in sea water for twenty-four hours, then washed, preferably in sea water, for about twenty-four hours more, and preserved in camphorated sea water. Such genera as *Nemalion*, *Champia*, *Rhabdonia*, *Cystoclonium*, etc., respond best to this treatment. Delicate species need very careful consideration. *Griffithsia bornetiana* is a most delicate species and, preserved in almost any way, collects itself together into a shapeless mass; the cells lose their shape, and it becomes a very uninviting object for study. But place in 2 per cent formalin in sea water with plenty of fluid so as not to be crushed, the cells keep their shape and the whole plant presents a life-like appearance as far as form goes. The color of course departs. The same thing is true of various species of *Callithamnion*, such as *C. baileyi*, *C. borneri*, *C. seiro-spermum*, etc. *Dasya elegans* has a way of dropping its hairs on being preserved, and the more delicate species of *Polysiphonia* break up into short pieces, but either formalin or chrome alum will prevent this if the specimens are fairly fresh when put into the preserving solution.—*Botanical Gazette*.

Special Staining Methods in Microscopy, Relative to Animal Tissues and Cells.

5. THE MUCIN CONSTITUENTS OF NEUROFIBROMATA AND OF THE CENTRAL NERVOUS SYSTEM. By DR. P. G. UNNA. Translated by A. HABERMAAS, M. D., St. Louis.

The beautiful specific red stain, which all mucin constituents of the skin (mast-cells, the mucin metamorphosis of collagen and epithelium) assume when treated with the polychrome-methylene-blue and properly decolorized, has led to some new discoveries which I shall briefly describe.

Some time ago I was impressed with the number of mast-cells in the neurofibrous tissue of a neurofibroma of the skin. In distinction to the cutaneous tissue surrounding it, which manifests the ordinary collagen, the tissue of the nodule, as the epoch-making work of Rucklinghausen has shown, consists of a very peculiar variety of collagen. The latter is not only destitute of elastin, for this peculiarity it shares with other varieties of fibromata but is also peculiarly transparent and soft and manifests a remarkably regular structure, which corresponds to that of the epineurium. Unlike the surrounding cutis, when treated by the orcein-methylene-blue method, it presents an affinity for the methylene-blue instead of the orcein and assumes so marked a stain that in a well-prepared intercellular stain it can be distinguished from the adjacent tissue by the naked eye. It consists of a soft, rather amorphous, collagenous material, showing no fibrillar bundles, and in which at regular intervals spindle-cells, meagre in protoplasm, with rod-like nucleus, as well as large mast-cells, of a remarkably round form, are imbedded. If the neurofibrous tissue within the cutis were not differentiated from that of ordinary cutaneous fibromata by the fact that it arises from a nerve, that it develops from the connective tissue of the epineurium, and by the peculiar variety of its collagen, the great

number, regular distribution and general round form of its mast-cells would distinguish it beyond doubt.

The discovery referred to pertains to these peculiarly distributed and formed mast-cells of neurofibromata. In some recently prepared nodules of such a neurofibroma the mast-cells under the new stain (polychrome-methylene blue, glycerin-ether mixture) appear twice the usual size. This is due to the staining of a large round area, in whose center the mast-cell itself lies, consisting of a blue nucleus and an area of dark-red granules. Under higher power this area is found to consist of a fine spongy reticulum, and is not granular, although it takes up the same red stain as the granules. We have here to deal with a spongioplasm peculiar to the mast-cells. A more minute examination of these cells shows that the area described does not surround the nucleus with its granular area equally on all sides, but only on one side. Most often the red spongioplasm, resembling an open shell, and in which the nucleus and its granules lie, is found more or less deeply situated. Sometimes processes of the spongioplasm surround the contained nucleus, meeting from both sides, so that the latter appears to be enveloped in a cloak, though not completely. In other instances the area is represented by an irregular plate, giving off thread-like processes in various directions and upon which the mast-cell (nucleus and granules) appears to lie. These cells somewhat resemble the "winged-cell" of tendons.

Again, in this instance bell-shaped, spongy masses are observed, with broad, veil-like processes, in whose concavity the nucleus and its granules lie.

That the area surrounding the mast-cell really belongs to the latter, and is not an independent structure surrounding the cell, is proven by the many pictures in which the spot can be clearly distinguished where the cell communicates with the mast-shell. At this point, the proto-

plasm surrounding the granules, though usually unstained but by this method stained diffusely red. is seen to pass over into the protoplasm of the shell. The shell is a continuation of the sponge protoplasm, not the granular area at a distance, coming in direct communication with it only at one point. For this reason in certain sections the granular area appears to be free, while the cell of red spongioplasm surrounds it at a distance, attaching itself to the wall of the lymph-space in which the mast-cell lies. Such pictures, examined alone, might lead to the mistaken assumption that this shell were an independent membrane, lining the lymph-space, or a deposit of mucus on the walls of the same. It is only necessary to know—and it can always be demonstrated is a good collagen-stain—that in neurofibromata every mast-cell is surrounded by a rather regularly rounded lymph-space; lining this in a more or less flattened manner, like endothelium, lies the spongy shell, while the granular area lies within this, attached to it at about its midst.

Since the other structures which exhibit the mast-cell reaction are not generally known, I shall add a few remarks concerning them. The original form of ordinary mast-cells, first recognized by Ehrlich, which arise by acid decolorization or neutralization (?) of basic dyes is that of a spherical, oval, spindle-shaped or irregularly twisted or branching group of granules, whose connecting protoplasm (spongioplasm) and nucleus are colorless and therefore invisible. The same forms are also obtained by neutral decolorization preferably polychrome-methylene-blue and decolorization with the glycerin-ether mixture, or a neutral orcein solution, with this difference, that in the group of granules (red) the nucleus is also stained (blue); the surrounding protoplasm is also generally stained somewhat.

Besides these generally well-known varieties, there are some which occur less frequently and may be unknown

to some histologists. First, and this quite often, the mast-cell is surrounded by irregularly scattered granules which resemble the granules of mast-cells. These may be considered free mucin, which will be taken up by the mast-cells, or has been shed by them. I consider the latter opinion the correct one. In a carcinoma I once found the connective tissue in parts thickly studded with mast-cell granules.

The second variety requires neutral decolorization, and is therefore not so well known. In this variety individual mast-cells are surrounded by a homogeneous substance, which manifests the reaction of the mast-cell granules, but contains no granules. In these we are dealing with either a mucin meta-morphosis of the intercellular substance, or with the "shell-plates" described above, though not easily identified as such. This variety I have found most often in fresh scar tissue.

Thirdly, by neutral decolorization, in a variety of skin diseases, mast-cells can be demonstrated which present the usual form, but are peculiar in this respect, that they show the usual granulation only at one pole, or arranged laterally, instead of around the nucleus. The rest of the cell-body is constructed like that of an ordinary spindle-shaped connective tissue cell. I consider this variety to be mast-cells in process of development.

Fourthly, by the same process of decolorization mast-cells can be demonstrated which present the usual form, but distinguished by the spongioplasm containing the granules, which assumes the same diffused red stain as the latter. The cells are to be considered either as mast-cells supersaturated with mucin, or as such in which the mast-cell granulation has become liquefied and dissolved.

Of these four rarer forms, which are, however, often met with by proper staining methods the second and fourth, as is seen, bear some relation to the fifth variety herein described and known as the "mast-cell with shell-

plate." For in them we see an extra intracellular diffuse stain of the same nature as that observed in the granules. From this we may conclude that the mast-cells with "shell-plate" are to be considered the most complete, richest in mucin, and, so to speak, hypertrophic variety of mast-cells. We are dealing with a far-advanced mucin metamorphosis of connective tissue cells, which thus far has only been observed in neurofibromata.

After these investigations there can be no doubt but that the collagenous substance, which characterizes neurofibromata from other cutaneous fibromata, contains an amount of mucin peculiar to itself. The mast cells develop to a remarkable extent and here and there diffuse red stains, which do not belong to ordinary collagenous tissue, are observed, and which depend upon its mucin constituents. Do these constituents bear any relation to a development from nervous tissue? Is the greater abundance of methylene-red elements a characteristic of neurofibrous tissue in contradistinction to other varieties of fibrous tissue and of neurofibromata as opposed to other cutaneous fibromata?

Perhaps a second discovery, made by the aid of the same staining methods, may throw some light upon this as yet unsettled question. In preparing sections of the spinal cord and medulla of man and rabbit I found that a large portion of a transverse section, especially of the white substance (anterior, posterior and lateral columns), was normally thickly studded with small bodies, which manifested a red mucin reaction similar to that of the mast-cells. These are of the most varied form and size, and partly fill in the interstices between the axis cylinders and neuroglia of the white substance. They are homogeneous in structure and, with the decolorization mentioned, they take up a complete red stain, merging into blue. The largest red bodies lie within the middle and inner zone of the white substance. Toward the

periphery they become much smaller and gradually disappear as they reach the margin.

Similar small bodies, of the same reaction, are also found in the anterior and posterior horns of the gray substance; likewise in the nerve trunks as they leave the spinal cord, where they rapidly diminish in number and size. Within the gray substance they follow the course of the nerve fibres which traverse it, but are distributed far more sparingly and irregularly than within the white columns.

Referring to the distribution of the red masses thus far described, I must not fail to remark that among the many methods of demonstrating them, which I shall detail below, there are very few which show the entire distribution of these masses. The glycerin-ether mixture is the means peculiarly adapted for the demonstration of mucin bodies. By most other methods, the small and less markedly stained bodies are lost to view and only a limited number of them remain, varying in the different preparations. In a complete demonstration, it can be shown that the mucin constituents make up a surprisingly large proportion of a transverse section of the cord, probably over one-third. It is a difficult matter to describe the form of these bodies; and to do so carefully would carry us beyond the scope of this article. I think the reader can obtain an adequate idea of their appearance if he takes variously-shaped slips of red silk-paper and by irregularly folding and concentrically rolling them, shape them into small rods. Then let him cut them into pieces of varying size. Some of these pieces will remain compact, others will partly enroll and resemble shell-like, laminated structures, with irregular processes; still others will fall apart into very thin membranes, hollow rods and small flat shavings. All such forms are present in the greatest variety and abundance—rounded, large and small, apparently solid lumps; likewise hollow

rods, laminated, crushed and rolled membranes, shapes resembling slates, book-covers and shells, to the smallest forms which possess a certain resemblance to various forms of bacteria.

The greater the number of bodies brought to view the greater variety of forms is observed, while the methods which stain only a limited portion of them select special forms. Thus we sometimes find only small flat or rod-like bodies, or larger shell-like and hollow cylindrical bodies, which line the nerve channels in a narrow layer without coming in direct contact with the nerve at any point. If we stain a series of spinal-cord sections by various methods, it will be possible to bring out certain bodies in every section, differing in form and color, but similar in the four following respects, and therefore plainly related to one another: 1, in their paraneural position; 2, in their affinity for methylene-blue; 3, in their homogeneous structure; 4, in their form, traceable to the fundamental plan of a shell-like structure.

From these different pictures, brought out by different staining methods on similarly prepared alcoholic sections we must not conclude that we are dealing with artificial products, but with masses of different chemical composition, whose individual constituents are made visible to a varied extent and degree by different staining methods.—*St. Louis Medical and Surgical Journal*.

To be concluded next month.

The Bath Waters.

At a recent meeting of the Bath Microscopical Society, Mr. J. W. Morris, F. L. S., read an extremely interesting paper on "Hazel Nuts and their Crystallised Contents found in the course of Excavations at the Roman Baths."

Mr. Morris explained that the subject which he had

to bring before them had come to light, if he might use such an expression, in rather an accidental way. There was nothing at all novel or strange in the fact of hazel nuts being found among the Roman remains. They had been found from time to time for centuries past, and there were a good many of them in the cases at the pump room. The odd thing was that through these long ages nobody ever thought of 'inquiring within upon everything,' until the results were discovered which were being placed before them. The frequent occurrence of the nuts was noted by Stukeley, who in 1724 wrote as follows:—"It is remarkable that at the cleansing of the springs, when they set down a new pump, they constantly found great quantities of hazel nuts as in many other places among subterraneous timber. These I doubt not to be the remains of the famous and universal deluge, which the Hebrew historian tells us was in the autumn, Providence securing by that means the revival of the vegetable world."

A sufficiently curious comment, but still nothing like so curious as the fact that with the nuts to hand and the microscope at their elbow, no one had thought of looking to see what was inside them. On one occasion, in the earlier days of the excavation, a man came up with some of the nuts in his hand, and he (Mr. Morris) had no sooner taken them up than he noticed something gleam through a crack in one of them. This brought the pocket-lens out and then he saw that there was really something to investigate. The contents proved to be various kinds of crystals, which were not only interesting and beautiful, but were in many respects important, as bearing testimony on one or two points in connection with the Bath mineral waters. In some cases the kernel was found to have been converted into solid calcite; in others it had perished, and the shell or testa of the nut was lined with crystals. In some instances where the nuts

had been cracked, water had infiltrated through the cracks. The water which came in poured with it the pulverized, smashed, and crushed atoms of broken crystals, and strewed over the projecting peaks and pinnacles of the carbonate of lime, a perfect shower as if a snowstorm had descended upon the Alps. A curious thing was that in the clefts of these peaks he had found the sporangia and the scale of a fern. Some of the nuts were filled with quartz sand just like that preserved at the Royal Baths, and on searching through this they found curious evidences of organic remains.

The microscope showed him a spray of *Selaginella* absolutely to be identified, while close by were a number of the spines of *Echini*. These must have been washed into the nut through cracks. Projecting from the sides, or lining the testa of the nuts, crystals of strontia were found, being readily recognizable by their blue tinge and their radiating fan-shaped distribution. There was also arragonite. Carbonate of lime, when mixed with a little strontia, would frequently yield arragonite, but the latter was very apt to fall from the surface on which it was formed, as it had in the case of one of his best specimens that evening on the way to the Institution. They found in these crystals curious evidences of change of temperature. In many instances a change of temperature had caused the carbonate of lime to take the form of arragonite and in others the form of calcite. The strontia crystals, radiating and bundled like a closed fan, had a magnificent sheen upon them, and were remarkably beautiful.

If they took the analysis of Bath waters, they would find it stated in some of them that traces of strontia were found; in other instances, it would be said that traces of strontia were suspected. Was it not an interesting thing, therefore, that what by chemical analysis of the water was "suspected" or barely traced, they

could now by this natural process show as actual crystals?

The question naturally arose how far these crystals were due to the action of the Bath waters at different temperatures on these nuts, either by coming through cracks or absolutely finding their way through the pores of the shell, and how far they might be due to the properties of the hazel nut. He was at one time half disposed to think that he must credit the hazel with some share of the performance, but he was rather disposed to give that theory up, as one day he had accidentally discovered similar crystals in the skull of a Romano-Brittonat the Pump Room. Another curious feature about these hazel nuts was that the spiral fibre was found to have remained, although the nuts themselves had perished. It was sufficiently perfect for the instruction of a Botany class. The lecture also contained other points of interest, and Mr. Morris was heartily thanked for delivering it. The specimens exhibited by Mr. Morris were of great interest and beauty. —*The International Journal of Microscopy and Natural Science.*

The Tsetse Fly Disease in Zululand.

The tsetse fly disease, called "magana" by the natives, occurs in the horse, donkey, ox, and dog, and varies in duration from a few days or weeks to many months. It is uniformly fatal to the horse, donkey and dog, but of the cattle affected with it few recover. It is characterized by fever, more or less rapid destruction of the red blood corpuscles, extreme emaciation, and infiltration of coagulable lymph into the subcutaneous tissue of the neck, abdomen, or extremities, which consequently become swollen. *Post-mortem* examination shows the presence of a yellow, gelatinous material in the subcutaneous tissue and under the serous covering of the heart,

ecchymoses in various regions, and congestion and fatty degeneration of many organs. The tsetse fly (*Glossina morsitans*, Westwood), is about 11 mm. or seven sixteenths of an inch in length, and has transparent wings about 10 mm. long. On the upper surface of the abdomen there is a longitudinal yellow line with four yellow lines crossing it at right angles. In 1894 Surgeon-Major David Bruce, A. M. S., discovered that the blood of animals suffering from the tsetse fly disease invariably contained a hematozoön which had not been previously observed in Africa, but which he considers to be either identical with or closely resembling the *Trypanosoma Evansi* found in surra, a disease occurring in India and Burmah; surra, however, as known in India, does not affect cattle. In fresh blood these hematozoa are seen as actively moving transparent elongated bodies, in thickness about a quarter of the diameter of a red corpuscle, and in length about two or three times the diameter of a corpuscle. One end is bluntly pointed and the other is prolonged into a very fine lash, which is in constant whiplike motion; the body is cylindrical and has a transparent, delicate, longitudinal membrane or fin, which is also in constant motion. Surgeon-Major Bruce believes that the fly acts only as a carrier of these microbes from infected to susceptible animals, and does not cause the disease by means of any poison elaborated by itself. A limited number of flies may bite a susceptible animal over and over again without producing any ill effect, but, when a horse is taken into the fly country for even a few hours, or when numerous successive relays of flies freshly caught in the fly country and brought into a healthy district are made to settle on an animal there, the disease is almost inevitably set up. Five flies kept in a cage with muslin sides were allowed to bite the shaved abdomen of a small dog every two days from September 25th to November 28th, but

the animal remained quite healthy. On the other hand, flies which had fed for a short time on a dog affected with fly disease were allowed to bite another dog on November 21st, 23rd, 25th and 29th, the effect being that on December 5th hematozoa were found in its blood. In order to show that neither food nor water is the channel by which the disease is conveyed, two healthy horses, provided with network nosebags, were taken into the fly country from about 10 A. M. to 4 P. M. on September 19th, 24th, and 29th, but were not allowed to graze or drink. Many flies settled on them and they both contracted the disease, one on October 4th, and the other about October 28th. Another experiment was made by bringing to Ubombo tsetse flies caught in the low country and allowing them to bite a healthy horse; 129 flies were used in this way in ten days, from November 22d to December 14th, the horse fell ill on December 15th and the hematozoa were found in its blood. The source from which the fly obtains the hematozoa still remains to be discovered.—*Lancet*.

The Charlotte Medical Journal.—In the August number of this valuable paper, we find among seven original communications two articles of interest to the bacteriologist. Clinical observations upon the use of antitoxin in diphtheria, and a report of a personal investigation of this treatment in the principal fever hospitals of Europe during the summer of 1895, by Joseph E. Winters, M. D., New York—and Diphtheria treated with Antitoxin, by W. E. Fitch, M. D., Durham, N. C.

Dr. Muller of Vienna has described certain particles found in the blood under the name of hæmokonia (blood-dust). They resemble fat-globules, and the largest are 1-25000 of an inch in diameter. They are motile and are unaffected by osmic acid.

EDITORIAL.

Wisdom vs. Knowledge.—In the address of Rev. W. J. Holland, which we have thought worthy of a place on pages 368-70 it will be noticed that he welcomed the Microscopists to Pittsburg as persons, "who are wiser than Solomon." Being a clergyman as well as a scientist he probably knows the difference between Wisdom and Knowledge and would readily admit that he used the word "wiser" improperly.

No one can deny that our scientists have very much more knowledge of nature than Solomon possessed. Dr. Holland well illustrates this fact. But knowledge is not wisdom and many of the learned men of today are notoriously lacking in wisdom. Many of the scientists deny the possibility of that element which distinguishes wisdom from knowledge. Hence their frequent use of the two words as synonymous—a most grievous fault. These are not the columns in which to describe the characters of wisdom. Suffice the protest and statement that there is a gulf between wisdom and knowledge. The microscopists cannot be flattered properly with having a tenth of the wisdom of Solomon, but they have vast stores of knowledge which he did not possess.

MICROSCOPICAL MANIPULATION.

Smegma Bacilli and Tubercle Bacilli.—Mendelsohn reports a case in which the patient's urine contained much pus and granular detritus. The urine from the right ureter was clear, while cystoscopy demonstrated that the pus and detritus escaped from the left ureter. Tubercle bacilli were found in the urine. Nevertheless, the extirpation revealed a stone in the diseased kidney and no evidence of tuberculosis.

Von Leyden calls attention to the frequency with which the bacillus tuberculosis has been confused with the smegma bacillus, especially as the two have certain morphological resemblances and their staining reactions are not dissimilar

They are differentiated as follows: 1. Smegma bacilli, stained by anilin dyes, lose their stain on two-minute treatment with acidulated alcohol, while tubercle bacilli do not thus destain. 2. Smegma bacilli lose their stain under Gram's stain, while tubercle bacilli retain anilin-fuchsin staining. 3. A cover-glass preparation of tubercle bacilli carried through the flame ten times and stained with Ziehl's solution, presents the bacillus in a somewhat granular form or as composed of a succession of spherules; the smegma bacillus remains a solid rod under the same treatment.

Leiden records several mistakes made before the identification of the smegma bacillus. König publishes a case of enlarged kidney, with tubercle bacilli (so-called) in the urine and unmistakable pulmonary phthisis. The tubercle bacilli were, however, smegma bacilli, and the renal tumor was sarcoma. Senator has seen many cases of alleged tubercular cystitis recover, which he could explain only on the assumption that smegma bacilli contaminated the urine of a vulgar cystitis. This author has written on the differentiation between the two varieties of bacilli in his contribution to Nothnagel's System of Special Pathology and Therapy, now issuing from the German press.

Fraenkel avoided many mistakes by carefully cleansing the genitalia and then catheterizing. He has used Ehrlich's stain (gentian violet) for tubercle bacilli, which method, on destaining with nitric acid, leaves smegma micro-organisms without stain. The "caterpillar"-like arrangement of the tubercle bacilli is not observed in the other genus.—*Medicine.*

Microscopical Examination of Flour.—Lange gives the following method: Boil the sample in a hard-glass test-tube with 20 ccm. concentrated sulphuric acid and 4 gm. copper sulphate (free from water) until the liquid becomes entirely clear. Dilute the liquid with 250 ccm. distilled water, using a conical settling glass. Let stand for a few minutes and with a pipette withdraw the precipitate. The latter consists of the hairs and silicious cells of the grain, the nature of which latter may thus be determined.—*National Druggist.*

Methylen Blue.—A few points observed in the use of Erlich's methylen blue method by the investigators in the Marine Biological Laboratory at Woods Holl, Mass., may be of general interest.

The method has been successfully applied during the past summer to the study of the nervous system in a great variety of forms, including vertebrates, crustacea, annelids, echinoderms and tunicates.

Ehrlich's *intra vitam* methylen blue, prepared by Grubler, was used for staining the nerve tissues. The stain was applied by injecting a 1-½ per cent solution of the methylen blue made in normal salt solution, into the blood vessels, body cavity or lymph spaces or by immersing small animals or excised pieces of nerve tissue in a weak solution.

The method of application and strength of the solution were determined by experiment for each animal and tissue. During the action of the stain, the animal or tissue was kept as nearly as possible in its normal condition. Everything seems to depend on keeping the tissue alive, and in bringing the stain in contact with it in a solution of a strength suitable for obtaining the best results.

The abundant supply of oxygen to the staining tissue was of great importance in some cases, while in others it seemed to make little difference.

It was found, as suggested by Dr. C. Huber, that animals which live in the dark, stain better in the dark than in the light.

The relaxation of the tissues by the use of chloroform or chloral hydrate seemed to be more favorable for the staining of some elements of the nervous system, while others did not stain which stained in the unchloroformed animal.

It was found that recently caught and perfectly normal animals stained more satisfactorily than those which had been kept in confinement for some time, unless under very favorable conditions.

In the case of the dogfish, active animals were killed by decapitation. The stain was applied by injecting a 1-½

per cent solution of the methylen blue into the blood vessels for the central nervous system and by immersing small pieces of nerve tissue in a weak solution of the stain for the sense organs.

The length of time required for the *intra vitam* staining varied widely, annelids requiring 4-5 hours, while dogfish only require 1-½ hours, either by injection or by immersing the tissue in the stain.

When small transparent pieces of tissue were to be examined, they were fixed in a saturated solution of picrate of ammonia in distilled water from 2-4 hours and were then mounted in a mixture of equal parts of pure glycerine and distilled water to which a small quantity of picrate of ammonia is added. When opaque or large pieces were fixed in this way they were sectioned by the freezing method. After fixing in the picrate of ammonia, the tissue was placed in a saturated solution of sugar for one hour and was then transferred to a piece of blotting paper to remove the syrup from its surface. It was then placed in a thick solution of gum arabic for fifteen minutes and then transferred to the plate of the freezing microtome, where it was frozen by means of liquid carbonic acid. The sections were mounted in dilute glycerine as in the other case. The principal advantage of this method is its rapidity, but neither serial sections nor those of equal thickness can be obtained.

In order to obtain serial sections by the paraffine method, the tissues were fixed in Berthe's Fluid.

FOR VERTEBRATES.

Molybdate of ammonia, 1 gram.
Distilled water, 10 c. c.
Hydrochloric acid, 1 drop.
Peroxide of Hydrogen, 1 c. c.

FOR INVERTEBRATES.

Molybdate of ammonia, 1 gram.
Distilled water, 10 c. c.
Peroxide of Hydrogen, ½ c. c.

A different formula is used for tissues of invertebrates,

as less oxygen is required than for vertebrates. The fixing fluid must be cooled on ice before placing the tissue in it. After remaining in the cold fixing fluid for from 2-4 hours the tissue is thoroughly washed with cold water, which generally takes about two hours although it has been continued for twelve hours without injury.

It is necessary to remove all the molybdate of ammonia by thorough washing if permanent preparations are to be secured.

The tissue is then passed rapidly, ten to fifteen minutes in each, through the ordinary grades of alcohol to absolute, all being kept cold with ice. The tissue should be left in the absolute alcohol for about two hours at a freezing temperature and the alcohol be changed several times. The stain is dissolved by dilute alcohol at ordinary temperatures.

Dr. Huber's plan of placing the tissue directly in cold absolute alcohol on removing it from the water and changing several times for a period of two hours, gave good results.

After thorough dehydration the tissue is placed in xylol for 12-24 hours and changed several times. It is then imbedded in paraffine in the usual way.

The most complete and in every way satisfactory staining of the sensory nervous system was obtained by two or three injections of a $\frac{1}{2}$ per cent solution of Erlich's methylen blue at intervals of from 15 to 20 minutes, both with vertebrates and invertebrates, as suggested by Semi Meyer.

□ The tissues relaxed after the first injection, so that more fluid was introduced by the second and third injections than by the first.

The use of chloroform was found to be wholly unnecessary by this method. Meyer uses a very strong solution of B. X. methylen blue, 5 per cent to 6 per cent, in water.

The paraffine sections should generally be quite thick (45-60 mm.)—*The American Naturalist*.

Blood Stains.—Blood stains may be removed from the hands by the use of tartaric acid.

BACTERIOLOGY.

A Bacterial Disease of the Squash-bug.—Some squash-bugs kept for experimental purposes were found to be dying in considerable numbers, in an apparently healthful environment. The disease was readily passed on to other bugs. The distressed insects became sluggish, and very weak, and finally died, the body becoming a mass of gruel like fluid. Cultures were made from dead insects upon various nutrient media, agar-agar, bouillon, gelatin, milk, etc., giving colonies of a bacillus. Inoculation of this bacillus produced the disease in healthy bugs. Infusions of different cultures were found to have characteristic toxic properties. Bugs placed in these infusions died with every symptom of distress. Preparations of the blood of diseased insects showed a short bacillus, single or in pairs. The tissues of the insects break down under the growth of these organisms, which probably enter insects through the spiracles.—*B. M. Duggar before the Botanical Society of America at Buffalo.*

Professor Chantemesse bought at the Paris markets French, English, Belgian and Portuguese oysters and found in them the presence of numerous germs, and especially that of the coli bacillus.

A recently published report of investigations of the effects of tobacco during the epidemic of cholera at Hamburg states that there were no live microbes after twenty-four hours in the cigars made up with water containing 1,500,000 cholera microbes to the cubic centimeter.

A new laboratory of bacteriology has been established at the University of Pennsylvania to study all diseases connected with poultry and cattle. Dr. M. P. Ravenel has been made director and bacteriologist.

Angers, France, has a bacteriological laboratory with an annual appropriation of about 2500 francs.

BIOLOGICAL NOTES.

At the Biological Society of Washington, Dr. Erwin F. Smith exhibited specimens of *Leuconostoc mesenteroides* from a sugar house in Louisiana. These were in the shape of fist large gelatinous aggregates. If the vats are not sterilized at frequent intervals this organism multiplies very rapidly in the sugar cane juice and causes much inconvenience and loss.

Dr. Erwin F. Smith also described a bacterial disease of Potatoes, Tomatoes and Egg-plant, caused by a new micro-organism, *Bacillus solanaceanum*, which he believed to be the cause of a large part of the potato rot of the United States.

At the New York Academy of Science meeting, October 12, 1896, Prof. Bristol gave a brief account of the progress at the Marine Biological Laboratory at Wood's Holl, Mass., during the past summer.

In the recently organized department of biology in the graduate school of Georgetown University, Mr. M. B. Waite has been appointed professor of botany.

MEDICAL MICROSCOPY.

Bacteriology of Strangulated Hernia.—Brentano, in the *Deutsche Zeitschrift fur Chirurgie*, gives the results of the study of a number of strangulated hernias, with reference to the bacteriological contents of the hernial fluid, in the cases occurring in Koerte's wards in Berlin. He concludes:

1. That the water of strangulated human hernia contains micro-organisms much more frequently than we have been justified in supposing from previous publications.

2. That the bacteria of hernial water are frequently few in number and exist in a condition of diminished vitality, perhaps as the result of the bactericidal action of the water.

3. That as a result of this action of hernial water upon

the micro-organisms, proper investigation presupposes a cultivation upon a fluid nutrient medium.

4. That the presence of the bacteria in hernial water appears to stand in close relation with all the factors which threaten the vitality of the strangulated parts in a special way.

Dr. Ustler says: "Where a bacteriological examination cannot be made, the practitioner must regard as suspicious all forms of throat affection in children and carry out measures of isolation and disinfection.

The mortality from the plague in China in 95 per cent of all cases, according to a letter to the French Academy of Medicine. Dr. Yersin has discovered a new serum remedy for the plague, which reverses the figures, leading to about 95 per cent of recoveries.

A gentleman by the name of Oleta is reported to have arrived in Paris from Guiana, with a vaccine against serpent's bites. The remedy has been known by the native negroes, it would appear, for many years, but has only of late received scientific study.

The Presse Medicale reports that from January 1st to July 30th there were four hundred and sixty-eight deaths from variola in the city of Marseilles.

MICROSCOPICAL SOCIETIES.

The Microscopical Society of Washington has elected the following officers for the ensuing year: President, J. M. Yznaga; vice-president, A. A. Adee; recording secretary L. M. Moers; corresponding secretary, H. H. Doubleday; treasurer, Dr. Robert Reyburn; curator, Dr. Wm. H. Seaman.

A. M. S.—The officers of the American Microscopical Society for 1896-7 are: President, Prof. E. W. Claypole, B. Sc., F. G. S., Akron, O.; Vice-Presidents, C. C. Mellor, Pittsburg, Pa.; A. M. Bleile, A. M., M. D., Columbus, O.;

Secretary, William C. Krauss, M. D., F. R. M. S., Buffalo, N. Y.; Treasurer, Magnus Pflaum, Pittsburg, Pa., and the elective members of the executive committee are A. A. Young, M. D., Newark, N. Y., Mrs. S. P. Gage, Ithaca, N. Y., W. P. Manton, M. D., F. R. M. S., Detroit, Mich.

MICROSCOPICAL NOTES.

Assistant Microscopist Wanted.—The United States civil service commission held an examination at the post offices in Boston, Mass., Indianapolis, Ind., and Chicago, Ill., on October 30 for the position of assistant microscopist. The salary of the position is \$600 per annum, and only women above the age of twenty were admitted to the examination. The subjects of the examination were as follows: Orthography, penmanship, copying, letter writing and arithmetic. It is desirable that applicants should have a knowledge of the use of the microscope.

The Association of American Agricultural Colleges met in Washington, D. C., on November 10th, 11th and 12th.

The University of the State of New York has decided that after January 1, 1897, no degrees B. A. or A. B. shall be conferred *causa honoris*.

Diphtheria is prevailing to an unusual degree in London, the mortality from the disease during the first week in October having been greater than that of any week this year.

A Statue to Pasteur has been unveiled at Alais, in the center of the French silkworm district.

A journal of medicine is going to be started in Edinburgh. This new monthly publication is to represent the Scottish medical profession.

The great cyclone which passed over Paris, September 10th, damaged to the extent of 75,000 francs the Musee d'Histoire Naturelle.

Dr. Woodhead said before the British association at the Liverpool meeting that while continental laboratories were supported by the state, in England they received practically no government support, and very little from the community, usually depending on the generosity of single individuals.

An international exposition of hygiene, of alimentation, and of industrial arts will take place at Lille in March and April, 1897.

NEW PUBLICATIONS.

Advantages of Chastity.—By Dr. M. L. Holbrook, New York, 12 mo., pp 120.

In these days of nervous disorders which the members of the medical profession confess themselves powerless to cure, such a book as this is very timely. We especially recommend it to those scientists who find themselves getting nervous. We also recommend it to those married people who suppose that they can rightly seek pleasures which they deny to the unmarried. That the married may have children and the unmarried not, goes without saying. But to use the married relation as a cloak for licentiousness and a cover for debauchery is not chaste, and the penalties are visited not only upon the people themselves but to the third and fourth generations in inherited nervousness.

PERSONALS.

Pasteur.—A crypt to receive the remains of Pasteur is in course of preparation beneath the Institute of Paris. It is most elaborate in its conception and execution, and is decorated with symbolical winged figures representing Faith, Hope, Charity and Science. The body of the great scientist is to be removed thereto from Notre Dame on the 27th of December.

Dr. B. Boccardi has been appointed associate professor of microscopical anatomy in the University of Naples.

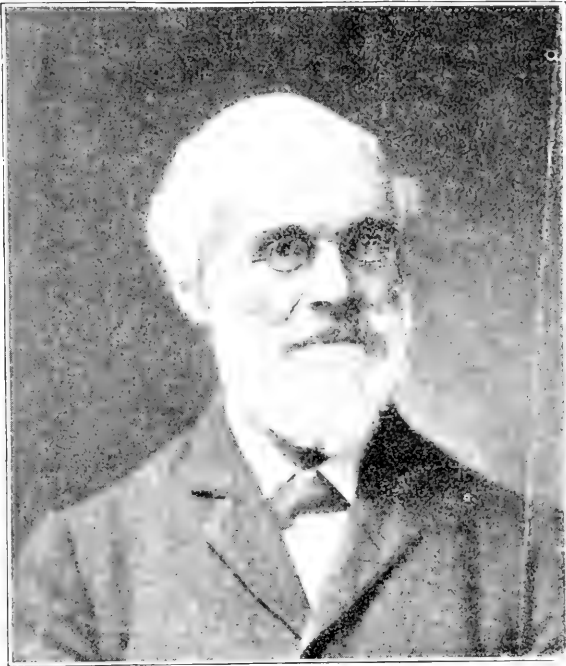

PROF. E. W. CLAYPOLE.

THE AMERICAN
MONTHLY
MICROSCOPICAL JOURNAL.

VOL. XVII.

DECEMBER, 1896.

No. 12

Prof. E. W. Claypole, M. D.

PRESIDENT OF THE AMERICAN MICROSCOPICAL SOCIETY.

WITH FRONTISPIECE.

Dr. E. W. Claypole is now professor of Natural Science at Buchtel College, Akron, O., and he was elected president of the American Microscopical Society at the recent meeting at Pittsburg. He was born in England in 1835. His education was for the most part obtained at home and from his father who was a good classical scholar and well acquainted with the principles of mathematics. Leaving home at 18 years of age he began work as a teacher and was so employed for some years in schools of various kinds and in different parts of England but chiefly in the southwest. During the spare hours of a busy life his studies for graduation were carried on and he passed the Matriculation Examination at the University of London in 1854. Following on in the same course in later years he successively took the degree of B. A., B. Sc., and D. Sc., in the same Institution. The University of London, it must be remembered, does not, as do most Universities, limit its degrees to those who have studied and resided at any of the colleges connected with it but its examinations are open to all comers on the sole condition of satisfying the examiners who are appointed in consequence of the high standing which they have obtained in their respective departments. Hence the list of graduates contains the names of men and women from different

countries and of different languages but of course mainly from Great Britain and the colonies. Mr. Clappole also as long as he had a residence in England and the state of his health permitted pursued a course of study and examination in connection with the same University.

After several years spent in the general work of college teaching at Bristol, England, Prof. Clappole, in 1872, came to the United States. He resided for twelve months at Boston and then removed to Ohio where for eight years he held the chair of Natural Science at Antioch College, Yellow Springs, succeeding Prof. Edward Orton who resigned to become President of the new State University then just established at Columbus. On the suspension of the College in 1881, he was appointed Palaeontologist-in-chief on the staff of the Second Geological Survey of Pennsylvania and during 1882 and 1883 resided at New Bloomfield in that state conducting the survey both stratigraphical and palaeontological of Perry Co. His results are contained in numerous papers in the American Naturalist, in the proceedings of the American Philosophical Society and in other periodicals but chiefly in the volume (F,) of the Reports of the Second Geological Survey of Pennsylvania, published at Harrisburg.

On the termination of his engagement in December 1883 Prof. Clappole received a call to the chair of Natural Science in the Institution named at the beginning of this notice. Here he has remained ever since engaged in teaching and investigation.

His work has been chiefly on geology and palaeontology to which however Botany and Zoology have been only secondary, both being indispensable adjuncts to the former. Papers by him on microscopical subjects connected with his researches may be found in the proceedings of the American Microscopical Society.

Dr. Clappole was with other naturalists one of the

active agents in founding the Ohio Academy of Science in 1891 for the investigation of the natural history of the state.

He was chosen as its first president. Four annual reports containing the results have appeared. He was also one of the original twelve editors who established in 1889 the American Geologist and have ever since maintained it. It is published at Minneapolis. In it will be found Dr. Claypole's recent investigations of the Devonian Fossil Fishes of Ohio. He has two daughters who are both members of the Microscopical Society and contribute to its proceedings.

Studies in the Elements of the Anatomy of the Lower Vertebrates.

By HENRY LESLIE OSBORN.

HAMLINE UNIVERSITY, SAINT PAUL, MINN.

The descriptions here presented are based on practical class work with college juniors, and are planned primarily to serve as a guide to be used in connection with dissection. Many good guides to vertebrate dissection are already published, but they are generally fuller in details than is absolutely necessary in a first survey of the animals. The constant effort has been made in this to indicate the facts which a person of little or no technical skill and equipped only with simple appliances can determine. This plan has been extended to a slight extent by means of brackets so as to include a synopsis of each topic, it being understood that this summarizes lectures or readings which accompany the students' work. In each case it is intended that the student shall have a specimen before him and so far as possible ascertain his knowledge from it. In case rigid economy is necessary the entire dissection could be made from a single specimen; and in case several are used they should be kept through the whole dissection and compared.

The subject should be examined point by point, verifying all statements and considering all questions that may be asked. The specimen should be kept moist all the time and all the internal anatomy and some of the external can be best made out under water, by using a pan with the bottom covered with paraffine, into which pins are to be thrust to hold the specimen in position. The water must be changed as often as it becomes turbid. Unfinished dissections should as a rule be kept in alcohol, brine or formol and finished subsequently. Side reading in anatomy is of great importance especially for a morphologist and a constant practice of comparison is absolutely indispensable as a fixed habit of mind.

The types that have been selected as the basis for study are easily obtained in the City of Saint Paul, if they are not obtainable elsewhere related forms can be used; for while the descriptions are for the most part based directly on the animals indicated, other allied forms are sufficiently similar for dissection in a first course. For general reference the student should have Wiedersheim's Comparative Anatomy of Vertebrates; besides which are the admirable articles in the Encyclopædia Britannica. Parker's Zootomy is a most excellent guide where a fuller course is desired.

PART I.

THE TELEOSTEAN FISH.

Osmerus mordax, The Eastern Smelt.

CONTENTS.

- | | |
|--|----------------------------------|
| 1. External Anatomy. | 9. The Alimentary Viscera. |
| 2. The Head. | 10. The Heart and Blood-Vessels. |
| 3. The Nose. | 11. The Uro-Genital System. |
| 4. The Eyes. | 12. The Muscular System. |
| 5. The Ear. | 13. The Nervous System. |
| 6. The Mouth and Throat. | 14. The Skeleton of the Trunk. |
| 7. The Brain. | 15. The Skull. |
| 8. Principal Parts of the Trunk
and Post-Abdomen. | 16. The Skin. |

1. EXTERNAL ANATOMY.—Examine the smelt,* noticing its elongate and tapering shape; how does this offer advantage in swimming? There is no distinct neck joining the head to the body. The following body-regions can be recognized, viz:—the *head*: with eyes, mouth etc; the *trunk* directly behind the head, it is marked by containing the thin-walled body-cavity, in which the various alimentary organs lie, and limited posteriorly by the *cloaca* or common opening for the viscera of the body, located in the middle line of the ventral surface; the *post-abdomen*, the remainder of the body behind the trunk. The body is covered generally with thin and delicate *scales*, located in definite lines; they are attached in front and free behind, and placed so as to overlap; a fuller study of them will come later. Examine the *fins*: as to position they can be distinguished as *median*, and *paired*. The *dorsal fin* is located in the middle of the back; the *caudal* is the name of the tail-fin (the term “tail” properly applies to the entire post-abdomen); the *anal fin* is located in the ventral surface commencing at the cloaca; in addition to these functional fins there is a fleshy structure in the dorsal line between the dorsal and caudal fins, it is the *adipose fin*, a rudiment of another dorsal fin. Besides these median fins, there are two *paired fins*: the *pectoral-fins* are closely related to the head at the very front end on the trunk region; the *pelvic fins* lie in the ventral surface just below the dorsal fin. Examine the fins carefully and distinguish in them all a thin and delicate fleshy portion, supported by pieces of bone, the *fin rays*. The fin rays start together in the base of the fin but distally they spread out like the parts of a fan; the small bones that compose them can be seen with the naked eye, but better with a hand lens. The number of rays in a

*In case a smelt cannot be had a trout or white fish is nearly of kin and can best be used.

fin is an important character for distinguishing different species of fish. Make a study of the distribution of color, and note that all the parts which would be visible from below are silvery white, while all those that would be seen from above are black; notice accurately the boundaries of these two colors. Do you think of any advantage from this distribution of the color? Is it true generally of animals? Of "Protective Coloration." Draw a side view of the smelt and show and index as many of these points as possible. Compare the smelt with other vertebrate animals (such as shark, skate, gar-pike, sturgeon, pike, bass, salamander, frog, lizard, snake, turtle, ostrich, eagle, duck, crane, sparrow, porpoise, seal, dog, horse, cow, bat, squirrel, elephant, mouse, ape and man). Can you make close comparisons in structure between the smelt and invertebrate animals such as clam, snail, angle-worm, cray-fish, butterfly?

2. THE HEAD.—In all the vertebrates (Craniota) the head presents two parts, the *cranium*, which lodges the brain; and the *face*, which includes the nose and eyes above and the mouth and throat below. In the smelt these parts are all present in the head, but the cranium is covered up by the face and lies in the upper and hinder portion of the head; the face will be taken up for study first.

3. THE NOSE,—as usual presents two chambers, open to the exterior by two small nostrils *anterior nares* easily seen. Cut away the skin around one of these nostrils and you will uncover a small *olfactory pit* lined with white colored *olfactory mucous membrane*. Search in the olfactory pit, also in the mouth chamber to determine whether there is a passage from the nostrils to the throat *posterior nares* as in the other vertebrates.

4. THE EYES.—Examine one of the eyes in its *orbit* or socket in the side of the head. Are there any *lids*?

Does the eye appear to be mobile? Locate the parts that show, viz: the *pupil*, the circular central opening; the *iris* encircling the pupil, silvery in color; the transparent *cornea*, covering the pupil and iris; beyond the cornea enclosing the sides and back the white tough outer *sclerotic* coat of the eye. Seize the eye firmly in the forceps by the sclerotic coat and pull it out of the orbit, as you do this notice and cut away the bands of *muscle* which attach it to the orbit, and at the back of the orbit notice and cut the white cord *optic nerve*, which runs through the sclerotic coat into the eye. Place the eye in clear water and with a sharp knife or scissors split it in two halves in a plane passing through the optic nerve, this will disclose: the *anterior chamber* of the eye, between the cornea and the iris; the larger *posterior chamber*, behind the iris; and inside the posterior chamber the spherical lens. On the back of the eye inside the sclerotic coat, the black *choroid coat*, the vascular layer can be seen and inside this (in well preserved specimens) the white *retina*. Repeat this dissection on the other eye; in removing it from the orbit study the muscles that fasten the eye-ball to the orbit and note that they are made of fibers which by pulling roll the eye in its orbit, they are not here sub-divided (as in the skate) into the six muscles of the eye of the higher vertebrates. Draw a diagrammatic longitudinal section of the eye in place in the orbit and show all these points.

[5. THE EAR,—is present in teleosts, but there is no external indication of its presence; it is located in a cartilage and bone capsule, on the side of the brain case and at the hinder level of the head; it has three *semi-circular canals* like the higher vertebrates, and there are large calcareous structures *otolith*, in an additional chamber, the *vestibule*; branches from the 8th cranial nerve (auditory) go to the ear on each side from the *medulla oblongata*.]

6. THE MOUTH,—externally is bounded by two jaws the free bone in the upper is the *premaxillary*, the lower the *dentary* (a part of the mandible of higher vertebrates). Note that the lower jaw is longer than the upper. Do both jaw-bones bear teeth? What is the shape and position of the teeth? Do other bones of the mouth bear teeth? Examine the interior of the mouth, note that its roof is entirely below the level of the nose, eyes and cranium. Study the sides and floor of the chamber, is there a fleshy tongue? Locate the *hyoid bone* in the centre of the floor; and the pairs of bones running from it obliquely backward, then arching dorsally to run forward and attach to the roof of the mouth posteriorly, these are the *branchial* or *gill arches*; count them. Note the openings, *gill-slits* between them, leading to the outside water; cut away the side of the mouth so as to enable you to examine the gill arches better; note in doing so: the *operculum*, a flat thin bony flap on the side of the head and behind, which covers the gills; it is open posteriorly to let the water that passes over the gills escape. How do you imagine that the operculum benefits the smelt? Cut off one of the gill-arches and examine it in perfectly clear water; note on its front side the row of fine delicate bones, *gill-rakers*, which stand projecting into the mouth cavity in such a position as to strain the water and retain any particles of food, and on the hind-side the masses of deep red *gills*. Separate the latter carefully and prove that they are made up of great numbers of delicate *filaments* all of them alike. Remove one of the filaments and see its central stem and numerous small side branches containing the capillaries in which the blood is aerated. The gill rakers and the filaments are carried on bones that support the arch and the chief blood vessels lie close to these bones and follow their course.

The *throat* or hinder part of the mouth chamber of the fish is devoted to the function of respiration; in the

lung-breathing vertebrate this region is relatively smaller and in the mammalia it is separated from the mouth by the soft palate and the muscular pillars of the fauces, as the *pharynx*. In the higher forms during their embryonic or larval life the throat and circulation are distinctly piscine.

7. THE BRAIN.—Cut away the mouth walls and floor and pin the upper part of the head down under water, dissect away the skin and muscles from the cranium and cut away the bones covering the brain, be very careful not to injure the soft white *nervous tissues*; beneath the bones you will find masses of cartilage surrounding the brain, pare these away as much as possible without damaging the brain. Explore the parts of the brain with a fine probe without dislocating them. The two largest rounded lobes of the brain are the *optic lobes*, directly in front of them are two smaller rounded masses, the *cerebral hemispheres*; the *olfactory lobes* are partly separate, lobed anterior portions of the cerebral hemispheres, in some cases they seem almost separate structures. The *olfactory nerve* can be seen running from the nose chamber to the olfactory lobes on either side by the help of a little dissection. The optic nerve can also be traced to the optic lobes which they enter on their ventral aspect. Other cranial nerves may possibly be seen. The portion of the brain behind the optic lobes presents two chief parts: a dorsal median rounded *cerebellum*; and ventrally to this the *medulla oblongata*. These lie in the extreme posterior portion of the cranium. Follow the nervous tissue back into the trunk region, note that it is enclosed in a passage, *spinal canal*, in the back-bone. Cut away bone enough to give you a view of the spinal cord and demonstrate its direct relation with the medulla oblongata. Draw a view of the brain in position in the head. Split the head in two in the middle line and locate the brain in relation to the head in the side view and draw.

8. PRINCIPAL PARTS OF THE TRUNK AND POST-ABDOMEN.

—Split the smelt in two in a vertical plane, passing a little to one side of the middle line. Cut across the ribs of one side and remove the lesser half entirely from the body. Notice that the post-abdomen is made up entirely of large masses of bluish grey *muscular tissue*, and that the same is true of the dorsal portion of the trunk region; but that in the trunk below the back-bone the muscular tissue is pushed aside, forming a thin layer in the wall of the *body-cavity (coelom)*, and that the space thus gained is occupied by the *viscera* (organs of digestion, etc. The viscera will be studied later).

Locate the back-bone *spinal-column*, extending the length of the body from the brain case in front to the base of the caudal fin. Examine it and recognize the situation of the successive pieces, *centra*, of which it is made; each centrum bears on the dorsal side a *neural spine* which runs upward and backward, the course of the neural spine is often indicated by blood vessels which run beside it. In the post-abdominal region a similar series of spines run ventrally, these are called *haemal spines* because the dorsal aorta is related to them. In the trunk region there are no haemal spines; but the *ribs* on each side in pairs articulate with the *centra*; the ribs pass insensibly into haemal spines. Follow the body-cavity forwards and note that it runs between and beneath the gills, where you will see the deep red *heart*. It extends posteriorly to the cloaca. It is everywhere lined with a delicate silvery lining layer, the *peritoneum*. Dissect away some of the peritoneum and see that the wall is composed of muscular tissue, and that this is composed of short fibres which run from one rib to the next (seen better in a specimen which has been boiled, vid. par. 12). Note that there is no breast bone for articulation with the ribs at their distal extremities; also that the body cavity is not divided by a diaphragm into thorax and

abdomen as in the higher vertebrates. Draw a view of this section of the smelt.

9. THE ALIMENTARY VISCERA.—Cut away the side wall of the body cavity so as to display the contained viscera, pin the specimen down under water, which must be frequently renewed to keep it clear, explore the organs with a probe but do not at first tear any of them from their natural attachments, try to determine the shape, position and connections of each one. Note the *peritoneum*, the silvery lining of the cavity; the *mesentery*, a very thin film running between some of the organs and attaching them to the dorsal wall of the body cavity. Find an elongate thin-walled organ filled with gas, it lies just beneath the vertebral column, it is the *swim-bladder*. Trace it forward and seek there for a connection leading from the swim-bladder to the throat, *pneumatic duct*; can you determine whether it is a hollow or closed duct? Find the *oesophagus* or *gullet* and follow it back from the throat to the point where it bends and begins to run forward. Here it passes into the *stomach* (which may be small and empty or enlarged and full of partly digested food, and whose size and shape will vary accordingly).

At the front end of the stomach the *intestine* arises, it bends back and runs straight to the cloaca, without having any sub-division into small and large intestine. The *mesentery* can be clearly seen with some of the *portal blood-vessels* beside the intestine. The compact organ straddling the front end of the stomach is the *liver*. The vessels from the intestine can be traced to it. It has a duct not readily demonstrated which leads to the intestine. There is no distinct pancreas but there are pocket-like enlargements at the beginning of the intestine which are said to be pancreatic in function. There is in the mesentery dorsal to the stomach a distinct compact rounded organ which is supposed to be a *spleen*. Salivary glands are not present. The large white or yellow organs addi-

tional to those mentioned occupying a large part of the body cavity are gonads, and do not belong to the alimentary system. Make a drawing to show these points. Then cut off the oesophagus, also the intestine, and remove the alimentary tube, split open each organ and examine the wall, noting in each an outer *muscular coat*, and an inner shining *mucous coat*. If there are any remains of food in the stomach wash them well and examine if possible the nature of the food on which the fish fed. The coats are easier seen if you soak a piece of the wall first for a time in 70 per cent alcohol.

10. THE HEART AND BLOOD-VESSELS.—The heart has already been located among the organs of the body cavity. Examine it carefully in position, and determine its relations to the adjoining organs and demonstrate as many of the following facts as possible: it lies immediately behind the bases of the gills; is ventral to the gullet; is surrounded by a very delicate membrane, the pericardium, which when removed enables you to see that the organ consists of three portions: the pear-shaped "*bulbus arteriosus*," which runs forward to the gills; the thicker walled "*ventricle*" directly behind the bulbus; and the thinner walled "*auricle*," larger than the ventricle dorsal to it and overlapping it on both sides. (There are vessels which bring blood into the auricle from either side, *ducts of Cuvier*, but they are not easily demonstrated on the smelt and there is a vein coming from the liver, *hepatic vein*). Cut the heart away from its attachments and immerse it in clean water, cut open its different chambers to see that they are hollow, find if possible the openings by which the chambers connect; can you find any *valves* to guard these openings?

[It is not possible to do very much with the dissection of the vascular system of a fish without injection, and especially with a small subject like the smelt which has been dead for several days (or weeks). However the

general plan of the circulation is given here as a guide; the student should locate as many of the vessels as possible from it. In the arterial system the blood is sent from the *bulbus arteriosus* directly forward into a series of pairs of *aortic arches* which follow the gill bones from below upwards. In the roof of the mouth the aortic arches unite, giving off *carotid* arteries to supply the head and then bending backwards to form the *dorsal aorta* which runs backward the length of the body directly below the vertebral centra. At its anterior end the aorta gives rise to arteries *coeliac axis* and *mesenteric* to the alimentary viscera, spleen and gonads, and small arteries are given off throughout its length to the muscles of the trunk and post-abdomen and to the kidneys *renal arteries*. The venous blood from the head and all the muscular system and kidney is returned to the heart by means of four veins in pairs, viz: the anterior and posterior right and left *cardinal veins*; these empty into the single auricle. The blood from the alimentary tube, spleen and gonads does not go into this cardinal circulation but is collected by means of the *portal vein* which carries it to the liver whence it is taken to the heart by the *hepatic veins*, two in number, opening into the auricle independently of the cardinal veins.]

11. THE URO-GENITAL SYSTEM.—In addition to the alimentary organs the body-cavity contains usually a pair of large organs, that are a part of the genital system. They are not the true germinal tissue, from which the eggs or sperm arise (*gonads*) but the greatly enlarged ducts leading from the gonads to the exterior, filled with the products that have been thrown off from the gonads. In the male they are very fine-grained and white, *spermi-ducts*; in the female they are coarse grained and yellow, *oviducts*. Examine an oviduct carefully, tracing it posteriorly till it passes to the exterior at the cloaca in common

with the intestine; trace it forwards and find its anterior end (in the body wall above the termination is located a small ovary). The general anatomy of the organs is the same in the male smelt. Cut out a small portion of an oviduct and tease it (pull it to bits) in water, as you do so you will be able to recognize that it contains great numbers of small spherical yellow objects, *ova*. Crush one on a slide and examine it with the high power, you can now recognize the *cell wall* or *vitelline membrane* which invests the ovum and the grains of *yolk* (there is in addition a central nucleated mass of protoplasm which should be carefully studied in a prepared slide if possible). The contents of the spermiduct should be studied in the same way, the *spermatids* are visible under the higher power (if preserved) as elongata filamentous objects; the size of one of these is infinitesimal in comparison with the size of one of the ova. The *kidneys* are situated in the dorsal wall of the body cavity, close to the vertebral column, they are covered by the peritoneum and do not lie in the body cavity. They can be recognized by their dark red color (a duct *ureter* leads from them to join the gonadial duct as it passes to the cloaca).

12. THE MUSCULAR SYSTEM.—Boil a fish thoroughly, then remove the skin so as to study the muscles, note first that throughout the trunk and post-abdomen, the muscle masses are segmented, i. e., they are made of similar portions that are repeated the length of the body; called *myotomes*; the number of the myotomes is the same as that of the vertebrate; each myotome is composed of parallel *fibres* which run from one rib, or posteriorly from the level of one vertebra, to the next. Draw figures showing the myotomes in situ, and of one myotome separated from the rest. Mount a few of the muscle fibres in water for microscopic examination, tease them into the finest possible masses, isolating single fibres if possible,

cover and examine (high power) note the cross markings *striations* the whole length of the fibre; note also that the fibres in some cases tend to divide up into lesser slender *fibrillae* in the length of the fibre.

[13. THE NERVOUS SYSTEM.—The general plan of the nervous system is that of the vertebrates at large, viz:—(1) *central system* consisting of: a *brain*; a *spinal cord*; and the *sympathetic system*; and (2) the *peripheral system* consisting of the serial *cranial* and *spinal nerves* and the *nerve-fibres* of the *sympathetic* system. The brain has already been dissected, the spinal cord can be seen by cutting away the neural arches (see section 14) of the vertebrae; the spinal nerves can be seen in the body wall beside the ribs in places; the sympathetic system can hardly be seen by a beginner, it consists of a chain of ganglia lying in the trunk region in the dorsal wall of the body cavity covered by the peritoneum; fibres from it communicate with the spinal cord and with the various viscera. The cerebro-spinal system in general is related to the sensations and voluntary motions of the animal while the sympathetic system is used in controlling the viscera (vegetative life).]

14. THE SKELETON OF THE TRUNK.—Using a fish that has been well boiled so as to loosen the muscular tissue from the bones, remove carefully as much as possible of the flesh, leaving the bones including the ribs in position as far as you can. Be especially careful not to detach the caudal fin. After you have removed all the flesh wash the skeleton and dry it. It is a help in keeping the bones together to have the back-bone lying on a piece of paper on which it is kept while being washed and dried. If it is later desired to separate particular bones for study they can easily be soaked with warm water and removed.

First study a single vertebra of some large fish; it presents the following parts: a *centrum*, which is biconcave and perforated in the centre. In life the space is occupied with the *notochord*, an embryonic cartilage which underlies the entire spinal system. On its dorsal side the centrum carries an arch of bone, the *neural arch*, and this passes above into the *neural spine*. The sides of the arch both in front and behind carry small articulating surfaces, the (*pre-* and *post-*) *zygapophyses*. If the vertebra is one of the post-abdominal series there is below the centrum a corresponding *haemal arch* and *haemal spine*. Now examine the spinal column of the smelt and after locating the points just made, compare the vertebrae in different parts of the spinal column and ascertain whether they are all alike. In the trunk region study the *ribs*, remove one and note its *head*, a rounded surface for articulation with the centra, note also at what exact point the ribs articulate with the back-bone. Do you find any indication of a *breast-bone*.

Examine the vertebrae at the line between the trunk and post-abdomen, and study the transition from the rib-bearing vertebrae to those having haemal arches. Examine the bones at the base of the caudal fin; the row of centra terminates in a long piece of *hypural bone* slanting upward with flattened neural and haemal spines which are adapted to receive the fin-rays; *cf. homocercal* and *heterocercal* types of tail. (The *pectoral fin* presents the following bones, so small, however, that the limb should be studied from some fish of large size. There is a *post-temporal* reaching up into the hinder part of the skull, a row of bones leading down from it, the *clavicles* to the base of the fin; a small dorsal *scapula* and a larger ventral *coracoid* between the clavicles and the base of the fin; three bones beyond these are called respectively beginning with the most dorsal of the row, the *pro-* *meso-* and *meta-ptyrgium*; beyond these there is

a row of *basalia* to which the *fin-rays* are articulated. The *pelvic limb*, presents: two thin bones, the *pelvic portion*, and the *fin-rays* directly articulated to them. (In some of the teleosts, e. g., the perch, the pelvic limbs are located actually anterior to the pectoral limbs though they are homologous with the hind limbs of the higher vertebrates).

[15. THE SKELETON OF THE SKULL,—is too difficult for a beginner who is limited as to time, the bones being so loosely articulated and so many of them incompletely ossified. One who attempts the problem should use a large skull well cooked; for detailed directions a fuller treatise must be consulted. The bones of the skull in the teleosts generally are directly comparable with those in the head of all higher vertebrates, this might be expected, since the head in other respects is thus comparable. Beginning with the lower jaw we find the *dentary* in front and the *articular* behind articulating with the rest of the skull. In the upper jaw there are the *pre-maxillary* in front and the *maxillary* behind it. The hinder part of the face is formed by the *operculum*, which consists of four separate bones. Removing these and attacking the bones in the floor of the mouth we find in the centre the *hyoid*, which, running back, articulates with a central *basi-branchial*, from which the bones of the gill-arches pass, as follows: *hypo-branchial*, *cerato-branchials*, *epi-branchials*; these latter articulate in the roof of the mouth with the *superior pharyngeals*. In the centre of the roof of the mouth underlying the cranium in the *para-sphenoid*. This articulates behind with a ring of bone (surrounding the *foramen magnum*) which in the higher vertebrates forms the single occipital bone, viz: the *basi-occipital* below, the *supra-occipital* above and the *ex-occipitals* between them. The roof of the skull is further covered in front with the *parietal*; this runs forward from the supra-

occipital to the *frontal*; which in its turn meets the *mesethmoid*; which encloses the cranium in front. The *nasal* projects beyond this and over the nose. In the side of the cranium encasing the ear are located a number of bones collectively called the *peri-otic* bones, and in front of these a small bone, the *ali-sphenoid*, lies in the side wall of the cranium. The orbit is bounded by a ring of small *sub-orbital bones*, and a *supra-orbital* is located above and behind it. The lower jaw is articulated at the end of a row of bones which run up to the side of the hinder part of the skull, these are the *quadrate* at the articulation; the *symplectic* above it and the *hyo-mandibular* still above and articulating with the skull. The sides of the roof of the mouth articulate with this row of bones by means of the *palatine* in front and the *pterygoid* behind; the pterygoid being made of three separate parts: the *pterygoid* proper and above it the *meso-pterygoid* and behind these and in front of the symplectic the *meta-pterygoid*.]

16. THE SKIN.—Keeping the skin moist, examine it closely, using the point of a needle, notice: that it is covered generally with *scales*; that these are arranged in regular alternating series (the number of rows is definite for each species of fish), that each scale is free from the skin behind but attached in front so as to offer no resistance to motion in that direction; that the scales near the middle of each side from the head tailwards, show a marking, *lateral line*, not present in the rest of the scales. Remove a single scale from the body surface anywhere not in the lateral line, keeping an exact idea of its position in the body as to outer and inner surface and anterior and posterior borders. Mount and examine the scale dry, noting its shape as to outline, the absence of notches on the margin and the presence of concentric markings, whose center is not the centre of the scale, (cf. *cycloid*

vs. *ctenoid* scale). Examine a scale from the lateral line, and determine that the line crossing it is a groove which runs obliquely through the scale from the front inner side to the hind outer side (this in life lodges the ending of a nervous organ). Illustrate these points.

Examine the general skin with a hand lens and note that the black color is caused by minute black spots, which are closely set, but ventrally are located in rows crossing so as to form diamond-shaped areas; how do these areas compare with the location of the scales? Cut off carefully taking as little as possible of the sub-jacent tissue a portion of the skin surrounding one of these areas, mount it in water and examine (low-power) now you will see that the spots are peculiar objects with irregular radiating processes, they are "pigment cells" and their growth is the cause of the color of the skin. They are a variety of "connective tissue cell" which has taken on the function of pigment secretion.

Examine the same piece (high power) you will find that it is composed of parallel fibres, "dermis," in two sets crossing each other, they are "white fibrous tissue" a second variety of connective tissue; white fib. tiss. swells and become translucent when treated with acetic acid, irrigate the piece and note the reaction, the fibres becoming invisible after its action. Draw views to show the location of the pigment cells, their shape, and the crossing fibres of the "dermis."

(To be continued.)

The Plague of Mice in Russia.

The *Consular Reports* for April contain a long contribution on the above subject, collated from a number of Russian governmental sources. Southern Russia and Siberia have during the last three years been the scene of the rise and fall of a pest of mice. In some places

the destruction of property by the rodents was a serious item in the sum total of the general misery of the peasant class. Regarding the bacteriologic work undertaken for the extermination of the animals, the reports from the laboratories are indicative of success, but not conclusive; at all events the closing up of the plague seems to have been chiefly due to the spread of infectious disease among the mice, but whether this was caused by the bacillus typhi murium or in some other way, no positive statement is made. The Governor of Cherson includes the following in his report :

1. It was particularly noticed that field mice had multiplied and that the number of house mice had largely increased.

2. The warm winter had without doubt favored their propagation, but probably the main cause consisted in the large quantity of cereals which had remained all over the province, in the shape of thrashed grain as well as in stacks.

3. It is also certain that the mice increased on the spot, but, according to the observations of some landowners, the mice were noticed to move from east to west. This gives reason to believe that they immigrated from neighboring provinces and occupied the territory of the entire province.

4. The reports regarding the extraordinary increase of the mice date from the spring of 1894, but its commencement dates back to the autumn of 1893; of late, the mice perish from some disease which is not as yet defined, but to determine its nature certain measures have been taken by the Department of Agriculture. It is not possible to estimate the extent of damage caused by mice; all the more so, because they are accompanied by rats which not only devour grain and other produce, but even destroy village buildings.

5. Up to the present, the population have used various

domestic remedies for the extermination of the mice, besides which, with the assistance of the rural administration, it was determined to poison mice with Professor Loeffler's cultivations of typhi murium, as prepared by the Odessa bacteriologic station and the Cherson bacteriologic laboratory. This cultivation of typhi murium shows its effect upon the numbers of mice not sooner than three to four weeks after its use. In June, 1894, the Department of Agriculture sent to the Province of Cherson, Dr. Merezhkovski, the assistant of the manager of the bacteriologic laboratory of the department, to carry out experiments of exterminating the mice by means of the cultivation of the bacillus discovered by him. The experiments carried out by him in the agricultural school of the Cherson rural administration gave good results, and in October they were extended to the estate of G. L. Skadovski, a landowner, where they were superintended by a special committee; on the sixth day, the mice began to perish of the cultivation of Dr. Merezhkovski, and on the ninth day this attained considerable dimensions and the mice were reduced to their normal number. In April, 1895, the department sent out bouillon with the cultivation of Dr. Merezhkovski, but there are no reports as yet to hand concerning the results. The United States Consul at Odessa adds that when the army of mice swarmed over houses and huts through the country, the dogs and cats refused to molest them, and says "An incident which came under my own personal observation is not without interest. While I was waiting for a train at a small station on a branch line of the Southwestern Railway, a clergyman, with very long hair and beard, who was walking up and down the platform, stopped for a moment and raised the end of a canvas which served as a cover for a large quantity of wheat which was awaiting shipment. In an instant a mass of mice sprang at him and his beard, hair

and cloak were literally alive with them. To brush them off was a matter of some time, and when my fellow traveler at length thought himself free, he was dismayed to find a mouse in each of his trouser pockets." Doubtless, all bacteriologists are familiar with the experiments of Loeffler, Lazare and Merezhkovski; but it may not be amiss to mention that, besides certain morphologic distinctions the differences between the bacillus typhi murium of Loeffler and the bacillus derived from mice by Merezhkovski consist mainly in this, that the mice die sooner when infected with Merezhkovski's bacillus than with that of Loeffler. Experiments with the infection of mice by means of Merezhkovski's bacillus were carried out by himself in his laboratory. As regards the typhi murium of Loeffler, besides the experiments of exterminating mice in the fields carried out by Loeffler himself in Greece, similar experiments were made by several Russian laboratories, among others, by that of the Odessa bacteriologic station in the provinces of Cherson and Podolia. These experiments were made in the fields and in the places where there was grain in stacks, and gave satisfactory results. These cultures of Loeffler's bacteria are customarily sent out in tubes of agar-agar, where they retain their vitality during the course of several months. The contagium of typhi murium presents itself in the shape of a gray film on the slanting surface of the jelly in testing tubes. For the purpose of using it, the film must be mixed with water in which pieces of white bread are soaked; the transparent remainder of the contents of the tube must be distributed, together with the pieces of bread, in the localities where the mice prevail. The details of this manipulation are as follows:

1. A .5 per cent. solution of table salt in water (one teaspoonful of salt is taken for five glasses of water) is

prepared by boiling it for twenty minutes and subsequent cooling.

2. The testing tubes are filled with this water to one-half, the film is carefully scraped off by means of a little stick, and the liquid contents of the tube are poured out into the prepared solution; to five glasses of water, three testing tubes are taken

3. In the liquid thus obtained, pieces of bread are soaked and distributed over the places indicated. The mixed contagion must be used immediately. Before using the cultures, it is indispensable to test their virulence on mice.

MICROSCOPICAL MANIPULATION.

To Find Micro. Objects.—It may not be generally known to those who mount their own slides that much good material can be found during the winter by examining the stems of any dried plants in the hedgerows, as, *e. g.*, Nettle, Cock's-foot Grass, etc. In this manner various and often rare insects can be taken in fine condition. The most productive stems are those *not* in a vertical position, as when standing at all upright the rain can enter, which makes it too uncomfortable for insects to take up their winter quarters there. It is a good plan, when the day is very cold, to take the stems home in a paper bag, and examine them over a sheet of white paper. Moss collected in the woods will also yield good results, especially in the beetle tribes. C. J. Watkins.—International Journal of Microscopy and Natural Science.

A New Method of Preparing Serum Agar-Agar.—Dr. A. A. Kanthack (*Lancet*) gives the following method of preparing serum agar-agar from ascitic, pleuritic, or hydrocele fluids. To every 100 c. cm. of serous exudation add 2 c. cm. of a ten-per-cent solution of caustic potash; this converts the serum albumin into an alkali albumin, which

is not precipitated on boiling. To this add 1.5 to two per cent of agar-agar, previously soaked in acidulated water, and boil the mixture in a Koch's steamer until the agar-agar is well dissolved. It must now be filtered through a hot water-funnel. The filtrate should be perfectly clear. To the filtrate add four or five per cent of glycerine. It may then be poured into test tubes and sterilized. Besides the glycerine, 0.5 to two per cent of grape sugar may be added; this however generally renders the medium a little darker in color.

Before adding the caustic potash to the serous fluid, a small quantity of it should be boiled in a test tube. If it becomes practically solid, or contains large quantities of albumin, the fluid must be diluted with at least twice its bulk of distilled water; and then to every 100 c. cm. of the diluted fluid 2 c. cm. of KOH and 1.5 to two grams of agar-agar are to be added. The serous exudation, after the addition of the alkali, also forms a good liquid nutrient medium for bacteria.

Storax as a Mounting Medium.—Permanent preparations can be mounted in storax, according to Dr. J. H. Piffard (*Medical Record*, 1895, p. 547), if it be prepared as follows:—The storax is liquified on a water bath, then filtered through two or three thicknesses of cheese cloth on a hot-water funnel, and when cold mixed with an equal weight of xylol. Shake well several times through absorbent cotton or Swedish filter-paper, and evaporate at a gentle heat to the consistency of treacle. Finally, to each two parts of the fluid add three parts of naphthaline monobromide, and heat gently until a clear amber-colored fluid is obtained. Preferably, the refractive index of the medium should be brought to 1.625, by adding more of the ingredient that may be found deficient, and the product will then be found suitable for work with the highest powers.

Brown Cement, suitable for Microscopic Work.—The Chemist and Druggist recommends either a thick solution of shellac in vegetable naphtha, or of gutta-percha in chloroform or bisulphide of carbon.

Plants Growing Under the Microscope.—This is something that we read of in most books on the microscope, and although it is not by any means true plant growth, it is very curious and beautiful. Procure a little *Collomia* seed, which may be had from seedsmen. Take one of the seeds, and with a razor, or very sharp knife, cut off a very tiny slice. Lay this slice on a slip of glass (an ordinary slide), cover it with a tiny glass cover, and, the microscope being in a vertical position, lay it on the stage. If you wish to incline the microscope, you must use a square glass cover, and not a round one, and hold the cover to its place by means of a very fine rubber ring. Now, bring the thin slice of seed into focus, and then apply a drop of water to the edge of the glass. The water will penetrate between the glasses and moisten the seed, which will at once throw out a very large number of spiral fibers, giving it the appearance of veritable germination. Beginners will find it easier to perform this experiment if one will apply the water while the other looks through the instrument. A single drop is enough.—Meyer Brothers Druggist.

BACTERIOLOGY.

Bacteriuria as a Complication of Gonorrhœa.—(*Wiener Med., Revue Int. de Med. et de Chir.*) Bacteriuria consists of the presence of numerous bacteria in the urine which has a nauseous and penetrating odor. The bacteria gain entrance either by catheterization, by immigration from neighboring organs, by fistulæ, or by the lymphatic system. The presence of gonococci enfeeble the resistance of the mucous membrane, making it an excellent soil for the development of these bacteria; the bacteria coli most often causes these attacks of bacteriuria; the same bacterium is also the cause of gonorrhœal inflammation of the prostate; in such cases the bacterium coli comes from the intestines. The bacterium coli can also produce a running suppuration; irrigations of silver nitrate are the most effective means of treating these lesions of the prostate.

Bacteria in Noma.—X. has made bacteriological examinations in two cases of noma (occurring in two girls, respectively three and fourteen years of age). The cultures and preparations were made in both cases from the boundary between the necrosed and healthy tissue. In both cases cocci were found together with a bacillus which was polymorphous and resembled the diphtheria bacillus. The cultures of this bacillus from the first case had no pathogenic effect upon animals. The author considers the bacillus found by him to be different from the one described by Shimmelbusch.

These findings correspond to those obtained by Bishop (Transactions Chicago Pathological Society, vol. i, p. 252), who reports cases of noma from which a bacillus was isolated resembling very closely in its morphology the diphtheria bacillus, but with slight pathogenic effect upon animals.—Medicine.

Bacteriological Diagnosis of Epidemic Meningitis by Lumbar Puncture.—W. Holdheim gives the results of the bacteriological examination of fluid obtained by lumbar puncture in four cases of epidemic meningitis. In all the cases the meningococcus intracellularis of Weichselbaum was found in the fluid. The fluid obtained by puncture was centrifugated, and from the sediment cover-glass preparations were made in the usual way and stained according to Loeffler. In all the preparations numerous leucocytes were found, in which were often seen three or four pairs of cocci. The diplococci were very like gonococci in appearance, and lance-shaped diplococci were not found. Pure cultures of the meningococcus were obtained upon glycerin agar-agar in each case.

The author holds that by this method a diagnosis can be easily made in epidemic meningitis by lumbar puncture, and a differential diagnosis during life between it and tubercular meningitis.—Medicine.

Bacteriology of the Hair.—Dr. L. Brocq says that when the bacteriology of the hair is taken up various microbes are found in it. Six are, however, discovered quite con-

stantly. These are: (1) a white fungus; (2) a yellow fungus; (3) a bacillus subtiliformis; (4) a bacillus in the form of a boat, staining with difficulty; (5) a special micrococcus, which Sabouraud designates provisionally under the name of micrococcus cutis communis; (6) the spore of Malassez, the flask bacillus of Unna, which he calls the bacillus asciformis. These two microbes, which appear to be the most important, are found in seborrhoics who are not attacked with alopecia areata. No one of these microbes would have the importance of a causal agent in the disease.—Medical Record.

Bacteria and Aerated Water.—Professor Frankland, in Nature, shows the fallaciousness of the prevalent idea that by drinking aerated water safety from infectious disease is insured. In experiments by Salter, the number of bacteria varied from 200 per cubic centimeter with 15 grams of carbon dioxide per liter, to 2,000 with 6 grams per liter. The spores of the anthrax bacilli have been found to survive 154 days in aerated water, but the cholera bacilli cannot live longer than three hours. The typhoid bacillus requires a period of two weeks to insure its destruction. The author recommends storage for a certain period, as time is thereby given for the destruction of the pathogenic bacilli by the innocuous forms.—Medical News.

Bacteriology in Private Practice.—Jaques in a paper read before the Chicago Medical Society describes a convenient way of using Loeffler's blood serum mixture. It consists in the use of small metal boxes, the size of a quarter, and several times its thickness, in which the medium is placed and sterilized as if in tubes, and sealed with paraffin. These can be carried about readily, present a considerable surface for inoculation, and can be incubated by carrying in a pocket near the surface of the body.—Chicago Medical Record.

The municipality of Paris has changed the name of the Boulevard de Vaugirard to that of Boulevard Pasteur.

MEDICAL MICROSCOPY.

Pleuritic Effusions and their Treatment.—A bacteriological examination should be made in all cases; both with cover-glasses, with culture media, and with injections of the effusion in animals. Distinguish between exudate and transudate by using the acetic acid chemical test, and by the same process eliminate mucine. Many cases of pleurisy are of an uric acid diathesis. These will yield readily by the treatment of the salicylates. I believe not more than 15 per cent of pleuritic cases are rheumatic. The finding of pneumococci does not aggravate the conditions, and often gives no markedly distinct symptoms. Pleurisy in typhoid is not a mixed infection, but a distinct condition. Tubercle bacilli are often found in the pleuritic effusions. I believe it is not only possible, but likely that the tubercle bacilli do penetrate through the alveolar septi, and enter the pleura without producing infection in the lungs. Tuberculosis may be differentiated by the agar culture. Hyperæsthesia of different parts is frequently present.

I have washed out the cavity in 14 cases with an anti-septic solution of one-half to two per cent of clove oil, with most gratifying results in 12 of the cases. The advantages of this method are: Many patients will allow such an operation, who would object to an exsection of the rib; no bulky dressings are constantly interfering with the comfort and convenience of both patient and physician; much shorter time is required.—Dunghlison's College and Clinical Record.

Mixed Infection and Virulence of Diphtheria Bacilli.—Dr. W. H. Park, said before the New York Pathological Society that he had been deeply interested in the question of mixed infection, because of the important bearing of this subject on the anti-toxin treatment of diphtheria. He presented temperature charts of three children affected with laryngeal diphtheria. In the first case, between February 11th and 19th, the temperature had ranged between 105 degrees and 105.5 degrees F. The glands had become

swollen four days before death, and the pneumonia which had been present had become more marked. The autopsy showed broncho-pneumonia; and lesions of the kidneys and other organs. The cultures from the lungs showed numerous streptococci, as well as Loeffler bacilli. The cultures from the blood of the various organs showed pure growths of streptococci. Cultures from the blood of the various organs showed pure growths of streptococci. When these streptococci were injected into a rabbit, they were found to be of moderate virulence. His experience had been that after the streptococci were passed through a few rabbits they increased somewhat in virulence but then the virulence remained stationary.

The second case was that of a child of one year, with laryngeal diphtheria and high temperature. It was given antitoxin. Twenty-four hours later it was intubated, but after three and one half hours the tube was removed. Thirty-six hours after admission the temperature was 106 degrees F., and remained high until death. The child remained the larger part of the time in a position of opisthotonos. The lung showed a late stage of broncho-pneumonia. Cultures from the lungs and other organs gave streptococci.

The third child had been sick only two days, but the chest was full of rales. There was no membrane in the throat; some diphtheria bacilli were found in the throat. The temperature at the end of forty-eight hours reached 107 degrees F., and the child died. The autopsy showed both lungs consolidated. Cultures from the lungs and from the blood showed the pneumococcus, and a few colonies of diphtheria bacilli were found in the cultures from the lungs.

Cultures from the blood of those dying early in diphtheria, without high temperature, were usually sterile; when there was a high temperature, septicæmia was generally found. When the lungs showed lesions, diphtheria bacilli were always present in the consolidated areas. Streptococci were also found. The diphtheria bacilli were found in fourteen cases. It had been suggested by Dr. H.

M. Biggs that the work done some time ago regarding the virulence of the diphtheria bacilli be again tested. In cases in which the clinical diagnosis was follicular tonsillitis or pseudo-diphtheria, the virulence of the cultures was tested and notes were made regarding the number of diphtheria bacilli and whether or not they were characteristic. In four months 71 such cases had been tested, and from 50 of these bacilli were obtained in pure culture and inoculated into guinea pigs. In 38 of the 50 the bacilli were characteristic and abundant; in 37 they were virulent; in 1, non-virulent. In 2 the bacilli were atypical. Out of 48 characteristic cultures, the bacilli were virulent in 46 and non-virulent in 2. In two cultures of the pseudo-type they were virulent. Of those tested, in 26 the diagnosis was not diphtheria; and of these, 22 were virulent and 4 non-virulent. In 24 doubtful cases the bacilli were virulent in 22, and in 2 not virulent—in other words, in twelve per cent of the 50 cases they were non-virulent. In 2 of these the bacilli would be called atypical.

Dr. L. Waldstein asked Dr. Park if he had noted any relation between the size of the individual links and the lengths of the chains and the virulence of the bacilli; also whether in making cultures of the streptococci the virulence was affected by the alkalinity or acidity of the medium.

Dr. Park replied that he had examined swabs from slight pus cases, and in these the chains had been very long. In some of the cultures from the severer cases the chains had been rather short. He had made no exact observations as to the effect of the alkalinity of the medium on the virulence of the bacilli.—Medical Record.

Antitoxin Treatment of Diphtheria in Austria.—Professor Paltauf has published statistics of 1,103 cases of diphtheria in which antitoxin was employed, with the result of 970 recoveries and 133 deaths, equivalent to a mortality of 12.5 per cent. He lays much stress upon the early application of the serum, for in the case of injections made on the second day of the disease the mortality amounted

to 6.7 per cent, whereas in those made on the third day it amounted to 19 per cent, in those on the fourth to 23 per cent in those on the fifth to 31 per cent, and in those on and after the sixth to 33.3 per cent. Professor Paltauf makes mention of the epidemic of diphtheria in Ischl, where in December, 1895, all those children died who had not received the antitoxin treatment; whereas in January, 1896, in the cases of 16 children attacked with the disease and treated with antitoxin the result was in every way successful.—The Lancet.

A Newly Discovered Constituent of the Blood.—Dr. Muller of Vienna has described certain particles found in the blood under the name of hæmokocia (blood dust). They resemble fat-globules, and the largest are 1-25000 of an inch in diameter. They are motile and are unaffected by osmic acid.

The Serum Treatment of Cancer.—At a recent meeting of the French Congress of Internal Medicine, M. Dubois stated that he had introduced fragments of cancer taken from human subjects into the cellular tissue of animals and had obtained several tumors, the largest of which weighed between seventeen and eighteen ounces. The serum of these inoculated animals was then employed in three cases of cancer. In the first case there was non-ulcerative cancer of the breast in which the treatment led to an almost complete recovery after a period of forty-five days. The second case was one of epithelioma of the face, which subsided in thirty-nine days.

In each case, from two to five cubic centimeters of the serum had been injected in the region of the tumor every three days and a few drops of alcohol with a very small quantity of iodide had been injected around the tumor in the second case. The third case was one of relapsing epithelioma of the upper lip, which was very much ulcerated and highly inflamed, and after twenty-three days of treatment the progress of the tumor seemed to have been arrested, but it presented no tendency to complete recovery. From these facts, M. Dubois concludes that the se-

rum of animals inoculated with cancerous elements seemed to cure cancer by fibrous transformation. Its action was much more certain he said, when it was employed in the beginning of the disease. He thought its employment presented no dangers, except in cases of extensive lesions.—*N. Y. Med. Jour.*

MICROSCOPICAL SOCIETIES.

Calcutta Microscopical Society.

At the April meeting Mr. W. J. Simmons described his method of making an observation of dust with a view of detecting in it air-borne spores which are said to cause molds to grow in a manner which the earlier observers believed favored the doctrine of spontaneous generation. The method is simplicity itself, and consists in placing a drop of pure glycerine on the center of a slip of glass measuring three inches by one inch. The drop is smeared over the glass lightly so as to cover a surface of about three-quarters of an inch in diameter, and is then exposed to the air for two or three days. When the dust which settles on the smear is to be examined under the microscope, a circular cover glass is placed on it, and the deposit is now shown by the microscope to be composed of a most heterogeneous collection of objects. Fibers of all sorts, the scales from insects, wings, root, pollen, starch, down, fragments of epidermis, and of the cuticle of plants, hair, entire mites, numberless inorganic particles, charred straw, portions of insects, hairs from plants, and several spores of fungi are thus revealed.

If a drop of glycerine, half an inch in diameter, arrests so many spores, how many do we inhale daily, and how many are deposited on our food in the course of a day? The study of dust is not one suited to a beginner in microscopy, because it presupposes familiarity with the thousand and one objects which are certain to be present on the glass slip; but it presents no insuperable difficulties, and does not demand any special or costly appliances.

THE AMERICAN MONTHLY MICROSCOPICAL JOURNAL.

INDEX.

- Abrasive substance, 298
Address of welcome, 368
Adirondack sanitarium, 222
Adulteration of senega root, 153
Acid, filicic, 287
Air, germ content of 185, 187
Air-passages, bacteriology of, 254
Algæ, 274, 378
American Electro-Therapeutic Association, 284
 Microscopical Society, 41, 141, 311, 368, 404
 Postal Microscopical Club, 289
Amœba, 266
Amphirrhopalum bifidum, 57
Anaerobic micro-organisms, 8
Angers, France, 402
Animal tissues, 131, 349, 385
Antidiphtheric serum, 288
Antifebrile reaction of tuberculin, 186
Anthrax in fox, 154
Antitoxin, 69, 186
 serum in small-pox, 313, 361
Aplanatic magnifiers, 66
Appendicitis, 98
Aquarium cement, 218
Aqueous media for preserving algæ, 378
Asthmatic sputum, 242
Atractura digitata, 98
Astroocurra, 138
Atwood, Melville, 139
Aubert, A. B. 165
Bacillariaceæ on Long Island, 52
Bacilli in pus, typhoid, 287
 smegma and tubercle, 397
 tubercle, 150
 typhoid, 315
 of chancroid, 226, 431
 ramosus, 149
 tuberculosis in milk, 40
 whooping cough, 283
Bacteria at low temperature, growth, 69
 diagnosis of, 148
 fluorescent, 150
 in excrement of bovines, 188
Bacteria in milk, 184, 187
 motile, 174
 of school rooms, 88
 of the intestinal canal, 104
 skin, 34
 of the vagina, 313
Bacterial disease of squash-bug, 402
 origin of eclampsia, 106
 products, 155
Bacteriologic Concours, 286
 Results from mechanical filtration, 89
Bacteriological, etiology of acute conjunctivitis, 313
 investigations, 220
 researches, 118
Bacteriology, 40, 68, 104, 148, 184, 219, 253, 257, 313, 402, 431
 of air passages, 254
 of hernia, 403
 of the normal conjunctiva, 373
Barbadoes, a new genus from, 61
 a new species from, 57, 58
 radiolaria, 19, 25, 96, 138, 161, Barnouvin, M. 149
Batrachospermum, 250
Biology, studies in, 261
Biological notes, 37, 66, 149, 150, 223, 403
Bifurcated crystal from asthmatic sputum, 242
Black plague, 224, 360
Blood-corpuseles, counting, 312
Blood, filariæ in the, 317
 hemoglobin in the, 167
 in general paralysis, 316
 in urine, 248
 of scarlatina, 221
 stains, 401
 test for tuberculosis, 331
 films, malarial, 357
Boccardi, Dr. B. 406
Bodio, Professor, 222
Bolley, H. L. 187
Books and microbial disease, 219, 258
Borax carmine, 31
Borden, W. C. 113, 193, 249

- Bovines, excrement of, 188
 Brain of turtle and sparrow, 4
 Branching algae, 274
 Bristol, Prof. 403
 Britton, N. L. 322
 Bronze and gold paints, 218
 Bujuid, Prof. 154
 Busch, F. C. 167
 Cabinet, slide, 311
 Cale, Geo. W. 131, 349
 Camera to enlarge images, 368
 Canada balsam, 282
 Canal, bacteria of the intestinal, 104
 Carmine, borax, 31
 Carnegie Library, 368
 Cars, railway, 362
 Carter, F. B. 19, 25, 57, 62, 96, 98, 163, 241
 Cattle tuberculosis, 331
 Cell, a growing, 346
 theory, objections to the, 66
 wall of amoeba, 268
 Cells-animal tissues, 349, 385
 atlas of nerve, 37
 staining methods of, 131
 wax, 63
 Cement, aquarium 218
 liquid, 33, 249
 Chancroid, bacillus of, 226
 Chantemesse, Prof., 402
 Cheese, ripening of, 68
 Chemistry of bacteria, 148
 Chlorophylogenous plants, 274
 Cholera microbes, 402
 vibrio, 223
 Cicada Septendecim, 45
 Clayey deposits, study of, 228
 Clearing vegetable sections, 249
 Cocaine, insolubility of, 308
 in the study of pond life, 95
 Coffee and disease germs, 223
 Commissuralis, obelia, 291
 Comparative morphology of the brain
 4
 Concours, international, 286
 Condenser, parachromatic substage,
 66
 Congress of medicine, 363
 Conjunctiva, normal, 373
 Conjunctivitis, acute, 313
 Conjunctivitis eczematosa, 220
 Conser, H. N. 95
 Contagion, 258, 362
 Cope, E. D. 322
 Corneal ulcers, 220
 Corpuscles, counting, 312
 Correspondence, 309, 365
 Cracow, diphtheria, 257
 Crouch, Dr. H. C. 69
 Crystal from asthmatic sputum, 242
 Culture media, 183
 micro-organisms, 8
 tube in diagnosis, 107
 Cunningham, K. M. 228, 298
 Cutter, Ephraim, 72, 112, 242, 296, 331
 Cyclosis, 273
 Cystin, 296
 Death, black, 360
 Deaver, John B. 98
 Development of negatives, 113
 Diagnosis of bacteria, 148, 315
 of diphtheria, 69
 Diatomaceous deposits, study of, 228
 Diatoms, 107, 165
 Dicoocura, 163
 Diphtheria, 69, 107, 186, 224, 257,
 Dirty sponges, 362
 Disease germs and coffee, 223
 of squash-bug, 402
 tsetse fly, 394
 Diseases, venereal, 362
 Drawings, micro-photographic, 36
 Dried plants, 250
 Drugs, 269
 Duclaux, 68
 Dust in sanitarium, 222
 Eclampsia, origin of, 106
 Editorial, 27, 64, 100, 141, 177, 216,
 247, 284, 309, 355, 360, 397.
 Edwards, Arthur M. 52, 227, 346, 370
 Elementary biology, 261
 Enzyma, of some yeasts 321
 Epidermis of the onion, 264
 Epithelium in urine, 248
 Etiology of acute conjunctivitis,
 313
 Examination of flour, 398
 of foul sea water, 38
 of opium, 68
 of skin, 34
 of urine, 316, 359
 of tubercle bacilli, 150
 Excrement of bovines, 188
 Excretion of micro-organism, 360
 of pathogenic microbes, 288
 Exhibiton of Washington Society,
 215
 Falsifications of pepper, 148
 Fever, 240, 253
 Fibres, smooth-muscle, 131
 Filariæ in the blood, 317
 Filicic acid, 287
 Filtration, mechanical, 89
 Fischer, L. 209

- Fixing solution, 164
Flagella, 30, 174
Fleischl methods, 167
Flour, examination of, 398
Flies, 219, 288, 394
Fluid, staining, 31
Fluorescent bacteria, 150
Foote, Charles J. 373
Forceps, cover glass, 182
Fox, anthrax in, 154
Free-swimming medusae, 291
French Congress of Medicine, 363
 method of purifying water, 320
Fresh water deposit, 165
Friedlander, pneumobacillus, 254
Fungus, ringworm, 286
Gage, Susanna Phelps, 4
Gibbs, Wolcott, 364
Geology, diatomology in, 107
General Index, 284
Germ content of air, 187
Germs, coffee and disease, 223
 flies carriers of, 219
 in ice, typhoid, 307
 in mother's milk, 256
Gold and bronze paints, 218
Gowers methods, 167
Growing cell, 346
Growth of organisms, 69, 106
Habermaas, M. D., A. 385
Hæmoglobin in the blood, 167
Hance; Irwin H. 222
Handkerchief, 189
Harwich, C. 153
Havemann, 69
Hayden Fund, 363
Heredit of acquired immunity, 256
Hereditary tuberculosis, 314
Hernia, strangulated, 403
Histology's sake, 355
Holland, W. J. 368
Houghton, E. M., 155
Huie, Miss Lily H. 103
Hyatt, J. D. 45
Ice, typhoid germs in, 307
Identification of Infusoria, 26
Infectious diseases, treatment of, 256
Infectiousness of dust, 222
Influenza in children, 209
Injection in rheumatism, 319
 rectal, 288
Immunity, 256
Improving cheap microscope, 101
Influence of lecithin, 106
Infusoria for identification, 26
Ingraham, Charles Wilson, 112
Instruments in use, 100
Intestinal bacteria, 104
Investigations, bacteriological, 220
Jean, Ferdinand, 8
Karyokinesis, 278
Keratitis, 220
Kerr, Jr., A. T. 167
Ketasalo, 187
Key to Radiolaria, 19
Kiessling, Dr. Fritz, 148
Kitasato, 360
Klemperer, 69
Krauss, William C. 1, 136
Lanceolatus, micrococcus, 186
Laudry's paralysis, 315
Lard and cocaine, 308
Laryngoscope, the, 285
Latham, V. A. 9, 29
Lawrence, Geo. M. 226
Lecithin, 106
Lee, T. G. 226
Leprosy in Russia, 208
Letters to the Editor, 72
Leuconostoc mesenteroides, 403
Levy, 69
Life, lowest forms of, 370
 study of, 73, 95
Lille exposition of hygiene, 406
Lincoln Club, 110, 152,
Liquid cement, 249
Liver, mammalian, 265
Long Island, Bacillariaceæ of, 52
Lungs of plants, 223
Magnifiers, aplauatic, 66
Malaria, plasmodia, 318
Malarial blood-films, 357
Malt, enzym in 321
Mammalian liver, 264
Manufacture of bacterial products,
 155
Marine, fossil 352
Marsh fever, 253
Mast-cell nuclei, 349
Mason, O. G. 367
Mass. General Hospital, 364
Media, aqueous, 378
 culture, 183
Medical Microscopy, 69, 106, 150,
 189, 223, 256, 288, 316, 361,
 403
Medusæ, free-swimming, 291
Mechanical filtration, 89
 stage, 143
Mercer, Alfred Clifford, 41
Metals, study of, 298
Meteoric paper, 244
Method of staining, 30
Methylen blue, 399
Microbe of scurvy, 255
Microbes, pathogenic, 361

- Microbian disease, 219, 255
 Micro-Cement, spirit-proof, 33
 Micrococcus lanceolatus, 186
 Micro-organism, excretion of, 360
 anaerobic, 8
 and the cholera vibrio, 223
 inspired air, 185
 in scarlatina, 221
 X rays on, 184
 Micrometallography, 290
 Micro-photographic drawings, 36
 Microscope, a new, 217
 as an advertiser, 190
 in surgery, 189
 novel, 143
 Microscopes and exhibits, list of, 99
 improving cheap, 101
 Microscopic diagnosis of diphtheria,
 69
 examination of opium, 68
 fixing solution, 164
 objective, modern, 13
 objects, 359
 objects and camera, 367
 specimens, 358
 Microscopical apparatus, 66, 101,
 113, 182, 217
 examination of flour, 528
 manipulation, 30, 103, 148, 183,
 218, 249, 286, 312, 357, 397
 notes, 320, 363, 415
 preparations, 276, 429
 societies, 9, 71, 109, 141, 151, 191
 225, 289, 362, 404, 438
 Microscopist wanted, 405
 Migula, Dr. W., 188
 Milk, bacillus tuberculosis in, 40
 bacteria in, 184, 187
 mother's, 256
 Mineral substances, 298
 Minerals, distinguishing, 139
 Missouri Botanical Garden, 247
 Mjoen, Dr., 68
 Modern microscopic objective, 13
 Moissan, Prof. H., 364
 Monod, Henri, 187
 Monument to Pasteur, 310
 to Robert B. Tolles, 64
 Moore, Veranus A., 174
 Morphology of the brain, 4
 Morris, J. W., 391
 Motile bacteria, 174
 Mounting specimens, 249, 282, 430
 Muller, Dr., 396
 Muscle fibers, 151
 Musee d' Histoire Naturelle, 405
 Nature of bacterial products, 155
 New Britain Scientific Association, 99
 Nerve cells, atlas of, 37
 Negatives, Photomicrographic, 113
 Nephritis, suppurative, 289
 New Publications, 111, 192, 226, 257,
 322, 365, 406
 Immunity protective inoculation,
 111
 Don'ts for Consumptives, 112
 The best waters to Drink, 112
 Keil's Medical Directory, 192
 Primary Factors of Organic Evo-
 lution, 226
 Modern Microscopy, 257
 The Crambide of North America,
 257
 Microscopical Studies in Botany,
 258
 Asiatic Cholera in India, 258
 An illustrated Flora, 322
 Ernst Mach's Scientific Lectures,
 365
 Mikrotechnik der thierischen mor-
 phologie, 365
 Advantages of Chastity, 406
 New Orleans, small-pox in, 224
 Nocard, M., 62
 Norton, George W., 291
 Nuclei, mast-cell, 349
 Nucleus of amoeba, 268
 N. Y. State University, 405
 Obelia commissuralis, 291
 Objective, a modern microscopic, 13
 Objectives, marking, 136
 Objects, microscopic, 359
 Onion, epidermis of, 264
 Opium, examination of, 68
 Orford, Henry, 13
 Organisms, growth of, 106
 Origin of eclampsia, bacterial, 106
 of rickets, microbial, 255
 Osborn, H. L., 261, 409
 Oscillaria, 273
 Osterhout, W. J. V., 378
 Ovaries of Scilla patula, 103
 Oxalic acid, 250
 Oysters, 402
 Paints, gold and bronze, 218
 Pan-American Congress, 182
 Paguin, Dr., 69
 Parachromatic condenser, 66
 Paralysis, Landry's, 315
 blood in, 316
 Paramaecium, 268
 Parrots and pneumonia, 62
 Partnerships in plant life, 73
 Pasteur, 285, 406
 a monument to, 310
 Pathogenic microbes, 288, 361

- Penicillium, 275
 Pentinastrum, 25, 58
 Pepper, falsifications of, 148
 Personals, 226, 364, 406
Perspiration and pathogenic microbes,
 288
 Pflaum, M.' 63
 Phacotriactis, 61
 Pharmaceutical, 190
 Photographic drawings, 36
 Photomicrography, 113, 193, 249
 Physiology of amœba, 267
 of vorticella, 270
 Pittfield, R. I. 30
 Plague, black, 224
 Plant-life, 73, 225, 431
 Plasmodia malaria, 318
 Pneumobacillus, 254
 Pneumonia, conveying, 62
 Pond-Life, study of, 95
 Postal Club, 362
 Potato, cells of, 262
 Prentiss, A. N. 364
 Preparations, rapid method, 286
 malarial blood-films, 357
 Preservation of specimens, 358
 Products, bacterial, 155
 Protococcus, 271
 Purifying water, 320
 Pus, bacilli in, 287
 Queckett Club, 71, 109, 151, 191, 225
 Radiolaria, 57, 58, 61, 96, 98, 138,
 161, 163, 241
 a new species 25, 62
 classification of, 19
 Railway cars, 362
 Ramosus, bacillus, 149
 Ravenel, M. P. 402
 Reaction of tuberculin, 186
 Rectal injection of serum, 288
 Rheumatism, acute, 319
 Rhizopods, 370
 Rhopalastrum? anomalum, 59
 Rickets, 255
 Rindfleisch, Professor, 150
 Ringworm fungus, 286
 Rogers, Mr., 69
 Root, senega, 153
 Rousselet, Charles F. 33
 Ryder, John Adam, 364
 Sage, C. Edward, 308
 Samson, Rene, 259
 San Diego Society, 290
 Sanitation in Italy, 222
 Scale, San Jose, 323
 Scarletina blood, 221
 Schizomycetes, 188
 Scientific Association, 99
 Scientific instruments, 216
 Scilla patula, ovaries of, 103
 Scott, Bryce, 247
 Scurvy, microbe of, 255
 Sections, vegetable, 249
 Sedgwick, Adam, 66
 Serum, antidiphtheric, 288
 for infectious diseases, 256
 injection, 319
 in smallpox, 313, 361
 treatment, 257, 429
 Senega root, 153
 Septendecim, Cicada 45
 Setchell, W. A. 378
 Shadbolt, Walter P. 38
 Sheffield society, 151, 225
 Sidney University, 364
 Skin bacteria, 31
 Slides, 177, 216
 Slide cabinet, 311
 Smallpox, 224, 361
 antitoxin, 313
 Smegma bacilli, 397
 Smiley, C. W. 227, 259
 Smith, Erwin F. 403
 Smooth-muscle fibers, 131
 Societe belge de Geologie, 248
 Societies, microscopical, 9
 Solution, fixing, 164
 Solutions, vegetations of, 149
 Sparrow, 4
 Specific gravity method, 167
 Specimens, microscopic, 358
 mounting, 249
 Spirit-proof micro-cement, 33
 Spirogyra, 272
 Sponge, dirty, 362
 Sputum, asthmatic, 242
 Squash-bug, 402
 Squire, P. W. 31
 Stage, mechanical, 143
 Staining bacillus tuberculosis, 40
 flagella, 30
 fluid, 31
 methods, 69, 131, 349, 385
 of ringworm fungus, 286
 Stains, blood, 401
 Starch-grains, 97
 Starr, M. Allen, 37
 Staurococcura, 96
 clavigera, 164
 cuneata, 162
 loculata, 161
 Stauralastrum trispinosum, 241
 Stedem, Druggist, 190
 Stentor, 271
 Sternberg, George M. 111, 118
 Strangulated hernia, 403

- Studies in elementary biology, 261
 Substage condenser, 66
 Suppurative nephritis, 289
 Surgery, microscope in, 189
 Sutton, Harry J. 58, 61, 138, 161
 Swarts, Gardner T. 89
 Symbiosis, 73
 Tariff on instruments, 216
 Telephone and tuberculosis, 362
 Tempere, M. J. 107
 Tenia, 305
 Test for tuberculosis, 331
 Tobacco and cholera microbes, 402
 Tolles, Robert B. 64
 monument, 72
 Transactions of the American Society,
 141
 Tricresol on Pathogenic Microbes, 361
 Tsetse fly, 394
 Tube, culture, 8, 107
 Tubercle bacilli, 150, 397
 Tuberculin, 186
 Tuberculosis and flies, 288
 and telephone, 362
 avian, 254
 cattle, 331
 hereditary, 314
 staining bacillus, 40
 Tuberculous handkerchief, 189
 Turpentine, 312
 Turtle, 4
 Typhoid bacilli, 315
 fever, 240
 germs in ice, 307
 Tyrothrix, 68
 Unicellular animals, 271
 Unna, P. G., 34, 36, 131, 349, 385
 Urinary examinations, 359
 Urine, 216
 blood in, 248
 epithelium in, 248
 examination of, 316
 Utah Society, 109
 Vagina, bacteria of the, 313
 Vaseline, cocaine in, 308
 Vegetable sections, 249
 Vegetations of solutions, 149
 Venereal diseases, 362
 Vibrio, cholera, 223
 Vorticella, 269
 Waite, M. B. 403
 Ward, H. B., 305
 Ward, H. Marshall, 149
 Washington society, 215, 404
 Water, foul sea, 38
 purifying, 320
 Waters, bath, 391
 Watson & Sons, W. 66, 248
 Wax-cells, 63
 Weiss, Professor, 73
 Wenham, F. H. 143
 White's objects, 284
 Whooping cough bacillus, 283
 Winkler, 68
 Wisdom vs. knowledge, 397
 Women in science, 248
 Woodhead, Dr. 406
 X rays on micro-organisms, 184
 Yeast, 274, 321
 Zululand, tsetse fly disease in, 394

QH
201
A35
v.17

The American monthly
microscopical journal

Biological
& Medical
Serials

PLEASE DO NOT REMOVE
CARDS OR SLIPS FROM THIS POCKET

UNIVERSITY OF TORONTO LIBRARY

STORAGE

