



LIBRARY OF CONGRESS.

Chap. 127 Copyright No. ....

Shelf B45

UNITED STATES OF AMERICA.











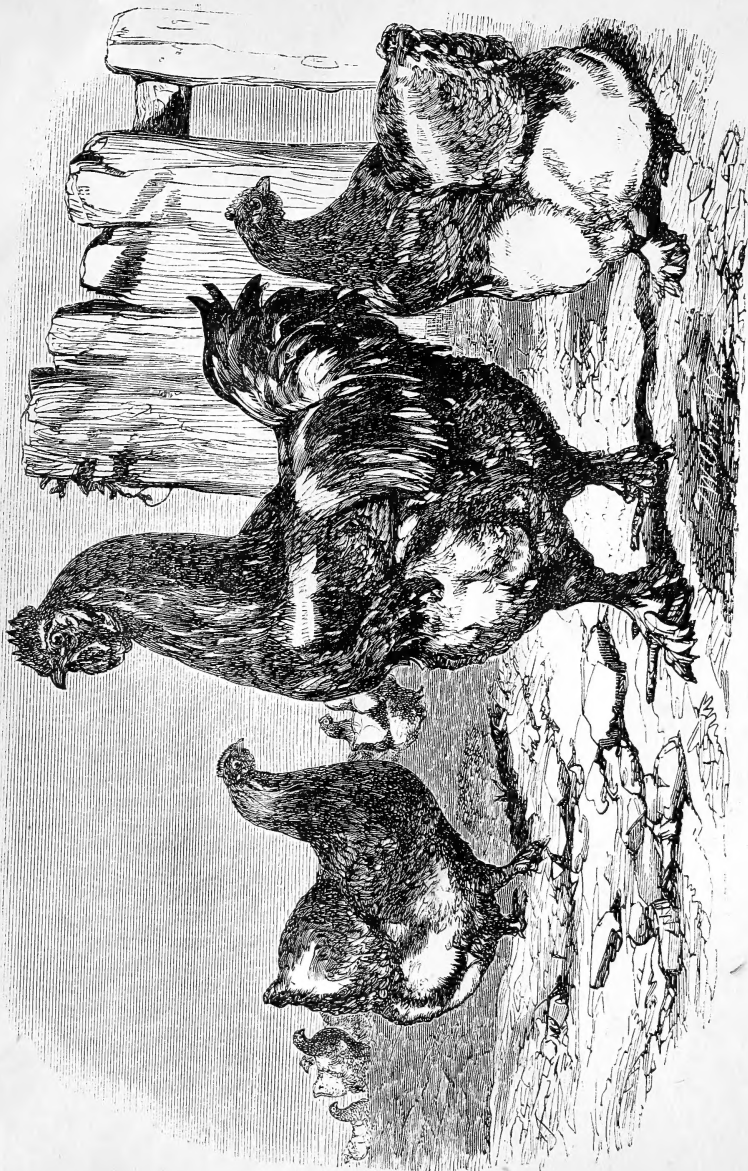

GROUP OF ASIATIC FOWLS.



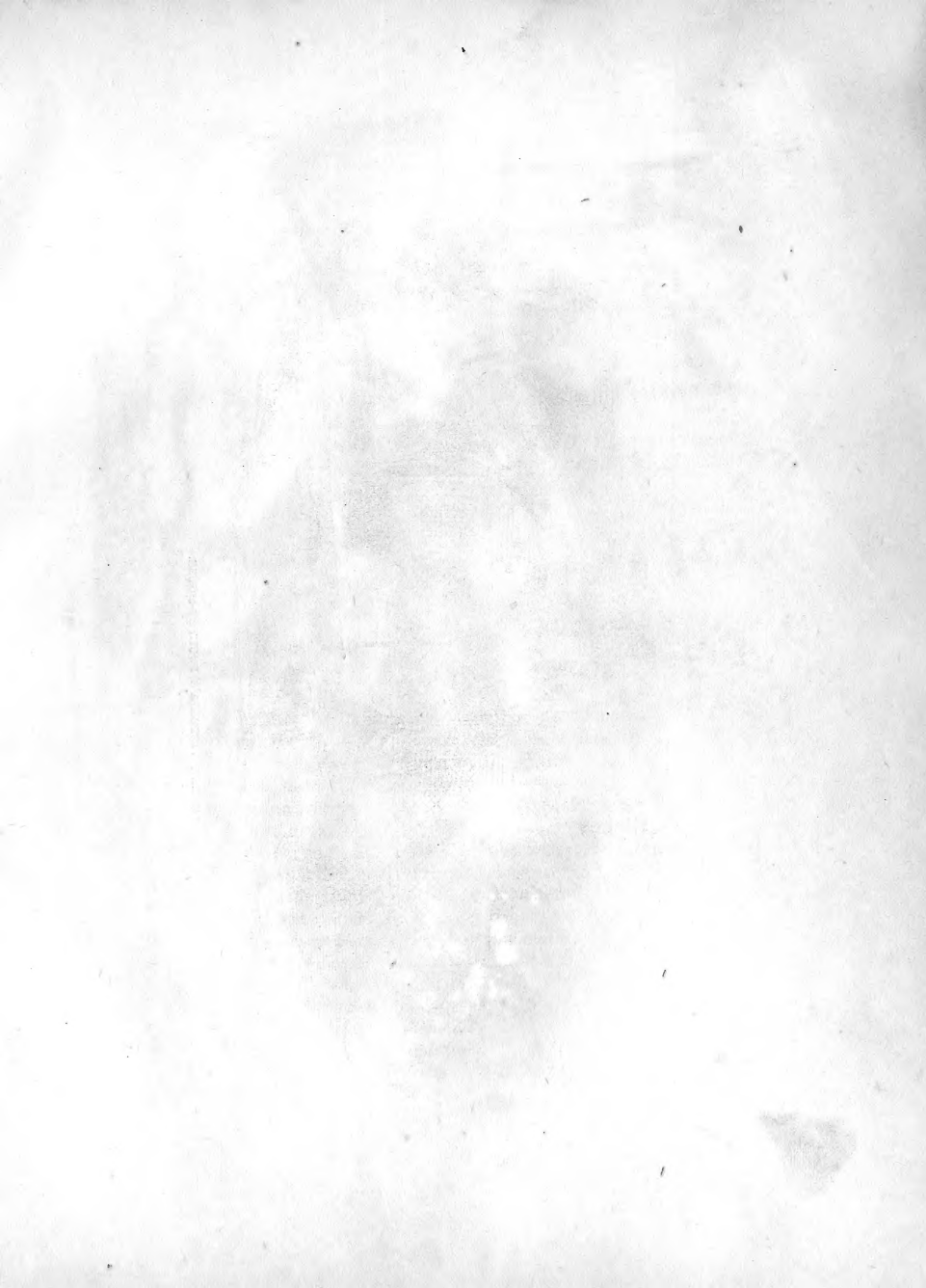

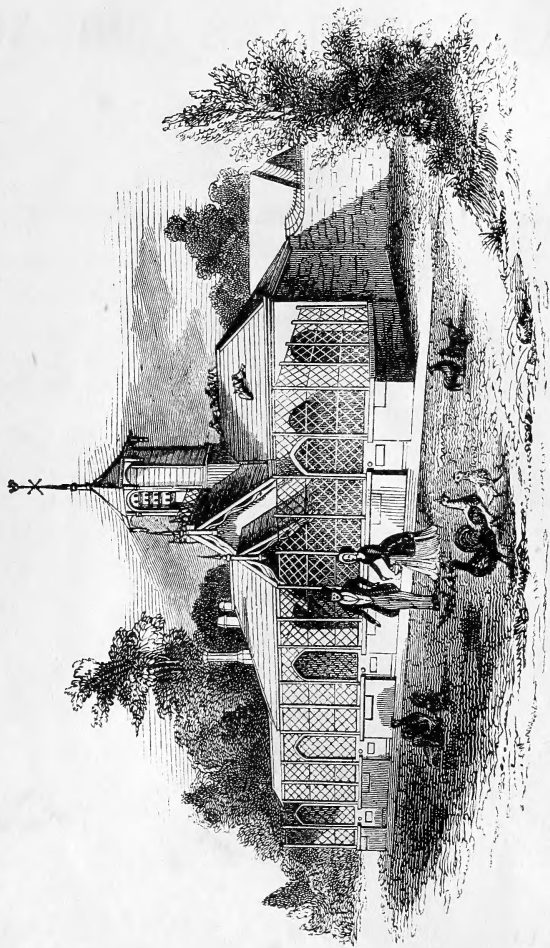

QUEEN VICTORIA'S POULTRY-HOUSE.

THE  
AMERICAN POULTERER'S COMPANION.

A Practical Treatise

ON THE

BREEDING, REARING, AND GENERAL MANAGEMENT OF  
VARIOUS SPECIES OF

DOMESTIC POULTRY.

ILLUSTRATED WITH PORTRAITS OF FOWLS, MOSTLY TAKEN FROM LIFE;  
POULTRY-HOUSES, COOPS, NESTS, FEEDING-HOPPERS,  
&c., &c., &c.

A NEW EDITION, ENLARGED AND IMPROVED.

BY C. N. BEMENT.

WITH 120 ILLUSTRATIONS ON WOOD AND STONE.



NEW YORK:

HARPER & BROTHERS, PUBLISHERS,  
FRANKLIN SQUARE.

1856.

SF427

.B48

Entered, according to Act of Congress, in the year one thousand eight hundred and  
fifty-six, by

HARPER & BROTHERS,

in the Clerk's Office of the District Court of the Southern District of New York.

## P R E F A C E.

---

IN laying before the public this new, enlarged, and much improved edition of the "American Poulterer's Companion," the author deems it necessary and not out of place to offer a few remarks regarding the undertaking. The work was first commenced in consequence of the urgent solicitation of numerous friends, who professed to think that I was well qualified for the task, and an authority upon which reliance could be placed, from the fact that the main portion of my lifetime had been devoted to the subject of poultry; for from my earliest youth I have taken great delight in studying, comparing, and admiring our numerous varieties of domestic fowls, which tend so much to enliven and adorn our farm-yards.

Impressed for a long time with the belief that poultry, under proper management, might be made as profitable, according to the capital invested, as any other branch of industry properly connected to farming; and with the view of satisfying myself on that point, I kept an accurate account of expenses and income, and found, on footing up the account, my previous opinion confirmed. From this register of results I have been enabled to draw such observations as I hope may be found correct and useful to such as seek information on the subject.

It is a common saying, that if we would sit down and write that which we have practically learned upon almost any subject, the information imparted could scarcely fail of being useful. Just so far my ambition extends. Nor is the world entirely without need of advice on this subject, notwithstanding its antiquity and the multitude of counselors. Of this fact I have had am-

ple proof in my numerous visits to various parts of this country, where I have found, in too many instances, that a sufficiency of poultry could not be raised for the use of the family, notwithstanding large numbers were kept, in consequence of the want of care and attention in supplying them with proper food and shelter. And many have houses and yards for their poultry, who, in the use of them, are only guided by random suggestions or unwise examples of their neighbors. They follow in the old beaten track, and, perhaps, even indulge a prejudice against all written instructions which lead them to change their course. To such I would recommend this work, as unfolding no gigantic projects, indulging in no useless theories, tempting to no rash experiments, but exhibiting plainly, practically, and profitably, the best mode for the management of poultry. With this view I undertook the pleasing and delightful task. Although my labors are humble, I hope they will not be the less useful. I have not the vanity to suppose that I have excelled in every thing, but I fondly hope that the path may be rendered more distinct and smooth for future progress.

It is now more than eleven years since the "American Poulterer's Companion" was first published. It was the pioneer of American works devoted to poultry, and has passed through several editions. When I commenced it, very little attention had been paid to the rearing of poultry. The profits arising from fowls were generally considered too insignificant to enter into the calculations of the farmer; and, consequently, the improvement of poultry was pretty much neglected in this country. In fact, many farmers considered them rather a nuisance, and "cost more than they come to." To be sure, there were a few connoisseurs who had imported some Game and Dorking fowls; but beyond that I have no reliable information. More attention had probably been paid to the Game than any other breed. Occasionally some Malay fowls were brought in our merchant ships, and found their way into the country, which very much improved the size of the common farm-yard fowl.

The object of rearing poultry and eggs for market may appear to some but a trifling concern; but a glance at the poultry statistics in the closing chap-

ter of this volume will probably surprise and astonish many who had paid little or no attention to the amount consumed, or been in the habit of reflecting on the various items that go to swell our agricultural prosperity.

In my endeavors to keep pace with the improvements of the age, I have been actuated by the most liberal views in obtaining the best and most reliable information that could be obtained on the subject, suited to the practical breeder as well as to the amateur or novice.

Among the novelties of the age is the excitement that has been manifested within a few years, in this country and Europe, on the subject of improved breeds of poultry. "It has had the effect of calling attention to the subject," say the editors of the *American Agriculturist*, "not only in the different breeds of fowls, but to the care and general management of them, and much good will arise from it. It has awakened public attention to the true value of poultry as an article of domestic stock, or creatures of sufficient merit and beauty in themselves to render them worth attention beyond the common fowls of the barn-yard. The extravagances, however, which have grown out of it, have afforded the lovers of fun not a few occasions for jest and merriment; for not a few of our notable savans in business and professional fame became as much absorbed with this branch of research as they would have been previously in matters out of which fortunes were to be made. Positively it was ungenerous to laugh at them for this new type of human character. Thousands, as notable as they are, have evinced, in relation to other matters, similar gushing impulses. Rarely does a year roll round and pass away without leaving on its tombstone some corresponding inscription of a new-fledged zeal that marked its authors for unenviable notoriety."

Every one who directs his thoughts to the subject, will at once acknowledge that poultry are just as capable of improvement as any other farm-stock, by breeding from selected specimens, and the beneficial results arising from this attention to superior parentage are already very marked. From my own experience these facts are very apparent, and no one conversant with poultry can attend our markets without seeing evidences of great improvement. Many specimens show increased compactness, roundness, and

symmetry ; shorter leg, clean head and neck, fuller and closer feathers, etc. ; still much remains to be accomplished. For information how this further improvement is to be achieved—for authority deciding what are the defects to be avoided, and the excellences to be arrived at—for sound practical directions in management—for accurate particulars of the good and bad characteristics of varieties, and for information on other points, all naturally turn to works published relative to poultry. Now we all know that no one has sought such aid without, in a measure, being disappointed. To remedy this defect, as near as possible, is the object of this work.

In preparing this volume, no expense has been spared in the embellishments, as the best artists have been employed. Some of the spirited and lifelike portraits on wood were drawn by Mr. K. Van Zandt, of Albany, from living specimens in possession of the author. I hope, therefore, to merit the approbation of the public, and trust the work, in this new form and dress, will be favorably received, and found to combine the utmost economy and utility, united at the same time with elegance and the facility of obtaining the desired end. In no other work, I believe, can be found so many portraits of fowls, and other embellishments. In short, my object and aim in this volume has been to furnish a full, authentic, and reliable work, adapted to meet the demand growing out of the interest recently manifested on the subject. And in the hope that it will serve to diffuse more widely reliable information in respect to the very important subject on which it treats, prove a welcome and valuable acquisition to the libraries of practical men, be found amusing and instructive to the young, and successful with the old and judicious, I make my bow, and intrust it to the public.

C. N. BEMENT.



# C O N T E N T S.

## CHAPTER I.

### GENERAL VIEWS: DOMESTIC POULTRY.

Choice of the Cock.....	33	Laying.....	36
Choice of the Hen.....	34	Fecundity.....	37
Selecting and Breeding.....	34	Profits.....	38
Management.....	35	Food.....	39

## CHAPTER II.

### POULTRY-HOUSES.

Victoria's Poultry-house.....	47	Browne's Poultry-house.....	57
Lord Penryn's Poultry-house.....	47	New York Poultry-house.....	59
Mowbray's Poultry-house.....	48	Rustic Poultry-house.....	60
Scotch Poultry-house.....	49	Poor Man's Poultry-house.....	60
Octagon Poultry-house.....	50	Rhode Island Poultry-house.....	62
Our own Poultry-house.....	51	Virginia Poultry-house.....	63
Ornamental Rustic Poultry-house.....	53	Van Nuxen's Poultry-house.....	64
Cottager's Poultry-house.....	54	Cheap Poultry-house.....	64
Fancy Poultry-house.....	55	Duck House.....	65

## CHAPTER III.

### ACCESSORIES TO THE POULTRY-HOUSE.

Plans for Nests.....	66	Nest Eggs.....	72
Wicker-work Nests.....	68	Feeding Hoppers.....	73
Cheap Nests.....	68	Double Feeding Hopper.....	74
Straw Nests.....	68	Scotch Feeding Fountain.....	74
Curious Nest.....	69	Self-Feeding Hopper.....	74
Secret Nests.....	69	Stool Feeding Hopper.....	75
Barrel Coop.....	69	Perfect Feeding Hopper.....	76
Marque Coops.....	69	Feeding Trough.....	77
English Coop.....	70	Water Fountains.....	77
Close Coop.....	71	Barrel Fountain.....	77
Pen' Coops.....	72	Bottle Fountain.....	77

## CHAPTER IV.

## WILD FOWL.

Sonnerat's Jungle Fowl.....	82	Fork-tail Fowl.....	88
Bankiva Jungle Fowl.....	85	Fire-backed Jungle Fowl.....	89
Ceylon Jungle Fowl.....	87	Australian Jungle Fowl.....	91

## CHAPTER V.

## ASIATIC FOWLS.

Malay Fowl.....	98	Shanghai Fowl.....	104
Kulm Fowl.....	98	Brahma Fowls.....	111
Cochin Fowl.....	101	Emeu Shanghai Fowl.....	114

## CHAPTER VI.

## FARM-YARD FOWLS.

Game Fowl.....	116	Golden-spangled Hamburg... ..	143
Dominique Fowl.....	121	Golden-penciled Hamburg.....	144
Dorking Fowl.....	123	Silver-spangled Hamburg.....	144
Bucks County Fowl.....	129	Specimen Feather.....	145
Ostrich Fowl.....	130	Black Hamburg Fowl.....	145
Bolton Gray Fowl.....	131	Bantam Fowl.....	146
Frizzled Fowls.....	133	Black Bantam.....	148
Silky Fowl.....	134	Java Bantam.....	150
Rumpless Fowl.....	136	Nankin Bantam.....	151
Spanish Fowl.....	138	Sebright Bantam.....	151
Hamburg Fowls.....	141	Creper Fowl.....	154
Silver-penciled Hamburg.....	142	Paduan Fowl.....	155

## CHAPTER VII.

## CRESTED FOWLS.

Black Poland Fowl.....	159	Golden-spangled Poland Fowl.....	167
Golden-crested Fowl.....	162	White Poland Fowl.....	167
Silver-crested Fowl.....	164	Silver-spangled Crested Fowl.....	168
Russian Fowl.....	165	Ptarmigan Fowl.....	169
Crisp-feathered Fowl.....	166	Serai Taook, or Sultan's Fowl.....	172

## CHAPTER VIII.

## INCUBATION.

Artificial Hatching.....	178	Mr. Cantelo's Hydro-incubator.....	185
Reaumur's Hatching Apparatus.....	179	American Egg-hatching Machine.....	186
Bonnemain's Incubator.....	180	Minasi's Incubator.....	186
The Potolokian.....	184	Scientific Hatching Machine.....	187

## CHAPTER IX.

## FATTENING POULTRY.

Wingate's Method.....	189	Feeding-houses.....	189
-----------------------	-----	---------------------	-----

## CHAPTER X.

## KILLING AND PREPARING FOR MARKET.

Age of Poultry.....	192	Preserving Poultry.....	192
---------------------	-----	-------------------------	-----

## CHAPTER XI.

## DISEASES OF POULTRY.

Apoplexy .....	193	Inflammation.....	199
Vertigo.....	194	Diarrhea .....	199
Paralysis.....	194	Costiveness.....	200
Cartarrh .....	195	Loss of Feathers.....	200
Gapes.....	195	Eating their Feathers .....	200
Pip .....	196	White Comb.....	201
Roup.....	196	Vermin.....	201
Consumption .....	198	Rheumatism.....	202
Crop-bound .....	198	Eating their Eggs.....	202

## CHAPTER XII.

## TURKEYS.

American Wild Turkey.....	203	Honduras Turkey .....	219
Domestic Turkey.....	208	Brush Turkey .....	220

## CHAPTER XIII.

## PEA-FOWL.

Description of the Pea-fowl.....	223	Characteristics.....	224
----------------------------------	-----	----------------------	-----

## CHAPTER XIV.

## GUINEA-FOWLS.

Common Guinea-fowl.....	226	Crested Guinea-fowl.....	228
-------------------------	-----	--------------------------	-----

## CHAPTER XV.

## AQUATIC FOWLS.—THE SWAN.

Mute Swan.....	230	Cygnets.....	233
White Swan .....	231	Black Swan.....	234

## CHAPTER XVI.

## AQUATIC FOWLS.—THE GOOSE.

American Wild Goose.....	236	Barnacle Goose.....	257
Domestic Goose.....	240	Brant Goose.....	259
Toulouse Goose.....	247	Egyptian Goose.....	260
Emden Goose.....	248	Goose-houses, Nests, etc.....	261
African Goose.....	252	Diseases of Geese.....	262
Chinese Goose.....	254	Plucking Geese.....	263
White Chinese Goose.....	255	Fattening Geese.....	264

## CHAPTER XVII.

## AQUATIC FOWLS.—THE DUCK.

The Mallard Duck.....	265	Aylesbury Duck.....	274
Black East Indian, or Buenos Ayrean Duck.....	266	Crested Duck.....	276
Musk or Brazilian Duck.....	267	Hook-billed Duck.....	277
Wood Duck.....	270	Penguin Duck.....	277
Mandarin Duck.....	271	Canvas-back Duck.....	277
Rouen Duck.....	272	Red-head Duck.....	279

## CHAPTER XVIII.

## WILD BIRDS SUSCEPTIBLE OF DOMESTICATION.

Curassow.....	290	Prairie Hen.....	295
Crested Curassow.....	290	Pheasant.....	297
Galeated Curassow.....	291	Cock of the Plains.....	298
Capercaillie, or Cock of the Wood.....	292	California Partridge.....	299
Ruffed Grouse.....	293	Great Bustard.....	300

## CHAPTER XIX.

## POULTRY STATISTICS.

Foreign.....	301	Domestic.....	303
--------------	-----	---------------	-----

# LIST OF ILLUSTRATIONS.

## LITHOGRAPHS.

	PAGE		PAGE
Malay Prize Cock .....	98	Ptarmigan Chickens, Male and Female....	169
Shanghai Cock and Hen .....	104.	American Wild Goose .....	237
Lemon Cock and Hen.....	107	Toulouse Geese.....	247
Game Cock and Hen.....	118	Black East Indian Ducks.....	266
White Dorking Cock.....	126	Rouen Ducks .....	266
Gray Dorking Cock.....	128.	American Wood Duck.....	270
Spanish Cock and Hen.....	140	Chinese Mandarin.....	271
Gold and Silver-laced Bantams.....	151	White Aylesbury Ducks .....	274
Black Poland Cock and Hens.....	161	Canvas-back and Red-head Ducks.....	277
Golden Spangled Poland.....	167	Prairie Hen.....	295

## WOOD ENGRAVINGS.

Group of Domestic Fowls.....	31	Scotch Feeding Fountain.....	74
Victoria's Poultry-house .....	45	Self-feeding Hopper .....	74
Octagon Poultry-house .....	50	Stool Feeding Hopper .....	75
Our own Poultry-house .....	51	Perfect Feeding Hopper.....	76
Ornamental Rustic Poultry-house.....	53	Feeding Trough .....	77
Fancy Poultry-house .....	55	Barrel Water-fountain.....	77
Browne's Poultry-house.....	57	Bottle Water-fountain .....	77
New York Poultry-house.....	59	Japanese Wild Fowl .....	78
Rustic Poultry-house .....	60	Sonnerat's Jungle Cock.....	83
Poor Man's Poultry-house.....	61	Sonnerat's Jungle Hen .....	84
Cheap Poultry-house .....	64	Bankiva Jungle Cock .....	86
Duck House .....	65	Specimen Feather of Ceylon Fowl .....	88
Secret Nests .....	66	Fire-back Jungle Cock.....	90
Wicker-work Nests.....	68	Fire-backed Jungle Hen.....	91
Barrel Coop .....	69	Australian Jungle Fowl .....	92
Tent Coops.....	70	Group of Asiatic Fowls .....	95
English Coop.....	70	Malay Cock and Hen .....	99
Close Coop.....	71	Group of Cochins .....	102
Pen Coop.....	72	Yellow Buff Cochins.....	104
Cheap Feeding Hopper.....	73	Shanghai Fowls.....	105
Double Feeding Hopper.....	74	Group of Brahma Fowls.....	109

	PAGE		PAGE
Emeu Shanghai Hen .....	114	Bonnemain's Incubator .....	180
Shawl-necked Game Cock .....	117	Reaumur's Artificial Mother .....	182
Dominique Cock .....	122	American Egg-hatching Machine .....	186
Dominique specimen Feather .....	123	Wild Turkey .....	204
Group of Dorkings .....	124	Domestic Turkey .....	209, 215
Bucks County Cock and Hen .....	129	Honduras Turkey .....	219
Ostrich Cock and Hen .....	130	Brush Turkey .....	220, 221
Bolton Gray Cock and Hen .....	131	Peacock .....	223
Bolton Gray specimen Feather .....	132	Guinea Hen .....	226
Frizzled Fowls .....	133	Crested Guinea Hen .....	228
Silky Fowls .....	134	Mute Swan .....	230
Rumpless Fowls .....	136	White Swan .....	232
Spanish Cock and Hen .....	138	Black Swan .....	234
Hamburg Fowls .....	142	American Wild Goose .....	236
Hamburg specimen Feather .....	143	Domestic Goose .....	240
Silver-spangled specimen Feather .....	145	Embden Geese .....	249
Bantams .....	146	African Goose .....	252
Black Bantams .....	149	Chinese Goose .....	255, 256
Java Bantams .....	150	Barnacle Goose .....	257
Sebright Bantams .....	152	Egyptian Goose .....	260
Creepers or Dwarf Fowls .....	154	Mallard Duck .....	265
Crested Fowls .....	158	Musk Duck .....	268
Black Poland Fowls .....	160	Crested Duck .....	276
Golden-crested Fowl .....	163	Crested Curassow .....	290
Silver-crested Fowl .....	164	Galeated Curassow .....	291
Russian Fowls .....	165	Capercaillie, or Cock of the Wood .....	292
Crisp-feathered Fowls .....	166	Ruffed Grouse .....	294
Silver-spangled Crested Fowls .....	168	Pheasant .....	296
Serai Taook Fowls .....	172	California Partridge .....	299
Reaumur's Hatching Apparatus .....	179	Great Bustard .....	300

# THE AMERICAN POULTERER'S COMPANION.

---

## INTRODUCTION.

UNTIL within the few last years, it is not extravagant to say that the improvement of poultry was pretty much neglected in this country; and it is only since the year 1840 that we have been aroused to an appreciation of their value. It is now, however, generally admitted that the rearing and keeping of poultry has become an important branch of rural economy, and that it is just as susceptible of improvement as any other kind of farm stock, by breeding from selected specimens.

The beneficial results arising from this attention to superior parentage are already marked; and no one conversant with poultry can attend our exhibitions without seeing collected evidence of increased and increasing attention and improvement. At the same time, every specimen affords testimony quite as apparent that much yet remains to be accomplished; and to impart information how this improvement is to be achieved—to decide what are the defects to be avoided and the excellences to be arrived at—to give accurate particulars of the good and bad characteristics of the different varieties, and to remedy the latter are the objects of this work.

Among the novelties of the age is the excitement that has been manifested within the last few years, particularly in some of the Eastern States, on the subject of improved poultry. The extravagances that have grown out of it have afforded the lovers of fun not a few occasions for jest and merriment; for not a few of our notable *savans* in business and professional fame became as much absorbed with this branch of research, as they would have been pre-

viously in matters out of which fortunes were to be made. Indeed we have seen these gentlemen as much galvanized with sleeping zeal to ascertain whether a particular variety of fowls should have four toes or five, as in collecting and adjusting the newly-found bones of the famous sea-serpent, or of a mammoth in a new locality. But it was ungenerous to laugh at them for this new type of human character; for thousands as distinguished as they are have evinced in relation to other matters similar gushing impulses—the Multicaulis speculation for instance. Rarely does a year roll round and pass away without leaving on its tomb-stone some corresponding inscription of a new-fledged zeal that marked its authors for notoriety.

The motive which led these gentlemen into such perils to their reputation was excellent. The result to the community will be good without doubt. The chaff from their harvest will be blown away or burnt up, but there will be left a residue for use equal to the best wheat. Improvement in the breeds of farm animals is undoubtedly one of the most rational topics that has claim on the attention of the farmer. Individuals who have distinguished themselves in it—and there are several in Great Britain and this country—have achieved a reputation for themselves as undying and far more honorable than that of the greatest generals the world ever had. The feasibility of such improvement has been demonstrated to an extent that places it in the first class of objects in which successful enterprise in rural economy can be promoted. The principles on which such improvement is

predicated are pretty well defined; but the philosophy of these principles is among the unfathomable mysteries of nature. In this matter, as in numerous other ones, human science may advance to certain points; the facts discovered in the progress may be as prominent and incontrovertible as mathematical theorems, and as solid as the foundations of a gigantic mountain, or as transparent as the clear light of noon; but beyond these points human science stands appalled—not a step onward can be made, not a gleam of light dawns upon the untrodden path; in the prospective all is dark and incomprehensible.

Every national improvement in the breed of animals has originated in a certain degree of mania. "If such amateurs had not lavished their money upon the turf," says an English writer, "we should never have had such good horses commonly available; and the same may be said of Short Horned cattle, South Down sheep, and priceless pigs." We most cordially assent to this, and gladly give our opinion that without "this promise of general usefulness" neither the exhibitions themselves would have received so large a share of public support, nor would their promoters have been so anxious for their success. Individuals there doubtless are for whom the Fantail-pigeon and the Lop-eared rabbit possess charms beyond the plumpest Dorking or the tenderest Poland; but how few are they in number when compared to those who encouraged these exhibitions simply from a desire that "twelve months hence eggs should prove better, chickens cheaper, and all poultry more abundant than ever."

All this is literally and emphatically true in relation to animal and vegetable physiology. We know that the different races of men, according to commonly-received theories, have been occasioned, in a long succession of generations, by meteorological influences. But who can tell why these influences in the human species should have led to the difference in organization, complexion, and mental endowment obviously characterized in the native American, the Asiatic, the African, the Malay, and European races? None can tell. Conjectures may be raised; hypothetical explanations may be propounded;

but the real truth lies deeply hidden from human investigation. And who can tell, in the feathered tribes, why there is such an infinite diversity in the plumage for instance? We mean not different species, but simply different varieties in single species. Why is there such an assemblage of varying hues in the silky vesture of the proud and exulting peacock, of the delicate and matchless bird of paradise, or even the beautiful little humming-bird, which seeks nourishment, like the honey-bee, from the flower-garden? Man can no more explain this than he can explain why the same vegetable element whitens in the lily and reddens in the rose; or why in one plant it becomes sweet, in another bitter, and in another acid. These things, and similar ones, are among the unrevealed canons of infinite wisdom. In relation to them the Author of them may and does say to us, as He says to the waves of the sea—"Hitherto shalt thou come, but no farther."

Let us look at the tenants of the poultry-yard, and much indeed will be presented to our view worthy the consideration of the philosopher as well as the rural economist. The latter may easily estimate the pecuniary value of this branch of his investment and care; but can the former as easily tell us why there is an almost infinite diversification in the development of the charming birds that enliven the mansion and the surrounding inclosures on the well-disposed farm—diversification of form, of color, of voice, and of social attributes? Here is a countless number of mysteries in the animal kingdom, which a profound philosopher can no more explain than the most unlettered peasant. These things are beyond human conception. We can no more tell why there is such a variation and commingling of colors in the plumage of the poultry-yard, and why there are such deteriorations in the muscular organization and development arising from successive malproductions, than we can tell by what strange process a portion of the human family have become the pigmies called Aztecs, which attracted so much attention among the curious and philosophical. We may, indeed, say it is from the operation of the law of nature; but of the operative principle of this law



we are as ignorant as we are of the law of attraction that causes the magnetic needle to point to the pole of the north. We know it is so—we know it must be so, from the tens of thousands of cases in which it has been demonstrated; but this is all we know, or all we can know on the subject.

The object of this work is to recommend the breeding and rearing of domestic poultry as one of the branches of rural economy; and this we shall do by setting forth, as well as our abilities will permit, the benefits to be derived from the poultry-yard. This will embrace three distinct objects. The first, that of rearing poultry for amusement and to supply the table of the owner; the second, doing the same thing with a view to profit; and the third, the benignant influences that will arise from it to the various residents of the contiguous mansion, both old and young, male and female—particularly the youthful and female members of the family.

It is believed that we shall be able to satisfy the reader that the culture of poultry is of much more importance than has generally been imagined; and consequently it should become one of the first objects of attention with every family in the country.

Every one should be made acquainted with the fact that some kinds of domestic fowls are more prolific and hardy than others; that some are of greater size; and that the flesh and eggs of some species or varieties are much superior in richness and flavor to others. The many suppose that a "pullet is a pullet, and an egg an egg, and that's an end of it;" not so, however, those gastronomes, the old Romans, according to Horace. The epicures were particular in the variety of their fowls cooked, or that produced their eggs, and even went so far as to distinguish between eggs that were supposed to produce males and females, as will be seen by the following lines:

"Long be your eggs, far better than round;  
Cock eggs they are, more nourishing and sound."

Let it be supposed that there are in this country three millions of families that possess all the conveniences for keeping poultry more or less. The number is doubtless greater; for there is no animal that breathes in the service

of man which has such powers of self-multiplication or productiveness as fowls. Then let it be supposed that to each of the families belong ten hens—surely a moderate allowance! yet this will make thirty millions for the entire country, which, at thirty cents each, constitutes an entire investment of nine millions of dollars. Four chickens to each hen are probably raised for the table, making one hundred and twenty millions of chickens raised every year for that purpose; which, at the same price, will be thirty-six millions of dollars, or forty millions of dollars for both. Again, if each of the stock hens lays only twelve dozens of eggs in the year—less than one dozen in four weeks—there will be a product of eggs in the entire country of three hundred and sixty millions of dozens. These eggs are worth at least two dollars for each hen. But allowing one half to go for feeding them, there will be left a net profit from the eggs of twenty-four millions of dollars annually; making a net profit of sixty millions of dollars from the combined production of eggs and chickens.

Let this result be placed with some of the leading staples of the country. The value of the flour of the country in 1847 has been set down at \$140,000,000. If one half of this is deducted for cost of production, and that is not enough, the value of the poultry is worth more to the country than our wheat crop. And taking similar data for comparison, it is worth double our oat crop, double our potato crop, double our cotton crop, and is equal to our crop of hay. Indeed, taking the statistics of our agricultural productions that year as a guide, there is but one of them that yielded, according to the most favorable calculation, so large a net profit as the poultry. Or if the poultry did not yield as much as supposed, it is because the poultry-yard is unduly neglected, and its products under-estimated. It is affirmed that, with the exception of prime cows, there is not on the farm a single article of produce, whether animal or vegetable, according to the value of the original investment, and to the expense and labor of production, which yields so much clear profit as will come from the poultry-yard, if properly regulated. This assertion is made with confidence, because it is sustained by our own

experience, and by a careful examination of the subject. What better occupation, or, rather, what better amusement can the young members of a family have than to feed and watch over the poultry of a farm? In this way they may clothe themselves and pay for their books, without interfering with the school exercises, or any reasonable labors expected from them in other things.

In this country poultry has ever been considered a luxury, and consequently not raised in such immense quantities as in France, Egypt, and some other countries, where it is used more as a necessary article of food than as a delicacy for the sick, or a luxury for the table. In France, poultry forms an important part of the live stock of the farmer, and it has been said of that country, that the poultry-yards supply a much greater quantity of food to the gentleman, the wealthy tradesman, and the substantial farmer, than the shambles do; and it is well known that in Egypt it has been, from time immemorial, a considerable branch of rural economy to raise domestic poultry for sale, hatched in ovens by artificial heat.

Connected with every farm establishment there should be a poultry-yard. Without it the farm is as incomplete as it would be without a piggery. And there is no reason why poultry should not be considered as a species of agricultural stock, and turned to as good account for both producers and consumers. Indeed, every family in the country, although not devoted to agriculture, should have one. For the mechanic it is important; so it is to the professional man and to the merchant. No direction or rule can be given as to the size of it; whether it shall contain ten hens, fifty, or a hundred. If it is partly designed to produce poultry for market, it may, of course, be proportioned to the demand there is for the products. If these products are wanted for home consumption only, the size of the family should regulate the size of the poultry-house and the number of the tenants. And in each case it is apparent that the amount of feed produced on the premises for the use of the fowls, and the local conveniences which can be appropriated to their accommodation, should have an in-

fluence in deciding how many should be kept. These are matters which all can decide for themselves. What might be expedient for one family would be inappropriate to others. Some, too, are excessively fond of eggs; others care less about them. The same is true in regard to the flesh of poultry. This also will have its influence. More eggs, therefore, and a much larger number of fowls of a better description, ought to be ultimately producible; and this improvement should act on the markets of the country. The consumers of poultry in fact, are very numerous; and but from its unnecessary high price, would be greatly increased. Chickens were selling in the New York market in July, 1855, not weighing much over one pound each, for seventy-five cents the pair. We can see no reason or excuse for this exorbitant charge. If the poultry dealers really fancy they are discharging any public duty, they must needs anticipate greater cheapness and greater abundance in the breed of our domestic fowls. That there has been an improvement in the size of our domestic poultry, is evident from the fact that a few years since, before the fowl mania, dressed fowls brought to our markets would seldom weigh over two and a half pounds each; now they run up to three, and even five pounds each—we speak of the common fowls, as raised by the farmers of the country—and this has been accomplished by crossing with the imported varieties, and with better care.

When fowls were sold by the piece, it was no interest to the farmer to increase the size of his poultry, as a pair weighing only five pounds would command just as much as those of six or seven pounds. Now, since they are more generally sold by weight, size tells the story. A fowl without any specific claim of weight is a very nondescript article; and since we can not as yet see how a couple of fat fowls any way deserving the appellation can be sold at three shillings per pair, no one can reasonably object to pay from ten to twelve cents per pound, according to the season, for poultry, while butcher's meat is from ten to eighteen cents per pound for such pieces as one would wish to see on his table.

Bird fanciers are devoting much of their time

in studying the habits and profits of each kind of fowl, and the best modes for their treatment. It is to be hoped that their labors may prove of value to the community. The subject in this country, as we have said before, till very recently, has attracted little or no attention. It may at first be viewed as too insignificant to merit consideration. This is natural. Little things are frequently treated with contempt, although in the aggregate they assume magnitude surpassing credibility. This is literally so with poultry. Because a fair stock of hens can be bought for two dollars or so, they are regarded as beneath the rank that entitles them even to kind treatment, especially if viewed in connection with expected remuneration. But although the winter stock of hens on a common farm may be estimated at two dollars only, the fair valuation of these hens in the country gives them a commercial importance ranging with some of our best products.

We have estimated the profits of the hen at one dollar per year, in addition to paying for her food. But she must have good accommodation, suitable food, and enough of it; then our estimate is a low one, provided, also, that she is of any good common breed. To show this we give a few statistics on that point.

A correspondent in the *New England Farmer* says that "one of his neighbors kept fifty-four hens, three geese, and nine turkeys, which he valued at thirty dollars and fifty cents. The money received from eggs and the carcasses sold was one hundred and seventy-four dollars and fifty-nine cents, or a clear profit of eighty-five dollars and fifty-one cents." A correspondent of the *Genesee Farmer*, who kept twenty-five hens, says that "the profit from them in the year, after paying all expenses, was twenty-five dollars and ninety-two cents"—a trifle above our estimate. J. H. Austin, of Canton, Connecticut, has stated the net profits for one year on fifteen hens to have been twenty dollars. Mr. Crocker, of Sunderland, New Hampshire, had a net profit of sixteen dollars and ninety-seven cents from seventeen hens in a year. Colonel M. Thayer has also stated that he can make more profit from one hundred good hens than from his farm of two hundred acres. His farm

is called a good one, and he has been accustomed to poultry for fifty years. Of this class we might extend the number to an almost indefinite extent.

And yet there is another consideration to be offered in favor of the poultry-yard. Is there nothing in the feathered tribes that dwell there to gratify the eye or the ear of those who watch over and nourish them? Can not the lover of natural beauty see any thing for admiration in the well-rounded breast and the gradually tapering and gracefully curved necks of these well-chosen and well-fed birds? Is there no beauty in their infinitely variegated plumage? Can human art successfully imitate the silky fineness and lustre of their feathers? Where, it may be asked, is there in the broad creation aught so much to delight the eye as in the poultry-yard filled with a choice collection of beautiful fowls? And is it possible, with all the dye-stuffs in the land or in the sea, for human skill to produce such an assemblage of delicate and brilliant colors, combined and commingled in ten thousand aspects, as are any day displaying themselves in the poultry-yard to the gaze and contemplation of their admirers? If the mansion of the farmer is not ornamented, like the drawing-room of the rich merchant, with costly drapery and tapestry, he may have a poultry-yard exhibiting specimens of beauty that would be the envy of princes.

A. B. Allen remarks: "Some look with regret upon the recent poultry mania which originated in New England, where most of our new notions are hatched. But we regard it as a downright blessing to the country. It has set people to thinking, to comparing, and finally to importing; and we have thereby greatly improved the quality of our poultry, and advantageously and largely augmented their numbers—the direct and inevitable consequence of this excitement.

"There is another important matter," continues Mr. A., "connected with this poultry subject, not to be estimated by dollars and cents, but of far more consequence than either. It is the social and moral influence they exert, especially on the junior members of our families. The flower and vegetable gardens, ornamental

lawn, and useful fields, are all attractive with their varied products of beauty and utility; yet they fail to enlist that sympathy and feeling which attractive animal life affords. How very much more of interest the pet horse, or cow, or lamb, excites among the little ones, or even among the serious, than the choicest trees, or shrubs, or flowers! And as we descend in the scale of size to certain limits, we intensify the interest of our children in the domestic pets. The tenants of the poultry-yards, with their youngling broods, are, of all things, what earliest catch and rivet their attention, and determine their devotion to rural life. By their withdrawing their thoughts from trifling games, vicious sports and indulgences, or idle, worthless habits, a great point is gained toward developing and maturing the future useful member of society. Comparatively few who have not the advantages of an extended farm can indulge in the luxury of improved flocks and extensive herds; but almost every one, not closely hemmed in by the brick walls of a city, can gratify their taste, and excite that of their children, by keeping a few choice fowls. They are far preferable to the usual pets—dogs, cats, and singing birds; there is less danger from disease from them, much more variety, more scope for ingenuity for rearing and attending, and we need not add on which side the profit is likely to be. If for no other reason, then, than to interest the children in a useful, attractive pursuit, we would say to any person who has the room, by all means keep some select poultry.”

It is well known that the constant supervision of most farm animals leads to affectionate familiarity mutually cherished. These animals well know their kind guardian from all others; when fed, they express their grateful looks, and wanting feed, their attitude, their motions, their beaming eyes, are so many beseeching manifestations of hunger. It is not, indeed, human speech; it is not a written language; but their keeper understands them perfectly, and if he is a man of kindness, he fails not to administer to their wants and to cultivate the exercise of their sympathies. Let it be asked if he experiences no pleasure in his intercourse with them, and especially in his ministrations to their ne-

cessities? Does their seeming fondness for him inspire no corresponding emotions in his bosom? Can he look upon them with the heartless indifference that he surveys the stones beneath his feet? Does no reciprocity of feeling spring up beneath them? It is not possible. If it were, he would not deserve the name of man.

The greatest social pleasure felt from an intercourse with, and a supervision of, dumb animals, is that which arises from a supervision of the poultry-yard. This is to be expected. The intercourse is more constant than with any other farm animals. In the time of rearing the young, it is seemingly every hour in the day. The febleness and the recklessness of young birds render this indispensable. In all cases the strength of mutual attachments is proportioned to the degree of constancy of intercourse kept up. This is true in human society. It is equally true in the brute creation. It is also true where they exist between human beings and dumb animals. Even in the stillness of a thick darkness that lulls to rest earth's wide realm, do we experience no pleasure at the un-failing notes of chanticleer proclaiming the hour of midnight or of dawning day? We never hear these notes without emotions of joy.

And with the rising sun what an uninterrupted concert opens among the feathered groups! What a jubilee begins to greet the new-born energies of the world! With a hundred hens constantly leaving their nests there is an uninterrupted succession of their joyful notes. Their mouths do not appear to be large enough to emit all the boisterous emotions that animate them. In the midst of this ceaseless cackling, every now and then their lordly mates cause the surrounding forests to echo with their shrill crowing—and rising above this, at measured intervals, is heard the pompous shout of the gobbler, almost causing the ground, like the discharge of cannon, to tremble beneath him. And if the Guinea-fowl belongs to this community, as if to increase this vocal jargon, or to make burlesque upon it, his harsh voice, not unlike the filing in a machine-shop, is heard for half a mile. If there is not music in all this, there is life in it—there is animation in it.

Whenever witnessed there can be no stupid languor, no lugubrious dullness for want of objects to inspire a feeling of interest, no painful sensation of solitude and loneliness. The human being that gives no responsive emotion to the sounds of this scene must have a heart as impenetrable as adamant, affections as frigid as the ice of the poles, and is, indeed, an outcast from Nature's temple.

Yet far more important in a social or sympathetic view is the pleasure experienced in feeding poultry, and thus making them, as it were, companions. Animal nature is full of social impulses, and these impulses are not confined in their operation to the particular species in which they severally originate. These impulses belong to other animals as well as to man.

In the advancing state of agriculture a peculiar interest is, at the present moment, thrown around every means calculated to advance the interests of rural economy; domestic poultry, though last, not least, now comes in for a share; and we are pleased to perceive that more attention has of late been directed to this subject. There is scarcely an agricultural paper which reaches us that does not contain some inquiries in regard to their management, properties, varieties, etc., etc.

"He who adds," says Boswell, "to the productiveness of any object of nature, which can add a unit to the sum of human subsistence, and which can render that available for the purpose which was wasted or useless before, must be deemed a benefactor to his species. In this light even the rearing a few poultry may be viewed; for by them much of the refuse of the kitchen may again appear on the table in a new and better form; and if to them can be added the rabbit, the pig, and the cow, there is no necessity that any thing be lost or thrown away."

The industrious mechanic can easily associate the poultry-yard to add to the comforts of his family, to render his leisure hours more profitable, and to convert his recreations into a reward. With proper arrangements and attention he may either in a village or city, at a trifling expense, keep at least twenty hens that will furnish each year from ten to fifteen hun-

dred eggs and not far from one hundred chickens, plump and full-grown for the table.

Among all nations throughout the globe, eggs and poultry have been long used and highly prized as articles of food. But the lack of information, or the want of proper attention in the management of fowls, the small quantity and high price of eggs in our markets during the winter season, cause most persons in moderate circumstances to do without them, while those of larger means use them as expensive luxuries.

"Poultry," says an able author, "has been too much undervalued as a means of study and field for recreation. Insignificant and, to us, valueless wild animals, brought from a distance, about whose history and habits we care little or nothing, are received with respectful attention by men of education and ability, and embalmed in spirits, treasured in museums, and portrayed by artists; but a class of creatures inferior to few upon the earth in beauty, useful, companionable, and of great value in an economical point of view, are discarded and disdained."

The importance of raising poultry in a pecuniary point of view, has been little appreciated by the farmer, and on most farms very little attention is paid to the rearing and breeding a greater number than can subsist by picking up waste or refuse grain, or what might escape the pigs and be lost. They are considered unprofitable, and a very insignificant part of live stock on the farm; still, they should not altogether be neglected, for there are very few persons who do not like a *fresh-laid egg* or a *fine fat pullet*; and these are some of the fine things which happily can be had in perfection by the farmer or mechanic, with very little trouble or expense.

A writer in the *Cottage Gardener* says, "Looking at the chicken merely as a machine for the conversion of cheap materials into a costly article of animal food, the point to be considered by those who have this object in view, and would be guided by motives of economy in their selection, is not which machine will consume least of the raw materials (for in any case the equivalent in the manufactured article will be in fixed proportion to the amount of

materials employed), but which will manufacture the article most expeditiously, and give the quickest return of serviceable food; here I think it will not be questioned that the Cochin breed possesses this property in a pre-eminent degree."

The question then naturally arises, which is the most profitable breed to keep? The answer must be, that which feeds best at an early age at the least expense, and that which possesses those properties most valued for food. Where every article of food has to be purchased, and no range can be permitted beyond limited yards and inclosures, there must be sales at fancy prices, and, moreover, great skill to remunerate the outlay; but wherever poultry has been kept as a regular item in the economy of a farm-yard, or even a laborer's cottage, we fully believe that a good breed of Dorking or Cochin China fowls properly managed will justify our present opinion of their merits as early layers, as also for their flesh.

For beauty the Dorkings surpass the larger kinds. They have short legs, small bones, full breasts, beautiful white flesh, quite equal in that to any breed; they fatten quickly—indeed, if well fed, need no cooping for the table.

In spite of their high price, in spite of the prejudice which exists against the Cochin China for the table, and the quantity of corn they are accused of consuming, we do most assuredly believe them to be the best fowl for the poor man and the farmer, considering them not as *fancy*, but only as *productive* stock.

If it be worth the farmer's or cottager's while to keep poultry, it is worth their while to consider how they may do so most profitably, and make the best arrangement for their management in every particular.

It is an acknowledged fact, and it is not the less true, that most old women who live in cottages know better how to rear chickens than any other persons; they are more successful; and it may be traced to the fact that they keep but few fowls; that these fowls are allowed to run freely in the house, to roll in the ashes, to approach the fire, and to pick up any crumbs or eatable morsels they may find on the ground, and are nursed with the greatest care and indulgence.

It is not every one who is in possession of such an abode for his poultry; but wherever, in addition to these advantages, discretion and judgment in the selection of the birds are shown, the fortunate individual will always be a dangerous competitor, both as regards the condition of his older birds, and the vigor, growth, and form of their offspring.

Let us not be supposed, by what has been said heretofore of the necessity of constant attention, to throw any discouragement on poultry-keeping; so far from it, one great object of our present work is to explain *how* it may be so done as best to pay the cost and labor it must entail. But neither in this nor in any other business will it answer for a person to engage without some experience of what they have to deal with, and a careful calculation of outlay and returns. Hoping, indeed, that this book may fall into the hands of very many to whom the profit and loss on their adventure are of importance, our cautions must be plainly given; so that, after all, the columns of the egg-book and the result of sales may not be exceeded by the charges for barley, oats, corn, and a host of other items.

The cottager, the farmer, and the amateur who would wish to make his poultry pay, must each see to this. It is true that, for those fond of such pursuits, there will be much amusement, much daily increase of knowledge of the natural history and habits of our pets; where this alone is thought worth paying for, no one can find fault. But our other friends—and an infinitely larger class are thus comprised—must find themselves remunerated for their investment of money or time. No poultry-keeper, indeed, high or low, has a right to complain of want of success, if he neglects keeping a regular account of food consumed and profit by poultry and eggs sold. Without this he is journeying in the dark, and the usual termination of such undertakings will also, doubtless, be his. This hint, we imagine, may prove of service to very many of those who can least afford to suffer loss by their poultry, and who most desire to increase their gains; for, after all, it is only by following out a regular system of management that any person can expect to satisfy himself that fowls, of whatever breed they may be, do really pay. Many dis-

like the little trouble it may create, and looking upon it as an insignificant item, are apt to say, "*I believe it pays, but can not speak positively,*" and are content to go on as before; but at the same time they have no right to be surprised if their rough calculations neither convince others nor fill their own pockets.

From our own experience we can safely say that there are few parts of the farmer's premises that can be made to contribute, according to the capital invested, more effectually to the comfort of the family, and, if properly managed, to the aggregate profit of the season, than the poultry-yard; and we are pleased to observe that more attention of late has been directed to the subject of domestic fowls. "Take care of the cents, and the dollars will take care of themselves," is an old maxim, and, so far as the farmer's profits are concerned, we think a true one.

But few species of animals are of so much utility as that of the fowl. Whether young, adult, or old, male or female, these birds afford light, wholesome, and strengthening food, which is equally suited to those in good health and to those in a sick or convalescent state, which the art of our modern epicures knows how to transform in a thousand different ways, and always agreeable, but which is not less succulent when dressed with temperate plainness.

But though most farmers keep fowls and raise their own eggs, there are many who have not learned the difference there is in the richness and flavor of eggs produced by well-fed hens and those from birds that have been half starved through our winters. There will be some difference in the size, but far more in the quality. The yolk of one will be large, fine colored, and of good consistence, and the albumen, or white, clear and pure; while the contents of the other will be watery and meagre, as though there was not vitality or substance sufficient in the parent fowl to properly carry out and complete the work that nature had sketched. In order, therefore, to have good eggs, the fowls should be well fed, and also provided with gravel during the months they are unable to come to the ground, that they may be able to grind and prepare their food for digestion.

Of eggs, those from the domestic hen are decidedly the best; but those of ducks and geese may be used for some of the purposes of domestic cookery.

The way in which the farmers in general, in this country, manage their poultry, is not the best for them or the fowls. They are allowed to run where they please, to lay and sit at any time they may deem expedient; when the hen comes off with her chickens, she is suffered to ramble about, exposing the young brood to cold and wet, which thins them off rapidly; no suitable accommodations are provided for their roosting-places, and they are allowed to find a place to roost where they can, probably in some exposed situation in a tree or shed; no attention is given to feeding them; and under such circumstances it is not to be wondered at that few or no chickens are raised, and that fowls are sickly or unprofitable.

When with so little expense to himself a farmer may have an abundant supply of eggs and raise one or two hundred chickens, it would appear strange that the poultry business should be so little attended to by the owners of the soil. Where crops are sown immediately around the barns, it may be inconvenient to have fowls run at large, but in many cases fifty or one hundred of these birds may be kept, not only without injury but with benefit. There are generally large quantities of grain scattered in the barnyards and lost unless eaten by fowls; there are myriads of insects, such as flies, bugs, worms, grasshoppers, etc., which require to have their numbers diminished by the cock and his followers; and even if constantly kept up and fed, experience shows that for the amount of money invested the poultry-yard contributes in proportion as great a return as any other part of the farm.

The following rules may be safely given—and they are useful ones moreover, in many other matters besides those of which we are now speaking: Never keep poultry without thinking it worth your while to give it a fair share of your attention—without satisfying yourself, if your time is otherwise employed, that it has the attention of your servant. Never keep persons for that purpose who do not show, by activity and

forethought, that they are fond of this employment, and who think of it at other times beyond the periods in which they are actually engaged about it. When you are fortunate enough to find these various qualifications united, you may hope for the best, and will probably find that many a useful observation as to the peculiar characteristics of the different breeds, and many a hint that may be profitably acted on, will reward your discrimination.

It is quite certain nothing has become so general or so universally popular in modern times as a taste for the culture of domestic poultry. This has arisen most probably, in a great measure, from the two-fold fact, that though a most exceedingly pleasant recreation, it has proved itself far more remunerative, in a pecuniary point of view, than any other public fancy of recent date; the latter, no doubt, having ensued in no slight degree from the anxiety to obtain first-rate specimens wherewith to compete at the public exhibitions of poultry. A few years since the prices *obtained easily* for fancy fowls would have been considered fabulous, and their purchasers jeered right heartily on the utter possibility of ever "seeing their money again." Time, however, that proves all things, shows that some of those who were thus situated had displayed greater foresight than their neighbors, and thus obtained considerable emolument from a source that had for many years been almost altogether neglected, or the profits of which, thus carelessly and indolently obtained, were only appropriated as "pin-money" for the wife and daughters of the family generally. It is now far different, and many have largely increased their incomes by the produce of some three or four hundred of *well-selected* poultry.

"There appears," says an English writer, "to have been two *radical* errors into which aspirants for poultry honors have by far too generally fallen, *viz.*, the supposition they *might* get very first-rate *produce* from indifferent stock; and others have erred quite as glaringly by adopting the plan of buying, at any price, those fowls *only* that have taken first prizes at the poultry shows. A few moments quiet reflection will tend to prove the fallacy of either plan.

"It is a well known fact that even when fowls are bred from the purest strains, *all the produce* will not evidence equal purity with their parents as to the characteristics of that particular variety to which they belong; it will, therefore, be easily conceived how infinitely removed are the probabilities of obtaining such where the 'blood stock' are only *tolerable* character; and as regards the purchase of first-rate prize pens only, this arrangement is open to the very serious objection that by so doing we have no *change* of blood, and the past experience of many a disappointed amateur *has* proved, and doubtless the dearly-bought knowledge of others *will yet confirm* that the undeviating and inevitable consequences of such 'interbreeding' will be imbecility and deterioration of character in the offspring."

It is hardly necessary to draw the attention of breeders generally to the fact, how few animals in England have *maintained* their superiority for a series of years in any particular variety, unless by the exhibition of the *same* cause which exists when first prize pens only are purchased for breeding stock by a wealthy new beginner. All being from the same blood, their offspring (if any) are puny, weakly, and highly susceptible of disease. These much-to-be-dreaded consequences are easily obviated by obtaining the male birds from one strain, their hens or pullets (as the case may be) from another and different one, then, if well selected, there is but little fear but there will be ample cause for self-congratulation as to their produce for a couple of generations, after which period deterioration will certainly ensue if the same plan is not again repeated.

We will just advert to one other most universal *mistake* into which an unreflecting novice is almost certain to inveigle *himself* unwittingly, *viz.*, a thirst for *more* poultry than he has the means to accommodate; the consequence is, the adult fowls are bad enough, but on the younger branches it acts with crushing effect; and certain it is, that many a one has seen contagion spreading its baneful influences on every side within the precincts of his poultry-yard, without the slightest supposition ever crossing his mind that his own former imprudence was



the foster-parent of all his present troubles. We need scarcely insist on the all-important subject of the most scrupulous care as to cleanliness in every department of a poultry-yard, whether in regard to water, food, or the roosting-houses. If proper attention is *early* given, *good food used*, and the fowls have been carefully and wisely chosen in the first place, we do not fear an unsatisfactory result.

We advocate beginning well, that is, with the best stock that can possibly be obtained; but certainly nothing can be conceived much more absurd than giving twenty-five, twenty, or even ten dollars per head for fowls, at the same time indulging in the hope of our ever making them pay a suitable return. Had not this frequently been done, and even greater prices obtained of late years, there would have been but trifling necessity for maintaining it; but were many who have paid *such* prices candid in their acknowledgments, we doubt not they would themselves admit to having ere this both seen and likewise paid for their inexperience and folly.

At many of the country establishments in Europe the buildings and yards for fowls are arranged on an extensive scale, comprising every necessary building, commodiously planned, and embracing every necessary or accessory required for the natural propensities, the comfort, and the protection of the various kinds: apartments which can be occasionally heated for the tender birds; basins of water which can be frequently emptied and refilled, and several inclosures of grass or orchard grounds as outlets for the poultry to range in alternately. The yards or outlets are also surrounded by high picket fences, to prevent the escape of the fowls or entrance of enemies. A keeper, male or female, is usually appointed to take care of the whole, and receive the orders for the required supplies of the family.

After all, perhaps, there is no better range for fowls, kept in any considerable quantities, nor one that seems so suitable as a well-arranged farmyard with *suitable* houses and accommodations for the poultry. The benefit of untold food, the opportunities of selecting the most sheltered and warm situations for roosting, and the

constant scratching in the straw in the threshing season, were advantages, we are aware, not now generally obtained; but our object in the narration of this is, that though for many years from eighty to one hundred fowls composed the breeding stock, and in summer time the amount was frequently four times that number, the occupants stated they never lost ten full-grown fowls from disease in as many *years*, and that their chief mishaps were from the cattle treading on the chickens when small.

Under this treatment eggs were obtained early in the season, and chickens were produced very much earlier than at the surrounding farms, where no accommodations were provided, while, as the rage for fancy fowls did not then exist, and consequently the returns were entirely limited to their value for the table, the result was far better from the *poultry* than from any other description of stock around the homestead. Chickens reared in this way were always plump and ready—a very significant remark, that at any age they are sure to be in condition. The eggs were anxiously sought for, at much higher than market price, as they could always be depended upon for the purpose of the breakfast-table, and the rich brown color of the shell was a feature that was generally approved.

Any person who neglects fair and legitimate means for profitably increasing the business he is engaged in, because the source from which such increase springs is small, commits an error. Now, this error is very commonly committed in farming stock, as applied to poultry. There are few farmers in this country who do not possess poultry; that is, various descriptions of small inferior birds, which rarely attain size and have not the quality of layers to compensate. Taking an average of farms, large and small, throughout the country, the number of breeding birds on each may be calculated at fifty or more. The usual practice is to allow the birds to breed in-and-in, haphazard; occasionally a *hen* is added, as an “*excellent layer*,” and her small progeny, bred from an inferior cock bird, are kept with the others. On more *carefully*-managed farms occasionally a large *cock bird* of no particular breed is added; but this is the utmost, and the consequence is ap-

parent in the general appearance and smallness of barn-yard poultry.

The mere fact of poultry being kept as a part of farming stock is at once an admission of its necessity. To the man who is content to cultivate his land, and keep the class of live stock, as in by-gone days, little can be said, but a suggestion to the improving farmer may not be cast away. We suppose it to be part of the Anglo-Saxon character to make business of every thing, and, when undertaken, to do it heartily. This may be the reason why the poultry movement is confined to this country and England. That which a few years since was unknown, is now becoming a great pursuit, and affording a delightful and innocent change to those who require it after a day of toil. It has called forth a spirit of emulation, and, true to our first remark, it has endeavored to turn it to account. The same mania assumes the same feature in each country; exhibitions, sales, and friendly paper war. Both quote from each other's papers, and the judgments of certain breeds are carefully canvassed on either side of the Atlantic.

For good poultry there is a sale, and where there has not hitherto been, they will supply one. The fact that they are to be had of a good quality will cause a demand to be made for them. In all cities there is always a demand, and, like other provisions, there are different periods for different prices; and here it is that Poultry Shows do much good in offering premiums for early maturity. If those who have facilities for rearing chickens in March or even February, take them to market in May and June, or even July, they can not fail to receive a remunerating price, say from thirty-seven and a half to fifty cents per pair for chickens four months old; at this season, less than thirty-seven and a half cents would be ridiculously low.

For early spring chickens such prices are necessary, when the cost of production is duly considered; and this at once indicates the main point toward which the improvement of Poultry Societies should be directed—the combination, as nearly as may be, in one bird, of early maturity, hardihood of constitution, and excellence, no less than quantity of meat.

A few more words as to the age at which we should *kill*, and the system on which we should *feed*, and then follows the main point—how much per head it costs to keep them, and what profit over and above the outlay.

Four months is long enough for any early cockerel to exist that is destined for the kitchen; if a late bird, and consequently of slower growth, add another month to his life; but let him not, under any circumstances, exceed the six. He is killed then with the most profit, whether for our own consumption or for sale. Pullets will usually be ready from three months till they are about to lay, during which they would be greatly depreciated for the table. Here observe the quick return; and surely it will be admitted that no other breed of fowls can rival the Cochin China and Brahma breed in this particular.

The following deserves attention. A consideration most valuable to the poor man, and to those who have their interest at heart, is the indifference of Cochin China or Brahma fowls to first-rate accommodation. They are very robust and healthy, very seldom ill, and less easily injured, from the egg-shell upward, than most kinds.

Whatever may be the result of the poultry mania, it is unquestionable that the demand for poultry will continue. Immense numbers of fowls are being disposed of daily, and although the supply may be greatly increased, it is unequal to the demand. It was said years ago, that when canals and railroads were completed, horses and oats would be unsalable. Every one who has paid any attention knows that has not been the fact, for horses and oats were never higher than at present, and it will be so with poultry. We are entirely without statistical returns on the subject, but if they were compiled, people would be astonished at the great consumption both of eggs and poultry.

Poultry, except to rich people, has always been a luxury; it may still continue so during a few months in the year; but there is no reason why in the autumn and winter months it should not be within the reach of those whose means are small. It can be raised at little expense and sold at a reasonable rate, and where-

ever it is offered for sale, purchasers will also be found.

There is so much truth and practical good sense in the following remarks, by A. B. Allen, in the *American Agriculturist*, that we can not resist the temptation of transferring them to our pages: "It is within ten years past only that public attention has been somewhat awakened to the true value of poultry as an article of domestic stock, or as creatures of sufficient merit and beauty in themselves to render them worth attention beyond the rude clowns of the barn-yard, or the pence-saving economy of the common housewife. In the multiplied objects, however, which increased intelligence and luxury are continually adding to the demands of country life, the resources of the poultry-yard have been drawn into active requisition. The various species, kinds, varieties, and tribes of the whole domesticated feathered world have been examined, their merits canvassed, and their subjects appropriated to the use, pleasure, and amusement of our people to a degree certainly never equaled since our country had a population. As a matter of taste they have become a branch of the fine arts—'high art,' as poor Haydon, in his enthusiasm for art-progress, would have called it.

"There is as much science, taste, and art in breeding poultry 'to a feather,' as in breeding a horse to the highest racing or trotting speed, and to our notion, quite as useful to the world at large—and, in their consequences, vastly less productive of the questional commodity of *fast* men than the latter pursuit. We have sat at the dinner-table where grave and reverend gentlemen sipped their wine and bobbed their heads toward each other with the most potential dignity, and where wine vaults, the years of their vintage, and the manner of their keeping, were discussed for hours together, and not a single idea eliminated during the whole sitting; and if in place of such a bore, the company could have adjourned to a well-bred poultry-yard, and discussed the merits of its several inhabitants, with the taste and intelligence which they deserved, each one would have been the wiser in head, and better in stomach and body for the transition.

"We are not going to talk now of fowls as economical things, or as a branch of domestic stock. This question, we take it, has been, from time immemorial, settled in the affirmative. For present purposes we are content to consider them as an amusement, an ornament, as a subject of beauty, of interest, and as a *study* for the leisure hours of the country or the town, or city resident either, if opportunity favors their keeping. Nor are we about to find fault with, or to criticise the taste of any one in the selection of a variety, or the several varieties that he may keep, although we frankly confess that we never fancied the monstrous Asiatic fowls that are at present so highly popular. We admire the medium sized and more graceful birds that show finished breeding and high quality, as we would prefer the refined and blood-like Arabian to the large Clydesdale or Canestoga draught horses. Such, however, is only individual opinion, and the wherefore need not at this time be discussed.

"The great show at Barnum's, contrary to general expectation, brought out altogether the finest, largest, and choicest exhibition ever witnessed in America. Of their kinds, there were scarcely a pair of inferior birds in the collection—and many fowls came five hundred miles for the occasion. This very fact shows that poultry fanciers within striking distance of New York have confidence in the society, in its managers, in the ability of Mr. Barnum to carry it out, and in his integrity to do what he promised. So far all was well, as, of course, it should be.

"As an evidence of the interest felt among the fanciers of all ranks and all fortunes, except the rascally low and worthless (not an individual of these, have we learned, that made an offering on the occasion), they sent their birds, generally attended by themselves, and took a lively interest in every thing that appertained to the proceedings. We saw highly distinguished scientific gentlemen, lawyers, and statesmen of great repute; grave divines, "wise with the lore of centuries;" merchants and commercial men, called, by way of eminence, 'millionaires;' artisans, farmers; men of no occupation, sometimes styling themselves, by way of

notoriety, gentlemen—singly, and with their wives and daughters and little children, all eagerly threading their way through and by each other, themselves constantly around or stopping to gaze at the coops and cages, intent on seeing every thing, examining a great many birds, and holding spirited conversations at various points and angles of each of the great halls where the chickens were congregated; and not once only, but repeatedly, day after day, during the show, did we see some of the same individuals, groups, and families.

“Now this means something. People would not congregate at this inconstant season, from fifty to five hundred miles distant to witness a ‘chicken show’ in New York, unless there was ‘something in it.’ *There is something in it.* There is a study in it; a subject for investigation; a delightful contemplation in natural history, to speculate upon the almost numberless varieties that are produced, and their beautiful, harmonious arrangement of plumage, shape, and all the wonderful qualities they possess. They are a thing to love, to interest young minds, and old ones too, who have enough of the natural left in their artificial thoughts to appreciate any thing. They are among the things that make country life interesting, and attach people to home, and make it pleasanter to them than all the world beside. It shows, too, that the world is growing better in domestic feeling and home attachment—that little things are worth looking after, and although of no great magnitude, that one had better feel interested in a chicken, goose, duck, or pigeon, than not be interested at all—and children and young minds, if not amused by innocent things, will surely become interested in vicious ones.

“To breed a good chicken, duck, goose, or turkey—a good animal of any kind—requires thought, skill, observation, study, and genius. Not so much either, perhaps, as to be a finished

sculptor or painter; but *breeding perfect models in form, grace, and plumage*, is an accomplishment in the fine arts, as well as to perpetuate their similitudes in marble, or fix them on canvas.”

The following remarks upon fowls in general we find in the New York Journal: “Fashion is very eccentric in the different forms it takes, and often breaks out in unlooked-for ways and upon unthought of subjects: and in nothing has it been more violent or more absolute than in poultry. Politics, metaphysics, religion, stocks, have been in many places banished from every circle for more edifying and profitable discussions upon the relative merits of Shanghais or Cochin Chinas. Country gentlemen have taken to experimenting on various breeds, and a vigorous speculation is often carried on upon Fowl Exchange, equaling, if not excelling, the interest and excitement at the Board upon the fluctuations of undiscoverable mining and coal companies that are blessed with names above—their ‘local habitations’ being beyond the power of man to discover. In Wall Street, where pups and mice, rabbits, birds, candies, fruits, big Irish men with little mock-watches, jujube-paste, pop corn, cutlery, things to eat, to wear, to look at, and to put to no use or ornament whatever—in Wall Street, where, upon every step and curbstone, these things assemble, prominent among all are Cochins, Chittagongs, Malays, Spanish, Shanghais, Dorkings, Rumpkins, Frizzled, Bantams, and innumerable others, where shrill and loud crowings mingle with the chink of gold, and the incessant jargon of bargain and sale. And no more interesting feature does the busy mart present, judging from the admiring crowd, who are gathered continually around them. The sales of these fancy birds in this street amount daily to a large number. They bring extraordinary high prices, and there are doubtless many shrewd breeders who skillfully keep up the passion, thereby reaping large profits.”

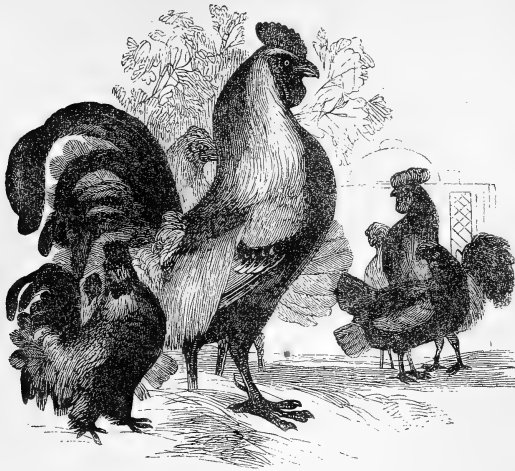

## CHAPTER I.

## GENERAL VIEWS: DOMESTIC POULTRY.

UNDER the term Domestic Poultry, are understood the cock and hen, turkey, duck, goose, pea and guinea fowl, to which perhaps may be added, the swan. Although fowls used for the table are, by nature, granivorous, yet all the various species, the goose perhaps excepted, are carnivorous likewise, and great devourers of fish and flesh.

By propagation and crossing, gallinaceous fowls have been distributed into endless variety; but without including the more marked breeds, Dr. Bechstein distinguishes eight varieties of the common barn-yard fowl; *viz.*, the fowl with a small comb; the slate-blue fowl; the silver-colored fowl; the chamouis-colored fowl; the ermine-like fowl; the crowned fowl; the widow, which has white tear-like spots on a dark ground; and the fire and stone-colored fowls. It is difficult, however, in many cases to identify the distinctions mentioned by foreign writers with the fowls bred in this country.

If one wishes to be acquainted with the nature

and the inclinations of fowls, one is obliged to have recourse to the poultry-yard; for we know nothing of the habits of wild fowls; but a long bondage has operated such great alterations in the nature of our fowls, that it is not easy to come at their original character. For instance, the tame fowl makes no nest; the wild one surely does. The fecundity of the former is in a measure unbounded; except in the moulting season, it lays almost incessantly; analogy will not allow us to doubt but that, in the wild tribe, the laying must be considerably confined, and that it takes place only at regular times.

The cock is to the farmer a living clock, where exactness, to be sure, is not quite so correct as some of our Connecticut-made wooden clocks; but is sufficient, nevertheless, to point out the divisions of the day and night, of labor and rest.

The attitudes of the cock are those of haughtiness; he carries his head high; his look is bold and quick; his gait is grave; all his motions bespeak a noble assurance; he seems to reign over

the other inhabitants of the poultry-yard. His activity is indefatigable, and he is never deficient in vigilance. Constantly taken up with his mates, he warns them out of danger, gets before them, and if obliged to yield to force, which robs him of one, he for a long time expresses by loud outcries his anger and his regrets; feeling for their suffering, he again utters loud and sonorous exclamations, when by their cries they announce the pains or fatigues of laying. A softer clucking is the signal by which he calls them; his unusual shrill crow is, at the same time, the expression of his continual vigilance, the cry of victory after an engagement, and the accent of satisfied love. It was formerly thought that the cock and the nightingale were the only day birds that sung and crowed at night; other species also warble after sunset; but all, as well as the nightingale, are quiet when the season of love is over; whereas the tame cock crows every day and every night throughout its whole existence. However, there is some ground to presume that it is otherwise in a state of nature, and that the crowing of the wild cock is no more, as with other birds, than the momentary accent of his loves.

If the life of the domestic cock be an uninterrupted series of enjoyments, it is also commonly a continual scene of war. As soon as a rival comes forward, the fight begins, and only ends by the retreat of one of the champions. Sometimes both rivals die in the battle. If one of them be conqueror, he immediately celebrates his triumph by repeated crowings and by flapping his wings. The other disappears, abashed at being defeated.

Less spirited than the males, hens are also milder and more timid; though they fight with each other, and, for a moment, with ten times more fury than the cocks. Their voice is less sonorous; but its different modulations show that they, as well as the cocks, have a varied language; after having laid, they utter loud cries; if they call their chickens together, it is by a short, grave clucking; they warn them out of danger by a monotonous and lengthened cry, which they repeat till the bird of prey is out of sight; in fine, they keep up, between themselves, a continual cackling, which seems to be a coherent conversation between these

very chattering females. There are some hens which faintly imitate the crowing of the cock; they are usually the young ones of the year, and they do not always keep on this mimic fancy, as I have ascertained by following several of those crowing hens, which happened to be at different times in my poultry-yard. As to the rest, they had none of those exterior characters which could bring them near the cock; they lay like the rest, and it is wrong that they should be generally proscribed as either barren or as ill-omened. The housewives of Lorraine, and several other parts of France, are forward in putting to death every hen that imitates the crowing of the cock, which in their eyes is the effect of a charm; hence a very jocular saying, in which there is some meaning: "A hen that crows, a parson that dances, a woman that talks Latin, never come to any good."

"In the mythology of the ancients," says Main, "the cock was the symbol of vigilance. Polytheism consecrated it to Minerva and Mercury; it was offered to Æsculapius, the God of Medicine, on recovering from illness. The Romans used to keep sacred pullets, and they undertook nothing of consequence before they had consulted the auspices of this prophetic fowl. Its meals were solemn omens, which regulated the conduct of the senate and the armies."

The cock is remarkable for his haughty, grave, stately gait, for his courage and vigilance, for his attachment to his hens, for his amorous disposition, and his means of satisfying it.

The cock begins paying his addresses to the hens from the time he is four months old; his full vigor only lasts three years, though he may live till ten. It is remarked that in cocks of the large species, the procreative qualities are later in coming forward; they probably enjoy it longer. As soon as the cock gets less nimble he is no more worthy to figure in the seraglio; his successor must be the finest, the most brave of all the supernumerary young cocks in the poultry-yard.

Peace does not continue long between cocks, among which the empire of the poultry-yard has been divided; as they are all actuated by a restless, jealous, hasty, fiery, ardent disposition.

their quarrels are frequent, and generally very bloody. A fight soon follows the provocation. The two adversaries face each other; their feathers are bristled up, the neck stretched out, the head low, the bill ready; they observe each other in silence, with fixed and sparkling eyes. On the least motion of either they set off together, they stand stiff, rush forward, and dash against each other, and repeat the same manoeuvre, till the one that is most adroit, and is the strongest, has torn the comb of his enemy, has thrown him down, by flapping him with his wings, or has stabbed him with his spurs.

The disposition of cocks for fighting so desperately, especially when they are not used to live together, and meet for the first time, the courage and obstinacy which they evince in this often dreadful contest, have given Englishmen the idea of exhibiting these cock-fights in public. It is that sort of tragedy they seem to like in preference. The annals of these sights mention a very singular sympathy between two cocks. They had successively beaten all the others; they could never be made to fight together, notwithstanding the stimulus of the most hateful passions.

Mowbray relates the following: "Every one has heard the horrible story of Ardesoif of Tottenham, who being disappointed by a famous game-cock refusing to fight, was incited by his savage passion to roast the bird alive, while entertaining his friends. The company, alarmed by the dreadful shrieks of the victim, interfered, but were resisted by Ardesoif, who threatened death to any who should oppose him: and in a storm of raging and vindictive delirium, and uttering the most horrid imprecations, he dropped down dead. I had hoped to find this among the thousand fanatical lies which have been coined on the insane expectation that truth can be advanced by the propagation of falsehood; but to my sorrowful disappointment, on a late inquiry among the friends of the deceased miscreant, I found the truth of the horrible story but too probable."

#### CHOICE OF THE COCK.

On the opposite page we introduce a white Dorking as a "model cock" of the domestic

C

fowl. The artist, however, has given him rather larger legs than belong to the breed.

The choice of the cock is a very important thing. It is accounted that he has every requisite quality, when he is of a pretty good size, when he carries his head high, and has a quick, animated look, a strong and shrill voice, the bill thick and short, the comb of a fine red, and in a manner varnished; a membranous wattle of a large size, and colored the same as the comb, the breast broad, the wings strong, the plumage dark, the thighs muscular, the legs thick, and supplied with long spurs, the claws supplied with nails rather bent, and with a very keen point; when he is free in his motions, crows often, and scratches the earth with constancy, in search of worms, not so much for himself as his mates; when he is brisk, spirited, ardent, and clever in caressing them, quick in defending them, attentive in soliciting them to eat, in keeping them together in the day, and assembling them at night.

"The courage of the cock," says Mr. Dixon, "is emblematic; his gallantry admirable; his sense of discipline and subordination most exemplary. See how a good game-cock of two or three years' experience, will, in five minutes, restore perfect order in an uproarious poultry-yard. He does not use harsh means of coercion, when mild will suit the purpose. A look, a gesture, a deep chuckling growl gives the hint that the turbulence is no longer to be permitted; and if these are not effectual, severe punishment is fearlessly administered. Nor is he aggressive to birds of other species. He allows the turkey to strut before his numerous dames, and the Guinea-fowl to court his single mates uninterrupted; but if the one presumes upon his superior weight, and the other on his cowardly tiltings from behind, he soon makes them smart for their rash presumption. His politeness to females is as marked as were those of Lord Chesterfield to old ladies, and much more unaffected. Nor does he merely act the agreeable dangler; when occasion requires, he is also the brave defender."

There are some cocks, which, by being too high mettled, are very snappish and quarrelsome. The way to quiet these turbulent ones is plain;

their foot must be put through the middle of a bit of leather in a round shape; they become as quiet as men who are fettered at their hands, feet, and neck.

The cock loves cleanliness; he is careful of his coat; you often see him busy in combing, polishing, and stroking his feathers with his bill. If, like the robin and the thrush, he has not the ambition of excelling in his note, one may at least think that he is particularly jealous in showing that he has a very loud, shrill, and powerful voice. In fact, when he has crowed, he listens to know whether he is answered; or, should he hear another, he begins again directly, and he seems to defy him to raise his voice above his own. Often of a dark night, this crowing, repeated by every cock in the village, has reached the ear of the benighted traveler, and has enabled him the better to direct his steps.

#### CHOICE OF THE HEN.

The good qualities of hens, whether intended for laying or for breeding, are of no less importance to be attended to than those of the cock. The hen is deservedly the acknowledged pattern of maternal love. When her passion of philogenitiveness is disappointed by the failure or separation of her own brood, she will either go on sitting, till her natural powers fail, or she will violently kidnap the young of another fowl, and insist upon adopting them. But all hens are not alike. They have their little whims and fancies, likes and dislikes, as capricious and unaccountable as those of other females. Some are gentle in their manners and disposition, others are sanguinary; some are lazy, others energetic almost to insanity. Some, by their very nature, are so mild and familiar, and so fond of the society of man, that they can scarcely be kept out of his dwelling; others seem to say, "Thank you, but I'd rather be left to myself."

#### SELECTING AND BREEDING.

In the selection of breeding stock, whatever variety preferred, avoid, if possible, near relationship, or breeding from birds produced from the same parents. Pullets for breeding should

be selected annually from early spring birds; and they will then begin to lay in the spring of the following year. These birds, if then put with a cock a year or two their senior, will produce finer and more vigorous chickens than older hens. Every second year the patriarch of the yard might be disposed of, and his successor introduced from a different strain. If he is a special favorite, then must the pullets be obtained elsewhere. No cock should be kept more than three seasons, nor a hen more than four, if it is intended to keep them in the highest possible perfection and efficiency. We repeat, avoid relationship in your breeding stock wherever possible. In a state of nature these evils would not have manifested themselves; but in the highly artificial condition in which poultry are now presented to us, the case is totally different, and the remedy must be sought, as with cattle, sheep, and swine, in the constant infusion of fresh blood—the best that may be attainable.

When for the infusion of fresh blood, another cock is to be introduced into the yard, it should be during the autumn, that the hens may become accustomed to him before the important operation of spring commences.

The poultry-yard is a place where the student of natural history will see many things to amuse and instruct. The plumage of birds has always formed an object of pleasing contemplation. The God of nature has shown by it his love of spreading beauty over all his works, and opening up every source for the pure enjoyment of man. The splendid coloring of many of our domestic fowls is not necessary in itself, and must have been bestowed as a means of pleasure to the beholder.

"If people," says M. Reaumur, "are affected with the kind of pleasure so transitory to the enthusiastic florists, who procure it but for a few days, by a world of care and toil, continued through a whole year; if they are affected by the variety and fine combinations of colors in their favorite flowers, the poultry-yard, when well managed, may be made to offer them endless pleasures of the same description."

The greater number of cocks, even of the most common kind, are beautifully penciled.



and when exposed to the play of the sun's rays exhibit the brightest hues, almost rivaling the gorgeous coloring of the rainbow. The hens are sometimes spotted with great beauty and regularity; some white and silvery, others by their bright orange tints appearing golden, and there is of the most common kinds an almost endless variety. In their colors they embrace the opposite extremes of light and shade, and all the tints that lie between them.

These colors are sometimes submitted to very remarkable changes in the same individual, at different stages of their existence. When newly hatched, the acutest poulterer could not predict of what precise color they would become, for it is not found invariably to run in the blood. After moulting, some fowls have been known to turn out a different color from what they were. Even without moulting the feathers of the white have been tipped with black as suddenly as the hair of some men has in the course of a night been turned into gray.

The changes of color which some of the domestic fowls undergo in the process of moulting are most singular and inexplicable. M. Reaumur gives the following instance of change of color, among many others: "One of my hens, readily distinguished by a crooked claw, had feathers of the ruddy-brown color mixed with brown, so common among barn-yard fowls. A year after, she was observed to be almost black, with here and there a white spot. At the second moulting, black was the predominant color, and only a few white patches of the size of a half-crown could be perceived. At the succeeding moult all the black disappeared, and the hen became pure white." In another case of a cock presented to M. Reaumur as a curiosity, the following changes occurred: in the first year he was of the common ruddy brown mixed with white; in the second, he was all over ruddy brown, or rather red without white; in the third, uniformly black; in the fourth, uniformly white; and in the fifth, white feathers mixed with chestnut and brown; while at the next moulting he again became a pure white.

A similar case lately occurred within the knowledge of the author. Passing by a neighbor's yard in the month of July, I observed a

beautiful cock of the Poland variety. His color was red and black, beautifully combined, with a splendid top-knot of white feathers. Wishing to obtain him, I called there in January following, and on inquiry, he was shown to me perfectly white; I objected to him, observing to the owner, that it was a speckled fowl I wished—one which I saw there in the summer. I was then informed that he was the identical fowl, that he was the only cock which had been on the premises, and that when he moulted in the fall his color changed by degrees until every dark feather disappeared.

Dickson, in his work on poultry, with regard to color, relates the following: "I have, at present, a hen of the Spanish breed, which has been of a uniform black for two successive moults, but has now her neck, wings, and tail feathers tipped with pure white. I have another which was all over a silver gray, but has now her head and neck coal black, with a ring of fine white at the base of the neck, while the rest of the body is finely speckled with black and snow white. It is remarkable, also, that this change took place in a few weeks, without any obvious moult, so as to cause her to appear any where bare of feathers."

Mowbray says, "A turkey cock, which was black in 1821, became afterward perfectly white. This extraordinary change took place so gradually that in the middle of the moulting the bird was beautifully mottled, the feathers being black and white alternately."

#### MANAGEMENT.

It is best to intrust the management of fowls to some trusty person, who can be depended on; and no other person, except the keeper, whom the fowls know, and the voice and sight of whom rejoice them, must go into the hen-house, for fear of scaring or disturbing the hens busied in laying.

The proper persons, or those who generally understand the art of rearing poultry, are females, who, accustomed from their infancy to look after the poultry, are acquainted with every particular of rearing, the different processes it requires, and the alterations which circumstances compel to bring forward.

It is well said by Beatson that poultry, when rightly managed, might be a source of great profit to the farmer; but where many are kept, they ought not to be allowed to go at large, in which case little or no profit can be expected; for not only many of their eggs will be lost, and many of themselves perhaps destroyed by vermin, but at certain seasons they do much mischief both in the barn-yard and in the field. Poultry, it is thought, ought always to be confined; but if so, instead of a close, dark, diminutive hovel, as is often the case, they should have a spacious, airy place, properly constructed for them.

#### LAYING.

The question is often asked, "Why can not hens be made to lay as well in winter as in summer?" They can, to a certain extent; but they require as a condition, that they be well provided with warm and comfortable lodging, clean apartments, plenty of food, pure water, gravel, lime, fine sand, and ashes to roll and bathe in.

There seem naturally to be two seasons of the year when hens lay; early in the spring, and afterward in summer; indicating that if fowls were left to themselves, they would, like wild birds, produce two broods in a year.

Early spring-hatched birds, if kept in a warm place and fed plentifully and attended to, will generally commence laying about Christmas, or even somewhat earlier. In cold and damp this is not to be expected, and much may, in different seasons, depend on the state of the weather and the condition of the bird.

It is a well-known fact, that from November to February (the very time we are in want of eggs the most) they are to many a bill of expense, without any profit. To promote fecundity and great laying in the hen, it is necessary that they be well fed on grain, boiled potatoes given to them *warm*, and occasionally animal food. In the summer, they get their supply of animal food in the form of worms and insects, when suffered to run at large; unless their number is so great as to consume beyond the supply in their roving distance. I found it advantageous, in the summer, to open the gates

occasionally, and give the fowls a run in the garden and in the field adjoining their yard, for a few hours in the day, when grasshoppers and other insects were plenty. I had two objects in view; one to benefit the fowls, and the other to destroy the insects. It will be found that the fecundity of the hen will be increased or diminished according to the supply of animal food furnished.

Hens moult and cast their feathers once every year, generally commencing in August and continuing until late in November. It is the approach, the duration, and the consequences of this period, which puts a stop to their laying. It is a critical time for all birds. All the period while it lasts, even to the time that the last feathers are replaced by new ones, till these are full grown, the wasting of the nutritive juices, prepared from the blood for the very purpose of promoting this growth, is considerable; and hence it is no wonder there should not remain enough in the body of the hen to cause her egg to grow.

Old hens can not always be depended on for eggs in winter, they scarcely being in full feather before the last of December; and then, probably, may not begin to lay till March or April, producing not more than twenty or thirty eggs; and this is probably the cause of the disappointment of those who have supplied themselves at the markets with their stock to commence with, and get few or no eggs. As pullets do not moult the first year, they commence laying before the older hens, and by attending to the period of hatching, eggs may be produced during the year. An early brood of chickens, therefore, by being carefully sheltered from the cold and wet, and fed once a day on boiled potatoes, warm, with plenty of grain, in the feeding hoppers (which will be hereafter described), and occasionally a little animal food, will begin to lay in the fall, or early in the winter.

"When," says Bosc, "it is wished to have eggs during the cold season, even in the dead of winter, it is necessary to make the fowls roost over an oven, in a stable, or to erect a stove in the poultry-house on purpose. By such methods the farmers of Auge have chickens fit for the table in the month of April, a period when

they are only beginning to be hatched on the farms around Paris, although farther to the south. It would be desirable to have stoves more common in poultry-houses near cities, where luxury grudges no expense for the convenience of having fresh eggs.

"Man," says Parmentier, "who thinks of nothing but his own interest, has attempted several means of arousing hens from their torpidity, when they cease at the natural period of the year to lay, inasmuch as it seems very hard to pass through the winter without the luxury of eating new-laid eggs."

M. Reaumur made several experiments with a view to the object in question. A certain class of food and of seeds, he says, are much extolled in many places, as tending to promote the laying of eggs, but nothing has yet been determined by our choice; for in this way the sum of the eggs laid by the hens of a poultry-yard might be distributed in a far more equitable manner over the several months of the year; and if, as is probable, each hen can only produce a certain number of eggs, we should be glad to have a portion of them yearly produced in winter. The necessity we are under of keeping great quantities of eggs in the season when they are laid, causes an uncommon quantity to be spoiled every year, from too long keeping or want of proper caution in preserving them; and hence the importance of the question, "Whether it may not be possible to make hens lay in winter?"

The method adopted by the ancients was rich and stimulant food, such as toasted bread soaked in ale or wine, barley half sodden, tares, and millet.

#### FECUNDITY.

With respect to fecundity, some hens will lay only one egg in three days, some every other day, others every day, and a hen was exhibited at the Fair of the American Institute, at New York, a few years since, that was said to have laid two eggs in a day, and Aristotle mentions a breed of Ilissian hens which laid as often as thrice a day.

According to our experience much depends on circumstances, such as climate, accommo-

datations, feed, and the attention paid to the hens, as to the number of eggs annually produced. It is asserted by Buffon, that a hen, well fed and attended, will produce upwards of 150 eggs in a year, besides two broods of chickens.

The act of laying is not voluntary on the part of the hen, but is dependent upon her age, constitution, and diet. If she be young, healthy, and well fed, lay she must; if she be aged and half starved, lay she can not. All that is left of her own choice is where she shall deposit her egg; and she is sometimes so completely taken by surprise, as not to have her own way even in that. The poultry-keeper, therefore, has only to decide which is the more convenient—that his hens should lay here and there, as it may happen, about his premises, or in certain places indicated to the hens by nest-eggs. Yet it is quite a mistake to suppose that the presence of a nest-egg causes a hen to sit earlier than she otherwise would. The sight of twenty nest-eggs will not bring on the hatching fever; and when it does come, the hen will take to the empty nest, if there be nothing else for her to incubate. Such is her determined inclination to incubate that she will sit upon stones. Any one whose hens have from accident been deprived of a male companion, can not be ignorant of the fact that they have not done so well till the loss has been supplied. During the interregnum matters get all wrong. The poor, desolate creatures wander about dispirited, like soldiers without a general. It belongs to their very nature to be controlled and marshaled by one of the stronger sex, who is kind, though a strict master, and a considerate though stern disciplinarian.

A writer in the *Connecticut Courant* says "a dozen hens, properly attended, will furnish a family with more than 2000 eggs in a year, and 100 chickens;" but from our experience we think this an overestimate, especially for this cold climate. From 80 to 100 eggs per hen a year would be a fair estimate for any number of fowls kept together.

We find in statements from practical writers recorded in our American journals, several instances of very extraordinary products of hens, which will enable us to form some judgment

on the subject; but it must be borne in mind, however, that these statements have been given generally as extraordinary products.

The editor of the *Massachusetts Plowman* tells us that he obtained 7200 eggs in one year from 83 hens—this was his highest number of fowls; he sometimes had less—that for 6744 he received \$100. The whole amount of his cash expenditures was \$56 43, leaving him a balance of \$43 57.

It is stated in the *Farmer's Journal* that from 150 hens 1900 eggs were obtained in the month of January; and that five pullets produced 300 eggs from the middle of October to the middle of April, which is the coldest part of the year.

Mr. Morent furnishes the following remarkable instance: He had three pullets of the Poland variety, which were hatched in June. December the fifteenth following, they began to lay, and from that time to the next December laid 524 eggs—cost of keeping not exceeding \$3 71. They were fed on barley, rice, and peas.

A friend living on Staten Island, informs me that from 55 hens and 7 ducks he obtained in the month of January 182 eggs—in February, 324—March, 792—April, 878—May, 915—June, 746—July, 534—August, 650—September, 346—October, 68—November, 5—December, 69—making in all for the year 5509. Allowing the seven ducks to have laid 70 eggs each, would leave 5019, which, divided by 55, gives an average of 91 eggs to each hen. These hens were fed from six to eight quarts of cracked corn per day, and occasionally boiled potatoes. Averaging the feed at seven quarts per day, we have within a fraction of 80 bushels of corn which, at fifty cents per bushel, amounts to \$40; and allowing the eggs to be worth \$1 50 per hundred, we have \$75 78, from which deduct \$40 for food, including the ducks, and we have a profit of \$35 78, besides 60 chickens, which, at 20 cents each, would swell the profits up to \$47 78. He gives the preference to the crested variety for eggs.

Another friend who resided in the city of Troy, and kept between 30 and 40 hens, obtained eggs from his hens throughout the year; that is, there was not a single day in which he did not obtain some. This he accounted for

by having very early chickens, as when the old hens ceased laying to moult the young pullets commenced. In 1842 he kept between 25 and 30 hens, and obtained 2832 eggs. This, it will be seen, gives a fraction over 94 eggs to each hen, which is nearly double the number we obtained from our hens.

In 1840 my hens commenced laying on the 7th of February, and between that period and the 15th of August, when they commenced to moult, we obtained 2655 eggs from 60 hens; when the year previous, from 100 hens, which were suffered to run at large, we did not get but few over 1000. In 1841 they commenced laying the 8th of January, and continued to lay until the 27th of September, when they ceased entirely, but commenced again on the 13th of October, and continued to lay until the 18th of November, when they ceased, and commenced again on the 1st of December; and up to the 1st of January they produced over 4000 eggs. In 1842 I had 71 hens, which produced within the year 3509 eggs. In 1843 I kept 60 hens, and obtained 3978 eggs.

#### PROFITS.

In order to ascertain by demonstration, and to satisfy myself whether the keeping of fowls were profitable or not, I commenced in 1842 keeping debit and credit account with the poultry-yard. I had 71 hens, 12 cocks, 2 ducks, 2 drakes, 3 turkeys, 1 turkey cock, 5 geese, and 2 ganders—in all 98 head. They consumed within the year as follows:

91 bushels	Wheat screenings,	at 21 cts. ....	\$19 11
6 "	Rye .....	" 5s. ....	3 75
11 "	Millet .....	" 5s. ....	6 62
2 "	Indian Corn .....	" 5s. ....	1 25
3 "	Barley .....	" 4s. ....	1 50
2 "	Indian Meal .....	" 8s. ....	2 00
10 "	Small Potatoes ...	" 1s. ....	1 25
			\$35 48

I obtained 3500 eggs, valued at .....	\$35 09
Sold fowls for .....	2 00
" 9 Geese .....	4 75
" 5 Turkeys .....	1 87
" 30 Fowls .....	5 63
" 60 Ducks' eggs .....	83
" 54 Goose eggs .....	1 62
" 8 lbs. Goose Feathers at 5s. ....	5 00
From which deduct for feed .....	56 79
	35 48
Net profit .....	\$21 31

From the foregoing it would seem that the profits are very small, but it must be recollected that the sale prices are very low, and that I had the misfortune to lose many of my chickens by hawks, and the greater part of my goslings by confining them in a yard, when they should have had the run of the pasture, which would have saved considerable food, and probably the lives of the goslings, and would have made a difference on the credit side. I lost many of my turkeys in the same way. The experience of this-year taught me that it will not answer to confine in too small space either goslings or turkeys after they are half grown.

In 1843 the care of the poultry was intrusted to my son, a lad of fifteen years, and the following is his account rendered on the first of January, 1844.

<i>Poultry-yard,</i>		<i>Dr.</i>
To 69 Hens, valued at .....		\$25 87
15 Cocks .....		7 56
3 Turkeys .....		1 88
7 Geese .....		7 00
1 Fancy Duck .....		1 00
1 Guinea-fowl .....		25
71 bush. Wheat Screenings, at 15 cts. ....		11 25
15 " " Corn " 42 cts. ....		6 00
31 " " Oats " 24 cts. ....		7 44
4 " " Millet " 50 cts. ....		2 00
8 " " Small Potatoes " 25 cts. ....		2 00
32 Fowls purchased .....		15 09
3 Turkeys purchased .....		1 13
		<u>\$88 47</u>

<i>Poultry-yard,</i>		<i>Cr.</i>
By 3978 Hens' eggs, at \$1 per 100 .....		\$39 78
175 Turkeys', Goose, and Ducks' eggs. .		2 56
41 Fowls sold for .....		46 31
30 do. consumed by family .....		7 00
5 Geese sold .....		7 06
3 do. consumed by family .....		2 00
2 Turkeys do. do. ....		1 00
32 bushels Manure, sold for .....		6 00
54 Hens on hand .....		20 25
18 Cocks do. ....		9 00
6 Geese do. ....		6 00
1 Duck do. ....		1 00
16 Turkeys do. ....		5 00
2 Guinea-fowls .....		50
		<u>153 46</u>
Deduct .....		88 46
Net Profit .....		<u>\$66 99</u>

It is also stated in the Report of the Wayne County Agricultural Society, that David Cushing keeps 25 hens, and feeds them with oats, corn-meal, broom-corn seed, and refuse meat, and supplies them with ashes, pounded shells,

etc. They were confined to a warm and dry room in winter. His account is as follows:

<i>Poultry,</i>	<i>Dr.</i>
To investment of stock and fixtures .....	\$50 00
Interest .....	3 50
Feed, 25 bushels of Oats at 20 cts. ....	5 00
Attendance .....	5 00
	<u>\$63 50</u>

<i>Poultry,</i>	<i>Cr.</i>
By 75 dozen Chickens, sold early at 12 cts. .	\$9 38
200 Chickens " " 10 cts. .	20 00
Stock and fixtures on hand .....	50 00
	<u>\$79 38</u>

Leaving a net profit of \$15 88 on an investment of fifty dollars, or an interest of more than 25 per cent. on the capital employed.

## FOOD.

Fowls are, of all birds, the most easy to feed. Every alimentary substance agrees with them, even when buried in manure; nothing is lost to them; they are seen the whole day long incessantly busied in scratching and picking up a living.

In well-fed fowls the difference will be seen, not only in the size and flesh of the fowls, but in the weight and goodness of the eggs; two of which go farther in domestic uses than three from hens poorly fed, or half starved.

The finest, the most imperceptible seed can not escape their piercing eye. The fly that is most rapid in flight can not screen itself from the promptitude with which she darts her bill; the worm that comes to breathe at the surface of the earth has no time to shrink from her glance—it is immediately secured by the head and drawn up.

It is customary to throw to the fowls in a poultry-yard, once or twice a day, a quantity of grain, generally corn, and somewhat less than that which they would consume if they had an abundance. Fowls, however, are more easily satisfied than might be supposed from the greedy voracity which they exhibit when they are fed from the hand. It is well known that, as a general rule, large animals consume more than small ones. There is as much difference in the quantity of food consumed by individual fowls as there is in animals.

It has been found by careful experiments

that the sorts of food most easily digested by fowls are those of which they eat the greatest quantity. They evidently become soonest tired of, and least partial to rice.

It has also been found that there is considerable economy in feeding with wheat, corn, and barley, well *boiled*, as the grain is thus increased in bulk at least one-fourth, and the same bulk seems to satisfy them; but there is no saving by boiling oats, buckwheat, or rye.

It has been ascertained by actual experiment that, in the months of January and February, a common sized fowl will consume, when at command, of corn, wheat, barley or buckwheat, about one gill per day. I was curious to ascertain the quantity of each sort of grain which a given number of fowls when abundantly supplied would consume; and for that purpose I confined one cock and seven hens of the Poland variety. The first feed I gave them was one peck of corn, which they consumed in eleven days. I then gave one peck of barley, which they ate in seven days. The next feed was the same quantity of oats, which they devoured in six days. The like quantity of millet lasted them eight days. The same measure of wheat served them ten days; and the like amount of wheat screenings they devoured in seven days. During these trials they had no other food, except a few boiled potatoes.

M. Reaumur instituted a series of experiments to ascertain the quantity of each sort of grain which a fowl would consume, when abundantly supplied therewith during the day; and in the course of his experiments he discovered many interesting particulars of importance to be known to all those who keep poultry for profit. He found that individual fowls vary very much in the quantity of food which they consume—there being little and great eaters among them, most commonly indicated by the size of the body; that two Bantams might be kept on the same amount of food as one of the largest breed. Even among fowls of the same size and kind, there are individuals which require more food than others, a circumstance that can be only ascertained by trial.

For the purpose of ascertaining the quantities of food consumed, M. Reaumur confined fowls

separately under basket coops; and others in hutches inclosed with wooden gratings, where they had more convenience, even so much as to lay eggs there in the same way as if they had been at liberty. To the hens in each hutch he put a cock, in order that nothing might be wanting to the completeness of his experiments. In some hutches he placed as many as seven hens, and in others as few as two. For several days together, he gave both to the fowls in the basket coops, and to those that lived in company with those in the hutches, the same quantity of grain, measured so as to be more than would fill their crops; and care was taken that the box into which the grain was put for them should never be empty. This box was longer than broad, with a bottom, and a piece of board on each side, projecting about five or six inches, so fixed as to prevent the chance of its being upset by the fowls hopping upon it, while the sides were sufficiently high not to allow them to scrape the grain out of the box—precautions indispensable to the accuracy of the experiments, as in this way every grain of corn could be accounted for. Gravel was also spread upon the bottom of the hutches and coops, and some was placed in a separate vessel, as being judged indispensable to promote digestion.

Nearly the same measure of grain was found sufficient for a fowl every day, whether it consisted of oats, buckwheat, or barley; and hence whichever of these three is cheapest at any time may be given without regard to other considerations. Variations in the appetite of the fowls may, perhaps, be occasioned by difference of seasons, and they may require rather more at one period than another; but it was ascertained that in the months of January and February a common barn-yard fowl, that has always, from morning till night, grain of one of these three sorts at command, will eat of it daily about a fourth part of a pint measure. This is even rather more than an ordinary sized fowl will eat, for when a quart was given to a large cock and Spanish hen, to two hens of a middle size, and to three of the ordinary size, it was not all eaten. Some very voracious fowls of the largest size, however, will consume daily about the third of a pint measure.

As wheat is the most nutritive grain for human food, with the exception of rice, it might be supposed that it is also the best for fowls; and as they will eat wheat greedily, we might thence be induced to conclude that they would eat more of it than of barley or oats. Yet when fowls have as much wheat as they can consume, they will eat about a fourth part less than of oats, barley, or buckwheat; the greatest quantity of wheat eaten by a fowl in one day being about three sixteenths of a pint; nevertheless, the difference of bulk is compensated by the difference in weight, for these three sixteenths of wheat will weigh more than six tenths of oats.

The difference in weight in different sorts of grain is not in every instance the true reason why a fowl is satisfied with a larger or smaller measure of one sort than another; for though rye weighs rather less than wheat, a fowl will be satisfied with a much smaller measure of this—even, in most cases, so little as one-half. The seven hens and the large cock just mentioned consumed daily a pint and a half measure of wheat, while of rye they only consumed three-quarters of a pint measure, and hence the average consumption of the rye by each, was to their consumption of wheat in the proportion of one to two.

Indian corn was found to rank intermediate between rye and wheat. When corn was exclusively given, the greatest eaters only consumed the first day about one-eighth of a pint measure, but by usage they came to relish it more; and the cock and seven hens, which were rather above the average rate of eaters, consumed daily one pint and a quarter of corn. Accordingly, five fourths of corn to them were equivalent to six fourths of wheat, and to three fourths of rye.

The consumption of each sort of grain daily, by a common barn-yard fowl, will be rather too great, if we take the data furnished by what was taken by the cock and seven hens, as some of these were of very large size, and great eaters; though it is more convenient for the practical purpose of estimating the expense, to be above rather than below the average; what is spent less than what one is willing to spend,

becomes, in one sense, clear profit. We may therefore safely estimate that a barn-yard fowl of the common size, having as much as she can eat during the day, will consume

	Pint measure.
Of oats, barley, or buckwheat .....	8-32
Of wheat .....	6-32
Of corn .....	5-32
Of rye .....	3-32

Although, from the experiments already detailed, as made with wheat and rye, it appears that the average consumption is not always in proportion to the specified weight of the corn, yet it is of importance to know the relative weights of each grain in all such experiments. M. Reaumur, in order to ascertain the difference of weight of each in different circumstances, carefully weighed a pint measure of each; when he found the weights to be the following:

	Oz.	Dr.	Gr.
Wheat .....	19	1	52
Rye .....	18	4	12
Corn .....	17	5	48
Buckwheat .....	16	7	12
Barley .....	14	0	48
Oats .....	10	3	12

#### BOILED GRAINS.

It is the custom of poultry-keepers in France to cook the grain given to fowls which they intend to fatten, boiling it in water till it is soft enough to be easily bruised between the fingers, the boiling causing it to swell till the farina splits the enveloping membrane, and thus they term bursting. Although it is the popular opinion that burst grain is better than when it is dry, for fattening poultry, this opinion has probably not been established on accurate experiments. Be this as it may, it is of no less importance to ascertain whether there is any difference of expense in feeding poultry on raw or on burst grain; that is, whether, under similar circumstances, fowls eat more or less of the one or of the other.

In order to ascertain this, we had two quarts of corn soaked and boiled till well burst, and found that the increase in bulk was over four quarts.

Two quarts of rice swelled considerably more by boiling than corn. Two quarts of barley, after being boiled to bursting, increased in bulk to

five quarts. Two quarts of buckwheat, after boiling, increased to seven quarts.

For the purpose of ascertaining whether boiling altered the preference of fowls for any of the particular sorts, we varied the experiments in every way. The fowls were furnished with two, three, and four different sorts, sometimes all the compartments of the feeding-box being filled with boiled grain, each different from the other, and sometimes each sort of grain filled two of the compartments, one of them having nothing but boiled and another nothing but dry or raw grain. All that could be collected from these repeated experiments was, that the greater number of fowls preferred boiled grain to raw, though there were many of them which preferred the raw grain on certain days, and no permanency could be discovered in the preference shown for any sort of boiled grain. Some fowls, for example, which one day preferred boiled wheat, would on other days make choice of corn, buckwheat, or barley. Rye, either boiled or raw, is the least liked by fowls, of any sort of grain. It would seem from such experiments that we may make choice of the sorts of grain which happen to be cheapest, without much or any disadvantage; always excepting rye, when other sorts are to be had at reasonable prices.

*Oats*, although increased in bulk by boiling nearly one-half, are not, any more than rye, rendered more sufficing; for the fowls which in two days would have eaten two quarts of raw oats, consumed in the same time three and a half quarts of the boiled grain—consequently it is no saving to boil the oats. Mowbray says oats are apt to produce scour, and chickens become tired of them; but they are recommended by many to promote laying, and by some for fattening.

*Buckwheat* is increased in bulk, by boiling, more than any other grain, as two quarts, when well boiled, swelled to seven; yet it is no benefit to boil buckwheat; for the fowls consumed the seven quarts of the boiled grain nearly in the same time which two quarts of the raw grain would have sufficed them. Many have the impression that it is rather an unsubstantial food.

*Corn* is, on the other hand, more profitable when boiled than when given raw; for the fowls

which would have consumed two quarts of the uncooked or raw corn, consumed only three quarts of the boiled grain, which are not equivalent to three pints of raw. Even calculating that they were to consume three quarts a day of the boiled grain, there would be a saving of more than one-fourth. In very cold weather it should be fed to the fowls hot, and the water in which it was boiled may be given them to drink.

*Barley* is also much more economical when boiled than raw; for fowls which would have eaten two quarts of raw barley a day, ate three quarts of boiled grain. Therefore, as five quarts of boiled barley are produced from two quarts of raw, three pints are equivalent to no more than six-fifths of a pint of the raw; consequently, the expense in raw barley is to that of boiled as ten-fifths to six-fifths, that is, as ten to six, showing a saving of two-fifths by giving boiled instead of raw barley.

*Wheat* will increase in bulk by boiling about the same as barley; but experiments prove that the saving to be obtained by feeding fowls with boiled wheat is not nearly so much as might thence have been anticipated; for the same fowls which consumed one and a half quarts of boiled barley in one day, ate the same quantity of boiled wheat. Three pints of boiled wheat, however, are not equivalent to two pints of raw wheat, as in the case of the barley, but only one pint and a half of raw wheat, which was found to be the quantity consumed in one day by the same fowls. Now, as one pint of boiled wheat is equivalent to no more than two-fifths of a pint of the raw grain, the three pints consumed a day are only six-fifths of raw wheat. Consequently, the proportion of what they consumed of raw wheat was, to what they ate of boiled, as fifteen-tenths to twelve-tenths, or as five to four; hence there is a saving of one-fifth by feeding with boiled wheat, as there is of two-fifths by feeding with boiled barley.

These experiments proved most clearly that in every case where the price of corn, barley, or wheat renders it eligible to feed fowls therewith, there is considerable economy in never giving the grain raw, but well boiled; and there is no saving by boiling oats, buckwheat, or rye.



*Millet*.—Fowls prefer raw millet to that which has been boiled, though it would evidently be a saving in other respects to boil it, as boiling increases its bulk above one-half. We have found millet excellent food for young chickens.

*Rice*.—Boiled rice might be supposed to be a very nourishing food for poultry, though it is too expensive for daily feeding, and they are at first very fond of it; yet their liking for rice does not continue, and in a week or two they come to dislike it. One reason may be that it is too clogging; and were it mixed with some less nourishing substance, such as bran, the fowls would continue to relish it just as well as they do barley.

*Potatoes*.—As potatoes contain a great proportion of nutriment comparatively to their bulk and price, they constitute one of the most economical articles upon which poultry can be fed. The poultry-keepers in England consider potatoes excellent for promoting laying in fowls; while M. Parmentier advises that they should only be given for the purpose of fattening, since he thinks they will render the fowls so fat as to hinder them from laying.

Potatoes are, according to our experience, a cheap, wholesome, and nutritious food for fowls, though it would require experiments similar to those already detailed with respect to grain to ascertain the quantity which each fowl would consume when potatoes are supplied with over-abundance. If fed alone, without grain, they are very apt to make them scour.

And we have found it indispensable not only to feed them in a boiled state, but *hot*; not too hot, however, as they are so stupid as to burn their mouths, if permitted. It is likewise necessary to break or mash them a little, for they will not unfrequently leave a potato when thrown down unbroken; taking it, probably, for a stone, since the moment the skin is broken, and the white of the interior is brought into view, they will pounce upon it greedily.

Fowls are not fond of raw potatoes, beets, carrots, or parsnips, though they relish carrots when cut into very small pieces, and mixed with corn meal or wheat middlings. Boiled vegetables, mashed with bran or meal of any kind, are excellent food for poultry, and answer

well for their evening meal, when grain has been given them in the morning.

*Green Food*.—From seeing fowls when at liberty devour plants and leaves, it is generally supposed that they will eat any thing that is green; but such is not the case, as I have found by experiment. Among the plants which they reject, are the leaves of strawberries, celery, parsnips, carrots, and potatoes. They are more partial to the leaves of lettuce, endive, spinach, cabbage, and chick-weed. They also eat grass, purslain, pig-weed; and M. Reaumur says, "that if hens have a green plot to go a-grazing in from morning till night, which they are naturally inclined to do, and which they will be naturally compelled to do if they are sparingly fed on grain, the expense of keeping them will not be half what it would be if they were furnished with as much boiled barley as they choose to eat."

Poultry, however, are none the better for being fed entirely on raw greens, as it is very apt to relax and scour them, and cabbage and spinach are still more relaxing to them when boiled than raw. M. Parmentier recommends, and this accords with our own experience, giving them all the refuse of the kitchen, such as bits of spoiled fruit, parings of apples, and the like; but I have found that my fowls are not fond of the latter.

The left pieces and crumbs of bread, pie-crust, fragments of pudding and dumplings, all fowls are fond of. There can be little doubt but that biscuit-dust from ship-stores, which consists of biscuits mouldered into meal, mixed with fragments still unbroken, would be excellent food for poultry, if soaked in boiling water, and given them hot. It can sometimes be had in large sea-ports, and at a very reasonable price. It will be no detriment to this material though it be full of weevils and their grubs, of which fowls are fonder than of the biscuit itself.

*Butchers'-meat, Fowl, and Fish*.—A fowl appears to be delighted when, after having scratched up the ground, she discovers an earth-worm, on which she does not fail to pounce with avidity; and from the ravenous voracity with which they pounce upon any scrap of meat they discover, we might suppose that they are more

carnivorous than granivorous. This, however, is only observed from the meat being an occasional tit-bit. Were they fed entirely on meat, without any grain, for some time, they would manifest the same voracity for the latter. But it is well to take advantage of this omnivorous propensity to make use of every scrap of meat and offal which would otherwise be lost, as such must always assist in saving the quantity of corn which they would otherwise require. Fish is no less wholesome to them than flesh, and they are as fond of it salted as fresh.

It seems to make but little difference with them whether any sort of animal food is raw or boiled, though perhaps what is raw is more highly relished; at least they are fond of blood, which they will sip up from the ground where it has been shed till not a drop remains.

Pieces of suet or fat they like better than any other sort of animal food; but this, if supplied in any quantity, will soon render them too fat for continuing to lay.

There is no sort of insect, perhaps, which fowls will not eat. They are exceedingly fond of flies, beetles, grasshoppers, crickets, and every sort of grub and maggot. We found it quite advantageous in the summer to open our gates occasionally, and give the fowls a run in the garden or surrounding field an hour or so, in the afternoon, when insects and grasshoppers are plenty.

A writer in the *New England Farmer* says, "I keep my hens warm under cover during the winter, and feed them on brewers' grains, which are placed in an open box or tub, that they may eat when they please, occasionally giving them

oats, corn, and oyster-shells, pounded fine, and plenty of water. By keeping them well fed and warm, they began laying earlier in the season."

Mr. Stimson, of Galway, a few years since, connected the business of rearing poultry with the useful purpose of protecting his garden from the depredations of the numerous tribes of insects which so frequently render abortive the best exertions of the gardener. His method is simply this: a sufficient number of coops are constructed, and are placed in different parts of the garden, and the hens with their different broods are put into these coops; the chickens, finding no restraint on their freedom, roam over the garden, and devour every fly, bug, or insect which falls in their way. There is one objection, however, to this, which we found by experience, and that is, if left in the garden too long, they become so attached that it is difficult to keep them out when grown up. We would, therefore, recommend moving them to the poultry-yard as soon as they get in feather.

The existence of fowls would be of short duration were they confined strictly to any one single kind of food, however excellent of its kind; this would necessarily imply a state of confinement for the experiment. Many articles more useful for a change, would, if given continuously, prove highly injurious, such as corn or animal food, while others, such as barley, or buckwheat, harmless in themselves, would either be refused, or else if taken, disorder the natural functions of the body. Grain of the different kinds seems to form the main articles of food for poultry, but, like bipeds of a larger growth, they like variety.

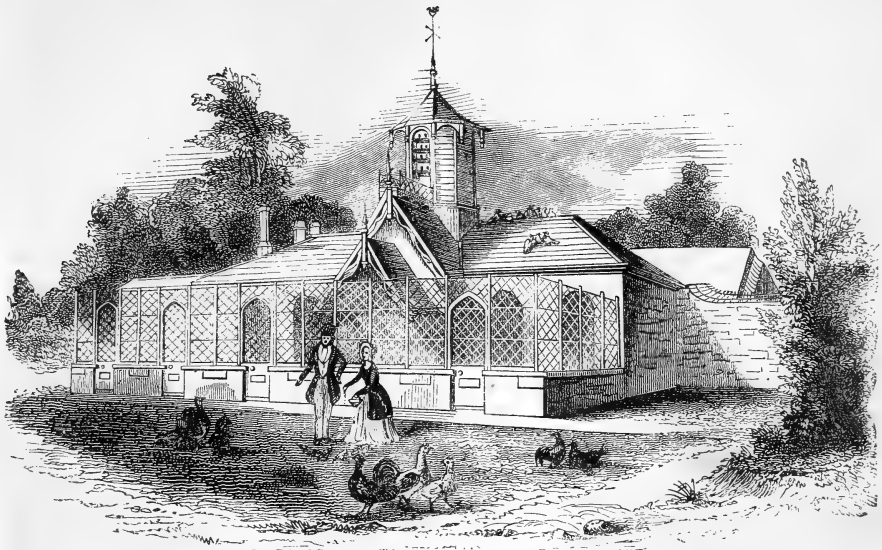

VIEW OF QUEEN VICTORIA'S POULTRY-HOUSE.

## CHAPTER II.

### POULTRY-HOUSES.

"EVERY householder," said the late A. J. Downing, "knows the value of good fresh eggs, and an abundance of good fat poultry, the year round. But few know how to obtain them without having them cost twice as much as they are worth. A hen is much like a fire-brand—a very fine thing in the right place. Like the harpies of old, they are sure to defile all they do not destroy. But with proper conveniences for managing them, they are among the most agreeable, profitable, and useful objects in country life. To children especially, fowls are objects of exceeding interest, and form an almost necessary part of the means of developing the moral and industrial energies of a country household. See that little fellow toppling along with his cap full of eggs for 'Mamma,' or patting his favorite chicken on its back. There is a whole

'California' in the little fellow's heart—showing out through his eyes, and evinced in every motion of his little body. He who will educate a boy in the country without a 'chicken,' is already a semi-barbarian; and he who leaves his chickens to make a hen-roost of all things sacred and profane, visible and invisible, is still worse; to say nothing of the good housewife's flower-patch in the garden, the very mention of which excites no small fear of a shower of oven-brooms and brickbats, while the whole welkin rings again with the discordant 'shew-there!' 'shew-there!'"

Whether fowls are suffered to run at large, or are confined, there should always be a poultry-house and yard where they can be regularly fed. Previous, therefore, to getting a stock of poultry, a place should be provided for them.

In selecting a proper situation for this purpose, it will be necessary to have it, if possible, on the south side of some building, or the south or southeast side of a hill or bank, so that one side of the wall may be set against the hill, and if of stone, to be laid in mortar, which will add very much to the warmth of the room. We would suggest, too, as an object of economy, when building the wall, to leave holes or recesses in them fifteen inches square, in which shallow boxes or drawers may be placed for nests. The sedrawers can be removed when necessary, and cleaned or freed from vermin. If the buildings are of wood, they should be filled in with brick, or lathed and plastered.

The confinement of fowls will be found a most necessary arrangement, as on many occasions it is highly requisite they should be confined, as at planting time, or at some other periods, when they are particularly troublesome. Close confinement in a room or shed would interrupt their laying, and make them sick, but a yard on the plan we are about to describe would answer every purpose, and be often found very advantageous in securing the eggs of such fowls as had contracted a habit of laying away, and hazarding the loss of eggs.

It is well known that cold benumbs fowls, retards and diminishes their laying; that the want of good water gives them the pip, costiveness, and other inflammatory diseases; in fine, an infectious atmosphere causes them to droop, whence it naturally follows that their fecundity is less, that the flesh is not of so good a quality, and that the rearing of them is difficult. Under such circumstances one may judge how important it is for the improvement of poultry that it should always be wholesomely, comfortably, and cleanly housed.

Dickson says, "In order to unite all the advantages desirable in a poultry-yard, it is indispensable that it be neither too cold during winter, nor too hot during summer; and it must be rendered so attractive to the hens as to prevent their laying in any chance place away from it. The extent of the place should be proportional to the number of fowls kept, but it will be better too small than too large, particularly in winter, for the mutual imparting of electric-

ity and animal heat. There is no fear of engendering infectious diseases by too much crowding; and it is found, in fact, that where fowls are kept apart they are much less prolific."

The driest and warmest soils are best adapted to the successful rearing and breeding domestic fowls, especially chickens; and to be attended with the greatest success and least trouble, some expense and great precaution will be required. Fowls endure extreme cold much better than moisture. To unite all the advantages desirable in a poultry-yard, it should neither be wet nor exposed to cold winds. There should, if possible, be running water in the yard, and under cover should be placed ashes and dry sand, where they may indulge in their natural propensity of rolling and basking or bathing themselves. Gravel, broken shells, crushed bones, and old lime mortar, should always be placed within their reach.

From our own experience we are satisfied that the same house ought to be kept exclusively for barn-yard fowls; for though they will not be very dissociable with others through the day, they do not like to sleep under the same roof with different species from themselves. Turkeys, in particular, are very quarrelsome, and will not suffer other fowls to come near them. Geese, too, are troublesome at the feeding hoppers, by keeping the fowls away till they have satisfied their hunger; ducks soil or contaminate the water, but are less troublesome than turkeys or geese.

Having settled all preliminaries, we will now give a number of plans, some of which would be rather expensive, and intended more particularly for the wealthy or fancy farmer; while others would be more simple and unpretending, and for utility rather than show, and could be erected at a very trifling expense, and within the reach of every one. In thus presenting our reader with a great variety of plans, we leave him to adopt such of them as may appear most suitable to his individual case. If we had adopted a different mode of proceeding, *viz.*, that of generalizing the plans of others and giving the result of our own, our work would necessarily have exhibited our own opinion only, whereas the former mode exhibits all the more valuable

plans which have been published. The young reader or novice is thus induced to think and plan for himself, and to refer his opinions and practice to fundamental principles; while the experienced practitioner may adopt the designs of those which suit him best.

We will therefore commence by giving some of the European plans, and add several plans adopted in our own country, which differ from the foreign in some respects very materially, and which will probably be found as well, if not better, calculated for our purposes than either of them; and by having a description of the different kinds a choice can be made, or one constructed by taking parts of either and combining the advantages of the whole.

#### QUEEN VICTORIA'S POULTRY-HOUSE.

[See engraving on page 45.]

"In a secluded wood on the boundaries of the Home Park, stands the Home Farm, or the farm attached to Windsor Castle—the private farm of her Majesty. In this establishment, which was founded by George III., are situated the royal fowl-house and poultry-yards, but of which, notwithstanding their great interest, the public know nothing, save the mere fact of their existence. Here, her Majesty, retiring from the fatigues of state, finds a grateful relief in the simple pursuits of a country life. In cultivating the homely recreations of a farm, her Majesty has exhibited great industry and much good taste. The buildings and farm routine which sufficed for the clumsy management of 1793, have been discovered by Her Majesty to be totally unsuited to the more enlightened system of 1843, and hence, under the direction of Her Majesty and Prince Albert, and others, an entire reorganization of the establishment has been determined, and is now in progress.

"The fowl-house lately built at Windsor is a semi-gothic building, of simple and appropriate beauty. It consists of a central pavilion, used for inspecting the fowls, crowned on the top by an elegant dove-cot, and on the sides, of wings capable of symmetric extension, in which are placed the model roosting-houses, and laying and breeding nests of the fowls. The ground, in front, slopes toward the Park, and is inclosed

and divided by light wire fences into separate wards, for the 'run,' or daily exercise of the birds. Inside these wards, gravel walks, bordered by grass plots, lead to the entrances of the fowl-houses. In the proportions, distributions, and fittings of the apartments of this house, considerable knowledge of the habits, with a corresponding and most commendable regard to the conveniences of their granivorous tenants, has been displayed; the chambers are spacious, airy, and of an equal and rather warm temperature, which accords with their original habits, and their nests are made as far as possible to resemble the dark bramble-covered recesses of their original jungles. In this particular her Majesty has set a good example to the farmers, who too often follow the false routine of their fathers, rather than consult the habits and obey the natural instincts of the animals about them."—*London Pictorial Times*.

#### LORD PENRYN'S POULTRY-HOUSE.

This establishment is described by Dickson as follows: "The most magnificent poultry-place perhaps that has ever been built, is at Lord Penryn's, at Winnington, in Cheshire. It consists of a handsome elegant front, extending 140 feet; at each extremity of which is a neat pavilion, with a large arched window. These pavilions are united to the centre of the design by a colonnade of several cast-iron pillars painted white, which support a cornice, and a slate roof, covering a paved walk, and a variety of different conveniences for the poultry, for keeping eggs, corn, and the like. The doors into these are of lattice-work, also painted white, and the framing green. In the middle of the front are four handsome stone columns, and four pilasters, supporting likewise a cornice and a slate roof, under which and between the columns is a beautiful Mosaic iron gate; on one side of this gate is an elegant little parlor, beautifully papered and furnished; and at the other end of the colonnade a very neat kitchen, so excessively clean, and in such high order, that it is delightful to view it. This front is the diameter or chord of a large semicircular court behind, round which there is also a colonnade, and a great variety of conveniences for the

poultry. This court is neatly paved, and a circular pond and pump in the middle of it. The whole fronts toward a rich little field, or paddock, called the poultry-paddock, in which the poultry have liberty to walk about between meals. At one o'clock the bell rings, and the beautiful gate in the centre is opened. The poultry being then mostly walking in the paddock, and knowing by the sound of the bell that their repast is ready for them, fly and run from all quarters, and rush in at the gate, every one striving which can get the first share in the scramble. There are about 600 poultry of different kinds in the place; and although so large a number, the semicircular court is kept so nice and clean, that not a speck of dung is to be seen.

"This poultry-place is built of brick, excepting the pillars and cornices, and the lintels and jambs of the doors and windows; but the bricks are not seen, being all covered with a remarkably fine kind of slate from his Lordship's estate in Wales. These slate are closely jointed and fastened with screw-nails, on small spars fixed to the brick; they are afterward painted, and fine white sand thrown on while the paint is wet, which gives the whole the appearance of the beautiful freestone."

This sort of cleanliness, with as free a circulation as possible, and a proper space for the fowls to run in, is essential to the rearing of this sort of stock with the greatest advantage and success, as in narrow and confined situations they are never found to answer well.

#### MOWBRAY'S POULTRY-HOUSE.

"Whether or not the poultry be suffered to range at large," says Mowbray, "and particularly to take the benefit of the farm-yard, a separate and well-fenced yard or court must be pitched upon. Upon farms the poultry-yard may be small, as the poultry should be allowed to range over the premises, to pick up what can not be got at by the swine. The surface must be so sloped and drained as to avoid all stagnant moisture, most destructive to chickens. The fences must be lofty and well secured at the bottom, that the smallest chicken can not find a passage through, and the whole yard perfectly sheltered, from the northwest to the south-

east. It should be supplied with some effectual lime and sifted ashes, or very dry sand, in which the fowls may exercise the propensity, so delightful and salutary to them, of rolling and basking themselves. This is effectual in cleansing their feathers and skin from vermin and impurities, promotes the cuticular excretion, and is materially instrumental in preserving their health."

If the number of stock be considerable, the houses had far better be small and detached, in order to secure safety; and especially, they should be absolutely impenetrable to vermin of any description. Should these houses abut upon a stable, brew-house, or any conductor of warmth, it will be so much more comfortable and salutary to the poultry.

The elevation should be a simple style, and, for health's sake, the roof should be lofty; the perches will be more out of the reach of vermin, should they break in; and there should be only one long and level range of perches, because, when they are placed one above another, the fowls dung upon each other; convenient steps driven into the walls, will render easy the ascent of the poultry to their perches; or they may be made as here shown, in which *a*, *b* are

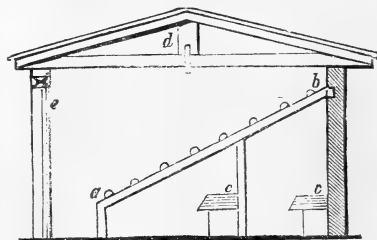

TRANSVERSE SECTION.

spars for the poultry to sit on; *c*, *c* are ranges of boxes for the nests; *d* the roof, and *e* the door, which should be nearly as high as the ceiling, for ventilation, and should have a small opening, with a shutter at bottom, to permit the poultry to go in and out at pleasure. The spars on which the birds are to roost should not be round and smooth, but roundish and roughish like the branches of a tree.

## SCOTCH POULTRY-HOUSE.

In a paper published in the "Transactions of the Highland Society of Scotland," for 1833, Mr. England, of Aberdeen, gives a plan of a poultry-house and yard, which appears to be very complete of its kind, though he differs from most of the authorities in many points of management. The house is divided into separate wards, each ward fitted up to lodge twenty-four hens and one cock, with a yard attached, about fifteen feet long, by ten broad.

The following is a ground plan of two such wards, with their yards and houses; *a, a, a*, three of the nests out of the twenty-four in each house; *b, a*

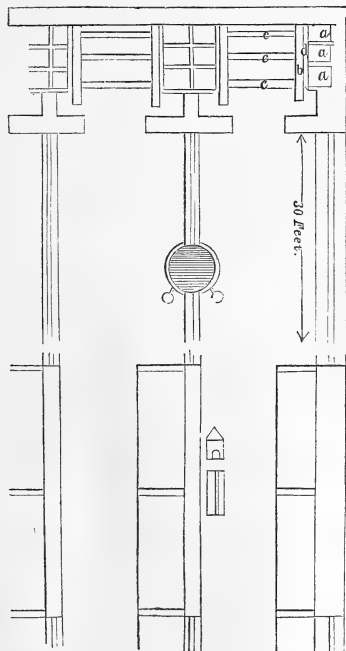

GROUND PLAN.

D

ladder by which the fowls go up to the nests; *c, c, c*, three roosts, holding about two dozen fowls; *d*, platform, to allow the fowls to pass in front of the nests.

The manner in which the nests, the roosting perches, the ladders for the fowls to go up by,

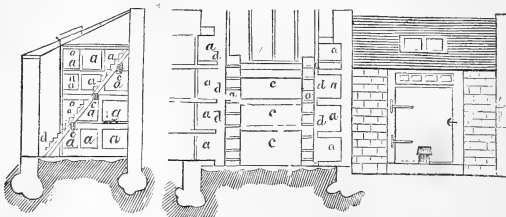

and the platform to allow them to pass in front of the nests, are arranged, will be best understood from the above figures.

The poultry-house within the yard, if there be a choice, should have a southern aspect, defended from cold winds and the blowing in of rain or sleet.

Mr. England also provides what he calls a storm house, for the fowls to run for shelter in bad weather.

It need scarcely be remarked, that the larger the inclosure the better; for, although it has been so much practiced in France, and so urgently recommended by French writers, we are no advocate for too strict confinement, unless it be from rain or damp. When the state of the fields can not render it injurious, they should at least occasionally be given liberty to roam at large. At the roots of hedges and shrubs they will grub up many a hearty meal, and the public roads will furnish them with a more grateful rolling-bed than all the artificial mounds and hollows of brick-dust, sand, and ashes, which can be laid down in the poultry-yard.

In the foregoing we have given several descriptions of foreign poultry establishments; we will now give some American ones, among which will be found some of our own plans, as well as those of others. If there is nothing original in them, they are none the less useful.

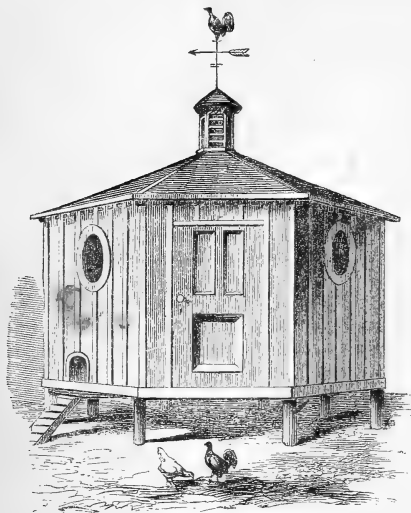

OCTAGON POULTRY-HOUSE.

The above figure represents the elevation of a neat, pretty, and convenient poultry-house lately erected near Factoryville, Staten Island. It is designed to accommodate from twenty-five to thirty common-sized fowls. The octagon form was preferred on account of economy, as it takes less materials and labor to inclose a given number of feet in an octagon than in a square or oblong form. It is more ornamental too. The object for placing it on piles was to prevent the encroachments of rats, mice, and other vermin, such as skunks, minks, and weazels. Rats are particularly annoying, as they not only devour the grain, but suck the eggs and kill the young chickens. Where fowls were fed in a trough, we have known them to contend with and even drive the fowls from their food.

This building is ten feet in diameter and six feet and a half high. The sills are 4 by 4, and the plates 3 by 4 joists, halved and nailed at the joints. It is sided with inch and a quarter spruce plank, tongued and grooved. No upright timbers were used. The floor and roofing are of the same kind of plank. To guard against leakage by shrinking, the joints may be battened

with lath or other strips of thin boards. An eight-square frame supports the top of the rafter, leaving an opening of ten inches in diameter, on which is placed an octagon chimney for a ventilator, which makes a very pretty finish. The piers should be either cedar, chestnut, or locust, two feet high, and set on flat stones.

The letter D designates the door; W, W, win-

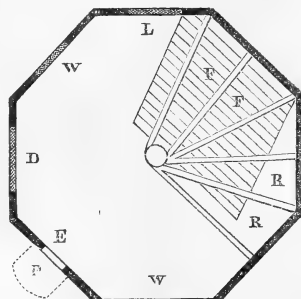

GROUND PLAN.

dows; L, latched window to admit air, with a shutter to exclude it when necessary; E, entrance for the fowls with a sliding door; P, platform for the fowls to alight on when going in; R, R are roosts placed spirally, one end attached to a post near the centre of the room, and the other end to the wall; the first or lowermost one two feet from the floor, and the others eighteen inches apart, and rising gradually to the top, six feet from the floor. These roosts will accommodate forty ordinary-sized fowls. F, F is a board floor, on an angle of about forty-five degrees, to catch and carry down the droppings of the fowls. This arrangement renders it much more convenient in cleaning out the manure, which should be frequently done.

The space beneath this floor is appropriated to nests, twelve in number, fifteen inches wide, eighteen inches deep, and eighteen inches high. In order to give an appearance of secretiveness, which it is well known the hen is so partial to, the front is latticed with strips of lath. By this arrangement a free circulation of air is admitted, which adds much to the comfort of the hens while sitting.



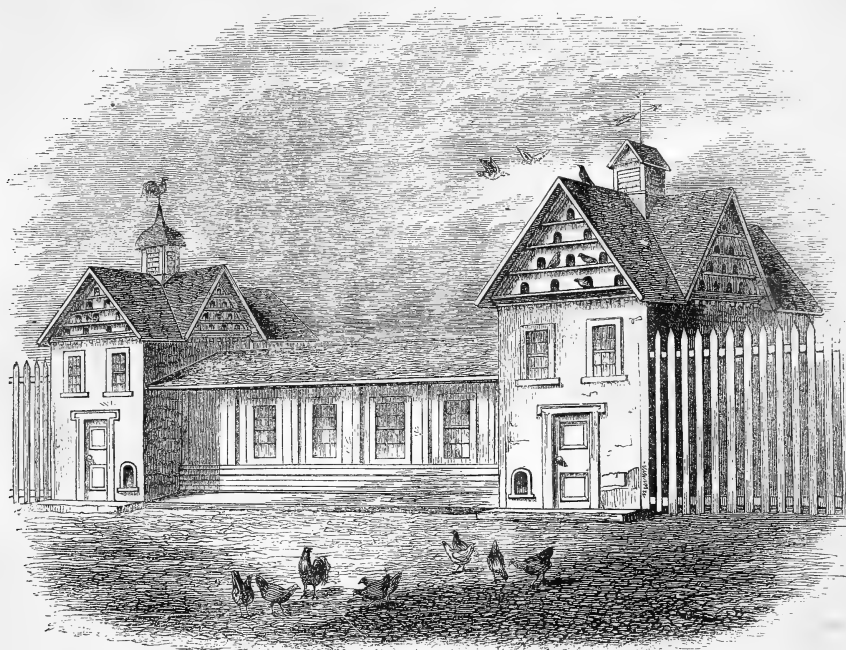

OUR OWN POULTRY-HOUSE.

The above figure represents the front and elevation of rather an extensive and costly establishment, but would be very convenient, and add somewhat in embellishing the premises of the homestead. The end buildings are intended for laying, hatching, and roosting apartments. The cupolas on the tops are finished with blinds for the purpose of ventilation as well as ornament. On the bottom of each cupola, and inside of the building, should be a door, hung on hinges, with a cord attached, passing through a pulley so that it can be closed or opened at pleasure, to ventilate when necessary. In the gables, if facing the south, as they always should, dove-cots may be formed, as shown in the engraving.

The long building with windows in front, connecting the two extreme ones, is intended for a

storm-house, chicken saloon, or walk, for exercise in cold weather, as well as a retreat from storms, and for feeding, basking, etc.; being made warm by filling in with brick, or lathed and plastered, and the roof should be thatched with straw. The front should be ten feet high, roof sloping to the north. The windows are intended to admit heat in winter as well as light. If only for a storm-house, the windows may be omitted, and the front finished in the form of a shed. Boxes for nests may also be placed there for laying and hatching. By partitioning it off, two varieties of fowls may be kept separate; so that one side may be appropriated for turkeys, guinea-hens, etc. Doors in each should open into the yards, which should be of considerable size, at least half an acre for every fifty fowls, as room and space in the open air is necessary for

their health when they are not permitted the range of the barn-yard. The yard should, if possible, be a little sloping, that it may be dry, as moisture is a most destructive enemy to poultry. It should be inclosed by a fence at least seven feet high, with long, sharp pickets, and the timbers on which the pickets are nailed, unless some distance below the top, should be on the outside, to prevent the fowls perching on them, as they seldom attempt to fly over a fence without alighting. When first confined, if they have been used to roam over the premises, they will show some impatience, which soon wears away, if every thing else is made agreeable to them. It may, however, be necessary to clip the wings of some of them, when first introduced, particularly if taken from the barn-yard, where they have always had their liberty.

The buildings at the ends should be thirteen feet square, and thirteen feet posts. We name this size, as there would be no waste of timber, being just the length of the boards. If not too near the dwelling-house, so that there would be danger of fire from sparks, we would recommend to have the roof thatched with straw, being much cooler in summer, and warmer in the winter, and when well done, it forms a light and durable roof, and will last for twenty years. It should, however, be made very sloping, that it may carry off the water the more readily. A door, ten by fourteen inches, should be made in each department, three feet from the ground, for the fowls to pass in and out, and to confine them when necessary. There should be no floor in the first story to prevent the fowls from coming to the earth; and the litter should be often removed, and the bottom sprinkled with effete lime or old mortar, at least once in each week.

In the second story there should be a tight floor under the roosts to catch the droppings of the fowls, by which means the apartments will be kept much cleaner, and the manure may be gathered, which, with the exception of pigeon's dung, is said to be the strongest of all animal excrements—it is home-made Guano. This will add a considerable item to the profits of keeping fowls that has heretofore been entirely overlooked.

The roosts should commence on one side, at

the top, near the plate, and slope downward, at an angle of about forty-five degrees, like a ladder, to within eighteen inches of the floor. The spars for the roosts should be about three inches square, with the corners taken off, and placed eighteen inches apart horizontally, for fowls, and at least two feet for turkeys, so that they may not incommode one another by their droppings. No flying will be necessary in this form of a roost, as the birds ascend and descend by steps. This arrangement is well adapted to the Asiatic fowls, such as Cochin Chinas, Brahmas, etc.

The lower story is designed for the laying and hatching department. When we first erected our poultry-house we tried ranges of boxes, similar to those usually made for pigeons, placed against the walls for nests, but experience, the best of teachers, proved it was erroneous, especially when hatching; for when the sitting hen left her nest to procure her food, drink, etc., one of the other hens would espy the eggs, and pop in and lay her egg there. In the mean time the hatching hen would return, and finding her nest occupied, and it being no easy matter to eject the intruder, as possession, with hens as with men, is considered nine points of law, she would seek the first nest she could find with eggs, and settle herself there very contentedly. The consequence was, the other hen, after depositing her egg, would leave the nest, and the eggs would cool and spoil. There is another difficulty. If vermin should make their appearance, there is no way of getting at them or cleaning the nests. To remedy this, we would recommend the insertion of shallow drawers in the niches, as adopted by a friend on Staten Island. When they become foul and require cleaning they can be easily removed.

The size and shape of the yard may be made to suit the convenience and taste of the owner, but from our experience, the larger the better. A hedge of lilac, or any other sort of shrubs within the fence, or what are better, small evergreen trees, with the branches left as near the ground as possible, will be found very acceptable to the poultry, where they will retire for shelter from the heat of the sun, and protection from the hovering hawk.

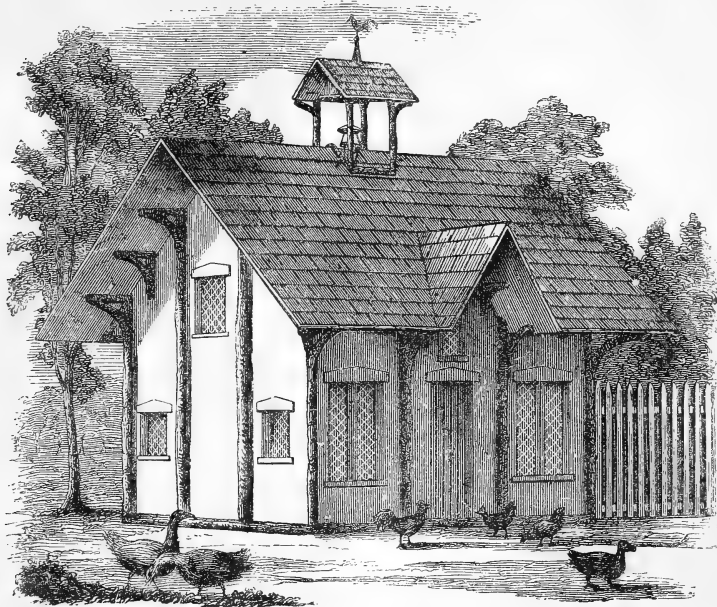

ORNAMENTAL RUSTIC POULTRY-HOUSE.

The above elevation and front view of a poultry-house we borrow from L. F. Allen's "Rural Architecture."

This design is of the rustic order, and may be erected either plain or ornamental, at a less or greater price, at the option of the owner. The proportions are as follows: Length 20 feet, breadth 16, and height 10 feet. The posts are set in the ground—"for we do not like floors of wood," says Mr. Allen, "because rats are apt to burrow under them, and are the worst pests of the poultry-house"—and boarded up, either inside or outside, but not double. Plates connect the posts firmly together, and support the rafters as usual. The chamber floor is 9 feet above the ground, and may be used for nests or as a store room for their feed. The roof projects boldly, as a shelter to the walks, and through the centre of it is an ornamented ventilator. The windows are represented with diamond

panes; common sash would be more suitable; the front windows are large, to attract the warmth of the winter sun. A section of picket fence is shown, also trees in the rear—both of which are necessary to a complete establishment; the former, to secure the poultry in the contiguous yard, and the latter, to give them shade and roosting-places in warm weather, for which we consider them eminently wholesome.

The wooden floor is dispensed with—if the ground be gravelly or sandy, that will be sufficiently dry. If on a heavy or damp soil, it should be underdrained, which will effectually dry it, and be better for the fowls than a floor of wood, brick, or stone. Doors for the entrance of the poultry can be placed near the ground, hung on the upper side, to be closed when necessary.

The front door opens into the laying room, around three sides of which are tiers of boxes, one foot wide, and one and a half feet in length

and height—the lowest tier elevated two feet above the ground, and one tier above the other, and snugly partitioned between, with a hole at one corner of each, 10 by 8 inches, for passing into them, and a shelf or passage board, 9 inches wide, in front of each tier, for passing into the boxes. These are for nesting, and should be supplied with short, soft straw or hay for that purpose.

#### COTTAGER'S POULTRY-HOUSE.

"No housewife in the country," says Boswell, "whether her cottage is situated in a village or on the roadside, need be without a few fowls; provided proper care be taken to do no injury to surrounding property not her own, and of whose possessor she has not obtained permission. This can be more easily accomplished, even in apparently disadvantageous circumstances, than is generally imagined. Although in some cases the profit may appear small, in all, the economy is great. Suppose a cottager while engaged in his daily toil, and his wife in her usual avocations, should have some means by which even the scraps of their scanty table, without trenching upon their time, should be turned to profitable account, instead of littering the floor, or being swept out into the road!

"For the accomplishment of this most desirable object, the means, in a great majority of instances, are simple and easy.

"At the gable end of the house, as near as possible to the opposite side of the kitchen fire—at which part, and for this purpose, the wall might be made thinner; perhaps only brick in bed, or brick on end, to the height of six or eight feet—a poultry-house,

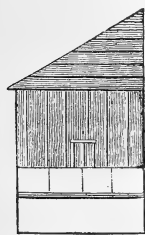

something similar to the annexed figure, might with the slightest materials be made.

Formed of rough slabs, or of such materials as the rural resident must be at all times able to find in his neighborhood, such an erection would cost almost no expense. Its construction can easily be understood from the figure. Its size, form, and

fitting up must depend principally upon the

judgment and convenience of the rearer; but in such a place, it not being advisable to permit them to roam at large, a palisade can easily be formed completely to inclose this poultry-house. It will only require one row of stakes, running parallel with the gable of the house, with the shed at one end and a small gate at the other, to form a complete parallelogram, in which the poultry, when necessary, may be confined. The inclosure does not require to be high, if the tops are pointed, for these fowls seldom attempt to pass over. If this inclosure can be made to surround the ash-pit, even in very unfavorable circumstances, a very perfect and profitable poultry establishment may on a small scale be formed."

In some plans, a poultry-house is built large enough to contain all the different species, and this is often found an agreeable as well as useful addition to a mansion, affording an opportunity of observing their habits. Some poultry-houses have been fitted up on a considerable scale, consisting of various compartments, each species of bird being placed in circumstances suited to its nature and habits; and each compartment comprising separate divisions for feeding, roosting, laying, incubation, and rearing. Among the most extensive of these we may refer to those of Her Majesty and Lord Penryhn, in Europe, and in this country, to that of Matthew Vassar, Esq., at Spring Side, near Poughkeepsie, one of the neatest and completest establishments we have ever seen. The yard is inclosed on three sides with sheds, the roofs sloping outward, and divided into wards for the different varieties of fowls, including turkeys, peacocks, Guinea-fowls, pheasants, tame and wild ducks, and different varieties of geese. A great variety of fancy pigeons are also kept in this establishment.

How much of the excellence of these first-rate constructions are attainable on a small scale, will depend upon the taste of the owner, and other circumstances; but although a small collection may be kept in one place, yet the principle of separating each species should not be lost sight of, and it will be found proper to give them different habitations, according to their several habits.



FANCY POULTRY-HOUSE.

It is true poultry may be kept almost any where. We have heard of their being successfully kept and reared in an attic or garret, who never knew there was any other world beyond the walls of their prison. In such accommodations, however, success could only be achieved by constant attention and great judgment in supplying artificially those requirements of the birds which the place of confinement did not afford.

Those who can well afford it, and wish to display more taste in this delightful branch of economy, might build in a Gothic, Chinese, or in the style of the above figure. It is designed for a poultry-house and yard for breeding fowls, ducks, and pigeons. It is intended to stand in the centre of a piece of grass-land or park, and if on a slight knoll or mound so much the better. If the soil is inclined to clay, it should be excavated all around the building at least two feet

deep, and first a layer of stones about one and a half feet deep, then covered with coarse gravel and sand. This is desirable—for we consider it almost essential to success—stagnant moisture or wet in the soil being more inducive to diseases than any other circumstance.

A southern aspect is the best, and if sheltered from the north and northwest, by plantations of evergreens, it will not only be a protection from the cold winds of winter, but a resort from the rays of the sun in summer.

The houses and yards must be constructed to suit the views and purposes of the proprietor. The yards should be fenced with pickets at least six and a half feet high—wire would be more ornamental, but rather expensive. Not less than one-fourth of an acre should be allowed for fifty fowls.

The walls of the poultry-house should be of

brick, nine inches thick, and hollow; they should be at least twelve feet high, so that the roof can project some four feet, forming a shed for protecting the fowls from the storm. The front of the shed may be formed of lath or any other kind of wood, in a rustic manner, forming a trellis on which vines might be trained, which would add much to its appearance; or it may be inclosed with glass, and grapes grown on the rafters; or nests may be placed in these sheds for sitting hens.

We may observe here, that whichever plan is adopted, the cheapest and warmest materials of which to construct the house are a wood frame and a weather-boarding, either of clap-boards or ceiled up and down with narrow battens. It should be ceiled within with hemlock boards, tongued and grooved, and laid crosswise, and filled in between the timbers with spent tan, or any other dry substance, well rammed or packed in. Or the spaces between the posts may be filled in with brick and a thin coat of plaster. In either case, whether of brick or wood, it should be whitewashed with lime.

The roof should also be ceiled with boards and filled in with tan, which would render it cooler in summer and warmer in winter, and it would have many advantages, especially as affording easy access to the lime-brush, an operation that should never be neglected four or five times in the year. Those who have insisted on this cleansing process, know well how amply the trouble is paid by the increased comfort and consequent health of their stock. It is also certain death to vermin.

For the floor, we regard bricks as the worst of all materials; they retain moisture, whether atmospheric or arising from indifferent drainage; and thus the temperature is kept low when warmth is most essential, and disease too often follows, especially cramps in the feet and legs. Let the floor be of whatever materials, it should be kept covered with fine sand or gravel, and removed often.

The interior may be finished to accommodate the kind of stock intended to be kept. If for the large Asiatic fowls, the perches should be low, or the floor of their roosting-room may be covered with straw; in which case it should

be cleansed or the straw changed daily. In the following ground plan A, A are roosting-houses, laying-nests, etc.

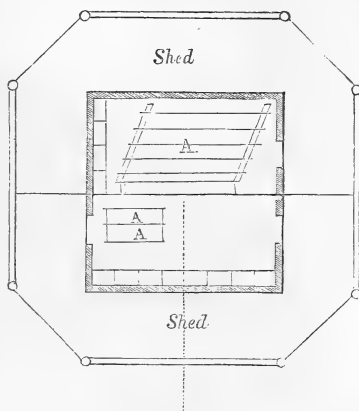

It is not essential to success that the nests should be upon the ground, though for the Asiatic fowls we should recommend it, in conformity with the general observation, that hens when left to themselves usually do so. But whether on the ground or raised somewhat above it, it should be clean and somewhat secluded.

The cupola is intended for a pigeon-house. The holes by which they enter should not be too large or too numerous, and should have a shelf at the entrance. The upper tier should have a roof or weather-boarding over them to keep out the wet. An objection to a wooden pigeon-house is, that they are too cold in winter and too hot in summer; but this may be in a great measure prevented by making the wood double, with a space of two or three inches between, which will form a non-conductor of heat.

The interior must have cells for nests; and these may be made by putting in partitions ten inches apart and one foot long. Across the front of each nest there should be a board two inches wide, sliding up and down in a groove to prevent the young ones from falling out, as they are liable to; by having this board movable, the nests may be cleaned out occasionally. Care should be taken to guard against rats.

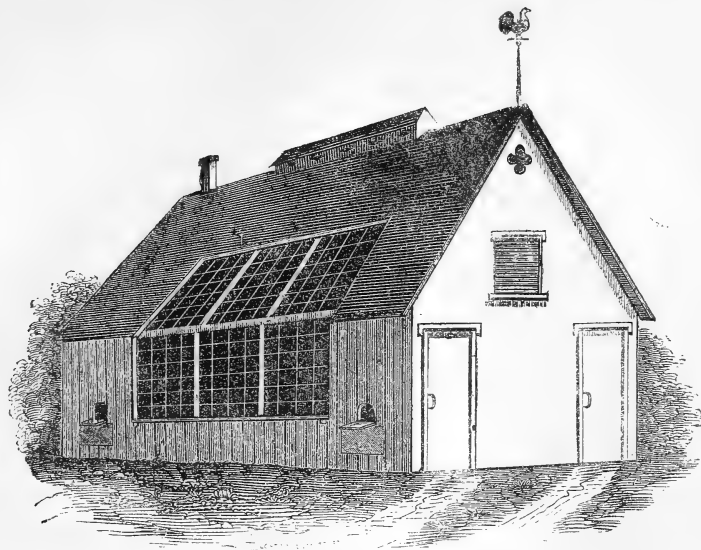

PERSPECTIVE VIEW OF BROWNE'S POULTRY-HOUSE.

From the "American Poultry Yard," by D. J. Browne, we take the following description of a very pretty and convenient poultry-house, of which the above is a perspective view:

"A fowl-house," says Mr. Browne, "should be dry, well roofed, and fronting the east or south; and if practicable, in a cold climate, it should be provided with a stove, or some other means for heating, warmth being very conducive to health and laying, though extreme heat has the contrary effect. The dormitory, or roost, should be well ventilated by means of two latticed windows, at opposite ends of the building; and it would be desirable to have one or more apertures through the roof for the escape of foul air. The sitting apartment, also, should be ventilated by means of a large window, in the side of the house, and holes through the ceiling or roof. If kept moderately dark, it will contribute to the quietude of the hens, and thus favor the process of incubation. The sitting-room should be provided with boxes or troughs, well supplied with fresh water and proper food for

the hens during the hatching period, from which they can partake at all times at will. The laying-room, in winter, should have similar boxes or troughs containing old mortar, broken oyster-shells, soot, brick-dust, gravel, and ashes, as well as a liberal supply of proper food and drink. The perches, or roosting-poles, should be so arranged that one row of the fowls should not rest directly over another. They should be so constructed as to enable the fowls to ascend and descend by means of ladders or steps, without making much use of their wings; for heavy fowls fly up to their roosts with difficulty, and often injure themselves by descending, as they alight heavily upon the ground.

"The accompanying cut represents a hen-house in perspective, 20 feet long, 12 feet wide, and 7 feet high to the eaves, with a roof of a 7-foot pitch, a chimney-top, a ventilator on the peak, 12 feet in length and 1 foot or more in height, and openings in the gable ends for the admission of fresh air. In the easterly end there are two doors, one leading into the laying apart-

ment and loft, and the other into the hatching-room. In the same end there is also a wooden shutter or blind, which may be opened whenever necessary to let air or light into the roost. In the back, or northerly side, there is a large lattice window, three feet above the floor or ground, 4 by 12 feet, for the purpose of affording fresh air to the sitting hens. In front, or southerly side, there is a large glazed window, 4 by 12 feet, and another on the southerly side of the roof, of a corresponding size, designed to admit light and heat of the sun in cold weather, to stimulate the laying hens. In the southerly side there are also two small apertures three feet above the ground or floor, for the ingress and egress of the fowls. These openings may be provided with sliding shutters, as well as with 'lighting boards,' inside and out, and may be guarded by sheets of tin, nailed on below them, to prevent the intrusion of rats, weasels, or skunks.

"The building may be constructed of wood or other materials, and in such style or order of architecture as may suit one's taste, only preserving the internal arrangements and proportions in reference to breadth and height. As a general rule, as regards the length of a building, each hen, irrespective of the cocks, may be allowed a foot.

"In the ground plan, L denotes the laying apartment; H the hatching-room, 6 by 20 feet; *n*, *n*, etc., nest-boxes for laying, 14 by 14 inches,

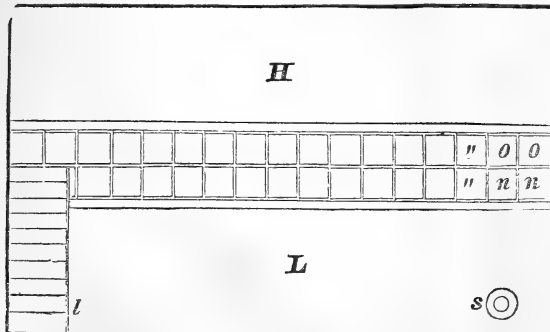

GROUND PLAN.

and ten inches deep; *o*, *o*, etc., nest-boxes for sitting hens of the same size; *l*, a ladder or steps leading into the loft; and *S*, a stove for warming the apartment, if desirable, when the weather is cold.

"The transverse or cross section shows the building from the bottom to the top, with the

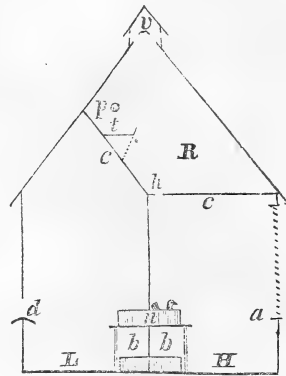

internal arrangements: L denotes the laying apartment, and H the hatching-room, divided in the middle by a partition; *n*, the nest-boxes resting on tables, three or four feet above the floor or ground; *b*, *b*, boxes or troughs containing water, grain, brick-dust, sand, ground oyster-shells, or the materials for the convenience of

the fowls; *d*, an aperture or door three feet above the ground or floor, for the ingress and egress of the fowls; *a*, a lattice window, three feet above the floor or ground, for the admission of fresh air to the sitting hens; R, the roosting-place, or loft, shut off from the laying and sitting apartments by the ceilings, *c*, *c*; *h*, a hole or opening in the ceiling for the escape of the air below into the loft; *v*, the ventilator at the peak of the roof; *p*, the roosting-pole, or perch; *t*, a trough, or bed, for retaining the droppings or dung."



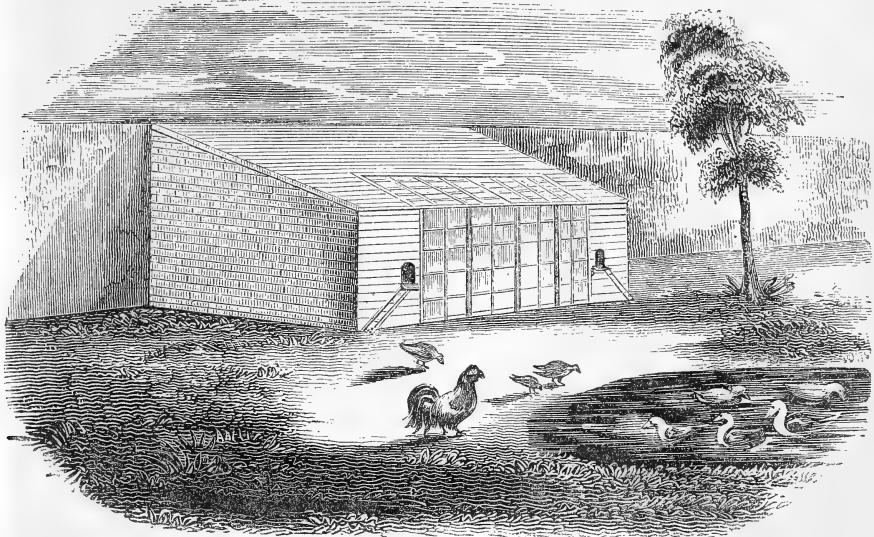

NEW YORK POULTRY-HOUSE.

After detailing the conveniences and manner of construction of several establishments, we come now to a very simple, complete, and, to our mind, very efficient fowl-house, as given by a correspondent under the signature of H. in the *American Agriculturist*. The writer says, "The accompanying plan and references render a further description unnecessary. The north, east, and west sides of the house are of brick; the floors are of cement, to keep out rats and other vermin.

"Fowls will not lay well in winter unless they have during the day a dry, light, and warm apartment in cold and stormy weather. The room marked *c* is designed for this purpose; it is lighted in front and above by sashes, one of which, in front, is hung with hinges for the entrance. If necessary, a ventilator may be added to the roof, or a window in each end."

Where location and circumstances will permit, we would recommend setting the building in a side-hill, the back wall to be of stone and

laid in mortar, which adds much to the warmth in winter, and renders it cool and agreeable in summer.

Ground plan—*a*, *b*, apertures for admitting

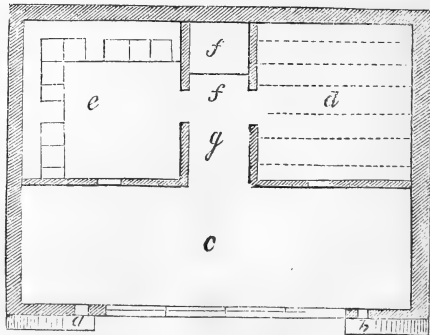

fowls, with slides for closing; *c*, place for feeding; *d*, roosting-room; *e*, laying-room, with secluded nests; *f*, bin for feed; *g*, passage.

## RUSTIC POULTRY-HOUSE.

A very cheap, pretty, and economical plan for a rustic poultry-house we find described in the *American Agriculturalist*, as follows: "This kind of work can easily be made by any person accustomed to the use of the saw and ax. All that is required is a little taste, having your plan well digested before commencing, so as to require no alterations.

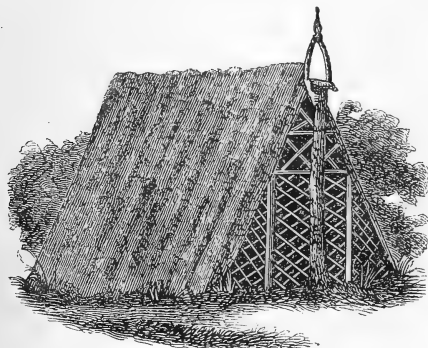

RUSTIC POULTRY-HOUSE.

"For the construction of a piece of rustic work like the above figure, after selecting the situation, join four pieces of saplings in an oblong shape for the sills; confine them to the ground; erect at the middle of each of the two ends a forked post, of suitable height, in order to make the sides quite steep; join these with a ridge-pole; rough-board it from the apex downward by the sills to the ground; then cover it with bark, roughly cut in pieces a foot square, laid on and confined in the same manner as ordinary shingles; fix the back end in the same way; and the front can be latticed with little poles with the bark on, arranged diamond fashion, as shown in the sketch—a part to be made with hinges for a door.

"The size of the building may vary according to the wants of the owner. Toward the apex of the interior, rough roosting-poles should run parallel with the sides of the house, so arranged that one set of fowls shall not perch directly

above the others. Troughs or holes should be placed under the poles, in order to catch the manure; and ladders or steps should be provided for the fowls to ascend and descend from their roost. Laying and sitting boxes may be placed at either side of the building, under the roofing, on or just above the ground. These would accommodate the Shanghai and other large fowls. They should be about 14 inches square, 10 inches deep, and concealed by bundles of corn-stalks, straw, brush, or evergreen-boughs. The sitting-boxes should be partly filled with wood-ashes, charcoal-dust, or tobacco-stems. They will ward off lice and other small vermin, as well as contribute to the health of the hen. Direct above the ashes, etc., should be the nest, which may be made of finely-chopped hay or straw, dried grass, or the leaves of trees. It is not at all required to have as many nests as hens, as one might suppose, because they have not all occasion to occupy them at the same time."

## POOR MAN'S POULTRY-HOUSE.

A very cheap and economical plan of a poultry-yard and pen is given by D. F. Ames, in the *Farmer's Rural Library*. "When necessary to fatten any fowls for the table or market," says Mr. Ames, "the yard plan is far better than confinement in a dirty coop, where they generally first lose flesh, and afterward contract a flavor by no means pleasant. One of these pens, of the most simple form, and such a one as any handy lad could make in a few hours, should be attached to every cottage; it costs nothing but a very little labor, and would really be pleasant employment for the noon hours, or evening.

"First, let a convenient and suitable place be chosen for a fowl-yard; not in a dark, shady corner, but in a light, airy situation; and, considering the number of fowls intended to be kept, mark its size: it is not well to have too many together, as the cocks will disagree. A stock of twenty-five, containing two or three cocks, is sufficient for one house; if more are to be kept, erect another pen in a different direction; accordingly, mark out a place in the form of a circle of eighteen or twenty-four feet

in diameter. On the outside of this circle, cut a trench three or four inches wide and deep, and plant poles twelve or eighteen inches into the ground every two feet. These poles should be as thick as a man's arm, and eight or ten feet high, thus forming a circle of poles standing on end. Choose a space to the south, between two of the poles, for the purpose of a door, and the poles on each side of this space should be straight, and a little stouter than the rest; then go to the swamp or brushwood, and cut a good parcel of it, leaves, small twigs, and burrs, all just as it stands. It ought to be six feet long, that it may reach three of the poles, and if longer all the better; then having conveyed it to the standing poles, commence by lacing some of the stout and straight ones round

the poles in the trench, alternately in and out, like basket-work, going the whole round, the door-way, of course, excepted. When you have got it eight or ten inches high, stamp it well down, making all tight and firm, that the smallest chicken may not be able to pass through it. Go on thus till you get it five feet high, then pass the circle of brush over door-way and all, to make it firmer and stronger, continuing it up to the height of eight or ten feet; the upper may be lighter and not braided so close; braid sometimes on one, and then on the other side of the uprights. Upon this principle, a yard may be made of any size, and in any situation, for really nothing. Any boy can make a door for this, and fix it with hinges from the sole leather of an old shoe.

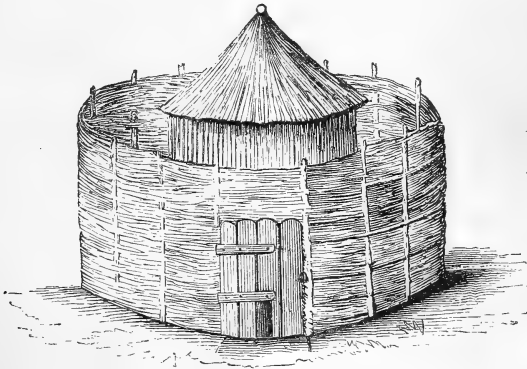

POOR MAN'S POULTRY-HOUSE.

“Then comes the fowl-house; this should be placed in the centre of the circle, that no vermin may get at it, and that the fowls may find shade and shelter all around, as the wind or sun may happen to be. A few stakes, a little more brush, and an armful of straw for thatch or roof, will make this answer; but one formed of boards, with a good tight straw thatch, would be far preferable. Mind, I say ‘*straw thatch*’ for roof, as it is far the best thing; and if properly done, it will last twenty years. The sun, rain, and snow, have no effect on it. It is very warm in winter, and lets no heat through in

summer. It should be formed of good, clean, long straw, clean-thrashed, and as little broken as possible; wheat or rye is preferable; put it on ten or twelve inches thick; I have seen it eighteen inches. Tie it close and securely with strips of white oak or hickory bark well twisted; but this every one knows how to perform. Mind and let the roof have a good pitch, or in other words, be very steep, that snow and rain may be quickly thrown off. To make this warmer in winter, the sides, either outside or within, may be laid with cedar brush and salt hay tacked up to the boards; or made of brush wicker-work,

and then plastered outside and in with clay and short salt hay; and when dry, a good coat of lime whitewash. This gives a neat, pretty look, and is warm and cheap.

"Now for the inside of the house—this should be arranged with order and neatness, for neglect on these points will be a serious evil; first, the nests: these may be formed by placing boards sixteen inches apart, beginning from the ground (do not floor it); then divide them into boxes by partitioning every sixteen or eighteen inches, and partly blind the front by nailing a board against them, leaving just room for the hens to pass out and in; a little piece of shingle can be placed across the bottom of the entrances to prevent the eggs from rolling out, and a perch can be so placed along the front as to assist them in getting up and into them. Choose those on the ground to hatch in, as the earth retains the temperature of the eggs better than hay or straw. Little doors would be convenient to place before the sitting hens to prevent their being disturbed.

"Perches for their nightly accommodation and roosting should be placed across so as not to have them dirty on one another, and down into the nests; and they should also be placed at different elevations, so as they can easily get up and jump from one to another. The perches or roosts should be of a good size, round, and stout as a man's wrist or arm, to make them steady, and to prevent the hens contracting the deformity of a bent or a crooked breast-bone, which is common from this cause; they should also be so far apart that the fowls can not from one perch peck those of another. Some fowls have a trick of doing this, and I have had several instances of the hens being almost stripped of feathers on the head and neck from others they did not agree with, and yet they would pertinaciously adhere to the situation that subjected them to the painful operation."

The hen-house should never be much larger than sufficient to accommodate the number of fowls to be kept in it; for if too large they huddle together in one corner, and, as it has been before observed, hens produce eggs more abundantly in a small apartment than in a more spacious building. But warmth and cleanliness

should be particularly attended to, and it should be rendered in every respect comfortable and agreeable to the birds that inhabit it; for, if that be not done, they will seek to lay away from home instead of in the nests provided for them, and if they can not succeed, they will to a certainty produce fewer eggs than if their propensities and tastes were better indulged; but if they have a clean, quiet, warm place to retire to, they will lay regularly and abundantly, and will repay both the trouble and expense.

#### RHODE-ISLAND POULTRY-HOUSE.

The following plan of a poultry-house is taken from the *Albany Cultivator*, and differs very considerably from those already given. The writer who furnishes the plan remarks, "Some farmers are of an opinion that a few boards tacked together, or set against the side of a wall, answer very well for the purpose of a hen-roost; but I have come to the conclusion that to render our fowls profitable, as much care must be taken of them as of our horses and cattle. This house may be built of pine boards, or it may be clap-boarded and plastered with lime; in either case it should have a good plank floor. It is twelve feet long, eight feet wide, and seven feet high, from the bottom of the sill to the top of the plate."

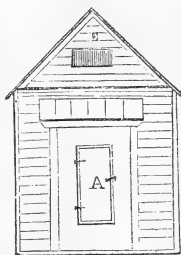

Fig. 1.

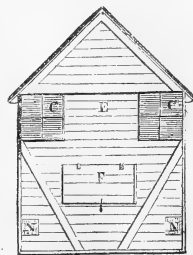

Fig. 2.

#### EXPLANATION.

Fig. 1. View of the east end: A, a door, two feet wide and five feet high; E, a small window for ventilation.

Fig. 2. View of the west end: NN, two holes one foot square for the entrance of the fowls;

F, a door to throw out the manure; it turns up and hooks at E; C C, windows with small wire grates.

Fig. 3. Interior view; U, a door; O O O O,

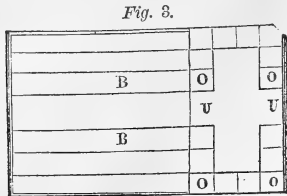

Fig. 3.

boxes for nests, twelve inches square, to be placed in three tiers, one above the other; U, an inside door of the same dimensions as the outer one; B B, are poles, or roosts; these may be either sassafras or wild cherry-tree. They are fitted to swing up and hook at the upper floor.

Fig. 4. Side view; M M, nests or boxes for

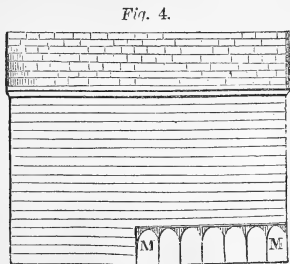

Fig. 4.

brood hens; these should have a long door to swing down and hook at the bottom.

VIRGINIA POULTRY-HOUSE.

A writer in the fifth volume of the *Cultivator* says, "I have used the poultry-house of which the following drawing is a representation, for about eight years, and can testify that it is preferable to any known in this section of country, and many of my neighbors have thrown aside their old houses and built after my plan.

"The roosts for the fowls should be often renewed, and always of sassafras, as the smell of that wood is deleterious to the vermin on poultry. The floor in the sitting-room should always



be kept perfectly clean, and continually covered with ashes and lime, and the litter from under the roost taken away weekly.

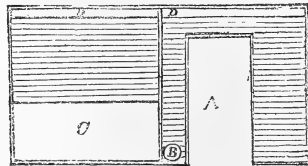

FRONT VIEW.

A, the door; B, the entrance for the fowls; C C C, the openings underneath the mitred floor, where the fowls roost; D D D, six-inch

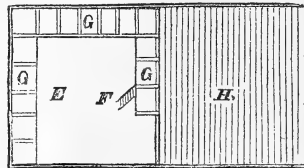

GROUND PLAN.

openings to admit air; E, the ground floor, made of earth, elevated above the surface one foot, with boxes for the poultry to lay and sit in;

F, a ladder for poultry to go to their roosting-room; G G, boxes for nests; H, lattice floor for the litter

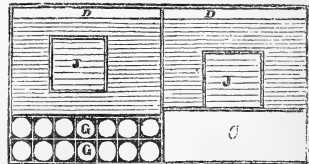

REAR VIEW.

from the poultry to fall through, and room for the poultry to roost in; I, a round hole, one foot in diameter, for fowls to roost; J J J, lattice windows of blinds three feet wide, and three feet six inches deep."

In the third volume of the *Country Gentleman* we find the following plan, with the annexed elevation, of a cheap poultry-house, furnished by a correspondent.

He says: "I have thought it would not be out of place to send you a drawing and plan of one we consider the best, as it can be made to accommodate from one dozen to five hundred fowls.

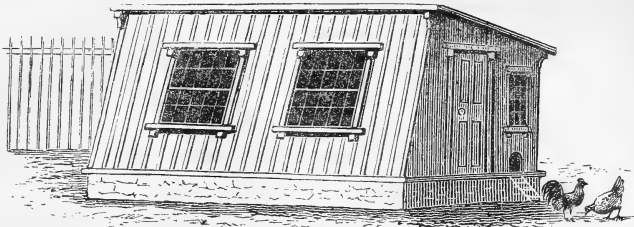

CHEAP POULTRY-HOUSE.

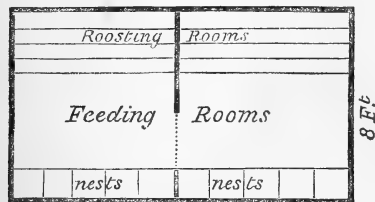
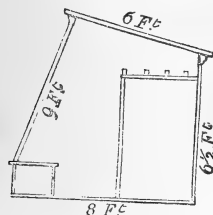
16 F<sup>t</sup>  
GROUND PLAN.8 F<sup>t</sup>  
TRANSVERSE SECTION.

"The plan I send is 16 feet long by 8 feet wide at the bottom, and costs, by using one-inch matched boards, about \$1 per foot. The present one will cost from \$16 to \$20, including sash, doors, and other fixtures.

"The engraving exhibits the plan so clearly that any explanation is altogether unnecessary."

## VAN NUXEN'S POULTRY-HOUSE.

"Having made some experiments in the raising of chickens, a business that forms a part of every farmer's occupation, I send you a description of my present plan of operation, which appears to answer admirably. Under an out-house 16 by 18 feet, raised three feet above the ground, I have made a cellar three feet below

the ground, making the height six feet altogether. Eight feet in width of this cellar is partitioned off for turnips, the remaining ten by sixteen feet being sufficiently large to accommodate one hundred chickens, or more. This cellar is inclosed with boards at present, but it is intended to substitute brick walls in a year or two. The roost is made sloping from the roof to within eighteen inches from the ground or floor, twelve feet long by six feet wide. The roost is formed in this way: Two pieces of two-inch plank, six inches wide, and twelve feet long, are fastened parallel, six feet apart, by a spike or pin, to the joist above, the lower end resting on a post eighteen inches above ground. Notches are made along the upper edge of the plank, one foot apart, to receive sticks or poles from the woods, the bark being left on. When it is desirable to clean out the roosts, the poles, being loose, are removed; the supports, working on a pivot, are raised and fastened up, when all is clear for the cleaning out. I next provide the fowls with corn, oats, and buckwheat in three separate apartments, holding about half a bushel each, which are kept always supplied.

"A row of nests is constructed after a plan of my own, and does well. It is a box, ten feet long and eighteen inches wide; the bottom level, the top sloping at an angle of forty-five degrees, to prevent the fowls roosting on it; the top opens on hinges. The nests, eight in number, are one foot square; the remaining six inches of the width is a passage way next to the wall, open at each end of the box; the advantage is to give the hens the *apparent secrecy* they are so fond of."



DUCK-HOUSE.

Ducks, being in a great measure aquatic birds, will not thrive unless there be a piece of water of some kind for them to swim in, or at least to dip in their bills and sputter, and it is useless without this to attempt keeping them. They should have a place separate from other poultry, on account of the great difference in their habits. When circumstances will permit the arrangement, we recommend having the house adjoining the pond, which should be inclosed. The laying ducks should have plenty of room, for the sake of cleanliness, and should never share the habitations of geese, as the ducks are liable to persecution. When accustomed to be fed in the house, they readily present themselves at the proper time; in the morning they get their food apart from the geese and fowls—in which case they are not plundered by the former, nor pilfered by the latter; and thus, too, their eggs are secured with far greater certainty, since the birds are not released from their inclosure till after the hour which usually witnesses the deposit of their eggs. The duck generally lays at night, or early in the morning, and is usually disposed to lay away from her house; but by our plan many eggs are secured which otherwise would have probably been lost.

A very cheap, pretty plan for a duck-house may be constructed something after the style of the above engraving, placed on the bank of a pond or small island of an ornamental sheet of

water. It may be constructed of rough boards thatched with straw, and partly covered with running vines and shrubbery, which would not only be ornamental but make a very pretty and cheap house for aquatic fowls.

The interior arrangement of the house may vary according to the means and taste of the proprietor, only providing the ducks with nest boxes, in order that they may lay and incubate undisturbed, and affording proper protection for their young.

It is not in every situation that ducks can be kept with advantage. They require water much more than the goose; they are no graziers, yet they are hearty feeders, and excellent "snappers-up of unconsidered trifles;" nothing comes amiss to them; and in places where tadpoles and the larvæ of aquatic insects abound, they can be kept at trifling expense.

A strong desire for the selection of her own nest is generally found to influence the duck; but this is mainly the case as the time draws near for incubation, since previously to that period, if the egg has not been laid before she has been let out of her house in the morning, it is usually dropped at random—wherever, in fact, the bird may chance to be when the time comes. If the nest selected by the duck be tolerably secure, it is better to allow her to continue there; for rarely will she sit well if she be disturbed by removal from the spot of her choice.

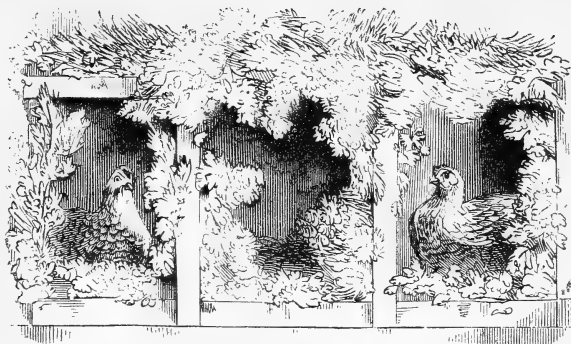

SECRET NESTS.

## CHAPTER III.

## ACCESSORIES TO THE POULTRY-HOUSE.

## PLANS FOR NESTS.

NESTS are sometimes fixtures, and generally built against the wall, either in one tier or several, according to the number of fowls and the size of the house. When there is more than one tier, each of those above the ground must have a projecting shelf at the bottom for the hens to reach the nests, and a slanting board, with strips of lath nailed on, leading to each tier. But we prefer, and would by all means recommend, movable nests arranged along the

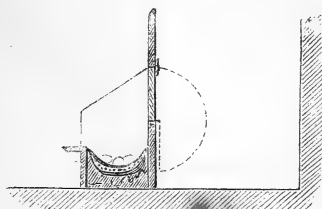

SECTIONAL VIEW.

wall, with a shelf in front, and a sloping top or cover, so that the hens may not roost on it and

annoy our notions of tidiness by the traces we should find there the following morning. Finally, each nest should have its cover open separately, so that the adjoining birds may not be disturbed when we have occasion to examine any nest, or to remove the hen herself. The bottom should be sliding, shallow drawers, three inches deep, to prevent the eggs rolling out, and also as a safe-guard to the newly-hatched chickens before they are removed to their coop. As to distance from the floor, we would place them for Asiatic fowls at six inches. We give preference to nests raised a few inches from the ground solely on account of the greater facility for cleaning the house by allowing the broom to reach beneath. If partially closed in front—by far the better plan—the entrance should be on one side, as shown in the sectional figure, thereby giving greater privacy to the interior—a quality which is highly prized by the occupant.

The hen is a prude, and likes to steal away in some sly place to deposit her eggs. To gratify their organ of secretiveness, we had the fronts removed, with the exception of the two-inch ledge in front, and tacked hemlock boughs



to the front, as represented in the figure at the head of this chapter, nearly closing the entrances, giving the hen an appearance of obscurity, and an opportunity of gratifying her natural propensity. This arrangement seemed very satisfactory to the hens, besides adding much to the appearance of the house. Where evergreens are not at hand, fine lattice-work will answer an equal purpose. It is amusing too, when you enter the house, to see how shy and cunning they look in their cosy and, to them, private nest.

In large poultry-houses, when a great number of fowls is confined, it would be well to have sitting-nests so formed as to keep them secure from the intrusions of the hens who have been in the habit of depositing their eggs there. One reason for adopting this system of apparent—but only apparent—restraint, is principally to prevent those friendly visits of other hens which are always anxious to insure a numerous progeny to their neighbor, by adding their own contributions; this, however, not being usually approved of by her ladyship in possession, a scuffle is frequently the result at the expense of the eggs, which are thus too commonly broken or injured.

We have found too, that the daily absence of the sitting-hen for food and exercise has been waited for by the other members of the poultry-yard which are about to deposit their eggs, and that they will avail themselves of such absence to mount the place of honor and prevent the return of the rightful owner.

We have also had eggs rolled out of the nest into those of the same level—you may conjecture with what lamentable results; we have, therefore, arrived at the conclusion that the old adage "safe bind, safe find," will apply in this case as well as in most others, and that it is upon the whole the best plan to secure the hen in the undisturbed possession of her nest, taking care, of course, to liberate her at a fixed hour on each day, and to have food and water at hand for her use.

The confinement of the hen is effected either by having a sliding board well perforated with air-holes or wire-work, that may be drawn across the entrance; or where the front of the nest is

open, a bar to let down, of sufficient width to prevent either egress or ingress.

As to the exact description of the nest which would be most suitable for the hens while engaged in sitting, almost every poultry-keeper has some favorite arrangement of his own, and, provided some two or three requisites are complied with, no great harm is likely to result from his indulging in it. The recess in the chimney-corner, the unused manger, and the concealed nook in the cart-shed have great attractions to many hens, and, barring accident from the exposed situation, as good a brood may be thence expected as the most scientifically-constructed nest can afford us. But as the eggs in the latter place often disappear, and the hen herself is at times found wanting or defunct, few would be willing thus to hazard the safety of any valuable bird.

For hatching we prefer nests on the ground; for, in the first place, almost all poultry will choose the earth as their resting-place, if circumstances will permit them to do so; and we are of the opinion that the small amount of dampness to which the eggs are exposed in this case, is any thing but undesirable or productive of injury to the forthcoming brood; and, secondly, the possibility of fracture arising from their being thrown out of the nests is greatly lessened.

But when we look at the places usually selected by the hens themselves, damp, and many other matters which we are often anxious sedulously to guard against, are plainly by them thought of little amount; and yet, at the expiration of the allotted time, the number of young led forth often tally very nearly with the eggs that had been there deposited. It seems, indeed, as if the self-willed hen was conscious that, having acted so far on her own responsibility, she could reckon on no other aid, and was thus incited to greater diligence in the performance of her natural duties. The desire of all animals in a state of nature to conceal the abode of their young is thus partially adopted by the hen who steals her nest, and takes every precaution by limiting the period of her daily absence, and retiring, if possible, unobserved, that a goodly brood may prove the wisdom of her choice.

Be this, however, as it may, fewer eggs, it can not be denied, are to be found in an added state in such stolen nests than when those of any one hen are kept for sitting, and when the eleven or thirteen are ready placed under the intended mother. We believe, too, that whatever care may be taken by us in keeping our eggs, their vitality is greatly preserved, when allowed to remain in the nest, by the periodical visits of the hen while adding to the store; and that the warmth of the half-hour or longer period occupied by the act of laying, stimulates the embryo, and tends to preserve it in a vigorous state.

#### WICKER-WORK NESTS.

A writer in the *Cottage Gardener* says, "We have used most contrivances in this way, but never found any to answer so completely as these. The hens take to them, and we require no better judgment than that. I believe they are a wrinkle for this article and *The Cottage*

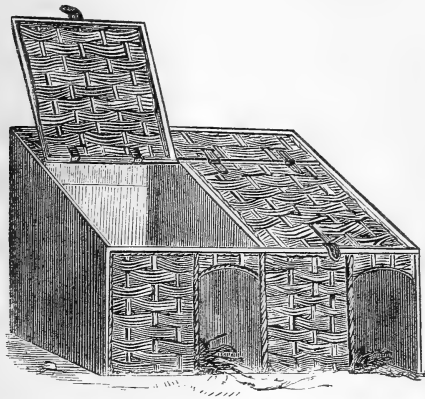

WICKER-WORK NESTS.

*Gardener* to say, Go forth! An auger, a saw, a bill-hook, a clasp-knife, a stout piece of leather for hinges, some iron tacks, a few poles, two inches in diameter, cut fresh from the water-willow, some strips, and a few seasoned pieces of larch, or any other boards, are all the implements and material I made use of in their con-

struction. Rive the willow rods into laths two-eighths of an inch thick; wattle them on the frame as in the engraving. Why I give the preference to these wattled boxes, in lieu of those formed of solid boards, is by reason of the constant circulation of air going on through the interstices. This has a great deal more to do with the health and comfort of the hens, and the perspective 'counting' of the chickens before they are hatched, than a great many people are aware of. In nine cases out of ten, sitting-boxes are too *hot, close, and dry*. Draw a comparison between them and the stolen, or, if you will, more natural nest in the grass or under a hedge in the open air—which of the two are notorious for producing a numerous and healthy offspring?"

#### CHEAP NESTS.

A friend, a practical man, recommends old nail-kegs for nests, as being not only economical, but very convenient in regard to cleaning. A narrow piece of board should be nailed across the open end, at the lower part, to keep the eggs from rolling out. A rack of poles may be set against the wall, and the kegs secured to it make attractive nests. We have seen flour-barrels set in the crotch of apple-trees for the same purpose, and the hen takes to them readily. One particular advantage of this kind of nests is, that when necessary to cleanse them, all that is required is to have a kettle of boiling water, and immerse the keg for a few moments, which will kill the vermin. Have a tub of hot lime-wash ready, and wash the keg inside and out with it. If these precautions are not attended to, particularly when hens are sitting, they are very apt to be infested with myriads of lice, which are not only annoying to them, but often drive the hen from her nest, and not unfrequently destroy her life.

#### STRAW NESTS.

We have seen nests made of twisted straw, in the same way as bee-hives are made; two apartments, one above the other. The objections to these are: they are too confined, and afford a harbor for vermin, and are too difficult to clean.

## CURIOUS NEST.

A cute Yankee down east, it is said, has invented a hen's nest, in the bottom of which there is a kind of trap-door, through which the egg, when laid, immediately drops; the hen, looking round and seeing none, lays another.

## SECRET NESTS.

The following plan, for fixed and *secret nests* is from the "American Poultry-House," which the author says "has lately been contrived in Connecticut, and I have tried it with complete success. Hens are well known to be anxious to deposit their eggs in secluded places. The secret nests, sections of which are here given, are well adapted to satisfy this natural propensity. They are made thus: 'Place a platform of

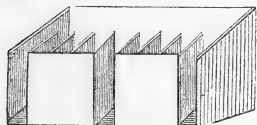
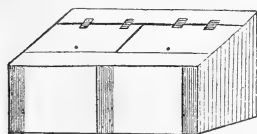

boards two feet wide, and say ten feet long (though it may be made of any length), against a building or a close board fence, about three feet from the ground. Along the outer edge of this platform nail a board lengthwise and upright, about one foot high—leave a space open in the middle and at each end, eight or nine inches wide, and divide the remaining space inside the nests a foot square; this leaves a passage-way nearly a foot wide behind the nests. The top must slope from the wall, and open partly or entirely with hinges. These nests are easily examined, and give the fowls all the secrecy they seem to require.'

## CHICKEN COOPS.

To give the chickens the best chance of life the hen should be confined in a coop, under a shed or outhouse, until they are about four weeks old; and in cold weather a week or two longer. The coop, however, should be moved into the sunshine, and on grass, if possible, whenever the temperature is sufficiently mild.

The most common method employed for the purpose of confining the hen with her young brood, is to drive stakes into the ground in front and make a pen about two feet square and cover with boards; but a better plan is to lay a flour-barrel on its side, with one end out, and drive a few sticks into the ground in front. This makes a very dry and comfortable coop, pro-

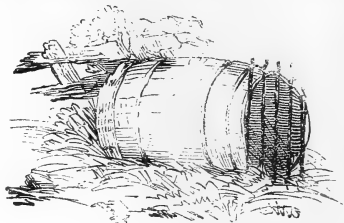

BARREL COOP.

tecting them from rain and winds, and allows the chickens to range about the yard, where they are enabled to pick up seeds, insects, and worms, by which means they obtain a large share of their living.

We say nothing of the poor hen's state of mind while, confined herself but with her young brood at large, she witnesses their erratic conduct, and their danger from hawks, cats, or ill-temper, or spitefulness of some of her own race, which often terminates in her "scrabbling" to death (a truly emphatic term, indicative of her peculiar notions under excitement of this kind) those of the brood which first answer the summons of recall while others are still truant. Her feelings, therefore, should be studied for our own sake, no less than for her's.

## MARQUEE OR TENT COOPS.

The marquee or tent-shaped coops, of which the following figure is a representation, we have found very efficient during the summer, if we avoid placing it on grass anyway damp during the early days of its inmates, though it does not afford the same degree of shelter as the one to be described hereafter.

The marquee coop is formed by nailing pieces of boards, two feet long, in such a way as to form two parts of a triangle, the ground forming the

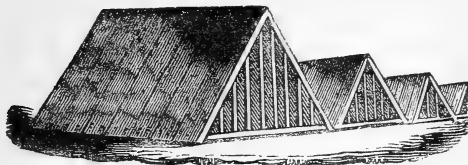

TENT COOPS.

other side. In warm and dry weather we consider it better to have them next the earth; but in the early spring, when the weather is cold and the ground wet, a floor or platform of boards, or an old door, should always be put under the coops. It should be two feet long, or if three feet much the better, and twenty-two high in the centre. The back end should be boarded up tight, with the exception of a small hole at the peak to admit air. The front should be secured by nailing strips of lath, as denoted in the figure, leaving sufficient space between

them for the free passage of the chicks without affording liberty to the hen. In front there should be a broad strip of board as long as the width of the coop on which to feed them. This board may be secured to the bottom bar of the coop with leather hinges, so as to admit of its being raised up to close the coop toward evening, which will not only answer the purpose of guarding the young brood against rats and other enemies during the night, but will prevent the chickens from wandering about the next morning on the dew and wet grass.

Precaution should be taken not to have the coops too near each other, as the chickens of the different broods are apt to wander to the wrong hen, where they will be punished and sometimes killed. Fifty or sixty feet apart will be a sufficient distance in general to secure the safety of the young broods from injury by other fowls.

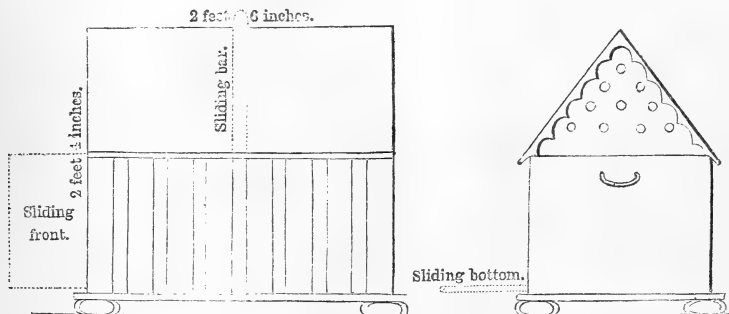

AN ENGLISH COOP.

The above is a front and end view of an excellent coop for early-hatched chickens, where it is desirable to have command of the mother as well as her young. A little court in front, two feet six inches wide, and three feet long, made of lath or wire-work, which restrains their wanderings, and checks the incursions of other members of our flock. When the weather will permit it can be removed to a warm sheltered piece of gravel, where the benefit of the sun's rays may reach them. Two or three hours of

good sunshine are then worth a week of codling and swaddling by the kitchen fire; and rarely does a young chick seem to think the sun too powerful—though if the mother differs with them in this, she is always ready to call them within the coop, for their play-ground is but the limited little court. So soon as the day wanes in spring, and while the temperature is low, we would remove them to the shelter of the house for the night; and the barred front of the coop closing altogether with a slide, they re-

main safe and warm till the next morning, when a similar move takes place again. The ends of the coop are perforated with air-holes, small enough to be secure against rats or weasels. In summer the coops stand out during the night.

It has a sliding bottom, as indicated by the dotted lines. We consider that the extra expense of a sliding bottom is well repaid by the avoidance of damp, and the greater facility of cleaning it. The interior of these, as in other chicken abodes, is not always so entirely in view as to render it at once perceptible whether the person who has charge of them has the same idea of the importance of scrubbing and purifying as we ourselves may think necessary; but if a second slide is at hand, to be scoured on alternate days, and dried in the sun or by the fire before it replaces the one in use, we are safe, and the health of our chickens will soon satisfy us that they appreciate the care.

But do not let our readers be frightened by the minuteness of these directions, for at a later season the chickens may be left much more to themselves; only let them remember that if in possession of a choice breed of fowls, and they desire to have healthy chickens at an *early* period of the year, their chances of success will be infinitely increased by following our advice. In our system of management we always endeavored to adopt as natural a course of treatment as might be; and if such daily care and attention to their dwelling-houses and food be insisted on as contrary to the natural provision they would meet with in a state of liberty, we can only reply that equally contrary to nature is their existence in a domesticated state. We have deprived them of what nature would have given; for which, therefore, some compensation must be made.

#### CLOSE COOP.

A writer in the *Cultivator* says: "The following cut is a coop of my invention, which I think is very convenient. It may be made of inch boards, long enough to admit of any number of fowls. A A, slats raised for admitting the hens; B B, doors to open and shut at night, to prevent the intrusion of any kind of vermin; C, button for fastening the doors."

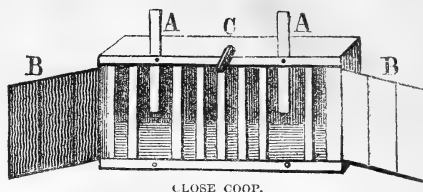

In all cases a warm, dry, and quiet place should be chosen for the coops, near the house, on account of the convenience of feeding them, and where the chickens are not in danger of being trod on either by man or beast, nor where the hen will suffer from the intense heat of the sun, or where there is danger of the chickens being carried off by the hawks or crows. To make them thrive, fine sand or ashes should be near at hand where the chicks can roll and busk themselves.

It has been our practice to place hens with their chickens in the walks of our garden, at least fifty feet apart; where they not only obtain their livelihood, but are of great service in destroying large numbers of bugs, worms, insects, and their eggs, which are so injurious to vegetation. We found some difficulty, however, in this, for the hawks would pounce upon them, and where the vegetables, such as beans and peas, are pretty rank, the rats will take shelter and catch the young chickens when they run among them. It is well to look to these evils, and we would also advise their removal after they are one month or so old, or they will become so attached to the garden that it will be difficult to keep them out.

At the end of six weeks the hen may be set at liberty after the dew is off in the morning and the weather fair, and if the movable coop be employed, it may be propped up with a stick, and the hen will return to it of her own accord at night, when it may be let down and kept so until the dew of the morning is dried off. At the end of two weeks more they may be turned into the poultry-yard.

As they will at first hardly receive fair play in the distribution of food, it will be necessary to prepare for them a feeding-coop, so that they

may enjoy their food without being disturbed by the older fowls. This we effected by driving strips of board or stakes in the ground, leaving spaces between just wide enough to prevent the grown fowls from entering, encircling a space from four to five feet in diameter and about two feet high, covered with boards, through which was a small aperture or door, where the feed was put into the hoppers of the feeding-box, which was made on purpose.

#### PENS AND COOPS.

It is sometimes necessary to separate some fowls from the rest; such as those which are diseased, which are liable to be ill-treated by the rest, as also strangers, and fowls of particular breeds. Pens or coops are useful for this purpose, which may be made in various ways.

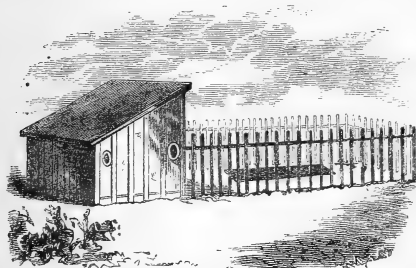

PEN COOP.

The above figure represents a very useful pen for keeping a cock and three or four hens for breeding, where they can enjoy the sun and fresh air, and yet be protected from stormy weather; and it may serve instead of a poultry-yard. It has a house to roost, lay, and hatch in, and an open part for exercise.

The dimensions are as follows: The shed or pen may be four feet high in front, the roof sloping to three feet in the rear, with holes in the ends to give a free circulation of air. It may be six feet long and four feet wide. The entrance, which is not shown in the figure, is in the yard. The yard may be ten feet long and six feet wide to correspond with the shed. The yard may be inclosed with panels of lath and rails four feet high, and the top covered

also with lath to secure the birds from flying over.

This same plan may be reduced to a size suitable for a hen and chickens. The coop for that purpose should be twenty-two inches high in front, and eighteen inches in the rear, and twenty inches square at the bottom. The top opens, and there is a sliding door in front to shut in the hen. The front or yard may be four feet long, slatted with laths, with a hole cut through the bottom, as shown in the figure, for hens to scratch in. It is light and easy to be removed from one place to another, which should be done daily. The tight and open part answers the double purpose of sitting the hen, and keeping her and the chickens in until they are able to take care of themselves.

Colonel Jaques says, "I think chickens can be raised as well without as with a hen, even though you take the chicks away in an hour or less after coming from the shell. Some of my hand-somest pullets were raised the past season without a hen. In order to do this you want a small coop, built in a lean-to shape, three to five feet long, high and wide in proportion, with a small door in front, and two squares of glass to admit light and sun, when cold and rainy. A piece of sheepskin, with the wool on, nailed to a board, would answer for them to run under and get warm."

#### NEST-EGGS.

There is some advantage to those who keep fowls and desire eggs in winter in having nest-eggs; they are useful appendages to the laying-houses, as indicating to the young aspirant to national honors the whereabouts of the "procreant cradle." We find also that they induce some hens to keep to their nests which are otherwise induced to deposit their eggs at random. An essential quality of a good nest-egg is a tolerable resemblance to a real egg. A hen will never lay to an egg-shell, however perfect it may be, for she knows by its want of weight that it is a counterfeit.

A good nest-egg may be made of solid white maple or hickory wood turned to the proper shape. But every one has not a lathe, and such eggs are not always to be had. Another nest-

egg which may be made by any person, any where, has been described in the *Prairie Farmer* by Mr. Lathrope, of Lasalle, a gentleman who keeps one hundred hens.

The eggs are made of clay, formed to the right shape in the hands. After being dried they are whitewashed, and ready for use. These eggs answer the purpose perfectly, the hens accepting them as those of their own make. Chalk, formed to the shape of an egg, has also been used; and white marble turned to the proper shape has been used for nest-eggs, but being solid and heavy, they would break the real eggs when coming in contact, on which account they have been discarded.

A very excellent artificial nest-egg can be made of plaster, in the following manner: Take an egg and break a small hole in the largest end, of about a quarter of an inch in diameter; in the other end make a small hole with a pin, and then blow the contents out of the larger hole. Then take some calcined or boiled plaster, and make a thin paste with water, and fill the shell, which soon sets and becomes hard, and then paste a small piece of white paper over the holes, to prevent the hens from picking out the plaster.

But among all the plans and devices for artificial nest-eggs those made of glass exceed the whole. It is the invention of some of our ingenious Eastern neighbors, and the imitation is so perfect, that Mrs. Bidly, with all her shrewdness, could not detect it as counterfeit. They are opaque, and about the size and weight of a common sized hen's-egg, and can be had at the agricultural warehouses at one dollar per dozen.

#### FEEDING-HOPPERS.

Some farmers are in the practice of feeding their fowls from the hand, strewing it over the ground, while others throw down the corn in the ear in a heap, and permit the fowls to help themselves. This is considered a slovenly and wasteful mode, and well calculated to invite rats and mice. In our experience we have found it more economical to keep grain constantly before them, and for that purpose adopted feeding-hoppers.

Our first hopper was made after the plan of Mr. Ames, who says, "Hoppers can be made out of an old candle-box, to be had at any grocery store for twenty-five cents. They are 18 inches long, 12 wide, and 10 inches deep.

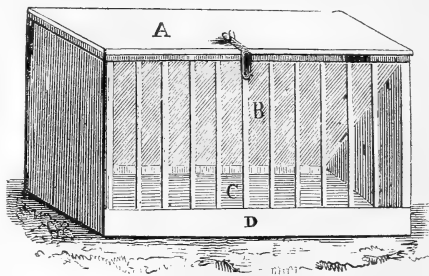

CHEAP FEEDING-HOPPER.

"Begin by taking off the lid and one of the sides, leaving the two ends, bottom, and one side remaining; then take the lid and cut a small strip off one of the ends so as it will slip in between the two ends of the box, placing the lower edge one and a half inches from the side and about an inch from the bottom; the other edge of the lid is to be brought out so as to reach the top and outside corners of the ends. In this position it will form a deep angular box with a long aperture at the bottom. Two or three nails will secure it in this position. The lid now forming a slanting side, B, will be too wide and project beyond the ends; cut the strip off and nail it across the bottom of the hopper so as to form a trough, C, where the corn, when put into the angular box, will descend through the long aperture down into it. Take then the side which you have not yet used, and with a few tacks and some old shoe-leather make hinges and put on the lid, A. The front or open part of the hopper has a paling or row, D, of slats or wire about two inches and a half apart, so that the fowls can just get their heads between to pick out the corn. These wires or slats should be brought out to the edge of the box, so that the fowls can but just reach the bottom of the angle or long aperture. The corn falls down as the fowls pick it away."

Our next essay was to construct one after the plan below, which we had in use three or four years, and it answered a very good purpose for about seventy fowls. It is very simple and easily constructed. The dimensions were as follows: It was nine feet long and nine inches wide; and pieces fourteen inches high, and the bottom raised six inches from the ground; the ends nailed to the bottom, and a strip of board four inches wide was firmly nailed on the sides, raised three inches above the bottom board, forming a manger or trough to prevent any waste of food. Another strip of board three inches wide was nailed on the top in front to secure the ends. The hopper to contain the grain was formed of two pieces of board, nine inches wide,

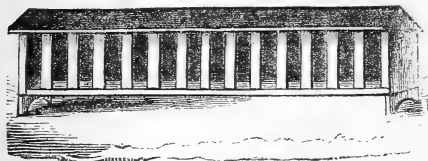

DOUBLE FEEDING-HOPPER.

set between the ends forming a V, the upper edges lying against the front top strips and the bottom resting on some small blocks, from one to two inches high, sufficient to allow the grain to fall down as the fowls pick it away. It may be made to open and shut at the bottom to suit the different sizes of grain. The top or roof may be made of the same width as the box, or it may extend over the sides sufficiently to protect the fowls from rain when feeding. Narrow strips of lath must be nailed to the top and bottom pieces, leaving space enough between them for the fowls to enter their heads when eating. It is open on both sides, and one of this size is sufficient for seventy-five fowls.

The following cut represents a feeding-fountain described in the "Transactions of the Highland and Agricultural Society" of Scotland. It is also figured in "London's Encyclopedia of Agriculture." "It can be made to contain any quantity of corn required, and none wasted. When once filled, it requires no more trouble, as the grain falls into the receiver below as the

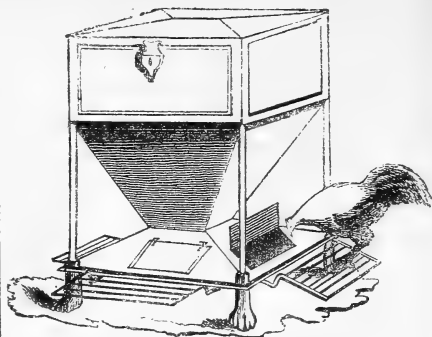

SCOTCH FEEDING-FOUNTAIN.

fowls pick it away; and the covers on that which are opened by the perches, and the cover on the top, protect the grain from rain, so that the fowls always get it quite dry; and as nothing less than the weight of a hen on the perch can lift the cover on the lower receiver, rats and mice are excluded."

As we did not exactly comprehend the principle upon which the above was constructed, we had one made, of which the following is a representation. We exhibited it at the fair of

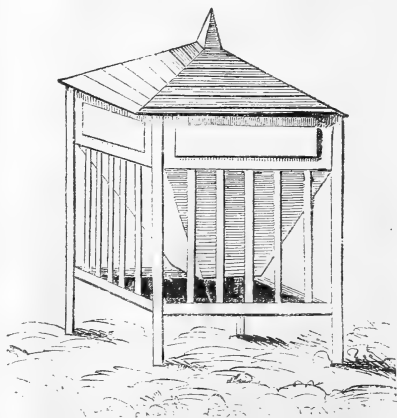

SELF-FEEDING HOPPER.



the New York State Agricultural Society, held at Albany in 1842, which excited considerable attention, and was highly commended by the committee.

This feeding-hopper is two feet square, the posts are eighteen inches high, and two inches square; the upper section of the box is six inches deep, and the ends are morticed into or nailed to the posts. From the bottom of this square

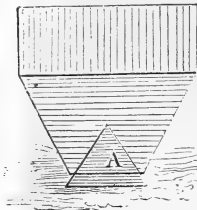

the tapering part of the grain-box reaches to within one inch of the floor, which should be raised on feet about six inches from the ground; the grain-box tapers to one foot square, and to bring the grain within reach of the fowls, a cone, as shown at A in the annexed figure, is placed in the centre of the floor, and should be as much smaller than the funnel part of the hopper as to leave at least one inch space all around the cone which forces the grain to the edge, where, as the fowls pick the grain away, more will fall and keep a constant supply within reach of the fowls, as long as any is left in the hopper. The slats on the sides are intended to prevent the fowls from getting into the trough or crowding one another. This hopper will hold about two bushels of grain, and if the roof projected one foot all round it, it would protect it completely from rain. It occupies but little space, and from twelve to sixteen fowls can feed at the same time.

As we were constantly annoyed by the depredations of rats (some of the old patriarchs would not only help themselves bountifully, but actually contend with, and drive the fowls from their food), in order to avoid their annoyance we had a feeding-hopper constructed after the following plan, which is fully represented in the figure.

Its construction is so simple, that a man or boy who can handle a saw, a plane, and a hammer, with a few nails, could make one in a few hours, and it would cost but a trifle.

We will now give directions for making one. First make a platform three feet square; then

make a square box of inch and a quarter plank, three inches high and sixteen inches square;

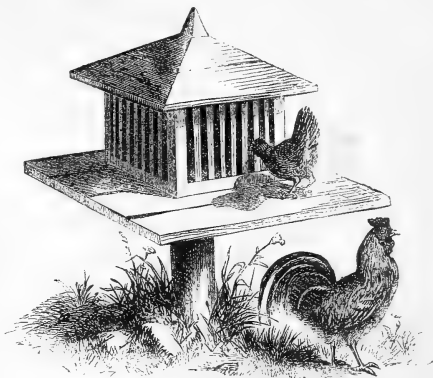

STOOL FEEDING-HOPPER.

nail this square in the centre of the platform; saw four strips one and a quarter inches square for the posts, which should be about eighteen inches high; nail strips of plank (which are not seen in the figure) two inches wide to the posts at top, to secure and steady them; then take common sawed lath, or thin strips of board one and a half or two inches wide, and nail them to the top and bottom, up and down, leaving a space of two inches between each slat, which will enable the fowls to insert their heads to pick the grain. The roof may be formed four square, like the engraving, or it may be made flat, or pitching on two sides like the roof of a house, and should be detached, so that it can be raised when required to be replenished with grain.

In order to make it proof against rats and mice, it will be necessary to elevate it at least three feet from the floor, if in a building, and this can be done by suspending it with wires at each corner and attached to the timbers or rafters above. The wires being small and smooth, the rats and mice could not pass up or down on them. If it is necessary to place the feeding-hopper in the yard, it may be placed on a post three feet high, and firmly set in the ground, as shown in the engraving; the platform

projecting so far from the post, it would be rather difficult for either rats or mice to climb up the post and on the under side of the platform.

The fowls will soon learn to leap upon the platform, and feed from the grain-box between the slats. From ten to fifteen fowls can feed at the same time.

In a late English work on poultry we find the following sectional drawings of a feeding-hopper for grain, and a trough for soft feed. In the end view here represented, *a* is a flap or

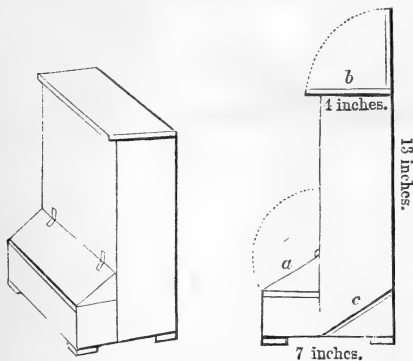

END VIEW.

hinged door to be opened and shut at pleasure; *b*, a hinged cover, through which feed is supplied; *c*, an incline, throwing the corn or other grain as wanted into the feeding-trough. This feeding-hopper will answer a very good purpose where there are no rats or mice; but we can not perceive any advantage it has over the preced-

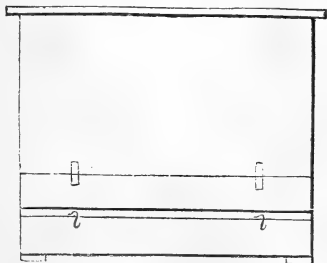

FRONT VIEW.

ing plans: it can be opened and closed at the option of the persons who have the fowls in charge.

Among all the plans for feeding-hoppers heretofore described we think the following invention of our own the most perfect. It is not only rat-proof, but weather-proof, as we hope to show in the description. Where fowls are fed in the yard, particular attention should be paid to keep the grain dry. The hopper figured below is well calculated to accomplish that object. *A* is an end view, eight inches wide, two feet six inches high, and three feet long; *B*, the roof projecting over the perch on which the fowls stand while feeding; *C*, the lid of the receiving manger raised, exhibiting the grain; *E E*, cords attached to the perch and lid of the manger or feeding-trough; *I*, end bar of the perch, with a weight attached to the end to balance the lid, otherwise it would not close when the fowls leave the perch; *H*, pulley; *G*, fulcrum. The hinges on the top show that it is to be raised when the hopper is to be replenished.

When a fowl desires food, it hops upon the bars of the perch, the weight of which raises the lid of the feed-box, exposing the grain to view,

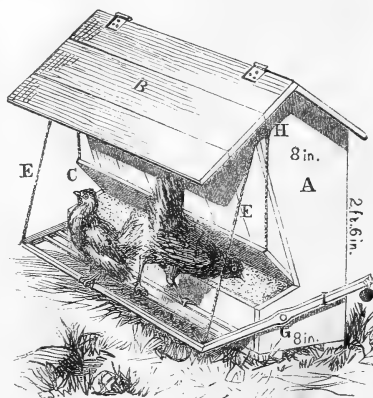

PERFECT FEEDING-HOPPER.

and after satisfying its hunger jumps off, and the lid closes. Nothing short of the weight of a fowl will raise the cover. Rats are wary and

suspicious animals, and any little movement of the apparatus would frighten them away. As a precaution, however, it would be advisable to cover the door and edges of the trough with tin.

This feeding-hopper may be increased by enlarging the diameter four inches, with another feeding-trough on the opposite side. In this case the end pieces of the perches may be cut off at the fulcrum, and one pin answer for both, and the lid loaded sufficiently to close after the fowls leave the perch. This may be done in part by covering the lid with tin, which would also prevent rats or mice from gnawing holes through the edges of the door.

For feeding with soft food, such as boiled potatoes, mush, barley-meal, shorts, middlings, brewers' grains, etc., a feeding-trough like the following one would be found very useful.

The trough should be two feet and a half

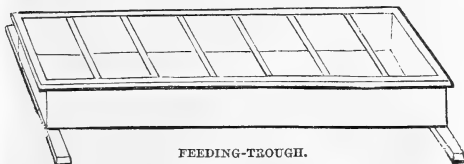

FEEDING-TROUGH.

long, eight inches wide, four inches deep, with lid of bars made to lift off at pleasure. It stands on feet, projecting six inches on each side, not only to prevent the trough being upset, but to keep the bottom dry. This being intended particularly for moist food, the bars and upper part should be removable to allow for a daily scouring.

#### WATER FOUNTAINS.

There should, if possible, be running water in the yard, as fowls prefer clean, pure water; and in order to prevent their drinking by chance what is bad or corrupted, wood, stone, or iron troughs, or what is much better, fountains similar to the two following. A small tube extends from the cask to a shallow dish or pan, which should be small, so that the fowls can not get into and soil the water. A jug, demijohn, or carboy may be substituted, and on some accounts the glass vessel may be preferred, as it can be more readily perceived when it requires replenishing.

When the hen is confined in a coop with her little family of chickens, they require consid-



BARREL FOUNTAIN.

erable water, and if a vessel is deep the chickens are sure to get into it, and not only soil and contaminate it, but often get their down wet, which injures, chills, and frequently kills them. To remedy this, we adopted the following bottle fountain for the mother and her brood, which we found to answer admirably well.

A very good fountain may be made by taking a thick piece of plank and scooping out one and a quarter inches, forming a shallow trough, and making a frame similar to the figure below, and inserting the neck of a bottle, the nozzle reaching to within three-fourths of an inch of the bottom of the trough.

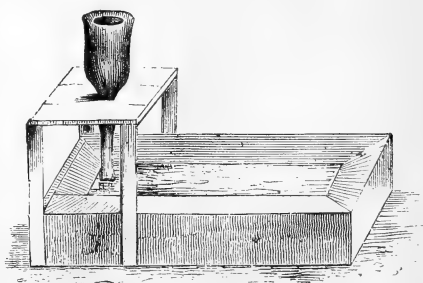

BOTTLE FOUNTAIN.

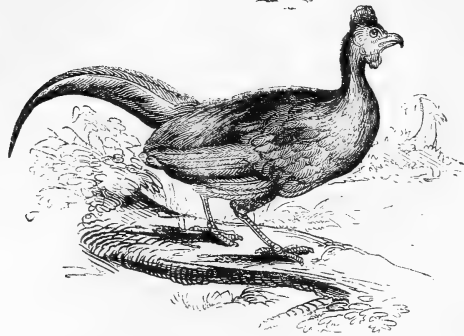

JAPANESE WILD FOWL.

## CHAPTER IV.

### WILD FOWL.

THE wild fowl are at present restricted to India, Malay, Sumatra, Java, and possibly in other islands of the neighboring groups, as well as those scattered over the vast Pacific. How far to the west, in remote ages, some of these species may have spread we know not; some may have been distributed from India through Persia, even to Mongolia and Georgia, anciently Colchis, whence the Greeks derived the pheasant, which they found on the banks of the Phasis.

The cock was supposed to be of Persian origin by some authors; but the period of their domestication is hidden in the remotest ages of the world; it is shrouded in mystery. It is said that in the Island of Ascension, wild fowl may be shot like partridges. In the Australian colonies, too, that fowls not well looked after take to a half wild state in the bush, and even building in lofty trees. It has been suggested too, that fowls of the game breeds might be turned out into coverts where pheasants will not stay, and the same opinion has been made

public by one of our numerous authors on poultry.

The acquisition of the fowl species has not, in all probability, been an easy conquest; to succeed in bringing them into complete bondage, a long series of attempts and cares has doubtless preceded the success we now enjoy, without being acquainted to whom we are indebted for them. The species has been since propagated and introduced into general use throughout the whole world, from east to west, from the burning climate of India to the frozen zone. They may be looked upon as a blessing to humanity. Among every polished nation on earth, and even among nations half-civilized, but united in stationary societies, there is no country habitation around which fowls more or less numerous are not met with, which man rears, shelters, and nourishes, and which are called *cocks* and *hens*. They are a species which art has almost entirely wrested from nature; fowls are every where seen in a domestic state, and wild ones are scarcely to be found any

where: it is not long since it was positively known where the latter still exist in small quantities.

Oliver de Serres says, "Among the moderns, *I am the first* that had seen fowls in a state of liberty. On my return from a first voyage to Guiana in 1795, I published a note on the subject of the wild cock and hen, which I have every reason to think natives of the hottest countries of the new continent. In traveling over the inextricable forests of Guiana, when the dawn of day began to appear, amidst the immense woods of lofty trees which fall under the stroke of time only, I had often heard a crowing, similar to that of our cocks, but only weaker.

"The considerable distance which separated me from every inhabited place, could not allow me to think this crowing was produced by domesticated birds; and the natives of those parts, who were in company with me, assured me it was the voice of wild cocks. Every one of the colony of Cayenne who had gone very far up the country, give the same account of the fact. Some have met with a few of these wild fowl, and I have seen one myself. They have the same forms, the fleshy comb on the head, the gait of our fowls, only they are smaller, being hardly larger than the common pigeon; their plumage is brown or rufous."

Some older travelers have spoken before of these wild fowl of South America. The Spaniard Acosta, provincial of the Jesuits at Peru, has positively said that "they existed there before the arrival of his countrymen, and that they were called, in the language of the country, *talpa*, and their eggs *ponto*. The ancient Mexicans had reduced these small fowls to domestication; they called them, as Gemell Carreri informs us, *chiacchialacca*; and he adds, that they were similar to our domesticated fowl, except they had brownish feathers, and that they are rather smaller. A fresh testimony, that of a traveler who has been all over Dutch Guiana after me, is again come in support of facts already certain. Captain Steadman has observed that the natives rear a very small species of fowls, whose feathers are ruffled, and which seem to be natives of that country."

It is then an indisputable fact that a tribe of wild fowl, very much like our cocks and hens, exists in the inland parts of South America. One can not reasonably suppose that this tribe springs from birds of the same genus which Europeans have transported thither, since they are only met with very far from any inhabited place; then there is a remarkable difference in the size of these and the common fowl; and, according to the assertion of Acosta, they existed in Peru before the arrival of the Spaniards.

But a learned traveler, to whom ornithology in particular is indebted for many capital discoveries, M. Sonnerat, has again found the species of the wild fowl on the antique land of India, in the mountains of the Ghauts, which separate Malabar from Coromandel. More successful than other travelers, M. Sonnerat took home two birds, a male and female, of the Indian tribe, and published a description of them in his "Travels to the Indies and China;" and he has taken them to be the primitive stock, whence have sprung all the tribes of our domestic fowl. He concurred in the opinion of Buffon, that most of our varieties of domestic fowl have proceeded from a single type; and that the differences which we perceive among them have resulted from accidents of climate, domestication, and crossing of varieties. Sonnerat did not or would not know of any other species of wild cock than this—for he speaks slightly of the authority of Dampier, who mentions that he saw wild cocks in the Indian Archipelago; but it is also admitted that the *Bankiva* species in Java, and the *Jago* species in Sumatra, more nearly approximate to our common fowl than that now under consideration, and to which Sonnerat refers. Upon the whole, it seems that our varieties of domestic fowl proceed from mixtures of one general species. Practical observers arrive at much the same conclusion on this point with scientific naturalists. It is thus, for instance, considered in India that our gamecock originated from a mixture of the jungle cock with the wild species in Malay and Chittagong. Altogether, however, it must be admitted that, on this disputed point, very little is actually known, and the domestication of the bird ascends to such remote antiquity, that it

seems hopeless to determine the era, and still more hopeless to ascertain the original species with precision.

The following lively statement on this subject is from "Excursions in India," by Captain Thomas Skinner, published in 1832:

"In some parts of the forests we saw several jungle fowl; they have exactly the same habits as the domestic poultry. The cock struts at the head of his hens, and keeps a strict watch over their safety. Whenever they were disturbed by our attempts upon them, he flew to the highest branch of some tree beyond our reach, and crowed with all his might, while his dames ran into holes and corners to escape our attacks. They are so cunning, that we found it impossible to get within shot of them with all the caution we could use. While intent upon capturing at least one, as we were creeping after them upon our breasts, lying occasionally like riflemen under cover of the unevenness of the ground to catch them *en passant*, we came suddenly upon an ambushade that very soon put an end to our sport.

"We were about midway up the face of a hill that was thickly covered with trees, and much clogged by shrubs and creepers that wound in all directions. On reaching the foot of the enemies' position, still advancing upon our breasts, and bending a keen eye upon the birds strutting before us, up rose, with a growl that denoted an offended spirit (for we had really touched his tail), a huge black bear; and, turning round, looked us in the face with the most undisguised astonishment. It was the most unsought, as well as the most unpromising introduction I had ever met with. There was no time for parley, and getting upon our legs, we at once stood on the defensive. This sudden metamorphosis completed his surprise, and yelling louder than before, he set off as fast as he could shuffle from the extraordinary animals that had so unaccountably sprung up before him. We determined that 'discretion was the better part of valor,' and began to retrace our steps, leaving the jungle fowl to benefit by the interruption."

It is seen by the foregoing description of the wild cock and hen of India, that the most striking dissimilarity consists in the wild fowls hav-

ing no comb on their head nor fleshy wattles hanging beneath the throat; but this difference is not sufficient to make this tribe be considered as other than that of the common fowl, in which, as it is known, a very ancient subjugation, removals and multiplications in opposite climates, differences of food, have produced numberless varieties, which, from all appearance, came originally from the wild fowl of the Ghauts. There grew besides, among common fowls, and chiefly in the tribe of tufted fowls, individuals whose head is without a comb, and the bill beneath without appendages.

The reasons for believing the Bankiva fowl is the wild stock from which our tame varieties derive at least their main origin are, the hens, the nature of the feathers, and the form and distribution of the barbs, which are absolutely the same in our tame fowls; and because it is in this species alone that the females are provided with a comb, and small wattles, characters not found in any other of the wild species.

"In point of size," say the authors of the "Poultry Book," "no less than the remote period at which we find reference to this bird, comes the 'Kulm cock,' sometimes called 'St. Jago cock.' The character of this inhabitant of the islands of the Eastern Archipelago and parts of the adjacent continent would seem to be far more suited to a state of domestication than we have reason to believe has been the case with other of the 'Jungle fowl,' properly so-called. It appears to have been reclaimed at the earliest period to which our knowledge of its native country extends, and in Europe, under the name of 'Malay fowl,' it shares the honor of a long pedigree with our oldest races. We have never seen a specimen of the wild bird, but all accounts unite in describing it as closely resembling the brilliant combination of chestnut, maroon, black, and yellow, that decorate the well-known Malay.

"This noble bird frequently measures more than two feet in height, and Lieutenant-colonel Sykes had one which was twenty-six inches. The comb of the cock is single, but slightly elevated, rounded at the top, and appears to terminate abruptly; the wattles are small, and the throat bare, as in the Guinea-fowl. Plumage

of the hackle, head, and upper part of back, golden-reddish; of the mid-back and lesser wing-coverts, dark chestnut; of rump, reddish-yellow. Tail very full, and, like the large wing-coverts, dark brilliant green; breast and belly glossy greenish-black; legs yellow. There is reason for believing that this bird is not only the parent of our Malay variety but also of the Shakebag.

"The birds commonly spoken of as Jungle fowl consist of two distinct species, inhabiting different localities; the Bengal Jungle fowl (there seems to be some confusion among writers on East Indian ornithology with regard to the bird thus designated. Sir William Jardine considers the 'Bengal Jungle fowl' identical with the 'Bankiva,' while Mr. Blyth and the writer on poultry literature in the *Quarterly Review*, by whom he is quoted, clearly refer to them as distinct), found in the northern portion of Hindostan, and as far north as the sub-Himalayan range, and the 'Sonnerat Jungle fowl,' which seems to be limited to the more northern portion of the great Indian peninsula.

"The 'Bengal Jungle fowl' resembles, in the general color of his plumage, the black-breasted Red game-cock, while in size, he is intermediate between that fowl and the Bantam. The tail in this, as we believe in nearly all the wild fowl, is carried nearly horizontally, a peculiarity which is only effaced by interbreeding for several generations with the vertical-tailed domestic fowl. It is also distinguished from all the other wild species by having a white face or cheek lappet, like the Spanish fowls.

"In Europe, we see comparatively little to recall the form, and still less that repeats the habits of the Jungle fowls; and the following passage from the pen of Mr. Blyth, points distinctly to the same state of things in India, where certainly we should most expect to witness at least some signs or tokens of transition from the jungle to the yard: 'It is remarkable that the domestic poultry of India do not approximate to the wild race in any respect more closely than the common fowls of Europe; and I have sought in vain for traces of intermixture of jungle-fowl blood in districts where the species abound in a state of nature.'

"Cross-bred birds between the Indian Jungle fowl and the English Game fowl are by no means uncommon. Mr. Thurnall has a high opinion of them as regards both their courage and appearance. The cock of the first cross, he tells us, carries his tail about half-way between the game-cock and the pheasant; but most of his progeny carry theirs but a little lower than the true-bred game fowls.

"By the kindness of this gentleman we are now in possession of a pair of these birds. The Bengal Jungle fowl is evidently the stock from which they have been derived, though faint traces only of his blood now remain. A son of a Bengal bird from a black-breasted hen was put with a brown-breasted hen, and these fowls were some of the progeny. There is little in the cock to distinguish him from a good red-breasted bird. The head, however, is remarkably fine, and the intense maroon of his back and saddle remind one, on a close inspection, of the feathering of his wild grandfather. So greatly, however, have both feather and form merged into those of the game fowl, that these traces are by no means evident at first sight, though his descent is most fully authenticated.

"Dr. Horner, of Hull, has most kindly communicated to us the following particulars of some birds bred between the Game fowl and Sonnerat's Jungle fowl, which we have already referred to as inhabiting the southern portion of the Indian peninsula:

"The cock is three-fourths pure Sonnerat, and as like the old Sonnerat cock as could as well be, only failing in not having the saddle feathers so perfectly laminated as the hackle. This laminated appearance may be compared to what is seen on the wing of the waxen-chatterer; on each feather there should be two lamina or scales; these are produced by the flattening of the shaft of the feather; the hackles have two such plates, other feathers but one, though somewhat more prolonged than the former. The color of the plating is a rich golden tint, somewhat sparkling and refulgent; some of the larger hackles are rounded at the extremity. The tail, though carried less horizontally than that of the pheasant, has the same general character. Its color is iridescent black;

the head is wholly red; the eye sharp, quick, and watchful; but of the gorgeousness of the bird's plumage I can give no idea; it is lustrous with gold and all the prismatic colors—a combination of a black-breasted red game-cock and the Chinese pheasant. His legs are red, spurs very sharp, crow harsh and short, between a gobbler and a crow. He is very pugnacious, and thoroughly master of my Polands; for although he appears soon tired, he never runs, and after catching his wind for a minute, begins again, and thus fairly tires out his adversary. But when victorious he is by no means intolerant, and of a most fatherly disposition toward his chickens. His weight is about three pounds. The hen, his grand-daughter through game mothers, exhibits a close resemblance to the feathering of the duck-wing, but of a sparer and still more delicate figure. She lays abundantly, the eggs being cream-colored—far richer than those of the common fowls. The chickens prove delicate, and are reared with difficulty, though tended with most unusual care by their male parent, who is constantly seen brooding them by night as well as day, in cold and unfavorable weather.

“But in addition to these half-breeds between the Jungle fowls and the Game, the different varieties of the latter have themselves been so frequently intermingled, no less from a desire to check degeneracy than from the result of accident, that the task of arrangement, as regards mere feather, presents difficulties of no ordinary character. Thus many are of opinion that we must look to the black-breasted reds as the original progenitors of the whole race. But this theory is at variance with the permanent character of some strains, where, throughout a long course of years, like has produced like without any material deviation in color or form.

“But unwilling, as we certainly are, to give our assent to this theory, we should certainly be inclined to side with those who, selecting the black-breasted reds, the duck-wings, and the whites, regard these strains as sufficient to account for the production of all our present sub-varieties. Whether the two former owe their existence respectively to the Jungle fowl and Sonnerat's, as many are of opinion, we are not

prepared either to affirm or deny, though to prove the descent satisfactorily we should ask for further evidence than has yet been attainable. The white birds are thought to be a distinct race, and their continued alliance with the two former would explain the cause of many of those combinations of color, among the Piles especially, which are often found as variable as they are undoubtedly beautiful; and domestication would certainly have sufficient influence on the descendants of each supposed cross to justify our referring the whole game variety to these three ancestral stocks.”

Mr. Dixon's account of this same cross is at variance with the afore-mentioned description; but the latter having been given from continued personal observation, we have no hesitation in thus laying it before our readers.

We should imagine from these two accounts that the progeny of Sonnerat's cock would longer retain the feathering and characteristic of the wild bird than is found to happen with the offspring of the Bengal Jungle fowls; the greater brilliancy and variety of plumage would, of course, tend to this result.

#### SONNERAT'S JUNGLE FOWL.

This splendid bird, of which many specimens have long been in the Menagerie of the Zoological Society, London, is celebrated for its high courage and prowess, and is in great request among the cock-fighters of Hindostan, who consider it more than a match for a larger bird of the ordinary breed. Its port is erect and stately, and its form is admirable. In size this species is nearly equal to the domestic fowl, but is lighter, weighing but three pounds, and differing both in gait and carriage, as well as in shape, from all other poultry. The comb is only slightly indented; the wattles are large and double, the hackles (though they scarcely come under this) of the neck, of the wing and tail coverts, dark grayish, with light golden orange shafts dilating in the centre and toward the tips into a flat horny plate. In some of the feathers the shaft takes an elliptical or oar-like shape; in others it puts on the appearance of a long inverted cone, from the centre of the base of which a battle-door-like process arises.



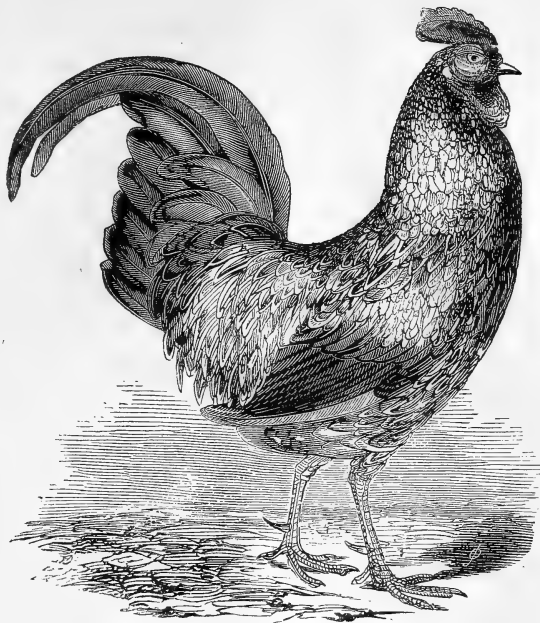

SONNERAT'S JUNGLE FOWL.

The substance and appearance of these plates have been not inaptly compared with the wax-like plates which ornament the wings and tail of the Bohemian Chatterer. Feathers of the middle of the back, breast, belly, and thighs, deep rich gray, with paler shafts and edges; tail generally rich green; the feathers which immediately succeed the hackles are rich purple, with a pale yellow edge; those next in succession are golden-green, with gray edges, and all glossed with brilliant metallic reflections; bill, legs, and feet, yellow. The living bird presents altogether a rich and striking object, especially when the sun shines on the plumage.

## SONNERAT'S JUNGLE HEN.

This fine bird is less than the cock, without comb or wattles, but with a trace of nakedness round the eye. The plumage generally is without

the horny structure which distinguishes that of the cock. Upper parts uniform brown; neck feathers with dark edges; those of the back and wing coverts with a pale streak along the shaft, and those of the wings; tail coverts and tail waved and mottled with darker pencilings; throat and front of the neck white edged with dark brown; legs and feet bluish-gray.

Sonnerat's Jungle cock is distinguished by the singular flattening of the shaft or mid-rib of the hackle and saddle feathers; a laminated appearance is thus obtained of extreme richness, these plates being of a bright golden-yellow.

"In our chapter on Game Fowls," say the authors of the "Poultry Book," "we alluded to a cross between this bird and a game hen, the produce of which was in the possession of Dr. Horner, of Hull. The kindness of that gentleman has since supplied us with some further information, which has such immediate reference

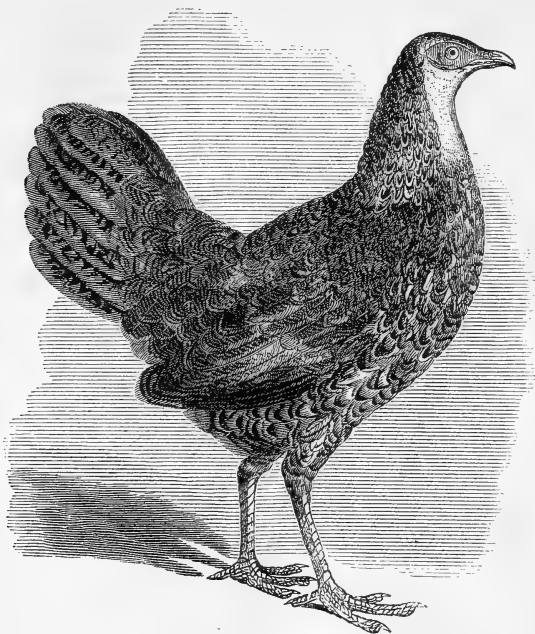

SONNERAT'S JUNGLE HEN.

to the subject of our present inquiries, the connection between the wild and domestic galli, that we now gladly lay it before our readers.

“My Sonnerat cock,” says Dr. Horner, “as I have learned from Mr. Hunt, chief superintendent of the aviaries at the Zoological Gardens, Regent’s Park, was bred at those gardens, between the true Sonnerat jungle fowl and a game hen. In size he is decidedly less than the game cock, weighing but three pounds, and differing both in gait and carriage, as well as in shape, from all other poultry. He is remarkably quick, showing great activity and alertness in all his movements. In his ordinary walk he is not so upright as the game—in indeed, he has often somewhat of a stooping manner; his wings are drooping or carried low, which gives his back a rather rounded appearance, and showing off to advantage its rich plumage; the tail, also, is not car-

ried so high as in other fowls. When at all excited his gait and attitudes are light, graceful, and peculiarly alert.

“The eye is particularly bright, sharp, and watchful; the wattles, and the comb, which is serrated, are of moderate size; the whole side of the head is red and smooth. The feathers of the golden-colored hackles, of the neck, the larger of which are round or blunt at the end, and the fine, rich, dark-crimson feathers of the shoulders or saddles, have their shafts or mid-ribs dilated, in one or two parts, into horny-like plates, as seen on the wing of the Waxen or Bohemian Chatterer, and which are of an exceedingly rich deep golden-yellow; giving to the plumage a very refulgent and sparkling appearance, especially when the sun shines thereon. The feathers of the breast and back are more pointed than in other poultry, and are of a

fine grayish color, lighter in the middle part, and fringed on the edges, some with grayish-white, others with various shades of yellow. The tail is of a shining greenish-black, the smaller feathers near its root being a rich refulgent purple-green, and some of them are laced with yellow; the legs are of a red color.

“As in mankind we often see true courage united with a gentle and amiable disposition, so it is in my hybrid Sonnerat, and that in a most remarkable degree. He is not only of a truly courageous but even of pugnacious disposition with other male poultry; but to hens, of whatever breed, even the Shanghais, he is kind and courteous, and to his own mate lavishly so. It is, however, in the extraordinary attentions to his chickens that his amiable and considerate conduct shines so peculiarly forth. Last year when his chickens were half-grown, and had long been discarded by their mother, he might be observed daily offering them in his beak all the delicacies he could select from the general food; nay, on occasions of a slight shower, or in cold winds, he frequently might be found with a pair of huge chickens hiding under his wings, which, by their size, were nearly lifting him off his legs. At night, one or more would invariably so nestle; keeping his wings apparently in no very comfortable position.

“In recording the good qualities of the hybrid Sonnerat according to my own experience, I should state them to be, the unequaled richness of the eggs, their abundance, and the great beauty of the cock bird; and in this example at least his amiability.

“The eggs laid by the hen (his own granddaughter through a game hen) are decidedly smaller than those of the game, and weigh less by rather more than a quarter of an ounce. The loss in size is, however, well compensated for by quality; they possess a richness and flavor unequaled, and which is at once recognized by every one.

“Mr. Hunt informs me that he considers there are but two cock birds in England really bred direct from the Sonnerat Jungle fowl, and which exhibit the peculiar golden plate on the feathers—the one at present (1853) in the Regent's Park Gardens, and my own. He also warns

me of the difficulty of rearing chickens bred “in-and-in.” I have accordingly added a game hen as a companion. Though the old birds exhibit considerable wildness in their look, yet a cockerel, raised last year, will daily take his food from my fingers, and his look is docile.

“My hybrid hen is less than the common game hen, and is of more delicate shape. She exhibits much of the color of the duck-wing variety, probably from her game parentage. The neck and breast are of very pale ochre.”

“Mr. Blyth also states that he found the progeny between the Sonnerat cock and a domestic hen decidedly infertile.”

#### THE BANKIVA JUNGLE FOWL.

This beautiful species is the most diminutive of its genus, and the stock to which our own bantams are generally and with much probability assigned. It is a native of the Island of Java; but a bird nearly allied to this, though somewhat larger, is found on the continent of India. Writers, however, in the natural history of these countries, limit the designation Bankiva to the smallest fowl. “An account has been given of an imported pair of Bankiva fowl, from which, however, no progeny was obtained, either pure or from bantam hens, that were introduced into their aviary; they retained their unsociable demeanor to the last; and after slaughtering several bantams that had been thus placed with them, they themselves at last fell victims to the superior strength of a game hen.” Many specimens have been seen in the gardens of the Zoological Society in Regent's Park, London.

“Specimens of these fowls, male and female,” says Dickson, “were brought from the Island of Java, by M. Leschenaust, and deposited in the Museum of Paris. They inhabit the forests and borders of woods, and are exceedingly wild. On examining the species, it will be found to exhibit many points of resemblance with our common barn-yard fowls of the smaller or middling size. The form and color are the same, the comb and wattles are similar, and the hen so much resembles the common hen, that it is difficult to distinguish it, except by the less erect slant of the tail. The rise of the tail is much more apparent in the male; but it may be ob-



THE BANKIVA JUNGLE FOWL.

served, that in all the wild species known, the tail does not rise so high above the level of the rump, nor is it so abundantly provided with covering feathers, as in the common birds. Probably the superabundance of nourishment, and the assiduous care of man, have contributed to the greater development of all their organs. Different tame birds, indeed, such as the tufted fowl, the Hamburgh double-comb varieties, and others, show that domestication, probably on account of superabundant feeding, produces infinite varieties.

The Bankiva cocks very much resemble, both in form and color, the tame Turkish and bantam breeds; but the tail differs in being nearly horizontal and vaulted in the Bankiva, while in the others it is more raised, and forms two upright planes meeting above, and diverging below.

The feathers which fall from the neck over the top of the back are, as in other fowls, long and with divided plumelets or braids, the feathers widening a little and being rounded. The colors of the plumage are exceedingly brilliant. The head, the neck, and all the long feathers of the back which hang over the rump are of a shining flame-colored orange; the top of the back, the small and middle coverts of the wings, are of a fine maroon-purple; the coverts of the wings are black, tinged with iridescent green; the quill feathers of the wings are rust-red on the outer, and black on the inner edges; the breast, belly, thighs, and tail, are black and tinged with iridescent green; the comb, cheeks, throat, and wattles, are of a more or less vivid red; the legs and feet are gray, and furnished with strong spurs; the iris of the eye yellow.

## THE BANKIVA JUNGLE HEN.

The Bankiva hen is smaller than the cock; and her tail is also a little horizontal and vaulted; she has a small comb, and the wattles are very short; the space round the neck is naked as well as the throat; and on this space are some small feathers, distinct from each other, through which the red skin can be seen; the breast and belly are light bay, or fawn-yellow; on each feather is a small clear ray, along the side of the mid-rib or stem; the feathers of the base of the neck are long, with disunited braids or plumelets, of a black color in the middle, and fringed with ochre-yellow; the back, the coverts, the wings, the rump, and the tail, are earthy gray, marked with numerous black zigzags; the large feathers of the wings are ashy-gray.

The reasons for believing that the Bankiva fowl is the wild stock from which our tame varieties derive at least their main origin are, the close resemblance of their females to our tame hens, the nature of their feathers, and the forms and distribution of the bars, which are absolutely the same in our tame cocks; and because it is in this species alone that the females are provided with a comb and small wattles, characters not found in any other of the wild species which are known.

A larger variety of the Jungle fowl, or perhaps a distinct species, is found on the continent of India, which closely resembles the black-breasted game breed of England. It tenants the jungles, and in some districts is very abundant. The plumage of the cock is as follows: The hackles of the neck and rump are long, and of a fine rich orange-red; the greater coverts and secondaries deep blue; the quills brownish-black, edged with pale reddish-yellow; tail black, with green and steel-blue reflections; breast and under parts black; the comb, which is upright and deeply indented, the marked space round the eye, and the wattles, are scarlet. The feathers of the neck are long, falling down, and rounded at the tips, and are of the finest gold color. It continues to reproduce, in the wild state, in the forests of India, and is clearly distinct from the domestic reared by the Hindoos; as these resemble, in all respects, the other tame breeds

of fowls in every quarter of the globe. M. Sonnerat, however, thought very differently, and prided himself much on the discovery of other wild fowls in Timor and other Indian Islands. The jungle fowl, in a word, seems to be as different from any known variety of our tame fowls, as a hare is from a rabbit, or a goat from a sheep, and the fact that a jungle fowl is not domesticated in its native country of India, while our barn-yard fowls are common there, seems to settle this question beyond any appeal.

## THE CEYLON JUNGLE FOWL.

Some birds of extreme beauty and most unique appearance have been lately introduced into England, and are now in the possession of Mr. Bissell, of Birmingham. "We," say the authors of the "Poultry Book," "have to express our thanks to that gentleman for the full description that he has favored us with, and which we can not do better than place before our readers in his own words. The term 'Jungle' fowl, however, we should premise, would appear apt to mislead us in respect of their habits and character, since by that expression we are accustomed to denote the unreclaimed inhabitants of the Oriental forests, whereas the specimens in question appear to rival Shanghai themselves in their quiet and contented demeanor.

"The Ceylon fowls which I possess,' says Mr. Bissell, 'were imported direct from the island from which they take their name in the early part of 1852, by a gentleman of Bristol, and were exhibited by him at the show in that city in the following December. They attracted on this occasion considerable attention, and were justly considered among the most beautiful specimens that were then brought together.

"Their general appearance has much of the Shanghai character; the points of excellence in the latter being still more fully developed, almost, indeed, it might be said, to exaggeration, size alone excepted, for the cock weighs but four and a half pounds, and the hen is not quite four pounds.

"They are exceedingly tame and docile in their habits, and a three foot fence is at all times

sufficient to restrain them within prescribed boundaries.

“There appears to be two distinct varieties of color—the one light, the other dark; the former of these has a general resemblance to the body color of the silver-penciled Hamburgs, but on close inspection the markings of the feathers are found to differ materially, not only from the plumage of these birds, but likewise from that of any domestic fowl that I have yet seen.



“The edge of the feather is margined or laced with white all round to the width of about one eighth of an inch, then comes a brownish-black inner line of about the same thickness, then one of white, while the centre of the feather is of the same dark hue, the shaft or stem being of a very clear white.

“Nothing, I can assure you, can be more beautiful or distinct than the plumage of this charming little hen—the very slightest bantam not being excepted. The cock does not manifest the same minuteness of marking, but nevertheless he bears quite as much similitude to

the hen as will be found to exist in the Shanghais, Game, Dorkings, and Hamburgs.

“The dark variety differs in color only, the hen being a light brown with dark markings, the cock a light red with markings of black.

“The peculiar beauty of the Ceylon fowl is certainly in their plumage, but the singularity of their form renders them objects of attraction and interest to the most casual observer. The head is neat and small; the comb single, upright, and serrated; ear-lobe scarlet, thin, and projecting from the face; legs (which are exceedingly short, so much so, indeed, that the feathers of the lower part of the body almost touch the ground) yellow, and free from feathers; bill yellow; wings short; tail the same, and carried almost horizontally; thighs more fluffy than in the best specimens of Shanghais, and their general figure also of a much more compact and squarer build than in any specimens of the latter birds that I have seen or possessed.

“The hen has both laid and sat this season, but as yet I have no produce; she is a good layer as well as a good sitter, and I have no doubt would prove a good nurse; and should I be so fortunate as to perpetuate the breed, there is little doubt that it would be generally acknowledged as among the most ornamental as well as useful of our poultry.”

#### THE FORK-TAIL FOWL.

This is another richly-plumaged native of Java, but seems to possess no tie that might connect it with our domestic race.

This curious fowl was first described by M. Temminck, in 1818. It is nearly two feet in length to the extremity of the tail. The cheeks are bare, the head furnished with a simple entire comb, and the throat with a single large wattle, springing from the centre; they are all light red. The head, neck, and upper part of the back are remarkable from the short and rounded form of the feathers, of a dark metallic blue. The hanging feathers are of a rich metallic green, tinged with steel-blue. The bill, legs, and feet, yellow. The hen has a circle round the eyes only naked, and of a livid tint. This bird is said to be very abundant in Java, and may be often seen during the day upon the edges of the

woods and jungles, but possesses the same disposition of its co-genus and pheasants, and, upon the least alarm, runs to cover. They are not domestic, but they occasionally breed with the tame varieties—a curious fact, and showing the uncertainty with which the true origin is clouded.

That many of our present breeds of fowls may have been derived from these four species, viz., *Sonnerat's Jungle fowl*, *Bankiva Jungle fowl*, *Fire-backed Jungle fowl*, and *Forked-tail fowl*, we have little doubt; but still these are not necessary to be regarded as the sole ancestors. The frizzled and tailless fowls, for instance, are both said to exist in a wild state; and the former especially is thus spoken of as inhabiting the interior of Ceylon. Their origin can not be referred to a mere *lusus naturee*, and can hardly be assigned to any of the birds before mentioned. Should these, therefore, be thus distinct, why should a separate origin be refused to other races.

"In our experiments at the present day," say the authors of the "Poultry Book," "when we attempt either the domestication of the wild *Gall*, or cross them with the occupants of our poultry-yards, we find few instances where their untamed character is so far subdued as has happened with Dr. Horner's *Sonnerat* hybrid. In by far the majority of cases, not only in this country, but even in India, there appears so decided a repugnance to the redeemed state, that, if these were indeed the sole source from which the domestic fowl has been obtained, we are led to inquire by what process that, to us most difficult feat, was ever accomplished. In two ways may this have been effected; the first of which would rest on the supposition that, in times immediately succeeding the earliest records of our race, the birds that we now call jungle fowl were less indisposed to minister to the wants of mankind in a state of domestication, or else that one of their family, now no longer existing in a wild state, became at once the willing companion of man, and subservient to his will. A similar theory has been employed with reference to the camel, of which no naturalist has yet discovered any trace in an unreclaimed state, and some other members also of the animal kingdom seem to have at least approached the same condition of existence.

"No positive conclusion, it is true, can be based on such a line of reasoning; but it surely presents a path with fewer obstacles to our inquiries than the idea that the present economy of any portion of the animal kingdom varied so greatly at any time from what we now see to be its regular course, as an adherence to the notion that the natural habits of any beast of the field, or fowl of the air, underwent so violent a change, must necessarily imply."

The recent impetus that has been given to the study of poultry may throw fresh light on this interesting subject, especially by introducing from their native abode the species of wild fowl to which we have alluded, or others that may still remain undiscovered in unexplored wilds, as yet untraversed by the foot of civilized man.

#### THE FIRE-BACKED JUNGLE FOWL.

This noble species, which is intermediate between the true jungle fowls and the pheasant, is larger than the domestic game breed, and stands peculiarly high in its legs, which are strong, and in the male armed with sharp spurs; there are no long hackle feathers on the neck; and the head, adorned with a crest of naked shafted feathers, expanded at their tips into slender spreading barbs, is destitute of both comb and wattles. The sides of the head from the base of the beak to the occiput, are covered with a naked purplish skin, encircling the eyes; the general plumage is black, shot with gleaming steel-blue; the lower part of the back is rich orange-red or flame color, and the color extends zone-like around the body; but becomes obscure on the abdomen; tail coverts broad, of a rich glossy bluish-green, with a paler bar at the tip: the four middle tail feathers, and the two central bending ones (which are really developed tail coverts in the males of the forest tribe) are white, the rest black with green reflections.

This fowl seems to be an intermediate form or cross between the fire-backed pheasant of Sumatra and common fowl. It is said to be a splendid bird, and might perhaps be domesticated. One of the remarkable characteristics of this fire-backed cock is the total absence of both hackle and saddle feathers; he is also nearly

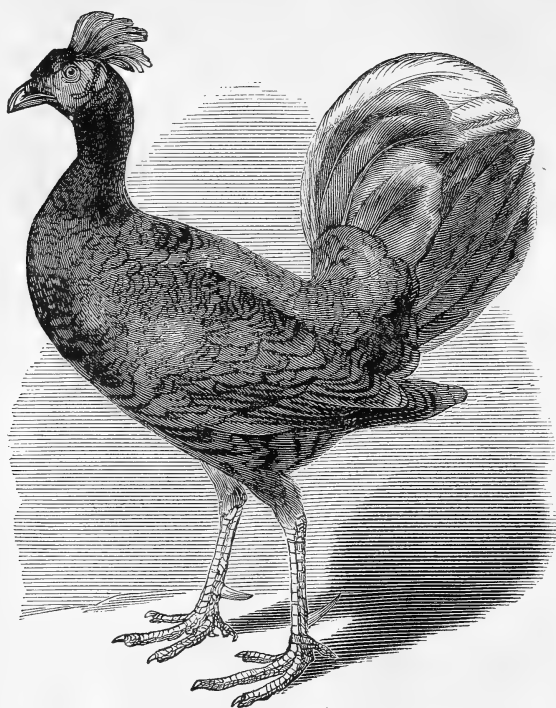

THE FIRE-BACKED JUNGLE FOWL.

devoid of sickle-feathers, being intermediate between those of the cock and the hen, the principal feathers being nearly straight, and not inclining to either side.

Hybrids between the pheasant and common fowl are of frequent occurrence; but are generally considered to be unproductive among themselves, all being half-bred, but when paired with the pheasant or the fowl, the case is different. A correspondent in the *London Agricultural Gazette* says, "After many trials of paired hybrids, I have never brought up but two to be almost hens, and they took the megrims (staggers), and died." And yet another writer in the same paper declares: "From what I have seen

of the plumage of birds casually produced at the woodside (from crossing with pheasants), I believe a judicious and scientific selection would lead to the production of very fine varieties, and that, among others, the dark pheasant-plumed breed both of game or other fowl would reward the patient inquirer."

In their general habits and manners, it is said they resemble their domestic relatives; the cock proudly struts and leads his train of females, and vigilantly watches over their safety. On being suddenly disturbed the troop scatter in all directions, seeking safety under covert of the dense brushwood. In spots where they are numerous, the challenging of the cocks to each other may



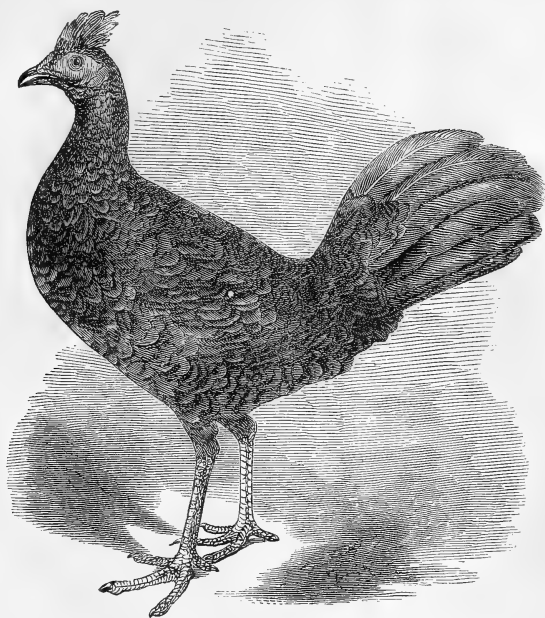

THE FIRE-BACKED JUNGLE HEN.

be heard on every side around, and yet such is their cunning and keenness of sight, that the sportsman, unless he is well acquainted with their habits, is often disappointed in his attempts to get a fair shot.

#### THE FIRE-BACKED JUNGLE HEN.

The hen has her plumage of a rich cinnamon-brown, the feathers of the upper parts being slightly mottled with black; the throat is white, and the feathers of the under parts, which are paler than those of the back, are edged with white; head crested; tail folded as in the fowls.

This species is a native of Sumatra, and was first introduced to science by Sir G. Staunton, in the narrative of his "Embassy to China." His host at Batavia, among other interesting specimens of natural history, possessed one of these birds, which was presented to Sir G. Staunton; it

was sent to England and described by Mr. Shaw. As its tail was mutilated, the figure is so managed as to leave the form of the tail undetermined. The bending feathers of the tail are shorter and much broader than those of the Bankiva, Sonnerat's, or the domestic fowls.

#### THE AUSTRALIAN JUNGLE FOWL.

Mr. Gould, an English naturalist, in his able work on the "Birds of Australia," gives an interesting account of this bird, which in size is about that of a common fowl, and must not be confounded with the Jungle cock of India, a very different bird. Its mode of constructing its mound-like nest, and its manner of depositing the eggs, etc., very much resemble those of the bush turkey (Talegalla), hereinafter described.

"The Jungle fowl," we learn, "is almost exclusively confined to the dense thickets immediately adjacent to the sea-beach; it appears

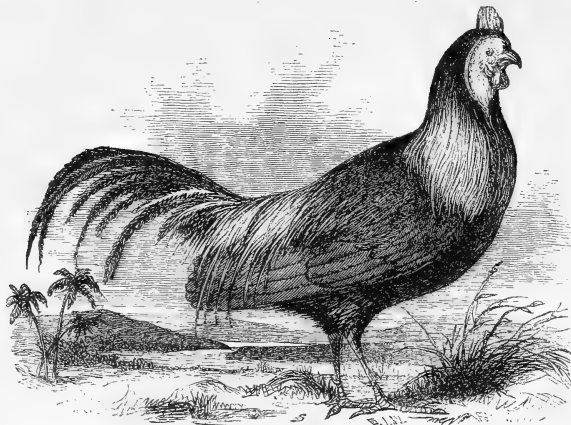

AUSTRALIAN JUNGLE FOWL.

never to go far inland, except along the banks of creeks. It is always met with in pairs or quite solitary, and feeds on the ground, its food consisting of roots, which its powerful claws enable it to scratch up with the utmost facility, and also of seeds, berries, and insects, particularly the larger species of Coleoptera. It is at all times a very difficult bird to procure; for although the rustling noise produced by its stiff pinions when flying away be frequently heard, the bird itself is seldom to be seen. Its flight is heavy and unsustained in the extreme; when first disturbed it invariably flies to a tree, and on alighting stretches out its head and neck in a straight line with its body, remaining in this position as stationary and motionless as the branch on which it is perched; if, however, it becomes fairly alarmed, it takes a horizontal but laborious flight for about a hundred yards, with its legs hanging down as if broken. I did not myself detect any note or cry, but from the natives' description and imitation of it, it much resembles the clucking of the domestic fowl, ending with a scream like that of the peacock.

"The head and crest of the bird is of a very deep cinnamon-brown; back of the neck and all the under surface very dark gray; back and wings cinnamon-brown; upper and under tail

coverts dark chestnut-brown; tail blackish-brown; bill reddish-brown, with yellow edges; tarsi and feet bright orange. It appears that on Mr. Gilbert's arrival at Port Essington his attention was attracted to numerous great mounds of earth which were pointed out to him by some of the residents, as being the tumuli of the aborigines. The natives on the other hand assured him that they were formed by the Jungle fowl for the purpose of hatching its eggs; and so it afterward proved. One of these mounds is described as fifteen feet high, and sixty in circumference at the base, and so enveloped in thickly foliaged trees as to preclude the possibility of the sun's rays reaching any part of it."

The list of wild fowls has now been gone through; a short reference, therefore, to these races that have been commonly regarded as the progenitors of our poultry-yard, will complete this portion of our labor.

First, in point of size, no less than the remote period at which we find reference to this bird, comes the *Gallus Giganteus* of Temminck, the Kulm cock or Jago fowl of other naturalists. The character of this inhabitant of the Eastern Archipelago and parts of the adjacent continent would seem to be far more suited to a state of domestication than we have reason to

believe has been the case with others of the "Jungle fowl" properly so called. It appears to have been reclaimed at the earliest period to which our knowledge of its native country extends, and in Europe, under the name of the "Malay fowl," it shares the honors of a long pedigree with their oldest races. We have never seen a specimen of the wild bird, but all accounts unite in describing it as closely resembling the brilliant combination of chestnut, maroon, black, and yellow, that decorate the well-known Malay.

This noble bird, the Kulm fowl, frequently occurs more than two feet in height, and Lieutenant Sykes had one which was twenty-six inches. The comb of the cock is single, but slightly elevated, rounded at the top, and appears to terminate abruptly; the wattles are small, and the throat bare, as in the Guinea-fowl. Plumage of the hackle, head, and upper part of the back, golden-reddish; of the mid-back and lesser wing coverts, dark chestnut; of rump, reddish-yellow. Tail very full, and like the large wing coverts, is a dark brilliant green; breast and belly glossy greenish-black; legs yellow. There is reason to believe that this fowl is the parent of our Malay variety.

The birds commonly spoken of as Jungle fowl consist of two distinct species, inhabiting different localities; the "Bengal Jungle fowl," found in the northern portion of Hindostan, and as far north as the sub-Himalayan range, and the "Sonnerat Jungle fowl," which seems to be limited to the more southern portion of the great Indian peninsula.

The Bengal Jungle fowl resembles in the general color of his plumage the black-breasted red game-cock, while in size he is intermediate between the fowl and the bantam. The tail in this, as we believe in nearly all the wild galli, is carried horizontally, like the Australian jungle fowl, a peculiarity which is only effaced by interbreeding for several generations with the vertical-tailed domestic fowl. It is also distinguished from all other wild species by having a white face or cheek lappet, like the Spanish fowl.

Sonnerat's jungle cock is distinguished by the singular flattening out of the shaft or midrib of the hackle and saddle feathers; a laminated appearance is thus obtained of extreme richness, these plates being of a bright golden-yellow.



## CHAPTER V.

## ASIATIC FOWLS.

UNDER this head we class the Malay, the Cochinchina, the Shanghai, and the Brahma-putra. These fowls all take their names from the country and rivers of their nativity. There is some difference in the orthography of the name of the latter, some spelling it Brahma Pooter, Brahma-putra, Burrampoetra. We shall adopt the second, and abbreviate it for convenience' sake to Brahma.

The Malay fowl takes its name from a town or province of that name, situated on the Straits of Malacca, in the most southern portion of Asia.

Cochin, from which the Cochinchina fowl derives its name, is a sea-port-town in south-eastern Asia, on the coast of Malabar.

Shanghai is a port in China, from which many of the Asiatic fowls are shipped; hence the name of "Shanghai" is given them.

Brahmaputra, whence the name of the fowl is derived, is a great river of southern Asia.

During the last twelve years many importations of fowls have been made from India, China and elsewhere, that are much superior in size, laying qualities, and in their general domestic habits to our common fowls. Among the Asiatic fowls the Shanghais have occupied a prominent position; not, however, as the best among us, as many have contended, but as a fowl in many respects superior to our common breed.

The Brahmas are generally acknowledged to be at the head of the list in regard to size, weighing at maturity from twenty-two to twenty-six pounds per pair.

There seems to be considerable difference of opinion as to whether the Cochins and Shanghais are varieties or distinct breeds. "There

is a doubt," says the Rev. Mr. Wingfield, author of the "Poultry Book," "which had better be removed from the very threshold, usually conveyed in the question—'Are Cochinchina and Shanghai fowls the same?' We have always entertained the opinion that they are; and as we have invariably found that fowls imported from China into this country, whether feather-legged or plain-legged, whether dark-plumaged or light-plumaged, came hither, directly or indirectly, either from Shanghai or its vicinity, we have long since concluded that Cochinchina is a name altogether misapplied in this variety. This conclusion amounts to conviction, since we have received a letter from Mr. Roland Fortune, who passed so many years in various parts of China, in which he says: 'The man who first gave these fowls the name of *Cochinchina* has much to answer for. I firmly believe that what are called *Cochinchinas* and *Shanghais* are one and the same. One thing is certain—the breed you have in this country as *Cochinchinas* are plentiful about Shanghai. They were discovered after the war, and were frequently brought to this country, and taken to India, by captains of trading vessels. Was not this the date of their introduction to England? And what grounds has any one for supposing the fowls ever saw Cochinchina?' We thought this variety might have been earlier known, owing to our long-established commerce with Macao and Canton, but Mr. Fortune says that it is a breed but little known in those warmer parts of China, and that 'in fact, the southern Chinese were as much struck with the size of the breed as we were.' He adds, 'The Shanghai breed seems to be more common about Shanghai than any where else in the north; but I

GROUP OF ASIATIC FOWLS.

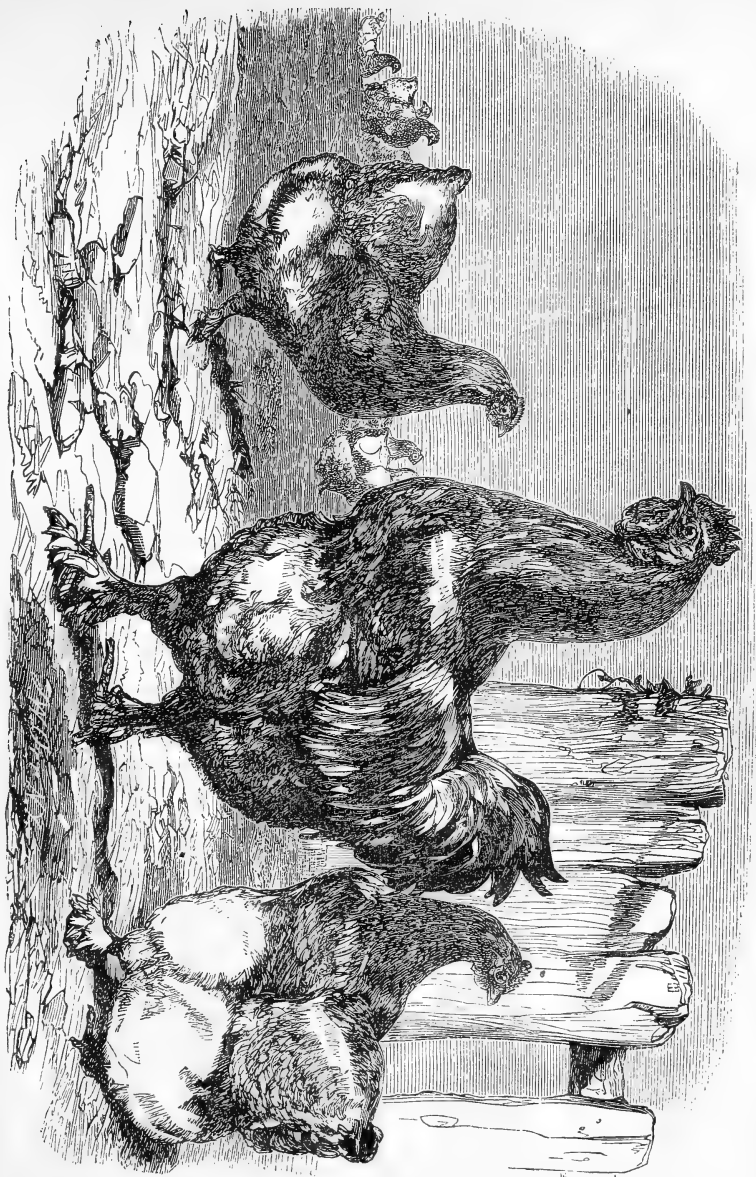

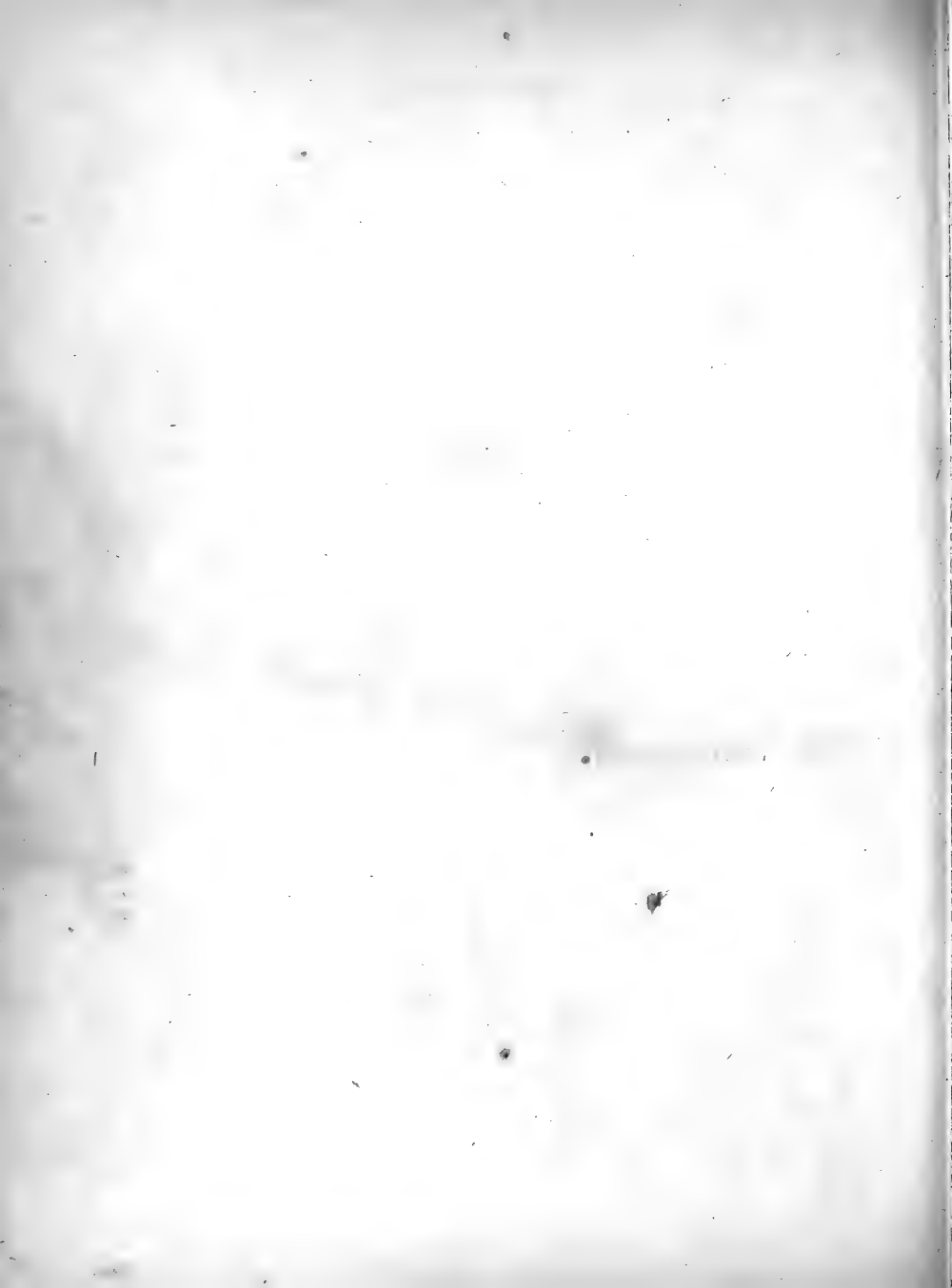

found it all over the low country of that part of China. The southern breeds have been long well known to ship captains and English residents; but there is nothing very marked in their character.'

"We have already stated that we do not believe that there are any grounds for the belief that this variety ever saw Cochin-China; and we think, with Mr. Fortune (for this question is indicative as well as inquisitive), that they were introduced into this country soon after the more northern parts of 'The Celestial Empire,' such as Shanghai, were thrown open to our traders, at the conclusion of the Chinese war, in 1843. At the poultry show held at the Zoological Gardens in the May of 1845, there were prizes especially devoted to 'Malay and other Asiatic breeds;' but these brought to the exhibition no other Oriental variety than Malays, and, we may add, that at that time Shanghai fowls were unknown to the Society. In fact, we shall be near the truth if we assign 1845 as the year in which they were first imported. It was in that year that her Majesty received specimens of them, which she exhibited at the Show of the Royal Dublin Agricultural Society, in April, 1846. Even in 1847, Mr. Walter Dixon, in his volume on 'Poultry, their Breeding, etc.,' does not mention this variety. Mr. Moody, of Droxford, in Hampshire, obtained his first Shanghai fowls in 1847; and Mr. Sturgeon, of Grays, Essex, accidentally became possessed of his stock during the same year. From the above mentioned stocks, with admixtures from fresh importations, have been derived the yards of Shanghais now becoming so numerous.

"Mr. Sturgeon gives the following details: 'The history of my Cochins is a very absurd tale, and full of ill-luck, or perhaps carelessness—a term for which ill-luck is often substituted. I got them in 1847, from a ship in the West India Docks. A clerk we employed at that time happened to go on board, and, struck by the appearance of the birds, bought them on his own responsibility, and at what I, when I came to hear of it, denounced as a most extravagant price—some six or eight shillings each! Judge of my surprise, after my extravagance, when I found a younger brother had, immediately on their ar-

rival, killed two out of the five, leaving me one cockerel and two pullets; nor was my annoyance diminished on hearing him quickly remark that they were very young, fat, and heavy, and would never have got any better! The cock shortly after died, and, beyond inquiring for another, which I succeeded in obtaining shortly after the original died, together with a number of hens which reached this country under peculiar circumstances, I personally took but little interest in them till the eve before their departure for Birmingham in 1850. Neither my brother nor myself, before we obtained these birds, had taken any particular interest in poultry, and why we came to prefer the light-colored birds remains a mystery to me; but so it was, for to Mr. Punchard, and to all others, we parted with none but the smaller and darker-colored birds. I have often laughed at the dreadful passes my own famous breed has been reduced to, and the very narrow escapes it has had of utter extinction—first the attack of my brother already narrated; then the death of the cock; and in the third year, the desperate incursions of some mischievous greyhound puppies, who killed one morning five young birds just as they were getting feathered, besides many more on different occasions. Our birds all came from Shanghai, and were feather-legged. It is to the cock of the second lot that I attribute our great success. I have had fifty others since, in four or five lots, but not a bird worthy of comparison with my old ones, or that I would mix with them.'

"Having thus traced out the date of introduction and the place whence derived, let us next inquire something of the characteristics and treatment of the birds as they occur at Shanghai itself; and here Mr. Fortune again comes to our aid. In the letter already quoted he says, 'The Shanghai breed occurs both with feathered and unfeathered legs, but more frequently unfeathered. The most admired kind there are the game-colored ones. Many of them are much like the pheasant of the country; indeed, we used to think that crosses were often produced between the pheasant and the fowl, as the former were often seen feeding with the latter. However, I am safe in saying that the Chinese do not attach so much importance

as we do to purity of color; large size and large eggs are what they most admire and prize.

"The Chinese are not particularly careful in managing their poultry. They feed them in the same way as our cottagers do in the country; that is, the birds are allowed to get as much as they can for themselves, and I need scarcely tell you they are not very particular. When the Chinese housewife feeds them, she generally gives them *paddy*; that is, unhusked rice.'

"It being certain that the true Shanghai fowl is met with in its native district with plain legs, even more frequently than with legs feathered, or *booted*, as it is technically termed, the point often disputed is now settled, as to whether this is any demonstration of a distinct breed. Henceforth it must be held to be a mere matter of taste; and as we have seen plain-legged Shanghai fowls superior in every important character to those feathered on the legs, we think that it would be well to have distinct classes for them at our poultry shows.

"Mr. Fortune's testimony settles another disputed point. It is very evident that, except as a matter of taste, the light-colored should have no pre-eminence over the darker plumaged; and those societies have acted judiciously who have given separate prizes of extra value to all the sub-varieties of color."

*Characteristics.*—The pullets of all Asiatic fowls begin to lay at five months old. The eggs are small at first but they are numerous, where liberal feeding and good shelter are provided. The egg of the hen averages about  $2\frac{1}{4}$  ounces; it is rounded almost equally at each end, so that its shape may be strictly described *oval*—an expression, notwithstanding its derivation, that is by no means applicable to the eggs of some fowls. In color it varies from different shades of buff to a tint approaching cinnamon, and the shell is unusually strong. The attractive color probably induces the belief that the egg is peculiarly rich, but this argument on their behalf we must leave to individual taste; but much may probably depend on the quality of their food.

It is not uncommon for the Asiatic hen to lay eggs with double yolks; they are unproductive, and it is useless to attempt hatching them.

#### THE MALAY FOWL.

This is one of the giant tenants of our poultry-yard for which we are indebted to tropical latitudes, and which, though natives of such a constantly torrid climate, have the power of enduring, uninjured, temperatures so varying, so cold, and so trying as our own.

This is undoubtedly descended from the Kulm or Gigantic cock, which is a native of Java, Sumatra, and probably, all other parts of Southern Asia. Colonel Sykes found the Kulm fowl domesticated in the Deccan; but he believed it was there introduced from Sumatra by the Mussulmans. He imported two cocks and a hen into England in June, 1831. They bore the winter uninjured; the hen laid freely, and by September, 1832, she had reared two broods. One of these cocks measured, when standing erect, 26 inches to the crown of his head. In comb, colors, and other points, they resemble the Malay; the hen was one-third smaller than the cocks.

It is still found in the islands named. Travelers inform us that it is kept in a domestic state not only in India, but in the Malay peninsula, in Cochin-China, and China, from whence they are now occasionally imported. It has long been known in Europe and America. It is unquestionably the parent stock of the kinds now known under the names of India, Java, St. Jago, Chittagong, Cochin, Shanghai, and Brahma, and in some parts of America as the Bucks County and Ostrich fowl.

Previous to the introduction of the more quiet Chochin and Shanghai, whoever required size resorted almost of necessity to the Malay blood, and a cross of it probably prevails in all the larger breeds. The trifling differences which appear in the kinds mentioned, Martin attributes to the influence of domestication and accidental crosses.

But a few years ago, the Malay formed a feature in most collections of any extent; and it is hoped they will not be lost sight of in the prevailing taste for Shanghais, Chochins, and Brahmans, as they are beyond doubt, taking size, appearance, carriage, and all into consideration, the most *majestic* fowl we have.



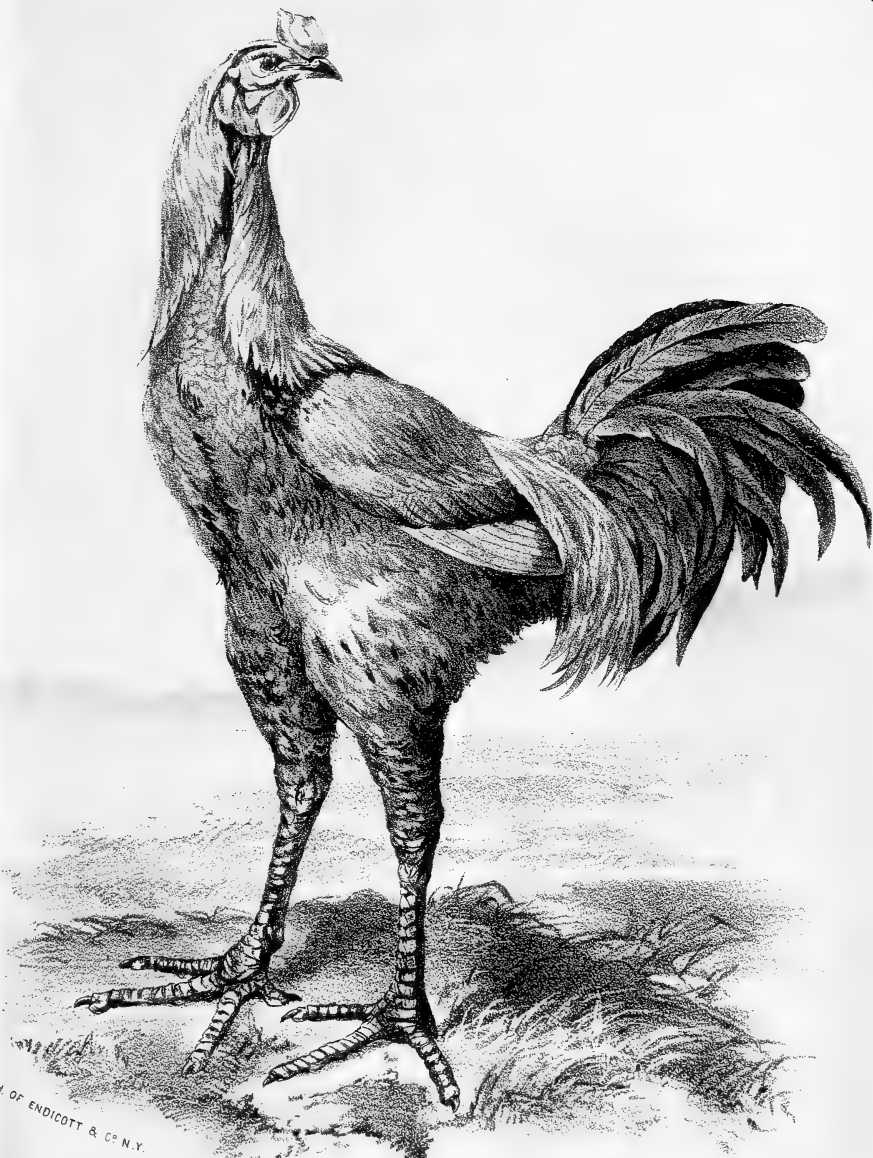

LITH. OF ENDICOTT & CO. N.Y.

BIRMINGHAM PRIZE MALAY COCK.

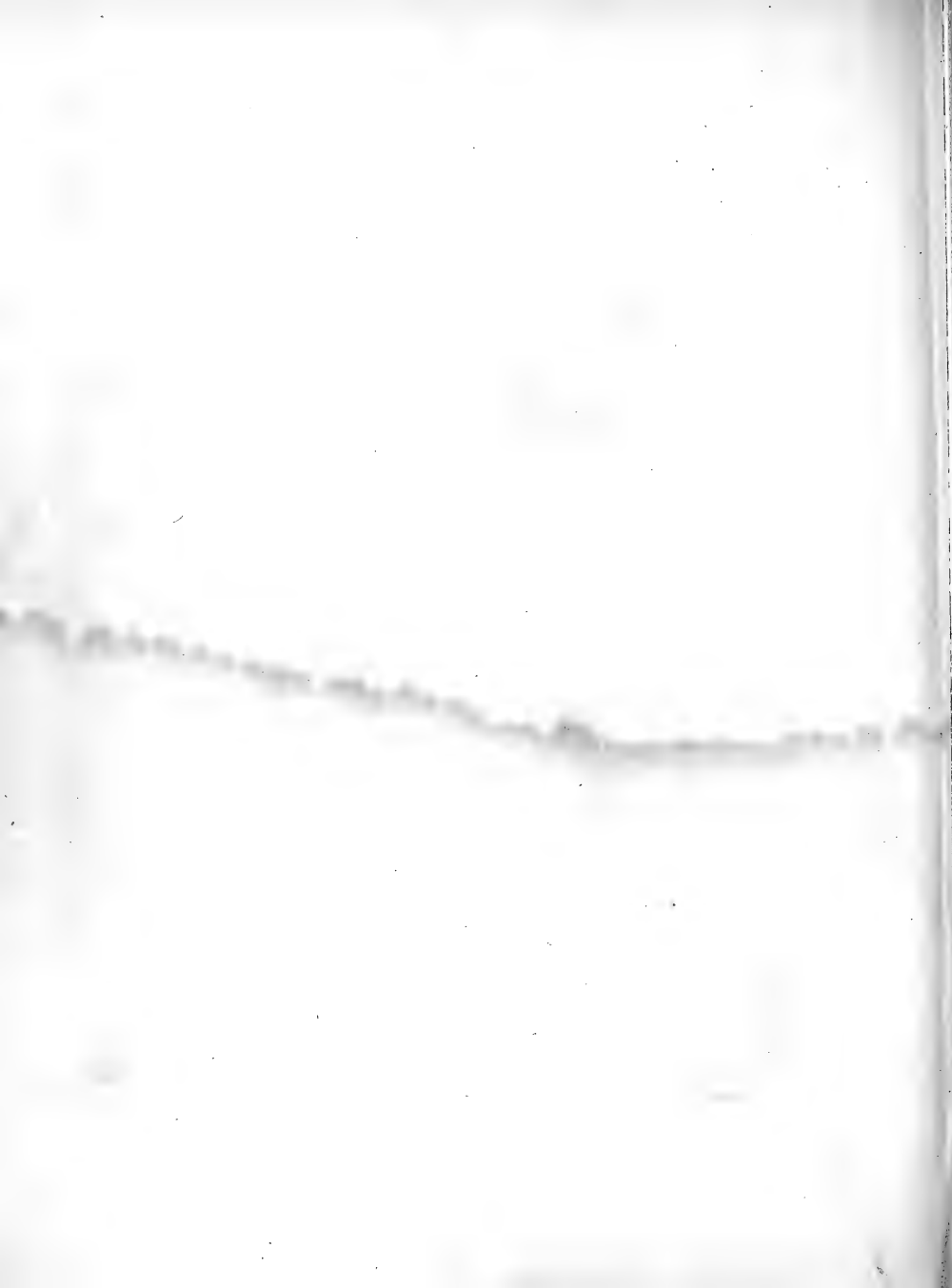

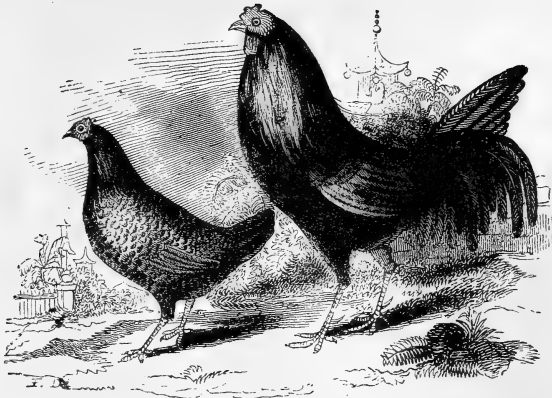

THE MALAY FOWL.

Martin gives the following description of the Malay fowl: "The male in his natural attitude often considerably exceeds two feet in height, from the ground to the crown of his head. The comb extends backward in a line with the eyes; it is low, thick, destitute of serrations, and has the appearance as if its ridge had been cut off. The wattles hanging from the under mandible are small, and the throat is bare. The neck is long and covered with hackles of pale golden-reddish color, which extends to the upper part of the back. The middle of the back, and the lesser wing coverts are of a deep chestnut, and the webs of the feathers disunited; the greater wing coverts are glossy green; the secondaries and quill feathers are of a pale reddish-yellow on their outer webs. The hackles of the rump are long and drooping, and are of a pale reddish-yellow. The tail feathers are of a glossy green. The under parts are generally of a glossy greenish-black, with high reflections, each feather being of a deep chestnut at the base, producing somewhat of a mottled appearance, especially if the plumage be a little deranged. The body is stout and the legs are long, but very robust. In proportion to the size of the body, and length of the neck and limbs, the head seems small, and is far from being

pleasing in appearance, the curtailment of the comb and wattles seeming of the result of injury or malformation. The gait is heavy and destitute of alertness, and the bird, as we have frequently seen, often reposes resting on the tarsi or shanks, their whole length being applied to the ground. The attitude is uncouth, and gives the idea of the bird being oppressed with its own weight. It is very probable that this gigantic fowl is less disposed to mount the trees and roost on the branches than most others of the genus; and this strange attitude may be the ordinary mode of taking rest. The crow of the cock, instead of being a clear ringing tone, heartily delivered as if in defiance of every rival, like the blast of the knight's clarion on the listed field, is short, hoarse, and monotonous, more like a croak than a crow."

We agree with the author just quoted, that the stock represented by the figure of the prize Malay cock on the opposite page, shows the greatest purity, and indicates the least departure from the original. The breed in its pure state is generally not handsome, either in form or plumage, and its flesh is coarse and wanting in flavor.

The usual height of the Malay cock is from 26 to 28 inches, and it weighs about ten pounds.

The weight of the prize cock, figured, was  $11\frac{3}{4}$  pounds. A cock raised in Dublin, is stated to have weighed alive, without being fattened, 13 pounds.

The disposition of both cocks and hens is stated, by some writers, to be very pugnacious; and some have ceased keeping them, because, among other causes, they found the cock excessively quarrelsome, and cruelly disposed toward his chicks. Other writers represent him as professing but little spirit and courage; yet a variety of the race is *game*.

Dickson thinks it very probable that the Dorking originated by a cross between the Malay and game fowl. A writer in the "Scottish Quarterly Journal of Agriculture," is of the same opinion.

A breed was established in England about seventy years ago by the Duke of Leeds, called the "Shake-bag" breed, which obtained great celebrity for the strength and prowess of the cocks. Martin observes that this breed was probably formed by a cross with the game-cock; the male frequently weighing over ten pounds, and to his great strength is added spirit and determination. This breed is now thought to be extinct. It was sometimes called by authors "Shack-back," or "Shag-bag" breed; but Martin says that it was formerly the practice in cock-fighting to challenge all comers with the cock *concealed in a bag*—the tremendous power of the Duke of Leeds fowl proved so superior to those of all competitors, usually securing conquest, it eventually attained the name, *par excellence*, of "Shake-bag," which was corrupted to the other terms.

*Varieties and Crosses.*—The varieties differ chiefly in the color of their plumage, with some deviation in height. The most worthy of notice is the white Malay. The plumage, both in cock and hen, is purely white, but the neck-hackle and saddle-feathers are tinged with yellow. They are smaller than the brown variety.

There is a light brown variety, in which the cock is light chestnut, spangled with black and dark chestnut; the neck-hackle, rump, and saddle-feathers are of a light reddish-brown; the tail feathers not finely tapering as in the dark variety, but broad and very long. The hen's

plumage inclines to uniform buff, but rather darker on the back.

Of the cross breeds there is the pheasant Malay, which is supposed to be a cross with the Malay and Golden Hamburg, or some other of the small varieties of domestic fowl. The cock resembles closely the pure Malay in its head, but the neck-hackle is black with green metallic lustre; breast and rump black; tail not strongly sickled, and legs white. The hen has bluish ear-lobes; neck-hackles black with metallic lustre; rump feathers partridge colored, spangled with dark brown, and the shaft of each feather yellowish; legs white; tail dark brown, and held upright; breast light brown, spangled with black or very dark brown.

The marking in the breast of the hen, from somewhat resembling those on the plumage of the cock pheasant, occasioned the suggestion that they are a cross between this bird and the Malay hen. It is, however, an error, and the best mode of defacing the mistake would be to change the name to Spangled Malay.

The Chittagong fowl is strongly suspected to be a cross between the Malay and the Dorking. They are usually penciled or spangled gray in plumage; but they have occasionally been seen with a mixture of yellow or brown upon the feathers; they have the Malay head and "expression of countenance," but with more of the ample breast of the Dorking; and their legs are somewhat white but not rarely yellow. A mistake is sometimes made by the owners of light-brown Malays, who from the spangled breast of the cock have thought them not pure Malays, and have thence been induced to call them Chittagongs.

*Character as Layers.*—The hen lays a moderate-sized egg, averaging about  $2\frac{1}{2}$  ounces in weight. The shells usually are slightly colored—a pale chocolate. The size and color, however, vary, pullets of last year laying eggs equal in size to those of any description of duck; and hens two or three years old laying an egg very little larger than a good-sized bantam's egg. Another writer observes, "The eggs are of good size, and of a rich buff or brown color, and are much prized by the numerous epicures who believe that this hue indicates richness of flavor—a fact

which has not yet been made sensible to my own palate."

They are not remarkable as prolific layers, but still, if well fed, they certainly are of an average merit in this respect. They seldom lay more than twelve or fourteen at a litter. Upon an average there will be fewer unproductive eggs among a given number than among the same number laid by any other hen under the same treatment. The outer shell is oftentimes very thin, and the under skin so tough and unyielding, as in numerous instances to strangle the chick in its birth. Dr. Kittridge says they are good layers, eggs very large, and hatch well.

The Malay hen sits closely and well, failures in the number of her brood rarely arising from any defect on her part. She is exceedingly attentive to her chickens; but it is necessary to watch her for the first few days after hatching, lest her great weight and long legs might crush any of her progeny while small and weakly. Such accidents, however, may be generally prevented by giving her an abundance of room.

Like those of the Shanghais, the chickens feather slowly, on which account no brood should be hatched after June; otherwise the cold and variable weather of autumn comes upon them before they are half grown, and the increase of their bodies has so far outstripped that of their feathers, that they are half naked about the neck and shoulders, which renders them extremely susceptible of wet and cold. The chickens are not difficult to rear, but are gawky, long-legged creatures until they have attained their full growth, and then fill out or "square up."

#### THE COCHIN FOWL.

Until recently very little, if any thing, was known of the Cochin breed of fowl. No mention is made of them in any of our early publications on poultry. The first notice of them we find in the *London Illustrated News* of 1844. The writer says: "Her Majesty's collection of fowl is very considerable, occupying half a dozen very extensive yards, several small fields, and numerous feeding-houses, laying-houses, winter coverts, etc. It is, however, in the new fowl-house that the more rare and curious birds are kept, and to these we shall confine our attention.

The Cochin fowls claim the first consideration. These extraordinary birds are of a gigantic size, and in their proportions very nearly allied to the family of bustards, to which in all probability they are proximately related—in fact, they have already acquired the name of 'Ostrich fowl.' In general color they are of a rich glossy brown; tail black, and without side feathers; in the breast a horse-shoe marking black; the comb double. Two characters appear to be peculiar to them—one, the arrangement of the feathers on the back of the cock's neck, which are turned upward; and the other, the form of the wing, which is jointed to fold together, so that on occasion the bird may double up its posterior half and bring it forward between the anterior half and body. The eggs are of a deep mahogany color, and of a delicious flavor. These birds are very healthy, quiet, attached to home, and in every respect suited to the English climate. In order to promote their propagation her Majesty made presents of them occasionally to such persons as she supposed likely to appreciate them."

Their origin was traced to a country situated in the southern part of China, to a country the name of which they bear. Though they evidently belonged to the genus *Gallus*, it was even doubted whether they were really *fowls*. Their supposed specific affinities with the Fire-backed pheasant were even sincerely discussed.

Of this much lauded fowl Mr. Dixon says: "Whether the breed now under consideration did really come from Cochin or not, is probably known only to the party who imported them, if to him. But they certainly have been cultivated in this country previously to their recent introduction to general notice as the most conspicuous ornaments of the Royal poultry-yard. A gentleman living in Monmouthshire, informs me that, nearly thirty years ago, a friend sent him a cock and hen of the true 'Java breed.' The cock was so fine, large, and handsome, that he was immediately made 'Cock of the Walk.' The present stock on the farm, which I have seen, are entirely descendants, and are true Cochin fowl; so that, in this case, Java and Cochin, are synonymous. The first parents of this lot came direct from India. But from

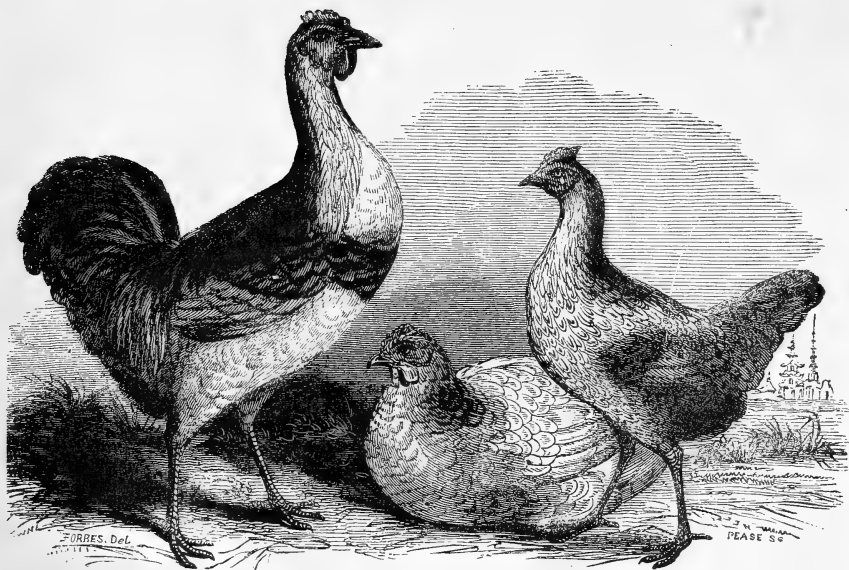

QUEEN VICTORIA'S COCHINS.

whatever Oriental region derived, it is a most valuable variety, and the only fear is that statements of its merits have been set forth so highly exaggerated, that they must lead to disappointment, and cause the breed to be as much undervalued as it has been before foolishly exalted.

"They differ very little in their qualities, habits, and general appearance, from our (later introduced) Shanghais, to which they are undoubtedly nearly related. The egg is nearly the same size, shape, and color; both have an equal development of comb and wattles, the Cochin slightly differing from the Shanghais chiefly in being somewhat deeper and fuller in the breast, not quite so deep in the quarter, and being usually smooth-legged, while the Shanghais generally are more or less heavily feathered. The plumage is much the same in both cases. The cock's comb is usually single, erect, serrated, and of a brilliant scarlet, but not always single; the wattles are large; the hackles

on the neck and hips yellowish-brown; the tail black, with metallic lustre, and when fully furnished presents the usual cock's plume; the legs vary from a flesh-color to an orange-yellow, and are not so long as in the Malay; the eggs are buff-colored, of large size, and blunt at both ends; the chickens progress rapidly in size, but feather slowly."

Another writer describes the Cochin cock as having a large, upright, single, deeply indented comb, very much resembling that of the black Spanish, and when in high condition, of quite as brilliant a scarlet; like him also, he has a very large ear-lobe or ear-cheek. This is not an indispensable, if even a required qualification; it is, however, to be preferred, for beauty at least, if not as a mark of pure breed. The wattles are large, wide, and pendent. The legs are of a flesh-color; some specimens have them yellow, which is objectionable. The feathers on the breast and sides are of a light chestnut-brown, large and well defined, giving a scaly oi

imbricated appearance to those parts. The hackle of the neck is of a bright yellowish-brown; the lower feathers being tipped with dark brown, so as to give a spotted appearance to the neck. The tail feathers are black, and darkly iridescent; back, scarlet orange; back hackle, yellow orange. It is, in short, altogether a flame-colored bird. Both sexes are larger in the leg, in proportion, than the Spanish or Malay.

#### YELLOW OR BUFF COCHINS.

Mr. G. P. Burnham, of Boston, communicates the following in reference to two importations of Cochin fowl by him in 1850. He says, "I obtained two lots of these fowls—one batch of six, from J. J. Nolan, of Dublin, and the other direct from Canton. The prevailing color of my birds is yellow, or yellowish-brown pullets, and yellow and red, or yellow, red and brown cocks. They have not deviated from this range of color except in two or three broods out of the dark Canton cock. The chicks come even in size and plumage; and down to the third generation they have bred exactly the same; this is a very satisfactory result, in my estimation. I have never yet seen a black, a gray, a white, or a speckled chick from this stock.

"For all purposes of a *really good* domestic fowl, whether I speak of productiveness, easy keeping, laying qualities, size, disposition, beauty of form and plumage, or hardness (in this climate), after a careful comparative trial, I deem the Cochin *the best*. And to my fancy they have no equals among the varieties now known in America."

The merits of the Cochin are such that it may safely be recommended to persons residing in the country. For the inhabitants of cities it is less desirable, as the light tone of its plumage would show every mark of dirt or defilement, and also the readiness with which they sit would be an inconvenience, rather than not, in families with whom everlasting layers are most in requisition.

There is considerable difference in the fowls called Cochin, some of which are loose-jointed, crane-like concerns, with legs long enough to *step* over a pretty high fence; these are a disgrace to the tribe. Many persons owning fowls

of this description have, after a short trial, discarded them, and justly conclude that there is a great deal of "gammon" in the "hue and cry" about fancy poultry.

Cochin fowl have for a few years been slowly recovering from the undeserved neglect into which they were cast, when it was found they were something less than a good horse or Durham cow. They were unfairly treated; they were made things of speculation rather than utility: an ideal standard was set up; real solid advantages were set at naught for imaginary wants; they were unnaturally forced and fed till they were useless, save for exhibition, and incapable of laying. Lately, however, they have been improving in quality and form.

The hen approaches in her form more nearly to the Dorking than any other, except that the tail is very small and proportionably depressed; it is smaller and more horizontal, I think, than any other fowl. Her comb is moderate-sized, almost small; she has also a small white ear-lobe. Her coloring is flat, being a compound of various shades of very light brown, with light yellow on the neck. Her appearance is quiet, and only attracts attention by its extreme neatness, cleanliness, and compactness.

The eggs are smooth, of an oval shape, nearly equally rounded at each end, of a rich buff color, and average about two ounces each. The newly-hatched chickens appear very large in proportion to the size of the eggs. They have light flesh-colored bills, feet, and legs, and are thickly covered with down of a caroty-brown. They are not less thrifty than other chickens, and feather somewhat more uniformly than either the Malay or black Spanish. A peculiarity in the cockerels is, that they do not show even the rudiments of their tail feathers till they are nearly full grown. They increase so rapidly in other directions, that there is no material to spare for the production of the decorative appendages. The pullets are less backward in shooting their tails; and the distinction alone is sufficient to denote the respective sexes at a very early age. The young cocks are later than others in coming to crow.

Reverting to the habits and dispositions of these birds, we can not describe them by two

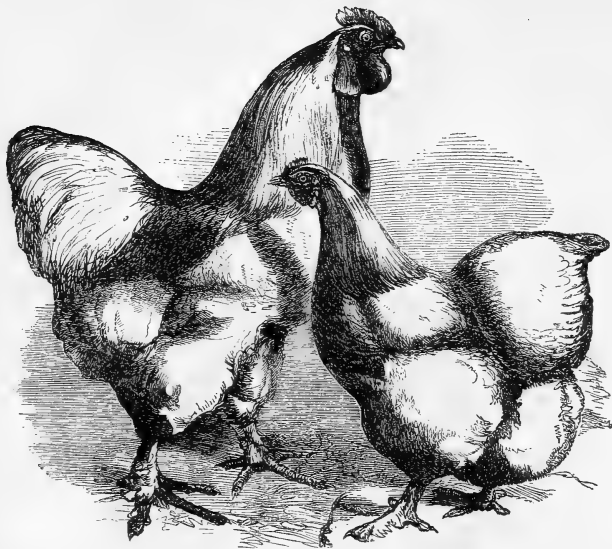

YELLOW OR BUFF COCHINS.

epithets more appropriate than that they are the most domestic and amiable of all the varieties of poultry. They are exceeded by none in their attachment to their own house and yard, from which they never wander far even when their liberty is unrestricted; and in gentleness they are unequalled. Both sexes will soon have sufficient confidence to feed out of the hand of any one with whom they are acquainted; and the hens will allow their chickens to be taken from beneath them with little resistance beyond a remonstrant cluck. No birds are more confiding under kind treatment, yet no others seem so willing to set about making themselves comfortable even under adverse circumstances. In a confined space all other varieties show their sense of restraint by irritated movements and sedulous research for an outlet; while the Cochins will quietly repair to some corner, and either by their repose or peering occupation give evidence that they purpose to make all things as pleasant as possible. Yet let no one suppose

that they are without becoming high spirit. In defense of their young, in buffeting intruding poultry, in firmness of purpose when desirous of sitting, no hens can be more exemplary. No cocks come forward more gallantly to repel the trespassing Lothario; and none are more generous in giving precedence to the ladies at feeding times than these natives of the Celestial Empire.

#### THE SHANGHAI FOWL.

The Shanghai fowl in its varieties is highly esteemed by many, and considered the best of the Asiatic breed. The first imported into this country was in 1847.

In enumerating the most important points of beauty and excellence in the Shanghai fowl, we will begin with the hen.

The hen should have a slightly curved beak; the forehead well arched; comb low, single, erect, and slightly and evenly toothed; wattles small and curved inward; eyes bright and prominent,



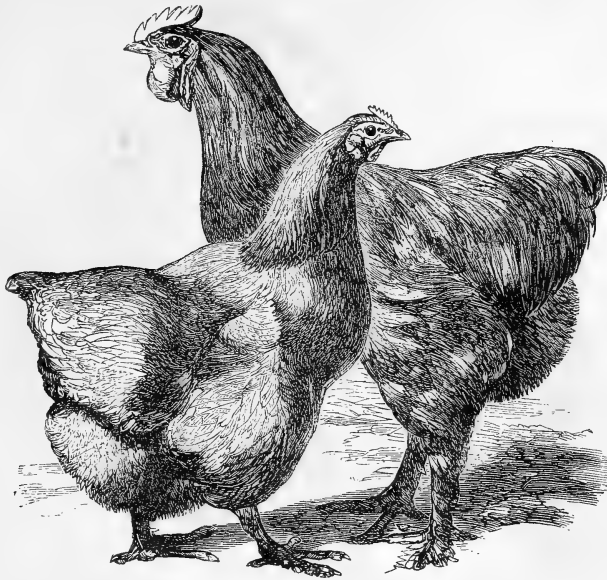

SHANGHAI FOWL.

with an expression tempering the whole of motherly patience and contentment. The neck about eight inches long, and should be gently arched when held upright, and the head held at right angles with it. The body, from the neck to the origin of the tail feathers, should be long and greatly arched; and the girth of the body, measuring over the wings and before the legs, should be, in the best specimens, about twenty inches. Wings well rounded outward, so as to increase the apparent diameter of the body; their shoulder well nestled in beneath the breast feathers, and the quill feathers short, buried under the mass of feathers which encompass the base of the tail. This mass of feathers is very peculiar, arching from the back to the tail, and sloping off so as to form a slight elevation round the sides, as it does round the base of the tail. The leg is rather long; color pale yellow with a tinge of flesh-color, and generally thickly feathered quite down to the toe on the outer side. The

plumage is remarkably soft and silky, or rather downy, termed by some as fluffy, and beneath the tail densely fluffy and rounded. We have chosen the hen as being most uniform in her make and coloring. The eggs are generally of a pale yellow or cinnamon color, not remarkably large compared with the size of the fowl, and generally blunt or rounded at both ends. The fertile qualities of this breed are considered equal to any other of the large breeds. The flesh of the Shanghai is rather inferior to the smaller breeds, being coarse-grained, neither tender nor juicy, and have more offal and less breast-meat than either the Cochins or Brahmas. Their habits are quiet and they are not inclined to ramble, on which account they bear confinement better than any other breed.

The gait of both the cock and hen, when walking slowly, is peculiarly precise and dignified and graceful, but when hurrying, it is a heavy rolling waddle.

## BLACK SHANGHAI—SUB-VARIETIES.

The sub-varieties of the Shanghai fowl are known as the buffs, yellow, cinnamon, white, gray, black, and partridge-colored.

The authors of the "London Poultry Book" say "the whole class of Shanghai fowls, taken collectively, constitute, properly speaking, but a variety of the species. We may here, however, probably be excused if, adopting its more popular meaning, we use the word 'sub-variety' to describe those more minute divisions into which every sort of poultry becomes in process of time separated.

"It is proposed to devote a few pages to a description of the several breeds or sub-varieties; to point out the comparative merits; and to give the best description in our power of each; the object being to enable the intending fancier to make his choice with facility, to assist his immature judgment in the selection, and, perhaps, to suggest to his more experienced brother-amateur the means of improving his stock by a judicious intermixture of blood, instead of contenting himself with breeding on with his old strain, or, being aware of the benefit of a cross, contenting himself with the first which may offer itself. Adhering to this outline, we will suppose we are passing with the reader through a show of Shanghais, and discussing the merits and demerits, comparatively, of the several sub-varieties, as they are usually classed by their colors; and that we may not appear to give undue precedence to any, let us take them in the order of their several shades.

"The White, which are not yet very widely diffused, have sold for great prices, probably on account of their comparative scarcity. The greater part of them are traceable to the breed of the Dean of Worcester and Mr. Herbert of Powick; although other imported specimens, of which the writer himself possesses one, have been introduced. In country districts, where they have a nice lawn or clean fields to run, they are very beautiful birds; but in the neighborhood of a town, we need not say they do not shine. Like all other white varieties of fowls, we do not consider them quite so hardy, or as easily reared, as those of a darker hue; nor do

they usually attain the weight of some of the other varieties. There are, however, many exceptions to this. Mr. Bowman has kept this sub-variety in considerable numbers, and does not consider them more difficult to hatch or to rear than those of darker colors. We must remember, however, that Mr. Bowman lives in one of the mildest districts of England. We believe them to be equally prolific, and their appearance will, no doubt, render them favorites with the ladies.

## "GRAY SHANGHAI.

"There is a Gray sub-variety—or rather white—with penciled hackles and flake tail, which afford a pleasing contrast, and are altogether exceedingly pleasing to the eye, when kept clean, and which (especially the cocks) attain a good weight. Of these we have seen but few specimens, and we have reason to believe that they are also yet scarce. We have also seen some mottled most uniformly all over with white and gray, so as to entitle them to be distinguished as the *Cuckoo* Shanghais. They were, however, of weedy growth, long-legged, and not of attractive appearance, even if certainly not of mongrel origin.

"The next color comprises the different shades of *buff* and *yellow*, and this is the favorite class, partly because it is exceedingly neat and pretty in its appearance, and partly because it has been ever sedulously cultivated, but most of all on account of its including, beyond doubt, a larger number of birds of first-rate quality, in other respects, than any other sub-variety. For these reasons we may be allowed to devote to its description a little more space than we may be able to spare for each of the other colors.

## "BUFF SHANGHAI.

"Of the Buffs, the cocks vary from a dark ginger or red, to a light or yellow buff. The former have the neck, hackle, and saddle of a bright orange-red; the saddle-hackle feathers are orange-crimson, and the rest of the body a dark buff or bay, without any black, except the tail and perhaps some of the quill feathers of the wing. The *yellow Buff* is more of a lemon color, but without white feathers, which give a





LITH. BY ENDICOTT & CO. N. Y.

LEMON SHANGHAE HEN AND COCK.

nealy appearance by no means pleasing. The hackles are of a bright golden yellow; the saddle and outside of the wings a shade darker, but still yellow; and the rest of the body a beautiful uniform light buff, except the tail, which is black. Black markings in the hackles are by some judges thought to be equally objectionable in each. The buff hens vary from a dark fawn to a light color, almost a canary color; and the nearer they approach the latter shade the more they are esteemed. The color should be as uniform as possible; but we do not object to a slight necklace or dark marking in the neck hackle, and the tail is usually black. We may hint to breeders that it is from the yellow cocks, rather than from the reds, that they may expect to breed of the light or canary shades.

#### “CINNAMON SHANGHAI.

“The Cinnamons, ranging from a sort of very pale reddish-brown to a dark chocolate, form the next class of shade. The cocks of this variety are usually by no means so handsome in their plumage as the Buffs; the greater portion of the feathers of their wing-coverts being of a plum color—light or darker, as may be—and the hackles of a duller yellow; but we have seen some most beautiful birds, varying from a Vandyke-brown to orange-madder. The hens are much prettier, some of those of a uniform light cinnamon hue being as neat in their appearance, and matching as well, as the Buffs. They are, however, for the most part wanting in that fineness and gloss of feather, known to amateurs as ‘quality,’ which usually distinguishes the Buffs from all their competitors.

#### “PARTRIDGE-COLORED SHANGHAI.

“Some of the partridge and grouse colored sub-varieties, which follow next in order, and with which Mr. Punchard has carried off, and deservedly, many prizes, are extremely pretty, and match well in shade and general appearance. The cocks are what are called black-reds—that is, they have a black body with red or yellow hackles (each hackle-feather being marked with black down its centre), and crimson back and wing-coverts. The hens are beautifully and very uniformly penciled, and ap-

proach, we think, when well bred, nearest in ‘quality’ of feathering to the Buffs.

#### “BLACK SHANGHAIS.

“Besides these, are the Blacks, of which so few have been exhibited that we believe them to be as yet scarce. Several have been imported; but we have reason to suppose that a large majority of those now in England have been bred between the White and Buff varieties. Some of the best that we have seen have their sires of the former color, while their mother was a buff bird. From thirteen eggs ten dusky chickens were produced, which in due time severally assumed the following garb: Two pullets were wholly black; two pullets and three cockerels with more or less golden hackle, and markings on the wings; while the remaining three were very darkly penciled birds altogether dissimilar to any Shanghai that we had previously seen. The hatching of subsequent nests of eggs gave a very similar proportion of colors.

“A curious variety of the Shanghai race is occasionally met with, of which the plumage resembles that of the Silk fowl in texture, while the colors are buff and fawn. It is usually of smaller size, and from this singularity has obtained the name of the ‘Emeu fowl,’ from its similarity to the ‘wooly’ coat of that Australian bird. We are not aware of its possessing any points of merit or excellence beyond its relatives, and we therefore leave it, with the mere mention of the strange garb that has obtained for it its present name.

“*Model Shanghai.*—A Shanghai to please us must have a stout curved and yellow beak, with plenty of substance at the base, and the shorter the better. The outline of the head should seem to be round in the hens when looked at from the side, and when the eye catches the comb and wattles; and we like just so much comb of a fine quality as will stand up and give that appearance of roundness. In the cock the comb will be larger; but the most careless observer will easily note the great difference of quality—some races showing a close and smooth texture delicate as a lady’s hand, and others a roughness which might more properly be compared to the

1. The first part of the report is a general introduction to the subject of the study.

2. The second part of the report is a detailed description of the methods used in the study.

3. The third part of the report is a discussion of the results of the study.

4. The fourth part of the report is a conclusion and a list of references.

requisite time, as is the case in his native land, and you see perfection; his mammoth form and lengthy proportions are filled in with flesh and fat—a wonder and a pleasure to look at.

“However, utility should precede beauty, and in the estimation of many ‘handsome is that handsome does,’ and here the Shanghai fowl will not be wanting. As has before been said, they are *excellent* layers, and arrive at maturity earlier than any other large-sized fowl, the Cochins excepted. By the term ‘maturity’ is meant the age at which a bird will commence laying eggs, and thus perpetuate its race. They will also prove harder than most other fowls—except the game breed. They will also improve the general race of farm-yard poultry by judicious crossing. The pullet from the cross between a Shanghai hen and Dorking cock, possesses, in an eminent degree, the special qualities of both. It grows up rapidly and to a large size. The yellow legs of the Shanghai are often displaced by the white foot of the Dorking, and moreover, the flesh is almost as juicy and as good as the last-named bird; while when alive, it produces more eggs than the Dorking, of equal size, and of a richer color.”

The introduction of the Shanghai fowls is a national benefit, for the farmer who keeps Shanghai hens and Dorking cocks will always be sure to have good-sized fowls, and a good supply of eggs, at a time when most needed for the market. But let him beware of breeding from this cross; for as sure as the young mongrels would chirp, so sure would they reverse the excellent properties of their parents.

Now let us hear the other side. A writer in the *American Agriculturalist* says: “I next tried the Shanghai, and of all the breeds of fowls I ever saw tried, I think them the most abominable, unprofitable, and unsightly brutes ever introduced into the poultry-yard. They are gross feeders, making for the same food, and in the same space of time, less than any breed with which I am acquainted. The chickens are never chickens, in an epicurean sense of the word; not filling out the first year, but the growth being expended in the bone and stature; and when fatted, if, indeed, they do ever get fat, I have found the meat coarse and dry. I have

not found their laying qualities so vastly superior to other breeds.

“We are averse to all large overgrown animals. We never knew a big hog, or ox, but had cost more than he come to, in making him grow up to his size. So with big fowls; and in reply to a Shanghai friend afflicted with declining *purse*, we have given it as our opinion that two, like the Game and Dorking, will sustain and keep in a better condition more flesh and feather, on the same food, than one, on a pair of gouty stilts under a modern Chinaman. And, too, careful comparison, deduced from the realities of cause and effect, teaches us that, as scratching is one of the elements of good living to a cock, the smaller breeds, in this particular, have greatly the advantage over the automaton monsters of the poultry-yard. With bountiful crops and good seasons they may do; but give us a Dorking or Game for the spit—a Bantam to crow—a Guinea-fowl for eggs, and we will give up all the giant fowl fancies to those who choose to indulge in them.”

It was the Shanghai which created the “Fowl Fever” a few years since, and it was on the Shanghai that the bubble burst. They are no longer the aristocracy of the fowl-yard; their day has passed, their race is run.

#### BRAHMA FOWLS.

To the banks of the Brahmaputra—a river that waters the territory of Assam—are we indebted for the fowls bearing that name, lately introduced into this country.

The first appearance of the Brahma fowls was in the city of New York, in the possession of a sailor, who sold them to a mechanic of that city, who again sold them or their progeny.

The editor of the *Northern Farmer* says, “The origin of the Brahma fowls can never be traced farther than has already been developed, true or fabulous, and at this day it is quite useless to attempt to arrive at any new facts pertaining thereto. We profess to know about as much in regard to their origin as any one, having heard the views and statements of all parties from the beginning to the present day. We, therefore, are prepared to make the following state-

ments, and we challenge any man to prove us in error.

"*First.* That no Brahma fowls have ever been imported into the United States or any other country from China or Asia, since the alleged importation of three pairs to the city of New York in 1850, from *one* of which it is alleged all the Brahma fowls have originated, now in this country or England.

"*Second.* That no such fowls are known to exist in China and Asia at the present time.

"When we say Brahma fowls, we do not mean *gray Shanghais*, as it is quite probable that certain 'gray fowls' have been imported from China, and we refer to fowls with cream-colored white bodies, dark wing, and tail tips—and neck hackle with the same hue.

"It is of no consequence now how they *originated*, as a knowledge of that matter can not change them in the least; but it is certain that a *pure* Brahma fowl was never seen in England till sent there from the United States."

An English writer says, "So much has been said about the Brahma fowls, and such a variety of opinions given as to whether they are a distinct breed or not, that I will venture to say a little respecting them. That they are a distinct breed there is not the least doubt, for long before they were imported into this country, a brother of mine, who has been much in India, informed me of them, and pointed out most particularly the advantages they possessed over the Cochins. I have now several of these birds in my possession, both of the dark and light variety. Some months since my brother visited me, and on being shown the birds, at once pronounced them to be the same as those he had seen in India; and he farther states that there are two distinct varieties as to color and shape—the one being dark and straight in form, with few feathers on the legs; the other, with white body, black tail and wing feathers, the neck delicately penciled, bright yellow legs, generally heavily feathered; the neck, tail, and back forming a half circle. The comb in each variety should be straight and single.

"I have seen nearly all the birds which have been imported from America, and many of those from India; and I must say that many of the

finest specimens at present in this country are sent to her Majesty. There is but little doubt that when the Brahmans become more generally known, they will stand number one. Their appearance is most pleasing, their flesh white and delicate. They are superior to most birds in size, and their eggs second to none for size and flavor; and the hens are not so prone to sit as the Cochins."

There has been an evident desire on the part of Shanghai and Cochin breeders to put a stop to the rapid advance to favor made by the Brahmans; but it is useless, for they have every thing to recommend them. Only "give them a fair field and no favor," and they will soon place in the shade their buff opponents, the Shanghais.

An American writer says, "We know, or we believe, they are from India, and came from the neighborhood of the river after which they are named. What hindered our countrymen from importing them, as they have the credit of go-aheadiveness? and if they imported them, why are those they have sent to England of necessity spurious? Did not the first ever received in England go from America? And may not the first possessors know something about them?"

The multitude of counselors has not yet brought wisdom, nor have they succeeded in agreeing among themselves as to the chief points, or the origin of their birds.

Mr. Burnham says they are Shanghais. Dr. Bennett contends they came from India. Why should they not? During the *mania* many of these birds were imported from China. How was it that among them there were no Brahmans, and then why should it be so strongly asserted they are only Shanghais? It would seem that the hold of these latter birds on their admirers is so strong, that rather than admit a new actor on the scene, they will vow he is the same in a new costume. Shanghais will ever be memorable in the history of poultry as the birds that were the general favorites when a love for the feathered tribe sprung up. They will also bear the palm of having made larger prices, and maintained them longer than any other will ever probably do.



Let their lovers and admirers be content with this, and with the good qualities which, by universal consent, are awarded them. It is useless for them to ask more, as the public has already decided the value of them, and they have passed from ridiculous to rational prices. They have also suffered the fate of all favorites and fashions; they have had their day. Let, then, the Brahmas have their turn, and reign if they deserve it; they will never attain the height of their predecessors, nor will any other; but do not seek to take from them "their local habitation and their name."

An English writer is wonderfully mistaken when he says "the American (Brahma) birds are crossed with the Malay." No mixture is so easy to detect as this; there is a character in Malay fowls which belong to no other, and the slightest of it is immediately visible to a practiced eye. The feather, the carriage, tail, and head of Malays are different from any others, and so different, that the veriest tyro will recognize them when grafted on any other stock.

If they were Cochins, they would not have the pea-combs nor the deep breasts. If they were crossed with the Malay, they would have drooping tails, small bodies, hard plumage, and cruel faces. If they were crossed with Dorkings they would have ample tails, five claws, and clean legs. These are the accusations, and the birds in question have no points to bear them out.

What are they then? They are Brahmas, large heavy birds, symmetrical, prolific, and hardy; living where Shanghais would starve; growing in frost and snow, when hatched in winter months; and without seeking to christen a mania, they are standing on their own merits, with the conviction they will deserve well of the public.

In speaking of various breeds of fowls Mr. G. B. Smith says, "As regards the Brahmas and gray Shanghai fowls, I think there is a great difference between the two; I have raised them both for several years, and greatly prefer the Brahmas. They lay a third larger egg than the Shanghai, and are the best fowl for any one desiring eggs in the winter. Their eggs sometimes weigh from 3 to  $4\frac{1}{4}$  ounces each, whereas those of the Shanghai seldom reach over 2 or  $2\frac{1}{2}$

ounces. The Brahmas, I think, will lay a greater weight of eggs in a year than any fowls I am acquainted with; I have bred fowls for over twenty years, and there are none I like better than these. They have improved in size since I first obtained them; this I think is owing to my changing the cock every year, which I am very particular to do."

Hide your diminished heads, poor Cochins and Shanghais! No longer will you walk at your ease in leisurely possession, but waddle away and hide in obscurity; no longer will you claim the distinction of "cock of the walk;" for you have formidable rivals now, and any one may see that,

"As eager runs the market crowd,  
When 'stop the thief' resounds abroad,"

so will the taste of the fancy go after the Brahmas; those large, showy, beautiful birds, which every one seems to take on credit, are certainly capital specimens of the feathered race. "If," as the spirited author of the "Pentologue" hints, "they are only the result of American invention, they have invented a very nice fowl. And if the Americans made them, I can only hope they will go to work again and make us something else."

The following is a description of two Brahma fowls, a cock and hen, bred by Dr. Bennett, of New Hampshire, and sold to Dr. Gwinne, of England:

"The cock, when drawn up to his full height, measures thirty inches; the head and eye have much of the Malay character; the neck is full; the back is very short; and falling rapidly from the bottom of the neck to the insertion of the tail; the thigh and shank long; but the breast is fairly developed, decidedly more so than in most Malay specimens. The face, wattles, and ear-lobes, the latter of considerable size, are brilliant crimson, similar in point of color to the face and crest of the silver pheasant; the beak short and yellow; comb small, depressed, and studded with numerous points or sprigs. American fanciers compare it to the pea-comb of the 'Sumatra pheasant Game fowl,' though of the bird thus designated we have no further notice; hackle full, being streaked with black on a yellowish white ground; saddle feathers

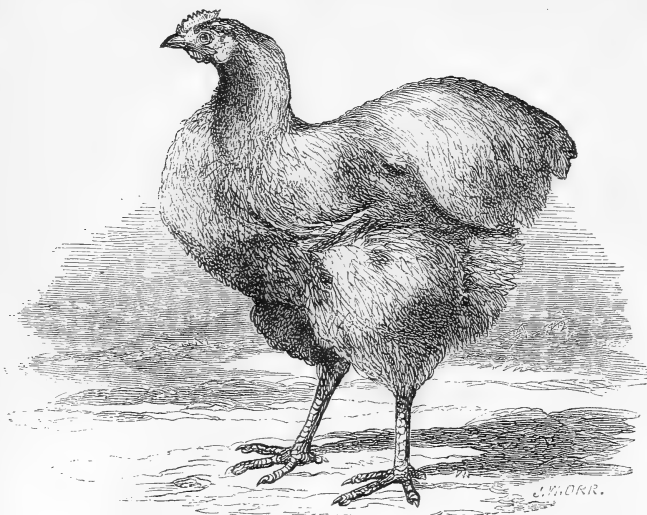

EMEU SHANGHAI FOWL.

the same; the point of the wings and tail black; breast imbricated (feathers placed like tiles); wing-coverts and primaries white, with black markings; belly and vent dark gray; legs yellow, with a pink tinge, and well feathered.

“The hen is throughout of a rich silvery gray color, with a considerable mixture of black on the hackle, back, tail, and wings; her comb is like that of the cock on a reduced scale; standing erect she would be about twenty inches in height.”

The doubts to which many have given utterance as to the title of the Brahmas to be considered a distinct race of fowls, exist among the English as well as American fanciers. Appearances there certainly are which, until farther evidence has been obtained on the permanency in the progeny of present distinctive features, should prevent any summary judgment favorable or otherwise.

The head, as also in some instances the comb, and the general figure certainly resemble those of the Malay. And as regards plumage, there

are birds of the Malay and Shanghai families by whose union such colors would probably soon appear. But if, on the other hand, the test of “like producing like” for several generations should be successfully afforded by the Brahmas, other grounds must be sought for by those who would consign this alleged variety to the comparative ignominy of a hybrid origin.

#### EMEU SHANGHAI.

Freaks of nature are not uncommon in the fowl species. Among the monstrosities of the domestic fowl, which are particularly curious, and worthy of the attention of the student of nature, may be mentioned the Emeu Shaghahi. Instances are not uncommon among fowls where the usual form of the feather has given place to the peculiar texture of the Silk fowl, and from this singularity has obtained the name of the “Emeu Shanghai fowl,” from its similarity to the woolly coat of the Australian bird. In the case of the above, which the engraving delineates, it is said there were no indications of any silky cross in

the Shanghai; but on the contrary, every other feature, plumage excepted, was perfectly retained.

The Emeu Shanghai, noticed above, "has plumage much resembling those of the true Silk fowls. The feathers have their web separated from the point of junction with the shaft, so that their covering seems of fur rather than that which is ordinarily allotted to birds. The tail feathers, if it can be called a tail, it is little more developed, in fact, than the Rumpless fowl, resemble fine gauze or fur, for here the texture is closer than on any part of the body."

This fowl was obtained as follows: A gentleman in England was presented with six Shanghai eggs from a yard where none other than Shanghais were kept, excepting, perhaps, one or two common hens; but, however, there were only Shanghai cocks, and the eggs which were given were laid by Shanghai hens. From these six eggs three chicks were hatched; two

turned out very handsome Shanghai cocks, and the third egg turned out, to all appearance, a thorough-bred Emeu hen. From her eggs no such fowls were ever hatched; they were also the sort of brute you would imagine would be the consequence of a cross between the Emeu hen and a Shanghai cock; but at the same time the Emeu hen, while differing entirely in appearance from her brothers, and, in fact, from all her relatives, possesses all the moral and domestic traits of a Shanghai—the same gentle tractability of temper, the same proneness to sitting, the same fecundity in laying eggs.

Some chickens bred from this hen by a Shanghai cock were not apparently different from buff Shanghai chickens, with black hackle and feathered legs.

We are not aware of its possessing any points of excellence beyond its relatives, and we therefore leave it with the mere mention of the strange garb that has obtained for it its present name.



## CHAPTER VI.

## FARM-YARD FOWLS.

THE day is beginning to dawn when each variety of fowls must stand or fall by its own individual merits; the fictitious bolsterings of fancy give preference to the stern realities of utility, and the most valuable for table purposes, for laying, and for incubation, must wrest the laurels from their opponents. It is well it should be so, for these are the considerations that should alone bias us in choosing our favorite variety to breed from; for as, when fowls are used for the legitimate purposes of the table, an ideal value can never be maintained, so it is equally certain that when an amateur has purchased dearly-bought experience, the impression fixes itself tenaciously on the mind, and does much to prevent unchecked demands on the pocket for the future.

Dr. Bechstein, of Germany, seems not to have been far from suspecting that several distinct varieties might be detected among the ordinary fowls of the farm-yard. It might answer the purpose of the amateur or dealer to rear a pure stock of some of the handsomest and most useful of these, and send them forth with appropriate names, determined by competent persons, fixing the appellation of the variety.

The common domestic cock, the well-known chieftain of the farm-yard, is subject to innumerable varieties, scarcely two being found to resemble each other exactly in form and plumage. At what time this valuable bird was first brought under the control of man, it is now impossible to determine; but as the forests of India still abound with several varieties of the fowl in the wild or natural condition, it is quite reasonable to conclude that the race was first domesticated in the East, and gradually extended thence to the western world. The earliest date of poultry-keeping is supposed to be coeval with the keeping of sheep by Abel, and the tilling of the soil by Cain. Indeed it would

seem that we are indebted for a stock of fowls from the ark itself. Aristotle, who wrote about 350 years before Christ, speaks of them as familiarly as a modern historian would.

## GAME FOWL.

We place at the head of the Farm-yard fowls the Game fowl, which is supposed to be the first reclaimed, and of course the most ancient of all the varieties of domestic fowls.

Our portrait is copied from an English print, and called the Shawl-necked, or Irish Gray. They are the largest sized of the Game fowls, and are highly prized by the "fancy."

The Jungle fowl of India is regarded by most authors as the common ancestor of all our fowls, and the Game fowl is naturally suggested as the first link in the geneological chain. Some assert that the Black-breasted Red birds are derived from what is commonly called the Bengal Jungle fowl, while others claim a separate descent from the Duck-wing fowl which inhabits Southern India, known as Sonnerat's Jungle fowl, whose more varied plumage bears a very close resemblance to this beautiful variety. Others again, think the race from which they sprung, like that of the Dodo, are extinct. But we will leave inquiries of this kind, though very interesting, to the Naturalist.

It is also supposed by some that the English Game fowl originated from a cross between the common barn-yard fowl and the English pheasant, as the latter is known to be so quarrelsome and determined a character, that when two cocks encounter in their wild state, they seldom separate until one or the other is killed. Many of the Game fowls certainly much resemble them in their plumage, color of their legs, etc., for the best are mostly red, dark brown, brass-colored wings, and black breast.

Mowbray says the progeny between the com-

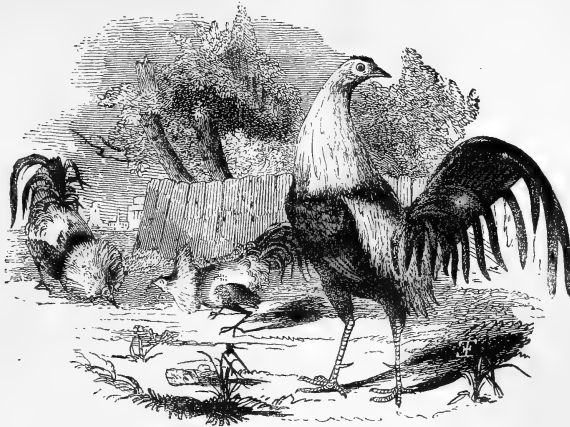

SHAWL-NECKED GAME FOWL.

mon fowl and the pheasant are necessarily *mules*, as proceeding from different species although of of the same genus.

That the pheasant will cross with the domestic fowl, is evident from the following fact, which we find related in the "Journal of Agriculture," published in Scotland. "In the autumn of 1836," says the narrator, "a wanderer of the Pheasant tribe made his appearance in a small valley of the Grampians, the first of his family who had ventured so far north in that particular district. For some time he was only occasionally observed, and the actual presence of this *rara avis* was disputed by many; wintry wants, however, brought him more frequently into notice; and in due time, proof still more unequivocal became apparent. When the chicken broods came forth, and began to assume a shape and form, no small admiration was excited by certain lofty, long-tailed, game-looking birds, standing forth among them, and continuing to grow in size and beauty, until all doubts of the stranger's interference with the rights of chanticleer effectually vanished. These hybrids partook largely of the pheasant character; and as they are of a goodly size and hardy constitution, a useful and agreeable variety for our poultry-

yards may be secured in a very simple and economical manner."

Although the fowl was found in a domestic state in Britain at the time of the Roman conquest, it is probable that the game breed was introduced after that event. Martin remarks that the ancient Greeks possessed several renowned breeds of game fowls, and that Media and Persia possessed others of first-rate excellence; but he thinks it probable that this breed was introduced by the Romans, who are supposed to have derived it from the Persians, when Britain was a Roman colony.

No satisfactory information seems to be accessible now by which to pronounce with certainty on the origin of this breed. It is certain, however, that in India an original race of fowls exist at the present day, bearing all the peculiar characteristics of the species, in full perfection; and the probability therefore is, that these fowls are natives of India. The natives of India, it is well known, are infected with a passion for cock-fighting. For this barbarous amusement these fowls are carefully bred, and the finest birds become articles of great value.

There is much elegance in all the movements

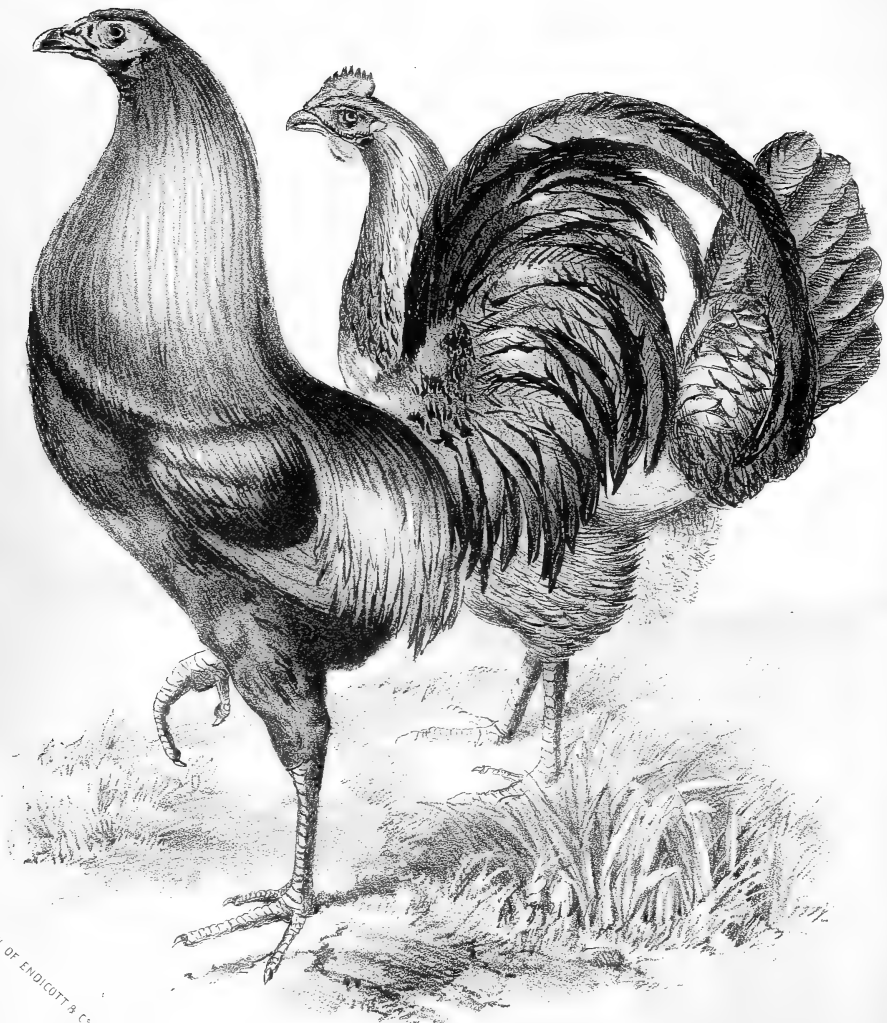

LITH. OF ENDICOTT & CO. N. Y.

BLACK BREASTED RED GAME.

a choice should be regulated: The head of the Game-cock should be thin and long, like that of a greyhound; face bright red; beak massy at the root, strong and curved; eyes large and sparkling; neck long and full; breast broad and well developed; back short and flat between the shoulders; body tapering toward the tail; wings inclined to expand and cover the thighs, somewhat after the Bantam; thighs short and muscular; shank or beam of the leg powerful, and long in proportion to the thigh; legs well forward, with a clean foot and strong claws. When placed on his breast on the palm of the hand he should be evenly balanced. In condition he should exhibit both closeness and hardness of feather, while his carriage is erect, evincing both boldness and self-confidence.

The proportions of the hen will, of course, exhibit certain feminine reductions from her consort's figure; but the clean and finely-formed neck and head, the latter surmounted by a small upright comb, together with a neat figure, and muscular formation of the leg and thigh, and of general elasticity of limb, must always be apparent.

The comb, as a main characteristic in the Game fowl, more particularly in the male bird, so disappears that the ardent admirers of this breed might be inclined to regard it rather as an accident than a property.

The spur should be placed low on the leg, its power as a weapon being thereby greatly increased; but the force of the blow is aided by a rapid driving stroke of the wing. The best weight of a Game-cock is generally considered to be about five pounds, but we have known some to reach six pounds. The Shawl-necked or Irish Grays are of the largest class.

*Game Hens as Layers.*—The color of the eggs of the Game hen varies from a dull white to a fawn, but crossing with the Asiatic bird imparts a still darker tint. In shape, as might be supposed from the numerous sub-varieties, our description must be very general, for, while with the Black-breasted and other Reds, we find the egg with the diameter greatest at one-third of its length from its larger end, and both extremities tapering, neither this color nor form could be affirmed of other varieties.

The Black-breasted Red is as good a layer as any of this numerous family; as many as twenty-four eggs being constantly laid by them before manifesting any desire to sit. But with regard to the number of eggs laid by fowls of any breed previously to their manifesting a desire to incubate, much will depend on whether the eggs are removed and a nest-egg only allowed to remain, or whether they are allowed to accumulate as day by day the store may receive additions. If the latter plan be adopted, few Game fowls, we imagine, would be found to lay beyond the number instinct would suggest as the proper complement for their nest; and this we find from twelve to fifteen.

As *sitters* Game hens have no superiors. Quiet on their eggs, regular in the hours for coming off and returning to their charge, and confident, from their fearless disposition, of repressing the incursions of any intruder, they rarely fail to bring off good broods. Hatching accomplished, their merits appear in a still more conspicuous light. Ever on their guard, not even the shadow of a bird overhead, or the approach of man or beast, but finds them ready to do battle for their offspring; and instances are on record where rats and other vermin have thus fallen before them.

*Qualities for the Table.*—If any of our readers should desire the *ne plus ultra* of excellence in a fowl, let him eat and pronounce his opinion on the wing of a well-fed Game pullet, and we will have no fear of his disagreeing with this expression of our judgment on the good qualities of these birds for the table.

Of all the breeds, the Game fowl is considered the most perfect and beautiful, whether we look to contour or to coloring; the cock carries himself proudly and yet gracefully, his port and bearing proclaim his fiery spirit, his undaunted mettle, which endures even to his last breath, for while prostrate and mortally wounded he will answer the insulting crow of his victorious rival, and make a last effort to revenge himself before the spark of life is extinct. No wonder then that the gallant cock should have been chosen as the emblem of courage.

It is allowed by most persons that a high-bred Game-cock in full health and vigor, is, after all,

the *beau ideal* of a fowl, the true aristocracy of the genus *gallus*. It is not wonderful that he should have been a favorite equally with the refined and intellectual Greeks and the hardy and daring Romans.

The Romans, whose taste for sanguinary spectacles is notorious, were extremely partial to the amusement of cock-fighting, and trained birds for that purpose. Indeed the taste for this cruel sport seems to be very general; the Mussulman natives of India are greatly addicted to it, and one species of Jungle fowl called Sonnerat's Jungle Fowl, is in high request. This bird, though smaller than the domestic breed, is superior in spirit and endurance, and usually proves victorious in combat. The Chinese are devoted to the sport; and the natives of Sumatra enter into it with so much ardor, that instances, it is said, have occurred of men staking not only their goods and money, but even their children on the issue of a battle.

In England the same taste long prevailed, but happily the practice, "more honored in the breach than in the observance," is now greatly on the decline, if not obsolete; it is, indeed, incompatible with the diffusion of knowledge and the progress of the age, the tendency of which is to humanize mankind, and lead the mind from sordid and debasing pursuits to sources of intellectual enjoyments.

The Manilla Indians, in common with all Malays, are passionately fond of cock-fighting; but they are not permitted to indulge at pleasure this inclination. An Indian rarely walks out without a cock, and as soon as he meets another Indian with one under his arm, the two birds are set down and immediately engage; but battles with gaffs or steel spurs are only permitted in a place formed for the purpose, which is farmed from the king at a rent of twenty or twenty-five thousand dollars; here the Indians assemble, and frequently bet on their favorite cocks the whole of what they are worth. The fate of the gamesters is soon decided, for the cocks being armed with sharp spurs, one or the other is killed almost in an instant.

A cock-pit, like a race-course, in a sporting point of view, in England, was for every person, and selection of company was entirely out of

the question. The noble lord and the weedy commoner were both at home after they had paid their *tip* for admission; and persons who enter the pit to sport a *crown*, bet a *sovereign*, or put down their *pounds*, are too much interested upon the *main* to consider whom they may chance to "rub against" for the time being.

Cock-fighting, which among us is regarded as barbarous and vulgar in the extreme, is in Mexico by no means a peculiar amusement. It is universal, and stands second only to the bull-fight.

Waddy Thompson, in his "Recollections of Mexico," gives a very interesting description of a cock-fight which he witnessed. "When I first visited Santa Anna at Encerro," says Mr. Thompson, "he was examining his chicken cocks, having a large main then depending—he went round the coops and examined every fowl, and gave directions as to his feed; some to have more, others to be stinted. There was one of very great beauty, of the color of the partridge, only with the feathers tipped with black instead of yellow or white; and the male in all respects like the female, except in size. He asked me if we had any such in this country, and when I told him we had not, he said that if that one gained his fight he would send him to me—he was the only one of fifteen which did not lose his fight; and shortly after my return, when I visited New York, I found the fowl there. I had thought no more about it, and had no idea he would send him.

"In Mexico there is no variety of sport that produces a more general excitement than the cock-fight. It is not confined, as might be supposed, to any particular class of persons. Between the generalissimo of the army and the rawest recruit—the President of the Republic and the humblest hind—the Archbishop of the Church and the meekest member, there is no difference. In the amphitheatre, side by side, stand the priest and the peasant, the hunter and the herdsman, the shopman and the soldier. In juxtaposition may be seen the old man, whose dangling locks are white as the polar snows; the slender youth, whose limbs are slowly rounding into manhood, and the truant boy, scarce old enough to lisp his Spanish name.



It is common to every caste and condition—to every age and vocation; and even women are sometimes the willing observants of this barbarous sport. It is attended by every body.

“When I entered the cock-pit Santa Anna and General Bravo, with a large number of the most distinguished men in Mexico, and quite a large number of ladies of the highest circles, were already there. The master of ceremonies on the occasion walked into the pit, and exclaimed two or three times, ‘*Ave Maria purissima, los gallos vienen*’—Hail most pure Mary, the chicken-cocks are coming. Whereupon a cock is brought in covered, and a challenge is proclaimed to all comers—which is very soon accepted. The fowls are then uncovered, and allowed to walk about the pit, that the spectators may see them, and select the one on which they choose to risk their money. Those in the seats call some of the numerous brokers who are always in attendance, and give them whatever sum they desire to bet, and designate their favorite cock. Before the fight commences, the broker returns and informs the person whose money he has received whether his bet has been taken. If he loses, he sees no more of the broker; but if he wins, he is perfectly sure to get his money. A small gratuity is expected by the broker, but never asked for, if it is not voluntarily given.

“Unlike cock-pits in other countries, attended by black-legs and pickpockets, and gentlemanly *roués*, by far the largest portion of the assembly in the pit was composed of the first young men in Mexico, and for that matter, of the first old ones also. There was neither confusion, nor noise, nor even loud talking, far less swearing, among the lowest of those assembled in the ring; and it is this quiet and orderly behavior which throws over all these incongruities a cloak of decency and decorum, that hides their impropriety so completely, that even foreigners, who have lived here for a few years, and who were at first struck with astonishment by these things, are now quite reconciled to them.”

Among the amusements at Lima the cock-pit is a great attraction, and all classes frequent it. The cocks are armed with steel spurs, and the battle is soon determined.

#### DOMINIQUE FOWL.

This well-known variety of our domestic fowl, there is good reason to believe, is old and distinct, though it is generally looked upon as a mere “farm-yard fowl;” that is, the accidental result of promiscuous crossing; but there are several forms among the farm-yard fowls, so called, that are seen to be repeated generation after generation, the counterparts of which are to be met with, scattered here and there, over this country. So constant repetition of corresponding features would seem to declare that there are several unnoticed and undistinguished varieties of fowls which deserve to be regarded and treated as we do other distinct varieties.

The Dominique fowl, well selected and carefully bred, is a fine and useful bird. They are distinguished as Dominique by their markings and their color, which is generally considered an indication of hardiness and fecundity. They are by some called “Hawk-colored fowls,” from their strong resemblance in color to the birds of that name. In England they are usually called “Cuckoo fowls,” from the fancied resemblance of their plumage to the feathers on the Cuckoo’s breast. We seldom see bad hens of this variety, and, take them “all-in-all,” we do not hesitate in pronouncing them *one of the best* and most profitable fowls, being hardy, good layers, careful nurses, and affording excellent eggs and first quality of flesh.

In any close grouping of the breeds of poultry, the Dominique fowl might perhaps be safely referred to the Dorkings. Some of the slate-colored, barred Dorkings are scarcely distinguished from them, except by the fifth toe; still there is something very permanent and remarkable in the peculiar style of plumage that ought not to be lost sight of. It is with difficulty got rid of by crossing. Half-bred Spanish and Dorking fowls have quite retained the barred and shaded feathers of the one parent, displaying the comb, ear-lobe and stature of the other. And this curious and decided plumage is quite confined to one or two breeds, never appearing, that we are aware, in others, such as the Game, the Malays, and the Hamburgs; a circumstance which makes us believe it to indi-

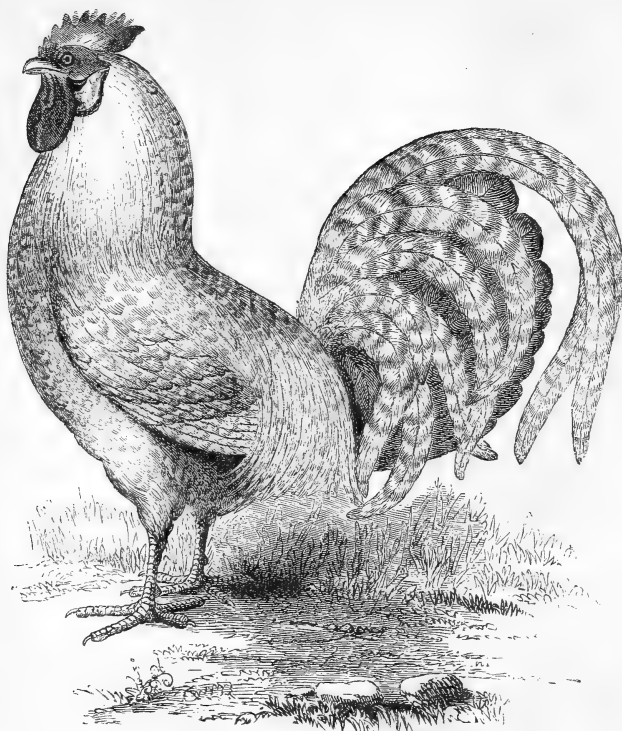

DOMINIQUE FOWL.

cate an ancient descent from some peculiar and original parentage.

The prevailing and true color of the Dominique fowl is a light ground, undulated and softly shaded with a slaty-blue all over the body, as indicated in the portrait of the cock, forming bands of various widths. In order to be more fully and better understood, and to show the peculiar markings of the feathers, we procured a feather from one of the hens which is faithfully delineated on the opposite page. The comb of the cock is variable, some being single, while others are double—most, however, are single; the iris, bright orange; feet and legs light flesh color—some, however, are of a bright

yellow or buff color; bill the same color as the legs.

The hens are not large, but plump and full breasted. The cocks are somewhat larger than the hens, some approaching the smaller-sized Dorkings in weight. The chickens at two or three months old exhibit the barred plumage even more perfectly than the full-grown birds. The eggs average about two ounces each, are white, and of porcelain smoothness. The newly hatched chicks are gray, with a dark stripe down the back of the neck, and three on the back, resembling those of the Silver Polands, except in the color of the feet and legs. The Dominique fowl supplies an unfailing troop of good

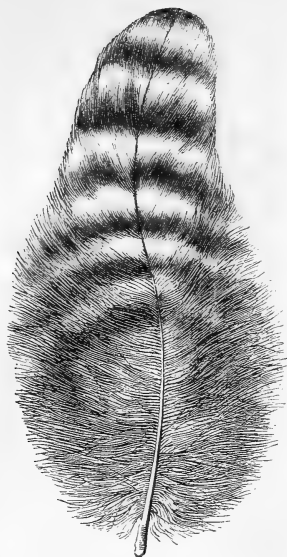

layers, though not quite so early in the season as the Asiatic and some others; they are good feeders, good sitters, good mothers, hardy, and are well worthy of promotion in the poultry-yard.

*Merits.*—Dr. Bennett, in his “Poultry Book,” says, “I know of no fowls which have stood the test of mixing without deteriorating better than the Dominique. They are said to be from the island of Dominica, but I very much doubt it. I should incline to the opinion that they took their name from being ‘tenants at will’ of some feudal sovereignty. Why it is that so perfect bloods should have escaped description of poulterers, I am unable to divine. It is true they are rather small, and that is the worst thing that can be said of the Dominiques. They were introduced by the French, and not a Dutch fowl, as some suppose.”

In the Appendix to “Browne’s Poultry-Yard,” the late venerable Samuel Allen, when speaking of the comparative merits of the different breeds of fowls, says: “The Dominique fowl is another breed becoming more and more in

favor, as they are universally pronounced as being hardy, good layers, careful nurses, and affording excellent eggs and flesh. Besides, their beautiful appearance, when in full plumage, is quite an acquisition to the farm-yard or lawn.”

Mr. G. C. Pierce, of Danvers, Massachusetts, a breeder of merit, says concerning the Dominique fowls: “Taken all in all, I believe them to be one of the very best breeds of fowls we have, and I do not know of any breed that alters so little by in-and-in breeding; they are first-rate layers, and although they do not come into laying so young as the Spanish, I think them far better sitters and nurses.”

#### THE DORKING FOWL.

“It is our firm belief that the fowl now known as the Dorking,” say the authors of the “Poultry Book,” “a very valuable and favorite variety, which takes its name from a town in the county of Surrey, might be much more correctly designated the ‘English fowl.’ It is supposed to have originated in Surrey, where, and in its vicinity, they are still said to be found in great plenty and perfection. This opinion is founded on the probability that they are the lineal descendants, of course of various intermixtures, from those which our British forefathers bred at the time when they first became intimately known to the Romans; or that they are similarly descended from fowls introduced by those conquerors of our island.

“It is in vain to endeavor to follow their origin farther; but those who would trace our gallinacious birds to an Eastern source, will take comfort from the certainty, or all but certainty, that the world’s merchants in the days of Solomon—the Phœnicians—visited the British Islands, the Cassiterides, for their tin. These merchants who bought goods to exchange for it, seeing the Britons’ fondness for domestic poultry, may have brought fowls to barter for the metal.

“The Romans probably weakened the prejudice of the Britons against eating the domestic fowl; and, as it is well known they strove to improve the British farming and gardening, so it is more than reasonable to conclude that poultry shared in the progressive effort. Our most prev-

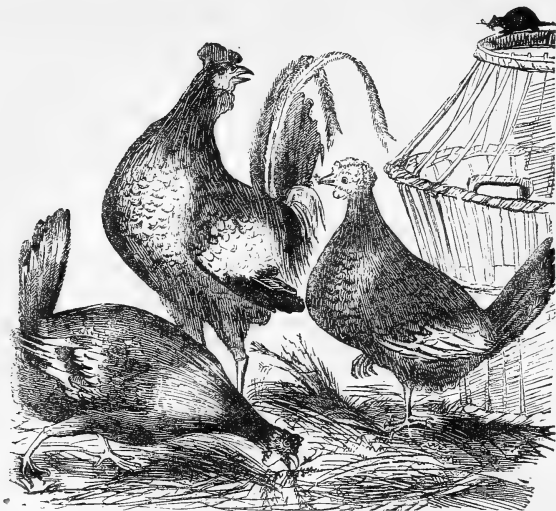

THE DORKING FOWL.

alent breed, the Dorking, share the five-toed excellence that characterized the most esteemed fowls of Rome."

Both the Dorking and Game are ancient breeds. Columella, who lived in the middle of the first century, accurately describes the Dorking, as we have it, as being the best fowl of his time; speckled in color, of great beauty of plumage, and possessing the fifth toe.

"We have sought for information as to the time when Dorking and its fowls first became noted," says a writer in the *Gentleman's Magazine*, "but our inquiry has been fruitless. When Camden wrote his 'Britannia' in 1610, Dorking was so inconsiderable as not even to be mentioned by him, and in his map of Surrey it is marked a mere village. It is probable that the soils in that neighborhood, sand and chalk, which are particularly favorable to the rearing of chickens (and also the demand for such delicacies occasioned by the resort thither of visitors in the summer season to eat 'water souchet,' made from the perch for which its waters are celebrated), may have led to particular attention to

poultry culture. At all events, a century ago the fame of Dorking poultry was established; for a writer in 1763, who evidently knew the neighborhood well, says, 'An incredible quantity of poultry is sold in Dorking, and they are all well known to the lovers of good eating for being remarkably large and fine. I have seen capons about Christmas which weighed between seven and eight pounds each, out of their feathers, and were sold at five shillings apiece.'

A writer who resides in the vicinity of Dorking, and an extensive breeder, says, "I am inclined to the opinion that the old white Dorking fowl has been continually crossed with fowls of a larger breed, which from time immemorial have been known to prevail in Sussex; and this more particularly in the district around Cuckfield and Horsham, where great attention has been paid to the selection of breeding stock, and a much better fowl has been produced.

"Now we are altogether without evidence, at least for the last eighty years, that would warrant our assigning the fowls, now called colored Dorkings, to the old Dorking stock before al-

cluded to; but, on the other hand, there are old men now living in the Cuckfield district, where the best specimens are still found, brought up from their infancy as higglers or fowl-dealers, following the occupation of their fathers in the same business, who assert, on their own knowledge and on the tradition of their predecessors, that the fowl in question is a *Sussex fowl*, and that nothing would induce them to cross their breed with the Dorking."

It has been stated by those who have paid particular attention to the subject, that the thorough bred are less hardy and less prolific than when an admixture of blood is admitted, which has been confirmed by the experience of those who have kept the pure speckled Dorking on a large scale, both for private consumption and for the supply of the market, that the cross is more profitable. Some complain that they are soon worn out, and not good for much, either in the way of laying or sitting, after their second year. All this shows some inherent defect. Hence the precautionary and remedial measure of introducing a fresh and well-selected cock-bird or two into the walk every second or third year, at farthest, is the very best that can be adopted.

Mr. Dixon, a celebrated writer on poultry, remarks, on the subject of the Dorkings: "For those who wish to stock their poultry-yards with fowls of the most desirable shape and size, clothed in rich and variegated plumage, and, not expecting perfection, are willing to overlook one or two other points, the speckled Dorkings are the breed to be at once selected. The hens, in addition to their gay colors, have a large vertically flat comb, which, when they are in high health, adds very much to their brilliant appearance, particularly if seen in bright sunshine. They are larger bodied, and of better proportions, according to their size, than any other variety I have yet seen, their bodies rather long, plump, and well fleshed; and the breeder, as well as the housewife, generally beholds with delight their short legs, full broad breasts, little offal, and the large quantity of good profitable flesh, the flavor and appearance of which is inferior to none. When fattened and served at table, the master and mistress may be satisfied.

In size the Dorking ranks next to the large Asiatic tribe. It is short-legged and large-bodied, and readily accumulates flesh, which is of good quality. The breed has been introduced from England, and has been bred in this country for a number of years. Mowbray, when he wrote, ranked them in size in the third degree of the largest of fowls. The weight of the Dorkings at maturity varies from five to eight pounds, and full-grown capons have been known to weigh from ten to twelve.

The Dorking hen is rarely a layer of many eggs before she becomes broody, the average number not exceeding twenty-four. The eggs are usually of a clear white, but sometimes of an ashy-gray color, rather larger in size, weighing from  $2\frac{3}{4}$  to 3 ounces each, rounded at both ends, and of a rich flavor. They have the reputation of being excellent sitters and good mothers; but as pullets they do not excel for either employment.

The Dorking cocks are splendid birds. The most gorgeous hues are frequently lavished upon them, which their large size and symmetrical form display to great advantage. The original Dorkings are said to have been white, but such are now seldom seen. From the specimens we have seen, we have no reason to believe that *color* is a criterion of purity. Mowbray contends that they are of an ivory-white, and that they have uniformly five toes or claws on each foot, while a writer in "Rees' Cyclopaedia" says "the colors are as variable as the dung-hill fowl." "The most valuable variety for the table at present," says Main, "is the Dorking breed. They are pure white; and highly esteemed for the whiteness and delicacy of their flesh when served at table, and fetch a high price in market."

Among the early importations of pure-blooded Dorkings into this country, white more or less prevailed; but many were marked with bands or bars of ashy-gray, like our Dominique fowl; some had the hackles of the neck white, with a tinge of yellow, and the body of a darker or brownish-red, intermixed irregularly with white; while others were beautifully variegated with white, black, green, and brown, commonly called speckled. The combs of some cocks are large,

serrated, and erect; in others, large and rose-shaped; wattles large, and of a brilliant coral.

The Dorking fowl, more or less crossed, or at least a race nearly allied to them, called the "Sussex breed," the bodies of which are more elongated than in the Dorkings, and many of them having five toes, are represented as very fine.

In the lithograph figure the reader will recognize a true Dorking—a fowl which has received as jealous a care in its breeding at Surrey as suits the fancier who goes for the purity of blood. So careful are the breeders of these fowls in their own neighborhood, that it has been with extreme difficulty that they could be obtained at any price.

Dr. Eben Wight, of Boston, who imported some of these fowls as early as 1839, and has paid considerable attention to the rearing of poultry, says, in a letter to the author, "So far as my experience has gone, the Dorkings are *decidedly* the best breed for laying; the eggs come abundantly, and are of the largest size, except when they have been bred 'in-and-in' too much. I have already seen the effect, and therefore hope to receive a new lot of Dorkings during the summer." After six months more experience, the same gentleman writes me: "As regards the Dorkings, I am still strongly prepossessed in their favor; as layers, they are certainly very prolific. As an instance, one of my neighbors had a pullet which was hatched in May: in the *same year* the pullet began her litter of eggs, and hatched out her chickens before the first of December ensuing. This is only one of the many instances which could be advanced in their favor."

Another breeder says "the Dorkings sustain a high character in England as layers, but mine have not laid better than our common hen."

"The Dorking fowls," says another writer, "stand first in the estimation of those who have raised them. Their meat is fine, their bodies are large, and better proportioned than any others, being long, full, and well-fleshed in the breast; have short legs, and beautiful plumage, with five instead of four toes; are good layers, good sitters, and good nurses. When caponized, they weigh from nine to ten pounds."

Dr. Wight some time afterward says, "When I received my first lot of Dorking fowls, some ten or twelve years since, through a friend who was making a periodical visit at Dorking, he assured me that it was only after a trial of some two years that he could obtain them, and then only by a resident to go down to the ship and see them safely off for America; the producers of the stock being fearful that other sections of England might secure the breed."

As corroborative of others finding the same difficulty, we quote from the editor of the *American Agriculturist*: "As Dorking fowls are likely to be in vogue now, we think it advisable to caution all those who wish to possess good ones, to be very careful what they buy. Choice birds are extremely difficult to be had, as we found to our cost when in England, and it was only by special favor we procured them at last."

In a late number of the *American Agriculturist*, the editor remarks, "We are glad to meet with the following common-sense article in an English publication, the *Derby and Chesterfield Reporter*, on the Dorking and Game fowls. It will be seen that it almost exactly coincides with our views as expressed on the same subject. When we first met with the Dorking fowl in England, we made up our minds that it was the best and most scientific-bred bird we had ever seen, its fifth toe only excepted, which is an excrescence that ought to be got rid of in future breeding. A little knowledge in keeping them justified us in pronouncing them entitled to the same rank among barn-yard fowls that short horns have taken among cattle; and years of experience in breeding them have confirmed us in this opinion. The only trouble we have ever met with them is, too close breeding, which it is essential to obviate. We, however, greatly esteem the cross with the Game fowls, and yet we desire to see both the Dorking and Game perpetuated, and kept up pure and distinct by themselves.

"The time will come when people will get sick enough of those great coarse ill-shaped Asiatic fowls. We have expressed very plainly our opinion of these fowls ever since we met with the first importations. A more *unscientific*-bred domestic bird we do not know. For the food



LITH. OF ENDICOTT & CO. N. Y.

WHITE DORKINGS.





consumed, it is utterly impossible for such a *modeled* machine to give the same amount of good flesh and eggs that the finer and juster bred fowls will, such as the Dorking, the Game, the Spanish, the Poland, the Dominique, and many other varieties we could mention. But to the article alluded to:

“The common sense of the public has brought back the Dorking fowl to its wonted pre-eminence. At the sale after the Metropolitan show, and also at the Birmingham Exhibition of 1854, the Dorking fowl met with readier sale at large prices than any other bird. The public voice has recognized it as *the* bird for the English farm-yard; it is altogether the pet of John Bull, as possessing great and good qualities without ostentation and clamor. The history of our country town records no less than three poultry sales by public auction, and at each of those the Dorking fowl obtained the highest bidding—good hens selling for as much as thirty shillings each; and farther, the most successful breeder of Dorking fowls is at this moment selling their eggs readily at three guineas per dozen. These and the Game fowl are the true British poultry. They are racy of the soil, and come to us, like many other good things, from a remote antiquity. If it were possible to ingraft the hardihood and the quality of the latter upon the size and early maturity of the former, *perfection* would be obtained. The veriest gourmand could ask no more, for there would be quantity and quality enough to satisfy the most capacious and capricious of appetites. Tenderness and plumpness would go hand in hand with a juiciness fitted to enrapture an alderman who had passed the chair, or even a metropolitan bishop. These are great and critical authorities in matters of taste. Bland, and unctuous, and racy as they appear, they are nevertheless excessively fastidious—the terror of cooks, and the final appeal in all matters appertaining to gustiveness and alimentary delight; but even such an ordeal could be borne by the fowl that combined in itself the respective excellences of the Dorking and Game breed. The delicate taste of an Aerial, who could sit only where the bee sipped, and the greediness of an Esquimaux, might be contemporaneously gratified under such a com-

bination, and short only of this, the Dorking fowl stands pre-eminent as *the* fowl for the table.”

“Those persons,” says an English writer, “and those only who saw and studied pen 160 at the Birmingham poultry show of 1853, can form an accurate idea of the size, quality, and beauty of a first-rate Dorking fowl. They were *the* birds of the exhibition, and before them the whole tribe of Spanish and Cochins, black, white, brown, and buff, ‘paled their ineffectual fires;’ thirty-five pounds’ weight of the most delicate meat under heaven were enshrined in beautiful forms, and robed with a plumage in which richness and grace struggled for ascendancy.

“Although this fowl was described by Pliny, by Columella, and by Aldrovandus, a thousand years ago; although it has been long known to naturalists as the ‘*Gallus Pentadactylus*,’ or five-toed hen, and recognized through this quality by every good housewife who sought a good fowl in Leadenhall Market, yet strange to say, it has been little patronized by the farmers in general, or even by persons of greater pretensions. Mr. Trotter, who has recently received a prize from the Royal Agricultural Society for the best ‘*Essay on Poultry*,’ devotes eighteen lines only to the Dorking fowl, and in this quarter page commits several errors respecting them. He says ‘this breed degenerates when removed from its native place.’ Now, it is a fact, that birds bred in Lancashire have hitherto beaten all competitors. The Rev. Mr. Boys, in Kent, took the chief prizes at Reigate, in Surrey (the very home of the Dorkings); but his birds, which he valued at £200, were beaten utterly at Birmingham by fowls from Lancashire, Derbyshire, and Shropshire. If I were to write that the Dorkings of Derbyshire may challenge the world it would appear like a big, burly, blustering sentiment, ‘full of sound and fury signifying nothing;’ but it is nevertheless not very far from the truth. Take not one county away, or one division, or one town, but remove the birds of *one individual* from competition, and then it is the modest opinion of a Derbyshire Yeoman, that the Dorking fowl, within a ten-mile radius of his county town, may safely vie with all England, and therefore with all the world. To the proof: in judging of public questions, we

can be guided only by public results. If asked, where are the best Leicester sheep in England, the reply at once is, at Mr. Sandy's, Holm Pierpoint, Nottingham—and why? because, in a royal competition, open to the United Kingdom, he carries off the prize. People may hug themselves with self-complacency, and flatter themselves that they have *better at home*; but let them compete, and perhaps they will discover that there is something in a home atmosphere which leads to optical illusions, and thereby to defective judgment. A little solitary hill in a wide plain looks wonderfully large, for want of others with which to compare it; and both cattle and poultry have been known to look much larger by themselves than by the side of their rivals.

"It is a question how the variety known in England under the name of 'Speckled Dorkings' was first produced. Some maintain that the pure white Dorkings are the original breed with five toes, and that the speckled and gray Dorkings is a recent and improved cross, by which the size was much increased between the original white breed and the Malay, or some other large fowl. From this opinion I must entirely dissent on the ground of strong, though not absolutely conclusive, evidence to the contrary. It seems to me that Columella's favorite sort of hen could not differ much from the speckled Dorkings as they at present exist. He says: 'Let them be of a reddish or dark plumage, and with black wings. . . . Let the breeding hens, therefore, be of a choice color, a robust body, square-built, full-breasted, with large heads, with upright and bright-red combs. . . . Those are believed to be the best bred which have five toes.' It appears that Columella had the white sort, but he rejected them; for he advises: 'Let the white ones be avoided, for they are generally both tender and less vivacious, and also are not found to be prolific,' faults which are still attributed to them by some. Mr. Courtney, in a letter to Captain Morgan, who imported some of these fowls in 1845, says: 'The old white sort is altogether bred out, and the speckled and gray varieties are now all the rage, and altogether are, perhaps, the best barn-yard fowls in existence.'"

Mr. Dixon says, after speaking of the good qualities of the speckled Dorkings, "With all these merits they are not found to be a profitable stock if kept thorough-bred and unmixed. Their powers seem to fail at an early age. They are also apt to pine away and die just at the point of reaching maturity; particularly the finest specimens, that is, the most thorough-bred, are destroyed by this malady. These, and a few other apparently trifling defects, seem to show that with the speckled Dorkings the art of breeding has arrived at its limits."

"Fearing total ruin in our chicken department (Dorkings)," says A. B. Allen, in the *American Agriculturist*, "two years ago we displaced the Dorking cock, and introduced a thorough-bred, spirited Shawl-necked Game-cock into the yard. The immediate consequence of this was the fecundity of the eggs, almost every one hatching that was set, the rearing of almost every chicken, and the replenishing of the yard with a fine robust stock of beautiful young birds, possessing the valuable qualities although somewhat lessened size of the Dorking, with the vigor, hardihood, and fecundity of the Game. Selecting our best pullets, we disposed of the Game-cock, for he was a pugnacious rascal, we brought back two or three young Dorking cocks, bred from a part of the old stock at another yard, to which we had removed them, as we still wished to retain a preponderance of that blood. Last year we raised over a hundred as good chickens as ever graced a barn-yard, yielding as fine, delicate, and juicy flesh as the original Dorkings. They are abundant layers, of good size, beautiful plumage, and altogether, please us exactly. How long we may keep them so, is to be tried, as they are mongrels; but alternating between the Game and Dorking, as necessity may appear to demand—and wanting no others so long as they breed satisfactorily—we hope to keep them as they should be."

The chief points of merit in a Dorking may be briefly stated as a broad, deep breast, broad, square shoulders, short legs, with, in the hens especially, a well-rounded stern.

A cock is about at his *best* at two years old, and still excellent at three.



LITH. OF ENDICOTT & CO. N. Y.

GREY DORKINGS.

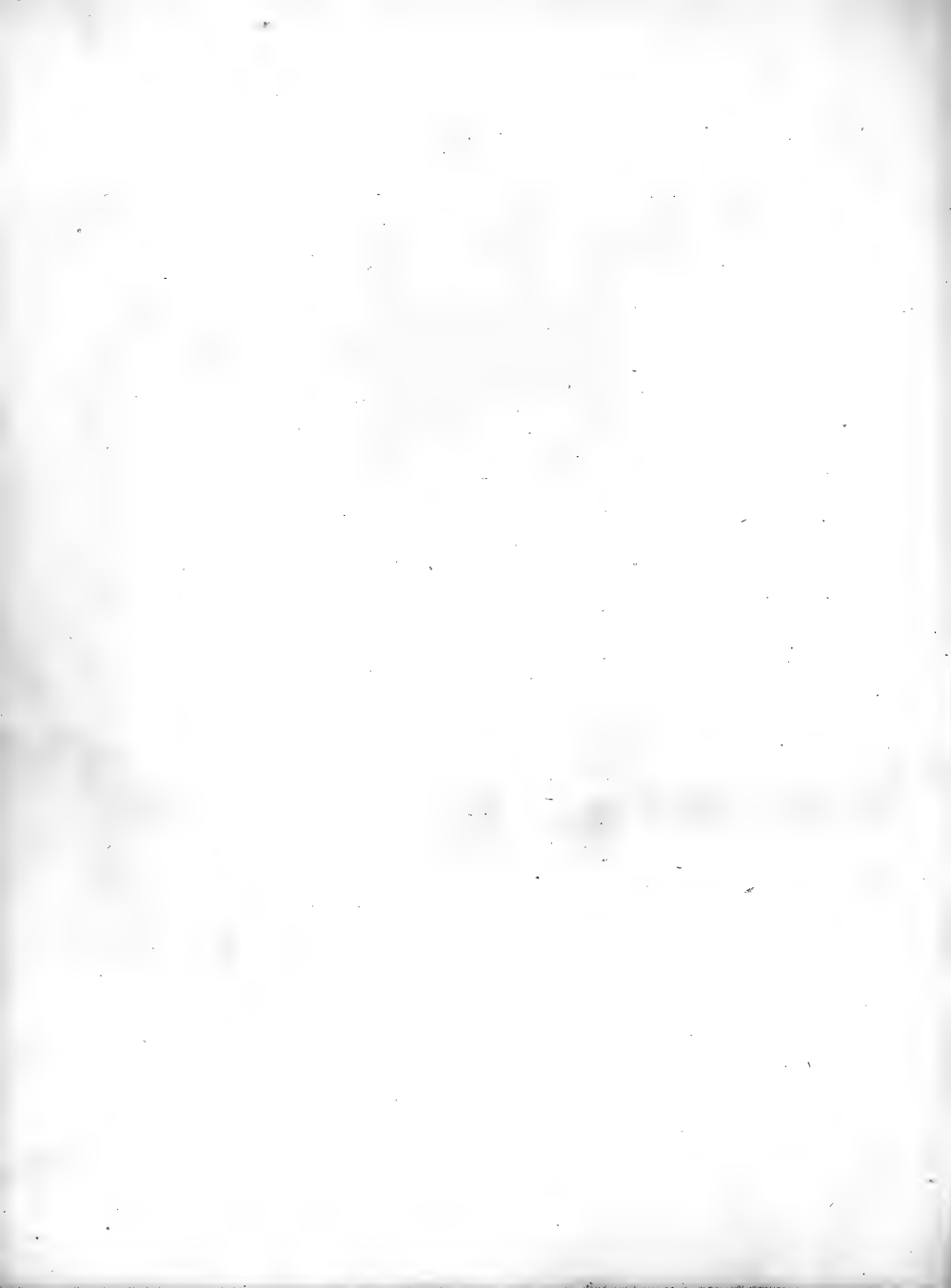

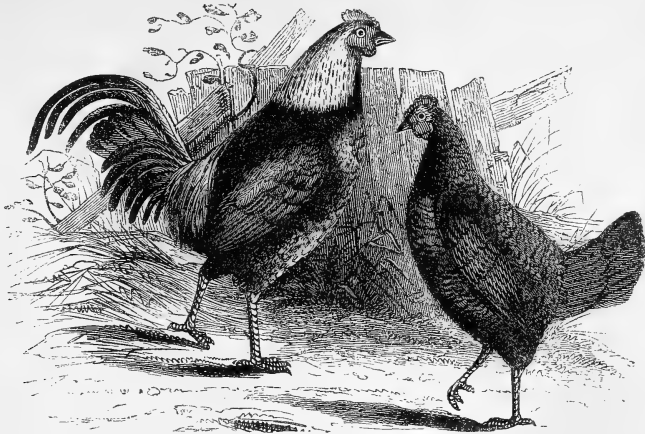

THE BUCKS COUNTY FOWL.

## THE BUCKS COUNTY FOWL.

This breed was first brought into notice in Bucks County, Pennsylvania—hence its name. It has little to recommend it except great size. The hens lay a few large and well-flavored eggs of a dark cinnamon color; but are great eaters, poor layers, and miserable sitters, seldom laying more than twelve or fifteen eggs before they become broody. They are only profitable to breed for making capons, which are sometimes sold in the market, weighing from eighteen to twenty pounds the pair, and sold at from \$5 to \$6. We bred them for two or three years, and then discarded them as unprofitable.

In corroboration of our opinion, we give the testimony of others. Thomas P. Hunt, in the *New England Farmer*, says “the large Bucks County hens, weighing as much as the Malays, are not good layers, and they are very apt to have double yolks.”

Thomas P. Thurlow, of Pennsylvania, who has paid considerable attention to poultry, in a letter to the author says, “As far as I am acquainted with the Bucks County breed, they would not do for layers, as they very seldom lay more than ten or twelve eggs at a litter. They are profitable to breed from, provided you can

make capons of them. They are often sold in the Philadelphia market at from \$4 to \$5 per pair, but they eat a great deal more than the common fowls.”

This breed of fowls have received some celebrity in the vicinity of Philadelphia as a valuable variety of fowl, principally on account of its great size. “I have seen many specimens of the Bucks County fowl,” says L. F. Allen, “paid some attention to its habits, and learned from those who have tried them, their principal merits. It is a large bird, weighing at maturity eight, and even ten pounds; rather thinly feathered, of various colors, from gray to black, and frequently speckled black and white. They are coarse in their legs, tall and bony, and have evidently a cross in their composition. They are but moderate layers; their eggs large and good. They are bad sitters, frequently breaking their eggs, on account of their great weight and size, by crushing them; are not hardy, and, on the whole, will not compare with the common farm-yard fowl for ordinary uses. They do not breed *equally* in size and appearance, showing them evidently to be a cross from other breeds; but from what they are derived, other than the Malay [the Cochin and Shanghai were then unknown in this country], it is difficult to say.

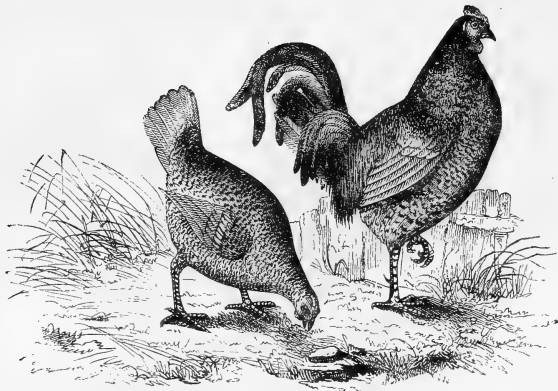

THE OSTRICH FOWL.

## THE OSTRICH FOWL.

This valuable variety, it is said, originated in Bucks county, Pennsylvania, and are called by some "Booby fowl," by others "Bucks County," or "Ostrich fowl." The specimens from which our portraits were taken were presented to the author by Dr. Eben Wight, of Boston, who informed us he procured them from Maryland, where, they are known as the "Ostrich fowl." In a letter accompanying the fowls, he says: "This breed are the largest of fowls, and from them you will obtain the largest-sized eggs. I have had eggs from this breed weighing 4 ounces avoirdupois weight. I could have sold fifty pair if I had them to spare." We found the above in regard to the size of the eggs correct; but since the introduction of the Cochin and Shanghai fowls they would not be considered the "largest of fowls," their weight being only from 5 to 7 pounds after being dressed. Dr. Kittridge, of Portsmouth, New Hampshire, however, says, "the cocks, when full grown, are represented to weigh from 9 to 10 pounds and the hens from 7 to 8 pounds live weight." He also says "some of their eggs weigh over 3½ ounces each, and measure 3 inches in circumference." We have had one that measured 3¼ inches in circumference and 7¼ lengthwise over the egg.

The color of the cock is a dark blue-black, with the ends of his feathers tipped with white; wings tinged with a bright yellow, or gold color; hackles dark glossy-blue; double or rose comb, and wattles large; legs dark; a bold, lively carriage, and a stately walk.

The hen does not differ much from the cock in color or form, being deep, short, plump, and thick-set in body; legs short and of a dark color, and of medium size; she has a single comb, serrated, generally falling over on one side, like the Spanish hen; wattles large and brilliant.

This breed of fowls has one peculiarity which we have discovered. When first feathered they are very dark colored; the white tips are quite small, and on moulting the white increases, and continues to increase with every successive moult until the white predominates. They are esteemed good layers, and, for a large breed, good sitters and good mothers; sometimes lay from forty to fifty eggs before they show any inclination to sit; eggs large and nutritious; the flesh, unlike that of the Malay or Shanghai, white, firm, and fine flavored. In many respects they resemble the Dorking, and we consider them fully equal to that famous breed.

We are under particular obligations to Dr. Kittridge, of Portsmouth, for the following information regarding the "Booby fowl," which

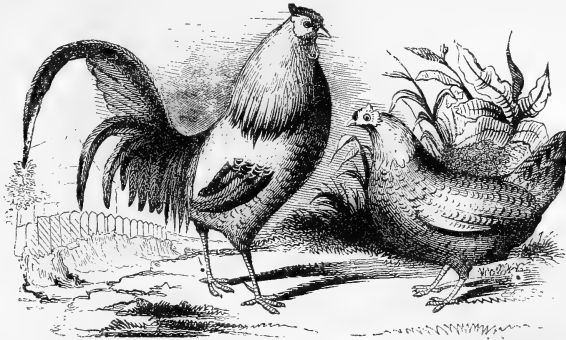

THE BOLTON GRAYS.

from his description, appears to be the Ostrich fowl under a different name: "Booby is a large fowl, weighing from 6 to 9 pounds. Of those that I received, the smallest weighed 6 pounds, the largest  $7\frac{1}{2}$  pounds; the cock 9 pounds. These, of course, were live weights. Their invariable color is a black ground with white spots all over them; the legs are black; they are shaped like a turkey; they are great layers, and are not so much inclined to sit as the common hen; laying forty or fifty eggs before they are broody. I procured mine from Pennsylvania."

In a letter from a gentleman in Philadelphia, who procured these fowls for the Doctor, he says, "I shall send two lots of fowls, a cock and three hens each. The Boobies are speckled, and were furnished by a German, and are no doubt a year old. There will be one hen with these that the good honest man said was much superior, and for which he was offered two dollars on his way to the city. He had no name for this fowl, but said these are the greatest fowls ever seen in our part of the country."

The editor of the *New England Farmer* says, "We have received from our friend Dr. Kittridge, of Portsmouth, New Hampshire, six Booby hens' eggs. These hens are considered as the greatest of layers by those who have kept them; and it appears that those which Dr. Kittridge has have laid well after getting over the effects of traveling. Owing to their being moved, they did not lay much for fifteen days; then

they (four in number) laid thirty-six eggs in ten days, and none showed a disposition to sit excepting one, which he thought not of the Booby breed."

The *Portsmouth Journal* gives an account of two varieties of hens of more than three times the common size, and of proportionate value, which can be as easily raised as the common hen. "They have been raised," says the editor, "by Dr. Kittridge, of that town, are called Boobies, and are speckled. The cock weighs ten pounds, and some of the hens eight pounds. They are prolific layers. Some of these eggs weigh over  $3\frac{1}{2}$  ounces each, and measure 3 inches in circumference."

THE BOLTON GRAYS.

This variety of fowls derive their name from having been extensively and superiorly cultivated in and about Bolton, England. From the intermixture of black and white, they are termed by some "Creole fowls;" at the present time they are denominated in England "Silver-penciled Hamburgs," because many of them are imported from Holland.

Both sexes of this sub-variety are characterized by a compactness and neatness peculiarly their own. Their color and size so nearly corresponds with the silver pheasant, that they are sometimes crossed with that beautiful bird. The cock has a full bright-red rose comb, about three quarters of an inch wide, erect, though low on

the head, and regularly pointed, but terminating in a single point behind, which should extend far back and consequently upward; ear-lobe, white and large; wattles large, round, and red; head small and fine; beak, short and white; plumage entirely white, with the exception of the wings and tail; the wings barred very regularly with black; tail ample, very erect, measuring nine inches to the top of the highest curve of the sickle feathers, which are of great length, and with the rest of the tail feathers of a highly iridescent black, their edges only being lightly margined with white, silvering, as it were, the whole plume. Mottled feathering is objectionable in the tail; but comparatively few birds attain the more perfect form described and figured on page 131. They are about sixteen inches high, and weigh about 4 or 4½ pounds.

The hen displays the peculiar markings which characterize this sub-variety much more distinctly than her mate, and as the penciled feather is strictly applicable only to the Bolton or Silver Hamburg variety, we may here give a specimen feather. The ground color must be

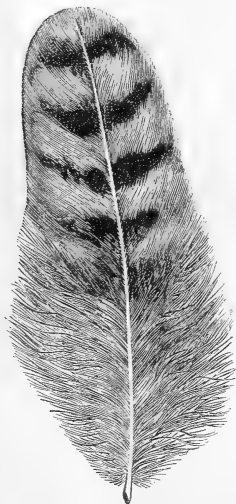

clear creamy white, and marked with at least four parallel transverse dark bars, as if an art-

ist had worked them in with a black-lead pencil. The hen's head is very small and fine; comb, double-rose, shaped like that of the cock, but very much smaller; ear-lobes, white; eyes in both sexes large and prominent; neck-hackle creamy white, without a black feather; the rest of her plumage, even to the tips of the tail-feathers, regularly penciled throughout; the tail feathers often have a broad black tip; legs and feet pale blue, and perfectly clean and featherless; nails white. Under the belly is often white, but the less of this the better. Spangled feathers mixed with the white is very objectionable—as is also that confusion of coloring or sprinkling of black among the white, which we should suspect first obtained for such specimens the designation of the "Silver Moss fowl;" a bird whose penciling has run or become blended with the ground color, conveys a good representation of the erratic growth of moss or sea-weed. Weight of hen about 3½ pounds.

Mowbray, to whom the merits at least of originality and practical knowledge ought to be conceded, appears to have been acquainted only with the English stock of this breed. He says of the Bolton Grays: "This variety, apparently the crack breed of their vicinity, but entirely unknown in the metropolis, is described by the Rev. Mr. Ashworth, near Bolton, Lancashire, as follows: small-sized, short in the leg, and plump in the make. The color of the genuine kind, invariably pure white in the whole lappel of the neck; the body white, thickly spotted with bright black, sometimes running into a grizzle, with one or more black bars at the extremity of the tail. They are chiefly esteemed as very constant layers, though their color would mark them for good table fowls."

The Bolton Grays, when bred to a nicety, can scarcely be distinguished from each other when apart; and when so bred, there is not a more beautiful fowl among our domestic poultry.

They are rather impatient of confinement, and succeed best when they can have the run of a clean pasture or common. Seven feet fences, where they are intended to be confined, will not be more than sufficient height for their safe custody.



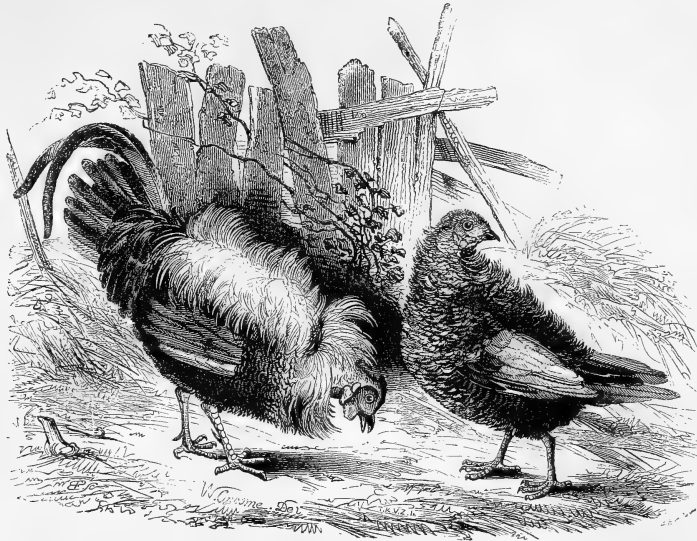

THE FRIZZLED FOWL.

The hens, if young, continue to lay nearly throughout the year, which entitles them to rank among the best egg-producers; but the eggs, which are white, are small, weighing only about  $1\frac{1}{2}$  ounces each. As they seem to have no desire to sit, it is advisable to hatch their eggs under a common hen.

#### THE FRIZZLED FOWL.

This fowl, more curious than useful, is said to be a native of Japan, and other parts of Eastern Asia, and is frequently called the "Frieze-land fowl," from confounding the proper term *frizzled* with Frieze-land. Captain Steadman has observed, in his "Voyage to Surinam and the interior of Guiana," that the natives rear a very small species of fowls whose feathers are ruffled, and which seem to be natives of that country.

"This fowl," says LAYARD, in a letter from Ceylon, "is called by the Ceylonese *Caprikukullo*. It is found here but rarely, and the natives say they came from Batavia." Sonnini and Temminck agree that it is a native of Southern Asia;

but that it is domesticated, and thrives well in Java, Sumatra, and all the Philippine Islands. It is the *gallus crispus* (Frizzled fowl) of Brisson.

Martin says, "this breed is originally from Eastern Asia, and is often seen in Java, Sumatra, and India. It is a new variety, and not a distinct species, as some have supposed." It is occasionally met with in this country, but is not common. It is called by some "French fowl." It takes its name of *frizzled*, from the feathers—with the exception of the tail—being turned or curled toward the head, giving the appearance, as has been facetiously remarked, of having been "drawn through a knot-hole." Here, at the north, our climate is even too severe for the grown fowls. They are tender—the feathers do not afford protection against wet, and they are unable to bear exposure. "The open, ruffled appearance of their feathers," says another writer, "suggests the opinion that they must be unsuited to our climate; but those best acquainted with them inform us that they are hardy, and do not suffer more than other fowls

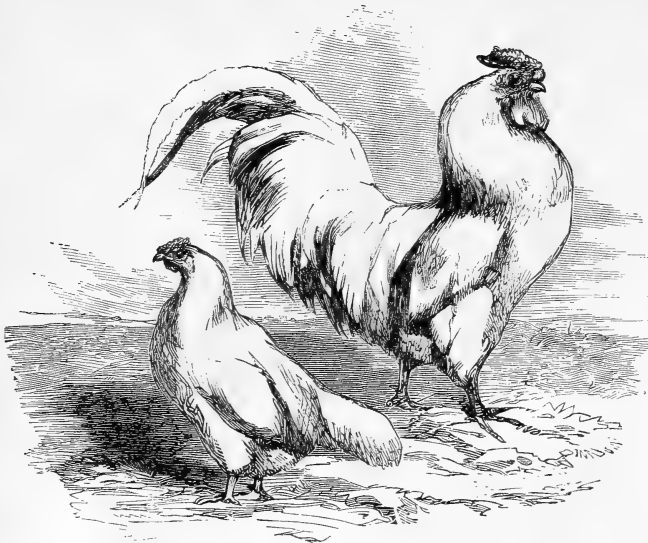

THE SILKY FOWL.

from the weather of this country. They have the power, it seems, to bring their feathers close together during the occurrence of rain.

*Characteristics.*—Temminck states that the prevailing color of the wild race is white, and that in these the legs are smooth; but there are many specimens variously colored with black and brown, and some of them have feathered or booted legs.

The cock has a beak much hooked; hackle slightly tinged with yellow; comb cupped and toothed; ear-lobe white; feathers over the entire body white, and projecting from being curved back from the body, so as to give the bird an appearance of being ruffled, and of having its feathers rubbed in the wrong way; tail ample and well sickled; legs bluish; height 18 inches; weight  $4\frac{1}{2}$  pounds.

They are not good layers, and their eggs average little more than 2 ounces in weight. The hens are good mothers, and the chickens are hardy. Though small, they are good table fowls.

The specimens from which our portraits were taken were presented to us by Dr. E. Wight, of Boston, and were of a brown color.

#### THE SILKY FOWL.

This is one of the accidental varieties that now and then break out in most yards, which Temminck describes as a distinct species. By modern writers it is also considered a species rather than a variety. It is of good size, and the whole body is covered with feathers, the webs of which are disunited somewhat in the manner of some of the feathers of the ostrich, the emeu, and the peacock, and appear somewhat like hairs and glossy silk.

Allusions to this bird are frequent, both in the works of the older writers on the poultry-yard, and in the early travelers in China, Japan, and some parts of India. The extreme singularity of their appearance would probably attract observation where the far greater merits, in an economical point of view, of the Malay

or Shanghai were disregarded. "Anomalies have been called," says Browne, "finger-points that point the way to unsuspected truths. Hence the strange irregularities which we often meet with in our domestic fowls better deserve the attention of naturalists than any favor of poultry-keepers. They may safely be pronounced worthless as a stock, and have a more appropriate place in the menagerie or museum than in the poultry-yard."

Temminck states in general terms that the Silky fowl is a native of India. But Mr. Blyth states more specifically, "the only Silky fowls I have seen here (Calcutta) were from China, or Malacca, or Singapore; the latter with single red comb and wattles; the former with complex rose comb, blackish, I think, and a very short, stubby beak, and a quantity of glaucous blue skin in place of wattles, imparting a most remarkable appearance."

By some writers on poultry, the Silky fowl has been indiscriminately mixed up with the Bantam, although the distinctive character of their figure, no less than plumage, would suggest the propriety of assigning them a separate chapter.

This is the breed which gave rise, in 1776, to the fable of the "Rabbit fowl," which was exhibited in Brussels, as the produce of a rabbit and a common hen, which was merely a Silky fowl of Japan. It is said that Buffon was for a long while teased by letters from two pretended naturalists of Brussels, one of whom was a prebendary, and the other a Jew merchant; they were continually writing to him in order to convince him of the existence of the Rabbit fowl. Buffon had answered several times by arguments that proved the impossibility of such a disproportioned connection. Their credulous obstinacy at last put him out of temper, and he silenced them by a joke too bad to be inserted here, but which rid him forever of the importunity of the Jew and the prebendary.

Some of this description of fowls were imported into England a few years since from Calcutta, and they, with their progeny, proved equal to the climate of the southwestern districts of England. Some, however, which were sent into Lancashire suffered so severely that the

attempt to keep them was abandoned. From the peculiar character of their plumage they are not calculated to endure a low temperature or excessive moisture.

This breed is said to be indigenous in Japan, where it is much prized, and is also found in China, where they are frequently offered in cages for sale to foreigners.

*Description.*—Their most usual color is white with a black skin, and their bones are also covered with a dark pigment. The feathers have their web separated from the point of the junction with the shaft, so that their covering seems of hair rather than that which is ordinarily allotted to birds. The tail feathers, in good specimens, should resemble fine gauze, for here their texture is closer than on any other part of the body; the tail itself is short—little more developed, in fact, than that of the Shanghai—but a sickle tail, such as is represented in the figure, is not unfrequent; in these too, the comb is carried back farther than is common.

The comb is usually depressed, approaching in form to the Malay; but variations in this respect are frequent, and single combs with those of an intermediate character are by no means uncommon—the one first mentioned, however, is the best form; its color, with that of the wattles, is a dark crimson, frequently becoming a dull leaden hue; the face being thinly covered with feathers shows his dusky complexion, which is still farther brought into relief by a white earlobe, often tinged with light blue; of this latter color are the legs, which should be heavily feathered. Individuals of this sort differ in respect to color, as in other varieties; some are pure white, and others of a dingy-brown, and all of them with dark colored legs, nor are the legs always feathered.

There is another spoken of as a distinct variety—the "Yellow Silky fowl," but its origin is supposed to be a cross between the yellow Bantam with the white Silky fowl; chickens have been bred of several colors, blue, spotted, and various shades of yellow. By the intermixture of yellow blood, however, the bright blue leg was lost, which is a good feature in the white birds.

We have known several instances of fowls of this description, having sprung from those

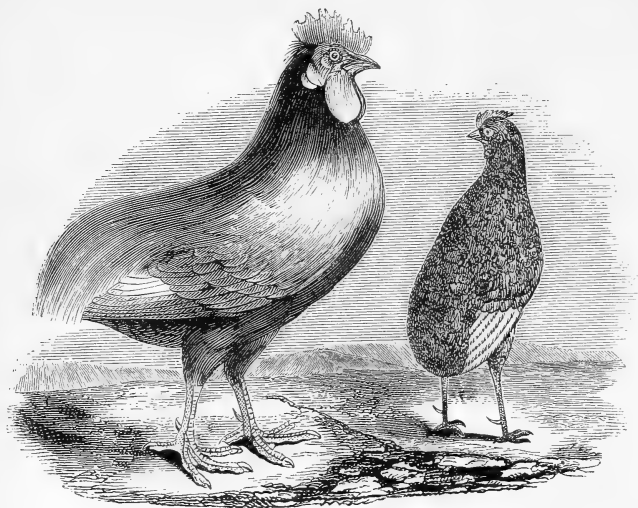

THE RUMPLESS FOWL.

of the ordinary character. They are tender, and more difficult to rear than the other varieties, owing probably to their destitution of the common feathers.

#### THE RUMPLESS FOWL.

This is the "Rumpless or Persian cock" of Latham, and the "Rumpkin or Tailless fowl" of others.

Among the monstrosities of the domestic fowl which are particularly curious, and worthy the attention of the student of nature, may be mentioned the Rumpkin or Tailless cock, believed at present to be found in its wild state in the Island of Ceylon.

Some writers, among whom is Temminck, consider this bird a distinct species rather than a variety; that it is a wild breed, a native of the Ceylon forests, and is called by the natives *Wal-kikilli*, or "Cock of the Woods." But Mr. Layard, writing from Ceylon in 1850, says, "The Rumpless Fowl is not a wild inhabitant of this island, in spite of M. Temminck. It is a rather rare tame introduction from Cochin, I am told.

It may appear like boasting, but I can confidently say I am more acquainted with the Ceylon Fauna than any man living, and if the bird had existed wild I must have seen it. *Wallikikilli* is the name for the female of *gallus Stanleyi*, meaning literally, *Walli*, jungle, and *kakilli*, hen."

This bird is looked upon by some to be a native of Persia. Buffon thinks, on the contrary, that Virginia is the place whence it sprung. He grounds his opinion on the one hand, on what is reported by the Philosophical Transactions of 1693, that when fowls are led to that country they seem to lose their rumps; and on the other, on naturalists having only begun to mention fowls without tails after the discovery of America. "I am not of that opinion," says Main, "which appears not admissible. In fact modern travelers have not confirmed the loss of the rump which the English experience in Virginia, and it is positively known, that in the wild parts of America, in the hottest even, this privation does not take place."

Blaine, in his "Rural Sports," says, "Of the

feathered tribes of Ceylon, the most remarkable is the *Tailless Cock*, at present, we believe, only known in its wild state in the forests," etc.

If the Rumpless fowl be really a remnant of the original Fauna of Ceylon, it will be a pity if it be suffered to become extinct, although it be one of Blumenbach's defective monsters.

"It is hardly possible," says Blaine, "to cavil at Temminck's evidence of its existence in Ceylon." In reply to Buffon's fairy tale that cocks, when transported to Virginia, lose that portion of their person on which the tail grows—a romance that seems to have imposed on the sober Dr. Latham—he says, "We can positively state that Buffon's opinion has not been confirmed; this Rumpless cock was not originated in the New World, since the primitive species inhabits the Island of Ceylon. The hen makes her nest on the ground; it is rudely constructed with fine grass, and resembles the nest of the partridge. The disposition of this bird is wild; the cock utters his crow, which, though less sonorous than that of our domestic cock, has still the same cadence. The Cingalese designate this species by the name of Wallikikilli; which means 'Cock of the Woods.'"

Aldrovandus describes the cock as black, interspersed with yellow streaks, and the chief wing feathers white, the breast white, and feet ash-gray. The hen has a smaller comb than the cock, and is of a rusty color except three black feathers in each wing.

Mr. Dixon remarks that "the cock which they call Persian differs from our own sorts mainly in having no tail; in other respects it is very much like them. The cock, however, has a sort of tail, as shown in one of the portraits on the opposite page. It was all black, sprinkled with yellow lines; the first quill-feathers were white, the rest black; the feet ashy. The hen was like our own with respect to carriage, and of extremely different color from the male, whence I attach little weight to diversity of color, except the three quill-feathers, which were black. Her comb, if you can compare it with the comb of the male, was much smaller.

"In the very light breeds the hen is white, with yellowish neck-hackles; rose comb; slightly grizzled tail; and legs bluish-white as in

the cock. Height about fourteen inches, and weight rather under five pounds. Their eggs average two and a half ounces each in weight, but they are no better than the common fowls as layers."

Hens of this species are without the caudal feathers, as well as all the coverts, which in other birds are planted on the rump; the cock of this species is also distinguished from the others that we have described by having his comb round, and without indentations. "I am unacquainted," says Blaine, "with the colors of the primitive female of this rare species, the Governor of Ceylon, to whom I am indebted for information respecting this wild cock, having sent me only a very old male, and a second individual, male also, at the stage when the comb and wattles begin to show themselves. These individuals have the same distinctive characters, and the colors of their plumage absolutely correspond. The different domestic races of this species are distinguished by different colored plumage: most of the cocks have indented combs like those of our farm-yard fowls; others have also the double comb." In all the specimens we have seen the comb has become either single or serrated, but nearly as often doubled—another proof of changes by domestication.

Aldrovandus's Rumpless cock is represented with a large double comb, that is protruded backward like a tail. They are not small, being at least of the average size of fowls. No information is given as to their laying or sitting qualities.

Mr. Nolan, of Dublin, gives them this faint praise: "I consider them rather a superior description of fowl; and the hen-wives who mutilate their stock, both cocks and hens, by depriving them of their tail, can not object to the Rumpless, as they are perfectly unincumbered by that appendage."

We have never before heard of the cruel, and we might say brutal practice of cutting off a fowl's rump. It certainly does not add to its beauty when alive; and we do not think that many would be found who would torture it when living, merely to make it look more compact when on the table. Nor do we imagine it would take less food to sustain it.

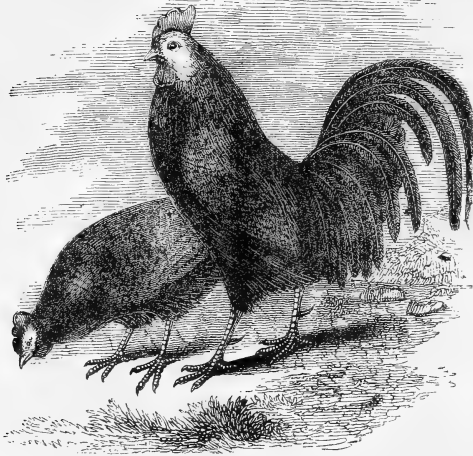

SPANISH FOWL.

#### THE SPANISH FOWL.

Of this beautiful and noble race of fowls until recently few specimens have found their way into this country. They possess very striking characteristics in their large single comb and white face; and however these features have undergone changes, either from breeding "in-and-in," or the admixture of other families, we have usually sufficient evidence of their origin, even when disfigured by illegitimate alliances. At the period of Mowbray's writing it appears to have been scarcely known.

Dixon, in his "Ornamental Poultry," remarks: "The Spanish breed is, in all probability, of ancient and remote origin, and does really seem to have reached us from the country after which it is named."

The name Spanish is said by some writers to be a misnomer, as they were originally brought by the Spaniards from the West Indies, and although subsequently propagated in Spain, it is now very difficult to procure good specimens from that country. They were taken, in considerable numbers, from Spain into Holland,

where they have for many years been bred with great care; and it is from that quarter our best specimens come.

The introduction of the Spanish fowl, therefore, into Holland and the Low Countries may be reasonably assigned to the period when the latter territory belonged to Spain, and constant intercourse was maintained with the peninsula by the commercial habits of the Dutch nation.

The names by which many of our domestic poultry are at present known to us, so far as they are indicative of their native country, are frequently matters of discussion. That Poland gave us the tufted bird, so remarkable an ornament to our yards, or that the Hamburgs were originally of German extraction, the evidence that we now possess has not yet certified; but with Spanish the case is different; though possibly the wider term of the "Mediterranean fowl" might be still more applicable.

From Gibraltar to Syria—north and south—the countries that border on that vast inland sea, with its numerous islands, abound with fowls that bear such resemblance to the Spanish race, in the striking points we have alluded to, as may

warrant our assigning them to one common stock. Names, also, that denote some subdivisions of this family, strengthen our conclusion; for the *Anconas* and *Minorcas* derive their designations from localities that carry us far beyond mere Spanish boundaries.

We copy the following description from Martin, who seems to hold this breed in high estimation: "Like the Black Poland, this breed is clad in glossy sable plumage, but is not crested with a top-knot; on the contrary, the comb is remarkably large, single, and often pendent on one side; the wattles are extremely developed, and the skin below the ear on each cheek is white, contrastingly strongly with the scarlet of the comb and wattles, and the glossy black of the plumage. The cock is a noble and stately bird, remarkable for size and height: it is in fact superior in stature to all our domestic races, if we except the Kulm, or Malay fowl, and at the same time it possesses excellent symmetry. The hen is also of good size and good figure. Brought originally, as it is believed, from Spain, this breed is nevertheless very hardy, and is reared as easily as any of inferior importance. To those who breed fowls for the sake of the flesh and eggs, this fine variety can not be too strongly recommended. The flesh is delicately white, tender, and juicy, and the hens are free layers. Some persons complain that the hens are far better layers than sitters. Their peculiar disinclination to sit is very remarkable, and is regarded as their most valuable characteristic; for, in our experience, we have been exceedingly annoyed by the constant propensity which some other breeds have manifested in this respect. The eggs are of very large size, and of first-rate flavor.

"Inferior cross breeds of this Spanish variety are very often to be seen; but such are not worth keeping. Let the pure strain only be adopted; it may be preserved from degenerating by the occasional introduction of males of the same race, and up to the mark in every point, which have descended by a collateral branch from the same root, and which have, therefore, only a remote connection with the stock to which they are admitted. It is thus that breeders may often benefit each other by mutual exchanges."

*Varieties.*—The varieties of the Spanish breed consist of the white and those going by the name of "Minorcas," which have neither the white face nor high-bred carriage of the pure bird. To these we may add the "Andalusian," lately introduced and exhibited in England.

The "Minorcas" are very common in Devonshire and Cornwall, England, though by no means limited to these counties. In the western parts of Cornwall especially, birds of this variety have long been valued as first-rate layers, and for some years they formed the one principal stock of the yards. The milder temperature of the south of England would offer peculiar advantages to the successful management of these fowls, which manifest impatience of severe cold.

A pen of white Spanish fowls were exhibited at Birmingham in 1852. "But," remarks a writer on the subject, "regarding the striking contrast of jet-black plumage, the coral comb, and the white face, as constituting the great beauty of the Spanish family, we can accord but limited approbation to this variety, where both cheek and comb are sadly compromised by the substitution of so unfavorable a color for their mutual relief. I have known white Spanish bred from black birds, but their offspring have been black again."

Cocks will average 7 pounds, while the hens may be stated at about 5½ pounds. Pullets hatched in April commence laying in October, and continue throughout the winter. Two pullets and three hens, it is said, averaged 120 eggs each in the year. The hens seldom show any desire to sit; but when this does happen, they prove themselves excellent mothers. The chickens are feathered early, are hardy, and very precocious. As a table fowl, they are considered full equal to the Dorking. "But when we come to speak of Spanish as layers, our award of praise," says a breeder of them, "can hardly go too far, either as to the actual number of eggs laid or their aggregate annual weight."

As regards the Spanish hens as layers, a writer in the "Poultry Book" says: "The hens commenced laying the last week in January, 1852, and continued laying two days, stopping one, down to the middle of November. They lay,

in my opinion, ten months in the year. The average weight from old hens is  $2\frac{3}{4}$  ounces." Another writer remarks: "As for eggs, I reckoned last year (1852) that my Spanish hens laid six days a week from early in February to late in August (they moulted in July). Between November and February they averaged, perhaps, three eggs a week. I consider them to be nearly (not quite) as good layers as my Shanghais, but very superior in the weight of the eggs, which are large and handsome; broad, but slightly rounded at each end; one end, however, is not so much more pointed than the other, as in some fowls. As for weight, I am cautious in speaking. I know that last year, from February to August I considered their average weight to be above  $3\frac{1}{2}$  ounces, but under 4 ounces. The largest were in May, many of them weighing  $4\frac{1}{2}$  ounces; but the average of those laid in December and January I should place at  $2\frac{3}{4}$  ounces."

The color of the Spanish egg never varies; it is clear white, with a smooth, polished surface. In selecting such as we desired to sit, we should follow the same rule as with Shanghais. Pullets are commonly found to commence laying from five and a half to six months old, and they certainly may be described as good layers, save only in the severe winter months. With regard to a tendency toward laying soft or unshelled eggs, it is the same to which all great layers are naturally subject.

Chickens are marked with a soft blue-black down, with white on the face, throat, and breast; and when feathering begins there is usually a longer interval than we wish between the casting off of the one covering and the assumption of the other. They are longer coming to maturity than other young poultry; they suffer much during the growth of their quill feathers, frequently pining away and dying at that period in spite of every attention.

In the habits of the Spanish fowl there is nothing peculiar to require notice; they are not, it is true, so quiet and disinclined to roaming as the Shanghai; but if well-fed at home, they will not be found to stray far from their walk. Nor are they quarrelsome among themselves to a degree at all troublesome.

*Characteristics.*—The thorough-bred Spanish fowl should be entirely black, as far as feathers are concerned, and when in high condition display a greenish metallic lustre. An erect brilliant scarlet comb, serrated; with a clear milk-white face and ear-lobes; dark-blue legs; and a lofty carriage. Wattles of the hen small, but large and very conspicuous in the cocks, and, like the comb, of a light scarlet. This marked contrast of black, bright-red, and white, makes the head of the Spanish cock as handsome as that of any other variety; and in the genuine breed the whole form is equally good. The cock-bird should be strong and short in the legs as possible; his back from tail to neck short, tail large and ample. He should weigh not less than six pounds; the head is rather large, the spurs long and sharp, and the bearing and carriage proud and high. The face should commence from where the comb joins on the head, and must extend downward over and around the eye till it meets the white ear-lobes.

Spanish hens are also of good size and good figure, and are celebrated as good layers, producing very large white eggs. The head of the hen should be neat, and of moderate size; eyes bright; comb single, very large and pendulous; face entirely white, the white extending round the eye; neck of moderate length, neatly set on; body broad, wings of middle size; legs a bluish-white; tail long and well squared; plumage of a glossy black, with brilliant tints of green and purple, as in the cock, but less brilliant. Her weight should not be less than five pounds. It must be especially observed that the slightest approach to coarseness, in either cock or hen, must be discountenanced, even at the expense of size; for in no class of fowls is quality more requisite and more appreciated than in the Spanish.

It can not be too strongly impressed upon breeders, that the purely white face is the most arbitrary rule in judging fowls of this breed, and will cover many trifling deficiencies. Of course the plumage should be black, without mixture of any other color.

Although cocks at seven months, and pullets at ten, ought to give promise of what they will be when they come to maturity, yet we should





LITH OF ENIGCOTI CO. N. Y.

BLACK SPANISH.



not advise too much haste in forming a judgment and condemning those that are not apparently perfect, as many, and more especially pullets, are from eighteen months to two years in becoming really white, and it is undeniable that the Spanish hen improves up to three years old.

It has been noticed that this variety of fowl frequently loses nearly all the feathers on the body, besides the usual quantity on the neck, wings, and tail; and if they moult late and the weather is severe, they feel it much. Nothing else can reasonably be expected to take place with an "everlasting layer." It often happens to the Guinea fowl; and the reason of it is plain. If the system of a bird is exhausted by the unremitting production of eggs, it can not contain within itself the wherewithal to supply the growth of its feathers. The stream that will fill but one channel can not be made to keep two at high-water mark; and therefore Mr. Leonard Baker, an English writer, justly observes: "With regard to our anxiety about their constant laying, in my opinion nature ought not to be forced, as it requires a rest." But some people think it can not be right if their hens do not lay every day.

"It is doubtful," says Browne, "whether they would readily become acclimated in the northern part of the United States, for continued frost, at any time, much injures their combs; frequently causing mortification in the end, which has terminated in death. A warm poultry-house, high feeding, and care that the birds do not remain too long exposed to severe weather, are the best means of preventing this disfigurement."

Browne also says a "cross between the pheasant Malay and the Spanish produces a particularly handsome fowl, and probably very much resembling the old Hispanic type." Valuable stocks have originated by crossing with other varieties.

Some very perfect specimens of this breed were exhibited by Mr. J. P. Childs, of Woonsocket, Rhode Island, at the New York State Poultry Society at Albany, in February, 1854, for which he was awarded a premium. Mr. J. Kellen, of Germantown, Pennsylvania, also exhibited some choice specimens of the same breed, and carried the first prize.

Mr. John Giles, of Woodstock, Connecticut, imported some of the Black Spanish Fowls, which were sold at Barnum's Museum, at auction, in December, 1854. They brought from \$5 50 to \$10 per pair, which was less than first cost.

#### HAMBURG FOWLS.

Whence this breed originated is not definitely known; some assign its origin to Hamburg or vicinity; others to Holland. Those places at the present time furnish the best specimens of these fowls, and we may, therefore, properly infer that if not originating, they have at least long been bred there, and brought to a high state of perfection.

It deserves our notice that all tradition, all our oldest naturalists, and even the names by which our fowls were originally called, all assign them to an Eastern origin. Even many of our modern names, Bantam, Malay, Shanghai, Cochín, and Brahma-poutra, point to a similar origin. Nor is the Hamburg fowl an exception, for its earliest describer, Aldrovandus, calls it "Turkish fowl." The white body, the black markings, the greenish-black tail, and the blue-tinged legs, are all characters which show that the old naturalist had before him specimens of the Silver Hamburg.

"Why it should be called the Hamburg fowl seems inexplicable," say the authors of the "Poultry Book," "except upon the supposition that the Levant merchants at Hamburg introduced them from Turkey or elsewhere, and that from Hamburg they were exported into England. By a similar transit did our Black Hamburg grapes derive their name; for they are certainly natives of Spain, imported by the Hamburg merchants, and first known to us as Hamburg grapes, because purchased by us there."

Wherever may have been its place of origin, or however its present name may have been derived, it would appear that the Hamburg fowl was among the occupants of the poultry-yard of our monasteries as early as the beginning of the fourteenth century, since Chaucer has described a cock in their possession which was evidently of the Golden Hamburg breed.

*Varieties.*—There are two distinct varieties; these being again subdivided into two each,

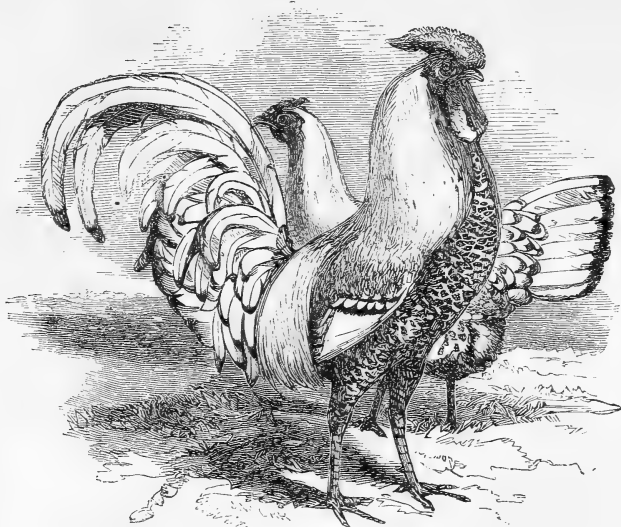

HAMBURG FOWLS.

distinguished by the ground color of their plumage. The first division into penciled and spangled fowls; the next into golden and silver penciled, and golden and silver spangled.

The Silver-penciled, known as the Bolton Gray, from being extensively and superiorly cultivated in and about Bolton, England, are considered the most beautiful, although probably no better layers than any of the other varieties. They are called Creole, from the intermixture of the black and white; Coral, because the numerous points of the polished, bright scarlet rose-comb bear no distant resemblance to grains of red coral; Penciled Dutch, because many are imported from Holland.

All Hamburg fowls, though scarcely of medium size, are plump, compact, beautifully formed and marked, which, added to their great reputation as perpetual layers, should commend them as general favorites. Their eggs are of a medium size; they are rather noted for long continued than rapid layers, and rarely known to sit. They are active, noisy, and impa-

tient of confinement; great foragers, though small consumers of grain; and when full liberty and a good range is afforded, they are undoubtedly a most profitable fowl. Some consider them delicate in constitution, but this can be obviated, in a great measure, by a little extra care when young, which will be amply repaid in the increased size of the fowl when full grown. There has been a great deal said by some about this class of birds not being winter layers. There must be bad management somewhere when this is the case. Hamburg pullets hatched in March or April, begin to lay in October, and continue until moulting again, and it is surprising what a number of eggs are produced.

They mature early, and are tender, juicy, and finely flavored. Few birds excel them for the table. The cocks weigh about  $4\frac{1}{2}$  pounds; the hens  $3\frac{1}{2}$  pounds.

#### THE SILVER-PENCILED HAMBURG.

This sub-variety is sometimes called the Penciled Dutch, because many are imported from

Holland; "Dutch every-day Layers," and "Everlastings," for the same reason, and their great productiveness as layers.

Both sexes of this sub-variety are characterized by a compactness and neatness peculiarly their own. The cock has a full, bright-red rose-comb, about three quarters of an inch wide, erect, though low on the head, and regularly pointed, but terminating in a single point or "pike" behind, which should extend far back and curve gently upward; ear-lobe white and large; wattles large, round, and red; head small and fine; beak short and white; plumage entirely white, with the exception of the wings and tail; the wings barred very regularly with black; tail ample, very erect, measuring nine inches to the top of the highest of the sickle-feathers, which are of unusual length, and, with the rest of the tail feathers, of a highly iridescent black, their edges only being very lightly margined with white, silvering, as it were, the whole plume. Mottled feathering is objectionable in the tail; but comparatively few birds attain the more perfect form described above. Height may be placed at sixteen inches, while an average weight would reach  $4\frac{1}{2}$  pounds.

The hen displays the peculiar markings which characterize this sub-variety much more distinctly than her lord; and as the penciled feather is strictly applicable only to the Hamburg variety, we give a specimen on the next column. The ground color must be either clear creamy white or coppery yellow, accordingly as the birds belong to the silver or golden classes, and marked in either with at least four parallel transverse dark bars, as if an artist had worked them with a black-lead pencil. The hen's head is very small and fine; comb double-rose, shaped like that of the cock, but very much smaller; ear-lobes white; eyes in both sexes large and prominent; neck-hackle creamy white, without a black feather; the rest of her plumage, even to the tips of the tail-feathers, regularly penciled throughout; the tail-feathers often have a broad black tip; legs and feet blue, and perfectly clean or featherless; nails white. Under the belly is often white, but the less of this the better. Spangled feathers mixed with the penciled are very objectionable, as is also that confusion of color-

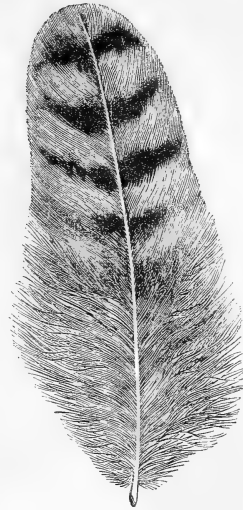

ing or sprinkling of black among the white, which we should suspect first obtained for such specimens the designation of the Silver-moss fowl. Such we say was probably the origin of the term as applied to the Silver Hamburgs, though, as it is well known, the fowl now called the Silver or Golden Moss is certainly the Silver or Golden-spangled Hamburg, which also bears the synonym of the Silver and Golden Mooney. A bird whose penciling has run or become blended with the ground color, conveys a good representation of the erratic growth of moss or sea-weed; hence the apparent derivation of the term, which it is evident becomes difficult of explanation when applied to any spangled specimen. Weight of hen about  $3\frac{1}{2}$  pounds; height about fifteen inches.

#### THE GOLDEN-SPANGLED HAMBURG.

The Golden-spangled Hamburg cock is a perfectly beautiful bird; nothing but a full-sized drawing, colored, can give an adequate idea of the extremely rich coloring and brilliant lustre of his plumage.

The Spangled fowls in their essential points are the same as the penciled. The same remark

may also be applied to their color; their markings, however, are decidedly different, one spot or spangle of clear black taking the place of the lines on the penciled birds.

The Golden-spangled Hamburg is also locally known as the Golden Pheasant, from the resemblance of its spangled feathers, especially in the case of some of the hens, to those of the cock pheasant. They are generally of a larger size than the Silver-spangled.

The comb of the cock is a very full-developed rose, about two inches broad, and running into a pike behind; wattles large, rounded, and, like the comb, of an intense red; ear-lobes white and large; hackle a rich copper, with black markings, though in some of the best specimens both hackle and saddle feathers are rounded, and have the perfect spangle at their extremity; wings barred by the spangle of their coverts; breast and back of the same bright coppery hue, deeply spangled; thighs and lower part of the body nearly black; tail full, erect, and bronzed throughout; legs and feet clean, and of darker color than in the penciled birds. They stand about nineteen inches high; and weigh on an average  $5\frac{1}{2}$  pounds.

The hen has a small rose-comb, shaped like that of the cock; ear-lobes white; with her body, the lower part alone excepted, spangled as in the cock. Her tail is full, and should be tipped black, like that of the Sebright Bantam. Height about sixteen inches, and weighs about  $4\frac{1}{2}$  pounds.

Such in particular are the colors of the Golden-spangled Hamburgs; but we must not pass them by without some farther encomium on the extreme brilliancy of their feather, from its rich combination of glossy hues. Their plumage is also compact and close, and in good specimens of the female bird attains a depth of tone seldom surpassed throughout the poultry-yard. The only comparison that does it justice may be found in the bloom of a thorough-bred bay horse in racing condition.

#### THE GOLDEN-PENCILED HAMBURG.

The Golden-penciled Hamburg varies chiefly from the Silver-penciled in having a yellowish buff or yellowish bay ground color in its plu-

mage, where the latter has white, and in being rather larger. "This is the only variety of Hamburgs," says Mr. Bond, "that has not been extensively bred among the Yorkshire fanciers." This is the more unaccountable, because we never heard that they are inferior in useful properties to their Silver relatives, and to most tastes are at least their equals in beauty. In one district of Lancashire both of them are kept to an extent which procured for them the names of Bolton Bays and Bolton Grays, as we have noticed of the Silver. The Golden-penciled have also been known as Dutch *every-day Layers*.

The cock has a rose-comb about an inch and a half broad with points of uniform height, and with a pike reaching far back; face well crimsoned round the eye; ear-lobe white; neck-hackle ginger or reddish yellow; upper wing-coverts, saddle-feathers, and breast light Vandyke brown; thighs brown; tail black, with a bronzed tint upon the feathers, well sickled and very ample for the size of the bird. In good specimens, when placed in a strong light, a succession of parallel transverse markings of a penciled character are distinctly visible on the tail-feathers; legs blue. About eighteen inches in height, and about five pounds in weight.

The hen has a rose-comb rather larger than in the Silver-penciled; face paler than in the cock; ear-lobe as in the cock; neck-hackle yellow buff, but not so free from stains as the Silver-penciled; breast, wings, and back, brownish buff, accurately penciled with black; legs blue. Height about fifteen inches, and weight about four pounds.

There is a variety called "The Hen-feathered," and the cocks are marked very similar to the hen; no sickle-feathers in the tail; the spangles being larger and the colors more brilliant. They are a bright yellow-black and pale bright red-brown. The markings in this variety extend all over the body, wings, and breast. Those with the hackle-feathers are never so distinctly barred or spotted on the wings; some have the breast wholly black, but are not considered so perfect.

#### SILVER-SPANGLED HAMBURG.

These are rather larger and altogether more stoutly framed than the Silver-penciled. The

cock has a very large rose-comb, two inches across, and well piked behind; ear-lobes white; beak white; neck-hackle white, with dark marking, and in old birds slightly tinged with yellow; at times, however, it is seen of a clear white. The breast should be regularly imbricated or spangled, exhibiting markings as clearly defined as any on the hen; black or irregularly mottled breasts are too common, but can not enter in competition with the former; the back, thighs, and wing-coverts, white, distinctly spangled; the latter, excepting the wing quill-feathers, white; legs blue; sickle tail-feathers ample, black, irregularly splashed with white, but the smaller feathers distinctly spangled.

The hen has a small rose-comb, well piked; eye dark, large, and prominent, that of the cock being often rather yellow and less prominent; hackle, breast, back, and wing-coverts, white, regularly spangled with black; tail white, with black tips.

As the spangled feather is best developed in the Hamburg varieties, we here give a drawing of one. We think that the spangle which ap-

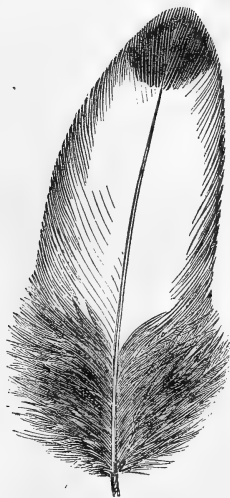

proaches to a circular form is the most correct, for when of the crescent or horse-shoe shape it

K

appears to be passing toward the laced character. When the spangle is of the crescent form the plumage may have a gayer and lighter aspect (we are speaking of the dark spangled); but when the spangle is circular or oval, the plumage is richer to the eye. The ground color of the feathers must be perfectly clear.

The Hamburg fowls are very impatient of confinement, and succeed best when they can have the run of a clean pasture or common. How essential this is, requires no other evidence than that all the most successful breeders with whom we have communicated have spontaneously stated, "They require a large grass walk." Six feet fences, where they are intended to be restricted to certain limits, will not be more than sufficient for their safe custody.

As egg-producers they are fully entitled to rank among the best. The hens, if young, continue to lay nearly throughout the year; but the eggs, which are white, are small, weighing about  $1\frac{1}{2}$  ounces each. The Golden-spangled reach to about  $1\frac{3}{4}$  ounces. Of the last named, Mr. Dixon gives the high average of 240 eggs yearly. As they are such abundant layers they seldom want to sit.

It is remarked by Mr. Dixon that "the chickens are healthy, strong, and require no unusual care;" who adds, "The full grown fowls are remarkably healthy." When first hatched the chickens are cream colored, or, in the Golden varieties, light yellow, with a dark stripe down the neck and back. They feather early, and the barred character of the penciled birds is quickly shown. In the rapidity of their movements they rival even the active little Bantams.

We may here observe that both sexes of all the varieties continue to improve in appearance after each moult until they are three years old. Birds of one year old have never attained to their full beauty; this is especially apparent in the more ample development of the tail-feathers of the cock as he becomes older. At from five to six months old they are fit for table use, their meat white, tender, and well flavored.

#### BLACK HAMBURG FOWL.

This is also called the Black Pheasant fowl, though it has no spangles, but a plumage uni-

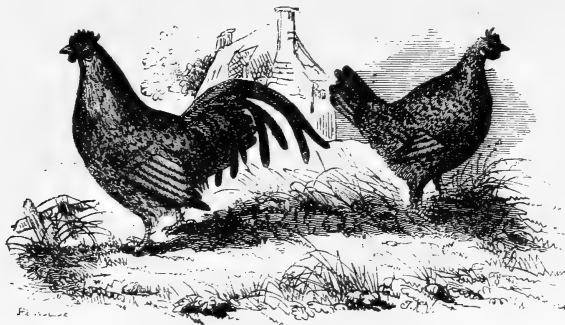

THE BANTAM FOWL.

formly of rich glossy green-black. In form they closely resemble other Hamburgs, and may bear the same relationship to them that the Black Shanghais do to the Buff and other colored.

Having thus described the various kinds of Hamburgs, we may conclude by observing that they, with the Polands and Bantams, are the two principal varieties that are technically known as "feathered fowls," because their merits consist in the accuracy of the markings and beauty of their feathers, and not in their size.

#### THE BANTAM FOWL.

The Bantam is the smallest specimen, and may with propriety be termed the Liliputian fowl of the gallinaceous tribe, and stands, comparatively, in size, to that of the Malay or Shanghai, as the stately Durham to the diminutive Alderney cow.

There can be little doubt but that it is to the islands of the Eastern Archipelago that the origin of this fowl must be referred; but whether all our present varieties owe their descent to any one primitive stock, may be the subject of speculation, though hardly capable of proof at the present day. It is generally supposed that this variety received its name from a town and district of Java, from whence it was first brought by the Dutch. Since their introduction into Europe, this breed has ramified into many varieties, none of which are destitute of elegance, and many remarkable for their beauty. All

are, or ought to be, of small size, but lively and vigorous, exhibiting in their movements stateliness and grace.

The Bantam, though extremely small in size, is elegantly formed, and remarkable for its grotesque figure, and must be considered more as an object of curiosity than utility, and, of course, must expect to be received with no peculiar favor, except by the fancier, in this country. From its size and delicacy, however, they are very convenient, as they may sometimes stand in the place of chickens, when they are not to be had. They are very domestic, often making their nests in the kitchen and cupboard of the dwelling when permitted.

The cocks are great at crowing, exceedingly courageous and pugnacious, and do not hesitate to attack a turkey or any large bird with most amusing pomposness of manner. Their passionate temper, their overweening assumption and arrogance, and their propensity to make every rival turn tail, has caused them many difficulties.

The white Bantams, with long feathers on their legs, are the most common, but are beautiful little birds, with short legs, feathered sometimes to the extremity of the toes. On account of their short, feathered legs, a dry location is required. They arrive at maturity early, and are well worthy of propagation. They are very faithful sitters, good mothers, and will lay more eggs, though small, than any other variety. They



require but little food, and thrive cooped up in a small yard where there is dry sand, ashes, and sun.

The feather-legged may often be kept for amusement and fancy, especially where there is convenience for no other kind, as they are not so apt to scratch or do injury in the garden; and as they are, in general, great devourers of some of the most destructive of our insects, they are thus positively serviceable creatures to the farmers, as far as their limited range extends, and still more so to the gardener and nurseryman. We are of opinion that it will soon be found as necessary to keep Bantams to kill vermin, as it is to keep terrier dogs or cats to keep down rats and mice. They will save various crops from injuries to which they would be otherwise exposed. They would, to be sure, scratch a little, and so would cats; and if the very small kind are kept, the African for instance, their scratching would do little harm.

The white feather-legged Bantams are now as completely out of vogue as they were formerly in esteem. The chief interest attached to them lies in their hinting to the naturalist an affinity with the Grouse or Ptarmigan. They are now nearly extinct in this country.

There is also a South American variety, either from Brazil or Buenos Ayres, which will roost in trees, and are said to be very beautiful; partridge-colored; eggs small and colored like the pheasant; both the flesh and eggs are fine flavored and delicate.

Mowbray speaks of a Bantam in his time, extremely small, and as smooth legged as a Game fowl; he probably meant the African, which will hereafter be noticed.

Aldrovandus, two thousand years ago, described the cock with the neck and the back of a chestnut color, the wings at first black, with whitish spots, afterward black; the quill-feathers being white on the outer, and black on the inner sides; the throat, breast, belly, thighs, and legs, black with whitish spots; the feet yellow; the wattles large; the comb double, and not very large; the beak yellow; the tail-feathers partly white and partly black. The hen is of a yellowish color, and every where, except the neck, marked with oblong black spots.

The Bantams are the fowls of all others for the city. We have known them to prosper and lay well through the winter in a cellar well lighted.

The following remarkable instance of the attachment of a Bantam cock to his mate, we find related in an English publication. Speaking of the cock, the author says: "He is also capable of such attachment to his mate, that we remember a Bantam cock and hen which were kept for some years as favorites without any others, in the stable-yard of our father, and when at length the hen died, the cock seeing her lifeless, but naturally unconscious of its being a final separation, hovered around her, calling to her, and pecking at her gently, as if to awake her. Though corn was offered to him, he refused to eat, or to roost at night, and moped round the yard, vainly searching for his old companion, when not finding her, he flew away, and was never after heard of."

"One of the prettiest little Bantam patriarchs we have ever seen," says Boswell, "was when on a visit to one of the finest landscape painters of the day, in the yard of our friend Mr. Brown. He marched majestically at the head of his tiny tribe, and was of a very fine breed from Ayrshire. They had the full scope of the garden, and did little injury—the door-step was their feeding-place, and still did no discredit to the tidiness of good old Bernie, so that two or three Bantams may be kept without much molestation in any rural situation."

We find in a late publication the following curious account of a pair of Bantams: "Some years since," says the writer, "a circumstance in reference to poultry, completely 'turning the tables' in every thing I have yet seen, came under my observation; and the simple narration will, I am sure, amuse your readers.

"At the time I speak of, I very greatly admired the sports of the gun, and being invited to pass a few days where game was exceedingly plentiful, became a frequent eye-witness of the oddity I describe. The children of the bailiff, it seems, in some of their rambles in early spring, discovered a partridge's nest, containing two eggs; and with that proneness for meddling, often noticed in children, went home, and finding three

eggs of their father's Black-breasted red Bantams (which were kept to raise game), without any but childish motives, placed them carefully in the partridge's nest. I find afterward these children frequently went to see the result, but did not again actually interfere with the poor birds' privacy. She continued laying until twelve of her own eggs were also deposited, and then sitting, hatched all her own, and two of the three Bantams' eggs; her numerous and strangely incongruous offspring were all reared, and in the autumn it was I first saw them, living together as comfortably as possible.

"Great care was taken by the owner that nothing should endanger the life of any of this covey; so that spring came on, and found the birds paying a tolerable revenue to the game-keeper, whose plan it was to gain 'a perquisite from every comer,' by running an old pointer, and when discovered, flushing the birds. On these occasions the pair of Bantams (for they were a cock and hen) would always fly equally with the partridges, both as to rapidity and distance, sometimes traversing six or seven fields at a single flight; and if their companions happened to drop short and run to cover, the Bantams would, with depressed head and tail, still manage to make a 'dead heat' of it; in fact, were as wild and retiring as possible—quite as much so as their companions!

"But it has been said truly, 'Instinct is never quite suppressed,' for *invariably*, when disturbed, the little fellow, after gaining supposed security, indulged in two or three hearty flaps of the wings, and as many shrill crowsings—a practice he would repeat as frequently as he was subjected to these almost endless rehearsals, a feat that generally produced a hearty laugh from spectators. At early dawn this bird might occasionally be seen traversing the meadows, and be espied calling haphazard either his fellow or the birds to partake of the proffered food, which was generally scrambled for from his bill. He seemed, too, as fond of some of this covey as of his own mate, a matter which greatly increased the vexation of its owner when his loss was discovered. Not hearing the bird crow as usual, the oft-adopted plan was tried to discover his whereabouts, but proved futile; and after a

lengthy and determined search, in which both owner and all the household were engaged, a number of partridges' feathers lying loosely about, in one of the fields, among which a 'sickle-feather' from the Bantam was also discovered, told too plainly that the treacherous meshes of some midnight poacher had caused his sudden disappearance."

#### THE BLACK BANTAM.

The Black African Bantam, which is faithfully delineated on the opposite page, is a most beautiful example of a great soul in a little body. He is the most pugnacious of his tribe. He will drive to a respectful distance great dunghill cocks five times his weight. He is in appearance a pleasing little fellow, though an impudent, consequential little atom! Oh, the little impudent scamp! That such a contemptible minikin as that should have the assurance to strut and parade his insignificant person in the presence of great hens, the members of families of weight and substance, before the Misses, and still more, the Mistresses Malay, Cochin, and Dorking, to presume to show such marked attention, I declare! to . . . Well, there is no knowing to what length impudence will go, so long as Bantams survive extermination. He is more jealous, irascible, and domineering, in proportion to his size, than the thorough-bred Game-cock.

"Its combativeness," says Mr. Dixon, "is manifest at a very early period. Other chickens will fight in sport by the time they are half grown, but these set to work in good earnest. One summer we bought a small brood, as soon as they could be safely removed from their mother; there were two cockerels among them. They were little things, beautifully shaped, but ridiculously diminutive; fairly chickens some of our friends called them. They had not been with us long before the liberal supply of barley began to excite them; and the two little imp spent the greater part of their time in fighting, which only made us laugh, judging serious injury impossible. But shortly observing one unusually tired (for it had always been a sort of draw game between them), and the other walking about in an odd uncertain manner, though

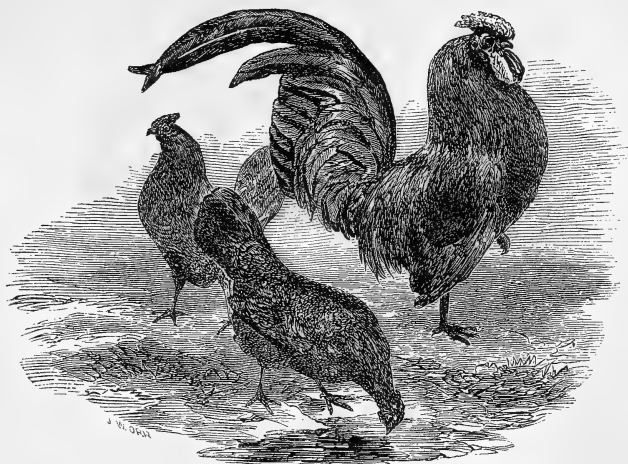

THE BLACK BANTAM.

firm and fearless, I found that this latter had both its eyes closed from wounds received the day before. I carried it to my dressing-room, to relieve it by sponging, and set it down, while I went to fetch some warm water. Still blind, it began crowing lustily. In a few minutes its eyes were unsealed, and it was returned to the yard. But battle after battle was immediately fought, and we were obliged to eat one of the combatants to prevent the mutilation of both. One that I have seen was in the constant habit of fighting, or rather sparring, with a little spaniel dog that belonged to the same owner. Though apparently attacking each other with great fury, they never seemed to be in real earnest. The arrival of strangers was generally the signal for a sham fight, which ended without bloodshed as soon as one or both of the combatants was out of breath. The spaniel was generally the first to give in, when the victor evinced as much triumph as if he had vanquished a feathered foe."

The cock which our cut represents has a full crimson rose-comb, similar to that of the Hamburg fowl, with wattles and face of the same

hue, and the ear-lobes, like the Spanish, perfectly white; his plumage is glossy black, reflecting purple tints with brass-colored spots on his back, which, however, is not common; tail ample, flowing, and sickled; short sinewy clean legs of a dark color. He has a waggish, impudent eye, self-satisfied air and gait. The hen is dusky black, with her comb and wattles small, and of a dull leaden hue.

The Black Bantams vary greatly in size, though occasionally we have found some of the smallest specimens of the whole family. We lately saw quite a number of these Lilliputian fowls in the yard of M. Vassar, Esq., at "Springside," his beautiful residence near Poughkeepsie, some of which, even the cocks, we should judge would not reach one pound in their feathers. Divest them of their sickle-feathers and they would pass for fan-tail pigeons. It was amusing to see what consequential airs they assumed, the little whipper-snappers.

In respect to determined courage, the African Bantam will yield to none—no matter the foe, even a turkey-cock, to whom they are opposed, or the cause of contention, they fight to the

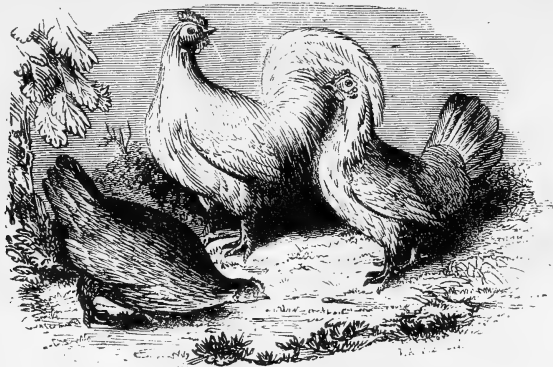

JAVA BANTAM FOWL.

last, and fowls treble their weight are often forced to yield. Hence, unless restricted by secure inclosures, they are unwelcome neighbors to other poultry; and consequently by no means so generally kept as, from the beauty of their plumage and their bold carriage—a very caricature of Bantam arrogance—would otherwise have happened.

It is generally admitted that the origin of this Lilliputian family must be referred to the islands of the Eastern Archipelago; but whether all our present varieties owe their descent to any one primitive stock may be the subject of speculation, indeed, though hardly at the present day capable of proof. Bantam, however, a town and district of Java, has afforded their present designation; and the wild Bankiva fowl is the bird to which they are usually considered to owe their origin.

#### THE JAVA BANTAM.

Richardson says that “the original of the Bantam is the Bankiva fowl, a native of Java, several specimens of which are kept by her Majesty at the Home Farm. These are beautiful little creatures, perfectly white in color, and exceedingly small size, and they exhibit some peculiar traits of habit and disposition that we can not overlook. Among other strange propensities, the cocks are so fond of sucking the

eggs laid by the hen, that they will often drive her from the nest in order to obtain them—nay, they have even been known to attack her, tear open the *ovarium*, and devour its shell-less contents. To subdue this propensity Her Majesty's keeper gave the cocks first a hard-boiled egg, and then a marble one to fight with, taking care at the same time to keep them from any access to a real egg. No sooner was this done, than an attack on the false egg was commenced, which lasted for a week, till at last, wearied with their fruitless labor, they gradually gave up all notice of them, and with that abandonment, as was anticipated, they ceased from their accustomed destruction of the eggs, and have never been known to attack them since.

“Another strange propensity was exhibited in a passion for sucking each other's blood; but this propensity is not peculiar to that breed of fowls; it is more or less common with all fowls. This passion generally exhibits itself when the birds are moulting, when they had been known to peck each other naked, by pulling out the new feathers as they appeared, and squeezing with their beaks the blood from the bulbs at the base. The intelligence of the keeper found means to overcome this propensity likewise. That person observing that the birds were subject to great heat of the skin, and that its surface occasionally became hard and tightened,





GOLD AND SILVER LACED BANTAMS.

LITH. OF ENDRITT & CO. N. Y.

conceived that, in such cases, the hard roots of the feathers being drawn into a position more nearly at right angles with the body than at ordinary times, the skin and superficial muscles were thus subjected to an usual degree of painful irritation; and it immediately occurred to him that the disagreeable habit in question was simply a provision of nature for the relief of the suffering birds. Impressed with this idea, he tried the effect of artificial relief, by washing with warm water, and the subsequent use of pomatum to the skin. His experiment was successful, and the birds' plumage has been ever since untouched.

"As might be supposed, when such a propensity to devour the eggs exists in the male bird the female is a secret layer. In this respect these fowls show their identity with the original bird of Java, the Bankiva cock, whose wildness of disposition I have already mentioned. These fowls are both good layers and good sitters."

In corroboration of the foregoing propensity a writer in the Poultry Book remarks: "The opportunity was once afforded me of narrowly watching the habits of a pair of Bankiva fowls, originally from Java, but which their owner had obtained from a dealer in Portugal. The male in appearance closely assimilated to the Black-breasted red Bantam, though in one peculiarity differing greatly from that bird, his tail always, whether quiescent or otherwise, carried almost in a straight line with the back. The same was the case with the female; and, beyond their somewhat lighter form, this appeared to be the only distinguishable difference between her and the hen of the domestic variety. These birds were unfortunately extremely wild, and confinement seemed to effect no change whatever on their natural habits. The hen, indeed, laid a few eggs, which were at once devoured by the parents. In fact so unsocial and pugnacious were they, that although attempts were made again and again to cross them with the Black-breasted red Bantams, death to the new-comers invariably ensued. Even the hen killed a little fellow of that variety when placed after night-fall side by side on the roost with herself alone. They would not fight during the presence of any one, but the instant they saw the coast

clear, they set to most determinately, and, if not overmatched in size, with invariable success. Their end, however, was a melancholy one, for a Game hen, placed with them, employed her great strength in the destruction of both."

#### THE NANKIN BANTAM.

The Nankin Bantams appear to have been among the earliest importations; and about the most useful of their tribe, and not the least ornamental. Their clear plumage and active figure will procure for them many admirers. Their prevailing color is a pale orange or buff, something resembling the Nankeen (a corruption of Nankin), a certain cotton material much in vogue in this country some years ago for summer wear. The cocks are decked in red, orange, and scarlet, mostly with the false speculum, or iridescent wing-coverts, altogether of a flashy appearance; and, indeed, when good specimens of their kind, they are really beautiful little birds.

The hen has usually some dark markings on the hackle, and the tail is often tipped with black; both sexes have short, dark legs, and a double comb. Many of these birds are said to exhibit a strong resemblance to the corresponding colors of the Buff Shanghais. Their eggs are large in proportion to the size of the fowl, very rounded and full at both ends, and of excellent flavor. The hens are steady sitters and excellent mothers.

There is a browner variety of this bird which is sometimes called the Partridge Bantam; such are almost miniatures of the Golden Hamburg fowls both penciled and spangled. There is the same double comb pointed behind, the same blue legs and characteristics of form and plumage.

#### THE SEBRIGHT BANTAM.

There are certainly very few, if there are any varieties of poultry which, for beauty and general appearance or conformation, are equal to the Sebright Bantam. The Cochin for weight and quietness—the Sebright for haughty carriage and diminutive beauty. They are comparatively non-injurious in the ornamental ground around a villa; their plumage and markings justify entitle them to the appellation given by the late

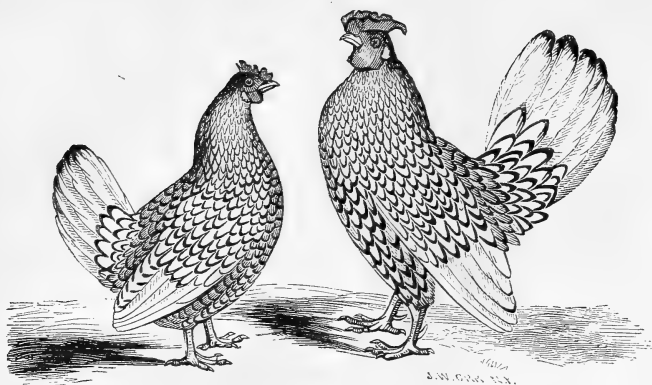

THE SEBRIGHT BANTAM FOWL.

Sir John Sebright, from whom they derive their name, and to whom we are indebted for this variety, as "being the very prettiest of all domestic fowls," and when hereditary breeding has not been too closely persisted in, they are not without *utility* likewise.

The English know more, I will venture to say, of the science of breeding, than all the other nations on the globe, and this knowledge is exercised on their domestic animals, from the noble race down to a tom-cat, Guinea-pig, or lop-eared rabbit; and from the proud and graceful swan to the no less proud and scarcely less graceful bantam.

Much mystery has been attached to the process by which these birds were brought to their present state of perfection. Whether originally bred from selected specimens of the spangled Poles, certain feathers, those on the wing-coverts more especially, are usually found of a laced character—or whether we should be content to place them as one among the numerous distinct branches into which this family have been divided, remains a matter of discussion, and one too, which at this date is not likely to be satisfactorily determined.

"The last object," says a writer in the *Poultry Chronicle*, "Sir John arrived at, was to improve

the Bantam to a clear erect carriage. To effect this, he, about forty-five years ago, obtained a buff colored Bantam hen at Norwich; she was very small indeed, with clear slate-colored legs; on the same journey he purchased a cockerel, rather inclining to red in color, destitute of sickle-feathers, with a hen-like cackle, and also (at Walford) a small hen resembling a Golden Hamburg. After this, by drafting for five or six years, he gained the very penciled feather he so anxiously sought after, by in-and-in breeding, for about twenty years. He afterward had a white cockerel from the Zoological Gardens by which he made his silvers."

One of the most remarkable characteristics of the Sebright cock is the total absence of both hackle and saddle feathers; he is also perfectly "*hen tailed*," that is, devoid of sickle-feathers; the principal feathers being straight and forming a square tail, like that of the hen, perfectly upright and not inclining to either side, for this would constitute a very serious objection, though by no means an uncommon occurrence, even in the produce of the best-selected birds. The tail-coverts are somewhat more developed than in other fowls, and great stress is justly laid on these being perfectly laced, since, in the few places are the colors more apt to run. The comb must be double, terminating in a well-



formed point, less sharp than the Hamburgs; while the legs and feet are required blue, and wholly free from the least appearance of a feather. The feathers on the head are apt to get dark from their wider margin of the lacing; this, however, should be avoided, since a main point of the Sebright is the preservation of the same proportion of ground color and lacing throughout the whole of its plumage. The ear-lobe is small, and in our opinion should be white; but this is rarely, if ever seen, and many would give a preference to a blue tinge. A writer in the "Poultry Book" thus alludes to this point: "In the Sebright 'laced' Bantams I have yet to see a specimen in which the ear-lobe is perfectly white; for although so many have been bred by myself in the last twenty years, all that I have ever yet had were blushed, and many perfectly red in the ear-lobe. I freely admit I should prefer the white, but feel confident that it is not to be generally, if ever, obtained. I have also invariably noticed that the usual whiteness of the ear-lobe is accompanied by a sad falling off in the lacing, therefore, if attainable only at so great a cost, it must not be insisted on. Whether the ear-lobe is white, or possesses the blue tinge, either form would place the bird above those of its competitors, who, equal in other points, manifested the decided red stain, which it must be remembered is widely removed from the blushed appearance before alluded to."

There are of the Sebrights two distinct varieties, well known, one as the "Golden-laced," the other as the "Silver-laced" Bantam, the markings in each precisely similar, the great difference being in the ground color; that of the Golden is a purely clear bright bay; the Silver colored on the other hand, if decidedly a perfect bird, is a clear bright frosted silver, which, from the very great contrast with the "black lacings," gives it a decidedly superior appearance to its less conspicuous neighbor. Every feather from the head to the tail of a well-bred Sebright is "laced" or bordered all round the edge with a line of pure black, about one-sixteenth of an inch in width, and it is quite essential that regularity should exist all throughout the whole lacings, even on the coverts of the wings; for if the line widens toward the ex-

tremitry of the feather, it becomes a fatal objection; this is one of the most common failings in these birds, and is the best obviated by a little careful management in the selection of "brood stock." The tail should be only tipped with black, and the ground color ought not to be clouded, but perfectly clear and distinct throughout its whole extent.

If possible, always breed this truly fashionable and beautiful variety of fowls from old birds, not chickens; as, when so managed; your success will be far more certain.

The chickens are hardy to excess, if kept in a perfectly dry place the first week or two; and it is quite necessary to enforce this, as the least damp at this early age is certainly fatal alike to your hopes and your chickens.

The gait of the Sebright Bantam is the very extreme of self-esteem, vanity, and self-assurance, and when silently walking on a lawn in search of insects in the grass, or hurrying with the most agile and noisy impatience from the too near advance of your favorite dog to some friendly covert of evergreens, it is impossible to conceive a more lovely ornament to your grounds, or one that claims more general admiration and astonishment from those who thus see them for the first time. The feet are raised in walking much more than in any other of the Bantams, and planted again with the greatest deliberation and precision. When alarmed, their deportment is most striking; the wings droop to the ground, not listlessly, but as if determined to make the most of their tiny proportions; while the head is thrown back, and the tail raised, so that they all but meet.

*Characteristics.*—The Bantams are excellent layers, sitters, and mothers, and perform all these duties with very little trouble. As mothers, indeed, they appear to the greatest advantage; for their activity, courage, and gentleness with their chickens place them above all other fowls. Four or even five eggs per week each, during a laying season, extending over seven or eight months, is no unusual production.

Our Bantam labors are now ended, and if our assurance of their hardy disposition and habits of domesticity, in conjunction with the beauty of their form and plumage, should induce



THE CREEPER OR DWARF FOWL.

any of those who have read our pages to give them a fair trial, we shall feel that our labors have not been in vain, and assured of eventual assent to all we have said in their favor.

#### THE CREEPER OR DWARF FOWL.

This variety is described by some authors as not larger than a pigeon, and differs from the Bantam chiefly in size and in the shortness of its legs. It is found occasionally in our farm-yards, and is considered less troublesome in gardens. The shortness of its legs prevents too free use of them on new-made beds. In size it is generally below the common fowl of the country.

The "Achoh," a native of Madagascar, is described as very small, with a circle of feathers about the legs, a thick tail, which it carries straight, and the ends of the wings black. Other varieties, said to come from Cambodia and now found in the Philippine Islands, have the legs so short as to drag the wings on the ground.

In addition to these, Buffon mentions a sort of fowl in Brittany which are always obliged to leap, the legs being so short. They are the size of the barn-yard fowl, and kept as being very profitable. The hens, it is said, will hatch thirty eggs at a time. Some think these dwarf fowls are the "Adrian" breed, mentioned by Pliny. Aristotle speaks in the highest terms of the fecundity of these dwarf fowls: "They lay," says he, "every day, and sometimes two eggs a day."

Aldrovandus, two thousand years ago, described the dwarf hen as all black, except the quill-feathers on the wings, which are white at the ends, with some chestnut-like spots on the neck, and a yellow spot around the eye. The comb small and dark colored; the feet yellowish; the claws equal and very white. He said nothing about the cock.

A very small dwarf fowl has been greatly multiplied in England, because it is very fruitful, and excellent for sitting; it is preferred in

pheasants' walks to the common hens, which are too heavy. When the breed is pure, the plumage of this fowl is quite white, and it is not larger than a pigeon.

Another variety, the "Chinese Dwarf Fowl," is smaller than the English dwarf; its plumage is variegated on the different individuals like that of the common breed. The painting of them is frequently to be found on Chinese papers.

The French also claim a breed of Dwarf fowls, not so small, however, as the English dwarf fowl. Its plumage varies like that of the common breed; its eggs are not larger than that of the pigeon.

In Scotland they have a breed of dwarf fowls which are called "Dumpies." "The *London Times*," say the authors of "The Poultry Book," "in an amusing article on the Metropolitan Poultry Show of 1852, questioned the possession by these birds of any more valuable qualities than the facility with which they might be stowed away in a sauce-pan. But Mr. Fairlie, of Cheverly Park, the only person, we believe, into whose hands they have yet passed, has recorded so favorable an opinion of their merits as layers and mothers, no less than for the table, that we shall be much surprised if, either in their present state, or crossed with other fowls, they fail to prove a useful addition to our poultry-yards.

"Mr. Fairlie obtained his birds from Scotland; but all his inquiries have hitherto been unable to trace their origin in, or importation into, that country. Their general character, however, so closely assimilates to that of the Dorkings, as shown in our illustration, that the probability of their being descendants of birds stunted in their growth by the less genial climate of the northern district of our island, may readily be admitted; and this the more easily, when we remember how many would describe the early ancestors of the Dorking race as 'stumpy, thick-set, white fowls.'

"For a detail of their several characteristics and points, let us refer to Mr. Fairlie's own words: 'The Scotch Bakies, or Dumpies,' he tells us, 'are a breed of fowls closely resembling the Dorkings in form, symmetry, and quality of

flesh; the average weight of the full-grown male bird is from six to seven pounds, and of the hen from five to six pounds; their legs are singularly short, not exceeding two inches in length from the hock joint; the comb is generally single, erect, and well serrated; the body round and plump, and the tail ample. As layers they have great merit; for after filling one nest, if the eggs are removed, they at once take to another, filling that also before they sit, during which process they fully justify the oft-repeated remark made at the Metropolitan Exhibition, *What excellent sitters they must make!* They cover many more eggs than might be expected from their size, for while on the nest, they appear as if they had been pressed flat upon it. They are gentle and quiet when hatching, and subsequently prove gentle and attentive mothers, their short legs enabling the chickens to brood well under them even when standing up. I have found them perfectly hardy; and their eggs are larger, and the shell a clearer white than the usual average of an English market egg."

#### THE PADUAN FOWL.

In the "Poultry Book," under the head of "Fowls Recently Imported," we find the following: "About twenty years since, a sitting of eggs was obtained from a ship's captain in London, who had imported the fowls by whom they were produced, though from what country can not now be ascertained. From these chickens a race of fowls has been kept up unstained by the admixture of any other breed; and birds from this stock have for some years been in the possession of the Rev. T. A. Holland, of Sussex. Several indications of the probability of their proving a distinct breed were noticed by that gentleman, and their features and general character were therefore carefully noted by him, as also Mr. H. Hinxman, to whom we are indebted for the following description:

"My friend Mr. Holland's Paduans have nothing whatever to do with those of Aldrovandus. The breed is one of those I mentioned to you as being under my experimental consideration as a practical and useful variety for general purposes. I like them much, and believe

them to be a pure race, although I am fully aware that one can not be too cautious in stamping stray pens of fowls as *new and distinct varieties*. There is always, indeed, abundance of trash sent to exhibitions under that class, and if they can but get noticed, they are forthwith sent out at prices that fairly make one stand aghast when one sees the article thus paid for.

“But the question now before us is whether these Paduans are either derived from or allied to any other known breed? Now the red Dorking and the Duck-wing Game suggest themselves as the most likely connections. But the Paduans I have hitherto bred, have shown no indications of either of those breeds beyond a tinge of blue or green in the legs, and a rather fan-shaped Game tail, both of which, it is true, *might* raise a question of (as the Irish would say) the *last taste of the Duck-wing*. But this has only occurred in a pullet or two, the cockerels being quite steady and pure. The adult birds are of the size of medium Dorkings, and rather partake of their shape, having short white legs and broad backs. The cock's hackle and saddle feathers are brilliant orange; back and wings, darker red; breast, chestnut; with a green

speculum on the wing; tail, a rich glancing greenish black.

“The hen has a chestnut or fawn-colored breast, golden hackle edged with brown, back and wings different shades of brown, each feather being beautifully marked, and closely resembling those of the partridge. They are excellent both as layers and incubators, no less than for the table, where they appear plump, well-shaped birds, a source of comfort, indeed, to any cook who, in these days of gaunt Asiatics, has been hitherto obliged to make those birds which *would not do for the show*, respectable for master's table. The eggs are fair sized, and about the color of the lightest Shanghai. The cockerel's comb is rather long in growing up, and, at maturity, of a medium size, and always single.

“Under such circumstances we should advise the substitution of some other name from that which they now bear. It neither indicates their native country, nor serves to explain any portion of their subsequent history; while confusion is sure to arise from its application to the Paduan fowls of Aldrovandus, the progenitors, according to Mr. Dixon, of our present Polish race.”



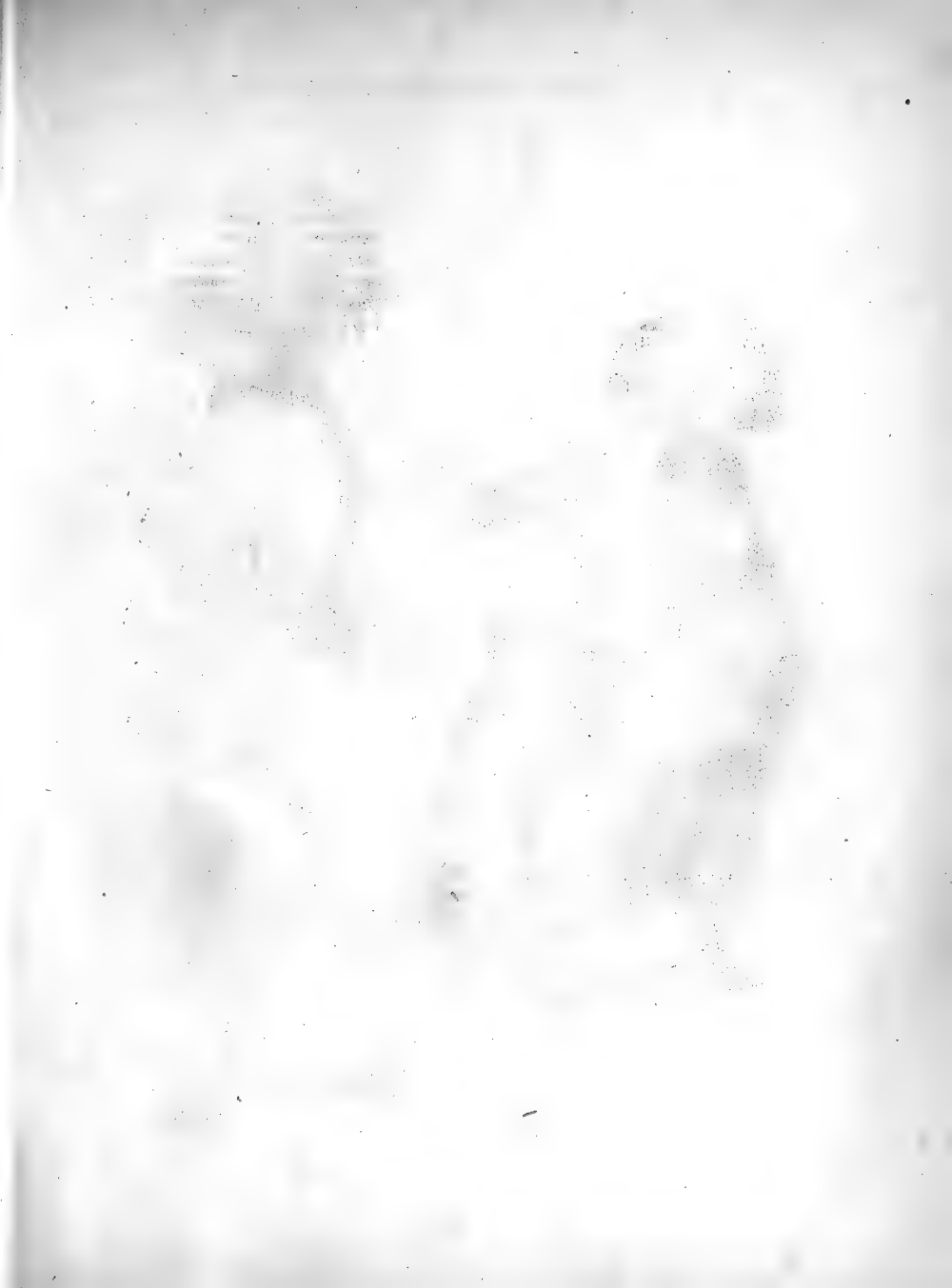

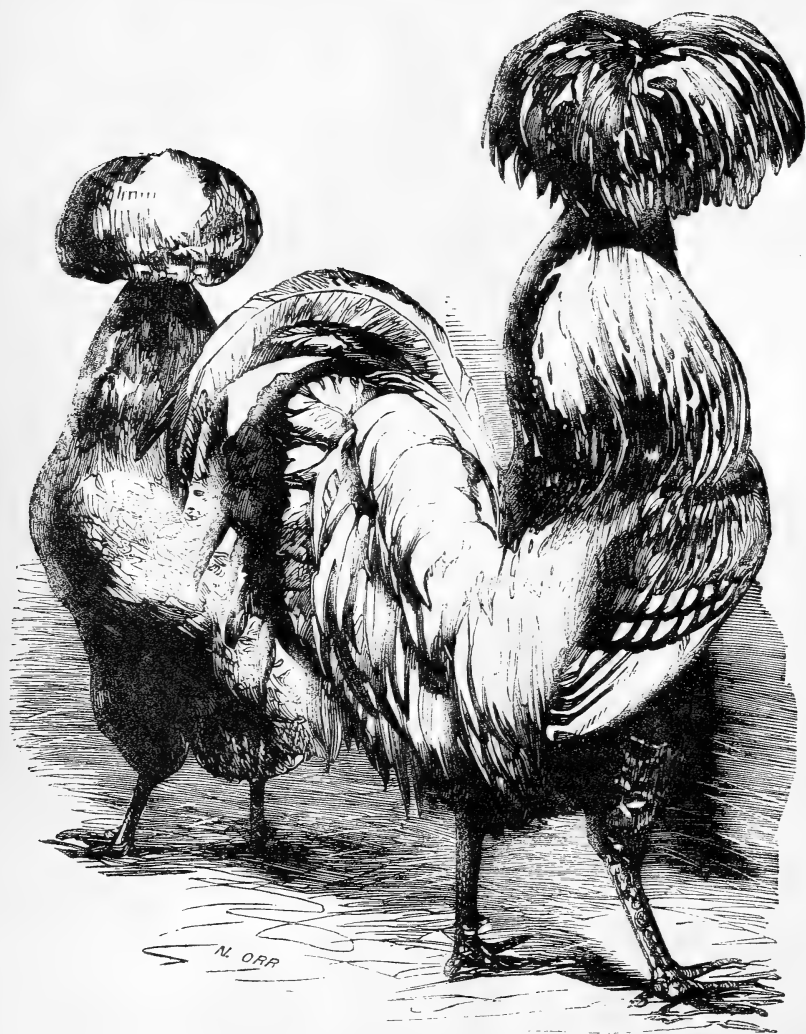

CRESTED FOWLS.

## CHAPTER VII.

## CRESTED FOWLS.

BUFFON, in speaking of the crested cock says: "The breed of crested fowls is that which the curious most cultivated, and what generally happens when things are closely examined, they have observed a great number of differences, particularly in their colors of plumage, which serve to distinguish a multitude of races, that are the more esteemed in proportion to the beauty of their plumage and rareness of their tints, such as the gold and silver ones."

A writer in the *Cottage Gardener* remarks: "The various breeds of crested fowls are generally designated under the head of Polands. I consider this name incorrect, as applied to all the varieties, as they are usually classed together, and that it ought not to be continued, as it gives the impression that they are only varieties of the same kind, instead of their being, as they really are, of distinct origin.

"I think it would be equally justifiable to class all single-comb birds together, and also those which have rose-combs in another class, as it is supposed that all top-knotted fowls are of one kind. I am not aware of any wild race that has the full rose-comb, and I believe it is usually supposed by naturalists that that form is attributable to the effects of domestication. The same or similar arguments have been used by some to account for the extra or fifth toe to be met with in other breeds; with equal justice, I contend, the crests of our top-knotted fowls *might* be assigned to a like origin; and supposing this to be correct, does it follow, that in the long lapse of years during which fowls have been domesticated, and the various circumstances under which these birds have been cultivated—is it not likely that if such change did take place once, it might again in a different place, and

even under different circumstances? The only wild breed of fowls I have ever heard of with feathery crests, is that which was said to have been found by the Spaniards in their western possessions; this fowl was called the St. Jago fowl, and has been confused by some naturalists with the *Gallus Giganteus* of Sumatra or Malay, from which, however, it is quite distinct. The old white fowls with black top-knots are considered as the true descendants of the wild St. Jago, even as the Malay is that of the *Gallus Giganteus*; if this is correct, the truth of which I do not doubt, and I think it will also be admitted, that top-knotted fowls were known in England before America was discovered, and as one variety is evidently of Persian origin, then they can not possibly be of one kind.

"The intermingling of the various kinds is also a fertile source from whence, in the length of their captivity, many varieties, by isolation and the whims and caprices of men, have in many cases produced established sorts as permanent varieties.

"Thus I conclude, from careful examination of poultry literature, so far as I have been enabled to obtain it, that the Persian Polands, the St. Jago, and the crested Hamburgs, are three distinct kinds, and ought therefore not to be called by one name."

## BLACK POLAND FOWL.

These, like the brave people from which they derive their name, are every way commendable, and are recommended to the "chicken fancy."

The Poland fowls, as they are generally called, were, according to English authors, said to be imported from Holland. Mr. Dixon regards the Paduan Fowl figured by Aldrovandus, as a

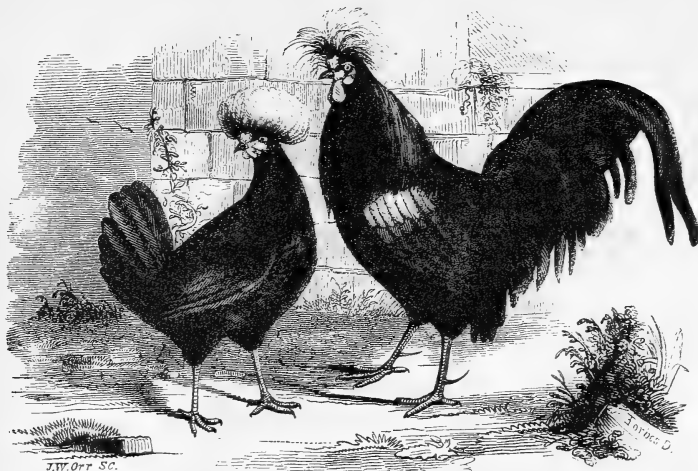

BLACK POLAND FOWL.

progenitor of the Polish race; but the red spot encircling the eyes, and the yellow-bill and feet assigned to the former bird, would create doubt as to any such relationship, and the portraits referred to are very unintelligible. Mr. Moffat, in the "Poultry-keeper's Guide," speaks of the Paduan as domesticated in the town of that name in Italy, and then treats of the Polands separately, under the title of the "Crested Cock."

The authors of "The Poultry Book," in reference to the origin of the Poland fowl, say: "Among other localities, St. Jago is spoken of as their native country; but this expression, we may remark, is very indefinite, since the Geographical Gazetteer under this name enumerates above twenty different places in various quarters of the globe. Thus, among others, we have St. Jago, one of the Cape de Verd Islands; a town in St. Domingo; a city of the Buenos Ayrean territory; also of Mexico, Gautemala, Honduras, and of Chili, in South America. Our investigations, therefore, are thus but little aided. Which of these is to be considered as the Poland's birth-place we are not specially in-

formed, nor does it appear probable that any inquiries, however carefully conducted, are now likely to settle the question. If we are content to trace the countries through which we have received these fowls, it appears highly probable that they were introduced into the Netherlands by the Spaniards during their occupation of the Low Countries; and from Germany, Holland, Belgium, and latterly Marseilles, we have been in the habit of receiving our best specimens. To all who are acquainted with the pictures of the Dutch school, the bearded Poland is known as a frequent feature. Whence the Spaniards obtained them is a point we can not pretend to decide, though the possessions and commerce of that kingdom would direct our inquiries to the western rather than to the eastern hemisphere.

"With Poland, we certainly have nothing to connect these birds; the supposed overland journey, which has been suggested as accounting for their presence in that country, and their consequent name, is hardly probable. Nor do we think more favorably of the derivation from the disease known as 'Plica Polonica,' in which the







BLACK HOLLANDS WITH WHITE CRESTS.

LITH. OF ASHCROFT & CO. N. Y.

hair of the human being is plastered flat on the head with an extended and hardened section, the very opposite to a flowing top-knot."

Mr. Dixon thinks that the Poland fowl is a hybrid between the crested and the Spanish fowls. It is, however, quite unknown in Poland, and is said to have taken its name from some resemblance having been fancied between its tufted crest and the square spreading crown of the feathered caps worn by the Polish soldiers.

There is no evidence that any breed of fowls with top-knots was known to the ancients; but we first meet with them in the Middle Ages. Aldrovandus, as quoted by Willoughby in his "Ornithology," gives us many kinds, or rather rarities, of hens, among which was one white and "coppered," but this is believed to be the lark-crested barn-yard fowl of the present day. Aldrovandus also gives two large spirited figures, each occupying the whole of his folio page, which he calls the Paduan fowls, but in which we recognize what would now be called Polands. His description reads as follows: "There exist cocks for the most part larger than our own, which the common people call Paduan, even as such hens are larger than our own hens. We exhibit a likeness of the male and the female. The male was most beautiful to behold, highly decorated with five different colors; viz., black, white, red, green, and ochre. For the whole body was black. The neck was covered with very white feathers. But the wings and the back consisted partly of black, and partly of green. The tail likewise was of the same color, but the roots of the feathers were whitish. Some of the quill feathers were whitish above. Its head was adorned with a very handsome crest; but the roots of the crest were white. A red spot encircled the eyes. The comb was very small, the bill and feet yellowish. But in the whole hen there was not the least white, except that white skin, which is usual about the openings of the ears, but she was altogether black, shining with green. The feet were light yellow; the comb very small, and scarcely of a red color."

*Characteristics.*—In speaking of the recognized points of excellence in the Polands of the present day, we must separate the black white-crested from the other varieties, since in form

and general appearance a wide difference between them is at once apparent; some features, however, are common to both; these, consequently, claim our first attention.

Thus the disposition and characteristics may be spoken of generally; and certainly in this view they possess, in no inconsiderable degree, all those traits which bespeak our admiration no less than our attention. The cock, though not belligerent, is by no means deficient in courage, and, once engaged, will contend till he finds himself fairly vanquished. His carriage is lofty and upright, and when excited he displays a convulsive movement of the throat resembling that of the Fan-tail Pigeon. The color is of a uniform black, both cock and hen, glossed with metallic green. The head is ornamented with a handsome crest or tuft of white feathers, springing from a fleshy protuberance, consisting of four or five spikes; the wattles long, and of a deep red; the bill in both sexes is distinguished by a peculiar elevation, as also by great width of the nostrils, observable in the youngest chickens. At its base there usually appears the small spike comb, which at its broadest part should never exceed half an inch, and in height it should be much less. From its form and position it has been well compared to the crescent that decorates the Turkish turban. But the cock and the hen are of the same color, only the cock has frequently some white feathers in his tail, which some think a true sign of pure breeding. His carriage is good; the arched neck nearly meeting the tail, which is very full and erect, especially when he becomes excited. The breast is wide and prominent, while the short legs and generally compact form are no less pleasing to the eye than valuable in an economical point of view, as indicative, technically speaking, of the comparativeness of offal. A full-sized Black Poland cock should weigh from five to five and a half pounds.

When we turn to the hen we require the same color throughout, but the top-knot, of course, must be perfectly white, globular, and free from broken colors. Her wattles are rounded and well developed; the ear-lobe white. In form, she is closer built than the cock, full breasted, and should weigh about four pounds.

Mowbray says "the Polanders are not only kept as ornamental, but they are of the most useful varieties, particularly on account of the abundance of the eggs they lay, being least inclined to sit of any other breed, whence they are sometimes called *everlasting layers*, and it is usual to set their eggs under other hens. They fatten as quickly as any other breed, and in quality similar to the Dorking; their flesh perhaps a little more juicy and of a richer flavor. They are a quiet, domestic fowl, neither quarrelsome nor mischievous, and their eggs of a good size, fine flavored, and thin shells."

They do not lay quite so early in the season as some varieties, especially after a hard winter; but they are exceedingly good layers, and continue a long time without wanting to sit. They will sit, however, at length, and prove of very diverse dispositions; some being excellent sitters and nurses, others heedless and spiteful. The chickens, when first hatched, are a dull black, with white breasts, with white down on the top of the head, rising sufficiently high to indicate the breed to which they belong. They do not always grow and get out of harm's way so quickly as some others, but are not particularly tender.

The chickens of the entirely black and the entirely white varieties resemble their respective parents in color, allowing for the difference between down and feather. They are no sooner hatched than peculiarities may be noticed by which they may at once be distinguished from those of any other fowls; viz., the elevated roof of the nostril, the round and prominent appearance of the head, and also the fatty substance, forming a nidus or cushion, from which the future top-knot grows. In the best specimens it is large, and seems to include the whole upper part of the head; in inferior breeds with small top-knots it is but indistinctly developed. Dr. Horner says this test is so accurate, that whenever it is considered desirable to rear only the finest birds, all those which are found wanting in this respect may be safely discarded.

Feathering and growth progress at the usual rate; and when two or three months old, they are certainly most attractive little creatures; their top-knots at this age add to their singu-

larity by giving them a most unique appearance. From the entire absence of the comb at this age, there is the greatest difficulty in distinguishing the sexes (this will apply to all the crested varieties); till their first moult, indeed, it is impossible to decide the point with certainty.

The most critical period extends over about three weeks or a month; for, feathering early, their constitution is severely tested by the heavy drain then made upon it. This point, however, once passed, they are quite as hardy as the chickens of other families; nor have we found them "fixed" or stationary, at any subsequent period of their growth.

However ornamental in appearance, meritorious as layers, and excellent as table fowls, the Polish, or any of the top-knot varieties, are ill-calculated for the vicissitudes of the ordinary farm-yard. Their not being to be depended upon as sitters, their non-laying character during winter, and the care that is required for the chickens in their early days, are objections that are justly urged against them as a farmer's fowl. But whenever the other unquestionable good qualities of this bird, and the beauties of its form and feathering are held to compensate for these drawbacks, we strongly advise a selection from some one or other of the numerous varieties.

As regards food, their consumption may be placed at the same cost as the common fowl—Game fowls being considered the cheapest in point of maintenance, from their vigorous constitution, and the large quantity of natural food that their rambling habits enable them to procure.

#### GOLDEN-CRESTED FOWL.

This, as an ornamental variety, we esteem above all others for their splendid plumage of bright and odd contrasted colors, similar to the Golden-spangled fowl of the English writers. The portraits were taken from specimens in our own yard. In size, they are less than the Black Polanders, and larger than the common sized Bantams, and of beautiful symmetry; bodies rather long and round; tail standing high, and long and full in proportion to the size of the body;

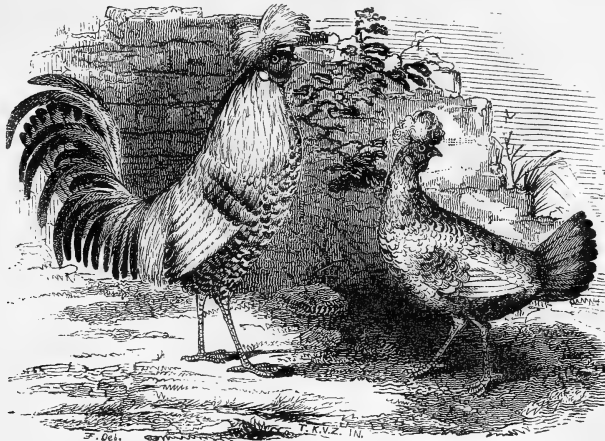

GOLDEN-CRESTED FOWL.

legs bluish. Their color is a dark yellow or rather buff colored ground, with small black spots on the ends of the feathers; crests standing upright, large, open, and of mixed colors. Some of the cocks are a bright red with black breasts; wings spangled with reddish gold color. The carriage of the cock bold and lofty.

They are very scarce, and we have no reliable information as to their origin. We found them in the hands of a gate-keeper on the Great Western Turnpike, near Albany, and he could give no account of their origin. He had bred them for a number of years, and by selecting those of the most odd and fanciful colors for propagation, produced a breed unrivaled in beauty, and as strongly marked in character as the Dorking or Black Poland.

They are good layers; their eggs are small, but rich in quality; flesh white, juicy, high-flavored, and delicate. When young, like all the family of crested fowls, they do not make good sitters—of course do not hatch well. They are a splendid bird, and make a beautiful appearance in the poultry-yard, and are greatly admired. They are rather tender in constitution, and it is difficult to raise their chickens, owing,

probably, to the fact of their having been bred "in-and-in" too long.

Boswell says, in his work on poultry, there is an ornamental sub-variety known as the Golden Poland, with yellow and black plumage.

Some travelers assert that the Mexican poultry are crested; but these, as well as all the rest on the continent of America, have been introduced from another continent. They are equally abundant at the Cape of Good Hope, where their legs are feathered. In Egypt they are very much esteemed on account of the excellence of their flesh, and are said to be so common as to be sold for two-pence or three-pence each.

Boswell says, "The whole breed of crested fowls is much esteemed by the curious, and reared with care." And Buffon says, "There can be little doubt that all the fowls with crests have originated from intercrossing with the Paduan or Polish."

It was from the crested variety of fowls that Mowbray stated he had obtained from five hens in eleven months five hundred and three eggs, weighing, on an average, one ounce and five drachms, exclusive of the shells.

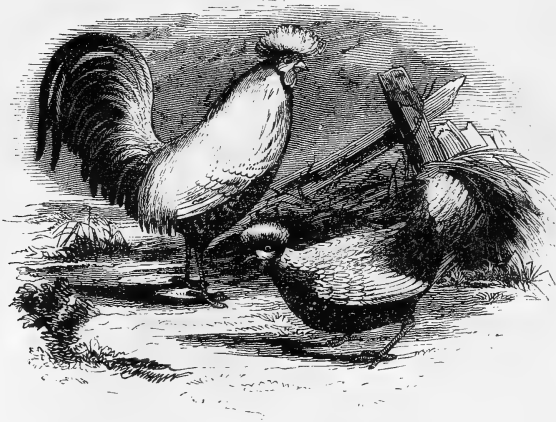

SILVER-CRESTED FOWL.

## SILVER-CRESTED FOWL.

This superb variety of crested fowl is second only to the Golden, before described, in brilliancy of plumage and odd contrast of colors, being of a silvery white ground with curious shaped black spots at the points or ends of the feathers. In size, they are less than the common fowl. The feathers on the crown of the head are longer than the others, and their assemblage forms an upright tuft or bunch, the colors of which are variable; those of the cock are rather an aigrette than a tuft, which gives them a light and airy appearance, and does not annoy or obstruct their sight, as it often does that of the Poland fowl. The comb is double and very small, and their wattles are smaller than those of other breeds. The cock has bluish ear-lobes, and a black collar under his throat.

The hen is considerably smaller than the cock, and is acknowledged, by all who have seen her, the most splendid bird of the gallinaceous tribe they had ever met with. Her colors are similar to the cock, about equally divided, and the dark spots have the appearance of scales. The crown or crest is unusually large, first rising from the head and then falling over, which gives

it more the appearance of a fine double full-blown dahlia than any thing else we can compare it with.

The specimens from which our portraits were taken (and we regret to say the artist has not done them justice), were presented to the author by a friend living on Staten Island, who said they were imported from France, and are said to be very prolific layers. They make quite a showy appearance in the poultry-yard. They are very scarce in this country, nor have we found them described in any of the old poultry books.

Those who desire to propagate any particular variety, must of course keep them apart, and not allow them to intermingle with those of a different color. They are generally esteemed in proportion to the beauty and rareness of their tints. Such are the gold and silver ones, the penciled and spangled, and the white with black crests, which we have often heard of but never seen.

Mr. J. Giles, of Providence, in a letter to the author says, "If eggs are the only object in view, then, as far as my experience goes, the Poland fowls are the best layers, seldom or ever wanting to sit."



THE RUSSIAN FOWL.

## THE RUSSIAN FOWL.

A few of this very singular and unique variety of fowls were imported, in 1842, from Moscow, by Dr. E. Wight, of Boston, from which our portraits were taken. In a letter accompanying the portraits, the Doctor says, "I herewith send you a rough sketch of a cock and hen of the Russian or Siberian fowls. They came to hand a few weeks since, and are perfectly described by 'Dickson on Poultry.' These were procured for me from Moscow, and answer the description well, except that the feathers on the legs are quilled, which they will probably lose in the next generation, our climate being so much milder than at Moscow."

In the fall of 1845 the Doctor sent us a coop containing the original imported fowls, together with several of their produce. They arrived in the latter part of November, while we were in possession of the American Hotel in Albany. On turning them out in the yard they appeared drooping and sickly, and on examination we found them covered and literally alive with vermin, one having died a few days after their arrival. We applied the usual remedy of rub-

bing lard under their wings, on the back of their necks and heads, and sent them into the country in charge of a faithful person, where they could have more room and fresher air, but it was to no purpose, as they all dropped off one after the other—and thus ended the importation of the Russian fowls. This we much regretted, as they were rather pretty though very odd-looking birds.

They were rather under size—that is, they were smaller than the common fowl, but larger than the White Bantam. They stood quite erect, on very short legs, which were thickly covered with fine ordinary feathers. Their plumage was a maroon, spotted with black. The cock had a very small comb and wattles; the hen a comb only. This breed differs from all others that we have seen, in having large tufts of fine black feathers springing from each jaw, and some longer and fuller, not unlike a Jew's beard, from the lower mandible. There was also a tuft of upright feathers of the same silky texture, springing from the top of the head, indicating Polish blood. The long body and singular position in which they stand, particularly the hen, gives them quite a grotesque appearance.

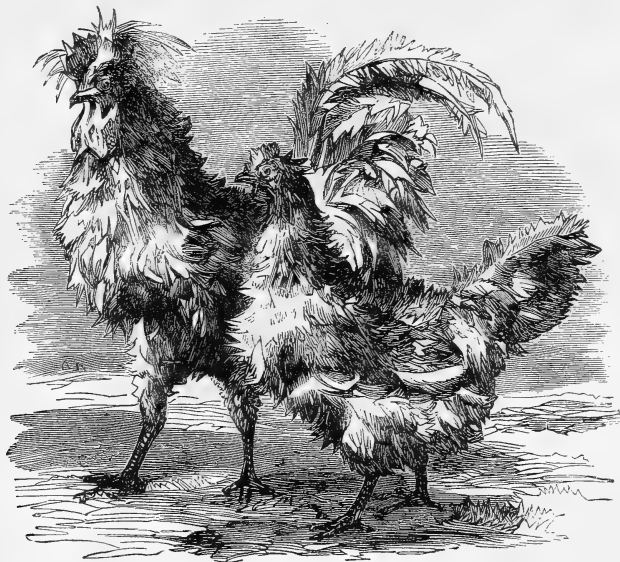

THE CRISP-FEATHERED FOWL.

## THE CRISP-FEATHERED FOWL.

This fowl, we are informed by Mr. Layard, is called in Ceylon, by the Cingalese, *Caprikukullo*. It is rarely met with there, and the natives say they came from Batavia. This agrees with Temminck.

It is the *Gallus crispus* of Brisson, and the *Gallus pennis revolutis* of Linnæus. Sonini and Temminck agree that it is a native of Southern Asia, but that it is domesticated, and thrives well in Java, Sumatra, and all the Philippine Islands. It was long regarded as a mere accidental variety, but is now believed to be a distinct species, and a native of Guiana.

Temminck states that the prevailing color of the wild race is white, and that in these the legs are smooth; but there are many specimens variously colored with black and brown, and some of these have feathered legs.

Our engraving illustrates a newly-introduced

variety, by some supposed to be a native of Japan. Its name of "Crisp-feathered fowl" is given from its grotesque and singular appearance—its feathers being all crisped and projecting outward, giving the bird a very singular aspect, which is well delineated in the wood-cut.

*Description.*—The cock has an upright crest; beak much hooked; hackle slightly tinged with yellow; comb cupped and toothed; ear-lobes white; feathers over the entire body white, and projecting from the body so as to give the bird an appearance of being ruffled, and of having its feathers rubbed in the wrong direction; tail ample, and sickled; legs bluish; height about eighteen inches; weight five and a half pounds.

The hen is entirely white, and with feathers crisped as in the cock; has also a cupped and toothed comb; small, sharp head, with a small crest projecting backward; height twelve inches; weight four and a half pounds.

*Qualities.*—This variety of fowl does not ap-







GOLDEN SPANGLED POLANDS

pear to possess any peculiar advantages, and is more interesting as a curiosity than valued for any practical purposes. The hens are not good layers, and their eggs are small, averaging little more than two ounces each in weight. They are described, however, as good mothers. They breed freely with all other domestic fowls, and the offspring is prolific without end. The chickens are hardy. They are said to be good table fowls, though small.

#### THE GOLDEN-SPANGLED POLAND FOWL.

This fowl is of no ordinary beauty; the cock possesses, in a high degree, all the rich attractions of his class. He is well and very neatly made, has a plump and round body, and no very great offal. When well bred, exceedingly handsome, having golden hackles or an orange red; and the back and saddle of the same glowing tint. The general ground color of the body is a clear ochre-yellow, spangled with black, which, in some shades, becomes a resplendent green. The primary feathers of the wing are also of the same bright ochre, while the wing-coverts are richly laced. The tail is well plumed, its sickle-feathers being dark brown; but the smaller ones on the side are of a deeper tone of ochre laced with black. Below the vent and around the thighs the feathers are black. The legs, in both sexes, must be blue, or of a pale slate color, and perfectly clean; and this holds good with reference to all the other varieties.

The Golden-spangled hen is a most splendid bird, her whole body being still more distinctly marked in the same colors as the cock. The feathers of her breast, neck, and back are all spangled; the wing-coverts, as generally happens in spangled birds, being laced; her tail, also, should be of the same clear tint, laced and tipped with black; while the top-knot is usually dark, and sometimes nearly black.

An accurate description of the precise arrangement and tone of the feathering of the Spangled fowl is, however, a matter of some difficulty, since the best specimens will occasionally vary. Their colors, again, undergo change during the age of the bird; for it is an undoubted fact that Polands generally increase

in beauty for three or four years, and it is not till the third or fourth moult that they attain their full size and brilliancy of feather. The top-knot, too, we should observe, increases up to this period.

Many of them are disfigured by a muff, or whiskers, or beard; but no such birds should be allowed a place in the poultry-yard, but be disposed of at once, either by sale or the fattening-coop.

#### THE WHITE POLAND WITH BLACK CRESTS.

If a white fowl with a black crest ever did exist, it is now regarded, as in all probability, extinct.

An attempt is said to have been made in England, a few years since, to revive the White Polish with a black crest, by crossing the Silver Top-knot with a pure White Top-knot fowl. The experiment failed; but it proved one thing, however: that it will not do to breed from the White Polish as a separate breed; being albinos, the chicks come very weakly, and few survive.

Buffon mentions them as if extant in France in his time. But Dr. Bennett, in speaking of this fowl, says, "This variety of Polish fowl is the most pure and unmixed of the three; it is, indeed, the uncontaminated of the great fowl of St. Jago. Its color is a brilliant white, with a jet black top-knot. This variety was described by Aldrovandus, and more recently by Dr. Bechstein. I have never myself seen a specimen of this breed, and have every reason to believe it to be extinct, or very nearly so. Applications have been made to several persons, in both Germany and Poland, connected with the poultry fancy, for the purpose of procuring specimens of these birds *at any cost*, but the answers returned were, without one exception, that they were no longer to be had."

The following allusion to this bird, taken from the "Poultry Book," may interest our readers:

"The last good specimens I saw," says Mr. Brent, "was in the year 1845, at St. Omer, in France; it was a hen, and belonged to a boat-builder who lived by the canal. She was of large size, so that the Malays in the same yard appeared small in comparison; her color was white, with a large black top-knot, some few of

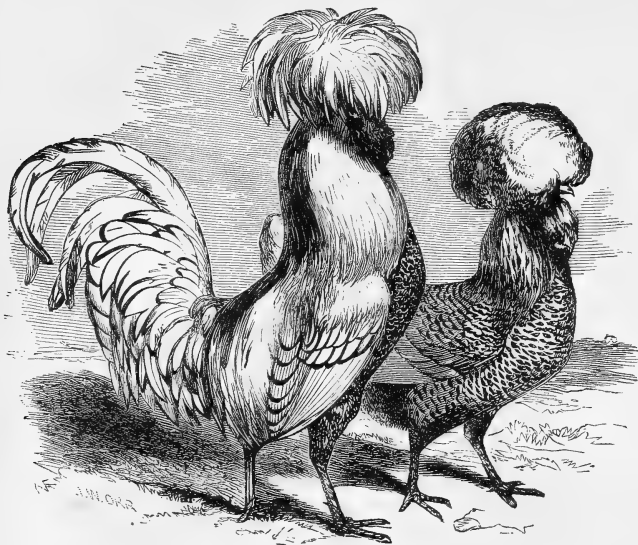

SILVER-SPANGLED CRESTED FOWL.

the feathers of which were, however, tipped with white; her bill and feet were dark slate-color, shape very plump and round. Her owner described her as an excellent layer, the eggs being also of large size. He had endeavored to get others of the same breed, especially a cock, but hitherto without success, although they were said to exist in Brittany."

"Of these old Poles we have little personal knowledge. Occasionally, indeed, we have seen tufted fowls of larger size than the ordinary Polands of the present day, and without any appearance of a comb. These, we presume, were the birds alluded to by Mr. Brent; but our recent inquiries for them confirm the opinion of that gentleman, as regards their present extreme rarity."

## SILVER-SPANGLED CRESTED FOWL.

The Silver-spangled fowls are in all respects similar to the Golden-spangled Poland fowls in shape and markings, except that white, black,

and gray are exchanged for ochre or yellow, and various shades of brown. They are even more delicate in their constitution, more liable to remain *fixed* at a certain point of their growth, and still more require, and will repay, extra care and accommodation. Their top-knots are not, perhaps, so large; but they retain the same neat, bluish legs, and slightly-webbed feet. It is curious that a bird which is quite incapable of swimming should have webs on its feet, while the Gallinule, which swims and dives well, has none.

In both the Gold and Silver varieties, one great point is the regularity and distinctness of their markings; for any thing approaching a splashed or spotted appearance is fatal to their claims. Spangling and lacing are, in fact, constantly united in these birds; for the horse-shoe spangle being continued up the sides of the feather, confers, in some degree, a laced character. At the same time, we are assured that those laced throughout, especially of the Silver kind,





LITH. OF ENDICOTT & CO. N. Y.

PTARMIGAN CHICKENS .

have been produced. The hens of the Silver-spangled Top-knots are much more ornamental than the cocks; though even they are sure to attract notice. They may certainly be ranked among the very choicest and most beautiful of fowls, whether we consider their beauty or their rarity. They lay medium-sized white eggs, much pointed at one end, in tolerable abundance, and when they sit, acquit themselves respectably.

The newly-hatched chickens are very pretty, creamy-white, interspersed with slaty-dun on the back, head, and neck, marked with longitudinal stripes down the back, with black eyes, light lead-colored legs, and a swelling of down on the crown of the head, indicative of the future top-knot, which is exactly the color of a powdered wig, and, indeed, gives the chick the appearance of wearing one. At a very early age they acquire their peculiar distinctive features, and are then the most elegant little miniature fowls it is possible to imagine. The distinction of sex, like the Golden, is not very manifest till they are nearly full grown, the first observable indication being in the tail. That of the pullet is carried uprightly, as it should be; but in the cockerel it remains depressed.

#### PTARMIGAN FOWL.

This curious, unique, and very interesting variety of domestic fowl was first introduced to notice at a Poultry Show, held at the Baker Street Bazaar, in London. In the *Cottage Gardener*, of August 4th, 1853, we find the following: "The greatest novelty here were the Ptarmigans, exhibited by Dr. Burney, of Brockhurst Lodge. The old birds are almost as small as the Dumpies; white, with slightly-colored hackle; white crests, and remarkably well feathered or booted legs. The combs are cupped, and the cock's tail is well sickled.

"The chickens exhibited of this breed were eminently attractive; they are of the purest white, light and sylphid in form, remarkably deeply vulture-hocked and booted. They were rapid and gliding in their movements, and timid, we should think, from being so repeatedly hunted by the visitors to show themselves, for the parents are sufficiently sedate.

"Dr. Burney informed us that they did not care for corn and the usual food of chickens, but preferred ants' eggs, and the insect food of a pasture.

"However partial the domestic fowl may be to food of this description, it rarely happens that their usual granivorous habits are laid aside to the degree that is represented as occurring in this case. This circumstance, in conjunction with their singular combination of top-knot and booted legs—features that hitherto have rarely, if ever, been sanctioned by public taste—induced us to apply to Dr. Burney for any further information that he might be able to afford us relative to these curious birds. In answer to our inquiries, the following communication has most kindly been sent to us by that gentleman: 'In reply to your letter respecting the Ptarmigan fowls, I have much pleasure in giving you all the information that I am possessed of, which amounts to this—that a gentleman in his travels, I believe in the north of Europe, brought home a couple of these birds, and gave them to a connection of mine, from whom they passed into my possession.

"I did not at the time place much value on them; since, from their confinement and moulting, their beauty was for some months unobserved; but being kept by themselves, their first clutch of chickens elicited the admiration of my neighbors, and induced me to pay more attention to their merits, so that I have now no hesitation in stating my opinion that they will prove a most valuable addition to the domestic fowls of this country. They are elegant in their form, and graceful in their movements; excellent layers, and of hardy constitutions. Their habits and, in part, their appearance, resemble those of the Ptarmigan—berries and insects being preferred by them when allowed to roam in the woods which surrounded my residence; still, when confined to a yard, they manifested no discontent, and the extreme beauty of their appearance, their form and color, their splendid top-knots and profusely-feathered legs and feet, have gained them many admirers among the best judges of the poultry-yard."

A writer in the *Poultry Chronicle* says: "My impression of that account is, that Dr. Burney was

uncertain whence he had first obtained them; but that he had kept them for several years, and had found them hardy, prolific layers, and good table-birds; and that from their shape, active habits, fondness for insects and such other food as they could themselves discover, and because of the profusion of feathers on their legs, extending to the points of their toes, he named them Ptarmigans.

"As Ptarmigans they were shown at several exhibitions, and had prizes awarded; and being in shape, carriage, and in color (silver-white), very attractive birds, and, from their activity of leg and wing, admirably adapted to ornament the lawn and pleasure-grounds, considerable attention was given them. Many pens were bought at long prices, and eggs were sold at five guineas the sitting.

"The mystery as to their origin and the country from whence they had come, does not seem to have been taken to and petted by the public, as mysteries sometimes are; and after some months little or nothing was said about the Ptarmigans, except by the few who had kept and admired them, not less for their useful than their pleasing qualities.

"Early in September, 1853, a pen of fowls were shown at the exhibition of the Devon and Cornwall Poultry Society, as *Turkey fowls*, by Mr. Snow, the gardener to the Earl of Morley. The judge on the occasion, the Rev. W. W. Wingfield, thought these birds had some affinity to the Ptarmigans, although in many respects unlike them. Shortly after this a gentleman, who had bought some chickens of Dr. Burney, brought them to Plymouth, and they were seen by me; the result being inquiries which led to the discovery of fowls of the same breed in the neighborhood of Plymouth, and that Dr. Burney's fowls were obtained from the same stock as those shown by Mr. Snow as 'Turkey fowls.'

"Further inquiries have furnished the reason of their being called Turkey fowls. It appears that some twelve or fourteen years since, W. Soady, R.N., asked his friend, J. E. Elworthy, Esq., if his son, who was then at Galatz, could bring home any thing from that country for him. Mr. Elworthy, being a poultry-fancier, replied,

that if he could obtain for him any white-legged fowls he should be obliged. Some months after this, a seaman brought to Mount Plym three odd-looking creatures, almost without feathers; the color of the few left being very uncertain, by reason of the dirty state they were in. Mr. Elworthy was not at home at the time, and when he came, having forgot his request to Mr. Soady, was puzzled as to whence and how this new importation could have been made. The conversation with his friend was subsequently brought to his mind. The birds soon got feathers, and looked very handsome. On seeing Mr. Soady, he learnt that they were bought in Constantinople market, and that during a rough passage home the fowls had been a good deal kicked about, the cock having been washed overboard and recovered in the Mediterranean.

"They proved favorites with their new owner, and evidently prospered in this country. He found them good layers, and but seldom disposed to sit; but having raised some chickens, he presented the imported birds to Sir W. Burnett. Some of the fowls subsequently passed into the possession of Colonel J. Elliott, G. T. Shortland, Esq., of Lipson, and others.

"At Lipson the breed has been kept pure to the present time. From Lipson some chickens were taken to Glassbrook, Devon, by Mr. Lowe, and others, their produce, presented to Mrs. Dr. Burney, now some years since. For several years they ran about Dr. Burney's house, but little talked about, or perhaps noticed, until some keen poultry-fancier made an offer to purchase the stock, that induced the Doctor to open his eyes, in surprise, at their value. This, I presume, will be thought sufficient to settle the fact of Dr. Burney's Ptarmigans being the descendants of the fowls brought from Turkey by young Mr. Soady some thirteen or fourteen years since; but if any doubt be possible, add another fact: when Dr. Burney was aroused to the value of his fowls, he applied to Mr. Stanly Lowe, from whose family they had come to the Doctor's hands, to buy him up all the sort he could, and, as I am told, offered a high price for his own stock. Mr. Lowe let the Doctor have his own stock, four birds, but could not induce Mr. Shortland to part with his.



"One word as to the country whence these fowls have been brought. Since I first saw the Ptarmigans of S. P. Smyth, Esq. (who bought from Dr. Burney), and from which my chickens, that took the prize at the recent show at Plympton, were bred, two gentlemen of this neighborhood have had brought to them fowls of the same description from Constantinople. Captain T. Russell, now commander of the well-known *Himalaya*, recently in the Black Sea, early in the present year (1854) brought home three fowls purchased in the Constantinople market which are clearly the same sort as Dr. Burney's Ptarmigans, and Mr. Blackwell, of Stoke, Devonport, had sent him some of the same description in return to a request to a friend, not a poultry-fancier, to send him home some of the ordinary fowls of the Bosphorus."

"When the Ptarmigans made their *début* last season," says a writer in the *Poultry Chronicle*, "every one was asking, 'What are their merits?' but from want of certain facts to go upon, a satisfactory answer was not returned to the query. I now, however, send you the doings of four hens of mine, extracted from my egg-book, giving the number of eggs laid by them from the 1st of April to 27th of May. And I am quite content to leave it to you to decide whether the product, added to their extreme beauty, does not entitle them to a higher rank than that of mere 'fancy fowls.' I may add, that my experience leads me to place them among the non-sitting varieties. My four hens laid in April, 90, and up to May 27, 89 eggs; total, in fifty-nine days, 179 eggs!"

#### THE DOMINIQUE, OR CUCKOO POLAND.

This is a handsome bird, but as yet hardly known in England. "The best specimens," say the writers of the "Poultry Book," "we are aware of are limited to the yard of Mr. Vivian, the well-known cultivator of the Polish varieties. The blending of the different shades of gray, that form the cuckoo plumage, is here most delicately displayed. The hens are wholly of this feathering; but in the cock it is seen on the breast only, white predominating on their backs, wings, and tails. They are bearded, and have top-knots nearly white.

"What we have termed the Gray, or Grizzled Poland, has the plumage of the Penciled Hamburgs in their relative sexes, but without the clearness that would be insisted on with the latter breed. They are heavily bearded, with top-knots of full dimensions, and, from their uniform appearance and very robust form, are attractive objects in any poultry-yard.

"The pair that we now possess came from a clergyman near Bridport, who has bred them for twelve years without crying back in the chickens—a strong test of a pure descent; which, from their manifest resemblance to the feathering of the Penciled Hamburgs, might possibly be called in question.

"The two next varieties that stand on our list—the Black and White Speckled, and the Blue with White Top-knots—we have never seen; but they have been noticed on the Continent by one of our best Polish fanciers.

"The Yellow-spangled Poland is probably the most beautiful of its class; and here, as with the Cuckoos, we are indebted to Mr. Vivian, who introduced them into this country.

"In both sexes the top-knot and beard are white, with a very slight admixture of yellow feathers. The cock's hackle, back, and wings are yellow, with occasional white feathers; the tail yellow and white, with a preponderance of the latter; but his breast is yellow, perfectly spangled with white, which is also the case with the hen's neck, breast, and back; her wings are yellow, the wing-coverts laced with white, the tail feathers being also similarly tipped.

"The extreme softness of the bearded Poland's feathers is very remarkable in this variety. The plumes on the higher part of the shaft especially, rivaling in texture the softest floss-silk.

"Here, also, we have an example of our previous remark, that Polands go on improving in plumage, as well as size, till the third or even the fourth year; since, in these yellow-spangled birds, their more delicate tints are but imperfectly developed in their first season, the beard especially remaining of a pale-dun color, and the top-knot of a still darker tint; and this improvement is continued till the full period we have before mentioned."



THE SERAI TAOOK, OR SULTAN'S FOWL.

## THE SERAI TAOOK, OR SULTAN'S FOWL.

These fowls were sent from Constantinople to the editress of the *Poultry Chronicle*, published in London, by a friend living there, in January, 1852.

"A year before," she says, "we had sent him some Cochon China fowls, with which he was very much pleased; and when his son soon after came to England, he could send from Turkey some fowls with which we should be pleased. Scraps of information about muffs and divers beauties and decorations arrived before the fowls, and led to expectations of something much prettier than the pretty Ptarmigans, in which we had always noticed a certain uncertainty of tuft and comb.

"In January, they arrived in a steamer chiefly manned by Turks, we should fancy much dirtier and in worse plight than the arrival at Mount Plym. The voyage had been very long and rough, and poor fowls so rolled over and glued into one mass of filth were never seen. Months afterward, with the aid of one of the first fanciers in the country, we spent an hour in trying to ascertain whether the feathers of the cock were white or striped, and almost concluded that the last was the true state of the case, although they had been described by our friend as '*Bellissimi galli Beanchi*.'

"We at once saw enough to make us very unwilling to be entirely dependent for the breed on the one sad-looking gentleman, with his tuft heavy with dirt for a mantle,

and his long, clogged tail hanging round one side.

"We wrote directly for another importation, especially for a cock, and to ask the name they had at home. In answer to the first request, we found that good fowls of the kind are difficult to get there; our friends have ever since been trying to get us two or three more; but can not succeed either in Constantinople or other parts of Turkey; the first he can meet with will be sent. With regard to the name, he told us they were called 'Serai Taook;' Serai, as is known by every reader of Eastern lore, is the name of the Sultan's palace. Taook is Turkish for fowl; the simplest translation of this is 'Sultan's Fowls,' or 'Fowls of the Sultan;' a name which has the double advantage of being the nearest to be found to that by which they have been known in their own country from which they came.

"Time very soon restored the fowls to perfect health and partial cleanliness; but it was not until after the moulting season that they showed themselves as the '*Bellissimi galli Beanchi*,' described by our Constantinople friend.

"They are superior to the Ptarmigan in general character, resembling rather our White Polands, but with more abundant furnishing, and shorter legs, which are vulture-hocked, and feathered to the toes.

"In general habits they are much like other fowls, brisk, and happy-tempered; but not kept in as easily as Cochin Chinas. They are very good layers; their eggs are large and white; they are non-sitters and small eaters. A grass run with them will remain green long after the crop would have been cleared by either Brahmans or Cochins, and with scattered food they soon become satisfied and walk away.

"They are the size of our English Poland fowls; but it seems likely that the young ones will be rather larger. Their plumage is white and flowing. They have a full-sized, compact Poland tuft on the head; are muffled, have a good flowing tail, short, well-feathered legs, and five toes upon each foot. One fowl, which came over with them, was exactly like the Ptarmigan; we have met with a very few such from Constantinople, but never saw any of exactly the same kind as our own Serai Taook."

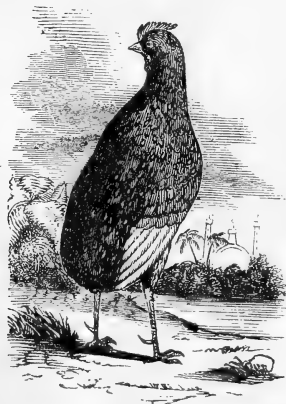

## CHAPTER VIII.

## INCUBATION.

In hatching of poultry, as in most other things, nature is the best guide; and nature designs that every hen shall sit upon her own eggs, and hatch her own progeny. But the domestic fowl is in an artificial state, and deviations from the laws of nature are, therefore, to be expected. A wild hen will lay no more eggs than she can conveniently cover, and her periods for laying and for incubation will be fixed and regular. Some lay every day, or every other day, for nine months out of the twelve, and rarely evince a desire to incubate; while others manifest this desire, some at one period, and others at another period. Among a flock of hens these diversities will show themselves, and advantage may be taken of them with benefit to their owner.

It is well known that when a certain number of eggs has been laid, the hen shows an inclination to sit. She has a peculiar sort of clucking, and a feverish state ensues, in which the natural heat of the hen's body is very much increased. The inclination soon becomes a strong ungovernable passion, which appears a blind instinct; for she will sit upon one egg or twenty, upon a piece of chalk or a stone; and if fresh eggs are supplied, she will sit for six weeks. In this state she flutters about, hangs her wings, bristles up her feathers, searches in every nook and corner, evidently ill at ease, for eggs to sit upon; and if she finds any, she immediately seats herself upon them. In high-fed hens this instinctive desire comes on sooner than in such as are not supplied with food in abundance, and it may be induced by stimulating diet, a little raw liver, and fresh meat, chopped small, potatoes mashed warm, with milk and coarse corn meal.

By high feeding, some hens—especially the Dorking, Cochín, or Shanghai breeds, which are sitters, and take the pre-eminence over all other breeds—may be induced to sit in October, especially if they have moulted early. Advantage may be taken of this circumstance at the South, and chickens may be obtained fit for the table by Christmas—not, however, without great care and trouble. The incubation must take place, and the chickens be reared and fed, in a warm room, if necessary, kept at an equal temperature. Generally speaking, spring chickens are more desirable, which should be hatched in the latter part of January or first of February, so as to be ready for the market in May and June. They require great care, but they return an ample profit.

The most usual time in which hens manifest a desire to incubate, extends from March to April, May, and June, and at this season chickens may be reared without any extraordinary precautions.

A hen is generally ill to please in the choice of her nest. The hen and duck, if left to themselves, find some dry, warm, sandy hedge, or bank, in which to deposit their eggs, forming their nests of moss, leaves, or dry grass. In this way the warmth is retained in the nest for the few moments she devotes to her hurried and scanty meal. When the determination becomes fixed—there is no need to indulge the first faint indications immediately—let her have the nest she has selected, well cleaned and filled with fresh straw or hay, underlaid with dry wood-ashes or tobacco-stems, as they produce the effect of destroying or preventing vermin, by which they are apt to be infested at that time. The number of eggs to be given to her will de-

pend upon the season, and upon their and her own size. The safest plan is not to be too greedy. The number of chickens hatched is often in inverse proportion to the eggs set. We have known only four or five to be obtained from eighteen eggs. Where every thing was agreeable we have known instances in which all the eggs, to the number of sixteen, have been hatched. Hens will in general cover from eleven to thirteen eggs, if laid by themselves. Sometimes the hen may lay more eggs, or others lay in the same nest; in such cases we have found it necessary to mark the eggs with ink, and if fresh ones should be laid, they could be readily distinguished and removed, as they would be too late in hatching.

If a hen is really determined to sit, it is useless, as well as cruel, to attempt to divert her from her object. The means usually prescribed are such as no humane person would willingly put in practice. If the season is too early to give a hope of rearing gallinaceous birds, the eggs of ducks or geese may generally be had, and the young may be brought up with a little pains-taking, as well as by their natural parent. And if it be required to retain the services of the hen for expected valuable eggs, she may be beguiled for a week or two with four or five addled or glass eggs, till the choice ones should be received.

For hatching and to have eggs productive, they must be fresh, and must not be exposed to noxious effluvia or moisture. Those intended for incubation should always be gathered with more care than if they were merely to be employed for aliment. They should be of an average size and ordinary form, avoiding very small eggs, which have generally no yolk, and those which are ill-shaped, or of equal thickness at both ends, as the latter are the usual shape of such eggs as have double yolks, which, though good for culinary purposes, are not so for hatching; for if they prove productive, the produce is generally monsters with two heads, four legs, and the like. Instances have occurred, but rarely, where two and even three chickens were hatched from one egg.

It has generally been found that hens which are the best layers are the worst sitters. Those

which we have found best adapted for that purpose have short legs, a broad body, large wings well furnished with feathers, their nails and spurs not too long or sharp.

During the period of incubation a good sitter will not leave her nest for more than a few minutes at a time, to provide her food, and at intervals of from one to three days. So powerful, too, is this instinct, that they have been known to remain on their nests until they have perished with hunger. To prevent such an occurrence, it has been recommended to feed them daily in this situation; but from our experience it seems the best plan to let them follow the dictates of their own instinct, and when they desire food and water, let them seek it in the poultry-yard.

After twenty-one days a good sitter will bring out her chickens, and as soon as she becomes a mother her whole character is changed. From being peaceful and cowardly, she becomes a noisy termagant, fighting with all her female friends, and avoiding chanticleer as her most dreadful foe. All her former feelings and habits become absorbed in increasing maternal solicitude. She turns out to be frugal, generous, sober, reserved, courageous, and intrepid. She assumes, indeed, all the qualities of the cock, and even carries them to a higher degree of perfection. When we see her come into the poultry-yard, surrounded by her little ones for the first time, it seems as if she were proud of her new dignity, and takes a great pleasure in performing her duty. Her eyes are lively, animated, and constantly on the alert; her looks are so quick and rapid that she could take in every object at one glance; and she appears to discover at once the smallest seed on the ground, which she points out to her young ones; and in the air, if she discovers the bird of prey, she dreads for their sake, and giving them warning by a peculiar cry, she induces them immediately to hide themselves.

Incessantly taken up with their welfare, she excites them to follow her and to eat; she picks them food; she scratches the ground in search of worms which she gives up to them; she stops now and then, squats down, opens her wings, and invites her tender brood to come and

gather around and warm themselves beneath her. She continues to bestow these cares on them until they are quite feathered, when they are fit to shift for themselves.

The first day after hatching, the chickens do not want to eat, and should be left in the nest. The next day, the whole brood being hatched, the hen with them may be removed and placed in a box with high sides, if the weather be cold or wet; or put under a coop, upon a dry, sheltered spot, and, if possible, not within reach of another hen, since the chickens will mix, and the hens are apt to injure, and often kill such as do not belong to them. Nor should they be placed near other fowls, as they would rob them of their food.

Their first food may be eggs boiled hard and chopped fine, or curd broken fine; coarse corn meal or millet, fed sparingly, a little at a time and often at first, as, from our experience, we are certain more chickens are destroyed by over-feeding than are lost by the want of it. We have remarked also, that hens which stole their nests generally hatched all the eggs; and if suffered to seek the food for their chickens, if the season be somewhat advanced, they would, unless some casualty occurred, raise the whole of their broods, while with too much kindness or officiousness, not half would be raised. All watery food, such as soaked bread, or potatoes, should be avoided. If Indian meal is well boiled, and fed not too moist, it will answer a very good purpose, particularly after they are eight or ten days old. Pure water must be placed near them, either in shallow dishes or bottle-fountains, as in page 77, that the chickens may drink without getting into the water, which, by wetting their feathers, benumbs and injures them. After having confined them for five or six days in the box, they may be allowed the range of the yard if the weather is fair. They should not be let out of their coops too early in the morning, or while the dew is on the ground, far less be suffered to range over the wet grass, which is a common and fatal cause of disease and death. Another cause of the utmost consequence to guard them against, is sudden, unfavorable changes of the weather, more particularly if attended with rain. Nearly all the dis-

eases of gallinaceous fowls arise from cold moisture.

At the end of four weeks the hen may be allowed to lead her little ones into the poultry-yard, where she will soon leave them and commence laying again. It should be the aim to have some of the hens hatch as early as possible, so that the chickens will attain a good size by the first of July; and, if fat, will return the best profit in market, in proportion to their age and food consumed. They are naturally most fat at six weeks old, or about the time they leave the hen, and have not run off their brooding flesh by exertion for food and by growth. Particular birds can be selected for breeding stock, as their color and form will be by that time apparent, so as to make the choice with safety; also, it will be easy to tell the males from the females.

If their keep costs nothing, and they are raised near or are convenient to a market, they may, in some cases, be advantageously retained till the holidays, when they seldom fail to command a ready sale and a good price; but if a large number are raised, they will, of course, require to be marketed regularly. Of this, however, the farmer will be the best judge. In many cases it will be more advantageous to sell to the *dealers*, who travel the country in all directions with wagons prepared to take the fowls from the yard, and pay cash price sufficiently liberal to return a handsome profit to the breeder.

The process of incubation of the chicken is a subject curious and interesting to the student of nature. It generally takes twenty-one days to hatch a brood of chickens, although a close-sitting hen will sometimes hatch in eighteen days, if the weather is favorable. The expiration of the time should be carefully watched for; not that the chicken requires any assistance, but, on the contrary, interference with them is much more likely to injure than benefit them; a healthy chick will perform all that is required to free it from the shell. It is truly wonderful the power they possess while rolled up in so apparently helpless a mass; but so it is, and the head, that makes the most exertion, is placed so as to leave room for reaction, and



to turn round, and thus to peck a circle, as seen in the above illustration, and breaks a circle around the large end of the shell, admitting the air by degrees, until it becomes gradually prepared to extricate itself. A rash attempt to help them by breaking the shell, particularly in a downward direction toward the smaller end, is often followed by a loss of blood, which can ill be spared, and death ensues.

The following account of the wonderful changes which an egg undergoes in hatching, from the first day till its final exclusion, is particularly interesting, and is taken from an English journal. By means of the Eccaleobion and hatching-ovens, many interesting facts have been discovered, and are described with great minuteness.

"The hen has scarcely sat on her eggs twelve hours before some lineaments of the head and body of the chicken appear. The heart may be seen to beat at the end of the second day; it has at that time somewhat the form of a horseshoe, but no blood yet appears. At the end of two days, two vesicles of blood are to be distinguished, the pulsation of which is very visible; one of these is the left ventricle, and the other the root of the great artery. At the fiftieth hour, one auricle of the heart appears, resembling a noose folded down upon itself. The beating of the heart is first observed in the auricle, and afterward in the ventricle. At the end of seventy hours, the wings are distinguishable; and on the head two bubbles are seen for the brain, one for the bill, and two for the fore

and hind part of the head. Toward the end of the fourth day, the two auricles already visible draw nearer to the heart than before. The liver appears toward the fifth day. At the end of a hundred and thirty-one hours, the first voluntary motion is observed. At the end of seven hours more, the lungs and the stomach become visible; and four hours afterward, the intestines, the loins, and the upper jaw. At the hundred and forty-fourth hour, two ventricles are visible, and two drops of blood instead of the single one which was seen before. The seventh day, the brain begins to have some consistency. At the hundred and nineteenth hour of incubation, the bill opens, and the flesh appears in the breast. In four hours more, the breast-bone is seen. In six hours after this, the ribs appear, forming from the back, and the bill is very visible, as well as the gall-bladder. The bill becomes green at the end of two hundred and thirty-six hours; and if the chicken be taken out of its covering, it evidently moves itself. The feathers begin to shoot out toward the two hundred and fortieth hour, and the skull becomes gristly. At the two hundred and sixty-fourth hour, the eyes appear. At the two hundred and eighty-eighth, the ribs are perfect. At the three hundred and thirty-first, the spleen draws near the stomach, and the lungs to the chest. At the end of three hundred and fifty-five hours, the bill frequently opens and shuts; and at the end of the eighteenth day, the first cry of the chicken is heard. It afterward gets more strength and grows continually, till at length it is enabled to set itself free from its confinement.

"In the whole of this process we must remark that every part appears at its proper time; if, for example, the liver is formed on the fifth day, it is founded on the preceding situation of the chicken, and on the changes that were to follow. No part of the body could possibly appear either sooner or later without the whole embryo suffering; and each of the limbs becomes visible at the first moment. This ordination, so wise and so invariable, is manifestly the work of a Supreme Being; but we must still more sensibly acknowledge His creative powers, when we consider the manner in which the chicken is formed out of the parts which com-

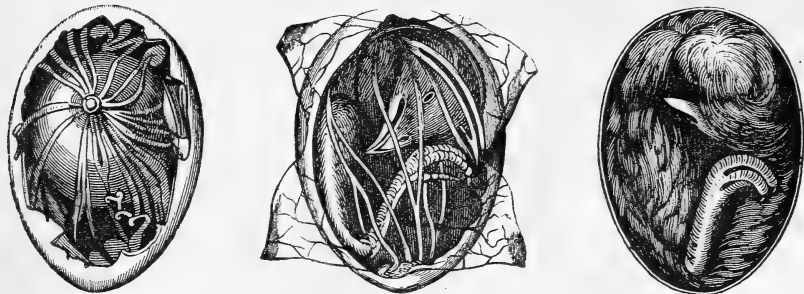

FIRST, MIDDLE, AND LAST STAGES OF THE CHICK.

pose the egg. How astonishing it must appear to an observing mind, that in this substance there should at all be the vital principle of an animated being; that all the parts of an animal's body should be concealed in it, and require nothing but heat to unfold and quicken them; that the whole formation of the chicken should be so constant and regular that, exactly at the same time, the same changes will take place in the generality of eggs; that the chicken, the moment it is hatched, is heavier than the egg was before! But even these are not all the wonders in the formation of the bird from the egg—for this instance will serve to illustrate the whole of the feathered tribe—there are others altogether hidden from our observations, and of which, from our very limited faculties, we must ever remain ignorant."

#### ARTIFICIAL HATCHING.

The method of artificial hatching, or the process of bringing the vitalized embryo of the egg through all its stages of development, until the chick makes its exit from the shell, by *artificial* heat, has long been practiced in China and Egypt, but has never, we believe, until recently, been attempted in this country. It is, however, resorted to in some countries to a considerable extent, and experiments in England, France, and our own country have been successful; but whether the plan will ever become general is questionable.

The first notices we have of hatching chickens artificially, without the aid of hens, are to

be found in Aristotle and Pliny. The latter mentions that the Roman empress, Livia, hatched an egg by carrying it about in her "warmed bosom;" and this probably gave origin to the device of late to lay eggs in some warm place, and to make a gentle fire underneath of small straw or light chaff, to give a kind of moderate heat; but, even more, the eggs must be turned by man or woman's hand both night and day; and so at the same time they looked for chickens and had them.

The art has been extensively practiced in Egypt and China from an unknown period of time. In the former place immense numbers of eggs are hatched by heat in ovens or mammels, and officers are appointed by government to superintend the process, and receive a part of the produce as pay. About the middle of January the ovens are inspected and repaired; and as they are public, and as each has a circuit of fifteen or twenty villages, notice is given to the inhabitants, so as they may come and bring their eggs. As soon as a suitable quantity of eggs is collected together, they are put into the rooms that are to serve for the first brood; for the whole of the ovens are never employed at once on the same brood, but only one half of those which the building contains.

It is asserted by Barron that it is practiced by the Chinese families who live constantly on the water. They deposit the eggs in sand, at the bottom of wooden boxes, placed on iron plates and kept moderately heated.

As there is no prospect of any of our coun-



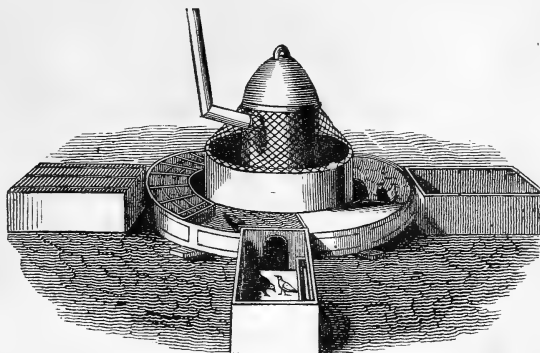

REAUMUR'S HATCHING APPARATUS.

trymen entering into the business on the Egyptian method, we will not detain the reader by a description of these ovens; other and less expensive plans have been adopted. The same feat performed by Livia has been accomplished in New Jersey, where a lady in Monmouth County patiently hatched two chickens, which she successfully raised. Some French ladies have in the same way proved themselves mothers of canaries and other birds.

"On this," says Ames, "I have heard an amusing anecdote, which I give as a hint for the advantage of those similarly situated. I am sure its veracity may be relied on. An industrious farmer's wife in New Jersey had a husband, or a thing she was obliged to call so, who was intemperate, hypochondriac, and lazy; and after a debauch would sometimes remain in bed for several weeks, from which no persuasion or art could rouse him. His active *ribs* hit upon an expedient to turn this to account, and immediately put it in practice. She procured a quantity of fresh eggs, and rolling them in wool and flannel, placed them around him in the bed so as to receive the necessary warmth, and in due time were brought forth a pretty flock of chickens. It was then farther surmised that, finding him more useful in this capacity of an old hen than in any other, she encouraged him, by 'tiny drops,' to lengthen his periods of incubation."

But to return to the hatching apparatus. Many experiments have been made, especially by the celebrated French naturalist and philosopher, M. Reaumur, under the immediate attention of the French king, which were published in a treatise of five hundred pages, with plates. It states that he found the proper degree of heat to be about ninety degrees of Fahrenheit. He thinks it perfectly practicable.

Oliver de Serres, the father of French agriculture, describes a little portable oven, of iron or copper, in which eggs were arranged and surrounded with feathers, and covered with soft cushions, heat having been communicated by means of four lamps, but he says it was more curious than useful.

The incubation of chickens by hot water is said to be the invention of M. Bonnemain, of Paris. The illustration on the following page is a section of his apparatus, consisting of a boiler, *a*; a box or building, *b*, for hatching eggs; a cage or coop, *c*, for rearing the chickens; tubes, *d*, for circulating the hot water; a supply tube, *h*, and funnel, *e*, and safety tube, *f*. Supposing the water heated in the boiler, it will rise by its specific gravity through the tube, *d*, move backward and forward through all the tubes, and return again to the boiler at *k*, which is inserted in the top like the other, but passes down to its lower part, *l*. This circulating movement once commenced, continues

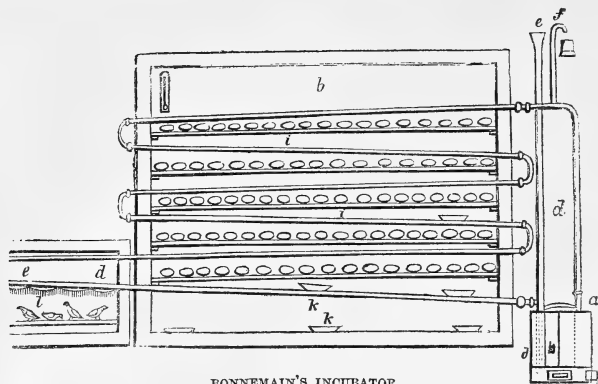

BONNEMAIN'S INCUBATOR.

so long as the water is heated in the boiler, because the temperature is never equal throughout all parts of the apparatus. We may readily conceive that a perfect equality of temperature can never exist, on account of the continual loss of heat, which escapes from the exertions of all the tubes. Meanwhile the temperature of the air inclosed in the box differs but little from that of the numerous tubes which traverse it; and as the bends of the tubes on the outside of the box afford but little surface to be cooled by the surrounding air, so the force of the circulation, which is always in the ratio of the difference between the temperature of the waters passing out of the calorifere and re-entering it, does not become greatly diminished, even after having expended a large portion of its heat on the outside of the box, in maintaining a gentle heat in the cage, *c*, adjoining to it. We see, therefore, the more the water is cooled which passes through the last circumvolutions of the tubes, the more active is the circulation in all parts, and consequently the more equal is the temperature of all the tubes which heat the box, and of the air within it; indeed, to prevent the loss of heat as much as possible, the boiler, and all those parts of the tubes which are placed on the exterior of the box, are enveloped in lists of woolen cloth. M. Bonnemain having thus applied these principles with so much skill, is always enabled to maintain in these boxes an

equal temperature, varying scarcely so much as half a degree of Reaumur's thermometer; but as if it was not sufficient to have thus far resolved the problem, he contrived that this degree of temperature in all parts of the stove should be maintained at that point which was found most favorable for promoting incubation. It was by means of an apparatus for regulating the fire that he attained this desirable object. The action of this regulator is founded on the unequal dilation of different metals by heat. A movement is communicated near to the axis of a balanced lever, which lever transmits it by an iron wire to a register in the ash-pit door of the furnace. Combustion is by these means abated or increased.

*When we would hatch chickens by hot water,* we light the fire and raise the temperature till we obtain that degree of heat in the box which is fitted for incubation; we then place the eggs near to each other upon the shelves with boilers to them. It is convenient not to cover, on the first day, more than a twentieth part of the superficies of the shelves, and to add every day, for twenty days, an equal quantity of eggs; so that we may obtain every day nearly the same number of chickens; but which, nevertheless, may be occasionally regulated by the particular season of the year.

During the first days of incubation, whether natural or artificial, the small portion of water

contained within the substance of the egg evaporates through the pores in its shell; this is replaced by a small quantity of air, which is necessary to support the respiration of the chick; but as the atmospheric air which surrounds the eggs in the box at that degree of temperature is either completely dry or but little humid, so the chick would greatly suffer, or finally perish from this kind of desiccation. The aqueous vapor which exhales from the breathing of the old fowls while hatching, in some degree prevents this ill-effect; but nevertheless, in dry seasons, the vapor is hardly sufficient, and thus, in order that the eggs may be better hatched in the dry seasons, the hens cover them with the earth of the floor of the granary. In artificial incubation, to keep the air in the stove constantly humid, they place in it flat vessels, such as shallow dishes, filled with water. When the chickens are hatched, they are removed from the stove and carried to the cage, where they are fed with millet, and nestle under a sheepskin with wool on it, suspended over them. They also separate, by means of partitions in the cage, the chickens as they are hatched each day, in order to modify their nourishment agreeably to their age. Artificial incubation is exceedingly useful in furnishing young fowls at those seasons when the hens will not sit, and, in some situations, to produce, or, as we may say, indeed, to manufacture, a great number of fowls in a small space.

A method somewhat similar to M. Bonnemain's, to which a long Greek name has been given, has been put in operation at Pall Mall, London, and exhibited at 25 cents each person. In *Chambers's Edinburgh Journal* is a description of the *EcCALEOBION*. It is a room on one side of which is a large oblong case placed against the wall, divided into eight parts, each one of which is warmed by steam pipes, and which are used for hatching the eggs. The bottom of these boxes or parts, and indeed the whole, is lined with cloth, and is covered with eggs lying at a little distance from each other. There is a jug of water in each part to preserve a proper degree of moisture to the air in the divisions. The meaning of having eight boxes is to insure a batch of chickens every two or three days.

Each part holds some two or three hundred eggs, or about two thousand in the whole. From twenty-one to twenty-three days are required to hatch the eggs, and as those are purchased in the market, from one-third to one-half prove worthless. None but new eggs should be used for the *EcCALEOBION*.

When the chickens appear they are not immediately removed from the oven, but remain a few hours until dry, when they are taken from the oven and put into a glass case or box made shallow and the sash-lid easily removable. They are not fed for twenty-four hours after hatching, and the material then used is a coarse meal grit, which they pick up with great eagerness—instinct, in this case, supplying the want of the mother. They are kept in this case two or three days, when they are put into divisions on another part of the floor of the same large and warm apartment. At dusk they are put into a coop or box, with a flannel curtain and covering, where they rest with as much quietness as under the wing of the mother. In the morning they are turned into the yard, which is cleaned and strewn with sand. When three weeks or a month old they fetch in market one shilling each. It thus appears that all that is necessary to form a chicken establishment is suitable rooms and a steady supply of the proper heat, fresh eggs, and constant attention.

At the meeting of the Royal Agricultural Society at Bristol, in 1842, a small machine for hatching chickens artificially was exhibited by the inventor, Mr. C. Appleyard, of London. As the notice was unaccompanied by a description, we can only say such a machine was exhibited.

It seems by no means so difficult to succeed in hatching chickens artificially as to rear them after they are hatched.

Some few years since an egg-hatching machine was exhibited, in full operation, in New York, bringing out the little chickens with all the punctuality of an old hen.

The machine, in outward appearance, forms an oblong box about five feet in length, three feet and a half in width, and four and a half feet high, divided into eight compartments, with narrow glazed doors. The bottoms or floors of

these apartments are covered with flannel, on which the eggs are laid. The divisions inside are tin, probably hollow, to contain hot water or steam, which is generated in a small cylinder standing in the centre of the machine, and extending through the top of the box, and a small pipe conducts off the smoke. In one end of the machine hangs a thermometer, apparently partly immersed in the water, by which the temperature is noted.

In one of the apartments we noticed some of the chickens busily employed liberating themselves from their imprisonment, coming forth into light and existence, rolling and tumbling about in all directions, and all through the agency of artificial means.

The wonderful and interesting phenomenon of producing animal life by machinery, presents a sight truly curious, beautiful, and interesting. We were informed that the chickens come forth from this machine strong, active, and healthy.

The warmth imparted by this apparatus, it is said, is uniform, continued, and so completely under control, that it does not, as is often the case with eggs when sat upon by the hen, ever addle them.

On one side of the machine a large box, the same length as the machine, four feet wide, with one side off, was placed close up, in which the chickens were put twenty or twenty-four hours after they were hatched. Arched holes were open at the bottom of the apparatus, through which the chickens passed to and fro to warm themselves, and did not seem to require or feel the loss of their maternal parent. They are constantly busy, either running about their apartment, or scratching the sand with their feet, and picking up the smallest particle of food which they discover. It would seem that there is no difficulty in teaching them to eat and drink; for they appear to perform these operations spontaneously, or from observation, as they are prompted by hunger.

Our interest was greatly increased and much excited on noticing with what certainty they would recognize the footsteps of the person who feeds and attends them. When he crosses the room to get their food, they would huddle to one side of the box and then to the other, and

apparently listen for his return. When he scratched on the bottom or side of the box they would rush there with great rapidity.

Beautiful as a brood of chickens always are under any circumstances, the interest excited is greatly increased by the artificial system of hatching and rearing.

M. Reaumur, in the course of his very interesting experiments, tried several plans for the substitution of what he aptly denominated an *artificial mother*. By bringing the chickens up in a hot-bed, indeed, it would be easy to make them enjoy a perpetual summer, exempt from all exposure to rain or to cold nights. For the first fortnight or three weeks, they may be advantageously reared in the oven where they have been hatched, taking them out five or six times a day to give them food and water; but this is much more troublesome than there is any occasion for, and some of the ingenious devices of Reaumur or Bonnemain may be adopted.

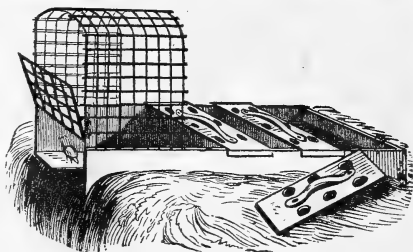
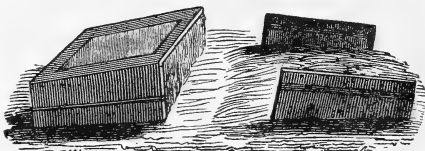

REAUMUR'S ARTIFICIAL MOTHER.

The former says: "My apparatus did not at first appear to be sufficiently perfect, because, though the chickens were kept in warm air, they had no equivalent for the gentle pressure of the belly of the mother upon their backs, when she sits over them. Their back is, in fact, necessarily more warmed than the other parts

of the body, while huddling together under their mother's wings; whereas their belly often rests the while on the cold moist earth—the very reverse of what took place in my apparatus, in which the feet were the best warmed. The chickens themselves indicated that they were more in want of having their backs warmed than any other part of their body; for, after all of them had repaired to the warmest end of the apparatus, instead of squatting, as they naturally do when they rest, they remained motionless, standing bolt upright upon their legs, with their backs turned toward the sides or end of the apartment, in order to procure the necessary warmth. I therefore judged that they wanted an apparatus which might, by resting on them, determine them to take the same attitude as they naturally assume under hens, and I contrived an inanimate mother that might supply, in this respect, the want of a living one."

The apparatus contrived by M. Reaumur upon these principles, consisted of a box lined with sheep-skin, having the wool on it, the bottom of the box being of a square form, and the upper part of it sloped precisely like a writing-desk. The box thus constructed was placed at the end of a coop, or cage, shut in with a grating of osier, net, or wire, and closed above with a hinged lid, the whole being so formed that the chickens could walk round the sides, as shown in the previous engraving.

The desk-like slanting direction of the covering permitted the chickens to arrange themselves according to their several sizes; but as they have, like all young birds, the habit of pressing very closely together, and even of climbing upon one another, the small and the weaker being therefore in danger of being crushed or smothered, M. Reaumur constructed his artificial mother open at both ends, or, at most, with only a loose netting hanging over it. Through that the weakest chicken could escape if it chanced to feel itself too much squeezed; and then, by going round to the other opening, it might find a less inconvenient neighborhood.

One improvement upon this consists in keeping the covers sloped so low as to prevent the chickens from climbing on the backs of each

other, and raising it as they increase in growth. Another consists in dividing the larger coops into two, by means of a transverse partition, so as to separate the chickens of different sizes.

"The chickens," says M. Reaumur, "soon showed me how much they felt the convenience of my artificial mother, by their fondness for remaining under it and pressing it closely. As soon as they had taken their little meals, they were seen jumping and capering about; and when they began to be weary, they crowded to this mother, going so far in that they were compelled to squat, as I perceived by the impression of the backs of several chickens on the woolly linings when the cover was turned up. No natural mother, indeed, can be so good for the chickens as the artificial one, and they are not long in discovering this—instinct being a quick and sure director. Chickens, indeed, direct from the hatching oven, from twelve to twenty hours after their escape from the shell, will begin to pick up small grains or crumbs of bread; and, after having eaten and walked about a little, they soon find their way to the fleecy lodge, where they can rest and warm themselves, remaining till hunger puts them again in motion. They all betake themselves to the artificial mother at night, and leave it exactly at daybreak, or when a lamp is brought into the place, so as to produce an artificial daybreak, with which, it is worthy of remark, old hens are not affected, but remain immovable on their roosts."

M. Bonnemain put the chickens hatched by his apparatus in a place where four pipes, fixed under boards, were made to run along at equal distances, a very little above the level of the ground. These pipes were filled with hot water, and had loose flannels attached to them, loaded with a light weight, so as to furnish for the chickens a soft body for warming chiefly their backs.

In one or other of the houses thus warmed with hot water, M. Bonnemain's chickens were permitted to run about or rest at pleasure; while in order to keep them clean, the floor is covered with a layer of fine gravel, which soaks up the dung, and is swept away every day. The artificial mothers are cleaned, the skins beat, the wool combed, the chickens which may be dirty

washed in warm water, and the walls white-washed with lime or lined with mats.

Efficient ventilation is, above all, necessary for renewing the air; and for this purpose the pipe of the stove may be led into a kind of chimney, the lower opening of which, beginning on a level with the ceiling of the room, will present a good exit to the air it contains, while the fresh air from without may be duly warmed on its entrance, by bringing it through the reservoir in the stove.

Adjoining the place thus heated artificially, a little piece of ground should be appropriated for the chickens to go into occasionally, to accustom them to the natural air, till, when about six weeks old or more, they can do without artificial heat and shelter.

The following artificial mother is recommended by Mr. Young, under which, he says, five broods may be reared at the same time. This mother may be framed of a board, ten inches broad and fifteen inches long, resting on two legs in front, two inches in height, and on two props behind, two inches also in height. The board must be perforated with many small gimlet holes for the escape of heated air, and lined with lamb's skin, dressed with the wool on, and the woolly side so as to come in contact with the chickens. Over three of these mothers, a wicker basket is to be placed, for the protection of the chickens, four feet long, two feet broad, and fourteen inches high, with a lid open, a wooden sliding-bottom to draw out for cleaning, and a long narrow trough along the front, resting on two very low stools, for holding the food. Perches are to be fixed on the basket, for the more advanced to roost on. A flannel curtain is to be placed in front at both ends of the mothers, for the chickens to run under, from which they soon learn to push outward and inward. These mothers, with the wicker basket over them, are to be placed against a hot wall at the back of the kitchen fire, or any other warm situation where the heat shall not exceed 80° of Fahrenheit. When the chickens are a week old, they are to be carried with the mother to a grass-plot for feeding, and kept warm by a tin tube filled with hot water, which will continue sufficiently warm for about three hours, when

it is to be removed. Toward the evening, the mothers are to be again placed against the hot wall.

The apparatus latterly employed for the purpose of incubation has been described under the names of *Eccaleobion*, *Potolokian*, and *Hydro-Incubator*. The former was an ingenious contrivance for hatching chickens by heated air. According to Mr. Bucknell, the English inventor and proprietor of this machine, which attracted, some years ago, great attention, the *Eccaleobion* possessed a perfect and absolute command over temperature from 300° Fahrenheit, to that of cold water, so that any substance submitted to its influence was uniformly acted upon over its whole surface at any requisite intermediate degree within the above range, and such heat maintained unaltered without trouble or difficulty for any length of time. Hence, by means of this absolute and complete command over the temperature obtained by this machine, the impregnated egg of any bird, not stale, placed within its influence, at the proper degree of warmth, at the expiration of its natural time was elicited into life without the possibility of a failure, which is sometimes the case with eggs subjected to the caprice of their natural parent. During the public exhibition of this instrument thirty or forty thousand chickens, perhaps more, were stated to have been brought into existence by a single machine, which was constructed to contain two thousand eggs at a given time. The chickens, with proper attention and under suitable treatment, were said to grow as healthy and strong as those under a parent's care. Of course, artificial mothers, warmth, a dry soil, and proper buildings, would be needed. What might not be expected from a multiplication of these machines, or their formation on a large scale!

#### THE POTOKIAN.

This was a similar contrivance for hatching eggs by means of heated air, established a few years since, on an extensive scale, in the city of Brooklyn, New York, by Mr. E. Bayer, who succeeded admirably well, as far as the producing of chickens was concerned, in the process of hatching, at a loss of not over twenty to twenty-

five per cent. of the eggs. The most congenial temperature at which the eggs were exposed during the process, he found to be 102° Fahrenheit. When uniformly kept in that degree of warmth, the period of incubation was generally hastened two days. The chickens arrived at maturity six weeks earlier than those hatched in the natural way, but were more susceptible to the climate. Notwithstanding they were sweeter, better flavored, and more tender in their flesh, and commanded a higher price in market than other fowls, the business proved unprofitable, and was abandoned with disgust.

#### MR. CANTELO'S HYDRO-INCUBATOR.

Mr. Cantelo, a few years since, established in or near London, what he termed a "Model Poultry Farm." In this institution numbers of chickens, Guinea-fowls, and ducks have been raised by artificial heat most ingeniously applied by "top-contact," so as to produce the same effect on the vitalized germ as the heat of the *incubating* hen. This heat has been proved by Mr. Cantelo to be as high as 106° Fahrenheit. The eggs were, in fact, hatched under artificial *incubators*, which allowed the inferior portion of the egg to remain cool until warmed by the inward circulation of the blood, as occurs in natural incubation, but not when eggs are placed in ovens or heated apartments. "The difference," says Mr. Cantelo, "between *top-contact* heat and that received by radiation as applied to hatching, is this: by radiation, or oven-heat, the eggs will be hours in arriving at the desired temperature, not only when first put to hatch, but any time afterward, when they may have been allowed to get cool. The eggs, of course, will heat alike over their whole surface, and consequently evaporate equally from every part. On the contrary, heat applied in *top-contact* penetrates almost instantly and revivifies the germ, and although a much higher temperature is used in this case, in imitation of nature, that is, 106° instead of 98°, still, inasmuch as but a small surface is heated, the loss of moisture is much less than by a radiating heat. The fowl leaves her nest every day in search of food for twenty or thirty min-

utes; this must be imitated also, as the temporary loss of heat has the effect of causing the contents of the egg to diminish in bulk, and the vacuum is filled by a fresh supply (of air) drawn in for the nourishment of the germ. The eggs must be moved three times a day, morning, noon, and night, which prevents the adhesion of any part of the fluid to the shell, and gives the small blood-vessels better opportunity to spread around the surface of the egg. This is effected by nature; when the fowl leaves her nest or returns to it, she naturally disturbs the eggs, and also from any change she may make in her position while upon her nest."

The machine itself is very simple; it consists of a tank or cistern of water, which is heated by a peculiar stove, the heat of which is shown by thermometer. This water is heated to 109° Fahrenheit, and flows over a surface of vulcanized caoutchouc, the lower surface of which is in contact with a tray, or nest of eggs, and maintains a heat of 106°. The tray is open at the sides, the bottom is made of wire gauze, lined with cotton cloth, and is raised or lowered by wedges; thus merely presenting a small surface to the lower surface of the caoutchouc, which represents the breast of the parent fowl, and thus only a *top-contact* heat is communicated to the egg. Around the stove is a warm chamber, in which the chickens are put as soon as hatched, and where they remain about thirty-six hours before taking food; they are then placed under the hydro-mother, which consists of a series of pipes, kept at the same heat of 106°, and under which the chickens nestle as under a real hen.

There is now no farther trouble. During the first ten days the chickens feed themselves in the house, and are then only permitted to go out in the open air, returning at pleasure to the protection of the hydro-mother. At the end of six weeks they are put into a common roosting-house, and henceforth shift for themselves.

It has hitherto been believed that the blood-heat of the feathered tribe was the same as that of the human race, viz., 98°. Mr. Cantelo asserts that it is 106°, and he considers this an overlooked fact. Another point is the manner

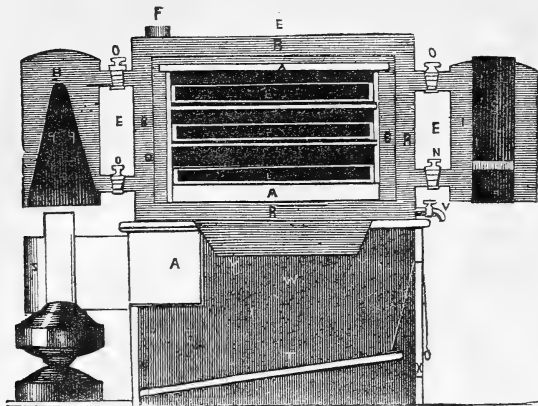

AMERICAN EGG-HATCHING MACHINE.

in which this heat is conveyed to the egg to vivify it. This he clearly proves is only by contact on the top. The principle of vitality, he contends, floats in the egg, and is constantly on the top, thus presenting itself to the bird's breast, leaving the other part exposed to the ordinary heat of the surrounding atmosphere; and as the blood-vessels form, the heat is conducted to every part of the egg.

This hydro-incubator was in operation at Mr. Cantelo's Model Farm, where he had more than two thousand head of poultry running about, from one day to three months old.

#### AMERICAN EGG-HATCHING MACHINE.

A few years since an apparatus, figured above, for the purpose of hatching chickens by artificial heat, invented by Mr. L. G. Hoffman, of the city of Albany, was put in operation, and, as far as the hatching of chickens was concerned, proved equal to the task, producing from 70 to 75 chickens from every 100 eggs.

Mr. Hoffman's machine was constructed of tin, with the hatching-chamber surrounded with water, heated and kept at a proper temperature by means of a lamp.

The machine forms, to outward appearance, an oblong box or chest, about two and a half feet in length, and two feet in depth, and the

same in width, and is stated to be capable of hatching from 200 to 400 chickens at a time. It stands upon a box, the top of which is warmed also with hot water, where the chickens are placed when removed from the hatching-chamber above. On the left of the machine is a small conical-shaped tank, or cistern of water, connected at top and bottom to the water surrounding the egg-chamber. By means of the connections at top and bottom, a constant circulation of the water is kept up. The cistern of water, on the left, is heated by a spirit-lamp, the heat passing up into the dark-colored cone, reaching to near the top of the water-cistern.

The slanting, or desk-like board, represented by a white mark near the bottom of the under case, is lined with sheep-skin, dressed with the wool on, raised or lowered by means of a small cord to accommodate the size of chickens, and by this means they can arrange themselves according to their several sizes. This is called the artificial mother.

#### MINASI'S INCUBATOR.

We notice in an English paper, that quite an improvement on the old plans of chicken-hatching has been quite recently made by a Mr. Minasi, requiring much less attention to the ma-



chine, during the process of incubation, than formerly. This was the great objection to all previously constructed hatching-machines. It may now go three days without attention; formerly it could scarcely be left three hours.

This new machine is a very simple contrivance, and can, consequently, be constructed at about one-fourth of the expense formerly required. The practical results are equally satisfactory, for he states that the average number of birds produced is 80 out of every 100 eggs. The necessary heat is obtained from a naphtha lamp, without a wick, which is so arranged that it may be left to itself for two or three days together, and yet the process of hatching goes on with due regularity and certainty.

The eggs are placed on a series of tubes, through which a stream of hot water is, by means of the naphtha lamp, kept constantly flowing; and when the chicken comes out of the shell, it is placed beneath the same tubes, which now perform the second duty of the artificial parent. After being kept there the proper time, it is removed to a compartment more suited to its increasing strength, and is ultimately placed in a pen in the open air.

The naphtha consumed, during the three weeks of incubation, about one gallon, which may be purchased at 78 cents per gallon.

#### A SCIENTIFIC HATCHING MACHINE.

A hatching machine has been invented in France, by M. Vallee, which is described by the Paris Correspondent of the *Intelligencer*. A drum, inclosing a warming cylinder, forms the basis of his system. He introduces air into the drum in which the eggs are deposited, and by

circular openings, gives access to currents of cold air. It is by the distribution and vigorously rational combination of warm and cold air that he obtains that dampish temperature in which lies the secret of incubation, from which results the development of the embryo in the egg. By this instrument artificial hatching is necessarily carried on in every state of the atmosphere, and at all seasons. But after the burst of the shell, a mother must be provided for the young. M. Vallee's ingenuity thus provides for this emergency. A lamb-skin is fastened by one extremity to a plank, and made to open at the other end like a pair of bellows. This affords a cover for the little ones, and keeps them as warm as would a veritable mother hen. The result of M. Vallee's experience, touching the period of incubation necessary for the various species of eggs, is curious, and worthy of record. Here it is: Chickens, 21 days; partridges, 24 days; pheasants, 25 days; Guinea-hen, 25 days; common duck, 28 days; pea fowl, 28 days; Barbary ducks, 30 days; geese, 30 days. The degree of heat required is from 104° to 122° Fahrenheit. A small lamp of the Locatelli system suffices to raise the temperature of the apparatus to the proper elevation. With such a machine every farmer could have a fine supply of fowls.

Notwithstanding the ease and certainty in which birds can be hatched with artificial heat, somehow or other they do not seem to be regarded with favor. Let us be content, then, with our feathered tenants of the poultry-yards as they are, and be grateful to a kind Providence for the fowls we have, which are pensioners on our bounty.

## CHAPTER IX.

## FATTENING POULTRY.

IN this branch of the business, the fattening of fowls for market, the author must confess his ignorance, as he has had no experience farther than the general run of the yard, and plenty of the best food kept constantly within their reach. The markets of Philadelphia are noted for large and fat fowls, and we have endeavored to obtain from some of the feeders in that vicinity information on the subject, but without success. We will, however, give the experience of some who have paid attention to it, and avail ourselves of such information as we can glean from books and the agricultural journals.

The well-known common methods are to give fowls the run of the farm-yard, where they thrive upon the offals of the stable and other refuse, with perhaps small regular daily feeds; but at threshing time they become fat—thence called *barn-door* fowls, probably the most delicate and high-flavored of all others, both from their full allowance of the best corn, and the constant health in which they are kept by living in the more natural state, and having the full enjoyment of air and exercise. Economy and market interest may, perhaps, be best answered by confining them in a dark place, but a feeder for his own table, of delicate and refined taste, and ambitious of furnishing his table with the choicest and most salubrious viands, will declare for the more natural mode of feeding; and in that view, a feeding-yard turfed with grass, and a room open all day for the fowls to retire at pleasure, will have a decided preference as the nearest approach to the barn-yard system.

It is a common practice with some to coop their fowls for a week or two, under the notion

of improving them for the table and increasing their fat; a practice which, however, seldom succeeds, since the fowls generally pine for the loss of their liberty, and, slighting their food, lose instead of gaining additional flesh. Such a period, in fact, seems too short for them to become accustomed to confinement.

To feed poultry requires both judgment and constant attention: and since these are far from being general attainments in the class of persons selected for this office, hence the unsatisfactory state, both for themselves and their owners, from what has been so inappropriately named the fattening coop. Without these requisites, the bird—be it of whatever race it may—is far more likely to lose than to gain flesh. A well-ventilated out-house, with a moderate but even temperature, is most suitable; and a cloth hung up in front of the coop, during intervals of feeding, induces beneficial repose.

So much has been said by different writers about the kind of food, that it is hardly necessary to repeat. Most families that keep no other animals will get together scraps enough to give four or six fowls one meal a day; if, in addition, they have one feed of boiled potatoes and one of corn, they will do very well as far as it goes.

The manner of fattening poultry would seem to be extremely plain. One might think that it was sufficient to feed them at regular hours with wholesome and abundant food, capable of satisfying them. This mode would, indeed, be very healthful for them; it would increase their size and strength; it would procure them an uncommon share of good health; but to accomplish the desired end, it is wished to give

them an extraordinary plumpness, to fat them, not for their own, but for our advantage.

Each different plan has its peculiar advantages; among others, that of leaving poultry to *forage and shift for themselves*; but where a steady and regular profit is required from them, the best method, whether for domestic use or for sale, is *constant high keep* from the beginning, whence they will not only be always ready for the table, with very little extra attention, but their flesh will be superior in juiciness and rich flavor to those which are fatted from a low and emaciated state. Fed in this mode, the *spring pullets* are particularly fine, at the same time most nourishing and restorative food.

It takes several weeks to fatten fowls confined in coops. All old writers on this subject recommend cooping or penning them, and feeding them with bread steeped in ale, wine, or milk; barley-flour mixed with milk, and seasoned with mustard or anise seeds; and some recommend cramming them three or four times a day. They also recommend keeping them in a dark place, and not allowing them any exercise.

"To fatten poultry," says Bradley, "the best way and quickest is to put them into coops as usual, and feed them with barley meal; but, in particular, to put a small quantity of brick-dust in their water, which they should never be without. This last will give them an appetite for their meat, and fatten them very soon." He thinks the brick-dust acts as gravel, as it is so universally supposed to do, in bruising the food in the gizzard.

In an extensive establishment near Liverpool, Mr. Wakefield fattened with steamed or baked potatoes, given *warm*, which is indispensable, three or four times a day. The fowls were taken in good condition from the yard, confined in dry, well-ventilated coops, and covered in, so as to prevent the entrance of too much light. This method was attended with the greatest success.

Paine Windgate, in the *Maine Farmer*, says his experience tells him that the following process is the best mode of fattening hens. Shut them up where they can get no gravel. Keep

corn by them all the time, and also give them dough enough once a day. For drink, give them skimmed milk. With this feed they will fatten in ten days. If they are kept over ten days, they should have some gravel, or they will fall away.

A writer in one of our agricultural papers recommends the following: Oats ground into meal and mixed with a little molasses and water, barley-meal with sweet milk, and boiled oats mixed with meat, are all excellent for fattening poultry, reference being had to time, expense, and quality of flesh.

Corn, before being fed to fowls, should always be crushed and soaked in water, or boiled. It will digest easier, and go much farther. Parched corn or oats is a kind of food poultry are very fond of, and an occasional change of food is found by experience and observation to be highly important in promoting the thrift of all kinds of domestic animals. Keep your fowls *dry and clean*, give them good lodging, provide them with some dry sand, ashes, or old lime-mortar to dust themselves in, and give them a plentiful supply of food, a portion of which should be animal, and if fat all the better, and you will not have to complain for their not thriving.

The food is a matter of much variety, as various articles are used for the purpose of fattening fowls. When fattening, care should be taken not to feed them on fish, as it would give them a bad flavor. In some parts of England and France, oil, lard, and other grease is extensively used, mixed with barley-meal, oat-meal, and other ground food. Arthur Young says, feed on coarse barley-meal steamed until quite soft; steamed potatoes minced quite small, and coarse wheaten flour; ground oats made into gruel, mixed with hog's grease, sugar, pot-liquor, and milk; or ground oats, molasses, suet, sheep's plucks, etc. These precious mixtures are said to fatten them, in a fortnight, to the weight of seven pounds; but there are instances of individuals attaining ten or eleven pounds.

*Feeding-houses*, at once warm and airy, with earth floors, well-raised, and capacious enough to accommodate twenty or thirty fowls, have

always succeeded best, according to our experience. The floor may be slightly littered down, the litter often changed, and the greatest cleanliness should be observed. Sandy gravel should be placed in several different layers, and often changed. A sufficient number of troughs, for the water and food, should be placed around, that the stock may feed with as little interruption as possible from each other, and perches in the same proportion should be furnished for those birds which are inclined to perch, which few of them will desire, after they have begun to fatten, but which helps to keep them easy and contented until that period. In this mode, fowls may be fattened to the highest pitch, and yet preserved in a healthy state, their flesh being equal in quality to that of the barn-door fowl.

It has always been a favorite maxim among feeders, that *the privation of light*, by inclining fowls to a constant state of repose, excepting when moved by the appetite for food, promotes and accelerates obesity. It may probably be so, although not promotive of health; but as it is no question that a state of obesity obtained in this way can not be a state of health, a real question arises—whether the flesh of animals so fed can equal in flavor, nutriment, and solubility that of the same species fed in a natural way?

*Insects* and *animal* food also form a part of the natural diet of poultry, are medicinal to them in a weakly state, and the want of such food may sometimes impede their thriving.

The London chicken butchers, as they are termed, are said to be, of all others, the most

dexterous and expeditious feeders, putting up a coop of fowls and making them thoroughly fat within the space of a fortnight, using much grease, and that, perhaps, not of the most delicate kind, in the food. "In this way," says Mowbray, "I have no boast to make, having always found it necessary to allow a considerable number of weeks for the purpose of making fowls fat in coops. In the common way, this business is often badly managed, fowls being huddled together in a small coop, tearing each other to pieces, instead of enjoying that repose which alone can insure the wished-for object; irregularly fed and cleaned, until they are so stench and poisoned in their own excrement, that their flesh actually smells and tastes of it when smoking upon the table."

Another plan is to confine them in a dark place and cram them with a paste made of barley-meal, mutton suet, molasses, or coarse sugar, pot-liquor, and milk; and they are found completely fat in two weeks. It is, however, really a barbarous and filthy practice, and, thank Heaven, in this country we have no overgrown epicures to demand or render the practice profitable, supposing it attainable.

To conclude: as barn-door fowls are considered superior in flavor to all others, the nearest approach to this manner of fattening we consider the best. The plan of confining a week or two, for the purpose of giving them extra food, does not improve them. The first week or two they pine and lose flesh. Five or six weeks are necessary in this way to make them fat.

## CHAPTER X.

## KILLING AND PREPARING POULTRY FOR MARKET.

If you wish to prepare your poultry in the nicest manner for the market, so that it will invariably secure the best price, observe the following rules, viz. : First, fat them well, and allow them to remain in the pens twenty-four hours without food previous to being killed. Then, when you kill them, instead of wringing their necks, cut their heads off at a single blow with a sharp ax or cleaver, and then hang them up by their legs and allow them to bleed freely, and pick them immediately, while *warm*. Some, however, prefer to run a small pen-knife into the jugular-vein by the side of the neck, just under the joles. In this case, let the heads remain on. In picking, great care should be taken not to tear the skin; the wings should not be cut off, but picked to the end. If the head should be cut off, the skin of the neck should be neatly tied over the end. Most persons like to see the heads of fowls left on; it makes a better show. The heads of ducks and geese should always be cut off. No cut should be made in the breast; all the offal should be taken out behind, and the opening should be made as small as possible.

Some persons send their poultry to market with their intestines in. This, to say the least, is a dirty, slovenly practice, doing great injury to the flesh, as it partakes of the flavor of the excrements when suffered long to remain undressed, and is otherwise impaired from the stagnant blood. After removing the intestines, wipe out the blood with a dry cloth, but no water should be used to cleanse them. With a moist cloth take off the blood that may be found upon the carcass, and hang them in a cool, dry room until ready to carry to market, or otherwise to be used. Do not remove the gizzard

from its place; but, if the fowl be very fat, make a larger hole, turn the leaves out, and fasten them with a small skewer. When prepared in this way, your poultry will be much nicer, and entitled to a better price than when butchered and dressed in the ordinary way.

We have often noticed the careless, slovenly manner, and little attention paid to external appearance of poultry offered for sale in our markets; and we have noticed the quick sale and higher price when due regard was paid to have the skin all sound and clean; the breast not mutilated by a long cut, the shrinking skin exposing the drying meat covered with hay-seed or chaff, but well covered all over with fat, of a rich golden yellow. Much of the poultry exposed for sale has been through the process of scalding to facilitate picking; this practice should never be resorted to. It turns the rich yellow of the fat into a tallowy hue, and oftentimes starts the skin, so that it peels off unless very carefully handled.

Much care and attention is required after the poultry is dressed and cool. It should be carefully packed in baskets or boxes, and, above all, it should be kept from the frost. A friend who was very nice in these matters, used to bring his turkeys to market in the finest order possible, and always obtained a ready sale and the highest price. His method was to pick them dry, while warm, and dress them in the neatest manner; then take a long, deep, narrow, tight box, with a stick running from end to end of the box, and hang the turkeys by the legs over the stick, which prevents bruising or disfiguring them in the least.

Too much should not be exposed at a time for sale, nor should they be hauled over too oft-

en. Appearance is every thing with poultry, as well as other articles, and has great influence on the purchaser.

#### AGE OF POULTRY.

Farmers usually sell poultry alive. Poulterers in towns, on the other hand, kill and pluck every sort of fowl for sale, so that the purchaser has it in his power to judge of the carcass; and if he buys an inferior article at a high price it must be his own fault. It is easy to judge of a plucked fowl, whether old or young, by the state of the *legs*. If a hen's spur is hard, and the scales on the legs rough, she is old, whether you see her head or not; but the head will corroborate your observation, if the under bill is so stiff that you can not bend it down, and the comb thick and rough. A young hen has only the rudiments of spurs, the scales on the legs smooth, glossy, and fresh colored, whatever the color may be,

the claws tender and short, the under bill soft, and the comb thin and smooth. An old hen turkey has rough scales on the legs, callosities on the soles of the feet, and long, strong claws; a young one, the reverse of all these marks. A young goose or duck is distinguished by the tenderness of the skin under the wings, the strength of the joints of the legs, and the coarseness of the skin.

#### TO PRESERVE POULTRY IN WINTER.

"About the 15th of November," said the late Judge Buel, "I purchased a quantity of poultry for winter use. The insides were carefully drawn, their place partially filled with charcoal, and the poultry hung in an airy loft. It was used through the winter, till about the first of February, and although some were kept seventy days, none of it was the least affected with must or taint, the charcoal having kept it sweet."

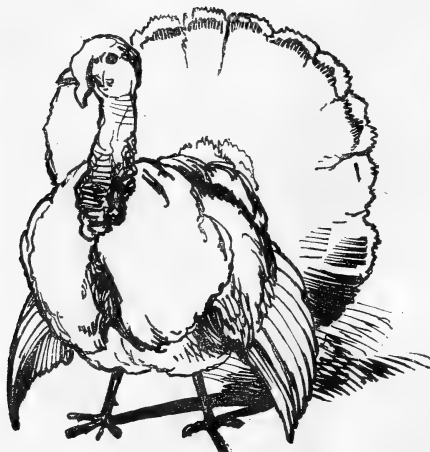

## CHAPTER XI.

## DISEASES OF POULTRY.

IN this climate the diseases of our poultry are few in number, and are generally controlled by proper treatment. On this point, it is said, with truth too, that "prevention is better than cure;" and when the former can not be altogether secured, the latter must be attended to immediately, or all attempts at a cure will prove fruitless. Although poultry are no less liable to disorders than cattle or other tame animals, but very little attention has been paid to them, owing, no doubt, to the small value of individual fowls compared with sheep or horses; and it is frequently most economical to kill them at once. These disorders, however, though few in number, are far from being devoid of interest, not only as sometimes leading to correct views of the diseases of other animals, but so far as the saving of even a few shillings, by curing them when that is possible, or of rendering their eggs or flesh more wholesome and palatable, as well as the humane motive of adding comfort to the creatures intrusted to our care.

When disease seizes an individual, it should be removed from the others as soon as discovered, and put by itself, or it may spread over the whole flock. Under proper management, Nature is a prudent guardian to fowls in health, a kind nurse to them in weakness, and the most skillful physician in disease. With her man should do no more than co-operate; and this we can do most effectually by adopting every proper means, by accommodation and diet, to preserve them in a proper state of health.

It is with truth said, that "the diseases of our domestic animals kept for food are generally the result of some error in the diet or management, and should either have been prevent-

ed or cured more readily and advantageously by an immediate change or adoption of the proper regimen. When that will not succeed, any farther risk is extremely questionable; and particularly with respect to poultry, little hope can be derived from medical attempts."

## APOPLEXY.

This disease is very frequent among fowls, and makes its attack, in most instances, without the slightest warning. M. Flourens, of Paris, says there are two degrees of apoplexy among fowls—one deep-seated and the other superficial—each having different symptoms. Deep-seated apoplexy is characterized by complete disorder of movement, while superficial apoplexy is manifested only by deficient muscular energy and inability in walking. Deep-seated apoplexy is accompanied by superficial apoplexy; but as the latter is the precursor of the former, it ought to be carefully attended to, in order to prevent its passing to what may be termed the second stage, though both stages are capable of being cured by a natural process, as an individual case proves.

M. Flourens had brought to him, in the month of April, a young fowl, whose gait indicated that of a tipsy animal so much, that the peasants called it the "tipsy hen." Whether standing, or walking, or running, it reeled and staggered, advancing always in a zigzag manner, frequently turning to the right when it wished to turn to the left, and to the left when it wished to turn to the right, and instead of going forward it went backward. Its legs also often bent under it, so that it fell down; above all, when it flew high up to perch, it could not govern nor regulate its movements, but fell and

rolled about on the ground a long while without being able to get upon its legs or recover its balance. These movements so nearly resembled those which had been produced by experiment, that M. Flourens was impatient to examine the brain. He found the bone of the skull to be covered with black carious points. On penetrating the dura mater, a quantity of clear water ran out, while the cerebellum was yellowish, rust-colored streaks on the surface, and in the centre was a mass of purulent coagulated matter as large as a horse-bean, contained in a cavity perfectly isolated, and having its sides very thin and smooth.

*Symptoms.*—The symptoms of apoplexy are plain and decisive. A fowl, apparently in the most robust health, falls down suddenly, and is found either dead, or without sensation or the power of motion. These symptoms are occasioned by the rupture of a small vessel (usually at the base of the brain), and the consequent effusion of blood, which, by its pressure, produces the evil.

*Causes.*—Apoplexy is almost invariably caused by a full habit of body; it is therefore frequent in overfed birds, and is most common among laying hens, which are sometimes found dead on the nest—the expulsive efforts required in laying being the immediate cause of the attack. Unnatural and overstimulating food, as greaves, hemp-seed, and a large proportion of pea or corn meal, greatly predisposes to the disease.

This disorder is termed by some *epilepsy*, *me-grims*, or *giddiness*. Many promising chickens are lost by this complaint. Without any kind of warning, they fall, roll on their backs, and struggle for a minute or two, when they rise, stupid and giddy, and slowly return to their food. One fit having occurred, is quickly followed by others, each more violent than the preceding, until at length the little animal staggers about, half unconscious, refusing to eat, rapidly wasting, and soon dies convulsed. In some cases it occurs when the fowl is poor and half-starved; but then the food has been improper; it has been watery or disposed to fermentation; diarrhea has followed, and the fits are the consequence of intestinal irritation.

Other young fowls will have occasional fits, from which, however, they in most cases rapidly recover, and appear to be little or nothing the worse for them.

*Treatment.*—In this disease much may be done in the way of prevention—little toward a cure in an actual attack; the only hope consists in an instant and copious bleeding. It has been said that *bleeding* is out of the question; for how is a bird to be bled, and where? We would reply, it is *not* out of the question; for we have saved the lives of several birds by its prompt employment. And as to the mode of operating, it is the same as in other animals—simply opening a vein with a sharp-pointed pen-knife, or, still better, a lancet. The largest of the veins seen on the under side of the wing should be selected, and opened in a longitudinal direction, not cut across; and so long as the thumb is pressed on the vein, at any point between the opening and the body, the blood will be found to flow freely. If the bird recovers after the operation, it should be kept quiet, and on light and scanty food, and the affected fowl should be confined in a rather dark coop, and kept warm.

#### VERTIGO.

*Symptoms.*—Fowls affected with this disease may be observed to run round in a circle, or to flutter about with but partial control over their muscular actions.

*Cause.*—The affection is one evidently caused by an undue determination of blood to the head, and is dependent on a full-blooded state of the system.

*Treatment.*—We have always found that holding the head under a stream of cold water for a short time immediately arrested the disease; and a dose of any aperient, such as calomel, jalap, or castor-oil, removes the tendency to the complaint.

#### PARALYSIS.

*Symptoms.*—An inability to move some of the limbs. In fowls the legs are usually affected, and are totally destitute of the power of motion.

*Causes.*—Paralysis usually depends on some



affection of the spinal cord, and is another result of overstimulating diet.

*Treatment.*—Nothing can be done by way of cure; the case may be regarded as hopeless or nearly so.

#### CATARRH.

*Symptoms.*—The symptoms of catarrh in fowls are identical with those so familiar in the human subject—namely, a watery or sticky discharge from the nostrils, and a slight swelling of the eyelids; in worse cases the face is swollen at the sides, and the disease has the appearance, or seems to run on to true roup.

*Causes.*—Exposure to cold and dampness, such as a long continuance of cold wet weather, or roosting in places which are open to the north or west.

*Treatment.*—In simple cases, removal to a dry, warm situation, and a supply of food rather more nutritious and stimulating than usual, soon effect a cure. We have found a little mashed boiled potatoes, well dusted with black pepper, very advantageous. In severe cases, the disease so closely resembles roup that it may be treated in the same manner.

#### GAPES.

Of all diseases, real or presumed, to which our domestic fowls are subjected, the most frequent is the gapes, sometimes called *pip*. It is a very common and troublesome disorder, and often proves fatal. All domestic birds, particularly young fowls, are peculiarly liable to it, and generally in the hot weather of July and August. By some it is considered a catarrhal disease, similar to the influenza in human beings, producing a thickened state of the membrane lining the nostrils, mouth, and tongue.

*Causes.*—This disease is supposed to be produced from filthy, sour diet, and drinking from dirty puddle water, infected with putrid decaying substances, ill-ventilated fowl-house confinement, or a spot of ground tenanted year after year by fowls, without attention to cleanliness, to renovation of the soil, etc. At the same time, let it be borne in mind that the "gapes" is an epidemic disease.

The gapes is supposed by some to be caused

by a sort of internal worm infesting the wind-pipe; but though this may have, in some instances, been observed, it is by no means uniformly met with in all the disorders accompanied with gaping.

*Symptoms.*—The name is sufficiently expressive as to the symptoms of this disease; gaping, coughing, and sneezing, dullness, and inactivity, ruffled feathers, and loss of appetite.

On the dissection of chickens dying with this disease, it will be found that the wind-pipe contains numerous small red worms about the size of a small cambric needle; on the first glance they would likely be mistaken for blood-vessels. It is supposed that these worms continue to increase in size until the wind-pipe becomes completely filled up, and the chicken suffocated. The disease first shows itself when the chicken is between three and four months old, and not generally after, by causing a sneezing or snuffing through the nostrils, and a frequent scratching of itself at the roots of the bill.

*Treatment.*—The plan formerly adopted, of giving remedies internally to remove the worms, is not a good one, as the medicine has to be absorbed, pass into the blood, and act powerfully upon the body of the fowl, before its purpose can be accomplished; its direct application to the worms is therefore preferable. This is readily secured by stripping the vane from a small quill feather, except half an inch from its extremity; this should then be dipped in spirits of turpentine; and, the chicken being securely held by an assistant, the feather so prepared is passed neatly down through the small opening of the wind-pipe, which is readily seen at the base of the tongue, and giving it one or two turns will generally bring up and destroy the worms. The turpentine at once kills the worms, and its application excites a fit of coughing, during which those that were left by the feather are expelled. This mode of application requires some dexterity, and at times the irritation proves fatal. We therefore suggest the shutting up of the chicken in a box, with some shavings dipped in spirits of turpentine, when the vapor arising from the extended surface produces, in most cases, an equally beneficial result. Creosote, used in the same manner,

has been found most extraordinarily efficacious.

*Prevention.*—We know a person, a very large breeder of fowls, who always gives his chickens, at six weeks old, wheat steeped in turpentine. This is given them once in the morning, when fasting, and as a preventive against, instead of waiting for the arrival of, the gapes. Let their first food be coarse corn meal, almost dry; then give cracked corn. As soon as they can swallow whole grains, let them have them unbroken. All poultry-yards, of course, should be supplied with lime, and the chickens should have free access to pure water. After the gapes appear, the cure is always doubtful; but crushed corn, soaked in very strong alum-water, is also a good remedy.

#### THE PIP.

This may be regarded as a token of derangement of the mucous membrane of the alimentary canal generally, and not as a local disease.

*Cause.*—This disease is generally attributed to the want of water, or to bad water, such as the drainings of dung-hills, sinks, etc., which fowls will drink when they can get no other.

*Symptoms.*—The occurrence of a dry, horny scale upon the tongue is generally regarded as characteristic of this disease, which, however, is by some confounded with gapes. We are quite assured that the dry, scaly tongue is only a symptom caused by some other disease, which forces the fowl (which habitually breathes through the nostrils) to respire through the mouth; in this case the constant current of air dries the tongue, which becomes hard at the point, and assumes a very horny character. Thus, in any inflammatory affection of the wind-pipe, in gapes, catarrh, or roup, when the nostrils are closed by the discharge, the pip, as it is termed, makes its appearance. It should be regarded, however, as a symptom only, and not as the disease itself. The beak becomes yellow at the base, the plumage becomes ruffled, the bird mopes and pines, the appetite gradually declines to extinction, and at last it dies, completely worn out by fever and starvation.

*Treatment.*—The treatment varies with the cause. In all cases the mouth should be fre-

quently moistened; and if the scale of hardened membrane is loose, it should be removed. The absurd plan of nipping off the end of the tongue in chickens is still practiced in some parts of the country; it is almost needless to say, that it is alike useless and barbarous.

A cure may be effected by a low diet; that is, in the case of common fowls, by an allowance of fresh vegetable food, as onions or parsley chopped and mixed with potatoes and a little Indian or oatmeal, granting at the same time a plentiful supply of pure water. Give, also, a tea-spoonful of castor-oil or thereabouts, according to the age or strength of the fowl. Do not scrape the tongue, nor use rough modes of cleaning it; but apply a little borax, dissolved in pure water, and tincture of myrrh, by means of a camel-hair brush, two or three times a day.

The following has been recommended: Give three times a day, for two or three days, a piece of garlic, the size of a pea; if garlic can not be obtained, onion, shallot, or chive will answer; and if neither of these be convenient, two grains of black pepper, to be given in fresh butter, may be substituted.

#### ROUP.

There are no diseases to which poultry are subject, from which we have suffered more than from roup, catarrh, or swelled head, which we consider one and the same disease. The term *roup* is very indefinite, being applied to very dissimilar disorders of poultry, such as the obstruction of the rump gland, the pip, and gapes, already described, and to almost every sort of catarrh, to which gallinaceous fowls are much subject. But the chief disease to which chickens and fowls are liable, originates in changes of weather and variations of temperature; and when the malady becomes confirmed, with running at the nostrils and other well-known symptoms, they are termed roup.

The word *roup* is supposed to be a corruption of *croup*, to which children are subject, and which often proves fatal. It affects fowls of all ages, and is either acute or chronic, beginning sometimes suddenly and sometimes gradually, as the result of neglected colds, stormy weather, or damp lodgings.

*Symptoms.*—The most prominent symptoms of roup are at first identical with those of severe catarrh; as difficult and noisy breathing, a cough, a kind of rattling in the throat, beginning with what is termed gapes. There is considerable discharge from the nostrils of fetid matter, like the glanders in horses; at first thin and limpid, but soon loses its transparent character, becoming more or less opaque, and of a very peculiar and offensive odor; froth appears in the inner corner of the eye; the lids swell, and in severe cases the eyeball is entirely concealed; the nostrils are closed by the discharge drying around them, and the eyelids are agglutinated together; the diseased secretion accumulating within the sides of the face, frequently swell to an extreme degree, and the bird, unable to see or feed, suffers from great depression, and sinks rapidly.

As secondary symptoms, the appetite is all but gone, except for drink; the crop feels hard to the touch, and the feathers are staring, ruffled, and without a healthy gloss. The fowl sits moping and wasting in corners, always apparently in great pain. In this stage of the disease it is supposed to be infectious; and whether so or not, it is certainly proper, for cleanliness' sake, if nothing else, to *separate* the diseased from the healthy ones, to prevent the disorder from spreading through the yard.

As fowls habitually breathe through the nose, the mouth being kept closed, it follows that there is, even in the early stages, some difficulty of breathing, and a distension of the loose skin below the under-jaw may be often noticed. The frothy matter appearing at the corner of the eye, results from the same cause; the air, stopped in its passage through the nose, passes up the tear-duct, and produces the appearance of bubbles.

With respect to the communication of this disease, our experiments prove that it is exceedingly contagious. It is, we are inclined to think, frequently communicated by fowls drinking out of the same vessel, as the discharge from the nostrils of the sick bird contaminates the water as it drinks.

*Treatment.*—In general, we should say, kill a roup-y fowl at once, unless it is valuable, as the risk of its contaminating the whole yard is

great. At all events, let it be removed from the yard at once. Combined with every remedy cleanliness is indispensable, as the first, the last, and the best, without which all others are vain, and worse than vain, as they may be pernicious by feeding, instead of starving, the disease.

Warm, dry lodging, and nutritious food, are the first essentials to recovery; in addition, the frequent removal of the dried discharge from around the eyes and nose, by warm bathing the nostrils with Castile soap-suds as often as necessary, and the swollen eyes with warm milk and water. In the way of internal medicine, we find that nearly equal numbers recover under various modes of treatment. We have tried the following remedies, viz.: A pepper-corn in a pill of dough the three following days, the patient being much chilled. Afterward, bathe the swollen parts with camphorated spirits, or brandy and water.

"But facts are better than words," says Boswell, "and we have the following case from a Middlesex farmer. A cock, about four or five months old, apparently turned out by some one to die, came astray, and was in the last stage of roup. The discharge from his mouth and nostrils was very considerable, and extremely pungent and fetid, while his eyes appeared to be affected with inflammation, as bad as what surgeons term Egyptian ophthalmia. The roup, it may be stated, was somewhat prevalent at the time, and a very fine cock had perished in a corner hard by, of cold and hunger, from not being able to eat. The roup-y cock was placed by the fireside, his mouth and nostrils washed with warm water and soap, which made him expectorate and sneeze off a quantity of the offensive obstructing matter. His eyes were washed with warm milk and water, and the head gently rubbed with a dry cloth. As he could not see to eat, he was put into a rabbit-hutch, with a warm bed of hay to squat on. Some hours afterward, his head was again washed, and as there was much intermittent fever, though the cold stage prevailed, a stimulant plan was adopted. Long pellets were formed of barley-meal, flour, mustard, and grated ginger, with which he was crammed several times a day, his head bathed, and warmth attended to. He had milk-

warm water, sweetened with molasses, to drink, for the purpose of counteracting the too heating qualities of the stimulants. The fireside always seemed to invigorate him; yet he still breathed with difficulty, and gaped, and had a rattle in his throat. In three days, the stimulants, warmth, and cleanliness, improved him so much, that he began to see a little, and in a week his sight was nearly perfect. A little mustard was still given him in his water, and then some flour of sulphur. He had also a pinch of calomel in some dough. He was gradually brought so as season him to the cold, and, in a month, was in high health and spirits. Having moulted late, he caught a cold on the first frost, and suffered a relapse, having cough, gaping, ruffled feathers, and aguish shaking; warm lodging, and occasionally a lounge by the fireside, proved a speedy remedy without medicine."

Dr. Bennett, in his "Poultry Book," remarks, "But for roup and all putrid affections, I confidently prescribe the following, and consider it the only true treatment: Take finely pulverized, fresh-burnt charcoal, and new yeast, of each three parts; pulverized sulphur, two parts; flour, one part; water, quantity sufficient; mix well, and make into boluses of the size of a hazel-nut, and give one three times a day. Cleanliness is no less necessary than warmth, and it will sometimes be desirable to bathe the eyes and nostrils with warm milk and water, or suds, as convenient."

Mr. Giles, who is excellent authority, having had more than thirty years' experience with fowls, and being the owner of an extensive collection of fowls, says, "As soon as discovered, if in warm weather, remove the infected ones to some well-ventilated apartment, or yard; if in winter, to some warm place; then give a dessert-spoonful of castor-oil; wash their heads with warm Castile soap-suds, and let them remain until the next morning, *fasting*. Scald for them Indian meal, adding two and a half ounces of Epsom salts for ten hens, or in proportion for a less or larger number; give it warm, and repeat the dose in a day or two, if they do not recover."

#### CONSUMPTION.

Notwithstanding their warm covering of

feathers, from their peculiar structure, fowls are exceedingly liable to cold and other catarrhal diseases, exhibiting themselves in the symptoms of hoarseness, snorting, and sneezing. It must be considered, also, that fowls are originally natives of a tropical climate; and though long naturalized, they still retain so much of their original habit as to influence them in this respect. Very wet or very dry weather, or extremes of cold or of heat, are equally fatal; whereas, when the weather is genial and equal, fowls always thrive best. The old poultry, in the mean while, frequently bear all changes of weather, without showing any symptoms of roup.

*Symptoms.*—Consumption, which is caused by the presence of scrofulous tubercles in the lungs, may almost always be induced in chickens by confining them in cold, dark, unhealthy places; we have also found tubercles in other organs of the body. The symptoms of consumption are not strongly marked in the early stages; in the more advanced state there is wasting, cough, and expectoration of matter. They are also affected, more or less, by the circumstances in which they are placed, spending a large portion of their existence in coops and under shelter, so that they are more liable to be affected by exposure.

*Treatment.*—It is fortunate that consumption can always be prevented by wholesome, abundant diet, and good housing, for in advanced stages it is quite incurable; when it is suspected to be commencing, cod-liver oil may be given, mixed with barley-meal; but as the disease is hereditary, a fowl so preserved would be worse than useless as a stock-bird. Temperature is the dominant principle, to which attention ought to be paid.

#### CROP-BOUND.

*Symptoms.*—The crop, or membranous dilatation of the gullet, whose office it is to receive food as it is swallowed, and to retain it until sufficiently softened by maceration, is sometimes so overcharged, that it is unable to expel its contents into the stomach. From the emptiness of the latter organ, the bird feels hungry, and by continuing to eat, adds to the mischief, until at

last, by the contraction of the crop and the swelling of the grain, a hardened mass is formed, weighing, in some cases, nearly a pound, and by the enormous protuberance it causes, giving evident indications of its presence. Sometimes the disease is occasioned by a single object being swallowed, whose size is too large to permit it to pass into the stomach. In this case it serves as a nucleus for other matters, and a mass is formed around it. "I have," says Mr. Tegetmeier, "now lying before me a piece of bone, one inch and a half long by three-quarters of an inch broad, which was imbedded in a mass of horse-hair, oat-husk, and other vegetable fibres, the whole forming an egg-shaped solid, two and a half inches in the long and one and a quarter in the short diameter. This caused the death of the Dorking in whose crop it was found."

*Treatment.*—The treatment of this disorder is very simple. With a sharp pen-knife an incision must be made through the skin and upper part of the crop; the impacted mass loosened by some blunt-pointed instrument, and removed. If it has remained many days, and is very offensive, the crop may then be washed out by pouring in some warm water. The incision, if small, may be left; but if large, a stitch or two is advisable. The bird should be fed on soft food a day or two, and will rapidly recover. Sometimes a dessert-spoonful of gin will stimulate the crop sufficiently to overcome the mass, and render the use of the knife unnecessary.

#### INFLAMMATION OF THE STOMACH.

*Symptoms.*—When a fowl mopes and refuses to eat, without any apparent cause, or selects only soft food, rejecting corn or grain, and, gradually pining, becomes excessively thin, inflammation of the stomach may be suspected.

*Causes.*—Overstimulating food, especially peas, hemp-seed, etc., necessarily make a greater call upon the digestive organs than more simple and wholesome diet. The amount of gastric juice must be in proportion to the digestibility of the food; and hence, under the use of peas, corn, hemp-seed, etc., the organ is overworked and stimulated to such an extent as to become inflamed. The secretion of gastric juice

then ceases, the food is not digested, and consequently distends the stomach to an enormous degree; so that, although not naturally larger than the finger, we have seen it four or five times the size of the gizzard.

*Treatment.*—The prevention of this disease, by the use of wholesome and natural diet, is easy; the cure in advanced cases very uncertain. The only treatment to be relied on would be the immediate employment of a plain dietary, consisting of cooked soft food, so as to make the least possible call on the digestive organs; and if to this regimen an occasional grain of calomel, at intervals of several days, be added, all is done that can be likely to benefit the patient.

#### DIARRHEA.

"There are times when fowls dung more loosely than at others, especially when they have been fed on green or soft food; but this may occur without the presence of disease. But should this state deteriorate into a confirmed and continued laxity, immediate attention is required to guard against fatal effects."—*Dr. Bennett.*

*Symptoms.*—The symptoms of diarrhea, or looseness, are so evident as to render description hardly necessary. Lassitude, emaciation, and, in very severe cases, voiding of calcareous matter, white, streaked with yellow, resembling the yolk of a stale egg, and sticking to the feathers near the vent. It becomes acrid, from the presence of ammonia, and causes inflammation, which extends speedily through the intestines.

*Causes.*—Diarrhea is generally produced by a too scanty supply of grain—which necessitates an excess of green food—dampness, undue acidity in the bowels, and unwholesome diet of any description.

*Treatment.*—The treatment is simple, and of course depends upon the cause. When the disease is brought on by a diet of green or soft food, the diet must be changed, and water given sparingly. Five grains of powdered chalk, the same quantity of rhubarb, and three of cayenne pepper, may be administered; and if the relaxation is not speedily checked, a grain of

opium and one of powdered ipecacuanha may be given every four or six hours.

Dr. Bennett recommends, "when it arises from undue acidity, chalk mixed with meal; but rice-flour boluses are most to be depended upon."

#### COSTIVENESS.

"The existence of this disease," says Dr. Bennett, "will become apparent by observing the unsuccessful attempts of the fowl to relieve itself. It frequently proceeds from continued feeding of dry diet, without access to green vegetables. Indeed, without the use of these, or some such substitute, as boiled potatoes, costiveness is sure to ensue. The want of a sufficient supply of good water will also produce the disease, on account of that peculiar structure which has already been explained, by which fowls are unable to void their urine except in connection with the fœces of solid food, and through the same channel."

*Remedy.*—Soaked bread, with warm skim-milk, is a mild remedial agent, and will usually suffice. Boiled carrots, or cabbage, is more efficient. A meal of earth-worms is sometimes advisable, and hot potatoes, mixed with lard, are said to be excellent.

#### LOSS OF FEATHERS.

This disease, which is common to confined fowls, is by no means to be confounded with the natural process of moulting. In the annual healthy moult, the fall of the feathers is occasioned by the protrusion of new feathers from the skin. In the diseased state which we now consider, where the feathers fall, no new ones come to replace them, but the fowl is left bald and naked. A sort of roughness appears also on the skin.

The loss of feathers and the wants of poultry in confinement, are clearly shown by a correspondent of the *Boston Medical Journal*, in the following amusing sketch: "A most pleasing illustration," says he, "was the want of lime, and the effects of its presence, which came under my notice on my voyage from South America to France. We had omitted to procure gravel for our poultry, and in a few days after we were at

sea, the poultry began to droop, and wound up their afflictions with the pip, or, as the sailors term it, the scurvy. Their feathers fell from their bodies, and it was perfectly ludicrous to see the numerous unfeathered tribe in the most profound misery, moping away their time in an utter state of nudity. Amusing myself one day by fishing up gulf-weed, which floated in immense fields upon the surface of the ocean, I took from it numerous small crabs, about the size of a pea. The poultry, with one accord, aroused themselves from their torpor, and seemingly, as if by instinct, aware of the therapeutic qualities of these interesting animals, partook of them with greater avidity than any invalid ever swallowed the 'waters of the springs.' After a few hours, the excellence of the remedy was apparent; the cocks began to crow, the hens to strut and look saucy, and in a few days all appeared in quite a holiday suit of feathers, derived from the lime, the constituent part of the crab-shells."

*Symptoms.*—A falling off in appetite, moping, and inactivity; the feathers staring and falling off till the naked skin appears.

*Remedy.*—This affection is supposed by some to be constitutional rather than local. External remedies, therefore, may not always be sufficient. Stimulants, applied externally, may serve to assist the operation of what medicine may be given. Sulphur may be thus applied, mixed with lard. Cayenne and sulphur, in the proportion of one quarter each, mixed with fresh butter, is good to be given internally, and will act as a powerful alterative. The diet should be changed, and cleanliness and fresh air are indispensable.

#### EATING THEIR FEATHERS.

Eating each other's feathers is a habit which fowls often contract, when confined in yards, but is not, perhaps, fully understood. "It is a morbid appetite," says a writer in the *Cultivator*, "apparently induced in the outset by the impatience of the fowls under confinement." It is well known that fowls are very fond of blood; and when moulting, the new feathers are what is generally called blood-shot; that is, the ends of the quills, when quite young, have a drop or

so of blood, which induces the fowls to pluck for the blood contained in them; and we knew it to be kept up till some individuals of the flock, who were made special victims, were almost entirely denuded of their feathers, and sometimes have even had their entrails torn out.

The best preventives are animal food, such as bones (not burnt), oyster-shells, charcoal, and fresh meat, with clean water, and clean apartments. Sometimes a particular fowl shows a more inveterate disposition to eat feathers than the rest of the flock. It is best to kill or remove such.

In a letter read before the British Association, from M. Sace, of Neufchatel, Switzerland, giving an account of some experiments in the feeding of domestic fowls, he informs us that some hens, fed upon barley alone, would not lay well, and that they tore off each other's feathers. He then mixed with the barley some feathers, chopped up, which they ate eagerly, and digested freely. By adding milk to the food, they began to lay, and ceased plucking out each other's feathers. He concludes, that this proceeding arose from the desire of the hens for azote food.

#### WHITE COMB.

"This disease," say the authors of the "Poultry Book," "makes its first appearance in the form of small white spots on one or both sides of the comb of the cock, which are so thickly clustered together as to be sometimes mistaken for a sprinkling of meal or other white powder. It seems to be of a scorbutic, or leprous nature—a form of disease to which all animals of Eastern origin are particularly liable. It is a disease to which the Shanghai is constitutionally subject; although we have heard of its existence in birds exposed to irregular diet and want of cleanliness. The disease should be attacked as soon as it makes its appearance. The consequences of neglect are related in the following communication, with the appropriate remedy:

"The disease is not confined to the combs only, but spreads itself down the neck, both in front and back, and takes off all the feathers as

far as it goes, *leaving the stumps*. I saw a bird very lately, with his neck and breast entirely stripped of feathers, but the stumps all left, so that no hope of their return can be entertained until the time of moulting.

"Now to the remaining question, 'How can it be cured?' By applying *cocoa-nut oil* and *turmeric*. This simple remedy has been tried with perfect success. No other oil but that of the cocoa-nut seems to answer the purpose. The proportions are about a quarter of an ounce of turmeric powder to one ounce of cocoa-nut oil. The latter, at an ordinary temperature, is solid, and very much resembles spermaceti; but it easily blends with the turmeric, and forms a yellow ointment. Three or four applications, with a day's interval between each, will usually be found effectual."

M. Tegetmeier suggests the separation of the sick bird, a plain, unstimulating, wholesome diet—say of oatmeal and water, with a supply of green vegetables—and the administration of some alterative medicine: as flour of sulphur ten grains, and calomel one grain, given every other night; or a three-grain Plummer's pill might be given instead. The plumage will not often reappear until next moulting-time.

#### VERMIN—LICE.

The whole feathered tribe seem to be peculiarly liable to be infected with lice; and there have been instances where fowls have been so covered in this loathsome manner, that the natural color of the feathers has been undistinguishable.

Mascall says, "They get them in scraping abroad among foul straw, or on dunghills, or when they sit in nests not made clean, or in the hen-house, by their dung lying long there, which corrupts their bodies and breeds lice and fleas."

The presence of vermin is not only annoying to poultry, but materially interferes with their growth, and prevents their fattening. In trifling cases, no particular attention is requisite; but when the cases are bad, the fowls should be removed from the nest.

A writer in the *Cultivator* recommends mixing sulphur with Indian-meal and water, and feed in the proportion of one pound of sulphur

to twenty-four fowls, in two parcels, a few days apart. It is said this will completely exterminate the lice, and produce a remarkably healthy and glossy appearance in the fowls. Strew oil-meal about the floor, in the nests, and against the rafters and sides of the buildings. Lining the nests infected with lice with tobacco-stems will expel them not only from the nests but from the body of the fowl. Another writer in the same paper says, "Lice may be destroyed by placing lard beneath the wing and on the back of the chicken." Sulphur, thoroughly dusted into the roots of the feathers, and spread over the entire skin, if used twice or thrice at intervals of a few days, is a certain cure. But the best remedy we have ever found is cleanliness in their roosting-places and nests, which should be often whitewashed with hot lime-water, and to place plenty of slaked lime, dry ashes, and sand, well mixed, where they can roll and bathe, by which means they will soon free themselves of the pests.

Hens, while hatching, are very apt to become infested with lice; so much so, that they are often driven from the nest. We have known the eggs covered, and the nest alive with them. In such cases we would recommend removing the litter and eggs, and cleansing the nest with scalding water. Then line the nest with tobacco-stems.

A friend of the author was complaining last spring of the difficulty of keeping his hens on the nest in consequence of the vermin infesting them. We recommended the above, which was adopted with perfect success, and he raised a greater number of chickens than ever before. This year he raised 250, while last year he raised not more than 20 or 30 from the same number of hens.

#### RHEUMATISM AND CRAMP.

These diseases, though differing in their nature, arise so constantly from the same cause, and are so readily removed by the same treatment, that we have placed them together. A disinclination and inability to move the limbs, evidently not arising from mere weakness or a permanently cramped condition of the toes, are sufficiently characteristic.

*Causes.*—Both disorders are caused by exposure to cold and wet, and the tendency to them may be much counteracted by preventing the fowls, during their chickenhood, from running among wet grass early in the morning.

*Treatment.*—Local applications are perfectly useless. Good food, and a warm, dry habitation, are generally effectual. When chickens are hatched at such times as February and March, it must not be expected that any treatment can counteract perfectly the unnatural circumstances under which they are placed. If exposed, they suffer from cold; and if confined in close rooms, the want of fresh air, natural green and insect food, produce equally unfortunate results.

#### EATING THEIR EGGS.

It is well known that hens, when kept shut up, are very apt to eat their eggs. The best preventive is to keep them well supplied with lime and gravel, and with fresh meat, in some form.

Fowls to which a portion of chalk is given with their food, lay eggs the shells of which are remarkable for their whiteness. By substituting for chalk a calcareous earth, rich in oxide of iron, the shells become of a light cinnamon color.



## CHAPTER XII.

## TURKEYS.

NEXT to the common fowl, the most useful, beautiful, important, and interesting bird is the Turkey; it is a native of North America; a noble bird, far exceeding its domestic relative, both in size and beauty; and we can boast of the Wild Turkey, a bird so truly valuable, that Dr. Franklin observed, that "it would have been a much fitter emblem of the country than the Bald-headed Eagle, a lazy, cowardly, tyrannical bird, living on the labors of others, and more suited to represent an imperial despotic government than the Republic of America." However true this may be, it is universally admitted that the turkey is entitled to the nobility of the barn-yard. Those who have seen only the domesticated bird, can form but a very faint idea of its beauty in a state of nature.

The turkey, with the exception of the domestic fowl, is the most recent of our reclaimed birds. That we can not fix the precise time, nor learn any of the circumstances which relate to the introduction of the turkey into Europe, may cause some astonishment when we reflect that it must have occurred at some period after the conquest of America. Buffon says, it "was unknown before the discovery of America, and it has no name in the ancient language. The Spaniards call it *pavor de las Indias*—the Peacock of the Indies, because its tail is like a peacock."

Oviedo, who resided as Governor of the fort and harbor of St. Domingo, in the island of Hayti, in 1514, published, among other works, one entitled "*Tratado de la Historia Natural de las Indias*," which was published at Toledo in 1526. In this work he describes the turkey as a kind of peacock abounding in New Spain,

whence numbers had been transported to the islands and the Spanish Main, and were domesticated in the houses of the Christian inhabitants. They were also called the *India Cock and Hen*, as they were first taken from the West Indies to Europe.

## THE WILD TURKEY.

This bird is strictly a native of North America, having its range from the Isthmus of Darien on the south, to the fifteenth degree north; and east and west, the Atlantic Ocean and Rocky Mountains. No individual of the species has been seen south of Panama, and it is utterly unknown beyond Lake Superior.

So greatly was the turkey esteemed in Europe shortly after its introduction, that in the year 1566, a present of twelve turkeys was thought not unworthy of being offered by the municipality of Amiens to their King, at whose marriage, in 1570, it is stated that they were first eaten in France. Hercksback asserts that they were introduced into Germany about 1530; and a sumptuary law, made at Venice in 1577, particularizes the tables at which they were permitted to be used. They were first introduced from Spain into England as early as 1525, and were in a short time spread over the whole kingdom, and increased to that degree, that in 1555 they could already furnish a dish in country feasts. They have since been domesticated throughout the civilized world, in every climate, although said not to succeed equally on the barren sands of Africa.

The plumage of the Wild Turkey is generally described as being compact, glossy, with metallic reflections; feathers double, as in other gallinaceous birds, generally oblong or trun-

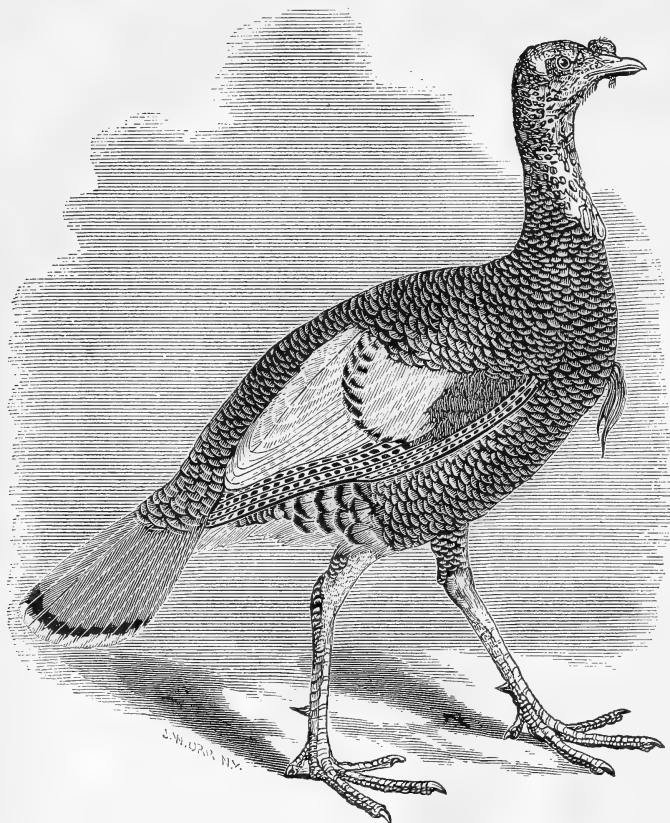

THE WILD TURKEY.

cated; tips of the feathers almost conceal the bronze color. The large quill coverts are of the same color as the back, but more bronzed with purple reflections. The lower part of the back and tail coverts are deep chestnut, banded green and black; the tail feathers are of the same color, undulatingly barred and minutely sprinkled with black, and having a broad blackish bar toward the tip, which is pale brown and minutely mottled; the under parts duller; breast of the same color as the back, the term-

inating black band not so broad; sides dark-colored; abdomen and thighs brownish-gray; under tail coverts blackish, glossed with brown, and at the tips bright reddish-brown.

The plumage of the male is very brilliant; that of the female is not so beautiful. When strutting about, with tail spread, displaying himself, this bird has a very stately and handsome appearance, and seems quite sensible of the admiration he excites.

Dr. Bachman says, "that in a state of domes-

tication the wild turkeys, though kept separate from tame individuals, lose the brilliancy of their plumage in the third generation, becoming plain brown, and having here and there white feathers intermixed."

The wild turkeys are described as being much larger than the tame ones. Far from being improved by care and abundance of food, contrary to most other wild animals, this species have degenerated. Wild turkeys, it is said, often weigh from forty to sixty pounds.

Many attempts have been made to introduce the wild turkey, in its native state, on several preserves of game in Europe, but with the exception of one or two instances in England, they have not succeeded.

"The great size and beauty," says Audubon, who, it appears, has studied the habits, and written more largely of that bird than any other individual or natural historian, "of the wild turkey, its value as a delicate and highly-prized article of food, and the circumstance of its being the origin of the domestic race, now generally dispersed on both continents, render it one of the most interesting of the birds indigenous to the United States of America. The flesh is of excellent flavor, being more delicate and juicy than that of the domestic turkey. The Indians value it so highly that they term it 'the white man's dish.'"

"As a matter of curiosity more than profit," says a writer in the *Rural New Yorker*, "I purchased, two years ago last fall, a pair of full-blooded wild turkeys—real Native Americans—from a flock, some of which exceeded thirty pounds each in weight. Being but a novice in the rearing of poultry, I procured Mr. C. N. Bement's book upon the subject, turned to the article in which I was interested—being about five dollars *contra*—but no small amount of pleasure and profit in anticipation. I read with pleasure the observation of Dr. Franklin, who considered the 'wild turkey so truly noble and valuable that it would have been a much fitter emblem of the country than the White-headed Eagle,' and also that of Audubon, whose knowledge of the feathered bipeds can not be gainsayed, 'that its great size and beauty render it one of the most interesting of the birds indigenous to the

United States—that its flesh is of excellent flavor, more delicate and juicy than that of the domestic turkey, rendering it a valuable and highly-prized article of food,' all of which was highly flattering to my new enterprise, and quite an inducement with me to persevere.

"Being a native of Down East, and an advocate for progression, I felt an instinctive desire that, in the general march, any improvement in the main feature of our time-honored festival, so indispensable as the turkey, should not be neglected; but in pursuing the article farther, I found doubts expressed by some partial experiments as to rearing and domesticating them, intimating that their disposition to wander off would be very difficult if not impossible to overcome. Now I live within about thirty rods of thirty acres of timbered land, which produced great quantities of nuts a year ago last fall, the first season of my enterprise, which afforded as great temptations to them, no doubt, as to the tame turkey, and they were often there, yet they were never known to be absent from their accustomed roost at night. I had but one male during last winter, and he selected the highest point on the wood-shed, which he maintained, regardless of the elements, every night, I believe, during the winter. The hens took a less conspicuous but more protected position inside.

"Last spring one of the hens succeeded in bringing out eleven chicks, which were left entirely to the mother, running at large. None of them appeared to suffer from exposure to rains or dews, and but for an accident by which we lost three, I should now be able to exhibit a brood of the most beautiful birds, whose aggregate weight would not have been less than 150 pounds, judging from the size of those on hand. I have had most kinds of poultry during the past two years, excepting ducks and geese, and I am satisfied that the wild turkey is the least destructive and least expensive.

"Two important considerations, so far as profit is concerned, remain to be noticed. Mine were fed nothing, after a few days old, till late in the fall. They appeared to thrive well on weeds, grass, and most kinds of flies and bugs, and during the continuance of grasshoppers

they enjoyed a continual feast. They are swift destruction to all the various kinds of bugs, flies, and other insects that infest the garden, except the rose bugs, those they could not be induced to breakfast upon.

"In a pecuniary estimate, exclusive of their weight and value in the market, I have given mine credit for some very nice cucumbers, melons, and squashes, nearly equaling them in value. My experience confirms all Mr. Beament says in regard to size, constitution, and habits, but I have always been unable to detect any propensity to wander off more than is common to the domestic turkey. His reasons for giving them a decided preference over the last, namely, 'that they are larger, often weighing from 20 to 30 pounds, more robust, will bear the rain and wet grass, and are therefore more easily raised; and also, being great hunters of flies, bugs, and other insects, they require less corn and meal, and, consequently, are more profitable,' corresponds with my two years' experience."

Bonaparte, in his splendid work on the "American Ornithology," gives an account of the ingenious way in which the turkeys escape the insidious attacks of their enemies: "These birds are guardians of each other, and the first who sees a hawk or eagle gives a note of alarm, on which all within hearing lie close to the ground. As they usually roost in flocks, perched on the naked branches of trees, they are easily discovered by the large owls, and when attacked by these prowling birds, often escape by a somewhat remarkable manœuvre. The owl sails round the spot to select his prey; but, notwithstanding the almost inaudible action of his pinions, the quick ear of one of his slumberers perceives the danger, which is easily announced to the whole party by a *chuck*. Thus alarmed, they rise on their legs and watch the motions of the owl, who, darting like an arrow, would inevitably secure the individual at which he aimed, did not the latter suddenly drop his head, squat, and spread his tail over his back; the owl then glances over without inflicting any injury, at the very instant that the turkey suffers himself to fall headlong toward the earth, when he is secure from his dreaded enemy.

"As early as the middle of February they begin to experience the impulse of propagation. The females separate, and fly from the males. The latter strenuously pursue, and begin to gobble or to utter the notes of exultation. The sexes roost apart, but at no great distance from each other. When a female utters a call-note, all the gobblers within hearing return the sound, rolling note after note with as much rapidity as if they intended to emit the last and first together, not with spread tail, as when fluttering round the females on the ground, or practicing on the branches of the trees on which they have roosted for the night, but much in the manner of the domestic turkey when an unusual or unexpected noise elicits its singular hubbub. If the call of the female comes from the ground, all the males immediately fly to the spot, and the moment they reach it, whether the hen be in sight or not, spread out and erect their tail, draw the head back on the shoulders, depress their wings with a quivering motion, and strut pompously about, emitting at the same time a succession of puffs from the lungs, and stopping now and then to listen and look. But whether they spy the female or not, they continue to puff and strut, moving with as much celerity as their idea of ceremony seems to admit. While thus occupied, the males often encounter each other, in which case desperate battles take place, ending in bloodshed and often in the loss of many lives, the weaker falling under the repeated blows inflicted upon the head by the stronger.

"Turkey cocks, when at roost, sometimes strut and gobble, spread out their tails, and emit the pulmonic puff, lowering their tails and other feathers immediately after. During clear nights, or when there is moonshine, they perform this at intervals of a few minutes for hours together, without moving from the same spot, and, indeed, sometimes without raising on their legs, especially toward the end of the love-season. The males now become greatly emaciated, and cease to gobble, their *breast-sponge* becoming flat. They then separate from the hens, and one might suppose that they had entirely deserted their neighborhood.

"About the middle of April, when the season

is dry, the hens begin to look about for a place in which to deposit their eggs. This place requires to be as much concealed as possible. The nest, which consists of a few withered leaves, is placed on the ground, in a hollow scooped out by the side of a log, or in the fallen top of a dry leafy tree, under a thicket of sumach or briers, or a few feet of the edge of a cane-brake, but always in a dry place. The eggs, which are of a dull cream-color, sprinkled with red dots, sometimes amount to twenty, although their usual number is from ten to fifteen. When depositing her eggs, the female always approaches the nest with extreme caution, scarcely ever taking the same course twice; and when about to leave them, covers them carefully with leaves, so that it is very difficult for a person who may have seen the bird to discern the nest.

"Turkey hens not unfrequently prefer islands for depositing their eggs and rearing their young, probably because such places are less frequented by hunters, and because the great masses of drifted timber which usually accumulate at their heads may protect and save them in cases of great emergency.

"When an enemy passes within sight of a female while laying or sitting, she never moves, unless she knows that she has been discovered, but crouches lower until he has passed. They seldom abandon their nest when it has been discovered by men; but never go near it again when a snake or other animal has sucked any of the eggs.

"The mother will not leave her eggs, when near hatching, under any circumstances, while life remains. She will even allow an inclosure to be made around her, and thus suffer imprisonment rather than abandon them.

"Before leaving the nest with her young brood, the mother shakes herself in a violent manner, picks and adjusts the feathers about her belly, and assumes quite a different aspect. She ultimately inclines her eyes obliquely upward and sideways, stretching out her neck to discover hawks or other enemies, spreads her wings a little as she walks, and softly clucks to keep her innocent offspring close to her. They move slowly along; and, as the hatching gen-

erally takes place in the afternoon, they frequently return to the nest to spend the first night there. In this tender state, when they are only covered by a kind of soft hairy down, rainy weather is extremely dangerous to them. To prevent the disastrous effects of wet weather, the mother, like a skillful physician, plucks the buds of the spruce-wood bush, and gives them to her young.

"In about a fortnight, the young birds, which had previously rested on the ground, leave it, and fly at night to some very large, low branch, where they place themselves under the deeply-curved wings of their kind and careful parent, dividing themselves for that purpose into two equal parties. After this, they leave the woods during the day, and approach the natural glades or prairies in search of strawberries, and subsequently of dewberries, blackberries, and grass-hoppers, thus obtaining abundant food and enjoying the beneficial influence of the sun's rays. They roll themselves in deserted ants' nests, to clear their growing feathers of the loose scales, and prevent ticks and other vermin from attacking them, these insects being unable to bear the odor of the earth in which ants have been.

"About the beginning of October, when scarcely any of the seeds and fruits have yet fallen from the trees, these birds assemble in large flocks, and gradually move toward the rich bottom lands of the Ohio and Mississippi. The males, or, as they are more commonly called, the *gobblers*, associate in parties of from ten to a hundred, and search for food apart from the females; and while the latter are seen either advancing singly, each with its brood of young, then about two-thirds grown, or in connection with other families, forming parties often amounting to seventy or eighty individuals, all intent on shunning the old cocks, which, even when the young birds have attained this size, will fight with, and often destroy them by repeated blows on the head. Old and young, however, all move in the same course and on foot, unless their progress be interrupted by a river, or the hunter's dog force them to take wing. When they come upon a river, they betake themselves to the highest eminences, and there often remain a whole day, or sometimes

two, as if for the purpose of consultation. During this time the males are heard *gobbling*, calling, and making much ado, and are seen strutting about as if to raise their courage to a pitch befitting the emergency. Even the females and young assume something of the same pompous demeanor, and spread out their tails and run round each other, *purring* loudly, and performing extravagant leaps. At length, when the weather appears settled, and all around is quiet, the whole party mounts to the tops of the highest trees, whence, at a signal consisting of a single *cluck* given by a leader, the flock takes flight for the opposite shore. The old and fat birds easily get over, even should the river be a mile in breadth, but the younger and less robust frequently fall into the water—not to be drowned, however, as might be imagined. They bring their wings close to their body, spread out their tail as a support, stretch forward their neck, and striking out their legs with great vigor, proceed rapidly toward the shore, on approaching which, should they find it too steep for landing, they cease their exertions for a few moments, float down the stream until they come to an accessible part, and, by a violent effort, generally extricate themselves from the water. It is remarkable that, immediately after thus crossing a large stream, they ramble about for some time, as if bewildered. In this state, they fall an easy prey to the hunter.

“When the turkeys arrive in parts where the mast is abundant, they separate into smaller flocks, composed of birds of all ages and both sexes promiscuously mingled, and devour all before them. This happens about the middle of November. So gentle do they sometimes become after these long journeys, that they have been seen to approach the farm-yards, associate with the domestic fowls, and enter the stables and corn-cribs in quest of food. In this way, roaming about the forests and feeding chiefly on mast, they pass the autumn and part of the winter.”

#### THE DOMESTIC TURKEY.

We have spoken of the turkey of nature; we will now treat of the turkey of art; that is, the turkey that makes so interesting a part of our

rural and domestic economy. They are, next to the common fowl, the most useful and valuable of domestic birds, and, at the same time, that which requires the greatest care in the first moments of its existence. When once reared, however, every temperature agrees with it.

Of the turkey, Buffon and others assert that there is but one species; and in this country we have three varieties—the black, the copper-color, and white. The first is considered the most hardy, and generally preferred; the second is held by some in great esteem; the latter, with their red head and caruncles, contrasted with their snowy whiteness, make a pretty appearance, and add much to embellish the grounds of the house. Their feathers are valuable, and they have much down on the thighs.

According to Parmentier, the white turkey, contrary to analogy, is by some thought to be more robust and easily reared and fattened; and hence large flocks of these may be seen in some parts of France. Such, however, is not our experience, but the reverse. The black turkey, on the contrary, is always most marketable, from its being said their skin is white, and their flesh finer and sweeter; while the males are larger, and the females are better breeders.

There can be little doubt that black turkeys are produced in greater numbers than any other color. Madame Clavier, an ingenious French lady, fond of rural economy, told M. Parmentier that she had a white turkey cock in her yard, with ten black turkey hens, and yet she never had a white chick hatched, nor even shaded in the slightest degree. In Dauphiny, on the other hand, they are found of every shade of color, from a deep black to a pure white.

Mowbray tells us that a turkey cock, the property of a gentleman in England, which was black in 1821, became afterward perfectly white, and in the process of moulting, just before this singular change, it gradually showed every shade between the two colors, the feathers being alternately black and white.

“Although not of ancient date,” says Main, “the subjugation of turkeys has already produced varieties in our climate. The most remarkable is that of the *tufted turkey*, as yet very

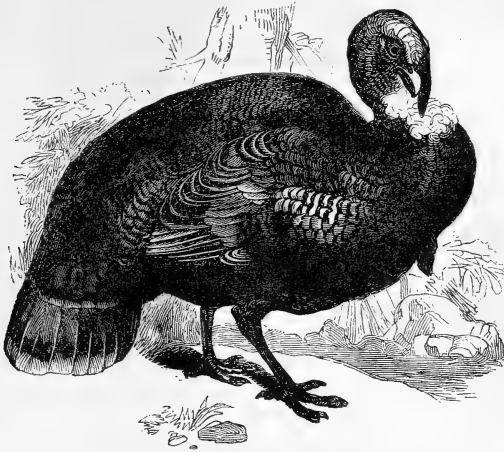

THE DOMESTIC TURKEY.

rare, and whose tuft is sometimes black and sometimes white."

Turkeys in the neighborhood of large woods, if not watched and prevented, will eagerly stroll thither without any design to return, such is the natural wildness of their species. In corroboration of the above, an instance was communicated by a correspondent in the *Sporting Magazine*, of May, 1824, who says, "Two years last harvest, a two year old cock and two hens of the same, belonging to me, were seen to prowl in a wood of eighty acres, a short distance from my house; and night coming on before they were observed by the person who had charge of them, all attempts to recover them were in vain. No tidings being had of them, all efforts to rescue them proved fruitless; and as nothing was heard of them for several months, I, of course, concluded that they were either picked up by some persons who had stumbled upon them, or had been killed by foxes. About six months ago, however, I was riding through a large covert about half a mile from that into which my turkeys were seen to go, when a hen, apparently in a state of alarm, ran before my horse's feet, and disappeared in the bushes. It immediately occurred to me, as the color was

the same, that she was one of the hens I had lost more than two years before. I have since caught her, and she is now in my yard. The other hen, which has young ones, was also caught, but on being given to a boy to hold, broke away from him again, and is still in the wood, with the cock-bird and the young ones. The one that I recovered had been sitting on eggs, as was evident from the state of her breast. Thus have these birds survived two winters, one a very severe one, in the woods, without either food or shelter, except that which nature provided for them."

That the turkey is susceptible of education is obvious from the following very interesting facts communicated to the author by Mr. L. Kennedy, of Hartford: "A few years ago I purchased a pair of turkeys, kept them through the winter, and in the spring, instead of laying at home, they absconded. After hunting them up a number of times, sometimes finding them two miles off, I killed them. In the fall I procured another pair, and as the snow melted away they began to play at the same tricks; but by shutting them up I obtained a few eggs, and raised three young ones. When they were about half-grown I killed the old ones. One of the young

ones was needed for 'Thanksgiving,' and the remaining two I kept through the winter. About the time for the hen to commence laying I killed the cock, to prevent too much conversation and intimacy with distant flocks. That year I raised eight young ones, and they seemed to have made considerable progress toward becoming domesticated.

"Last year I kept over two hens and a male bird, and in the spring they both laid near the house, one of them under a bush in the garden, and the other in the barn. The one in the garden laid her third egg on the morning after the last snow that season, which was, I believe, the last of March or fore part of April. I discovered her nest by the tracks in the snow. Supposing the first two eggs were injured by the cold, I left them in the nest, and removed the succeeding ones from day to day until I had taken out sixteen, when she began to sit. I then removed the two eggs and placed the sixteen in the nest, adding also one from the nest of the other turkey. The other turkey sat on fourteen eggs and hatched out twelve; only one, however, proved to be rotten, the other was broken in consequence of the nest being too dishing. I did not remove the eggs from this nest as they were laid. I placed the old turkeys in coops near to each other, and consequently I can not say how many of each brood died. The season was quite wet, so that I lost eleven and raised eighteen. I should have raised more, probably, had I been situated so as to have let them run sooner, but as it was I succeeded much better than most of the farmers in this section. I give the young ones no food for the first twenty-four hours or longer, leaving them to peck the stones and dirt. After this I feed moderately with the curd of sour milk, never with clear meal, until they are several weeks old.

"My turkeys, I am quite confident, not only know my voice but my person; and why not? 'The ox knoweth his owner, and the ass his master's crib.' This season they have not rambled to any distance, and usually taking care to be at home at meal times. But if all this is not sufficient to satisfy you of their being more domesticated than the 'commonalty,' let me

add another circumstance which somewhat surprised me. The first of November I changed my residence, moving about thirty or forty rods from my former house, designing to remove the turkeys as soon as I had prepared a place to *confine* them. But the day after I removed, the turkeys followed one of the members of my family without his calling them at all, and came to the barn of their present home, when I fed them. At night they flew into an apple-tree in the garden, and have given me not the least trouble since. The tree where they formerly roosted is within sight, and yet they have never been into it, but have remained perfectly contented with their new location. I have nine of them now, all but one of which I design to put on my farm in the spring. The males which I killed the 16th of November, averaged about 10 pounds, and one of them weighed 10½ pounds, all young ones.

"I think in an ordinary season I can ten-fold a flock of turkeys at an expense not exceeding twenty cents each."

As a further proof that turkeys may be made as tame and domestic as any other fowl, we will relate what occurred on our own premises: About two years ago we purchased a cock and two hen turkeys of the white variety. They had been hatched in the woods and suffered to run at large, and in the fall they selected some tall pines for their roosting-place. On bringing them home and putting them in the yard with the other fowls, they refused to stay there, and would not roost in the house at first, preferring the top of the building or a tall elm-tree standing near. As the cold weather approached, and feeding them only in the house, they finally took to roost with the other fowls, and have remained there ever since.

They soon became very quarrelsome, and would not suffer the other fowls to sit near them, pecking with their bills and throwing them from their roost. For which reason we attempted to keep them out of the yard, and removed them to the barn-yard, where there was a good shed for them to roost in. While the snow was deep they remained tolerably quiet, but as soon as the weather and snow would permit, they found their way to the yard



again. We removed them the second and third time, feeding them plentifully, but all to no purpose; leave the poultry-yard they would not.

The following account of the propensity in a cock turkey for incubation was related by a correspondent of the *Genesee Farmer*: "The circumstance," says the writer, "I am about to relate, as far as I know, is not common, if it exists at all. I have been in the habit of rearing a good many domestic fowls, and among them have been rather partial to the turkey, particularly to fat ones about Christmas. Among a brood I once possessed, there was one male, who was a long-legged, gander-shanked fellow, of a most unique appearance. During the period of incubation one of the hens began to sit, and she, seeming to know the old gentleman's propensity, was very careful to manage in a very private and secret manner. The cock began to grow uneasy, and mounted the stumps and fences, watching for the appearance of the hen, and peering about to find the place of her concealment, which he usually discovered the first or second day; when he, by virtue of his authority as one of the lords of creation, immediately took possession of the nest, and from that time forward, till the period of hatching, went on with the regular process, when he brought off his brood, and duly carried them forward to maturity; when the hen, poor simple wife, was allowed to trudge along at a respectable distance, in the true after-honeymoon style.

"Although I am aware that certain other birds, male and female, alternately sit upon the nest during the period of incubation, yet I am not informed of any case where a male has shown such a decided passion and propensity for the sedentary habit of hatching eggs. This he has performed for three years in succession, and being such a notable exhibition of pugnacious opposition to petticoat government, he became quite a favorite, and I intended to have kept him as an example to some of my neighbors, and as a *rara avis in terris*. But one night he came up missing, and whether he was sacrificed as a target at a Christmas gambol, or made one at Master Reynard's supper, or is even yet sitting on eggs that proved addled, I was never able to ascertain."

"The antipathy," says Mowbray, "which the turkey cock entertains for any thing of a red color, is well known; and indeed will never be forgotten by myself, who, at about the age of eight years, having on a red waistcoat, was chased by two of them around a very extensive yard, to my most terrible affright and discomfiture."

*Rearing Turkeys.*—The first great requisite is to have good stock to raise from, both male and female. The cock turkey should be of a large size, and as he does not attain to his full growth till he is two or three years old, one of this age is to be preferred, though yearlings are generally made to answer. The color should be jet-black or bronze, with legs to match. There is very little difficulty in finding a cock turkey whose strut is sufficiently martial to satisfy the most precise stickler for a military carriage. With tail spread and erect, breast inflated, and head and throat inflamed, he marches a perfect Haynau of the poultry-yard. The number of females that should constitute his harem are hardly ever more than can be suitably provided for by him. A great point is to prevent a deterioration of stock by breeding in-and-in. It is, therefore, necessary to change the cock turkey every year. A strong and healthy brood of chicks is thus secured.

With the same view, the largest hen turkeys—and if more than a year old the better—should be reserved for mothers. If you expect a large litter of eggs, the hens must be well kept through the winter, but not so as to become very fat, otherwise they will not lay so early as is desirable. If they do not begin to lay till May, they will not complete their litter and be ready to sit till June, which will bring the hatch into July; and thus only five months allowed for their growth until the period arrives for Thanksgiving turkeys. It is considered, therefore, by experienced persons, quite an object to have an early litter of eggs.

The turkey is an out-of-door bird. In this respect he retains, even in his domesticated state, that love of freedom which characterizes the aborigines of our country. Turkeys have no fondness for a shed or shelter for a roosting-place; but in the coldest weather in winter, in

the severest storms of rain or snow, they prefer the open air, and a lofty tree on which to take up lodgings for the night. Here, perched head to the wind, they ride out the hardest gales in safety with apparent pleasure. The instances are rare in which they are known to perish from cold or storm. When the old hens shed their feathers late in the fall, as will sometimes be the case, it is well to house them in storms and cold nights, till they renew their feathers, and it may be prudent to do so in extremely severe weather in winter.

We will now suppose that winter is gone, and spring is beginning to open. The notes of the blue-bird and robin are heard welcoming the advent of warmer skies. As the snow melts away, patches of green grass are here and there disclosed to view. Turkeys no longer hang about the barn, like so many loafers, but spend most of their time in the orchard, and on the sunny side of walls and buildings. The cock turkey now is as full of airs as any city dandy, perambulating hither and thither, strutting in front and at the sides of his hens, more intent on exciting admiration of his own beautiful person than bestowing it upon theirs. This species of courtship continues throughout the spring, even after the hens have laid out their litters and have begun to sit. His attentions to them during this period often become so officious and annoying that it is best to separate him entirely from them.

The hen turkey is very shy in selecting her nest, and is sometimes so particular as to be a number of days in securing a place to her fancy. In this she is probably governed by instinct to provide a safe place for her eggs and her young. The first intimation, after mating, of her disposition to lay, is by her stealing away from her companions, going here and there, with head down, as if meditating upon the task before her. If closely watched, she will be most likely to give up her project for the present. Even after she has begun to lay, she must be followed at a distance. A better way to find the nest, if out of doors, is to observe the direction in which she returns from it.

If left to her own choice, the turkey will usually make her nest out of doors, at the side of

walls, under a bush, in long grass, or in a thicket. Although so fastidious in the site of her nest, she is not at all particular as to the materials of which it is composed, and is as well contented with the bare ground as with a bed of leaves. After a place is selected, it is not always the first day or the second that it is made the depository for the first egg. She seems intent rather on adapting herself to it and endeavoring to get the hang of it. The number of eggs which a turkey will lay in the spring varies from fifteen to twenty-five. They should be gathered daily, or as often as they are laid, and carefully kept in a cool place. If left out over night, they may be chilled or stolen. But to guard against such accidents nature teaches the turkey—silly bird as we sometimes call her—just what to do, by covering them up carefully with leaves or dead grass. To be sure she does this in warm weather as well as cold, but the covering serves equally in both to screen them from observation.

When she has laid her litter, the turkey manifests her desire to sit by remaining on her nest even if no nest-egg be under her. She should be permitted to do this for some days before the eggs are placed under her, observing, however, to drive her off at night if the nest be out of doors. When this is the case, it will not be safe to let her sit there, as the eggs and herself will be exposed to weasels, skunks, foxes, and other midnight marauders. A nest should therefore be prepared for her under cover. The barn is a good place for this purpose, and the ground-floor. Better still is a shed or an out-house, which can be kept fastened, as the liability to accidents is thus diminished to almost none at all. The nests should be rather shallow, and spread out over sufficient space for all the eggs to rest on the surface.

The number of eggs that can be covered by a turkey depends upon her size: twenty is a large number, and better success may be expected with fifteen or seventeen. Having placed the eggs in the nest, allow the hen turkey to remain on her original nest, if out of doors, till dusk, and then carefully take her in your arms and remove her to her new abode. Sometimes she will be frightened and disposed to escape.

To prevent her leaving, secure a piece of lattice, made of laths, in front of the nest on placing her there. Similar screens may be attached to all the nests, thus keeping the inmates as securely shut up as if they were in so many cages. This arrangement demands more care of the turkeys than when they have their liberty, as they must be let off every day to eat and drink, and for health and cleanliness. The way once learned into the building, there is no trouble in their returning to it afterward.

The turkey is a close sitter, so close that we have almost uniformly been obliged, on removing the lattice, to use some efforts to drive her off. She quits reluctantly. When off, she feeds and drinks eagerly; she runs about quickly, pecking the green grass, and if she can find any dry loose dirt she settles herself in it, flapping the dirt rapidly with her wings over her body, and then hastens back to her nest. This adhesiveness to her eggs grows stronger as the time of hatching approaches. She should then seldom be disturbed. Four weeks is the usual term of incubation, but it is protracted sometimes a day or two longer. Turkeys' eggs may be placed under common fowls, and hatched with success, if no more eggs are used for this purpose than can be fully covered. This is convenient in the spring, in order to enlarge other broods.

As soon as the chicks break the shell it may be known by a peculiarly soft and tremulous sound uttered by the mother, as if recognizing the new-born brood, and expressing the anxious sensations that now throb in her bosom. We know of no sound more touching and plaintive; a sound which she never makes till this epoch in her existence. A turkey will almost always hatch out the larger proportion of her eggs on which she has sat, and not unfrequently the whole of them. We have known instances when, on removing the old bird for the first time after hatching, the entire brood presented themselves as lively as crickets.

Now that the young have fairly entered on life, what is to be done with them? Were she in the woods, wild and undomesticated, leave them to the care of the mother; for Nature is the best guardian and provider. But she is un-

der our protection, and in our hands is the destiny of her offspring. We must do something for them at least after they are one or two days old, or they will perish by starvation. In doing this, however, avoid the too frequent and mischievous practice of stuffing and overloading them with food. They are but tiny birds, with delicate constitutions. In a state of nature, ants' eggs are eagerly devoured by them; curd, or thickened milk, chopped fine, we have found a good substitute. Crumbs of bread, softened in milk or water, is excellent food for them when quite young. The same food of which the parent turkey eats, except grain in an unbroken state, the chicks will eat. They are great devourers of insects. Did you never observe them, when they espied a bug or fly, and notice with what precision and unerring aim they seize it? They should, for one or two weeks, be kept in a dry place under cover, and they may be placed out of doors in some inclosure to keep them from rambling. A frequent practice is to tie the mother to a stake, with a string tied to one of her legs; but this is a bad practice, and liable to many accidents. The best way to confine the mother is to place a crockery crate over her, at the sides of which the little ones could have an easy passage in and out. To confine the young and prevent them from going abroad before the dew is off in the morning, boards may be placed at the sides and ends, and secured by driving stakes in the ground. The top should be covered with boards also, to protect them from rain. There should also be a floor of boards—an old door would be still better, as it would be tight, and keep out rats, etc. The floor should be covered with hay or straw, which should often be replenished and removed frequently for the purpose of cleanliness. The cleaner they are kept the less liable are they to be infested with lice.

As the chicks grow, they will need larger supplies of food. Curd and thick skim-milk are good articles of diet. Beware of giving any salt with the food of young turkeys. For drink, let them be supplied with water placed in shallow vessels.

After a few weeks, the young brood may be allowed to accompany the mother in her ram-

bles, giving her the range of a pasture if practicable. They will soon learn to forage for insects, which promotes their health and growth. Dry summers make large turkeys, the weather being favorable to their rambling, and insects and grasshoppers are then plenty.

Early in the fall they should be fed night and morning with dry corn. When the weather becomes colder, they may be supplied at frequent intervals with boiled potatoes, mashed with Indian meal and skim-milk, given to them warm, of which they are very fond. If they are fed regularly, they will soon learn to come for their meals. If thus plentifully fed, they thrive most rapidly, increasing in size, in the short space of six months, from the mere chick that was hatched in the spring to the plump and tempting roaster, if a male, of twelve to fifteen pounds, and if a female, eight and ten pounds weight.

Now, the question may be asked, will they pay a profit for the rearing? When they bring twelve and fifteen cents per pound, we think those that raise them are generally satisfied. Besides, it is a pleasant task to have the care of turkeys. They are sociable, and company at all times; first to salute you in the morning with their gabbling, then the young with their pee-up, pee-up, etc. And the interest we take in them is all the greater from the care and solicitude with which we have watched over them.

It has often been repeated that extreme difficulties occurred in raising the turkey; and that when, by dint of great pains, we had succeeded so far as to secure them from those accidents which threaten them till the time when the red color of the head shoots, the expenses they afterward incurred to bring them to a desirable plumpness, exceeded the produce of the sale; this was sufficient to deter farmers from admitting this bird into their farm-yards, and they have been consequently deprived of a sure means of increasing the resources of the house, and at the same time of adding to the resources of the farm.

It is important, in breeding animals, to attend to their natural instinct as much as possible, and it is no doubt from the neglect of this,

that all the degeneracy and difficulty of rearing them which occurs may arise.

In its native forests the turkey is naturally a wandering and migratory bird, and hence it is unnatural to confine it to the narrow range of a poultry-yard; we speak from experience, as we found it, to our sorrow true, for one or two years. They have a strong disposition to wander, and will sometimes steal away a long distance from home, apparently wishing not to be observed.

Laborious efforts are not here required, but some care and a little patience. If attempts to raise turkeys have not been crowned with success, it is entirely owing to the unskillfulness and inexperience of those to whom they have been intrusted; and as long as it is persisted in thwarting the females when sitting, in opening the shells of the eggs in order to help the passage of the tardy chicks, in pressing them, as soon as born, to make them eat against their will, in leaving them exposed to intense heat or cold damp; so long will their death be the undoubted consequence of such usage in the course of a month. It is less trouble to say that the bird is difficult to rear, than to acknowledge, at once, that negligence, unskillfulness, and barbarity were the causes.

Delicate as they are supposed to be, they can find their living in the woods, and feeding on acorns, roots, berries, insects, and wild nettle seed. It is curious to observe with what adroitness and certainty they will pounce on the smallest bug or fly. The strong propensity of turkeys to perch in the open air and on high places, is a sufficient reason for those who rear them to attend carefully to this point. Scarcely, indeed, does the *red* appear, when the fowl shows his unconquerable desire to perch in the open air, though this can not safely be permitted till they are two or three months old. Open sheds are consequently best suited to them, with roosting-bars, fixed as high as convenient from the ground, which should be about three times as large as for common fowls.

*Pairing.*—Some writers say from six to eight hens may be allowed to one cock, while others assign from ten to twelve. "Your turkey cock," says Gervase Markham, "should be a large and

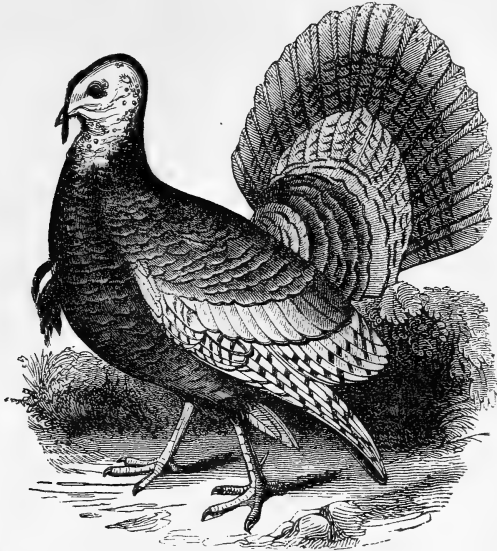

DOMESTIC TURKEY.

stout bird, proud and majestic, for when he walketh dejected he is never good." And Mascall says, "He should be passing a year or two years old—three years is the most, and too much." According to Parmentier, both the cock and hen ought to have short legs, a full shape, and great vivacity and energy in all their actions. For breeding, it is peculiarly necessary that both should be well formed and in healthy condition.

The plumpness or leanness of the hen, the climate or localities, will alone forward or retard her laying. By feeding and taking proper care of her in winter she will be disposed to lay earlier in spring, and to begin afresh at the end of the summer. Nature seems to have taken all the trouble on herself.

*Laying.*—In the wild state, about the middle of April, when the season is dry, the turkey hens begin to look out for a place in which to deposit their eggs. In a domestic state, the time of laying is usually a month earlier than that of the wild turkey. It may readily be seen,

indeed, when a hen is about to commence laying, by her vivacity, and also by her endeavors to secrete herself, and steal away from the observation of the keeper. She utters, besides, a peculiar note, indicative of her feelings; and when this has once been heard, it can never afterward be mistaken.

The time of laying is almost invariably in the morning of every second day, though some hens will lay every day, till from fifteen to twenty eggs have been laid; in a wild state, more usually from ten to fifteen, according to the age of the bird; for a young bird, two or three years old, will lay nine, and larger eggs than when only one year old.

During the time of laying, it is advisable to confine the cock, at least in the morning, when she is laying; otherwise, if he finds her on the nest, he will ill-treat her, drive her away, and break her eggs.

It does not appear, from Audubon's account, that the wild turkey has usually more than one brood in the year, unless her eggs have been

carried off or destroyed; and Buffon says, the tame turkey only lays once a year, which is wrong; for, in favorable circumstances, when well fed and taken care of, the hen turkey will lay a second time, toward the end of summer, sometimes sooner and sometimes later.

In the second laying, there are rarely more than a dozen eggs; and in order to have the brood from these successful, more than ordinary care will be required.

*Hatching.*—A turkey hen is one of the most steady and inveterate sitters of any known fowl. Before she has even completed her laying, she shows a wish to sit by unequivocal signs; she clucks like the common fowl, and continues in her nest till her breast becomes bare of feathers. While laying or sitting, she never moves when an enemy passes in sight, unless she knows she has been discovered, but crouches lower until he has passed; hence the difficulty of finding them when laying abroad.

In the domestic state, the instinct of the turkey hen is truly remarkable; her little artifices and tricks to conceal her eggs, and to deceive those who might try to discover her nest, appear almost dictated by reason; but what brings her back to the rank of a brute, is her manner of sitting; for even when her eggs are taken away, she will continue to sit on any substance whatever, even stones. It is, therefore, a matter of consequence that she be satisfied; for sitting without eggs would fatigue her more than natural hatching.

When turkey hens have been left to themselves during their laying, and have chosen a nest at a small distance from the house, there is hardly any thing to be done, for they will leave it with difficulty, and it is even prudent not to thwart them, for they generally hatch their own brood safely, and the young ones are the stronger for it.

The turkey hen sits from thirty to thirty-two days, and, it is said, will continue on the nest even until starvation; and when hatched, she is not the most careful mother, nor is she a good provider, as she does not scratch for her young, like the hen, but leaves them to shift for themselves; but she is very alert to discover birds of prey and give timely notice. As the

young, at the moment of their birth, give no signs of seeking their food, and as they are not instructed in the least so to do it by the mother, it appears necessary to admit two or three eggs of the common fowl to those of the turkey-hen, ten days after sitting, so that the young ones may be hatched at the same time; as the common chickens peck and eat as soon as out of the shell, they become for turkey chickens an example which they imitate, and which determines them to eat a few hours sooner, which is of some use.

The hen and brood must be housed during one month or six weeks, dependent upon the state of the weather. The scorching sun and the rain are above all hurtful to them; superfluous moisture, whether external or internal, is death to chickens, therefore, all slop victuals should be rigorously avoided. The utmost cleanliness is necessary, and a dry graveled layer is most proper. High places exposed to the east or south are those which always agree best with chickens, especially when they have a small separate yard.

At the Rhode Island State Agricultural Fair, Mr. Chedell, of Barrington, exhibited an interesting turkey cock, that took a notion to try the art of incubation. How he succeeded the following will show: "Last year," says a writer, "Mr. Gobbler actually sat on a dozen eggs until the chickens were hatched, and then he brought them up with all the assiduity of a hen, combined with the masterly protection which his own red throat, sharp and curled spurs so amply afford. This year a more economical method took his fancy, and instead of spending his precious time in hatching, he has deputed this duty to the hens, and as soon as a brood comes forth he immediately takes charge of the chicks, and releases the hens from farther responsibility. The hens are again employed in sitting, while he takes charge of the chicks and anticipates their every want. He goes out every morning and conducts them to good hunting-grounds in the woods and fields, where grasshoppers, grubs, and other luxurious game, afford ample sport for the young. In this way he provides entirely for the fowls under his protection, so that they cost nothing to keep them."

*Food.*—The French, and all foreign writers, recommend for their first food, “bread crumbled and soaked in wine.” The best food, however, which we have found for them, was eggs boiled hard and chopped fine; thick sour milk, boiled, which makes a thick curd; the whey is separated by putting it into a colander, or coarse sieve, and when cold, rubbed fine in the hands, and fed to them in small parcels, and often. Indian meal wet in the ordinary way is injurious to them, until they are several weeks old. Chives cut fine and mixed with their food, is eaten with great avidity. In case of the chicks appearing sickly and the feathers ruffled, indicating a chill from severity or change of weather, ground malt, with a little barley-meal, is allowed, and, by way of medicine, powdered caraway or coriander seeds. Boiled meat pulled into strings, in running after which the chicks have a salutary exercise. It will be borne in mind that the above diet is beneficial for every other species of chicks, equally with the turkey.

Water should be given them in very shallow vessels, in which they can not wet themselves, as this would be very injurious. In order to prevent the mother turkey from robbing the chicks of their food, they should be fed in a separate coop at such a distance from her as to be out of her reach.

Some recommend removing the chicks from the mother as they are hatched, but we are not of that opinion; nature seems to be the best guide, as they generally keep under the mother, as animal warmth is, without doubt, infinitely more necessary to them than food. It is well known that birds, on leaving their shells, quit a warmth of sixty or seventy degrees, and that they often perish, sooner or later, on account of the difference of temperature through which they pass so suddenly; and being so excessively delicate, they should not be taken from warmth and repose; therefore in the beginning of his existence, the new-born chick remains under the wings of his mother, where he finds the warmth nearly equal to that he had in the egg; by removing him from this shelter, to handle and feed him, he passes too suddenly from heat to cold, from rest to exercise; and

this sudden change, so hurtful to grown animals, becomes more especially so to the turkey-chicken, where natural delicacy and want of feathers render him more sensitive to the transitions.

When young, they should be kept in a warm and dry place; and when introduced into the open air, it should be by degrees, and choose the finest days. They should not be suffered to go abroad in the morning till the sun has dried the dew, and they should be shut up before the fall of the evening damps. On their return at evening they should be fed, except in harvest time, when they have gathered enough in the fields.

The mother leads them with the same solicitude that the hen leads her chickens; she warms them under her wings with the same affection, and protects them with the same courage. It would seem that tenderness for her offspring gives quickness to her sight; she discovers a bird of prey at a prodigious distance, when it is yet invisible to every other eye. As soon as she perceives her dreaded enemy, she vents her fears by a scream that spreads terror through the whole brood; each little turkey seeks refuge under a bush, or squats in the grass, and the mother keeps them in that situation by her cries, so long as danger is impending; but when her apprehensions are removed, she informs them by a different note, and calls them from their concealment to assemble around her.

Young turkeys are interesting, for they have different tones, and different inflections of voice, according to their age, their sex, and the various passions by which they are influenced; their pace is slow, and their flight tardy.

At two periods of their lives turkeys are very apt to die; viz., about the third day after they are hatched, or when they throw out what is called the “red head,” which they do at about six weeks old. It is a very critical period in the life of a turkey—much more so than the period of moulting; the food must, therefore, be increased, and rendered more nutritious by adding boiled eggs, wheaten flour, bruised hemp seed, or a few bruised beans.

Turkeys are the most tender and difficult to rear of any of our domestic fowls; but with due

care and attention, which, rightly considered, in all things gives the least trouble, they may be produced or multiplied with little or no loss; and the same may be said with all truth of the rest of our domestic fowls and animals in general, the losses and vexations annually deplored arising almost entirely from ignorance and carelessness united hand in hand. Turkeys as well as geese, under a judicious system, may be rendered an object of a certain degree of consequence to the farmer.

*Of the fattening of Turkeys.*—It is only when the cold comes, and when turkeys are about six months old, that they should be fed with better and more plentiful food, in order to increase their size and plumpness for market. Indian corn, ground barley, wheat, also rice and other articles, used to fatten common fowls, are considered best for turkeys. Their weight, when well fattened and carried to market, should average twelve pounds; their living and dead weight is as eighteen to twelve pounds.

Cobbett says, "As to fattening turkeys, the best way is never to let them get poor. Barley meal, mixed with skimmed milk, and given to them fresh, will make them fat in a short time. Boiled potatoes mixed with Indian meal, will furnish a change of sweet food which they relish much, and of which they may eat as much as they can. As with others, the food of this bird must be kept clean, and the utmost care taken not to give them on the morrow the remains of the mixture of the preceding day; because if the weather is warm, it will sour, which might displease them."

In some sections, in order that they may all get fat more *expeditiously*, some professional poulterers cram their turkeys, which, with the barbarous practice of depriving them of sight, and light, and motion, by confining them in narrow inclosures, is so revolting to humanity, that it is to be hoped that the horrid custom is but seldom practiced, in this country at least. The very idea is enough to disgust and cloy the appetite of the most consummate epicure!

There are said to be some advantages attending this mode of feeding turkeys; but it is, to say the least, unnatural and cruel; and therefore, fattening in freedom, and as they naturally

choose, is a more certain way of procuring pure and healthy birds, free from all plethoric disease.

We give the following, which was published in the *National Recorder*, more for its singularity than in the belief of its usefulness: "In the winter of 1818-19, a gentleman in this city made the following experiment. He placed a turkey in an inclosure about four feet long, two feet wide, and three or four feet high. He excluded as much light as he could without preventing a circulation of air, and fed the turkey with soft brick broken to pieces, and with charcoal also broken, and with ten grains of corn per day. Fresh water was daily supplied. The box or coop in which the turkey was placed he always locked up with his own hands, and is perfectly confident that no person interrupted the experiment. At the end of one month he invited a number of his neighbors, among others, two physicians. The turkey, now very large and heavy, was killed and opened by the physicians, and was found to be filled up with fat. The gizzard and entrails were dissected, and nothing was found but a residuum of charcoal and brick. To conclude the examination satisfactorily, the turkey was eaten and found to be good.

"The circumstance which induced him to make the experiment is a very curious one. One of his neighbors informed him, that being driven from the city by the fever of 1793, his family recollected that some fowls that had lived in a kind of loft over his workshop had been forgotten in the hurry of their removal, and would certainly be starved. They were absent six or eight weeks, and on the retiring of the pestilence returned. To their great astonishment, the fowls were not only alive, but very fat, although there was *nothing but charcoal and shavings* that they could have eaten, and some water that had been left in the trough of a grindstone, had supplied them with drink."

*Fattening Turkeys on Charcoal.*—Much has been published of late in our agricultural journals in relation to the alimentary properties of charcoal. It has been repeatedly asserted that domestic fowls may be fattened on it without any other food, and that, too, in a shorter time than on the most nutritive grains. "I have re-



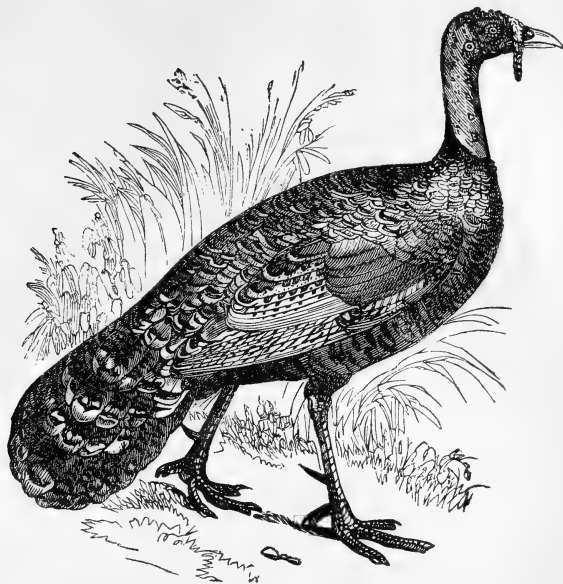

THE HONDURAS TURKEY.

cently made an experiment," says a writer in the *Germantown Telegraph*, "and must say, that the result surprised me, as I had always been rather skeptical.

"Four turkeys were confined in a pen, and fed on meal, boiled potatoes, and oats. Four others, of the same brood, were also at the same time confined in another pen, and fed daily on the same articles, but with one pint of very finely pulverized charcoal, mixed with their food—mixed meal and boiled potatoes. They had also a plentiful supply of broken charcoal in their pen. The eight were killed on the same day, and there was a difference of one and a half pounds each in favor of the fowls which had been supplied with the charcoal, they being much the fattest, and the meat greatly superior in point of tenderness and flavor."

Since the publication of the fourth edition, the author has received the following very interesting and valuable suggestions from Colonel Wade Hampton, of South Carolina:

"I have read your treatise on poultry with much interest, and have derived from its perusal very many valuable suggestions.

"On the subject of rearing turkeys, I venture to make you a suggestion or two. As soon as they are removed from the nest, immerse them in a strong decoction of tobacco, taking care to prevent the fluid from entering the mouth or eye of the chick, and repeat the operation whenever they appear to droop. Corn-bread, soaked in pepper-tea, is the best diet for them, after they are two or three days old, that I have ever tried. They are particularly liable to chills, which nothing so effectually cures as the pepper. A tablespoonful of Cayenne pepper to a quart of boiling water is about the rate at which it is used."

#### THE HONDURAS TURKEY.

Beautiful as is the common wild turkey of this country, it is said to be far surpassed by the Honduras turkey, which rivals the peacock



THE BRUSH TURKEY.

## THE BRUSH TURKEY.

in its gorgeous dress, effulgent with its golden bronze, steel-blue, emerald green, and velvet black. A specimen of this rare bird is now said to be in the Paris Museum. Of the habits of the species, which appears to inhabit the vast forests of Honduras, nothing is known. The specimen in question was one of those seen by a crew employed in cutting wood, and captured alive. It died after it arrived in the Thames, in consequence of an accident.

Two species only are known to naturalists, namely, the common wild turkey (*Meleagris galopavo*) of North America, the origin of our domestic stock, and the Honduras turkey (*M. Ocellata*), figured on page 219, a bird which, in the metallic splendor and varying tints of its plumage, outrivals the peacock, if not every tenant of the air. But except, perhaps, in some of the dense untrodden forests of Yucatan and of Central America, from Cape Honduras to the tenth degree of north latitude this bird might be sought for in vain. Of its peculiar habits and manners nothing is positively known. We may suppose, however, that it resembles, to a great degree, the common wild turkey of the north. Could it be domesticated in our Southern States, what a splendid acquisition should we have to our poultry-yard!

This bird is a native of Australia and the Pa-puan Islands, and in various parts of New South Wales. In the dense brushwood of Manning and Clarence it is plentiful. It was found in the scrubby gullies and sides of the lower hills that branch off from the great range into the interior; on the Brezi range, to the north of the Liverpool Plains, and was abundant on all the hills on both sides of the Naomi. It is gregarious, moving about in small companies, like many other gallinaceous birds; but the most remarkable circumstance connected with the economy of this bird is its nidification, for it does not hatch its own eggs by incubation. The bird is a thorough chemist, and constructs for itself a patent artificial incubator, on truly chemical principles, by which it hatches its eggs in a scientific manner, without the tedious operation of sitting, to which other birds submit. It is a believer in fermentation and co-operation; for when the breeding season arrives, a number of these birds enter into copartnership, as it were, and collect together a huge heap of decaying vegetables as the place of deposit of its eggs; thus making a hot-bed, arising from the decomposition of the collected matter, by the heat of



which the young are hatched. Mr. Gould describes this heap or mound as the result of several weeks' collection by the birds previous to the period of laying, as varying in quantity from two to four cart-loads, and as of a perfectly pyramidal form. This mound, he states, is not the work of a single pair of birds, but is the result of the united labor of many; the same site appeared to Mr. Gould to be resorted to for several years in succession, from the great size and entire decomposition of the lower part, the birds adding a fresh supply of materials on each occasion previous to laying.

"The mode," says Mr. Gould, "in which the materials composing these mounds are collected is equally singular, the bird never using its bill, but always grasping a quantity in its foot, throwing it backward, as represented in the engraving, to one common centre, and thus clearing the surface of the ground surrounding the hot-bed for a considerable distance of every leaf and blade of grass, every scrap of vegetation being added to assist fermentation. The heap being accomplished, and time allowed for sufficient heat to germinate, the eggs are deposited, not side by side, as is ordinarily the case, but planted at regular intervals, at the distance

of nine or twelve inches from each other, and buried nearly an arm's length beneath the surface, perfectly upright, with the large end upward. They are covered up as they are laid, and allowed to remain until hatched.

"Some of the natives state that the females are constantly in the neighborhood of the heap about the time the young are likely to be hatched, and frequently uncover and cover them up again, apparently for the purpose of assisting those that may have appeared; while others have informed me that the eggs are merely deposited and the young allowed to force their way unassisted. In all probability, as Nature has adopted this mode of reproducing, she has also furnished the tender birds with the power of sustaining themselves from the earliest period; and the great size of the egg would equally lead to this conclusion, since in so large a space it is reasonable to suppose that the bird would be much more developed than is usually found in eggs of smaller dimensions. In farther confirmation of this point, I may add, that in searching for eggs in one of these mounds, I discovered the remains of a young bird, apparently just excluded from the shell, and which was clothed with feathers, not with down, as is

usually the case. The upright position of the egg tends to strengthen the opinion that they are never disturbed after being deposited, as it is well known that the eggs of birds which are placed horizontally are frequently turned during incubation."

It is affirmed, both by the natives and settlers living near their haunts, that it is not an unusual event to obtain nearly a bushel of eggs at one time from a single mound, and they are said to be delicious eating.

Mr. Gould also relates that these birds, while stalking about the wood, frequently utter a loud clucking noise; and in various parts of the bush he observed depressions in the earth, which the natives informed him were made by these birds in dusting themselves. The stomach is stated by Mr. Gould to be extremely muscular; and he found the crop of one which he dissected filled with seeds, berries, and a few insects.

When the Brush Turkey is disturbed, it either runs through the tangled underwood with singular rapidity, or springs upon a low branch of some tree, and reaches the summit by a succession of leaps from branch to branch. This latter peculiarity renders it an easy prey to the sportsman. The composure with which these birds sit to be shot at must, as Mr. Gould observes, lead to an early extinction of the race; an event, he remarks, much to be regretted, since, independently of its being an interesting

bird for the aviary, its flesh is extremely delicate, tender, and juicy. There is no doubt that this species may be domesticated, and it would make a noble addition to the denizens of the poultry-yard which enrich our homesteads and our tables.

The Brush Turkey (*Tallegalla*) is not a very striking bird in appearance. The beak is robust and convex; the wings are moderate; the tail ample; the head and neck furnished with short hair-like feathers; the cheeks naked; and the front of the neck presents a carunculated naked skin, or sort of wattle, reminding us of that of the turkey—hence its name. In the adult male the whole of the upper surface, its wings and tail, is of a blackish-brown at the base, becoming silvery-gray at the ends. The skin of the head and neck is a deep pink, verging on red, and thinly sprinkled with short hair-like blackish-brown or dingy feathers; wattles bright-yellow, shading off into red where it unites with the red of the neck; bill black; irides and feet brown.

The female is about one-fourth less than the male in size, but so closely the same in color as to render a separate description unnecessary. She also possesses the wattle, but not to so great an extent. Size about that of a hen turkey. In general habits this turkey is nothing remarkable; it is in the reproduction of the species that its anomalous proceedings are manifested.



THE PEACOCK.

## CHAPTER XIII.

## THE PEA-FOWL.

WE are not going to narrate the natural history of the peacock. It has been done over and over again; and although proverbial philosophy has taught us that "a good story can not be told too often," another equally wise saw, with the sharpest possible teeth, has assured us that "too much of one thing is good for nothing." All we propose to do is to gossip about the peacock.

Oh! a gay gallant is the peacock as he struts about in the morning sun, first one side, then the other, proud of his bright, beautiful coat, resplendent in the light; his sharp eyes looking

about as if he courted praise and felt that he deserved it; his form so graceful, as his long tail sweeps the ground like the train of a countess, or as he sometimes stands before his less-endowed brother, and spreads that tail of his in a semicircle, all bright and gay, gleaming with its black discs and circles of gold.

Proudly, indeed, the peacock moves along, as though he were the very king of birds; proudly he extends that glittering tail of his, brightly jeweled, as it seems in the glory of the sunshine. But he is only beautiful to the eye. What poet can sing in praise of the peacock?

Surely the turtle-dove, with its plain Quaker garb and endearing manners, is far more worthy of the poet's song. Pleasant is it to listen to the cuckoo, the plain song-cuckoo of Bottom the weaver—the beauteous stranger of the grove, the messenger of spring. But the peacock has no other recommendation than that of a fair exterior, a gay and gorgeous plumage. Says Young:

“How rich the peacock! what bright glories run  
From plume to plume, and vary in the sun!  
He proudly spreads them to the golden ray,  
Gives all his colors, and adorns the day;  
With conscious state the spacious round displays,  
And slowly moves around, a waving blaze.”

Oh! a noble fellow is the peacock; his small head crowned with a crest of feathers, choice and straight; his neck long and slender, tapering gracefully from the breast upward; his back and wings of a light ash color, mingled with black; his head, and neck, and breast of a greenish-blue, with a gloss which, in the sunshine, appears exceedingly brilliant; his eyes set between two stripes of white; the feathers of his tail of a changeable mixture of green, blue, purple, and gold. Standing thus before us, he is one of the most beautiful objects imaginable.

This most magnificent and beautiful of all the feathered race is supposed to have been originally a native of India; but they have long been introduced into Europe and this country as ornaments to the mansions of gentlemen farmers. Peacocks are said to be at present found in a state of freedom upon the islands of Java and Ceylon. The earliest mention we can trace of the peacock is in the Book of Job. The history of King Solomon is an evidence of the antiquity of the peacock, and also the choice of the goddess Juno, who selected this for her favorite bird, from its gorgeous and brilliant plumage and majesty of demeanor. It is asserted by the ancient writers that the first peacock was honored with a public exhibition at Athens; the rumor of the arrival spread all over Greece; from distant parts the rich and the noble took their journey to the classical city, to pay handsomely to be spectators of that beautiful phenomenon and wonderful paragon

of the feathered race. Going to look at the peacock was not only an expensive, but an aristocratical entertainment. How greatly admired was the magnificent bird! How, in beholding the gay plumage, the people would listen and wonder as the showman of the day informed them that the black and ill-formed legs of the birds were the objects of aversion even to the birds themselves, and they were never so happy as when they spread their gorgeous tails and felt the power of their appearance exercised on the gay groups of sight-seers before them.

At a later period, the Grecian ladies had the tail-feathers of peacocks arranged in the semi-circular sweep, and used them as fans. Bright and beautiful fans they were, too, with the brilliant colors and the glittering gold shining in the light, and the fashion contributed greatly to the picturesque costume of those ancient dames.

“There are,” says Goldsmith, “various descriptions of peacocks, some of which are white, others crested; that which is called the Peacock of Thibet is the most beautiful of the feathered creation, containing in its plumage all the most vivid colors, red, blue, yellow, and green, disposed in almost artificial order, as if merely to please the eye of the beholder.”

*Characteristics.*—The crow, or, rather, the scream, of the peacock is loud, harsh, and disagreeable. It is only heard during the breeding-season, and it is one of those rural sounds which proclaim the approach of summer. This, together with the frequent appearance of the cock in “full glory,” exhibiting his splendid train, are sure signs that the business of nidification is at hand. The hen has always much apparent listlessness in her manner; for even when looking about for a proper place to deposit her eggs, she makes no sign that she is so engaged, but walks leisurely about, as if she were looking for food. She is, however, seeking the most private corner she can find, at some distance from the concourse of houses of the other poultry. If a wood or shrubbery be near, she will choose a place under a bush, and generally among dry fallen leaves. The nest is generally made of sticks and leaves rudely thrown together, and contains from twelve to fifteen eggs.

The best food for young pea-fowls are ant-eggs, as they are called, barley-meal paste mixed with sweet curd, and hard-boiled eggs chopped fine; when grown up, they live on any kind of grain. The young do not attain their full plumage until the third year, and only the males possess the vivid tints and lengthened train, the female being a comparatively ordinary bird. A white variety of the peacock is not uncommon. In this case, the eyes of the train feathers are slightly marked with a kind of neutral tint.

But however beautiful may be the outward form of this gaudy bird, its disposition is of a very different character from its plumage; it is said to "have the plumage of an angel, the voice of a devil, and the stomach of a thief." Its loud, harsh voice grates unpleasantly on the ear; while

its insatiable gluttony and spirit of depredation more than counterbalance the beauty of its external form. Exclusive of the consideration of ornament to the mansion, the peacock is useful for the destruction of all kinds of reptiles; but, at the same time, some are said to be vicious, and apt to tear to pieces and devour young chicks and ducklings suffered to come within their reach, on account of which we discarded them from our premises.

Peacocks are not worth the attention of the farmer on the score of profit, but they may be made useful to keep watch; as they will roost on the highest chimney, the top of the barn, or any elevated place, and from it they will issue their loud and piercing cry on the approach of any stranger or enemy, taking the place of the watch-dog.

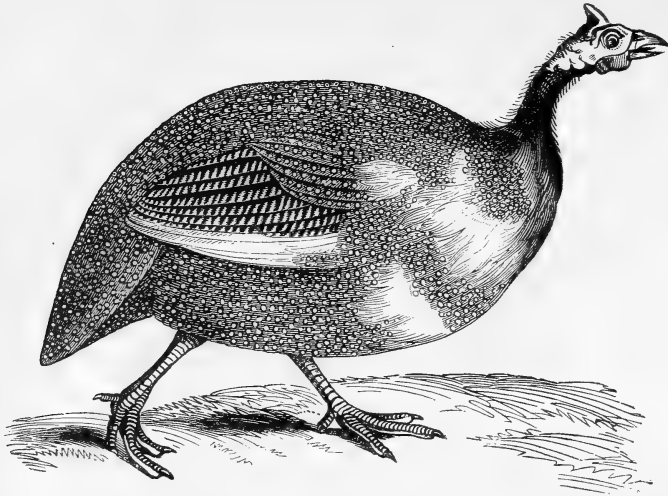

THE GUINEA-FOWL.

## CHAPTER XIV.

## THE GUINEA-FOWL.

THIS is the *Numidia Meleagris* of ornithologists, which received the name of Guinea-fowl on account of its being brought from the Guinea Coast of Africa, and was anciently confounded with the turkey, and is supposed to have been introduced soon after the Europeans had visited the western coast of Africa, in their voyages to India, by the Cape of Good Hope. There is no doubt, from the descriptions given by Columella and Varro, that the Guinea-fowl was reared on the farms of the Romans as early as the commencement of the Christian era, and that it was first made known to them during the wars with Africa. "The African hen," says Columella, "which most persons call the Numidian, bears upon her head a bright-red helmet and crest."

The Guinea-fowl has not only been diffused through Europe, at a very early date, but transported into America.

In the Middle Ages we lose all trace of it; no writers of those times appear to notice it; but

in the early part of the 18th century it was tolerably common in England, and is now completely naturalized.

Anderson, Dampier, and other travelers in Africa, have observed the wild Guinea-fowl in different parts of the continent; but, as about six species are known, we can not be certain which of them is intended.

The common Guinea-fowl appears to be dispersed through an extensive range of Africa, frequenting low, humid situations, and the banks of rivers and marshes. It is eminently gregarious, assembling in large flocks, which wander about in the day in search of food; as evening approaches, they seek the branches of trees, and roost crowded together. It is of a restless, wandering disposition, which does not leave them in captivity. It will stray for miles from the farm to which it belongs, and it often happens that a long-missed female will make her appearance with a young brood attending her.



In close confinement, the female rarely hatches her eggs, the want of freedom interfering with her natural instincts. Few birds, indeed, are more recluse and shy during the time of incubation, or more cautious in concealing their nest. It is generally made among dense brushwood, or in similar retreats. The number of eggs varies from twelve to twenty. They are smaller than those of the common fowl, and of a pale yellowish-red, minutely dotted with dark points.

There are several varieties of the Guinea-fowl, such as the white, the spotted, the Madagascar, and the crested. Charlevoix pretends that a wild race of these birds is found in St. Domingo and others of the West India Islands, which is said to have been imported from Guinea.

The Guinea-fowl differs from all other poultry in its being difficult to distinguish the male from the female; the chief difference being in the color of the wattles, which are more of a red hue in the male, and more tinged with blue in the female. The male also has more of a stately strut.

From the earliest times to the present, it has been no great favorite with poultry-keepers, and but few have patronized them; and is one of those unfortunate beings which, from having been occasionally guilty of a few trifling faults, has gained a much worse reputation than it really deserves, as if it were the most ill-behaved bird in creation; whereas it is useful, ornamental, and interesting during life, and when dead, if young, its flesh is tender, very superior, resembling in flavor our partridge, and a desirable addition to our dinners at a time when all other poultry is scarce and out of season.

"We have heard complaints," say the authors of the "Poultry Book," "of the large proportion of 'bad,' that is, unfertile, eggs, which are laid by them; but this occurs only because those who keep them are ignorant of the fact that they pair like our domestic pigeons, and that very rarely indeed does the male bird prove unfaithful to his mate. This is no drawback upon their being kept for the purpose of profit, since the male of the second year is excellent

for the table, and should be slaughtered early in the spring, to make way for a youthful successor."

Various attempts have been made to have the Guinea-fowl wild in England. In the north and in Ireland they all perished during the winter, and in the south of England we have been informed of an instance where they were obliged to be destroyed to prevent the entire driving away of other feathered game, which they were rapidly effecting.

*Description.*—The beak is short, stout, slightly curved, and whitish, having a warted bluish-red membrane at its base; wattles fleshy and scarlet; eye black, prominent, and bright; eyebrow very distinctly marked and arched; head and neck covered with downy feathers, like those of the Silk fowl; forehead surmounted by a long casque; tail short, and pitching downward like that of the quail; legs blue, with a tinge, in places, of flesh-color. The plumage, though not decorated with rich and dazzling colors, is singularly beautiful, being spangled all over with white spots, varying in size from that of a pea to infinite minuteness, on a bluish-black ground. The weight of the male very slightly exceeds that of the female; and, indeed, the hens of the same brood have been known to outweigh the cocks.

The Guinea-fowl is a lively, restless, turbulent bird, that dislikes confinement in the same place, and, being very pugnacious, contrives to become master of the poultry-yard, domineering over the fowls, and boldly attacking even the fiercest turkey cock; for, though much smaller in size, it gains the ascendancy over them by the mere dint of petulant pugnacity.

Its rapid mode of running, its short wings, and pendent tail, its short flight when forced to take wing, remind us of the partridge, which it also much resembles in the contour of its body. It is also one of those birds which, by wallowing in the dust, rid themselves of vermin. They also scrape or scratch the ground, like the common fowl.

The desirability of having the males and hens in similar numbers renders the inquiry important, how to distinguish the one from the other. There is but one unerring characteristic, and

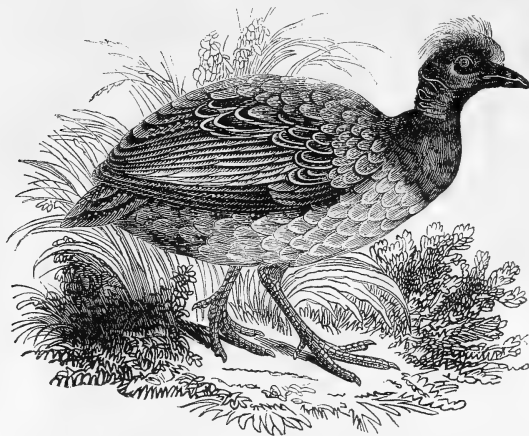

CRESTED GUINEA-FOWL.

that is, the hen only utters the well-known and everlasting cry, or clamor, of "Come back." The note, or wail, for it is mournful, of the male bird is totally different; he has somewhat larger wattles than the hen, and runs on tip-toe with a mincing gait, which the hen never imitates; but her "Come back" cry is the only unmistakable mark of distinction.

Of all the tenants of our poultry-yard none produce chickens so pretty and interesting, when first hatched, as the Guinea-fowl. Their orange-red beaks and legs, their zebra-striped down, and their extreme sprightliness, render them most peculiarly attractive. They are so strong and active, when first hatched, as to appear not to require the attention really necessary to rear them. Almost as soon as they are dry from the moisture of the egg, they will peck each other's toes, as if supposing them to be worms, will scramble with each other for a worm, and will domineer over any little chicken that may happen to have been hatched in the same clutch with themselves. No one, who did not know, would guess, from their appearance, of what species of bird they were the offspring.

The chicks require feeding as soon as they are dried after escaping from the shell, and should never be without a supply of food after-

ward until they are of a size permitting them to have their liberty.

Under a shed in a warm corner of the garden, with a southern aspect, is the best place for the coop under which the mother is to be confined; for cold winds and rain are very destructive to them. In the garden, the chicks find that large amount of insect food which is so promotive of their growth and health. In addition, they should have eggs boiled hard, and chopped very fine, mixed with Indian meal, oat-meal, and barley meal, millet, and curd, all separately, and on different days, for the sake of change of diet. Change of food is one great means of promoting the health and growth of all poultry. Pure clean water, in shallow vessels, should be kept constantly before them. In fact, the whole management of both young and old may be precisely the same as that of turkeys.

By their continued clamor and watchful nature they are useful in protecting the other poultry from the hovering hawks—for which reason, if no other, a few should always be kept in the poultry-yard.

## THE CRESTED GUINEA-FOWL.

The Crested Guinea-fowl is less in size than the common species just described; the head

and neck are bare, of a dull blue, shaded with red, and instead of the horny casque, it has an ample crest of hairy-like disunited feathers, of a bluish-black, reaching as far forward as the nostrils, but in general turned backward. The general plumage, except the quills, is of a bluish-black, covered with small grayish spots, sometimes four and sometimes six on each

feather. Quills yellow-brown; edges of the secondaries pure white.

We are not aware of any of this variety or species of Guinea-fowl ever being domesticated or introduced into this country; of course we know nothing of its habits or qualities. As a rare bird, we hope to see it introduced into our poultry-yards.

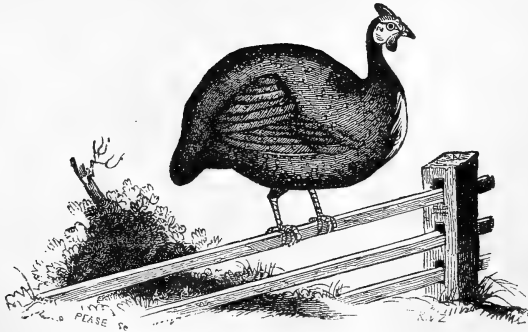

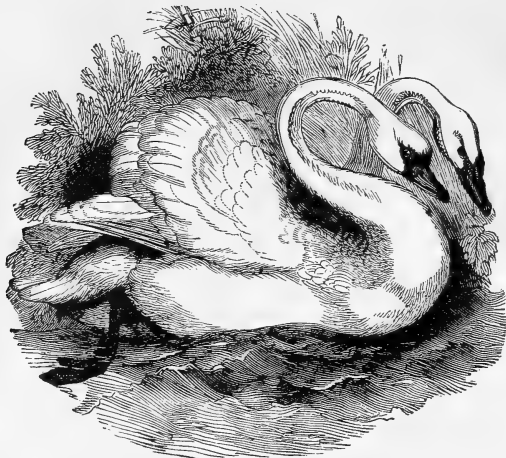

MUTE SWANS.

## CHAPTER XV.

## AQUATIC FOWLS.

## THE WHITE SWAN.

At the head of this class of birds may justly be placed the stately and majestic Swan. Next to the peacock on the land, the swan is the most noble and elegant fowl on the water. Though they are seldom found on any farms in this country, and are not in request as food, they are well worth the notice of every one having a pond or an inclosed part of a creek, to enliven and beautify the scenery by a small family of swans.

Every person that has visited Fairmount, Philadelphia, must recollect the beautiful swan that floats silently and majestically on the bosom of the little pond at its base. Its beautiful plumage of pure white, black legs, feet, and bill; its beautiful curved neck and graceful movements, could not escape the notice of any one.

The antiquity of this stately bird, the "silent swan," is conspicuous in the pages of history

and poetry. The prototype of the domesticated breed has been probably lost in the lapse of time, "since the wild swans," says Mowbray, "of all countries, differ essentially, both in plumage and organic structure, from the tame. The longevity of the swan seems to equal, if not exceed, that of any other animal, as it is said to live three centuries."

"The goose, the swan, and the eagle," says Boswell, "are well known to be the longest lived birds. Of the former, it is comparatively easy to discover the precise age; of the third, from its very nature, it is clearly impossible; and of the second, from its temporary overpowering propensity to change situations, it is very difficult. The place of an old swan may be supplied by a younger one, and may still, from their similarity, be considered the same."

Besides the tame swan, there are said to be three European varieties. Of these one has been recently characterized; it is allied to the tame swan, but instead of the legs, toes, and

web being black, as in the latter, they are of a pale ashy gray. The cygnets are white. Mr. Yarrell, the first discoverer of this species (of which several individuals are living, and have bred in the garden of the Zoological Society), observes, that this species has been known to him for some years past, as an article of commerce among London dealers in birds, who receive it from the Baltic, and distinguish it by the name of the Polish swan. In several instances, these swans had produced young in this country, and the cygnets when hatched were pure white, and did not at any age assume the brown color borne for the first two years by the young of all the other species of swan.

"During the severe winter of 1837-8, flocks of the swan were seen pursuing a southern course along the line of our northeast coast, from Scotland to the mouth of the Thames, and several specimens were obtained. One flock of thirty, and several smaller flocks, were seen on the Medway. The skull of this species differs in certain points from that of the tame swan, according to Peleren, who has published a paper on the subject in the 'Magazine of Natural History,' April, 1839. Of the two remaining swans, one is the wild swan, Hooper, or Whistling Swan, a native of the whole northern hemisphere, breeding on the borders of the arctic circle, and migrating southward in winter. In America, the emigration of this swan is bounded by Hudson's Bay on the north, and extends southward as far as Louisiana and the Carolinas. It extends its winter visits in Europe and Asia as far as the warmer latitudes, and passes into Egypt. The windpipe of this swan is remarkable for a loop which passes into the substance of the keel of the breast-bone."—*Penny Magazine*.

The last European species is Bewick's swan, which has been confounded with the Hooper, but which, as Mr. Yarrell has demonstrated, is a distinct species. Like the preceding, it is a native of the high northern regions, migrating south in winter. Its windpipe is of smaller calibre than that of the Hooper, and passes far more deeply into the keel of the breast-bone.

"The tame swan," says Dickson, "is very

different from the wild swan which are sometimes seen in England, though by no means common."

"The tame or mute swan," says a writer in the *Penny Magazine*, "is abundant on the Thames, each pair having their exclusive range or district, at least during the breeding season. The nest, in the formation of which both male and female labor, is made on the banks, among reeds or osiers, on one of the osier islands. It consists of a mass of sticks or twigs, raised sufficiently high to prevent its being overflowed by any rise of the water."

The swan feeds like the goose, and has the same familiarity with its keepers, kindly and eagerly receiving bread which is offered, although it is a bird of courage equal to its apparent pride, and both the male and female labor hard in forming a nest of water plants, long grass, and sticks, generally in some retired spot; and they are then very dangerous to approach, their size and strength enabling them to break a man's limb with a stroke of their wing. The hen begins to lay in February, producing an egg every other day, until she has deposited seven or eight, on which she sits six weeks. Buffon says it is nearly two months before the young are excluded. Swans' eggs are much larger than those of the goose, white, and with a hard and somewhat tuberosus shell. The cygnets are ash-colored when they first quit the shell, and for some time after; indeed, they do not change their color, nor begin to moult their plumage, until twelve weeks old, nor assume their perfect glossy whiteness until advanced in their second year.

Swans can not be made to thrive without abundance of water to swim in, and clear water is to be preferred to that which is muddy.

The swan is found in various parts of North America. Here this noble bird is seen floating near the shore in flocks of some two or three hundred, white as the driven snow, and from time to time emitting fine sonorous and occasionally melodious notes so loud that they may be heard, on a still evening, two or three miles. There are two kinds, so called from their respective notes; the one the trumpeter, and the other the whooper; the former is the largest.

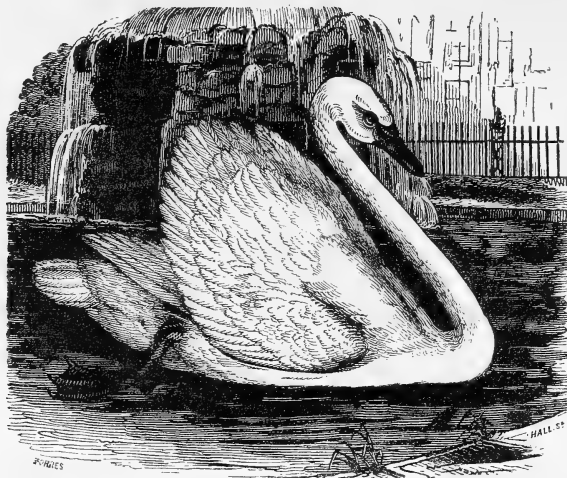

THE WHITE SWAN.

These birds are sagacious and wary, and depend more on sight than on the sense of smell.

It is doubtful whether the swan could be kept through the winter north of New York. Our winters are too severe for them, and it is necessary for them to have water to resort to, sufficient for them to swim in, in winter. Mr. Prentice, of Albany, imported a pair from England, a few years since, and placed them in artificial ponds supplied from springs, but they did not do well, and finally died.

Our readers will probably remember to have seen, a few years ago, a pair of these splendid birds sporting in the basin of the Bowling Green, at the foot of Broadway, New York. When we saw them, they had not recovered from their confinement in cages, and looked rather rough; still they added much to the beauty of the scene.

A very interesting account of "a weather-wise swan," we find in an English paper, which we transcribe: "This swan, the property of Lord Braybrooke, which was eighteen or nineteen years old, had brought up many broods, and was highly valued by the neighbors. She

exhibited, some eight or nine days past, one of the most remarkable instances of the power of instinct ever recorded. She was sitting on four or five eggs, and was observed to be very busy in collecting weeds, grass, etc., to raise her nest. A farming man was ordered to take down half a load of haulm, with which she most industriously raised her nest and the eggs two feet and a half. That very night there came down a tremendous fall of rain, which flooded all the malt shops and did great damage. Man made no preparation—the bird did. Instinct prevailed over reason—her eggs were above, and only just above the water."

In the Appendix to Brown's "Poultry-Yard," we find the following, communicated by the late Samuel Allen: "It has been said that the *common swan* will not breed in this country, in consequence of the variableness of our climate. But this is an error, probably founded on ignorance of their habits, and the mode of their propagation; for they have been successfully bred for a few years past by Mr. Roswell L. Colt, of Paterson, New Jersey, who has, by-the-by, a fine pond and every other accommodation necessary for rearing them.

"Having written to Mr. Colt, a few days since, for information on this subject, I have just received at this moment the following reply:

"PATERSON, Dec. 1st, 1849.

"DEAR SIR—You ask me what success I have had with my swans. I got them from France four years ago last spring. The first year they did not lay. I suppose they were young ones. The second year I had two eggs, which did not hatch. The third year I had five eggs, four of them hatched out in thirty-nine days. The fourth year I had six eggs, all of which hatched out on the third of June, also in thirty-nine days. The swan lays an egg every other day, and begins to lay here toward the end of April. I have lost two young ones; but on examination could not discover any cause for death.

"Swans must have an abundance of clean water to swim in. I feed mine with Indian corn, rye, oats, and buckwheat, put at the edge of the pond, close to the water, as they like to wash down their food as they partake of it. When the cygnets are young, I give them Indian meal, mixed with water, and boiled potatoes broken up. I throw into the water some clover, green leaves of Indian corn, lettuce, cabbage, spinach, besides the corn and oats, etc. They also come out and eat grass like geese. In fact, they may be fed as you would a favorite goose, and with a fresh, clear pond of water, you will succeed.

"Truly yours, R. L. COLT."

A lake of half an acre in extent is quite sufficient not only to maintain a pair of swans, but to supply an acceptable lot of cygnets in the fall; but in confined waters they require a liberal supply of food in the autumn, when the weeds run short. It should be remembered that, at this season, they have to supply themselves with a new suit of feathers, as well as to maintain their daily strength. If they have been taught to eat corn, and have not acquired a notion of grazing, they perish from starvation as undoubtedly as a canary bird neglected in its cage. Young birds are apt to be fanciful or stupid, and have not sense enough to come to

the bank and eat grass, or pick up the thrashed corn that may be thrown down to them. Sometimes they may be tempted with a lock of unthrashed barley or oats thrown, straw and all, into the water, which they will instinctively lay hold of and devour. Swans have been kept on a much more limited space successfully.

The cygnets, when first hatched, are of a slaty-gray, inclining to mouse color. The time of incubation is about six weeks or thereabouts.

The happy parents will charge themselves with entire maintenance of their tender young, if they have but the range of a large extent of river banks and shallow water; will lead them up to the quiet ditches, point out the juicy blade, the floating seed, the struggling insect, the sinuous worm; will then steer to shoals left by some circling eddy, and stirring up the soft sediment with their broad feet, show that minute but nutritious particles may thence be extracted. As hunger is satisfied, and weariness comes on, the mother will sink in the stream till her back becomes an easy landing-place, and the nurslings are thus transferred, in a secure and downy cradle, to fresh feeding-places.

But in a restricted beat they must not be left altogether to themselves. A gently-sloping bank will enable them to repair at pleasure to the grassy margin. The old ones must have plenty of corn, which they will by-and-by teach their young to eat; tender vegetables from the kitchen garden, such as endive, lettuce, or cress, will help to sustain them, besides attracting the soft-bodied creatures that are of all food the most needful. Pollard frequently scattered on the surface of the pond will be of material assistance; and whatever it is found that they will eat, let them have in the greatest abundance. Their growth is rapid; their weight should be considerable, but with little time to acquire it in. The period can not be extended much longer than from June to the end of November. By Christmas they must all either be eaten or have migrated, when the parents will begin to direct their thoughts forward to a succeeding family. Confined swans sometimes get a sort of quid of mud, fibres, and gravel under their chins, which it is as well now and then to examine and clean out.

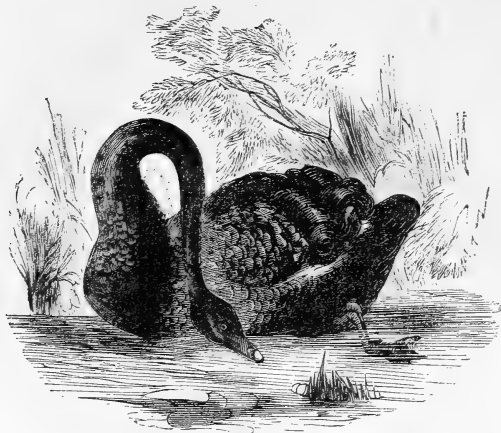

THE BLACK SWAN.

Those who have only a good-sized pond—say from a quarter to half an acre of water—may rear and fat an annual brood. In so small a space, the old birds must, of course, share with their young the extra supply of fattening corn; but they will get through the winter the better for it, and be more prolific in the spring. Neither they nor their cygnets should at any time be allowed to become poor.

When cygnets are removed from their parents to be fattened in a regular swan-pond, it is usual to separate them at the end of August or the beginning of September. At first, grass is thrown into the water to them twice a day, with their other food; but this is not continued more than two weeks. Four bushels of barley is the established allowance to fat each swan. Their weight, in the feathers, generally varies from 25 to 28 pounds, and sometimes, though rarely, 30 pounds. They are in season until Christmas, after which they are good for nothing for the table.

#### THE BLACK SWAN.

This bird is a native of, and is found in large flocks in Van Diemen's Land, and on the western coast of New Holland or Australia. It was first found at Swan, or Black Swan River, by a

Dutch voyager, who, in 1697, sailed forty or fifty miles up the river in his boat.

The Black Swan is exactly similar in its form to the swan of the Old World, but is somewhat smaller in size. Every part of its plumage is perfectly black, with the exception of the primaries and a few of the secondary quill-feathers, which are white. The bill is of a light-red color, is crossed at the anterior part by a whitish band; it is of a grayish color on the under part; and in the male is surrounded at the base by a slight protuberance. The legs and feet are all of a dark-ash color. Black swans, in their wild state, are extremely shy. They are generally seen swimming on a lake, in flocks consisting of eight or ten individuals. On being disturbed, they fly off in a direct line, one after another, like wild geese.

When Captain Flanders—an excellent sailor, of late years—first explored the same coast, he found black swans, in immense flocks, in the openings both of the rivers Tamer and Derwent. Of these flocks he says: "From one-fifth to one-tenth of them were unable to fly; they can not dive, but have a method of plunging so deep in the water as to render their bodies nearly invisible, and thus frequently avoid detection. In chase their plan was to gain the



wind upon our little boat, and they generally succeeded when the breeze was strong, and sometimes escaped from our shot also."

"The black swans of New Holland," says Mowbray, "I have not hitherto had the opportunity of seeing. They were introduced in this country some years since, but I believe the number bred or remaining is very small. They are said to degenerate here as to size, yet the imported individuals, it seems, were no larger than our indigenous breed. There is said by naturalists to be some disparity between the wild and tame black swan in respect to the bill and organization of the bones. Hence, probably, they form different species of the same genus."

"It is strange," says Dixon, "that their price should still continue so high, as they

breed in this country, frequently though not abundantly, under circumstances that must be considered unfavorable. We suspect, from the localities in Australia where they were originally found, that they would be all the better for occasional marine diet, and, like the shel-drake, enjoy now and then a treat of cockles and shrimps, with perhaps a barrowful of seaweed as the joint on which to cut and come again."

For those to whom the amount of purchase money is of little importance, the black swan is, beyond all question, the bird to place, as a finishing stroke of art, on the smooth lake or sheet of water which expands before our mansions. Its superb beauty, its gentle manners, is undeniable and acknowledged, and, indeed, altogether taking in its ways.

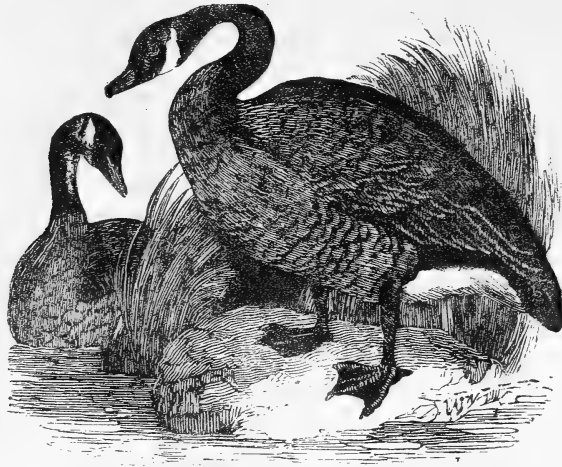

THE AMERICAN WILD GOOSE.

## CHAPTER XVI.

## AQUATIC FOWLS.

## THE AMERICAN WILD GOOSE.

THIS bird is the well-known Wild Goose of America; in Europe it is called the "Canada Goose." Most writers on poultry call it a variety of the common goose; but it is no more a variety of goose than the swan. Cuvier seems to doubt whether it is a goose at all, and says that it can not properly be separated from the true swans. The American wild goose, in spite of its migratory habits, which it appears in almost every case to forget in a reclaimed or domesticated state, shows much more disposition for true domestication than the swan, and may be maintained in perfect health with very limited opportunities for bathing. Audubon kept some three years, and although the old birds refused to breed in confinement, their young, which he captured with them, did. He states their period of incubation to be twenty-eight days, which is a shorter period than one would have imagined. That circumstance alone makes a wide distinction.

In a state of nature, the American wild goose eats worms and soft insects, as well as grass and aquatic plants, which the typical, or goose proper, never does. In a domestic or confined state they do not breed till they are at least two years old, and so far approach the swan, like which also, the male appears to be fit for reproduction earlier than the female. But Audubon says, "That this tardiness is not the case in the wild state, I feel pretty confident; for I have observed having broods of their own many individuals, which, by their size, the dullness of their plumage, and such other marks as are known to the practical ornithologist, I judged to be not more than fifteen or sixteen months old. I have, therefore, thought that in this, as in many other species, a long series of years is necessary for counteracting the original wild and free nature which has been given them; and, indeed, it seems probable that our attempts to domesticate many species of wild fowls, which would prove useful to mankind, have often been abandoned in despair, when a few years more of



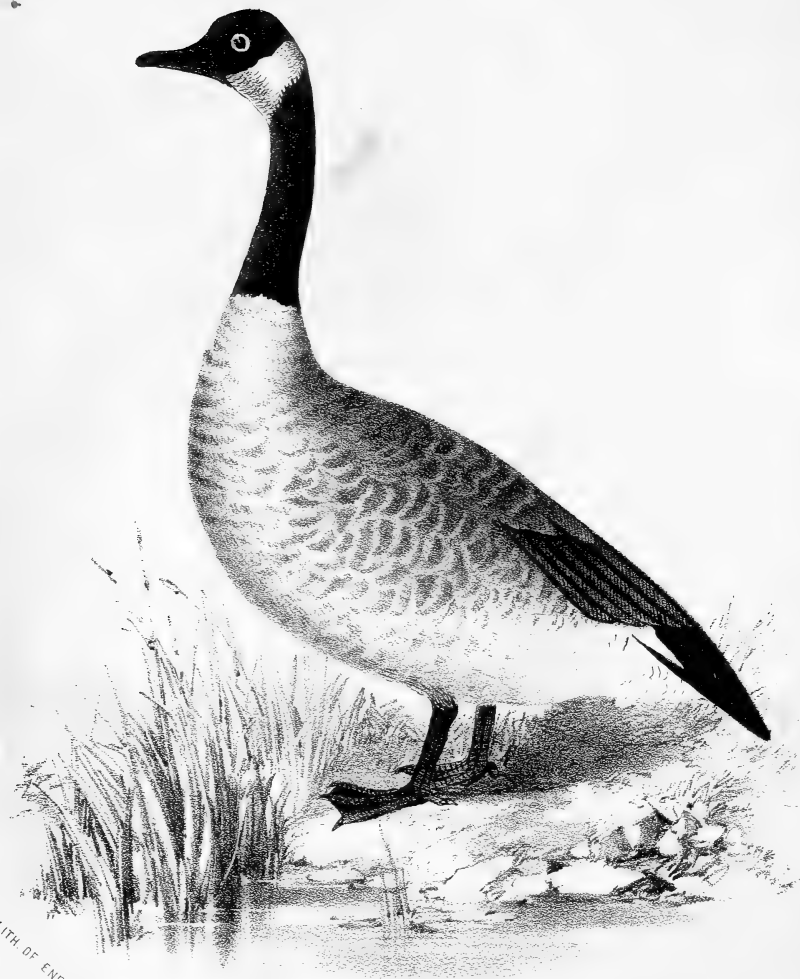

LITH. OF ENDICOTT & CO. N. Y.

WILD GOOSE.

constant care might have produced the desired effect."

The American wild goose is a beautiful bird. The head, two-thirds of the neck, the greater quills, the rump and tail, are jet black; the back and wings are brown, edged with lighter brown; the base of the neck anteriorly, and the under-plumage, generally brownish-gray; a few white feathers are scattered about the eye, and a white cravat, of a kidney-shape, forms a conspicuous mark on the throat; upper and under tail-coverts pure white; bill and feet black. The long and delicate neck of this bird gives it quite a snake-like appearance.

The American wild goose is universally known over the whole country, whose regular periodical migrations are the sure signal of returning spring or approaching winter. Late in autumn, especially when the wind is from the north, these wild geese are seen sailing high in the air, making their accustomed tour at that season. Impelled by nature, they quit their northern abode, and hazard an escape from the artifices of man sooner than perish amidst the icy barrens of the frozen regions. When migrating, many flocks unite and form a vast column, each band having its chosen leader.

The flight of the wild goose is heavy and laborious, generally in a straight line, or in two lines, approximating to a point, or rather in the form of two sides of a triangle; in both cases the van is led by an old gander, who every now and then pipes his well-known *honk, honk!* as if to ask how they come on, and the honk of "All's well!" is generally returned by some of the party. When bewildered in foggy weather, they appear sometimes to be in great distress, flying about in an irregular manner, making a great clamor. On these occasions, should they alight on the ground, as they sometimes do, they meet with speedy death and destruction.

The hoarse honking of the gander is so familiar to the inhabitants of our country, that it is impossible for them to arrive among us without making their visit known. All welcome their return. The once keen eye of the aged gunner again sparkles as he beholds their grand and lofty flight; the firelock is immediately brought into requisition, and then the prac-

ticed gunner looks upon them as debtors returned to cancel a long-standing obligation; he has watched their flight, and discovered their landing-place; his keen eye glances quickly over his trusty gun, and ere a moment elapses death is among them.

The autumnal flight lasts from the middle of August to the middle of November; the vernal flight from the middle of April to the middle of May.

Wilson says that, "except in calm weather, the flocks of American wild geese rarely sleep on the water, generally preferring to roost all night in the marshes. When the shallow bays are frozen, they seek the mouths of inlets near the sea, occasionally visiting the air or breathing-holes in the ice; but these bays are seldom so completely frozen as to prevent their feeding on the bars at the entrance."

Wounded geese have frequently been so far domesticated as to pair readily with our tame geese; but their progeny are mules, and will not breed. On the approach of spring, however, they discover symptoms of uneasiness, frequently looking up in the air and attempting to go off. Some, whose wings have been clipped, have traveled on foot in a northerly direction, and have been found at a distance of several miles from home. They hail every flock that passes overhead, and the salute is sure to be returned by the voyagers, who are only prevented from alighting by the presence and habitations of man. The gunners sometimes take one or two of these domesticated geese with them to those places over which the wild ones are accustomed to fly; concealing themselves, they wait for a flight, which is no sooner observed by the decoy geese, than they begin calling aloud until the flock approaches so near that the gunners are enabled to make great havoc among them with musket shot.

We once possessed a wild gander that had been slightly wounded in the wing, which mated with a tame gray goose, and we bred from them for more than ten years, but the produce were not fruitful, although they laid eggs. They never showed any disposition to pair or mate with either the wild or domestic goose. They seemed to consider themselves *exclusives*, and kept by

themselves—apparently rather aristocratic in their notions. The hybrids partook largely of the wild character and habits, and if their wings are not clipped spring and fall, they are very apt to fly away and not return. We have lost two pair in that way; one pair, after rising in the air and whirling about the premises for a short time, bent their course in a “bee-line” toward the river, and alighted about three miles below Albany, where they were supposed to be wild geese, and shot. The other two left in the latter part of winter, and after hovering about the neighborhood for two or three days, were seen to rise high in the air and direct their course toward the river, which was the last we ever heard of them. The old gander was finally shot in a small sheet of water near the house by one of those lawless loafers who encroach on our premises with impunity.

The young gander has a frequent disposition to neglect his own mate, and give himself up to unlicensed companionship. Mr. Dixon had one that deserted his partner, to her evident grief, and made most furious love to one of a flock of tame geese, separating her from the rest, not permitting any other water-fowl to swim near her, stretching out his neck stiffly on a level with the water, opening his red-lined throat to its utmost extent, hissing, sighing, trumpeting, winking his bright, black eyes, tossing his head madly, and all kinds of folly. Mr. Dixon did not choose to permit such conduct; but as often as he killed and roasted the object of his affections, the Canadian gander immediately selected another leman, invariably the ugliest of the surviving females. One short, squat, rough-feathered, ill-marked goose, with a thick bill and a gray top-knot, was his special favorite. When the Michaelmas murders had extirpated the whole race he so much admired, he returned reluctantly and coldly to his former love. The best remedy in such a case is to divorce them at once, and exchange one out of the pair for another bird.

A similar incident is related in the *American Agriculturist*, by Colonel Thayer, of Braintree, Massachusetts, in the following words: “A few years since, a neighbor of mine shot at a flock of wild geese while passing to the south, wound-

ed one in the wing, took it alive, and very soon domesticated him. He soon became very tame, and went with the other geese. I bought him, and kept him three years, and then mated him with an old native goose. They had several broods of young ones, and the old goose became very feeble, so much so that she could not sit long enough to hatch out her eggs. I accordingly put them under another goose, where they did very well. In the fall of the year I gave her away, and mated the wild gander with another. In the spring following, about six months after, I heard that the old goose had got better, and was in good health. She was brought home and put into my poultry-yard. The wild gander and his new mate were at a distance of about eighty rods, in another pasture. As soon as the old goose was put into the yard she made a loud noise, which the wild gander heard. He immediately left his new mate and came down to the yard, recognized his old mate, entered into close conversation, and appeared extremely happy in seeing her again. His other mate followed him, and wished to join the party; but he appeared much offended, treated her with the greatest indifference, and drove her from him.”

Wild geese are regarded by those who have kept them nearly as good and as profitable as the domestic goose, which they exceed in size, and especially in the quantity and quality of their feathers; even the half-bloods show a great superiority in that respect.

The facility with which the wild goose is tamed, while yet it retains a “trick of the old nature,” is well exemplified in a story related by Wilson, on the authority of a correspondent for whose veracity he vouches, which story, he observes, is paralleled by others of the same import: “Mr. Platt, a respectable farmer on Long Island, being out shooting in one of the bays, which in that part of the country abound with water-fowl, wounded a wild goose. Being wing-tipped and unable to fly, he caught it and brought it home alive. It proved to be a female, and, turning it into his yard with a flock of tame geese, it soon became quite tame and familiar, and in a little time its wounded wing entirely healed. In the following spring, when the wild

geese migrated to the northward, a flock passed over Mr. Platt's barn-yard, and just at that moment their leader happening to sound his bugle-note, our goose, in whom its new habits and enjoyments had not quite extinguished the love of liberty, remembering the well-known sound, spread its wings, moved in the air, joined the travelers, and soon disappeared.

"In the succeeding autumn the wild geese, as usual, returned from the northward in great numbers, to pass the winter in our bays and rivers. Mr. Platt happened to be standing in his yard when a flock passed directly over his barn. At that instant he observed three geese detach themselves from the rest, and, after wheeling round several times, alight in the middle of the yard. Imagine his surprise and pleasure when, by certain well-remembered signs, he recognizes in one of the three his long-lost fugitive. It was she, indeed! She had traveled many hundred miles to the lakes, had there hatched and reared her offspring, and had now returned with her little family to share with them the sweets of civilized life."

"The following account of a Canada goose is so very extraordinary," says Willoughby, "that I am aware it would with difficulty gain credit, were not a whole parish able to vouch for the truth of it. The Canada geese are not fond of a poultry-yard, but are rather of a rambling disposition. One of these birds, however, was observed to attach itself, in the strongest and most affectionate manner, to the house-dog, and would never quit the kennel except for the purpose of feeding, when it would return again immediately. It always sat by the dog, but never presumed to go into the kennel except in rainy weather. Whenever the dog barked the goose would cackle, and run out to the person she supposed the dog barked at, and try to bite him by the heels. Sometimes she would attempt to feed with the dog; but this the dog, who treated his faithful companion rather with indifference, would not permit. This bird would not go to roost with the others at night unless driven by main force, and when in the morning she was turned into the field, she would never stir from the yard-gate, but sit there the whole day in sight of the dog. At last, orders were

given that she should be no longer molested, but suffered to accompany him as she liked. Being thus left to herself, she ran about the yard with him all night; and, what is particularly extraordinary, and can be attested by the whole parish, whenever the dog went out of the yard and ran into the village, the goose always accompanied him, continuing to keep up with him by the assistance of her wings, and in this way of running and flying, follow him all over the parish. This extraordinary affection of the goose toward the dog, which continued to his death, two years after it was first observed, is supposed to have originated from his having accidentally saved her from a fox in the very moment of distress. While the dog was ill the goose never quit him day or night, not even to feed, and it was apprehended she would have been starved to death had not orders been given for a pan of corn to be set every day close to the kennel. At this time the goose generally sat in the kennel, and would not suffer any one to approach except the person who brought the dog's or her own food. The end of this faithful bird was melancholy; for when the dog died she would still keep possession of the kennel; and a new house-dog being introduced, which in size and color resembled the one lately lost, the poor goose was unhappily deceived, and going into the kennel as usual, the new inhabitant seized her by the throat and killed her."

The manner in which these birds are usually kept, in Europe as well as in this country, is neither consistent with their natural habits, nor calculated to develop their usefulness and merit. They are mostly retained as ornaments to large parks and inclosures, where there is an extensive range of grass and water; so far all is as it should be. But they are generally associated with other species of geese and water-fowls, all being of a sociable disposition, and forming one heterogeneous flock. In the breeding season they can neither agree among themselves to differ seriously, nor yet to live together in peace; the consequence is, that they interrupt each other's love-making, keep up a constant bickering, without coming to the decisive quarrels and battles that would set all to rights;

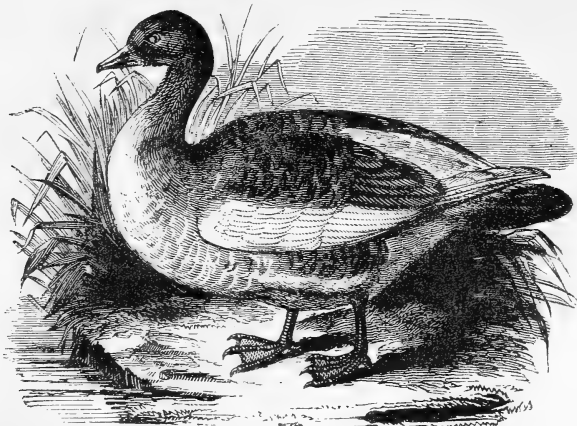

THE DOMESTIC, OR COMMON GOOSE.

and in the end, we have birds without mates, eggs unfertilized, and now and then a few monstrous hybrids, which, however much some curious persons may prize them, are as ugly as they are unnatural, and by no means recompense by their rarity for the absence of two or three broods of healthy legitimate goslings.

#### THE DOMESTIC, OR COMMON GOOSE.

The domestication of the goose, like that of the domestic fowl, is hidden in the remotest ages of antiquity. Among the Greeks and Romans it seems to have been the only really domesticated water-fowl they possessed; and appears to have held exactly the same place in their esteem that it still retains with us, after the lapse of two or three thousand years.

It is very natural to inquire whence so remarkable and valuable a bird was originally obtained; but the conclusion generally arrived at appears to be inconsistent not merely with truth, but even with probability; viz., that it results from the crossing and intermixture of several wild species. None of these ancient accounts indicate any such fact; but on the contrary, declare that the domestic goose was in the earliest ages exactly what it is now. The very same arguments that are used to show that the

domesticated goose is a triple alliance of the Gray-legged, the White-fronted, and the Bean goose, would equally prove that the Anglo-Saxon race of men is derived from a mixture of the red Indian, the yellow Chinese, and the tawny Moor.

According to popular opinion, the domestic goose is usually considered as having been derived from the "Grey-legged Goose," but such a circumstance is rendered highly improbable from the well-known fact that the common gander, after attaining a certain age, is invariably white.

The Grey-legged goose certainly approaches nearer to the domestic bird than any of the others above named; and if we are limited to any one of the wild birds of this genus, now known to us, in our inquiries for the probable ancestor, it is to this species that, in our opinion, the honor should be assigned. Mr. Yarrell, in his most valuable work on British birds, mentions the following instance in strong corroboration of this relationship:

"The Zoological Society of London, possessing a pinioned wild Grey-legged gander, which had never associated with either Bean goose, or White-fronted goose, though both were kept on the same water with him, a domestic goose,



selected in the London market from the circumstance of her exhibiting in her plumage the marks which belong to and distinguish the true Gray-legged species, was this season (1841) brought and put down to him. The pair were confined together for a few days, became immediately very good friends, and a sitting of eggs was the consequence.

"These were hatched, and have proved prolific. Some were hatched in the two following seasons, and some of their descendants still remain at the gardens. Eight young ones were hatched out from eleven eggs of the first cross, and seven young ones the next season from ten eggs; but from some cause the young geese derived from the first pair of birds do not now produce large broods; the number of eggs has been, in two instances, only six, and in three instances only five. Some farmers, who received specimens of these geese, declined keeping them as stock, because they produced such small broods—in some instances only four."

This reduction of the number of eggs seems to us consistent both with the infusion of the wild blood and the continued collateral alliances. But this falling off from the productiveness of the tame goose, we imagine would, after a time, be regained; and again, as in such cases an argument is often drawn against the probability of the Gray-leg being the stock from whence proceeded our domestic bird, from the reduced size of the young, it is sufficient to reply, that in many of those instances where this objection has been raised, proof is wholly wanting to show that the Gray-legged goose has been the wild parent; while, from the comparative scarcity of that bird, and the abundance in which the Bean goose may be obtained, the latter, we have every reason to believe, has often been the bird alluded to under the common name of the "Wild Goose."

If this be so, loss of size in such hybrids will be readily understood by any one conversant with the great difference in this respect between the two wild species.

The general tone of the plumage and the figure of the Gray-legged goose are closely repeated in many specimens of the gray domesticated bird; the variations that occur not passing be-

yond the limits that the control of man would probably occasion. Thus the pale color of the wild bird's legs and feet, which gives it its distinctive name, is changed to a brighter hue in the tame bird; but to account for such an alteration, it will hardly be considered necessary to refer to the introduction of the pink-footed race.

Mr. Selby, in his "Illustration of British Ornithology," thus expresses himself: "It is generally admitted that our race of domestic geese has originally sprung from this (the Gray-legged goose) species, and however altered they may now appear in bulk, color, or habits, the essential habits remain the same; no disinclination to breed with each other is evinced between them, and the offspring of wild and domesticated birds are as prolific as their mutual parents."

The common gray, white, or mottled goose, has hitherto, with but few exceptions, formed the general stock of this country; and from disregard to the degeneracy, occasioned by breeding in-and-in, inferior specimens have become far too common.

These causes, too, with neglect of proper attention when young, have in many instances so reduced their weight at maturity, that they fall short of a Brazilian drake, and a corresponding depreciation of the flesh, in both flavor and texture, is the consequent result.

The ganders are usually white, or with a preponderance of that color, while the geese have various shades of ash-gray, and a dull leaden-brown with it; a preference is often expressed for those that have no white whatever, excepting only on the lower part of the body.

All our domestic birds none are so profitable as geese, where there are facilities for keeping them; for there are none which can do so much for themselves when alive, and none that come to so little waste when dead. Unlike the fowl, all parts of the goose are equally good. Besides which, every feather is of value, greater than that of every other of our domestic birds. Every housewife knows how to appreciate bedding stuffed with their plumage; and in these days of steel pens, the goose still possesses quills. When young, or in the "green" state, as some

term it, the goose is a popular dish on the table of those who can afford it.

How is it, then, that the goose is not more popular with poultry-fanciers? It can only be accounted for by the fact, for fact it is, by reason of its not being in every one's power to keep them.

The chief requisites for goose-keeping are a pool of water and a pasture for grazing. The latter is essential, as the bird is graminivorous as well as granivorous. An occasional cabbage-leaf will form an acceptable variety of food; and during the winter any spare garden-stuff will help to supply the deficiencies of the pasture. If fed high, some varieties of geese will often lay in autumn, but the advantage of a brood of goslings in November is questionable.

"All men," says Markham, an ancient writer, "must understand that, except he have either pond or stream, he can never keep geese well." Yet if we are to believe M. Parmentier, the vicinity of rivers and ponds is not absolutely necessary to the most successful rearing of geese; for in districts destitute of these advantages, a small reservoir, where they can bathe, will be quite sufficient.

Columella advises to pasture geese in marshy or moist grounds, and to sow for them vetches or tares, clover, mellilot, and fenugreek, but more particularly chicory and lettuce, of which, he says, they are very fond.

"Grass," says Markham, "they must necessarily have, and the worst and that which is most useless is the best, as that which is moorish and unsavory for cattle."

In allowing geese to range at large, it is requisite to be aware that they are very destructive to all garden and farm crops as well as to young trees, and must, therefore, be carefully excluded from orchards and cultivated fields. It is usual to prevent them getting through the gaps in fences by hanging a stick or "yoke" across their breasts.

They are accused by some of poisoning the grass, and of rendering the spots where they feed offensive to other stock; but the secret of this is very simple. A horse bites closer than an ox, a sheep goes nearer to the ground than a horse; but after the sharpest shaving by sheep,

the goose will polish up the turf, and grow fat upon the remnants of others. Consequently, where geese are kept in great numbers on a small area, little will be left to maintain any other grass-eating creature. But if the commons are not short, it will not be found that other grazing animals object to feed either together with, or immediately after, a flock of geese.

Although water be the natural element of geese, yet it is a curious fact, that they feed much faster in situations remote from rivers or ponds. They should not be allowed to run at large when they are fattening, as they do not acquire flesh nearly so fast when allowed to take much exercise.

The domestic gander is polygamous, but he is not an indiscriminate libertine; he will rarely couple with females of any other species. Hybrid common geese are almost always produced by the union of a wild gander with a domestic goose. Three, or, at the very utmost, four geese, are as many as we should place with one gander; if the latter, indeed, were a young bird in his second or third year only, it would be prudent still farther to diminish the number. But the older the stock-birds, the better the chances of success; for the eggs of a young goose, in her second year of existence, produce but few goslings, and these, as might be anticipated, are often delicate in rearing.

Two geese we consider sufficient for one gander, and it is generally admitted that more goslings are produced from such a proportion of the sexes than if more are kept with one gander. Many experienced breeders will, perhaps, differ from this opinion, but we would rather err with the smaller number than hazard the risk of unfertilized eggs. If we admit the probability of descent from the Gray-legged goose—a strictly monogamous bird—the produce of such limitation must be apparent. Occasionally, as happens with other poultry, an aversion will be shown by the gander to one or other of the geese placed with him; this dislike, from whatever cause proceeding, is usually permanent, and the rejected one should therefore be at once removed.

It was ascertained by St. Genis of France,

that geese will pair like pigeons and partridges; and in the course of his experiments he remarked, that if the number of the ganders exceed that of the geese by two, and even by three, including the common father, no disturbance or disputes occur, the pairing taking place without any noise, and no doubt by mutual choice. Besides the common father, he left two of the young ganders unprovided with female companions; but the couples which had paired kept constantly together, and the three single ganders did not, during temporary separations of the males and females, offer to approach the latter. He also remarked, that ganders are more commonly white than the females. M. Parmentier recommends the gander to be selected of a large size, of a fine white, with a lively eye, and an active gait; while the breeding-geese, he says, ought to be brown, ash-gray, or parti-colored, and to have a broad foot. The gray geese are supposed to produce the finest goslings, while the parti-colored ones produce better feathers, and are not apt to stray from home.

*Laying.*—When well fed the goose will begin to lay early in the spring, usually in March; sometimes earlier, as the weather is cold or mild. Some geese will lay, twice or three times in the year, from five to twelve eggs each time, and some more—that is, when left to their own way; but if the eggs are carefully removed as soon as laid, a goose may be made, by abundant feeding, to lay from twenty to fifty eggs without intermitting.

This refers to the old birds, since young geese in their second year are seldom to be relied on. A few eggs are constantly laid; but neither can we trust to their proving productive, nor to the bird itself as likely to properly fulfill the duties of incubation; our remarks, therefore, are now limited to the older birds, which, indeed, are not generally considered trustworthy as sitters until their third or fourth year, and even long after that age do they continue to improve in their discharge of this important office. From twelve to fifteen is the number usually laid before the goose desires to sit; but so much depends on weather and food, that variations in this respect are of constant occur-

rence. The usual time of laying is night, but we have had them deposited at all hours of the day. The eggs are produced on alternate days, and sometimes on two consecutive days, with a cessation on the third. The fecundity of some geese, however, is wonderful; instances are said to have occurred of a goose laying upward of one hundred eggs within the year. A Mr. Holmes, of Maine, had a goose in his possession which, within the year, laid seventy eggs; twenty-six at the usual time of incubation, from which she hatched and brought up seventeen fine goslings. She began to lay again at the end of harvest, and continued to lay every other day to the end of the year, and remained in high condition.

The best locality adapted for the goose-keeper is a wide range; for where water and grass are plenty we need go no farther. Water of such size and depth as will permit at least a daily "paddle," is essential for stock birds; for here they resort as soon as the door of the place of their night's rest is opened, and here and then ensues the intercourse from which an increase to their numbers may be looked for, the presence of water appearing essential to the fertility of the eggs. A rapid running river has few attractions for the goose-keeper, since his birds are too often induced to extend their excursions to perilous distances, and the hazards before enumerated are proportionally increased.

The goose-house is too often thought sufficiently provided for when some old out-house, hardly secure against the predatory rambles of the fox, and affording easy ingress to rats and other vermin, is appropriated. But as we have seen that the value of breeding turns so greatly on age, it would surely be worth while to take efficient means to guard against such risks. The rat, it is true, would hardly be considered as a dangerous foe to the grown birds; but goslings have peculiar attractions for it; and by night the chances of a successful inroad are great in spite of the resistance of the old birds in defense of their young. But weasels, skunks, and others of the destructive family, will effect an entrance by apertures which admit the former animal; and from these, small as some of

them are, even the older members of the flock are not secure.

For a gander and his three or four partners there should be an allowance of room not less than eight feet in length, by six in width; the height need not be more than is sufficient for the person who cleans it to stand upright; and beneath the eaves an open space should be left, securing perfect ventilation, while it prevents the rain from driving in during windy weather. Barred windows at the side would permit a more thorough access of air in summer; and the floor can not be made of any better material than gravel well rammed down. But if it is necessary to employ stone for this purpose, care should be taken that the surface should be smooth, since full-grown geese, from the bulk to be sustained on their wide-spreading feet, are easily injured by a rough floor, and lameness may often thus ensue. For the young goslings dry floors are necessary; as the bath, which with the older birds so generally precedes the retiring to their night's rest, would soon convert an earth floor into a mass of mud. Where these precautions have been taken, a little straw shaken down, and renewed every other day, will secure a most comfortable abode.

But other lodgings must be provided for the goose and her brood, as likewise for the young birds when they have left their mother, and are in a course of feeding.

In the former case nothing is better than a well-ventilated, secure compartment, about three feet square, in which, by timely arrangement, it may be so managed that the goose shall commence laying; but if the ordinary indications of that season have not been taken advantage of, and the first egg should be laid in the ordinary house, it is better to allow her to remain there than incur the risk of rendering her unsteady in the nest by removals. We would, however, advise transferring her to her proper abode when the goslings are ushered into life. It is not from any misapprehension of the gander's disturbing her on the nest that it is advisable to allow her this separate apartment, for that rarely happens; and usually, indeed, he performs the part of a vigilant guard while his consort is engaged in incubation; but when

hatching-time comes round, his own anxiety to protect his offspring brings him and the other geese, who share this feeling, into dangerous proximity with the brood; and thus, not unfrequently, are the latter overwhelmed with kindness.

A separate house has also been suggested for the goslings when they have ceased to be under maternal superintendence. Natural affection, indeed, does not then usually cease with the parents, but food of a better quality is required to push them on; and this they may just as well have by themselves.

*Care of the Goslings.*—The head of a gosling protruding from beneath the mother's wings, on or about the thirtieth day, induces greater watchfulness on the part of the attendant; but interference is seldom required, since the young birds are stronger in freeing themselves from the shell than any other kind of poultry. This is indeed fortunate; for however gentle in her previous demeanor, the goose now declares herself the most uncompromising opponent of all who approach the nest, including even those of her own race who have long been her companions. Hence the great advantage of the separate hatching-pen, previously recommended. "I never interfere with their hatching till the last moment," says a writer in the "Poultry Book," "for their bill is very severe; and on one occasion my poultry-woman nearly lost the tip of her finger from such an attack." Meddling with them, indeed, except only when there is urgent apparent necessity from the weakness of the young, or the want of caution of the parent, would be more likely to do harm than good, no less to the brood than to the operator, for the goose not only becomes at that period a savage opponent, but is so heavy and powerful a bird, that lifting her from her nest is not easily accomplished without such struggles as throw eggs and goslings in utter confusion.

On the first day after the goslings are hatched they may be let out, if the weather be warm, care being taken not to let them be exposed to the unshaded heat of the sun, which might kill them. The food given them is prepared with some barley or Indian meal, coarsely ground, bran, and raspings of bread, which are still bet-

ter if soaked and boiled in milk, or lettuce leaves and crusts of bread boiled in milk. On the second day a fresh-cut turf is placed before them, and its fine blades of grass or clover are the first objects which seem to tempt their appetites. A little boiled hominy and rice, with bread crumbs, form their food for the first few days; fresh water in a shallow vessel, which they can dabble in and out without difficulty, being duly provided. Afterward advantage must be taken of a fine warm sun to turn them out on grass for a few hours; but if cold and damp, they should remain in their house, in which every attention should be paid to cleanliness by a constant supply of clean straw. After two weeks we cease these special precautions against exposure to the weather, and find them perfectly able to shift for themselves, in company with their mothers and the others of their race. For some weeks, however, extra supplies of food, such as bran or corn meal mixed with boiled or steamed vegetables, may be given them twice a day, morning and evening, continuing to give them this food till the wings begin to cross on the back, and after this green food, which may be mixed with it, such as lettuce, cabbage, beet leaves, and such like. The pond is strictly forbidden them under all circumstances for the first two weeks, and in severe weather for a longer period. Exposure to heavy rain out of doors, and a damp floor in the house where they are placed at night, are the main hazards to be avoided.

*Fatting.*—With geese and ducks the principle should be to feed well from the earliest period; and the quality, no less than the quantity, of their flesh will be found to reward the outlay. When put up to feed, an airy out-house, of such dimensions as may be suitable to the number of its intended inmates, is the first requisite; and the process of fatting, we should observe, is more readily accomplished when some ten or a dozen are shut up together, than in the case of two or three only being thus doomed to captivity. The goose is essentially a gregarious bird; and separation from the remainder of the flock with which it has been accustomed to associate, is apt to induce sulkiness and partial rejection of food, which rarely happens when companions

are present in sufficient numbers. On this account it is desirable to have the feeding-house at some distance from the run of those birds which are still at large.

Like other fowls, geese may be brought by proper management to a great degree of fatness; but the period at which they are the fattest must be chosen to kill them, otherwise they will rapidly become lean again, and many of them would die.

Geese may be fattened at two different periods of their lives; in the young state, when they are termed "green geese," and after they have attained their full growth. The methods at each period are very nearly the same.

A good diet for the first two weeks is formed of oats and water mixed in a trough; after this the food is gradually changed to barley-meal mixed with water, of the same crumbling consistence that has been recommended for the goslings, the water being given separately in small quantities. Steamed potatoes, mashed up with four quarts of buckwheat or oats, ground, to the bushel, and given warm, is an excellent diet, and will render geese cooped in a dark, quiet place, fat enough in three weeks.

When there are not many geese to fatten, they may be put into a cask with holes bored in it, through which they may thrust their heads to feed; and being naturally voracious, the love of food is greater than the love of liberty, and they fatten rapidly. The food consists of a paste, made of buckwheat, barley, or Indian meal, with milk and boiled potatoes.

In Belgium a lean goose is confined in a small coop made of fir, narrow enough to prevent it from turning, while there is a place behind for passing the dung, and another in front to let out the head. Water is supplied in a trough in front, having some bits of charcoal in it to sweeten it. A bushel of Indian corn is considered enough food for a month. It is soaked in water the day before it is used; and the goose is crammed morning and evening, while it is allowed during the day to eat and drink as much as it chooses. In a month it is seized with difficulty of breathing, and a lump of fat under each wing indicates that it is time

to kill it, lest it should be choaked with fat and die.

In some places on the Continent they nail their feet to a board, burn out their eyes with a hot iron, and keep them before a fire, allowing them, however, as much water as they choose to drink; but these barbarous practices are now seldom resorted to.

M. Viele, of France, found, by experiment, that geese fattened without cramming can not be brought to weigh above 12 or 13 pounds, while by cramming they can be made to weigh at least a third more.

It is stated in the *Farmer's Gazette* that geese can be raised, in a proper situation, at a profit far greater than almost any other stock. But to do this, more attention is required than is usually bestowed on their keeping and management.

The profit to be derived from geese feathers is not any where to be neglected; it is an important article, and always commands a fair price. An acquaintance of the author, who is very particular in keeping the feathers clean, finds a ready market at from 50 to 60 cents per pound. A goose will yield from 15 to 17 ounces in a season. Bremen or Embden geese are larger than the common geese, are always white, and yield on an average from one to three ounces more feathers, and of a better quality (having more down attached to them) than those of the common brown goose.

A writer in the *Maine Farmer* says: "I once knew a couple of industrious sisters who lived near a never-failing brook or stream in Massachusetts, who kept generally through the winter thirty geese, male and female. They had erected some suitable but not costly sheds, in which they had apartments for them to lay, sit, and hatch. Their food in the winter was meal of various kinds to some extent, but principally apples and roots. In summer they had a pasture inclosed with a stone wall or broad fence, which embraced the water. They kept their wings so clipped that they could not fly over such a fence. They well knew, what we all know, that live geese feathers are a cash article at a fair price. They picked off their feathers three times in the season. Those thirty geese

wintered, would raise seventy-five goslings, or young geese, and of course they had that number to dispose of every fall or beginning of winter, when they are sent to market, and again picked, making four times they obtained feathers from those they wintered, and twice from the young ones that they had killed."

Of all the stock brought up on farms, the goose lives to the greatest age, and is noted for its longevity; there are records of some attaining to a century or more. Twenty and thirty years are common periods through which its life may be traced; but more than twice the latter space has been well proved to have passed over its head, without the least diminution of its value for the purpose of breeding.

In 1824 there was a goose living in the possession of a Mr. Hewison (England), which was then upward of one hundred years old. It had been always in the constant possession of Mr. H.'s forefathers and himself; and on quitting his farm he would not suffer it to be sold with the rest of the stock, but made a present of it to the incoming tenant, that the venerable fowl might terminate its career on the spot where its useful and long life had been thus far spent.

There was also a goose on a farm in Scotland of the clearly ascertained age of eighty-one years, still healthy and vigorous; she was killed while sitting on her eggs by a sow. It was supposed she might still have lived many years, and her fecundity appeared to be permanent. Other geese have proved fertile at seventy years.

"A farmer near this place," says Mr. Sayers, writing from Clanville House, near Andover, England, "tells me that he has a goose now twenty-three years old, and that she has never hitherto failed in hatching out two good broods every year; her second hatch this very season (1853) was ten, of which all are alive."

The following goose story was related by Rev. C. Atwater in an English publication:

"At the farm mills of Taberakeena, near Clonmel, Ireland, while in the possession of the late Mrs. Newbold, there was a goose, which by some accident was left solitary without a male or offspring, gander or gosling.



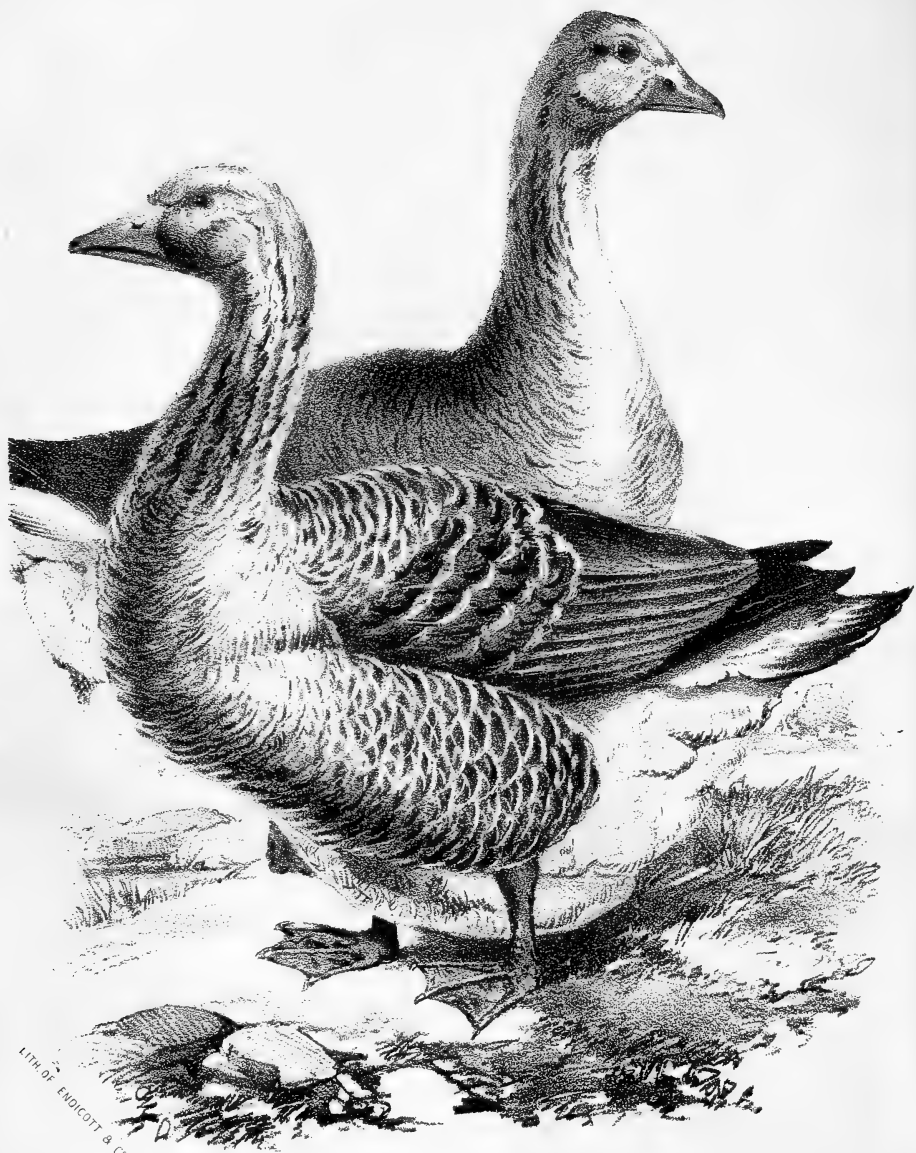

LITH. OF EMBERTON & CO. N.Y.

TOULOUSE GESE.



"Now it so happened, as is common, that the miller's wife had set a number of duck's eggs under a hen, which in due time were incubated; and, of course, the ducklings, as soon as they came forth, ran with natural instinct to the water, and the hen, as may well be supposed, was in a sad pucker, her maternity urging her to follow the brood, and her selfishness disposing her to keep on dry land. In the mean while, up sailed the goose, and with a noisy gabble, which certainly (being interpreted) meant leave them in my care, she swam up and down with the ducklings; and when they were tired with their aquatic excursion, she consigned them to the care of the hen. The next morning down came again the ducklings to the pond, and there was the goose waiting for them, and there stood the hen in her great frustration. On this occasion we were not at all sure that the goose invited the hen, observing her maternal trouble; but it is a fact that she being near, the hen jumped upon her back, and there sat, the ducklings swimming, and the goose and hen after them, up and down the pond. And this was not a solitary event. Day after day the hen was seen on the back of the goose, attending the ducklings up and down, in perfect contentedness and good-humor, numbers of people coming to witness the circumstance, which continued until the ducklings, coming to the days of discretion, required no longer the joint guardianship of the goose and hen."

#### THE TOULOUSE GOOSE.

The Toulouse Goose, as its name indicates, originated in France, and is distinguished from the dark-gray variety of the common goose, which it much resembles, not only by its greater size, but also by its colors being darker and more intense, by the bright-orange hue of the bill, legs, and the orbit around the eye, as also by the singularly early development of the abdominal pouch. The orbit itself is also much larger, and the head more depressed. The last characteristic, the unusual proportions of the abdominal pouch, is abundantly displayed in the same excess as is sometimes seen in the dew-lap of some breeds of cattle; and this occurs at a short period after they have emerged

from the shell. The goslings will begin to assume this ordinary feature of mature birds when not ten days old; and at three months it will be seen almost touching the ground.

Some of the earliest birds of this breed were imported into England by the late Earl of Derby, from the south of France—probably from Marseilles. Like the Embden variety, they attain great size, and by the continuous retention of certain fixed colors in their plumage, with some other peculiarities, they would seem to be equally entitled to the separate position of a "sub-variety."

Dixon says: "The Toulouse goose, which has been so much extolled and sold at such high prices, is only the common domestic, enlarged by early hatching, very liberal feeding during youth, fine climate, and perhaps *by age*. I am in possession of geese, hatched at a season when it was difficult to supply them with abundance of nourishing green food, that are as much undersized as the Toulouse goose is oversized; they are all domestic geese, nevertheless. It is for the sake of enlarging their growth, not for the mere purpose of supporting their strength, that the breeders cram them night and morning with flour-and-egg pellets. Grass alone would suffice for their sustenance, but extra nourishment makes extra-sized birds."

The weight attained by the Toulouse goose is said to be enormous; and in a good locality, and under good management, must insure an admirable return for food consumed and the other expenses of their keep. To these merits we may add another recommendation, in the fact that, "even when fed to the greatest weights, they never become disgustingly fat, as too often happens with the common goose."

It is very essential to farmers to procure good and pure-bred stock in their poultry-yards, that although the difference between a flock of ordinary geese and of Embden birds may not be great, except in color, it is still advisable the Embden or Toulouse should be preferred as being *distinct* breeds, and therefore, by attention to the renovation of the stock, not likely to deteriorate.

The following is a description of a gander of this breed: "Head depressed, and of a more

elongated form than in the common goose; bill three inches in length, by two inches in depth at the base; in color a clear orange-vermilion, the nail at its extremity being white, irides dark brown; orbit large, and of the same color as the bill. The plumage of head and neck ash-gray, the latter showing 'the curl' in a very marked manner. Throat a light tint of gray; breast, back, and thighs dark grayish-brown, with a margin of white, more or less distinct, on each feather. Greater wing-coverts brown; lesser wing-coverts a light gray. Primary wing-feathers, of which the second is the longest, ash-gray, becoming very dark rich brown at their extremities, the shaft being a clear white; secondaries and tertials dark leaden-brown; scapulars the same, with a narrow light edge. Under part of the body white; tail-coverts white; tail-feathers brown, with broad white band at the extremity. Legs and feet reddish-yellow; claws dusky. The wings, when folded, about half an inch shorter than the tail.

"The orbit, in both its form and color, the general tone of plumage, the color of the bill and legs, the particular light marking of the lesser wing-coverts, and the wings, which fall short of the tail, are points of resemblance between the Toulouse and the Gray-leg goose."

It has already been said that geese are much given to grazing, but we have not said that they improve the pasture. This is the case, although there is an old misquoted proverb to the effect that "nothing *will* eat after a goose," whereas the auxiliary verb should be *can* and not *will*. The fact is, the goose will thrive on pasture so short that a goat would starve on it; and the consequence is a short sweet herbage.

In the event of any one being induced by our account to keep geese, let us recommend him not to begin with young birds. They are not to be depended upon for breeding until the third year, and do not attain their perfection for a year or two subsequent to that age. When once in their prime they never retrograde, so that, barring accidents, a person possessed of a gander and three or four geese (no way related to each other, and in their prime of days), may consider himself set up in the anserine for life.

#### THE EMBDEN OR BREMEN GOOSE.

To Colonel Samuel Jaques, of Ten Hills Farm, near Boston, are we indebted for the first introduction of this very valuable and useful variety of water-fowl. They are originally from Holland, and the appellation of Embden has been obtained from the town of that name in Hanover. Beyond their great size, and the uniform clear white of their plumage, we are at a loss for any sign of a specific difference between these and the common goose. In figure they are alike, and the bill and legs are of the same brick-dust hue; the permanency of these advantages, however (that we have just alluded to), may justify our speaking of them as a sub-variety.

One of their great advantages is this—that all the feathers being perfectly white, their value, where many are kept, is far greater in the market than is ever the case with "mixed" feathers. In weight, too, these birds have great advantage over the common goose. All white poultry, again, are considered to "dress"—that is, to pluck, of a clearer and better appearance than colored birds.

The quality of the flesh of the Embden geese is equal in flavor to the famous Toulouse of France. The Embden is the earliest layer, and frequently rears two broods in one season, the young ones proving as hardy as any other. The Embden goose has prominent blue eyes, is remarkably strong in the neck, and the feathers, from near the shoulder to the head, are far more curled than is generally seen in other birds.

The quiet domestic character of the Embden geese causes them to lay on flesh rapidly; they never stray from their home, the nearest pond and field satisfying their wants, and much of their time is spent in a state of quiet repose.

The following account of the first importation of these birds, was communicated by S. Jaques, Jun., to the editor of "Dixon's Ornamental Poultry," in 1850. He says: "In the winter of 1820, a gentleman, a stranger, made a brief call at my father's house; and, in conversation, casually mentioned that, during his travels in the interior of Germany, he had noticed a pure

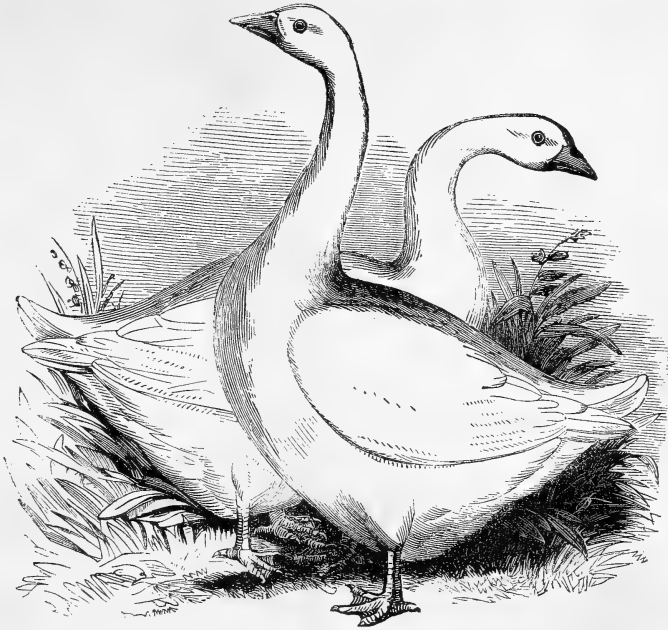

EMBDEN OR BREMEN GEESSE.

white breed of geese of unusual size, whose weight, he supposed, would not much fall short of twenty-five pounds each, providing they were well-fed and managed. At that period a friend of my father's—the late Eben Rollins, of Boston—kept a correspondence with the house of Dallas and Co., in Bremen; and, at his request, Mr. Rollins ordered, through that firm and on my father's account, two ganders and four geese of the breed mentioned by the stranger gentleman. The geese arrived to order in Boston, in the month of October, 1821.

“Having had the breed in question sent him from Bremen, my father named them after that place; but English writers call this variety the ‘Embden geese.’ It will be seen from what I have stated above, that my father was the *original importer* of this description, and therefore is entitled to the credit of first introducing it to

the United States. It is certain that he had the Bremen geese in his possession at least five years prior to the time when Mr. James Sisson, of Rhode Island, imported his.

“Ever since my father imported the Bremen geese he has kept them pure, and bred them so to a feather—no single instance having occurred in which the slightest deterioration of character could be observed. Invariably the produce has been of the purest white—the bill, legs, and feet of a beautiful yellow. No solitary mark or spot has crept out on the plumage of any one specimen, to shame the true distinction they deserve of being a pure breed: like, with them, always has produced like.

“The original stock has never been out of my father's possession; nor has he ever crossed it with any other kind since it was imported in 1821.

"I find, by reference to my father's notes, that, in 1826, and in order to mark his property indelibly, he took one of his favorite imported geese, and, with the instrument used for cutting gun-waddings, made a hole through the web of the left foot. This was done on the 26th of June; and now, in 1850, the same goose, with the perforation in her foot, is running about in his poultry-yard, in as fine health and vigor as any of her progeny. She has never failed to lay from twelve to sixteen eggs every year, for the last twenty-seven years, and has always been an excellent breeder and nurse, as has all of the stock and offspring connected with her. I had the curiosity to weigh one of her brood of 1849, when nine months old exactly, and his weight, in feather, sent up 22 pounds in the opposite scale.

"In 1832 a bull-dog killed several of my father's geese, and among them the two ganders originally imported. For the last eighteen years he has bred by his young ganders—putting them indiscriminately to parents and sisters—and reserving the best of the produce, male and female, for breeding. In so doing, he has never experienced any deterioration in weight, feather, or stamina, as has been exemplified in the above-mentioned instance of the nine-months' old gander, so produced, and whose food was almost exclusively grass.

"As quality of flesh, combined with weight, is a main consideration, I wish to mention, regarding the former, that the flesh of the Bremen (Embden) goose is very different from that of any of our domestic varieties. It does not partake of that dry character which belongs to the other and more common kinds, but is as tender and juicy as the flesh of a wild fowl; besides, it shrinks less in the process of cooking than that of any other fowl. Some of the keenest epicures have declared that the flesh of the Bremen (Embden) goose is equal, if not superior, to that of the Canvas-back duck.(?) There is assuredly some comfort, not uncombined with ease, in carving a bird that weighs seventeen pounds, and taking a slice from the breast so long as to be obliged to cut it in two that one-half may cover no more than the width of a common dinner-plate.

"The Embden goose inclines to commence laying at an earlier period than this northern latitude favors, which is in the latter part of February. To give the young fair play, it is advisable that hatching should be finished before the first of June. The mode of prevention used by my father is as follows:

"The whole of the breeding stock, male and female, are put into a dark room—say about the 20th of February—and kept there until about the 10th day of April. When in duration they are well fed once a day with corn, and allowed sufficient water all along to drink. Once a week they are allowed to get out for one hour to wash and plume themselves, and are then shut up again. While thus confined, they lose the inclination to breed, and do not assume it while they are kept shut up; but in eight or ten days after they are set at liberty the disposition returns, and they commence laying.

"The mode adopted by my father to bring the broods of goslings forth in one day is as under, and has been followed by him for many years with unvarying results. In 1840 he had four ganders and ten geese for breeding purposes. At that time he had as many as thirty milk-cows in one stable, the large door of which opened upon the farm lane. Directly in front of this door he had boxes, or nests, in which the geese laid their eggs. These boxes I will describe in course. The man who had charge of the cows had also the care of the geese, and he worked by the following instructions: First, the geese were to be carefully and properly fed. Secondly, the eggs were to be removed in the most gentle manner every day from the nests, and placed in a basket of cotton, which was kept in a moderate temperature and free from damp. When all the geese had begun to sit steadily, each was furnished with a nest composed of chopped straw, and care was taken that the nest was sufficiently capacious. The eggs were then set, and the geese allowed to sit upon them.

"Strict attention was enjoined on the attendant not to allow more than one of the geese to leave her eggs at a time. As soon as one leaves the nest she makes a cackling noise, which was to be the signal for the man in attendance to

go and shut up the boxes in which the remainder were sitting; consequently, when the goose returned, she found only her own box open. Soon as she had entered, the whole of the doors were again opened, and the same rule observed throughout the period of hatching. In following this style of management, every goose was kept to its own nest. There were one hundred and twenty eggs set altogether, twelve to each of the breeding-geese before alluded to; and at the end of four weeks—which is the usual period of incubation—there were eighty-eight goslings, produced all in one day, and they formed a beautiful sight.

“When first hatched, the goslings are of a very delicate and tender constitution. My father’s general practice is, to let them remain in the box in which they were hatched for twenty-four hours after they leave the shell; but he regulates this by the weather, which, if fair and warm, may tolerate the letting the goslings out an hour or two in the middle of the day, when they may wet their little bills, and nibble at the grass. They ought not to be out in the rain at any time during the first month. A shallow pool dug in the yard, with a bucket or two of water thrown into it, to suit the temporary purpose of bathing, is sufficient during the period named.

“The practice of feeding my father follows is not to give the goslings any grain whatever, after they are four days old, until snow falls, when they require to be fed on corn for a time. He thinks, however, if well fed on grain from the time they were hatched, they might weigh from four to seven pounds more than by leaving them to grass-feeding alone.

“By feeding his geese until they are four days old, and then literally ‘sending them to grass,’ the weight of my father’s geese, at seven to eight months old, has averaged from 17 to 18 pounds each after the feathers have been cleanly picked off. He has no doubt that 25 pounds could be easily attained by a little attention to feeding with grain.

“The breeding-boxes before mentioned are made in the fashion something like a dog-kennel, with a roof pitched both ways. They are 30 inches long by 24 inches wide, and are 24

inches high. The door is in the end, and is covered by a sliding panel, which moves upward when egress or ingress is sought, and may be shut down at pleasure. For the first month the geese and goslings are all shut up in the boxes at night, in order to protect them against rain and vermin.”

We were always under the impression that Mr. James Sisson, of Warren, Rhode Island, was the first importer of these superior geese; but it appears incorrect from the following account of them, published in the *New England Farmer*: “In the fall of 1826,” says Mr. S., “I imported from Bremen (north of Germany) three full-blooded perfectly white geese. I have sold their progeny for three successive seasons; the first year at \$15 per pair, the two successive years at \$12. Their properties are peculiar: they lay in February; sit and hatch with more certainty than common geese; will weigh nearly, and, in some instances, quite twice the weight; have double the quantity of feathers; never fly; and are all of a beautiful snowy whiteness.”

#### ASIATIC OR INDIAN GEESE.

There appear to be three or four varieties which will come under this denomination, viz., the Hong Kong—by some writers called the African, Guinea, and Swan goose—the Brown Chinese, and the White Chinese goose. The Indian, Mountain, and Poland are probably hybrids or mongrels.

There is an old joke about a Spanish Don, who knocked at a cottage-door to ask a night’s lodging. “Who’s there? What do you want?” said the inmates. “Don Juan José Pedro Antonio Carlos Geronimo, etc., etc., wants to sleep here to-night.” “Get along with you!” was the reply; “how should we find room here for so many fellows?” The Chinese goose is in the same position as the Spanish Don. It has names enough, says Dixon, to fill a menagerie—China goose, Hong Kong goose, Knob goose, Swan goose, Asiatic goose, Guinea goose, Spanish goose, Poland goose, Muscovy goose, and the Lord only knows how many more.

Confusion, therefore, and perplexity are the certain lot of whosoever attempts to trace this

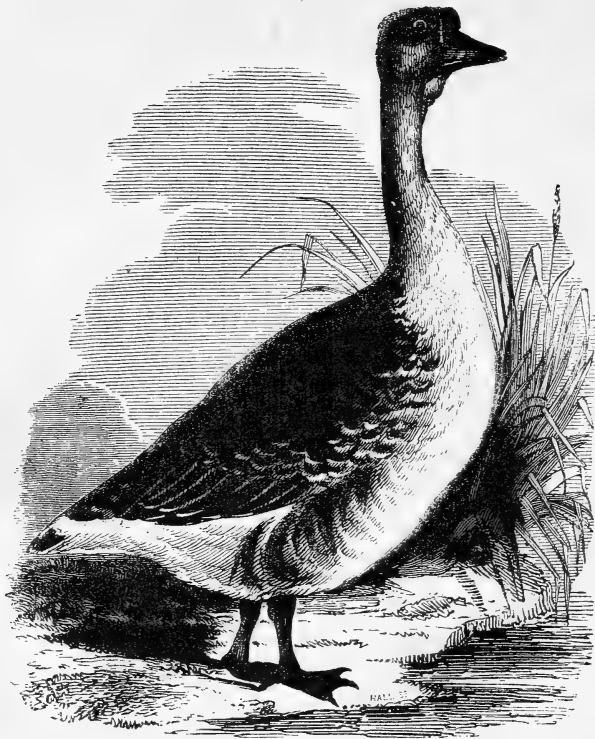

THE AFRICAN GOOSE.

bird in our books of natural history. Its place of birth has excluded it from all monographs or limited ornithologies. In very few systematic works is it mentioned at all, which is remarkable of a bird so striking in its appearance, which, there is every reason to believe, must have been domesticated for a long period. The uncertainty that has existed as to its correct name, and really native country, may be one cause of this. Like the Jews or the gipsies, it has not been allowed to claim a place among the natives of any one region; and, like many others furnished with a number of aliases, it ends by being altogether excluded from society.

The old writers call it the Guinea goose, for the excellent reason, as Willoughby hints, that in his time it was the fashion to apply the epithet "Guinea" to every thing of foreign and uncertain origin. Thus, what we at this day erroneously call the Muscovy duck, was then called the Guinea duck.

#### THE AFRICAN GOOSE.

This is the largest of the goose tribe which has fallen under our observation; it is of the size of the swan, and it often weighs more than twenty-five pounds. We once possessed a pair; the gander, in ordinary condition, weighed over

twenty-four pounds. They are noble-looking birds, quite ornamental about the premises, and add much to the scenery, particularly if a sheet of water be near. When floating on its surface they have a stately, majestic appearance, and in their dignified movements they certainly much resemble the swan. They have a deep, coarse, hollow voice, unlike that of any other variety.

The appellation of Swan goose, given by Willoughby to this large and beautiful bird, is very apt; but the Canada goose, which is at least as beautiful, has an equal right to the name; and, besides, all compound epithets ought to be banished from natural history.

"The Guinea goose," says Buffon, "exceeds all others in stature; its plumage is a brown-gray, and with a brown cast on the head and above the neck; it resembles, therefore, the wild goose in its colors; but its magnitude, and the prominent tubercle at the root of its bill, mark a small affinity to the swan; yet it differs from both by its inflated throat, which hangs down like a pouch or little dew-lap; a very evident character, which has procured to these birds the denomination *Jabotieres* (from *Jabot*, the crane). Africa, and perhaps the other Southern countries of the old continent, seem to be their native abode; and though Linnæus has termed them Siberian geese, they are not indigenous in Siberia, but have been carried thither and multiplied in a state of domestication, as in Sweden and Germany. Frisch relates that, having repeatedly shown to Russians geese of this kind which were reared in his court-yard, they all, without hesitation, called them Guinea geese, and not Russian or Siberian geese. Yet has the inaccurate denomination of Linnæus misled Brisson, who describes this goose under its true name of Guinea goose; and again, a second time, under that of Muscovy goose, without perceiving that his two descriptions refer precisely to the same bird."

"It is somewhat larger," says Brisson, "than the tame goose; the head and the top of the neck are brown, deeper on the upper side than on the under; . . . on the origin of the bill there rises a round and fleshy tubercle; . . . under the throat also there hangs a sort of fleshy membrane." Klien regards this goose

of Muscovy or Russia as a variety of the Siberian, which, we have seen, is the same with the Guinea goose. "I saw," says he, "a variety of the Siberian goose, its throat larger, its bill and legs black, with a black depressed tubercle." Not only does this goose, though a native of the hot countries, multiply when domesticated in the coldest climates, it also contracts an affinity with the common species; and the hybrids which are thus bred take the red bill and legs of our goose, but retain of their foreign parents the head, the neck, and the strong, hollow, yet loud voice. The clangor of these large geese is still more noisy than that of the ordinary kind, and they have many characteristics common; the same vigilance seems natural to them. "Nothing," says Frisch, "can stir in the house during the night but the Guinea goose will sound the alarm; and in the day time they give the same screams if any person or animal enters the court, and often will pursue, pecking the legs."

The bill, according to the remark of this naturalist, is armed at the edges with small indentings, and the tongue is beset with sharp papillæ; the bill is black, and the tubercle which rises upon it is vermilion. This bird carries its head high as it walks, and its fine carriage and great bulk give it a noble air. According to Frisch, the skin of the little dew-lap, or pouch, under the throat, is neither soft nor flexible, but firm and hard. This account, however, scarcely agrees with the use which Koblin tells us the sailors and soldiers at the Cape make of it. "These wild geese at the Cape have been called *Crop geese* (*oies Jabotieres*). The soldiers and common people of the colonies use their crops for tobacco-pouches; they will hold about two pounds."

Bewick has given an admirable wood-cut of this bird; but he has evidently selected the gander, which is taller and more erect than the female, though to both may be applied Willoughby's description: "A stately bird, walking with its head and neck decently erected." Bewick calls it the "Swan goose." The tubercle at the base of the bill, the usual length of neck, and its graceful carriage in the water, give it some claim to relationship with the aris-

tocracy of lake and river. Cuvier goes farther; calls it at once *Cygnus Sinensis* (Chinese Swan), and says that this and the Canada goose can not be separated from the true swan. A goose, however, it decidedly is, as is clear from its terrestrial habits, its powerful bill, its thorny tongue, and its diet of grass.

Another proof is their deficient power of flight compared with the rest of their congeners, owing to the larger proportionate size of their bodies. The common domestic goose flies much more strongly than her sister from Guinea. Indeed, of all geese, these are the worst fliers. There is no occasion to pinion them. While the Canada goose thinks little of a journey from the North Pole, or thereabouts, to Carolina; while the Egyptian goose pays an occasional visit from Africa to Europe; while the merry little Laughing goose, if tamed, and allowed the use of its wings, is almost as much at ease in the air as the pigeon; the African goose, to get out of the way of a frisky spaniel, can hardly manage to flutter across the lawn.

#### THE CHINESE GOOSE.

The Chinese Goose is not only brought from China, but from Guinea, the Cape of Good Hope, and Siberia; and it is also to be found in the Sandwich Islands.

Richardson describes three sub-varieties of this species. First, the *Hong Kong*. This bird has a large horny knob on the bill and forehead; its prevailing color is gray, with a longitudinal stripe of deep brown running down the back of the neck. The legs are of a red color, whence it is sometimes distinguished as the "Red-legged Chinese goose." This is the same long known among us under the erroneous name of the "Poland goose."

Second. *Black-legged Chinese Goose*. Also knobbed, and usually with a white edging round the knob, somewhat similar to that of the wild breed called the "White-fronted goose."

Third. The *White Chinese Goose*. A very beautiful and showy bird, of a snow-white color, knobbed as the others, and with legs of a bright orange red.

This beautiful bird, in its shape and motions

in the water, much resembles the swan. It again resembles the swan in other respects. She glides on the watery element with her neck beautifully arched, her head drawn in, her breast just settled in the water, her tail a little raised, giving a light and airy appearance, moving on the water with apparently little or no exertion; and we may say, with the poet,

"In all her movements dignity and grace."

Her note is loud and shrill, and she utters it often when an enemy appears. She is still more watchful than the African or Guinea goose. Nothing can stir about the premises at night but she sounds the alarm. This must have been the goose that is said to have saved the Capitol of Rome. It is delightful to see them, on a fine day in spring, lashing the water, diving, rolling over through mere fun, and playing all sorts of antics. Slight variations occur in the color of the feet and legs, some having them of a dull orange, others black; a delicate fringe of minute white feathers is occasionally seen at the base of the bill. These peculiarities are hereditary and transmitted, but do not amount to more than mere varieties.

The plumage of this goose is gray on the back, and darker—almost black—on the back side of the neck; front and under side of neck lighter, and tinged with a fawn color; wings and tail feathers dark, and under side of body light-gray. Feet, legs, and bill dark slate color. She resembles again the swan in having a knob or fleshy tubercle on the base of the bill, at which also a narrow white strip encircles the mouth.

The male is almost as much disproportionately larger than the female as the Muscovy drake is in comparison with his mate. He is much inclined to libertine wanderings, without, however, neglecting to pay proper attention at home. If there is another gander on the same premises they are sure to disagree; one of the two had better be got rid of. Both male and female are, perhaps, the most noisy of all geese. At night, as we have said before, the least footfall or motion in their neighborhood is sufficient to call forth their clanging and trumpeting. This to a lone country house is an advantage and a protection. Any fowl-stealer would be stunned



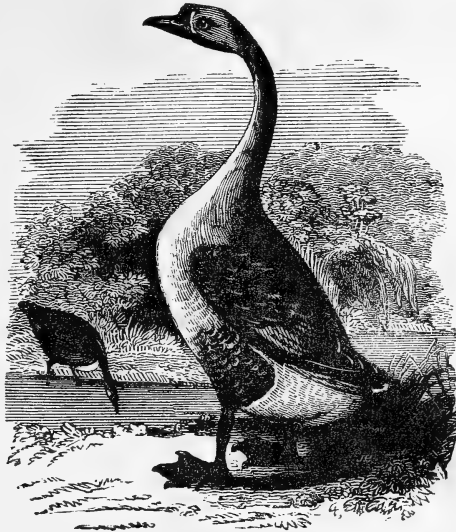

THE CHINESE GOOSE.

with their din before he captured them alive, and the family must be deaf indeed that could sleep on through the alarm thus given.

Though a native of a warm climate, this bird appears very well naturalized in this country; the only, or greatest objection to them is their early laying, which often occurs in the dead of winter. It will couple and breed with the common goose, but there would be no improvement on either side.

The Chinese geese are much smaller than the common goose; but what they lack in size they make up in prolificness. "They are valued in this country," says Main, "as they are in their own, for their early breeding and aptitude to fatten." They begin laying at the end of November, if the season be mild, and in January goslings are hatched; and, if kept in a dry, warm room, may be fit for the table in April or May.

The specimen from which our portrait was taken has been in our possession for many years. She was imported from China, and we obtained

her direct from the ship, and is the one before spoken of in a previous page. She once commenced laying in the month of November, and continued until she had produced over forty eggs.

Some beautiful specimens of this variety were brought out from China by Fletcher Webster, Esq., and taken to the Home Farm at Marshfield, some ten or twelve years ago. We also noticed some beautiful specimens exhibited at the Fair of our State Agricultural Society, held at Poughkeepsie a few years since, by Mr. Mazier, of Fishkill.

## THE WHITE CHINESE GOOSE.

This bird is infinitely more beautiful and attractive than its dusky relations. It is larger in size, not quite so erect in its carriage, and better merits the term "cygnoides"—swan-like—than any other member of the species. We first noticed the White Chinese goose, some twenty-five years ago, at the residence of the late Charles Henry Hall, at Harlem, who was a great

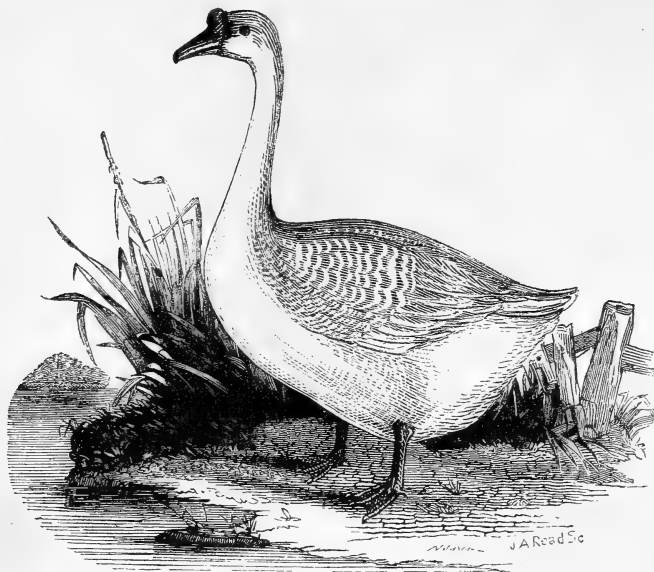

THE WHITE CHINESE GOOSE.

fancier of poultry, as well as all kinds of blooded stock, from the noble high-bred horse to a Bantam cock. It was brought into notice a few years ago in England by Mr. Alfred Whitkar, who speaks of it in the following words: "The White China goose is of a spotless, pure white, more swan-like than the brown variety, with a bright orange-colored bill, and a large orange-colored knob at its base. It is a particularly beautiful bird, either in or out of the water, its neck being long, slender, and gracefully arched when swimming. It breeds three or four times in a season, and its period of incubation extends to five weeks. They are prolific layers, but their eggs are small for the size of the bird, being not more than half the size of those of the common goose. The spring goslings are easily reared, and are a fair average quality for the table. The disparity in size between the sexes is considerable, often amounting to over one-third of their relative weights.

"Its color, as its name indicates, is a pure,

spotless white, which, contrasted with its yellow or orange-colored bill and legs, gives quite a pleasing effect, and it certainly deserves to rank in the first class of ornamental poultry."

These geese, it is stated, formerly existed in the aviaries of the London Zoological Society, and were there considered in the light of a variety of the *Anser cygnoides*; but the head-keeper of that establishment speaks most decidedly of his experience of the permanence, not only of this variety, but also of that of the dark-legged sorts of the brown kind, thus indicating three races; which, I repeat, would be considered as species, were they now discovered for the first time.

Mr. Dixon, in speaking of these birds, says: "They are larger than the brown Chinese geese, apparently more terrestrial in their habits; the knob on the head is not only of greater proportions, but of a different shape. If they were only what is commonly meant by a variety of the dark sort, it is a question whether the bill

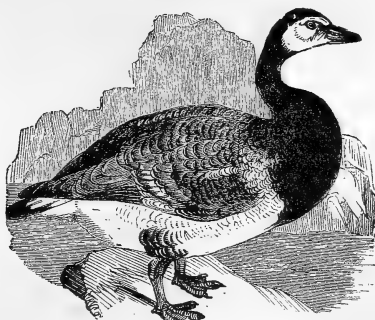

THE BARNACLE GOOSE.

would not retain its original jet black, whatever change occurred to the feet and legs, instead of assuming a brilliant orange hue. If the bird were an albino the bill would be flesh-colored, and the eyes would be pink, not blue."

Mr. Knight, of Frome, England, in whose possession they had been for three years, states that he has been unable to obtain any young from the eggs of the goose, but if he supplies her with eggs of the common goose, she invariably hatches and rears the goslings. Separate trials of each of the pair with the common goose and gander have been made by him unsuccessfully, although the white China goose lays four times in the year. Another gentleman, who also had a pair of the same lot from China, says, "I had one good brood from the young pair which I kept, but since that they have laid so badly that I have parted with the females, and kept a male bird, and now get very good broods. My friends, to whom I have given young birds from my pair, also complain. The geese sit remarkably well, never showing themselves out of the nest by day, but whether they may leave the nests too long in the cold of the night I can not tell. The time of incubation I consider to be about four weeks and three days. The young birds of the crossed breeds in appearance follow the mother, the common English goose, but they do remarkably well.

"In point of longevity they are said to be far from equaling the domestic goose. A cross of the China gander with our common goose

R

has been strongly recommended, as producing finer birds, and of much finer flavor. Hybrids between them and the common goose are prolific with the common goose, and the second and third cross is much prized, particularly for their ganders; and in many of the flocks the blood of the China goose may often be traced by the more erect gait of the birds, accompanied by a faint stripe down the back of the neck."

## THE BARNACLE GOOSE.

This bird is a native of the high northern latitudes of Europe, but during the winter seeks warmer quarters on the shores of Great Britain. They are shy and wary, and can only be approached by means of the most cautious manœuvres.

The Barnacle breeds in Iceland, Greenland, and the north of Russia, and of Asia. It is of handsome form, standing high on its limbs. The flesh is excellent, and they weigh about eight pounds a pair. The bill is small and black, with a reddish streak on each side; the cheeks and throat, with the exception of a black line from the eye to the beak, white; head, neck, and shoulders black; under plumage marbled with blue, gray, black, and white; tail black; under parts white; legs dusky. Although the Barnacle is so shy and cautious in a wild state, yet when brought under a state of domestication, it is as tame as any of the goose tribe. A pair of these geese were exhibited at the show in New York, by R. L. Colt, Esq., of

Paterson, New Jersey, and were the centre of attraction for the admiring multitude.

Of the origin of this bird most absurd tales have been told. All agree that it was produced from a tree, but the latest and most approved account was that of Gerard, who in 1636 wrote as follows: "But what our eyes have seen, and hands have touched, we shall declare. There is a small island in Lancashire called the Pile of Foulders, wherein are found broken pieces of old broken ships, some whereof have been cast thither by shipwrecks, and also the trunks and bodies with the branches of old and rotten trees, cast up there likewise, wherein is found certain spume or froth, that in time breedeth into certain shells, in shape like those of the muscle, but sharper pointed, and of a whitish color; one end whereof is fastened into the inside of the shell, even as the fish of oysters and muscles; the other end is made fast unto the belly of a rude mass or lump, which in time cometh to the shape and form of a bird. When it is perfectly formed the shell gapeth open, and the first thing that appeareth is the aforesaid lace or string; next come the legs of the bird hanging out, and as it groweth greater it openeth the shell by degrees, till at length it is all come forth and hangeth only by the bill; in short space after it cometh to full maturity, and falleth into the sea, where it gathereth feathers, and groweth to a fowl."

Dixon remarks as follows: "Several ornithological writers have lamented, with expressions of surprise, that so few of the larger water birds have been domesticated, and made to afford us a ready supply of food, in return for their board and lodging. But it should be remembered that there are two parties to the proposed arrangement—the master and the slave. If the captive resolutely persists in saying, 'You may bestow every care upon me, and lavish every comfort, but I *will not* be the parent of a race of slaves, although I may show a little personal thankfulness to yourself,' the move for us to make is to procure young that are ignorant of the fascinations of a wild life, and to endeavor to subdue, by kindness, *their* stubborn nature. If they remain indomitably independent, and refuse to yield, we are checkmated, and can

not proceed a step farther. It is not in *our* power to increase the number of domestic birds. 'The fear of you and the dread of you shall be upon every beast of the earth, and upon every fowl of the air, upon all that moveth upon the earth,' is a promise which will be undoubtedly fulfilled; and thus, as the dominion of man over the earth daily and hourly extends itself, those creatures that refuse to enter into his train will be crushed, and perish beneath his advancing footsteps; for 'unto your hand are they delivered. Every moving thing that liveth shall be meat for you; even the green herb have I given you.'

"The Barnacle goose is one of those species in which the impulse of reproduction has at length overcome the sullenness of captivity; and it is a curious fact, that instances of their breeding have of late increased in frequency, and we may therefore hope will go on increasing. The young so reared should be pinioned at the wrist as a precaution. The probability is, that they would stay at home contentedly, unpinioned, till hard weather came, when they would be tempted to leave their usual haunts in search of marshes, unfrozen springs, mud banks left by the tide, and the open sea, where they would be liable to be shot by sporting naturalists—a fate which has done more than any thing else to check the propagation of interesting birds in England—or might be induced to join a flock of wild birds, instead of returning to their former quarters.

"Broods of five, six, and seven Barnacle geese have been reared; not an inconsiderable increase if we only kept them to eat; but they have hitherto been chiefly valued as embellishments to our ponds. Their small size renders them suitable even for a very limited pleasure-ground, and they are perhaps the very prettiest geese that have yet appeared in our menageries. The lively combination of black, white, gray, and lavender, gives them the appearance of a party of ladies robed in those becoming half-mourning dresses that are worn from etiquette rather than sorrow. The female differs little from the male, being distinguished by voice and deportment more than by plumage. Their short bill, moderate-sized webs of their feet, and

rounded proportions, indicate an affinity to the Coreopsis. The number of eggs laid is six or seven, the time of incubation about a month, but it is difficult to name the exact period, from the uncertainty of knowing the precise hour when the process commences. The geese are steady sitters. The young are lively little creatures, running hither and thither, and tugging at the blades of grass. Their ground-color is of a dirty white. Their legs, feet, eyes, and short stump of a bill, are black. They have a gray spot on the crown of the head, gray patches on the back and wings, and a yellowish tinge about the fore part of the head. The old birds are very gentle in their disposition and habits, and are less noisy than most other geese. Water-ton mentions an instance where the gander paired with a Canada goose, a most disproportionately large mate for him to select. The same thing has occurred in Norfolk, but in this case the ludicrous union was altogether unproductive.

"The young of the Barnacle goose, like those of the Canada, when left entirely to the guidance of their parents in this country, are apt to be attacked by a sort of erysipelatos inflammation of the head, similar to that from which the domestic fowl suffers so much, and which proves equally fatal. The eyelids swell until the bird is blinded; its sufferings must be extreme, if it ever recover. The parts afflicted discharge copiously a watery fluid. Frequent washing with warm water and vinegar is the best remedy; and cramming the bird to keep it alive must be resorted to. Pills of rue-leaves, or a strong decoction of rue, as a tonic, have been administered with apparent benefit. The disease seems epidemic rather than contagious, though we would not quite deny that it is so; but of all remedies, warmth and dryness, particularly at night, are the most indispensable. Goslings hatched about mid-summer in the Arctic regions know not what it is to feel the absence of the sun. A Scandinavian summer's night, even in those latitudes where the sun does sink for an hour beneath the horizon, differs from the day in little else than stillness. There are no frosts succeeding a broiling day, no chilling dews which require hours of sunshine to remove, but

all is, for the time, perpetually bright, and warm, and genial. The difference between such a climate and an English May must be seriously felt by our tender little pets, whatever care we may take to protect them. This clear, uninterrupted day, two or three months long, of settled, delicious weather, gives a complete explanation of the apparent paradox that birds should retire to the regions, reported absolutely icy, of the north for breeding purposes. But those who have made the precincts of the Mediterranean their elysium on earth, can have no conception of the health, the vigor, the manly tone of mind and body to be inspired from hyperborean breezes."

#### THE BRANT GOOSE.

This and the Barnacle goose are the smallest of their tribe yet introduced to our aquatic aviaries; both being less in size than some ducks. The Brant is considered one of our most savory birds. In its transit from its breeding-places near the Arctic sea, it appears in great numbers on the coast of New York in the first and second week in October, and continues passing on to the south until December. Some few have been observed to remain all winter. They are again seen with us in April and May, on their way north, when they are in the best condition. They feed exclusively on *Zostera marina*, or eel grass, and other marine plants. The history of its migrations is not yet complete. On the Atlantic coast it has been observed from 73° to 38° north. On the Pacific, it appears to range from Columbia River, where it was seen by Mr. Townsend, to the 26th parallel. The Brant is capable of domestication, and Audubon states that it has been known to produce young in captivity, but when or where, or on what authority, is not stated. We are not advised of its ever having been bred in any British collection. We have been informed that several gentlemen on Long Island have attempted, and in some cases have succeeded in domesticating the Brant, which in its wild state is highly esteemed for the exquisite delicacy of its flesh. Domestication, however, does not appear to have improved it much, and its small size will scarcely render it, except for curiosity, an object of much

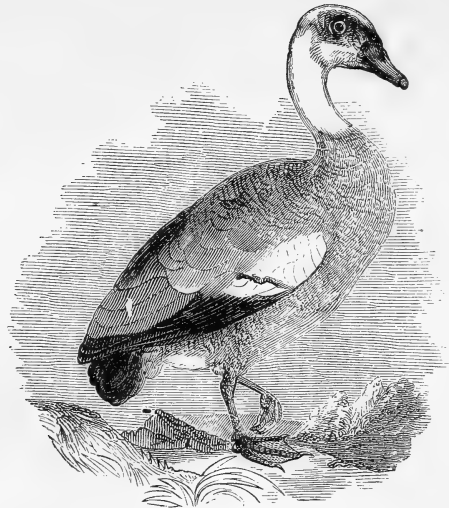

THE EGYPTIAN GOOSE.

attention, particularly in the vicinity of their haunts. To succeed in domestication, the most likely method would be, probably, to make an approach to their natural habits, by supplying them with occasional marine diet. It might also be expedient to assemble them in a flock instead of just keeping a single pair, so that they could consult their own individual choice of partners. Their picturesque effect, too, will be greater in this way. Their almost uniform color of leaden black, and their compactness of form, make them a striking feature in the scene, though they can not be compared in beauty with many other water-fowl. There is so little difference in the sexes it is not easy to distinguish them.

"Immense numbers of Brant geese," says Mr. St. John, "float with every tide into the bays formed by the bar. As the tide recedes, they land on the grass, and feed in close packed flocks. On the land, they are light, active birds, walking quickly, and with a graceful carriage. On any alarm, before rising, they run together as close as they can; thus affording a

good chance to the sportsman, who may be concealed near enough, of making his shot tell among their heads and necks."

#### THE EGYPTIAN GOOSE.

This bird belongs to a different genus from any other goose. Martin observes that it constitutes one of the links between the *Anatidae* and Galatores, or waders. Its size is less than the common goose, and it is chiefly kept on account of the beauty of its plumage and its singular habits. Its Greek name, *Chenolopez*, signifies fox-goose, indicative of its resemblance to the fox in cunning and vigilance.

The Egyptian goose is abundant along the banks of the Nile, and is distributed over the continent of Africa generally. It also visits the southern shores of Europe, and is not uncommonly seen in Sicily. According to Temminck it was this species which was held in veneration by the ancient Egyptians, and of which figures are frequently observed among the monumental remains of that extraordinary nation.

The ancients regarded the eggs of this species

as second in flavor only to those of the Pea-fowl. The Egyptian goose is often kept, because of its beauty, in a semi-domesticated state, on ornamental sheets of water, both in England and on the Continent, and in that condition it breeds freely; hence it happens that the young, when fledged, often take wing, and wandering about on rivers or lakes, are shot; a circumstance, as Mr. Gould observes, which occurs yearly.

The habits of this goose closely resemble those of the rest of the tribe. The bill is long, slender, nearly straight, and rounded at the tip; the upper mandible is slightly curved, and the nail hooked (see figure). The tarsi are elongated; the neck is long and slender; the general contour compact.

Mr. John Giles, of Woodstock, Connecticut, who has some of these geese, which he imported, says: "Among the truly ornamental, the Egyptian goose stands first. They are a part of the hieroglyphics of the Egyptians, a favorite article of food for the priests, and their eggs are considered of delicious flavor. They are hardy, and easy to raise; laying seldom over seven eggs at a time. Three broods can be brought off in one season, by setting their first and second laying of eggs under a hen. They are very pugnacious over their nest and young, and woe be to the intruder.

"The plumage of the Egyptian goose is most beautiful; the base of the bill and the space surrounding the eyes is a chestnut brown; cheeks, crown, chin, and throat yellowish white. The neck is yellowish brown, paler on the fore part, and on the back reddish-brown; the upper part of the back, the breast, and flank pale yellowish-brown, minutely waved with a darker tint; the centre of the breast and belly nearly white, with a dark patch (a horse-shoe) of chestnut brown, where the parts may be said to join; vent and under-tail coverts, buff orange; the lower back, rump, upper-tail coverts, and tail black; wings, as far as the greater coverts, pure white, the latter having a deep black bar near their tips; the wing-feathers or tertials, chestnut-red, with grayish-brown color on the inner webs; secondaries, black at the tips, and with the outer webs a brilliant varying green.

"They are a rare bird, hard to be obtained,

but when obtained, easily kept. Their weight, about twelve pounds per pair."

It is a most stately and rich bird, reminding one of the solemn antiquity of the Nile, with its gorgeous mantle of golden hues and its long history. They are very prolific, bringing off three broods a year, from eight to twelve each time; their weight is about eight pounds each.

#### GOOSE HOUSES, NESTS, ETC.

In selecting a situation for a goose-house or pen, all damp must be avoided; for geese, however much they may like to swim in water, are fond at all times of a clean, dry place to sleep in.

It is not good to keep geese with other poultry; for when confined in the poultry-yard they become very quarrelsome, harass and injure the other fowls; therefore it is best to erect low sheds, with nests partitioned off, of suitable size to accommodate them; and there should never be over eight under one roof; the large ones generally beat the smaller, in which case they should of course be separated, one from the other, by partitions extending out some distance from the nests.

The nests for hatching should be made of fine straw, of a circular shape, and so arranged that the eggs can not fall out when the goose turns them. From thirteen to fifteen will be as many as a large goose can conveniently cover. The ganders remain near when sitting, and seem to watch them as a kind of sentinel, and woe be to man or beast that dares approach them; and they seem very anxious to see the young ones, that are to be born, make their appearance.

Incubation lasts from twenty-eight to thirty days, and not two months, as some state, and the goose should have water placed near her, and be well fed as soon as she comes off the nest, that she may not be so long absent as to allow the eggs to cool, which might cause her to abandon her task.

After twenty-eight or twenty-nine days' incubation, the goslings begin, but frequently at an interval of from twenty-four to forty-eight hours, to chip the shell.

Like turkey-chickens, goslings must be taken from under the mother, lest, if feeling the young ones under her, she might perhaps leave the rest

of the tardy brood still unhatched. After having separated them from her, they must be kept in a basket, lined with wool and covered with cloth; and when the whole of the eggs are hatched, may be returned to the mother. The male seems to evince the same solicitude for the young as the mother, and will lead and take equal care of them. We once had a gander of the Chinese variety that actually took a brood of goslings from under a common goose, and brought them up with equal care.

On the second day after they are hatched they may be let out after the dew is off, if the weather is warm, but care must be taken not to expose them to the scorching rays of the sun, which might kill them. All authors seem to agree on the proper food to be given them, which is coarse barley meal, bruised oats, bran, crumbs of bread soaked in milk or curdled milk, lettuce leaves chopped fine, or crusts of bread boiled in milk. In this country Indian meal moistened with water is generally given, but in our experience we have found it too laxative, and to counteract the effect we have moistened it with boiled milk, and occasionally added chives chopped fine. It is our opinion, however, that more goslings are killed by over-feeding than by starving. A person who is curious in these affairs informed us that he had been most successful when he let the goslings shift for themselves, if the pasture was good. We tried a brood that way and succeeded well. Grass seems to be their natural food, and by following nature in all cases, with animals, and more especially with fowls, we have generally succeeded best.

After they are three or four weeks old they may be turned out in a field or lane containing water. If their range is extensive they must be looked after, as the goose is apt to drag the goslings until they become cramped or tired, some of them squatting down and remaining at evening, and are seen no more.

After the goslings are pretty well feathered they are too large to be brooded under the mother's wings, and will sleep in groups by her side, and must be supplied with good and renewed straw to sit on, which will be converted into excellent manure. Being now able to fre-

quent the pond and range the common at large, the young geese will obtain their own living; and if favorably situated, nothing more need be allowed them excepting the vegetable produce of the garden. We have, however, found it a good practice to feed a moderate quantity of solid food to the young and store geese, by which means they are kept in a growing and fleshy state, and attain a larger size; the young ones are also forward and valuable for breeding stock. Besides, feeding them, especially in the evening, on their return, attaches them to their home.

There is one thing the author has learned by sad experience, and that is, it will not answer to confine goslings in a small yard; they need exercise and a pasture to range in. We had a fine brood of fourteen, nearly feathered, confined in our poultry-yard with other fowls. We occasionally found one sitting by or on the water, stupefied, dumphish, with no inclination to eat or stir, and would remain so for one or two days, and then die. After losing three in this way, we turned them out, and let them range over the pasture and visit the pond, and never lost one afterward.

#### DISEASES.

“Prevention is better than cure;” so says the proverb. Colds and fogs are extremely against geese; therefore, when young, care should be taken not to let them out but in fair weather, when they can go to their food without a leader.

They are particularly subject to two diseases; the first a looseness, or diarrhea, for which Main recommends hot wine in which the parings of quinces, acorns, or juniper-berries are boiled. The second is like a giddiness, which makes them turn round for some time; they then fall down and die, if they are not relieved in time. The remedy recommended by Main, is to bleed the bird with a pin or needle, by piercing a rather prominent vein situated under the skin which separates the claws.

Another scourge to goslings are little insects which get into their ears and nostrils, which fatigue and exhaust them; they then walk with their wings hanging down, and shaking their head. The relief proposed is to give them, on



their return from the fields, some corn at the bottom of a vessel full of clear water; in order to eat it, they are obliged to plunge their head in the water, which compels the insects to fly and leave their prey.

#### PLUCKING.

Mr. Dixon's advice, that "Geese as well as ducks should be let out to the pond a few hours before execution, where they will purify and arrange their feathers, as if they were going to their wedding instead of their death," should always be followed. The bird is more easily plucked, and the feathers are more valuable. Decapitation is the mode of death generally adopted; but as this might injure the appearance of the bird for sale, other modes, less instantaneous, and also less merciful, are had recourse to. To aid plucking, the goose is often placed immediately after death in boiling water; but the appearance of the skin is more or less injured by that mode, therefore dry picking should be always had recourse to. The fat taken from the intestines of a goose, and converted into an oil, becomes a medicine of great reputation, and is considered highly efficacious to human as well as animal systems.

Old, or what are termed stock-geese, may be plucked three, and in some seasons four times, allowing six weeks' interval, without inconvenience. Many are of opinion that it was directly injuring the health of geese to pluck them. This operation, however, if done in a dextrous manner, and taking place before the moulting season, a disease common to all birds, is followed by no inconvenience. One crop of feathers may be taken from the goslings, and some think it an advantage to them, but that could hardly be expected; and it should be deferred till the goslings are three months old before they are subjected to this operation, especially to those intended to be killed early, as they would get lean, and lose some of their good qualities. Precaution should be taken when the goslings are just plucked not to suffer them to go into the water, but merely give them drink for one or two days till the skin is closed. Food has a great influence over the quality of the down and feathers, as also the care that is taken of the

geese. Great precaution is necessary; the feathers always bring away with them a kind of fat, which would give them a disagreeable smell, and perhaps spoil, if this was not prevented by putting them in the oven after the bread is taken out, and keeping them in a dry, airy place. One pound of feathers is generally estimated to be the produce of a common goose; the Bremen and African will give more, and of a superior quality. None but feathers taken from live geese, or those just killed, should be carried to market; in the last instance they must be picked before the bird is entirely cold; the feathers are infinitely better for it.

On the subject of plucking the living geese we would willingly be silent; for the torture experienced by the poor fowl from the too frequent unskillfulness and want of dexterity of the operator must be excruciating. The skin and flesh are sometimes so torn as to occasion the death of the victim; and even when the geese are plucked in the most careful manner they lose their flesh and appetite; their eyes become dull, their wings heavy, and drag on the ground, and they languish in a most pitiable state during a longer or shorter period. Great mortality often occurs in flocks of geese, from sudden and imprudent exposure to cold, after being stripped, and more especially during severe storms and sudden atmospheric vicissitudes.

A writer in one of the magazines remarks humanely on the cruelty of picking geese, and proposes the following remedy:—"Feathers are of but a year's growth, and in the moulting season they spontaneously fall off, and are supplied by a fresh fleece. When, therefore, the geese are in full feather, let the plumage be removed, very close to the skin, by sharp scissors, clipping them off as sheep are shorn; they will be renewed at moulting in the usual course of nature. The produce would not be much reduced in quantity, while the quality would be greatly improved, and an indemnification be experienced in the consciousness of not having tortured the poor bird, and in the uninjured health of the fowl, and the benefit obtained in the succeeding crop. After this operation shall have been performed, the down from the breast may be removed by the same means."

## FATTENING.

"It is the same with the goose," says Main, "as with every other bird that is fattened up; that moment must be laid hold of, when come to a complete plumpness, or they would soon get lean and die if they were not killed." Meal and skimmed milk will soon do the business: after ranging in the grain stubbles but little else will be required. These are called "*green geese*," and are most esteemed by the epicure; they will then be about six weeks old, tender and fine.

The writer of the article on poultry in "Baxter's Library of Agriculture," recommends steamed potatoes, with four quarts of ground buckwheat or oats to the bushel, mashed up with the potatoes, and given warm. This, it is said, will render geese, cooped in a dark place, fat enough in three weeks.

The French method of fattening is detailed very copiously by M. Parmentier. "The whole process," says he, "consists in plucking the feathers from under the belly; in giving them abundance of food and drink, and in cooping them up more closely than is practiced with common fowls; cleanliness and quiet being, above all, indispensable. The best time is in

the month of November, or when the cold weather begins to set in. When there are but a few geese to fatten, they are put in a cask, in which holes have been bored, and through which they thrust their head to get their food; but as this bird is voracious, and as with it hunger is stronger than love of liberty, it is easily fattened, provided they are abundantly supplied with wherewithal to swallow."

The Romans considered the liver of the goose a great dainty, and to increase its size they fed them sixteen days on a paste of Turkey figs, stamped and beaten up with cream; their livers would thus be brought to table, each weighing three or four pounds. Equal parts of the meal of oats, rye, and peas, mixed with skimmed milk, form an excellent feeding article for geese and ducks.

The grand object of preparing, not geese only, but all kinds of poultry, for market in as short a time as possible, is effected solely by paying unremitting attention to their wants; in keeping them thoroughly clean, in supplying them with proper food (dry, soft, and green), water, exercise-ground, etc. They should be fed three times a day: and it is truly astonishing how soon they acquire a knowledge of the time.

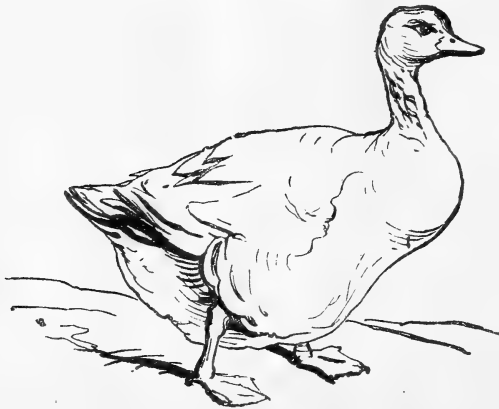

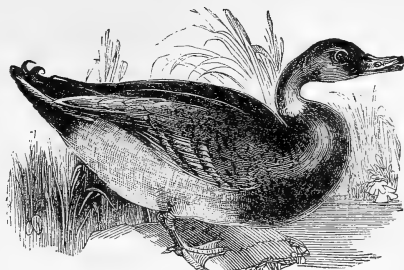

THE MALLARD DUCK.

## CHAPTER XVII.

## AQUATIC FOWLS.

## THE WILD MALLARD DUCK.

THIS is the well-known and generally supposed original, on both continents, of our common domestic duck, of which we have now so many varieties. Messrs. Cooper and Nutall have noticed a large wild variety measuring 30 inches. In these the primaries are white and the tail feathers gray.

The Mallard is commonly found about most of the lakes in the interior of the State of New York, and also on the sea-coast. It leaves us in the autumn for the South, and has been observed from Mexico to the 68th parallel.

*Description.* — Male. Head and neck deep green with a white ring or collar beneath; neck and breast deep chestnut; bill yellowish, and sub-equal with the head, flattened and somewhat dilated toward the end; upper part of back, wing-coverts, and quills, ash-brown of different shades; rump and upper tail-coverts blackish-green; some of the outer scapulars chestnut, with dark transverse lines. Mirror with purple and green reflections. Sides of the rump and interior of the wings white.

Female. Reddish-brown, spotted with dusky-brown; beneath, yellowish-gray, obscurely spotted with brownish-black. When young, wholly brownish, varied with yellowish and blackish.

Eminent naturalists of our own and other

countries acquiesce in the supposition that the domestic duck derived its origin from the Mallard; but other writers on the subject hold a different opinion. Mr. A. Williams, in a note to the authors of the "Poultry Book," says, "I do not think that our domestic varieties are descended from the wild. At farm-yards, there often occurs a cross between the two, and I have known the wild birds kept by a gentleman whose property adjoins mine. These never altered either in color or habits, many of them flying away unless pinioned."

Mr. Dixon, in his work on poultry, has the following passage in strong corroboration of the opinions that have been expressed: "I know of no instance in which any one has finally succeeded in founding a permanent tame farm-yard race of ducks by breeding from the Mallard, though the attempts have been numberless, and a few parties have been on the brink of success. Crosses between the wild and tame birds have answered better; but the progeny have retained their full share of independent temper and movements."

Dixon regards it as an importation from India and China, probably about the same period as witnessed the discovery of the passage by the Cape of Good Hope, in the year 1493; and we have of late years received a permanent variety, if not a distinct species of tame duck

(the Black East Indian), from the Cape or the South American continent. Such an importation may be regarded as a link in the chain that would connect our domesticated duck with an Eastern origin, independent of its wild congener.

"The squatters of the Mississippi," says Audubon, "raise a considerable number of Mallards which they catch when quite young, and which, after the first year, are as tame as they can wish. These birds raise broods which are superior even to those of the old ones, for a year or two, after which they become similar to the ordinary ducks of the poultry-yard. The hybrids produced between the Mallard and the Musk duck are of great size, and afford excellent eating. Some of these half breeds now and then wander off, become quite wild, and have by some persons been considered as forming a distinct species. They also breed with the black duck, when tamed."

Dixon says, "This season [1849] I have been particularly successful in rearing the Mallard in a state of domestication. Three different sets of eggs, from five to nine in number, were brought in by our mowers, and the greater part hatched under hens. The ducklings were shy at coming out, but as soon as their first feathers began to appear, they would eat from my hand, and follow me eagerly about the garden, if they saw me with a spade; seeming to understand that they were about to enjoy their grand treat of worms. Out of many I reared, there were only two females—one of which had a singular habit of attacking me with great spirit and much quacking, if I attempted the capture of either of her gentlemen friends."

Beautiful Mallard! Well mayest thou be vain of that beautiful plumage—of those intense hues which rival the rare glories of the breaking dawn, or the decaying twilight of autumn, or the intermingled dyes which tinge the stripes of the showery bow. But, alas! the most venial vanity will be indulged no more, for the red drop of death is trembling on that polished beak, and thy heart's blood is oozing over thy downy bosom. Thine affrighted mate has left thee to breathe out thy last gasp on the billow; and on the wings of fear, is now hastening away

with the rest of thy brethren to the distant country of thy destination. Many a time will she, while swimming in some lagoon with her brood (thy offspring), relate the cruel story of thy death, and caution them to make a wide circuit, whenever they shall chance to espy a small, suspicious-looking wherry, with a long gun and a rough face peeping over its side, in the waters of the bay. She will caution them to keep farther out to sea along that piratical coast, and thereby avoid that treacherous picaroonish sort of craft, which there lies in wait, between two billows, ready to pounce upon and pop over the unwary cruiser.

#### THE BLACK EAST INDIAN, OR BUENOS AYREAN DUCK.

This variety is not usually met with, but deserves to be better known. It is called the Buenos Ayres duck, but well known in England as the "East Indian duck," sometimes called the "Labrador duck."

"Why or wherefore this bird was called the 'Labrador duck,'" remark the authors of the "Poultry Book," "we are at a loss to imagine, since that country, as has been well observed by Mr. Dixon, 'however rich in wild specimens, is not likely to have given us any tame variety of bird.' The trivial or accidental name of a bird has often, however, done good service in exciting facts in connection with its history; and we diligently consulted authors as to any possible connection between Labrador and the variety of duck of which we are now speaking. Our search, we must confess, supplied us with but one solitary hypothesis for this designation, in the fact that velvet scoter, *annus fusca*, abounds on the wild coast of Labrador, and that a fancied resemblance between the deep, glossy, black plumage of these two birds may have suggested the name by which it has hitherto been commonly known. As such distinctions, however, only tend to perpetuate error, the sooner they are discarded the better; and whether Buenos Ayres or the East Indies is the original locality from which the other synonyms have been obtained, either of these is a far preferable distinctive appellation. The Zoological Society, we are told, obtained

their specimens from the former place; but whether these were original stock in that country, or imported from the Asiatic continent, we know not. Nothing is more probable than that the Zoological Society had their birds from the East, *via* Buenos Ayres. Whether the stock had been introduced there a month, or twenty years previously, does not alter the main fact; while ships direct from India would be very likely to land a few pairs at the first channel port they touched at.

"But from whatever quarter obtained, they are handsome creatures. A little girl, at first sight of them, could not help exclaiming: 'Oh, what beautiful golden-green ducks!'

"This duck is of less size and lighter than either the Rouen or Aylesbury breeds, the adult male rarely exceeding five pounds in live weight, while the females average but four pounds. Their plumage, however, is strikingly beautiful, and possesses the peculiarity unusual in birds of this genus, that the drake does not monopolize all its glories, a portion of his refulgence being granted to the duck. Metallic tints, varying with the light from green to a gilded purple, decorate their garb of uniform velvet black, their bills and feet being of the same dark hue. Not only the neck and back, but the larger feathers of the tail and wings, are gilt with metallic green. On a sunny day of spring, the effect of these glittering black ducks sporting on the blue water is very pleasing, and adds much to the beauty of the scene. With all their brilliant combinations of color, there is a singularly neat and close make, and compactness of feathers, which suggests their comparison, in these respects, with the Game fowl.

"All who have kept these birds unite in expressing their constant annoyance at the appearance of more or less white feathers after their first moult. Mr. Nolan, indeed, remarks, that they often then become entirely white. This latter metamorphosis we never have ourselves witnessed, though we have frequently seen it to the extent of giving the bird the pied appearance. Many are also of opinion that the duck is more apt to exhibit this peculiarity than the male bird. The white feathers so produced remain till the next moulting, when the bird fre-

quently discards them altogether, and re-assumes its perfect sable plumage; they are, however, often permanent. Impurity of blood has been assigned as the cause of this occasional drawback to their undoubted beauty; but we are not yet aware of any yard, however carefully selected, that has wholly escaped the occurrence of this blemish.

"A peculiarity of these ducks is, that the eggs they lay in the beginning of the season are frequently smeared with a dark greasy matter, which causes them to appear of a slaty, and sometimes even of a black hue; but the color of those subsequently laid, gradually fades to that of the common kinds. This strange appearance is not caused by any internal stain penetrating the whole thickness of the shell, but by an oily pigment which may be scraped off with the nail. In form they are elongated, being smooth, thin shelled, and weighing about two ounces. They lay, perhaps, a little later than other ducks, and some say a little more difficult to rear, being very subject to *cramp*; this will not surprise us when we remember the warmer temperature of their original Eastern abode.

"The drakes are unusually pugnacious; and on that account it is impossible to keep two of them in the same inclosure. The imported birds usually pair; but a drake from their produce will occasionally attend to three or four ducks. If any complaint should be made in regard to unfertilized eggs, it might thus be explained, as in the case of the Musk duck, with which domestication has had a like effect.

"They are less disposed to confinement than other domestic ducks, and the most suitable locality is found for them on a piece of ornamental water, where, in addition to the beauty of their appearance, they add the farther recommendation of the highest gratification for the table. For this latter purpose they require no fattening, and but few wild ducks are more tender or of higher flavor."

#### THE MUSK, OR BRAZILIAN DUCK.

Our portraits at the head of page 268 were furnished by a friend from specimens in his own yard, who says, in a note accompanying them,

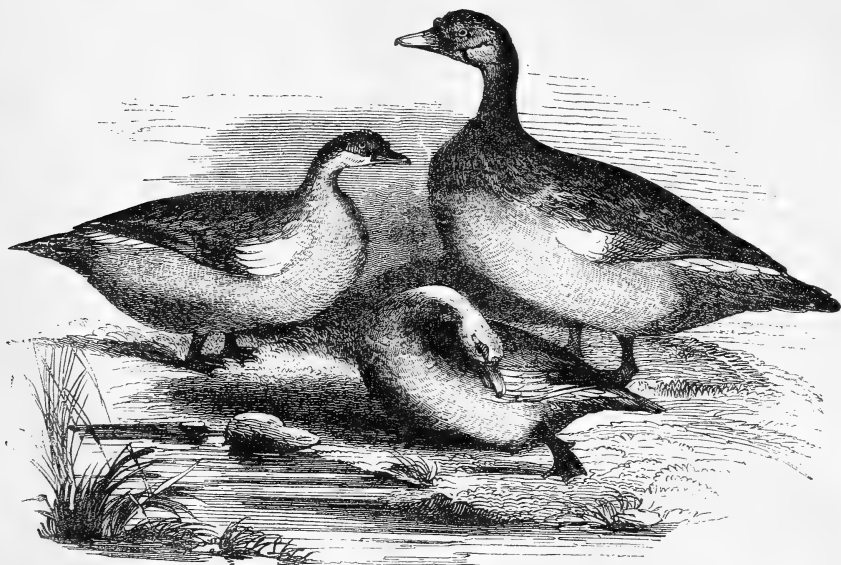

THE MUSK, OR BRAZILIAN DUCK.

“They are all of the same color, though I believe not necessarily so; a very dark, rich, blue-black *prismatic*, with every color of which blue is a component, and a white bar is on the wing, some white about the head and neck, and I presume are to be found of all colors; the feathers on the back of the male are somewhat plumelike; the legs and feet dark,” etc., etc.

The Muscovy duck, it appears, is only found in a wild state in South America. Marcgrave has observed it in the Brazils; it is also a native of Guiana. This species has, like the East Indian duck, been erroneously called after the name of a country which certainly never witnessed its existence in a wild state. The appellation Muscovy, by which term European Russia is often designated, is clearly erroneously applied to this bird, whose plumage is thought to emit the odor of musk, whence the trivial name.

The narratives of early voyagers to the South American continent, and the numerous groups

of islands which stud the Pacific Ocean, afford frequent allusions to these birds, which, however variously named in such records, have sufficiently clear descriptions of their peculiar appearance and habits to enable us to recognize them without difficulty. Brazil appears to have been one of their principal habitats; hence one of the designations connected with this bird.

The tropical regions, therefore, of South America, are the native country of the Musk duck, and the French naturalists assert that it is a distinct species and not a variety. The first point that strikes us in the Musk duck, is the disproportionate size of the male and female, the latter not exceeding five, or at the most six pounds live weight, while the drake frequently reaches nine or ten pounds. They are of various colors; but commonly black, variegated with other colors. They are also clear white, slate-blue, and light yellow. The white are considered the prettiest, their feathers the most valuable, and their flesh the most delicate.

The black are deemed the handsomest, the most productive, and yield the finest flavored flesh. The black are glossed with green on the back, and changeable as they are exposed to the rays of the sun. But the first-named color would seem to belong to the bird in its wild state; and the best specimens of the tame birds are of similar plumage. In the domestic state it exhibits every variety of color, like the common duck. At one time the male is white, at another the female is white; in other instances both male and female are of a lead color, yellowish, with more or less white. A crest, elevated or depressed at pleasure, rises from the back of the neck, and a scarlet, fleshy space surrounds the eye, continued from scarlet caruncles at the base of the bill. The colors of the legs and feet vary with that of the plumage, being mottled in dull flesh color and black, according to the tints of the latter. Their figure is of an extremely elongated character, and the shortness of their legs increase their stumpy appearance. The duck has considerable powers of flight; but her mate's heavier bulk retards his aerial excursions. Contrary to the usual habits of this genus, the top of a wall, or the branches of a low tree are favorite resting-places. Its feet appear by their form to be more adapted to such purposes than those of most other ducks. If allowed to spend the night in the hen-house, the female will generally go to roost by the side of the hens, but the drake is too heavy and clumsy to mount thither with ease; and thus they are certainly less aquatic in their habits than the other species, though equally disposed to cultivate a familiar intercourse with man.

Travelers assert that these birds, in their wild state, perch on large trees that border rivers and marshes, similar to terrestrial birds; they build their nests there, and as soon as their ducklings are hatched, the mother takes them one by one and drops them into the water. Laying takes place two or three times in a year, and each is from twelve to eighteen eggs, quite round, and of a greenish white. The moulting season begins in September, and is sometimes so complete, that the ducks, finding themselves almost destitute of feathers, are unable to fly,

and let themselves be taken alive by the natives. These birds are as shy as our wild ducks, and it is by surprise alone that they are to be shot.

Those that expect that its singular appearance would render it a curious, if not an elegant companion, among our most attractive ducks, will be disappointed; for it will seldom go near the water if it can help it, but will prefer the farm-yard, the precincts of the kitchen, or even the piggery itself, to the clearest stream that ever flowed. In fact, it hates water, except some dirty puddle to drink and drabble in. When thrown into a pond it gets out again as fast as it can. Its very short leg does not appear to be mechanically adapted for the purpose of swimming. It waddles on the surface of a pond as much as it does on dry land; it is evidently out of its place in either situation.

The voice of the drake is so harsh and croaking that he has been described as if perpetually suffering from a sore throat; and, contrary to the usual rule among their congeners, the female is comparatively silent.

As layers they are inferior to the Rouen or Aylesbury, but probably on a par with the usual inhabitants of the duck-pond. The eggs are of a dull white, and very seldom exceed three ounces in weight. The period of incubation is about five weeks.

The male is very salacious, and pairs readily with tame or domestic ducks, and the birds thus produced are of large size, seven and eight pounds each being no unusual live weights. It is asserted, on good authority, that such hybrids have proved unprolific; while others assert to the contrary. Out of one hundred eggs of this hybrid sort, M. Parmentier was able to succeed in hatching scarcely twenty ducklings; and hence, to keep up the stock, Olivier de Serres advises to continue crossing every year, by keeping a sufficient number of Musk drakes with the common ducks. We are unable to ascertain any one instance of these hybrids having bred by themselves; but suited with a bird of the parent species, we have little doubt that in most instances a prolific union would take place. The female will also, though not so readily, pair with the common drake. The hybrid has a deep-green plumage, and is destitute of the

red caruncled membrane on the cheeks, as well as the musky odor of the rump gland of the Musk duck. These hybrids are of good size, fat readily, and are not inferior to the wild duck for the table, as the author can testify.

The drake is often very pugnacious, cross, and quarrelsome with other poultry; and we have known it to attack small children, and take away food from them. He manifests little affection to his female partner, and none toward his offspring. The possession of three or four mates suits him and them better than to be confined to the company of a single one. He bullies other fowls, sometimes by pulling their feathers, but more frequently by following them close, and repeatedly thrusting his face in their way with an offensive satyr-like expression of countenance; or salaciously pursuing them, whether male or female, until he has accomplished his purpose, or at least made an attempt.

Though a voracious feeder, the Musk duck is easily fattened, a prolific breeder, and consequently may be profitably reared. It is excellent eating, if killed just before it is fully feathered, but it is longer in becoming fit for the table than the common duck. The flesh is at first high flavored and tender, but an old bird would be rank and tough.

The rearing of the young of the Musk duck, at least in the southern parts of the United States, is not attended with greater difficulty than those of other domestic varieties; whenever, therefore, we hear of complaints being made to the contrary, we presume that the colder northern sections are the localities referred to. The finest and most healthy brood we have ever seen, were hatched and reared in the attic of a warm out-building.

No very high opinion is entertained by us as regards the appearance, habits, or economy of this duck in the poultry-yard. The bloated look of the head, the inordinate length of the body, its awkward legs and twaddle walk, mar the effect of colors that are often brilliant and striking.

#### THE WOOD DUCK.

This is the most beautiful of the ducks known; the only one approaching it being the Mandar-

in duck of China, which, indeed, it strongly resembles. Its popular name of wood duck, is derived from the fact that it makes its nest in hollow trees; and the *summer duck*, from remaining with us during the summer. It is only seen in the North during the summer months, migrating southwardly with the cold weather. It is familiarly known in every part of the United States, from Florida to Lake Ontario. It rarely visits the sea-shore or salt marshes, its favorite haunts being the solitary, deep, and muddy creeks, ponds, and mill-dams of the interior, making its nest frequently in some old hollow tree that overhangs the water.

The wood duck is equally well known in Mexico and many of the West India Islands. During the whole of our winters they are occasionally seen in the States south of the Potomac. On the 10th of January Doughty says he met with two on a creek near Petersburg, Virginia. In the more northern districts, however, they are migratory. In Pennsylvania, the female usually begins to lay late in April or early in May. Instances have been known where the nest was constructed of a few sticks laid in a fork of the branches; usually, however, in the hollow of a tree, which is selected for this purpose.

The wood duck seldom flies in flocks of more than three or four individuals together, and most commonly in pairs, or singly. The common note of the drake is *Peet! peet!* but when, standing sentinel, he sees danger, he makes a noise not unlike the crowing of a young cock—*Oe eek! oe eek!* It breeds from Mexico to the Columbia River, and eastwardly to Nova Scotia. It has been found from 19° south to 54° north latitude. Its food consists of acorns, chestnuts, seeds of wild oats, aquatic plants, and insects. Its eggs yellowish-white. Their flesh is inferior to that of the Blue-winged teal. They are frequent in the Albany, New York, and Philadelphia markets. A few years since large numbers were taken in a seine on Lake Pleasant, and sold alive in Albany.

Among other gaudy feathers with which the Indians ornament the calumet, or pipe of peace, the skin of the head and neck of the wood duck is frequently seen covering the stem.



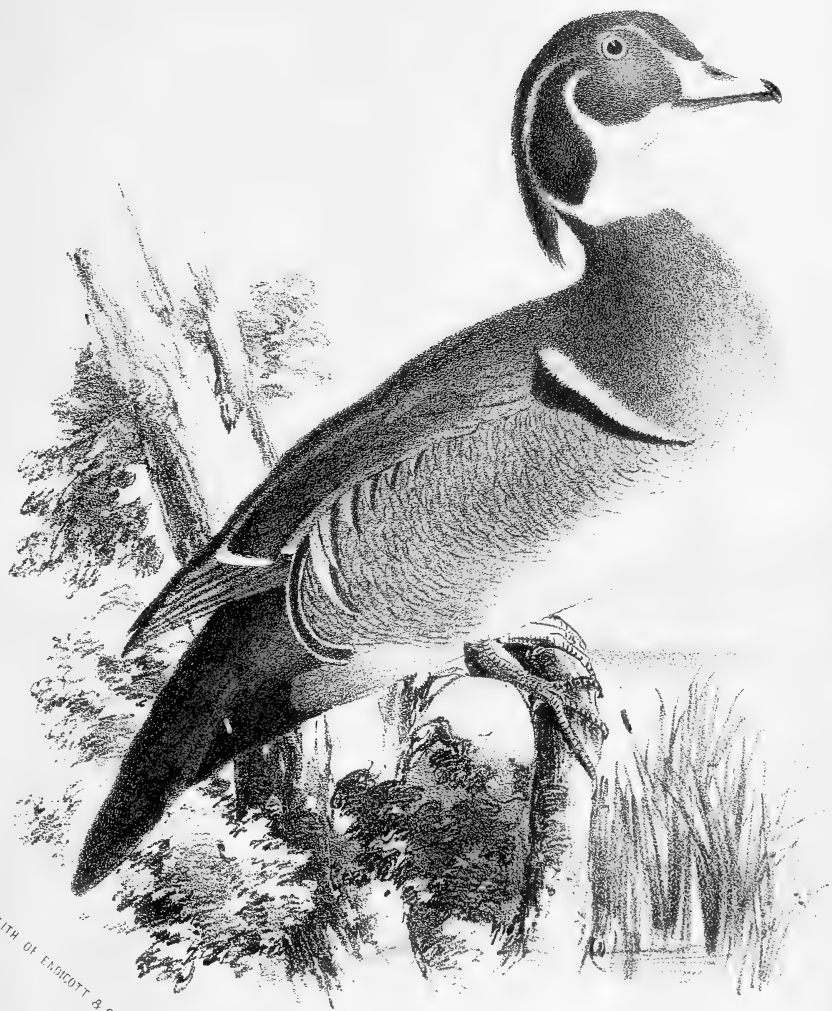

LITH. OF EMMETT & CO. N. Y.

SUMMER DUCK .





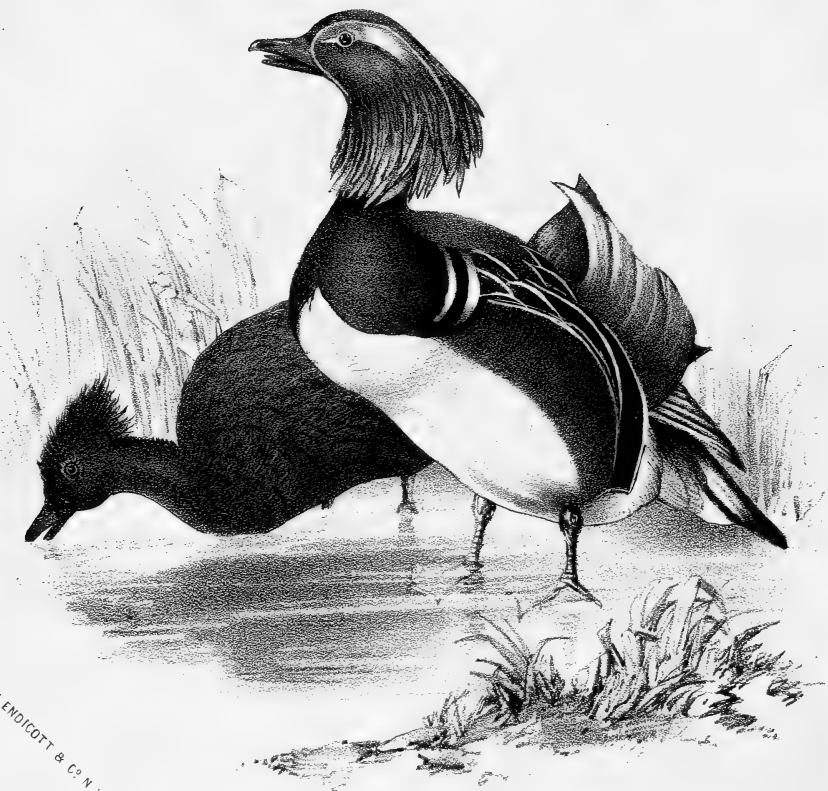

LITH. OF ENDICOTT & CO. N. Y.

MANDARIN DUCKS.

This beautiful bird is easily domesticated, and soon becomes so familiar as to permit one to stroke its back with the hand. On a late visit to "Spring Side," the beautiful country-seat of M. Vasser, Esq., we saw in his aviary a pair of these birds, the duck then sitting on six eggs. They are also tamed in various parts of the Union. "Captain Boice, Collector of the port of Havre de Grace, informs me," says Wilson, "that about forty years ago, a Mr. Nathan Nichols, who lived on the west side of Gunpowder Creek, had a whole yard swimming with wood ducks, which had been tamed and completely domesticated, so that they bred and were as familiar as any other tame fowls; that he (Captain Boice) himself saw them in that state, but does not know what became of them." Latham says that they are often kept in European manageries, and will breed there.

*Description.*—The wood duck is from 19 to 20 inches in length, and 28 inches in extent; bill red, strongly toothed, much hooked, shorter than the head, the feathers in front descending low, margined with black; head deep glossy-green; irides orange-red; front crown and pendent crest rich glossy bronze-green, ending in violet, elegantly marked with a line of pure white running from the upper mandible over the eye, and with another band of white proceeding from behind the eye, both mingling their long pendent plumes with the green and violet ones, producing a rich effect; cheeks and sides of the upper neck violet; chin, throat, and collar round the neck pure white, curving up in the form of a crescent nearly to the posterior part of the eye; breast dark violet-brown, marked on the fore part with minute triangular spots of white, increasing in size until they spread into the white of the belly; each side of the breast is bounded by a large crescent of white, and that again by a broader one of deep black; sides under the wings thickly and beautifully marked with fine undulating parallel lines of black, on a ground of yellowish-drab; the flanks are ornamented with broad alternate semicircular bands of black and white; sides of the vent rich light-violet; tail-coverts long, of a hair-like texture at the sides, over which they descend, and of a deep black glossed with green; back dusky-

brown, reflecting green above, below dusky; primaries dusky, silvery-hoary without, tipped with violet-blue; secondaries greenish-blue, tipped with white; wing-coverts violet-blue, tipped with black; vent dusky; legs and feet yellowish-red; claws strong and hooked.

The female has the head slightly crested, crown dark-purple, behind the eye a bar of white; chin and throat, for two inches, also white; head and neck dark-drab; breast dusky-brown, marked with large triangular spots of white; back dark bronze-brown, with some gold and greenish reflections. Speculum of the wings nearly the same as in the male, but the fine penciling of the sides, and the long, hair-like tail-coverts are wanting; the tail also is shorter.

#### THE MANDARIN DUCK.

A remarkably beautiful addition to our ornamental water-fowl is the Mandarin Duck contributed by the Celestial Empire. In many respects it resembles our American wood duck, which is one of the most beautiful of the family of ducks, but is said to be surpassed by the Mandarin species, which is even more beautiful and gorgeous in its plumage. Of its habits we are not advised. The specimens from which our portrait was taken, which we present to our readers in this volume, have been bred in the Zoological Society's Gardens, in the Regent's Park, London, and were originally brought from Whampou, in China.

The Mandarin drake is represented as being the most gorgeous in plumage of all water-fowl (our beautiful wood duck should be excepted). The top of the head is black, a color which extends down the nape of the neck; below is a clear white line, passing over the eye down the base of the bill, which is of a bright deep-rose color. The cheeks and the long pointed feathers of the neck are of a bright orange-brown. The upper parts of the breast and back are of a glossy black, and the lower white. The two raised feathers of the wings are orange-brown; the flight-feathers are white and black. The tail is black, except underneath, which is white. The sides of the breast are greenish-orange, margined by a clear white line. The legs are

a deep pink. From the middle of June to the middle of September the drake assumes the color of the duck, which is a dull olive-brown. He is very pugnacious, and quite a tyrant over the other aquatic birds.

A pair of these beautiful birds were imported by Mr. John Giles, of Woodstock, Connecticut, in 1854. They were sold at auction, at Barnum's Museum, in December of the same year, for \$150. They are said to have cost in England 75 guineas (about \$375).

#### THE ROUEN DUCK.

This bird derives its name from the city of Rouen, on the River Seine, in France, and is esteemed highly by epicures. It is a prolific bird, and lays large eggs. Its size is the criterion of its value.

"My notion," says Dixon, "that the title Rouen and its aliases is only a trade name, intended to elevate the common sort into a choice and more remarkable variety, is confirmed by the omission of such a designation by Aldrovandus, and later by Buffon; both writers who swept every thing into their net."

The variety at present most in request is the dark-colored Rouen, originally from France, but common in England and this country.

The authors of the "Poultry Book" speak of the Rouen duck thus: "We have given precedence to the Rouen, because we believe that, under ordinary circumstances, it will be found the most profitable variety. Its plumage, moreover, is of great richness. The latter, we will at once admit, is a point of minor consideration in a bird whose merits must be mainly weighed by its value as an economical inhabitant in the poultry-yard; but where both these recommendations can be combined, there are few persons who would not be desirous of so uniting them."

"I am confident," says Mr. Hewitt, whose Rouen ducks have been placed at the head of their class at the exhibitions for several consecutive years in England, "that, when obtained purely bred, the Rouen is the most prolific, the most profit-producing of the duck tribe. They are the most lethargic, and consequently the most speedily fed of any; but they lay great

numbers of large eggs, an average of the weight of which would be  $3\frac{1}{2}$  ounces—always above three ounces. The color of the egg is a blue-green, the shell being considerably thicker than that of the Aylesbury breed. The flesh is of the highest possible flavor; and in first-rate specimens the supply is most profuse; for the drake and three ducks belonging to the writer, and which were so successful for several consecutive years at the Midland Poultry-show, when there weighed by the judges reached  $26\frac{3}{4}$  pounds; and this, too, when they were simply taken from the pond without any previous preparation. On another occasion, when purposely fattened, they attained the almost incredible weight of 34 pounds. I have frequently known the young drakes, of only nine or ten weeks old, to weigh, when killed, 12 pounds the pair, and in some instances more than this. As regards their consumption of food, I have not found them to require more than the birds of smaller varieties. In color, whether we consider the plumage of either sex, the Rouen closely assimilates to the wild duck. The eyes, however, are very deeply sunk in the head; and the ducks especially, even when young, have the appearance of old birds; the abdominal pouch, or apron, being developed, as in the case of the Toulouse goose, at a very early age. This enlargement of the lower part of the body in some specimens causes it to rest partially on the ground—not unfrequently, indeed, to the destruction of the feathers. The whole appearance of the Rouen bird is certainly ungainly; but the most inconsiderate observer can hardly fail of being struck with the size of really good specimens of this family. Their dull, loud, monotonous call is also distinct from any other variety. A great diminution in size is the invariable result of any attempt at crossing, and this becomes apparent in the first generation. They are as hardy as any other kind, and rarely evince any disposition to wander from the immediate vicinity of the homestead. So dull and lethargic, in fact, are they, that they are little liable to become the easy prey of any pilfering stroller; or even if one bird is picked up, the others will scarcely move away. They appear to care less for water exercise than the other varieties."

BLACK EAST INDIAN, OR BUENOS-AYREAN DUCKS.

ROUEN DUCKS.



LITH. OF ENDOTT & C. N. Y.





The following is a description of the adult plumage of both male and female:

*Drake*.—Bill inclined to green, the nail and around the nostrils being black. Head and neck, as far as the white collar, which should be very distinct, brilliant iridescent green; throat and breast claret-brown; back, scapulars, and thighs gray, with minute wavy dark lines at right angles to the shaft of the feather; tail brown, with the outer edge of the feathers white, forming a broad margin of that color, the three centre feathers being curled; primaries brown; secondaries with a bar of bright steel-blue forming the speculum, the band of black, the extremities being tipped with white; lesser wing-coverts rich brown; greater wing-coverts the same, with a narrow white margin; under part of the body gray, with the same wavy dotted lines as on the back; legs and feet orange.

The *duck* has a uniform plumage of rich brown, every feather being more or less marked with black; bill, legs, and feet dusky; irides light-brown in both sexes.

The Rouen duck has been usually spoken of as a late layer, but this is entirely contrary to what has happened with us, for we have found the old birds good egg-producers in autumn, even before their moult has been completed; in this respect, indeed, they resemble the Shanghai fowl. With some cessation in mid-winter, they recommence at a period when others of their species have only just begun. Even the young ducks of the year are singularly prolific; those hatched in March will sometimes commence laying the latter part of August or first of September, and continue to give from three to four eggs per week till October.

The colors of the Rouen duckling, when first hatched, are a yellowish-brown body color, with patches of yellow upon the face, breast, and wing, a dark line passing along the side of the face about the eye. At two weeks old, these colors have become blended and indistinct, and so remain till the feathers take the place of down.

Is the Rouen duck specifically distinct from the common brown duck of the farm-yard? Mr. Furneaux inclines to the opinion that it is but a cultivated sub-variety of the common duck.

The peculiarity of voice which has always

been noticed, the deep greenish-blue tint of the egg, and the great bulk of the body, resembling a pillow or bolster supported on two sticks (for the indentation of outline before and behind the legs suggests the simile), favor the idea of at least a permanent variety; though whether it may amount to specific difference we will not undertake to decide.

It is indisputable that the most hardy variety of duck is the Rouen; and from this cause it is that they are frequently kept with a degree of profit and success very rarely attained where other kinds are preferred.

Of all kinds of ducks the Rouen seems the most useful; and at the same time, there are very few parties who will not freely admit that for beauty of plumage, few, if any, excel them. They commence laying sooner in the spring than any other ducks; are infinitely more hardy than the Aylesbury, even when kept on the same farm; and, indeed, bear well trials from keen and inclement weather that would quickly destroy all hopes of immediate benefit from the more docile breeds.

The Rouen ducks lay very freely if the eggs are removed, and the eggs are readily incubated by common hens; but for brood stock, ducks should only be used for rearing them, or in after time the *drakes* will be one of the most troublesome pests in the whole yard. It will be well for new beginners to pay the fullest attention to these last remarks, as it will prevent much vexation and disappointment, and perhaps an equally unfavorable ebullition of temper in themselves; therefore, except for killing, let the ducks themselves watch their own offspring—a duty they will accomplish with carefulness, perseverance, and success. The flavor of the Rouen duck is really most excellent, being surpassed by none others. Incredible weights have likewise been attained by some birds of this variety. At one of the Birmingham shows, a drake and three ducks of this kind were tested by the judges with scales, against all other kinds then present, and exceeded the most weighty of their rivals by nearly four pounds; their own weight, though then simply taken from the pond, without any extra feeding, was twenty-six pounds and three-quarters.

A singular trait of character in this variety is, that the duck closely approximates in size to the drake, and not unfrequently is the most weighty of the two; while in most other kinds, the disparity of size is glaringly obvious, and tells much against the value for consumption. One of the most general objections to ducks is their sad propensity to stray away and get lost, more especially if in the neighborhood of large rivers or other running streams; and it is, therefore, by no means unusual for parties, when this occurred frequently, to give up all desire for this really profitable kind of stock, in a spirit of utter hopelessness and despair. To those persons the Rouens will prove themselves a treasure, for they are the most determined "stay-at-home" birds possible. They never ramble at all except near home, but appear dull and lethargic, which accounts for the little difficulty and expense in feeding; they eat no more than others, and attain their very superior size and weight in an equally short period of time.

When it is considered how great pecuniary benefit may be obtained, by the keeping of a few ducks, to the general farmer, it will be readily admitted that, to the humble cottager, the boon will be still more highly valuable, as ducks speedily arrive at a condition for market, and when there offered, generally command the quickest and most universal sale of any other poultry whatever; they are reared more readily, and will eat food of almost any kind. It should always, however, be kept in remembrance, that the quality of the flesh is highly dependent on the nature of their food; therefore a proper care on this point is essentially necessary. I feel certain that if a common degree of care, attention, and regularity of feeding are adopted with ducks, they will remunerate the owner as well as any poultry he may bring before the public.

The Rouen ducks are generally larger than the Aylesbury, and heavier. The plumage of this bird much resembles the wild duck; the drake's especially is magnificent, its head and neck being a rich, lustrous green, with a white ring at the base of the neck, breast a reddish brown, the remainder of the body and wings partaking very greatly of the colors of the wild

Mallard. The duck is a brown bird, the feathers being all marked with black; she has, at a very early age, a great development of her "stomach pouch," which frequently hangs so low as to impede the action of the bird; from this and other causes, the Rouen is a less active variety than the Aylesbury, and for the same cause does not make a good sitter, being too heavy for the young birds when hatching. The eggs laid by these birds generally exceed in number those laid by the Aylesbury; indeed, the duck is almost a continuous layer; but not making a good mother for the cause above stated, her eggs should be placed under a hen.

The demand for ducks being very much smaller than for fowls, one drake and three or four ducks will be sufficient for most farmers. The Rouen will do better without water than the Aylesbury; but a pond deep enough for them to swim in, is so *essential* for both ducks and geese that no farmer should attempt keeping them without it.

The young ducks are reared, provided they are *not* allowed to get into *any* water for some time after they are hatched; and although this time may not be accurately defined, if six weeks are allowed to elapse, the birds will be found to have gained most considerably in weight and size over those which have frequented a pond, as the time employed in swimming is then occupied in sitting still and getting fat. All ducks are great eaters, and most industrious little bodies in procuring their food from water-courses, always thirsty, as one would suppose, from the greediness with which they sputter. Notwithstanding, the young will certainly repay the cost by their rapid growth.

#### THE AYLESBURY DUCK.

Of white ducks the best are the Aylesbury, with its unspotted snowy-white plumage, and yellow legs and feet. It is large and excellent for the table, but not larger or better than several others. They are assiduous mothers and nurses, especially after the experience of two or three years. A much smaller race of white ducks is imported from Holland; their chief merit, indicated by the title of Call Duck, consists in their incessant loquacity. The white

LITH OF ENDICOTT & CO. N. Y.



WHITE AYLESBURY DUCKS.

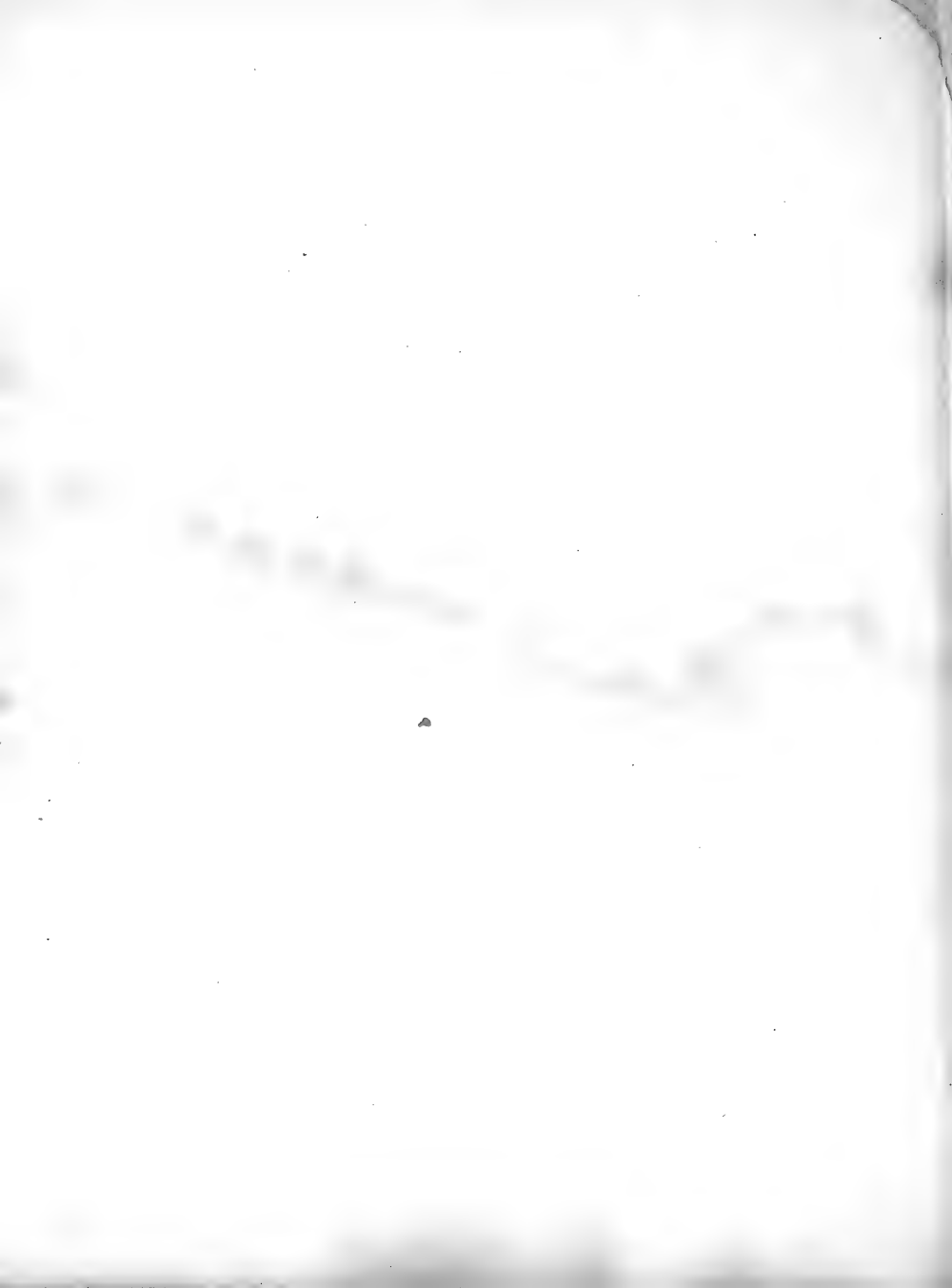

Call duck has a yellow orange-colored bill; that of the Aylesbury should be flesh-colored.

Mr. John Giles, of Woodstock, Connecticut, who has probably had as much, if not more, experience in the breeding and management of fowls of all descriptions than any other fowl-fancier in this country, says of the Aylesbury duck: "The breed I brought out with me from England are white, with white bills; their flesh is of a beautiful white, weighing from eight to ten pounds per pair when full grown. They are considered a rarity in London, commanding one-third more price than any other ducks brought to market."

"The white Aylesbury ducks are a beautiful and ornamental stock," says Mowbray, "matching in color with the Embden (Bremen) geese. They are said to be early layers and breeders. Vast quantities are fattened for the London markets, where they are in great demand. Many families derive a comfortable living from breeding and rearing ducks, the greater part of which, the early ones at all events, are actually reared by hand. The interior of the cottages of those who follow this occupation presents a very curious appearance to the stranger, being furnished with boxes for the protection of the tender charge of the goodwife, whose whole time and attention is taken up with this branch of domestic economy."

Browne says, "The English, or Aylesbury white variety, though handsome and strong, is inferior in flavor, the flesh being too light colored and 'chickeny,' as it is termed. Great numbers of these fowls, however, are fattened in Buckinghamshire, England, for the London markets, where, in consequence of their size, they command high prices."

The heaviest specimens of the Rouen duck exceed, in respect of weight, those of the Aylesbury breed, the latter being a bird of less breadth, though equaling the former in length. Plumage of unspotted white, a pale, flesh-colored bill, a dark, prominent eye, with orange legs, are the characteristics of this race, whose name is derived from the town of Aylesbury, in which neighborhood they are kept in large numbers for the supply of the London markets. The weight of the adult Aylesbury duck should at

least average, if properly fed, from ten to twelve pounds the pair (duck and drake). Instances, however, have occurred where the drakes have come up to eight pounds and upward, and would, in all probability, if fattened, reach ten pounds each. They are very prolific layers. From two of these ducks 300 eggs have been obtained in the course of twelve months; in addition to which, one of them sat twice, the other only once, the three nests giving thirty young ones. The eggs vary in color, some being white, while others are of pale blue. As a farther recommendation for them, in an economical point of view, it is argued that their consumption of food is less than that of the common duck; and another advantage may be found in their comparative silence from the continuous "quack, quack, quack," of the latter bird. They also attain greater weight in less time; and, from their superior appearance when plucked, are a far more marketable article.

The carriage of the Aylesbury duck is more upright than that of the Rouen; the eye, of which the iris is dark-gray, being also more prominent; and, as might be anticipated from its greater powers of locomotion, the bird is by no means addicted to such stay-at-home habits.

It has been stated that the eggs of the Aylesbury ducks are of a pale-blue tint; the usual color, however, is a dull French white, the surface being smoother than that of the Rouen, but the shell more brittle. Average weight about three ounces. They are better sitters, and also, from their lighter form, better nurses than the latter.

It is not necessary here to enter into the question of the origin of these varieties; they are now so distinct from any other as to be easily distinguished by any one desirous of obtaining them.

The Aylesbury duck is a pure white, with flesh-colored bill and orange-colored legs. In birds of about two years old, the bill frequently becomes marked with dark blotches, which is considered a great disfigurement. The duck is a good layer, commencing early in the year, and should be allowed to sit on thirteen eggs.

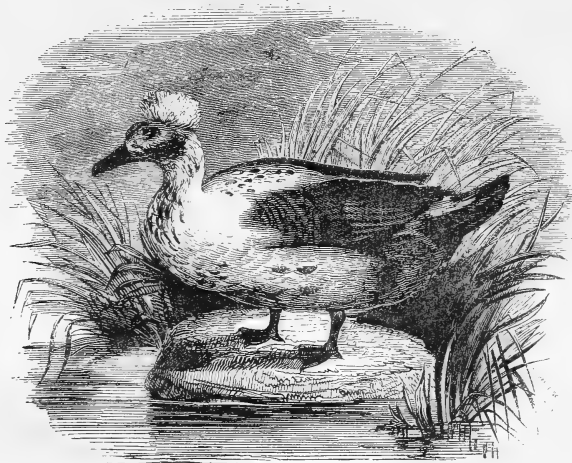

THE CRESTED DUCK.

## THE CRESTED DUCK.

This is a beautiful and ornamental variety. They are of all colors, having in fact no other common features. We have had them pure white, black, and mixed black and white, with large turbans, or top-knots. The duck from which our portrait was taken, is a fair specimen of the pied ones. The white are considered the most beautiful, as they have yellow bills and legs. We are not advised of the origin of this variety. Mr. Brent regards them as probable descendants of the Australian tufted ducks, of which more than one variety is said to exist in that country. Many may have been thus bred; but the accidental appearance of the tuft on the goose, of which bird we have no rumor even of any variety thus uniformly decorated, suggests the probability of the duck having obtained its head-dress in a similar accidental manner. The top-knot of the latter, however, is in general proportionably larger, and more spherical than that of any geese we have ever yet seen, sometimes, though placed on the back of the head, even rivaling in form that of the Polish hen.

Main speaks of the "Red-crested duck," from New Zealand, but which is not common there. A red crest grows on the head; a very glossy black-gray is predominant on the back, and a deep grayish soot-color on the belly; the bill and legs are lead-color, the irides golden.

Latham also speaks of the Crested duck, and says, "This inhabitant of the extremity of America is of the size of the wild duck, but is much longer, for it measures twenty-five inches in length; a tuft adorns its head; a straw-yellow, mixed with rusty-colored spots, is spread over the throat and front of the neck; the wing speculum blue beneath, edged with white; the bill, wing, and tail are black; irides red, and all the rest of the body ashy-gray."

It is a question, therefore, not easily answered, whether the domestic Crested duck has been produced from a cross of our wood duck, or from the above-mentioned variety. If it sprung from either, its size would indicate that the one mentioned by Latham would appear the most likely to produce them.

Very fine specimens of Crested ducks have been exhibited at the different meetings of the Poultry and Agricultural Societies.

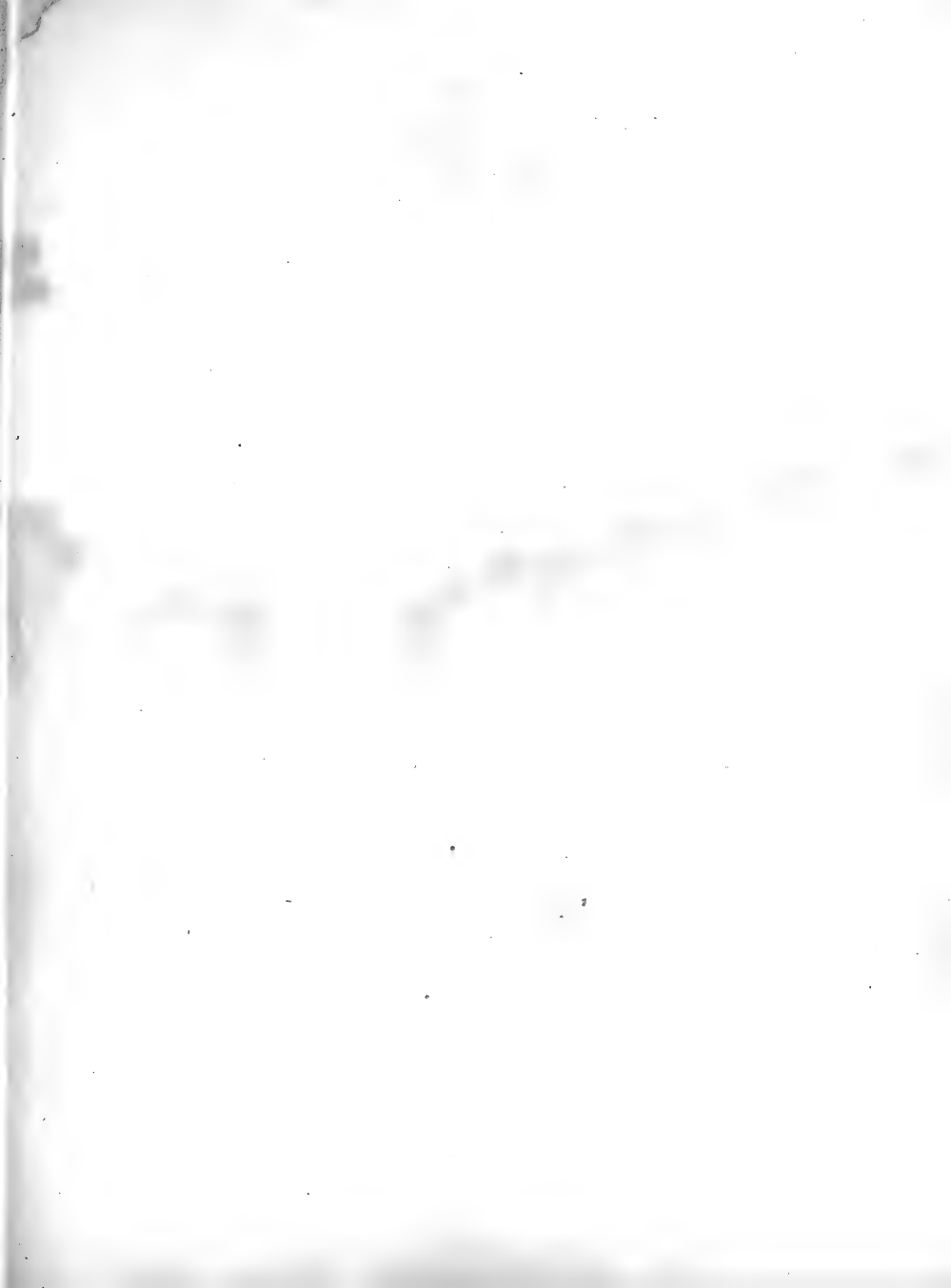



CANVAS BACK DUCK.

RED HEADED DUCK.

Wm. J. ELLIOTT & CO. N.Y.



## THE HOOK-BILLED DUCK.

Many early writers refer to this species, the singularity of whose appearance would secure attention in the days when real utility so often yielded to what merely gratified curiosity.

*Description.*—The bill is of large size, and turned downward, *not upward*, as some writers have it; but Roman-nosed ducks, in short, with features of a most grotesque and ludicrous appearance. The plumage usually white, with a large top-knot; but colored specimens are not unfrequent. Holland is the source from which these birds are commonly derived; and it is said that they pair like wild ducks, and manifest a decided disinclination to associate with other ducks.

Dixon says, "Hooked-billed ducks are nothing new." Albin, in 1738, published colored figures of both sexes, which look much as if they had a right to claim the rank of a species. The lines of small white specks on the head, as he describes them, are remarkable. The bill has some resemblance to the Flamingo. He says these ducks are better layers than any of the other, either the wild or tame.

We are not aware of ever having seen or tasted one; but they are said to possess qualities for the table, in addition to the recommendation of being both hardy and good layers.

## THE PENGUIN DUCK.

This variety or species of duck are nearly as strange as the Hook-billed. The birds thus designated have a peculiar upright gait, somewhat resembling the Penguin. But it is not strikingly apparent when they are in an ordinary frame of mind. A sudden fright makes them raise their heads, as it will many other birds. They are usually of dull colors; and, from all we can learn, wholly devoid of any merits to compensate for their uncouth appearance. Nolan states that they are imported from Bombay, and are the common domestic duck of that country.

## THE CANVAS-BACK DUCK.

This celebrated variety of duck is a native of America, and, as far as can be judged from

the best figures and descriptions of foreign birds, is altogether unknown in Europe. It probably received its name from the peculiar color of the feathers on the back, which very much resembles coarse canvas. It approaches nearest to the Pochard of England, *Anas Ferina*; but differs from that bird in being superior in size and weight, in the greater magnitude of its bill, and the general whiteness of its plumage. The Pochard, according to Latham, measures 19 inches in length, and 30 in extent, and weighs 1½ pound. The Canvas-back measures 2 feet in length, and 3 feet in extent, and, when in best condition, weighs three pounds and upward.

Bewick says of the Pochard: "The plumage, above and below, is wholly covered with prettily-freckled, slender, dusky threads, disposed transversely in close zigzag lines, on a pale ground, more or less shaded off with ash;" a description much more applicable to the bird figured beside it, the Red-head, and which is very probably the species meant. In the Pochard, given by Bewick, who is generally correct, the bill agrees very well with that of our Red-head, but is scarcely half the size and thickness of that of the Canvas-back.

The Canvas-back, in the peculiarly rich, juicy tenderness of its flesh, and its delicacy and flavor, stands unrivaled by the whole of its tribe, in this or perhaps any other quarter of the world. Those killed in the waters of the Chesapeake are generally esteemed superior to all others, doubtless from the great abundance of their favorite food which is there produced. It is well ascertained that they feed on a bulbous root, or a grass which grows on the flats, and has very much the color and flavor of garden celery: it is to this food that has been attributed, and we believe correctly, the peculiar delicious flavor of their flesh. This plant, which is said to be a species of *Vallisneria*, grows on fresh-water shoals, is from 7 to 9 feet long, having narrow, grass-like blades of 4 or 5 feet; and with great strength and agility the Canvas-backs seize the grass near the bottom, bringing it up, root and branch, to the surface, where they bite off the root, leaving the long herbaceous part to float on the water.

"It is a circumstance calculated to excite our surprise," says Wilson, in his "Ornithology," "that the Canvas-back duck, one of the commonest species of our country—a duck which frequents the waters of the Chesapeake in flocks of countless thousands—should yet have been either overlooked by the naturalists of Europe, or confounded with the Pochard, a species whose characters are so obviously different. But this is the fact, I feel well assured, since I have carefully examined every author of repute to which I have access, and have not been enabled to find any description which will correspond to the subject before us." The species, then, we hope, will stand as Wilson's own; and it is no small addition to the fame of American ornithology, that it contains the first scientific account of the finest duck that any country can boast of.

The Canvas-back duck is 2 feet long, and 3 feet in extent, and when in good order, weighs 3 pounds. The bill is very large, rising high in the head, 3 inches in length, and 1½ inch thick at the base, of a glossy black; eye very small; irides dark-red; cheeks and fore part of the head blackish-brown; rest of the head, and greater part of the neck, dark-cinnamon, or a bright glossy reddish-chestnut, ending in a broad space of black that covers the upper part of the breast, and spreads round to the back; back scapulars and tertials white, faintly marked with an infinite number of transverse waving lines or points of the breast; also the belly white, slightly penciled in the same manner, scarcely perceptible on the breast, pretty thick toward the vent; wing-coverts gray, with numerous specks of black; primaries and secondaries pale slate, two or three of the latter of which nearest the body are finely edged with deep velvety-black, the former dusky at the tips; tail very short, pointed, consisting of fourteen feathers of a hoary-brown; vent and tail-coverts black; lining of the wing white; legs and feet very pale ash, the latter three inches in width—a circumstance which partly accounts for its powers of swimming.

The female is somewhat less than the male, and weighs 2½ pounds; the crown is blackish-brown; cheeks and throat of a pale drab; neck

dull brown; breast, as far as the black extends on the male, dull brown, skirted in places with pale drab; back dusty white, crossed with fine waving lines; belly of the same dull white, penciled like the back; wings, feet, and bill as in the male; tail-coverts dusky; vent white, waved with brown.

The Canvas-back duck arrives in the United States from the north about the middle of October; a few descend to the Hudson and Delaware, but the great body of these birds resort to the numerous rivers belonging to and in the neighborhood of the Chesapeake Bay, particularly the Susquehanna, the Petapsco, Potomac, and James rivers, which appear to be their general rendezvous. Beyond this, to the south, I can find no certain accounts of them. On the Delaware they are called Red-heads, on the Susquehanna Canvas-backs, on the Potomac White-backs, and on James River Sheldrakes.

They are seldom found as far north as the Hudson, or at a great distance up any of these rivers, or even in the salt-water bay; but in that particular part of tide-water where a certain grass-like plant (*Vallisneria*) grows, on the roots of which they feed. Where this plant is found there will the ducks be; and they will frequently venture within reach of their enemy's gun rather than abstain from the gratification of their appetite for this delicious food.

The Canvas-back duck will feed readily on grain, especially wheat, and may be decoyed to particular places by baiting them with that grain for several successive days. Some few years since a vessel, loaded with wheat, was wrecked near the entrance of Great Egg Harbor in the autumn, and went to pieces. The wheat floated out in vast quantities, and the whole surface of the bay was in a few days covered with ducks of a kind altogether unknown to the people of that quarter. The gunners called them Sea ducks. They were all Canvas-backs, at that time on their way from the north, when this floating feast attracted their attention, and for a while arrested them in their course.

We have been informed that attempts have been made to domesticate the Canvas-back duck, but we have not learned with what suc-

cess. We have seen in the yard of Mr. George Law, of Baltimore, a half-blood—a cross of the Canvas-back and the common duck. She was timid, shy, and seemed to retain many of the wild habits, and did not seem to care for the company of the other ducks in the yard.

At our public dinners, hotels, and particular entertainments, the Canvas-backs are universal favorites. They not only grace but dignify the table, and their very name conveys to the imagination of the eager epicure the most pleasing and exhilarating ideas. Hence, on such occasions, it has not been uncommon to pay from one to three, and even five dollars per pair for these ducks; and, indeed, at such times, if they can they must be had, whatever may be the price.

As the Red-heads are so frequently imposed on purchasers for the Canvas-back, we have thought it advisable to introduce both birds in the same plate, where it will be seen that the distinguishing marks are chiefly confined to the bill, eyes, head, and size of the bird, and having a bright-red over the whole head.

#### THE RED-HEADED DUCK.

"This," says Wilson, "is a common associate of the Canvas-back, frequenting the same places, and feeding on the *stems* of the same grass, the latter eating on the *roots*; its flesh is very little inferior, and it is often sold in our markets for the Canvas-back to those unacquainted with the characteristic marks of each. Anxious as I am to determine precisely whether this species be the Red-headed widgeon, Pochard, or Dun bird of England, I have not been able to ascertain the point to my own satisfaction; though I think it very probably the same, the size, extent, and general description of the Pochard agreeing pretty nearly with this.

"The Red-head is twenty inches in length, and two feet six inches in extent; bill dark slate, sometimes black, two inches long, and seven-eighths of an inch thick at the base, furnished with a large broad nail at the extremity; irides flame-colored; plumage of the head long, velvety, and inflated, running high above the base of the bill; head, and about two inches of the neck, deep glossy reddish-chestnut;

rest of the neck and upper part of the breast black, spreading round to the back; belly white, becoming dusky toward the vent by closely-marked undulating lines of black; back and scapulars bluish-white, rendered gray by numerous transverse waving lines of black; lesser wing-coverts brownish-black; wing quills very pale slate, dusky at the tips; lower part of the back, and sides under the wings, brownish-black, crossed with regular zigzag lines of whitish; vent, rump, tail, and tail-coverts, black; legs and feet dark ash.

"The female has the upper part of the head dusky brown, rest of the head and part of the neck a light sooty-brown; upper part of the breast ashy-brown, broadly skirted with whitish; back dark ash, with little or no appearance of white penciling; wings, bill, and feet nearly alike in both sexes."

This duck is sometimes met with in the rivers of North or South Carolina, and also in those of Jersey and New York; but always in fresh water, and usually at no great distance from the sea. It is most numerous in the waters of the Chesapeake, and, with the connoisseurs in good eating, ranks next in excellence to the Canvas-back. Its usual weight is about 1½ pound avoirdupois.

The Red-head leaves the bay and its tributary streams in March, and is not seen until late in October.

#### THE DUCK.

The common duck is so well known that a description is hardly necessary. In regard to the origin of the common farm-yard duck but one leading opinion seems to have prevailed in all the compilations from Aldrovandus down to Audubon—that it is nothing more than the tame descendant of the common wild duck (*Anas boschas*) of Europe, or the Mallard. It is generally dark-brown or gray, and the wings and throat sometimes ornamented with changeable purple. The drakes of all sorts may be distinguished by the curled feathers in their tails.

Though little can be elicited as to the origin of the tame duck, we still possess birds in this class presenting features quite as distinct as any

in the various races of fowls, and even to a greater extent than appear in geese. These varieties may be thus stated:

The Rouen duck,	The Muscovy duck,
The Aylesbury duck,	The Crested duck,
The Common duck,	The Buenos-Ayreal duck.

We give precedence to the Rouen duck, because we believe that, under ordinary circumstances, it will be found the most profitable variety. Its plumage, moreover, is of great richness. The latter, we will admit, is a point of minor consideration in a bird whose merits must be weighed by its value as an economical inhabitant of the poultry-yard; but where both these recommendations can be combined, there are few persons who would not be desirous of so uniting them.

Ducks generally are very prolific in eggs. Mowbray says they are good layers (one, the property of Mr. Morell, laid an egg every day for eighty-five successive days), and that a duck has been known to lay, in the autumn, during forty-six nights in succession, after which she continued to lay every other night. "The Rouen duck," say the authors of the "Poultry Book," "has usually been spoken of as a late layer; but this is entirely contrary to what has happened with us, for we have found the old birds good egg-producers in autumn, even before their moult has been completed: in this respect, indeed, they resemble the Shanghai fowl. With some cessation in mid-winter, they recommence in January and February, at a period when others of their species have only just begun. Even the young ducks of the year are singularly prolific; some of our own, hatched this March (1853), laid in the latter part of August, and have continued giving us three or four eggs per week to the present time (October)."

"We have one Rouen drake and three ducks," says Mr. Punchard; "the latter commenced laying in February (1853), and up to July laid 334 eggs, besides a few soft, and five double ones. One of the ducks laid every morning for ninety-two consecutive days, and never desired to sit."

Like those varieties of fowls that pass by the name of "Everlasting-layers"—such as the Spanish, the Polish, and the Hamburgs—the

production of eggs is the object to which the natural powers of the Rouen duck are mainly directed.

The egg of the duck is by some people very much relished, having a rich flavor, which gives it a decided superiority over the egg of the common fowl; and these qualities render it much in request with the pastry-cook and confectioner—three duck eggs being equal, in culinary value, to six hen eggs.

The duck possesses many excellent qualities. They were great favorites with the ancients, from the mildness and simplicity of their character, from their great fecundity, and from the cheapness and ease with which they are provided for. The feathers of the white sort are excellent, and will compare favorably with those of the goose.

The inoffensive and harmless character, the social and conversational qualities of ducks, render them not only pleasant but profitable birds to keep; and the contrast between them and chickens, in their nature and habits, is much in their favor. The manners and actions of the duck, whether upon land or water, are curious and pleasant. Their regular afternoon parade and march in single line, the elder drakes and ducks in front, from the pond homeward, is a beautiful country spectacle, to be enjoyed by those who have a relish for the charms of simple nature. A parcel of ducks, which had been accustomed to their liberty, were, for some particular reasons, shut up for several hours. On the door of their house being opened they rushed out, threw themselves into rank-and-file, soldier-like, and marched, with rather a quick step, three or four times round a certain space, constantly bowing their heads to the ground, then elevating them and fluttering their wings; the ceremony finished, they quietly adjourned to the water. We have laughed a thousand times at the conceit with which our boyish imagination was impressed; namely, that the act we had witnessed was nothing less than a duckish thanksgiving for their deliverance.

Of the kind and social nature of the duck, the following is related by Mowbray: "We had drawn off for the table the whole of a lot of ducks, one excepted. This duck immediately

joined a cock and hen, and became so attached to them that it never willingly quitted their company, notwithstanding some harsh usage, particularly from the cock. It would neither feed nor rest without them, and showed its uneasiness at their occasional absence by continual clamor."

We once had an individual duck of the crested variety, which, after losing its mate, would keep with a few particular fowls during the day, and at night, when the fowls went to rest, she would follow up the stairs into the second story of the poultry-house, and sit as near the fowls as she could get. But after we had placed a few African geese in the yard, she left the hens and contracted an intimacy with the geese, keeping constantly with them.

Ducks thrive best, and are cleanest in the neighborhood of water, such as a pond or stream of water, swamps or marshes, as where there is an abundance of water they will find the greater part of their living. They are the most industrious of all the fowl tribe, and we have often gazed on them with admiration to see them sputter in hallow, and dive down in deep water. Ducks are carnivorous as well as granivorous; they will thrive on flesh and garbage of any kind like the chicken; yet water insects, weeds, vegetables, and corn, are their general food. They are also very fond of fish, and will greedily devour it even when partly decomposed; this, of course, will impart a bad flavor to their flesh if continued. In respect to food, ducks may be almost termed omnivorous; for few things come amiss to them. Slugs, worms, and aquatic insects, form a large portion of their sustenance when kept in suitable localities; but since grass and herbage go but a little way to satisfy their appetites, they are, comparatively speaking, far more expensive to keep than geese. The refuse of the kitchen-garden is eagerly devoured, and where grass is not attainable, must be regularly supplied. When feeding for the table, a portion of skim-milk with their meal forwards them very rapidly.

*Habitation.*—The duck-house should, if possible, be of brick, and paved with the same material, with considerable inclination, so that the wet, when the floor is sluiced down, may at

once pass off. Wood is seldom secure against rats, and does not so well suit the cleaning process of water and the lime-brush, and few places require their application more frequently. Do not crowd your birds, and always arrange for good ventilation. When the flock is large, separate the young ones, that they may thus have the advantage of better food, and that no risk may be incurred of finding the eggs of the older ones trodden under foot and broken at your morning visit. On this account the laying ducks should always have plenty of room, and be kept by themselves. Ducks for these reasons, as well as for the sake of cleanliness, should never share the habitation of fowls, and from geese they are liable to persecution. Yet where fowls are kept, a little contrivance will suffice to make their berth even in a fowl-house tolerably comfortable. In winter, a thin bedding of straw or rushes should be placed on the floor, and frequently changed.

When circumstances permit, we recommend the arrangement adopted in our own case, where the house for the old ducks adjoins their pond, which is railed in. They are accustomed to be fed here, and readily present themselves at the proper time; in the morning they get their food apart from both geese and fowls, neither plundered by the former, nor pilfering from the latter; and thus, too, their eggs are secured with far greater certainty, since the birds are not released from their inclosure till after the hour which usually witnesses the deposit of their eggs. By the time the ducks obtain their liberty the geese have gone to their pasture. The duck generally lays at night, or early in the morning, and is usually disposed to lay away from her proper house; but by our plan many eggs are secured which otherwise would have probably been lost.

Where there is much extent of water and shrubbery within the range of ducks, they are liable to lay and sit abroad, unless they are constantly looked after, and driven home at night, and provided with proper shelter or pens. These may be made of rough boards, or of rustic work, thatched with straw. On an island, with small trees, it would make quite a picturesque appearance.

The internal arrangement of these houses may vary according to the means and taste of the proprietor, only providing the ducks with nests or nest-boxes, in order that they may lay and incubate undisturbed, and affording proper protection for the young.

"It is a mistaken notion," says Ames, in the "Rural Cabinet," "to suppose that ducks *must* have a pond or run of water; they will do very well where there is none. A small pan or shallow tub sunk in the ground and placed so as to receive the waste water from the pump or well, will afford every necessary arrangement." But from our experience we are satisfied that where there is no piece of water or stream, they will *not* do as well, nor do they appear as beautiful. It is not in all situations that ducks can be kept with advantage; they require water much more even than geese; they are no graziers, yet they are hearty feeders. Confinement will not do for them; a paddock, a pasture, an orchard, a green lane, and a pond; a farm-yard, with barns, and water; a common, smooth and level, with a sheet of water, and nice ditches, abounding in the season with tadpoles and the larvæ of aquatic insects, are the localities in which the duck delights, and in such are they kept at little expense. It could not answer any where but in cold aquatic places. It would be fruitless to persevere in the desire of bringing up ducks in dry and barren places; their flesh would neither be so tender nor so sweet. In this case, it is better to take, in preference to them, some other birds, to whom the localities are better suited, to come into the views which are in contemplation.

*Pairing and Laying.*—One drake, according to M. Parmentier, is sufficient for eight or ten ducks, while Columella limits the number of ducks to six; and others to four or five. Few of the common ducks begin to lay until the latter part of February, and then only when well fed; but so far from producing the limited number of about sixteen eggs, some will lay as many as fifty, and nearly double that number. They do not usually continue to lay, however, later than May or June, unless they are particularly well fed—the great secret of rendering them prolific, provided they do not become too

fat. A strong desire for the selection of her own nest, is generally found to influence the duck; but this is mainly the case as the time draws on for incubation, since previously to that period, if the egg has not been laid before they have been let out of their house in the early morning, it is usually dropped at random—wherever, in fact, the bird may chance to be when the time comes. In clear, shallow water, many eggs are constantly found, and in deeper pools, when cleaned out, the relics of such are often visible.

At the laying season, therefore, ducks require to be closely watched and looked after, inasmuch as they are not so easily brought to lay in the nests prepared for them as common fowls, but will stray away to hedges and other by-places to lay, and will even sometimes drop their eggs in the water. When they succeed in laying out their number of eggs without their nest being discovered, they will hatch them, and not make their appearance till they bring their young family home to the yard, except in raw, cold weather.

If the nest selected by the duck be tolerably secure, it is better to allow her to continue there, for rarely will she sit well if removed from the spot of her own choice. But careless as we have seen her of the egg, no bird becomes more anxious for the nest and its contents when the more important duties of incubation are about to commence. The hollow of a wood-pile, or grassy hedge, or the shelter of some evergreen shrubs, are among the sites that appear most attractive. Here the ground is scraped out for an inch or so, and this, with a few leaves, is all that is thought necessary, till the duck finds that the time has come for its constant occupation. It is then well lined with her own down, and a store of leaves and grass is prepared, with which the eggs on the occasion of the mother's absence are entirely covered and concealed.

Thirteen eggs are a full allowance for a duck, and these should be as fresh as possible, for certainly the eggs of ducks do not keep so well for hatching as those of fowls. Whenever, therefore, we notice the preliminaries of a desire on the part of a duck to take to her nest, we allow

her eggs to remain, and, if insufficient in number, supply what is wanting by such as have been last laid by the others. During the early period of their incubation they are irregular in their time of feeding, for where the hen is accustomed to make her daily appearance with little variation from the same hour, the duck is often clamorously demanding the supply of her wants at daylight, and manifests the rapidity of her digestion by another application in the afternoon. During the last few days, however, they are steadier, and frequently, on the eve of hatching, are unwilling to quit their nests at all. At such times they should be well supplied with food and water close at hand. But so cautious in concealing her eggs, the duck becomes a sad tell-tale of their existence, both by her voice and appearance, when in search of food; the quack on such occasions becomes louder and more continuous, and the head is thrown back, the bill being kept open, and her whole plumage on end like that of a frizzled fowl.

Cautions are often given as to the necessity of watching the duck, and seeing to her return to the nest in good season. Occasionally, doubtless, as we find with our hens, there will be a negligent discharge of this duty. But such instances are the exceptions, and not the rule, among our own birds; and the warmth retained by ducks' eggs under the covering provided by the mother while herself absent, is very great. After an hour's absence, indeed, in the case of one careless mother, such heat was found to be retained as at once freed us from all anxiety as to the ultimate result.

"The duck," says Main, "is reproached with letting her eggs get cold when she sits. Yet Reaumur asserts he had a duck of the common species, which appeared still more uneasy about the cooling to which the eggs were going to be exposed while she was taking her food than hens appeared to be for theirs; she only left the nest once a day, toward eight or nine in the morning; and before she left it, she covered them over with a layer of straw, which she drew from the body of the nest, to secure them from the impression of the air. This layer, above an inch thick, secured the eggs so well that it was quite impossible to guess that they were there."

To be sure, every duck of the same species is far from giving the same proofs of so much foresight, for the preservation of the warmth of her eggs, as the one above alluded to. It often happens that they let them cool. Besides, hardly are the ducklings born when the mother takes them to the water, where they dabble and eat at first, and many of them perish if the weather is cold.

The period of incubation varies to a remarkable degree. From twenty-eight to thirty days is generally thus occupied. We would give twenty-eight days as a mean for those that are placed under ducks, for under hens we have constantly had them out in twenty-six days; but such birds generally proved delicate. Early broods are generally the best, because the warmth of summer helps much to bring them about; the cold always prevents the late broods from getting strong, and giving as large ducks.

For the foregoing reasons, it is well to set hens on ducks' eggs; being more assiduous than ducks, these foster-mothers have more affection for their young, will hatch and guard them with more attention; and as they are unable to accompany them on the water, for which ducks show the greatest propensity, as soon as they are excluded they follow the mother-hen on dry land, and get a little hardy before they are allowed to take the water without any guide.

The duckling seldom requires assistance in emerging from the shell; and this is fortunate, since it is a process of far greater hazard to relieve them than to render the same aid to chickens. The blood-vessels appear more liable to be ruptured; and we have few instances where such operations have eventually proved successful.

If a duck has hatched the eggs, it is best to confine her for a few days under a coop, that the young birds may not be enticed into the pond, such early immersion being unquestionably dangerous. The duck, too, is far from following the example of the hen in abstaining at this season from her usual excursions; fatigue, therefore, even supposing they escape the other perils of such rambles, is most prejudicial to the well-doing of the brood.

The period of their confinement to the pen

depends on the weather and strength of the ducklings. Two weeks seems the longest time necessary; and they may sometimes be permitted to enjoy the pond at the end of the week, but not for too great a length of time at once, least of all in cold weather, which will affect and cause them to scour and appear rough and draggled. In such case, they must be kept within a while, and have an allowance of strong food. The straw beneath the ducks should be often renewed, that the brood may have a dry and comfortable bed; and the mother should be plentifully fed with solid corn, without an ample allowance of which ducks are not to be reared or kept in perfection, although they gather so much abroad.

A writer in the *Southern Agriculturist*, in speaking on the subject of rearing ducks, says, "These birds being aquatic in their habits, most persons suppose they ought to give the young ones a great deal of water. The consequence is, they soon take colds, become droopy, and die. This should be avoided. Ducks, when first hatched, are always inclined to fever, from their pinion wings coming out so soon. This acts upon them as teething does on children. The young ducks should, consequently, be kept from every thing which may have a tendency to create cold in them. To prevent this, therefore, I always give my young ducks as little water as possible. In fact they should only have enough to allay their thirst, and should on no account be permitted to play in the water. If the person lives near the city, liver and lights should be procured, and these should be boiled and chopped up fine, and given to the young ducks. Or, if fish, crabs, oysters, or clams can be procured, these should be given. In case none of these can be obtained, all the victuals should be boiled before feeding. Boiled potatoes mixed with hominy are also excellent. Half of the ducks which are lost is because raw food is given them. To sum up in a word, if you wish to raise almost every duck that is hatched, give them little water, and feed them on no food which is not boiled. By observing this plan I raise for market, and for my own table, between two and three hundred ducks every year."

Ducks when young, are exposed to many dangers and mishaps. Their waddling gait quite unfits them for running from a foe on land, and they are but too apt to be trodden on by horses, cattle, and even by the foot of man. They should never be let out of their pens before half past eight o'clock in the morning, as if by any chance a pen may have been let out earlier, the probability is that they soon suffer from cramp; and it is a great gain for any young bird never to receive any check; and though the cramp may wear off, the bird never thrives so well afterward, if this malady has once attacked it.

It is the general idea that the down about the tail in the young of both geese and ducks should be cut close, especially if the weather be what is termed "*draggling*," i. e., wet or drizzly. Nature certainly does not provide a pair of scissors for this purpose; and among our own broods, where some have undergone this operation, while others have been left unshorn for the sake of testing the effect, we have hitherto been unable to ascertain any difference in their subsequent progress.

*Enemies of the Duck.*—Care must be taken that the water where the ducks are at liberty to go contain no leeches, which occasion the loss of the ducklings by sticking to their feet. We have also suffered some loss from the mud-turtle, which infests some streams. We were once passing near a small stream, and hearing the cries of a gosling, we hurried to the bank, and found its feet apparently entangled; on grasping it, we found something hanging to the foot, and on raising it from the water, behold a snapping-turtle had fastened to one of the legs, to which he adhered with the tenacity of a bulldog. We cast him on the bank; he weighed ten pounds, and furnished us a repast which would make an alderman's mouth water. But the most dreaded enemy is the fox, to whose stealthy incursions the ducks are most liable, because they most commonly stray from home, and it can not be hunted too much to get the country rid of it. The ducks should, therefore, be driven to the water in the morning and brought back in the evening.

Skunks, weasels, and minks will also destroy



ducks; we once had a very fine duck killed by a mink, which found its way from a neighboring stream to our poultry-yard. It was killed by a wound in the throat, no other part having been touched. Cats will sometimes catch young ducks as well as young chickens. Of all dreaded animals the rat is the most formidable. We have suffered more from their depredations than all the other animals put together, and they are the most difficult to be got rid of. To avoid them, the ducks, as well as young chickens, should not be cooped too near any buildings. The rat will also attack chickens even when feathered. We were once standing near a small patch of beans in the garden, when we noticed considerable fluttering and noise among a brood of chickens in search of worms and insects, when all at once one of the chickens emerged from among the patch of beans near to where we stood, followed by a large rat, in eager pursuit, which, on observing us, he abandoned. The best way to master that sort of animal is to keep one or two good terrier dogs.

To show that even in their congenial element, when skimming the surface of the water, under the watchful care of their mother, they are not free from danger, the following story is told by Waterton: "In 1815," says he, "I fully satisfied myself of the inordinate partiality of the carrion-crow for the young aquatic poultry. The duck had in her possession a brood of ten ducklings, which had been hatched about a fortnight. Unobserved by any body, I put the old duck and her young ones into a pond, nearly three hundred yards from a high fir-tree, in which a carrion-crow had built her nest; it contained five young ones, almost fledged. I took my station on the bridge, about one hundred yards from the tree. Nine times the parent crow flew to the pond, and brought back a duckling each time to its young. When a young brood is attacked by an enemy, the old duck has nothing to defend it. I saved a tenth victim by timely interference. In lieu of putting herself between it and danger, as the fowl would do, she opens her mouth and shoots obliquely through the water, beating it with her wings. During these useless movements the invader seizes its prey with impunity."

A duck seldom troubles herself much about the abstraction of her young, and the latter are equally content to forego maternal superintendence. Many hazards, too, are thus avoided; and the supervision of the attendant, both as regards food and management, is performed in one quarter of the time it would occupy in looking after the different straggling families.

"The courage of the hen is eminently shown in her determined resistance to any foe that may attack the nest or her young; the duck, on the other hand, though she vigorously repels an intruder while sitting, takes little trouble to protect her ducklings. Mr. Roscoe mentioned to us an instance of this indifference to the safety of her brood in a duck that had hatched close to his lodge in Knowlesy Park. Several of the ducklings had disappeared without the depredators being discovered, when he determined to watch and ascertain their fate. As evening drew on, a large rat was seen approaching; and with a view of seeing what defense might be made by the old bird, it was allowed to come close up to her. A duckling was then taken by it from beneath the mother, without her even moving or showing any sign of anxiety. Wishing to observe whether she would be more on her guard or equally passive on a second occasion, the rat was allowed to retire unmolested; and after a few minutes the same, or another animal of the same kind, again approached as before, evidently intent upon obtaining an additional victim. Still the duck remained without any expression of alarm; but his object being now gained, Mr. Roscoe's gun soon numbered the aggressor among the slain."

#### COMPARATIVE COST AND PRODUCE OF DUCKS.

Any calculation as to the return to be expected by those who keep ducks, turns entirely on the possession of a suitable locality. They are most likely to be kept with profit when access is allowed them to an adjoining marsh or water-meadows, where they are able in a great measure to provide for themselves; for if wholly dependent on the breeder for their living, they have such ravenous, insatiable appetites, that they would soon, to use an emphatic phrase, "eat their heads off." No description of poul-

try, in fact, will devour so much or feed so grossly. But certain moderate limits are requisite for their excursion, for otherwise they will gradually learn to absent themselves altogether, and acquire semi-wild habits; so that, when required to be put up for feeding or immediate sale, they are then found wanting. Ducklings too early allowed their liberty on large pieces of water, are exposed to so many enemies, both by land and water, that few reach maturity, and even if some are thus fortunate, they are ever after indisposed to return to their discipline and regular habits of the farm-yard. The best situation, therefore, is in a medium between such uncontrolled liberty and the close confinement of a yard. They may be kept in health, indeed, within small inclosures, by a good system of management, though we fear not with profit, which is the point to which all our advice must tend.

#### FATTENING.

According to Gervase Markham, pulse or any kind of grain will fatten ducks in a fortnight. We are not of that opinion; and we think if he had tried it, he would have found that his recipe was not always successful.

Ducks are fattened, either in confinement, with plenty of food and water, or full as well restricted to a pond, with access to as much solid food as they will eat. They fatten speedily by mixing their hard meat, as an Englishman would say, with such variety abroad as is natural to them, more particularly if in good condition, and there is no check or impediment to thrift, from pining, for every mouthful tells and weighs. A dish of mixed food, if preferred to whole grain, may remain on the bank, or, rather in a shed, for the ducks. "I must here mention a fact," says Mowbray, "which I have either actually verified, or suppose that I have verified. Barley, in any form, should never be used in fattening aquatics, ducks or geese, since it renders their flesh loose, woolly, and insipid, and deprives it of that high, savory flavor of brown meat which is its valuable distinction; in a word, rendering it *chickeny*, not unlike in flavor the flesh of ordinary and yellow-legged fowls." Oats and corn are the standard material for

ducks and geese, to which may be added boiled potatoes and Indian meal, or ship stuffs, mixed as it may be required. Liver boiled and chopped fine is a good condiment, and well relished by ducks. In England they are fattened on ground malt, mixed up with water and milk.

When ducks are confined to fatten, or otherwise, it is well to give them sand, or brick pounded fine and mixed with their food, and occasionally earth-worms. If their droppings are too loose and watery, mix a little forge-water with their food; this will also cure the relax in any other sort of fowls.

A deceased friend of the author, who was very curious in these matters, and besides a lover of the good things of this world, used to feed his ducks, ten or twelve days previous to killing them, with celery chopped fine, to give them a flavor, which he assured us rendered their flesh but little inferior to the famous Canvas-back ducks.

That the food on which fowls are fed has a tendency to impart a flavor to their flesh, and even to the eggs, is obvious from a fact related to us, not long since, by a friend. He said some onions, partly decayed, were thrown into a yard where he had some fowls confined, of which they ate considerable. A few days after, he was surprised to find his eggs tasted so strongly of onions that they could not be eaten. It is also well known that when fowls are fed on fish, their flesh has always a fishy taste.

Ducks are so very greedy that they often devour a whole fish or a frog, which hurts them very much, if they do not immediately throw it up. They are particularly fond of meat, which they eat with avidity, even when tainted; slugs, spiders, toads, insects, all suit their ravenous appetite. They therefore are, of all the birds in the poultry-yard, those that do the greatest service in a garden, by destroying insects which do so much damage, did not their own voraciousness cause other inconveniences, which more than balance this advantage.

Cobbett advises feeding them on "grass, corn, cabbages, and lettuces, and especially buckwheat, cut when half ripe, and flung down in the haulm. This makes fine ducks. Ducks will feed on garbage and all sorts of filthy things,

but their flesh is strong and bad in proportion. They are, on Long Island, fattened upon a coarse sort of crab, called a horse-foot, cast on the shores. When young, they should be fed upon barley-meal, or curds, and kept in a warm and dry place in the night-time, and not let out early in the morning. It always does them harm; and if intended to be sold or killed young, they should never go near ponds, ditches, or streams. When you come to fat ducks, you must take care that they get no filth whatever. They will eat garbage of all sorts; they will suck down the most nauseous particles of all those substances which go for manure. A dead rat, three parts rotten, is a feast to them. For these reasons we should never eat any ducks unless there were some mode of keeping them from this horrible food. We treat them precisely as we do our geese. We buy a troop when they are young, and put them in a pen, and feed them upon oats, cabbages, lettuces, and have the place kept very clean. Our ducks are, in con-

sequence of this, a great deal more fine and delicate than any others that we know any thing of."

They live chiefly on grain scattered about the premises, the siftings and sweepings of barns, all sorts of mealy substances, the residue of breweries and boiling-houses, roots, fruits, every thing, indeed, suits them, provided it be rather moist: in fact, nothing seems to come amiss to them.

Their weight, size, and flavor depend much upon the manner in which they have been fed and fattened. The size of the duck varies much. There are some which, in the course of eight or nine weeks, reckoning from their birth, weigh as much as seven or eight pounds, while others, of the same age and species, do not come to half this weight. As this bird values its liberty very much, it is no less strange than true, that it fattens more readily and rapidly not only in confinement, but even when cooped up; repose and good living appearing to hasten even aldermanic obesity.



## CHAPTER XVIII.

## WILD BIRDS SUSCEPTIBLE OF DOMESTICATION.

THERE can not be a doubt but that all the domestic fowls we now possess have been reclaimed from a wild state. We are certain the turkey and the Musk duck have been recently reclaimed; and we see no reason why many more may not be domesticated as well, if any pains were taken to do it. But those who have tried the experiment say that it requires three or four generations to bring them down to a thoroughly domesticated state. There are quite a number of beautiful wild fowl that, if domesticated, would not only make useful additions to the flocks of our poultry-yards, but add greatly to the beauty of those flocks. We are aware that many attempts have been made to domesticate that elegant and most beautiful of the duck tribe, known as the Wood or Summer duck, but have not heard of any systematic efforts being made to perpetuate them in a domestic state. It would require great care, attention, and perseverance; still, we think, it may be accomplished.

The following remarks upon the wild stocks was furnished by a gentleman of Boston, well known as an ornithologist and a natural historian, who was solicited by the Committee of Supervision of the Exhibition of Poultry held in the city of Boston in 1849 to furnish them with his views on the classification of domestic poultry, and the kinds which might, with advantage, be introduced into our poultry-yards: "The order," says the writer, "from which the most valuable poultry is derived is that known to naturalists as Gallinae, or Gallinaceous birds. The genus of these first in order is that known as Penelope, or Guan, of which there is not much to be said as regards their

fitness for the poultry-yard as I know of but one instance in which one has been brought to this country. I brought a female specimen of Crested Guan with me on my return from Yucatan, which did not live a year after its arrival. This bird is of the size of a small turkey, weighing, when full grown, seven or eight pounds; the meat is very good. They live principally on the leaves of trees and such like food, greedily eating grass, clover, etc.; in short, almost any green herbage, and also fruits of various kinds. They are not difficult to domesticate in their native countries; but, I think, could hardly be made to survive our cold winters.

"The next genus would be that of Crax, or Curassow, known as the Mexican Pheasant. There are a number of species of this genus, of which several are frequently domesticated in their native country. I brought with me three different species to this country, viz., one Crax Rubra, one Crax Alektor, and one Crax Globicera. The Crax Alektor was killed by a dog a few days after we arrived; the other two lived until winter, when, in order to save myself the trouble of keeping, I lent them to a traveling menagerie, and they soon died, owing probably to neglect. These birds are larger and more hardy than those of the previously mentioned genus. Their meat is very good, and they feed on much the same food as the Guans. They might, perhaps, with care, be kept in this country; but of this I do not feel very sanguine.

"The next genus which affords any thing likely to be of value in the poultry-yard is that of Pavo, or Peacock. There are three known species belonging to this genus, of which the Pavo Cristatus is the one generally known.

This bird used to be highly valued for the table, and I see no reason why it should not again.

"Next comes the genus *Phasianus*, or Pheasants. These birds are more valuable in a wild state, in parks and preserves, on account of their beauty, and the sport afforded in shooting them.

"Next to this comes the most valuable genus to the poulterer of any yet mentioned, that of *Gallus*, or Cock. Our present domestic varieties are derived principally from the *G. Bankiva*, but some of the larger varieties, probably, come from *G. Giganteus*, and *G. Ænus*, and perhaps from some of the other large species. The native country of this genus is India and its islands. In the same country is also found another genus, some species of which are frequently domesticated by the natives. It is that of *Gallophasis*—*Cock-pheasants*, which could undoubtedly be introduced here. The most common species are *G. Ignitus*, or FIRE-BACKED pheasant, and *G. Erythrophthalmus*, or Red-eyed Pheasant.

"Besides this, in the same country is found the genus *Ceriornis*, or Trogophans, which also would bear our climate perfectly well.

"The next genus in value, as well as order, is that of *Meleagris*, or Turkey. There are but two species, however, belonging to this genus, one of which is found in the north, and the other in Central America. *M. Gallopavo* is the common North American species, which has been spread all over the world. The other species, *M. Ocellata* (Honduras Turkey), was almost unknown until within a few years. It is much more beautiful than the common turkey, and also much more delicate and difficult to rear; so that I doubt whether they can be successfully domesticated in this country, though they are not uncommon in a domestic state in Yucatan.

#### "ANSERES.

"The next order from which is derived an important part of our poultry, is that of *Anseres*.

"The first genus is that of *Cygnus*, or Swan. It comprises nine species, of which four are

European, two are North American, two are South American, and one New Holland. All of these might be domesticated with us. The species now domesticated is *C. Olor*.

"The second genus is that of *Anser*, or Goose. There are eight known species belonging to this genus, of which two, the Snow and the White-fronted goose, are common to Europe and America, and five are common to Europe and Asia. The *Anser Feras*, or common wild goose of Europe, is the stock from which descend nearly all our common domestic varieties. All the species of this genus might be introduced into our poultry-yards.

"The third genus of this order is that of the *Bernicla*, or Barnicle Goose. The most important species of this genus is *Bernicla Canadensis*, or our common Wild or Canada goose. Nearly all the species of this genus might be domesticated. Our common Brant (*B. Brenta*) is frequently found in a domestic state along the sea-coast of Massachusetts.

"The fourth genus likely to afford poultry is that of *Aix*. There are but two species belonging to this genus, viz., *A. Sponsa*, our common Summer or Wood duck, and *A. Galerulata*, the Mandarin duck of China, both of which are occasionally domesticated, and are chiefly valuable as ornaments to pleasure-grounds, on account of their brilliant plumage.

"The fifth genus, that of *Mareca*, or Wid-geons, has been almost totally neglected by our poulterers and bird-fanciers, although having very beautiful plumage and excellent flesh; almost all the species would bear domestication perfectly well.

"The sixth genus, that of *Defila*, or Pint-tailed ducks, affords two or three large and very beautiful ducks. *Defila Acuta*, our common gray duck, is occasionally domesticated.

"The seventh and most important genus of this order is that of *Anas* or ducks proper. The common tame duck is derived from *A. Boschas*, or Mallard, a species common to Europe and North America, which is occasionally crossed with *A. Moschata*, the Muscovy duck. This last belongs more properly to a different genus—that of *Cairina*—and is of considerable value in the poultry-yard."



THE CRESTED CURASSOW.

We will now give a history and description, with illustrations, of several species and varieties, some of which have been partially reclaimed, and are susceptible of domestication.

#### THE CURASSOW.

The Curassow, known here as the Mexican Pheasant, are all natives of Mexico, South America, etc., and many approach the common turkey in size. The Crested Curassow, which our figure illustrates, is a native of the forests of Mexico, Guiana, and Brazil; in Guiana particularly it is so abundant that Sonnoni regards it as an unfailing source of supply to the traveler who has to trust to his gun. These birds congregate together in large troops, and are so unsuspecting that they will remain quietly perched on the branches of trees while the gun makes havoc among their numbers. In districts, however, which are well frequented, they are more shy and mistrustful, ever keeping on the alert to avoid pursuit of the sportsman. They build large nests in the trees, constructing them with

sticks and long herbage, and lining them with grasses and leaves. The eggs are from five to eight in number, and resemble those of a fowl, but have a thicker shell, and are of a larger size. Their flesh, in delicacy and whiteness, surpasses that of the fowl or pheasant.

This species has been bred in Holland, and is common in a domestic state in the Dutch settlements of Berbice, Essequibo, Demerara, and elsewhere, and requires but little care. In aviaries, we are informed, it suffers, as do the rest of the group, from wet or dampness, which occasions mortification and consequent loss of the toes. Plenty of room, a dry soil, and trees on which to perch, and a sheltered situation, are essentials in all endeavors to naturalize this valuable bird. The Crested Curassow is as large as a moderate-sized turkey. The tail is ample, and composed of stiff feathers. With the exception of the abdominal region, which is white, the whole plumage is rich black with a gloss of green. The cere and skin round the eyes are light yellow. The crest consists of



THE GALEATED CURASSOW.

feathers about three inches long, curled forward, of a velvety appearance, and capable of being raised or depressed at will. In several species, as in the Galeated Curassow, the Guan, the Razor-billed Curassow, and others, the wind-pipe makes one, two, or even three deep folds between the skin and muscles of the breast before passing into the cavity of the chest. Berries and various sorts of grain constitute the food of these birds, and they are remarkable for tameness, becoming easily domesticated.

"In many parts of South America," says Mr. Bennett, "these birds have long been reclaimed; and it is really surprising, considering their extreme familiarity of manners, and the facility with which they appear to pass from a state of nature to the tameness of domestic fowls, that they have not been introduced into the poultry-yards of Europe. That with proper treatment they would speedily become habituated to the climate, we have no reason to doubt; on the contrary, numerous examples have shown that they thrive well even in its northern parts, and

M. Temminck informs us that they have been, once at least, thoroughly acclimated in Holland, where they were as prolific in the domestic state as any of our common poultry. The establishment, however, in which this had been effected was broken up by the civil commotions which followed in the train of the French Revolution, and the results of much labor lost by its complete dispersion."

## THE GALEATED CURASSOW.

The variety known as the Galeated Curassow frequents, in flocks, the forests of Mexico, and perches on trees, but, as is stated, makes its nest on the ground; and the young are led by the female parent in the same manner as a hen leads her brood. The young are at first fed with worms, larvæ, and insects, and afterward pick up grain, fruits, berries, etc. Like the Crested Curassow, this species is easily domesticated, and is one of those which bred in Holland in the menagerie of M. Ameshoff. Its size is that of a small turkey. Head and neck covered with



THE CAPERCAILLIE, OR COCK OF THE WOOD.

short velvety feathers of a deep black; all the rest of the plumage, with the exception of the feathers of the abdomen, which are white, are black with a gloss of green; tail tipped with white; legs red; bill bright red.

All the *hocos* or Curassow (*crax*), which are derived from their native forests of Guiana, readily unite with one another, giving rise to a progeny that is reproductive without end. "It is probable," observes a judicious ornithologist, "that if the intercourse were repeated in a variety of ways, it would be possible to cultivate, by suitable care, many different races of these birds, whose descendants might be susceptible of multiplying, *ad infinitum*, and branching out into a number of singular varieties, under the superintendence of man.

"In fact, the Dutch menageries have already obtained the prolific hybrids of these species (*crax alector*, *c. rubra*, and *c. globicera*); and it has been observed that these mixed birds have their plumage more varied and far more agreeable to the eye than the uniform livery of the adult individuals of the pure race."

Here, then, we have a family of wild birds, recently reclaimed from their native forests, so

as to leave us no possible question of their origin and specific diversity; and by intermixing these species in a state of domestication, we have passing under our eyes, as it were, the identical series of phenomena—those very same changes which are so remarkable and familiar in the common fowl.

#### THE CAPERCAILLIE, OR COCK OF THE WOOD.

This bird is common in most parts of North-western Europe, and was once to be found in Scotland and Ireland. The male is a large bird, almost equaling a turkey in size, but the female is considerably smaller. In the early spring, before the snow has left the ground, this singular bird commences his celebrated "play." This play is confined to the males, and usually takes place in the early dawn of day to sunrise, or from a little after sunset until it is quite dark, and intended to give notice of their presence to the females who are in the neighborhood. "During the play," says Lloyd, "his neck is stretched out, his tail is raised and spread like a fan, his wings droop, his feathers are ruffled up, and, in short, he much resembles in appearance an angry turkey-cock. He begins his play



with a call something resembling *Peller, peller, peller!* these sounds he repeats at some little intervals, but as he proceeds they increase in rapidity, until at last, and after perhaps the lapse of a minute or so, he makes a sort of gulp in his throat, and finishes with sucking in, as it were, his breath.

"The play of the capercaillie is not loud, and should there be wind stirring in the trees at the time, it can not be heard at any considerable distance. Indeed, during the calmest and most favorable weather, it is not audible at more than two to three hundred paces.

"On hearing the call of the cock, the hens, whose cry in some degree resembles the croak of the raven, or rather, perhaps, the sounds *Gock, gock, gock!* assemble from all parts of the surrounding forests. The male bird now descends from the eminence on which he was perched to the ground, where he and his female friends join in company. The capercaillie does not play indiscriminately over the forest, but he has his certain stations for his playing-grounds. These, however, are often of some little extent. Here, unless very much persecuted, the song of these birds may be heard in the spring for years together. The capercaillie does not, during his play, confine himself to any particular tree, as Mr. Nilsson asserts to be the case, for, on the contrary, it is seldom he is to be met with exactly on the same spot for two days in succession."

The female makes her nest upon the ground, and lays from six to twelve eggs; her brood keep with her till the approach of winter, but the cocks separate from the mother before the hens. The food of this bird consists of the leaves of the Scotch fir, of juniper-berries, cranberries, blueberries, and occasionally in winter of the birch. The young are sustained at first on insects, and especially the larvæ of ants. In the male the wind-pipe makes a loose fold, or two curves, before it enters the chest, gaining by this contrivance great increase of length.

The general color of the males on the upper part is chestnut-brown, irregularly marked with blackish lines; the breast glossy, greenish black, passing into black on the upper surface; elongated feathers of the throat black; tail black.

In the female the head, the neck, and back are marked with transverse bars of red and black; the under surface is pale orange-yellow, barred with black. Nilsson assures us that the capercaillie is often reared up in a domestic state in Sweden, and is bold and disposed to attack persons, like the turkey-cock; and both this naturalist and Mr. Lloyd affirm that these birds will breed with due care in confinement; in fact, they give several instances by way of proof. Beckstein states that the cock of the wood will breed with the black grouse, and even with the domestic fowl and turkey.

In the early part of spring the markets of London are supplied with these birds in abundance from Norway, and owing to the rapidity of steam navigation, the birds are almost as fresh as if just shot, opening well for many days. The flesh of the females is excellent.

#### THE GROUSE.

With regard to the true grouse, it is of the moorland and heath, the wild plain and the mountain, the barren rock and the dense pine forests, that they are the respective tenants. Some naturalists class them all, together with the partridges and quails, in one genus *tetra*; others, however, have subdivided this genus into many, but often on very superficial grounds.

The grouse, celebrated for the exquisite flavor of its flesh, inhabits an extensive range of this country; open dry plains, interspersed with trees partially overgrown with shrub-oak, being its favorite haunts. They were formerly found on the bushy plains of Long Island; on the grouse plains of New Jersey; over the whole extent of the barrens of Kentucky; on the rich prairies of Indiana and Illinois. They are common at Moose Fort, on Hudson's Bay; and were found by Lewis and Clarke in crossing the Rocky Mountains, and on the vast and remote plains of the Columbia River.

#### THE RUFFED GROUSE.

This well-known American bird is called partridge in New York and the New England States, pheasant in New Jersey, Pennsylvania, and the Southern States, although neither the partridge nor pheasant is found in America.

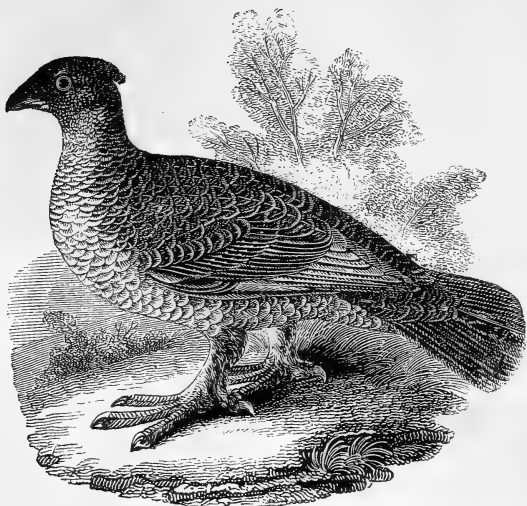

THE RUFFED GROUSE.

The ruffed grouse is known in almost every quarter of the United States, and appears to inhabit a very extensive range of country. Its favorite places of resort are high mountains, covered with balsam, spruce, hemlock, and such like evergreens. It always prefers the woods; is seldom or never found in open plains; but loves the pine-sheltered districts of mountains near streams of water. In the lower parts of Georgia, Carolina, and Florida, they are very seldom observed; but as we advance inland to the mountains they again make their appearance.

The manners of the ruffed grouse are solitary; they are seldom found in coveys of more than four and five together, and more usually in pairs or singly. They leave the woods early in the morning, and seek the path or road to pick up gravel and glean among the droppings of the horses. They also bathe and bask in the fine, dry sand. If the weather be lowering or foggy, they are sure of being found in such situations. They generally move along with great stateliness, their broad, fan-like tail spread out.

The drumming, as it is generally called, of the partridge, is another singularity of this species. This is performed by the male alone. It is a kind of thump, like that produced by two blown-up ox bladders being struck together; the strokes at first are low and distinct, but gradually increase in rapidity until they run into each other. They may be heard in a still day half a mile off, and are produced in the following manner: The bird, standing on an old prostrate log, lowers his wings, erects his tail, contracts his throat, elevates the two winglets or tufts of feathers on his neck, and inflates his whole body somewhat in the manner of the turkey-cock, strutting and wheeling about with great stateliness. After a few manoeuvres of this kind, he begins to strike with his stiffened wings in short and quick strokes, which become more and more rapid, as has been described. This is most common in the morning and evening; and by this means the gunner is led to the place of his retreat.

On being disturbed the bird springs a few yards, with a loud whirring sound, and flies

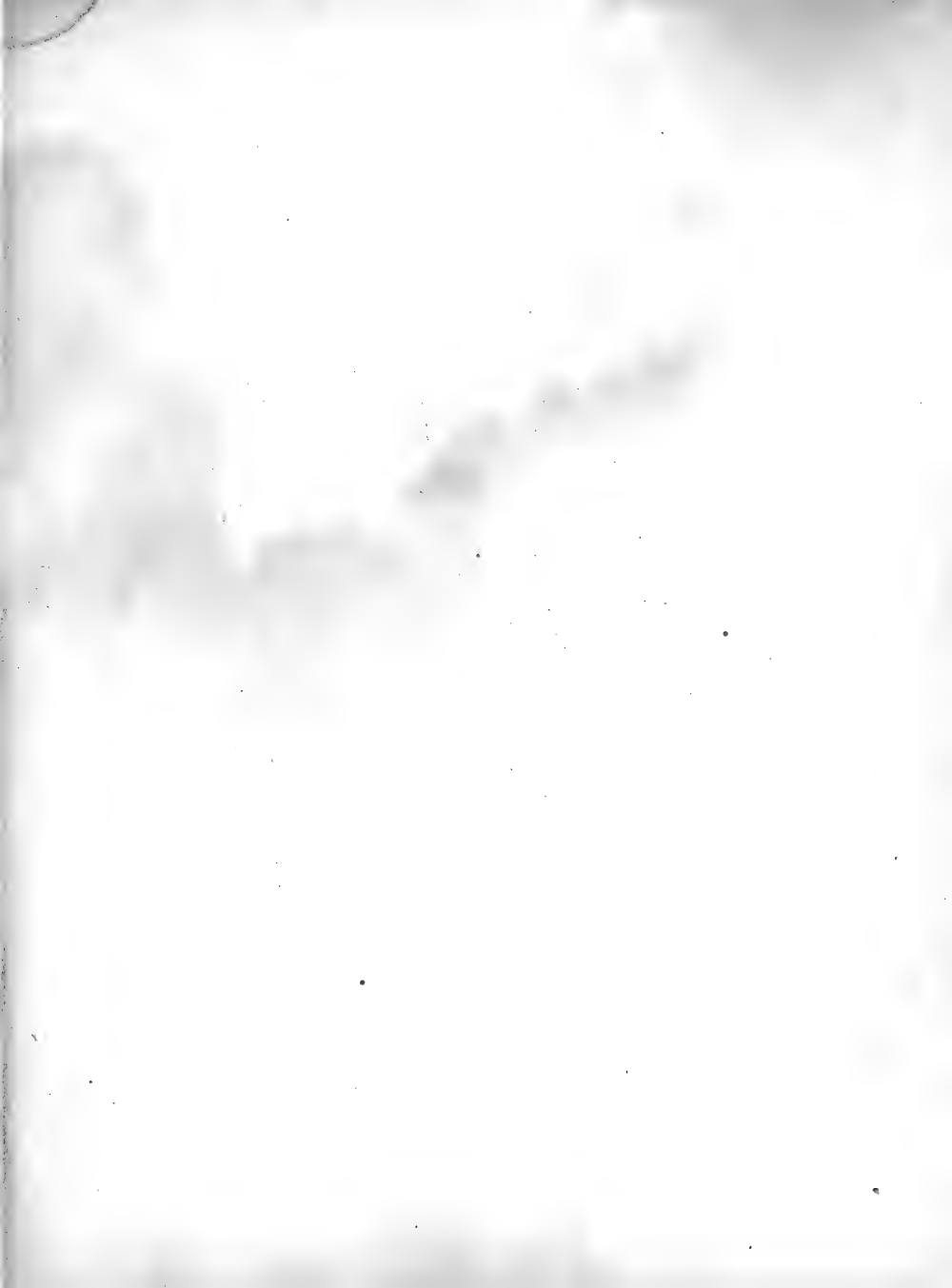



PRAIRIE HEN

LITH. OF ENDICOTT & CO. N. Y.

with great vigor through the woods, beyond reach of view before it alights. They are exceedingly fond of the seeds of grapes, and eat chestnuts, blackberries, and ants. In the fall they feed on various kinds of berries, and on the buds of the birch and apple-tree; the latter often imparting a bitter, disagreeable flavor to their flesh.

The ruffed grouse is eighteen inches long, and in best condition in the months of October and November, when they feed on whortle and partridge berries, the last of which give to their flesh a peculiar and delicate flavor. The general plumage is variegated with transverse markings of black, reddish-brown, and white. The upper parts of the body are of a bright rust color, marked with spots of white. The under parts are white, and the tail beautifully marked with black. There are tufts, or winglets, on each side of the neck, which it occasionally raises, composed of feathers, velvet-black, with green reflections.

The female is paler tinted than the male; the shoulder tufts are smaller, and of an orange-brown. The hen breeds in May, artfully concealing her nest, which is placed on the ground under brushwood, on a tussock of long grass, and formed with little art; the eggs are from ten to fifteen in number, and of a brownish-white. She carefully attends her brood, and, like the partridge of Europe, put various manœuvres in practice, such as fluttering on the ground, as if a wing or a leg were broken, in order to decoy intruders from the place of their concealment.

#### THE PRAIRIE HEN.

This species is known under the various names of grouse, pinnated grouse, heath hen, and prairie hen, in different sections of this country. In the State of New York they are now almost exterminated. The specimen figured was one which was killed on Long Island in 1840, and was probably the last of its race in that district. It is still found in a few of the Atlantic States, in a few of the islands off the coast of Massachusetts, and the mountainous regions of Pennsylvania. They are also said to have been recently seen at

Schooley's Mountain, in New Jersey, and a few are also said to linger about Orange County, New York. They are so readily killed that they soon disappear as the country becomes settled.

These birds are now found in great numbers on the luxuriant plains and prairies of Illinois, Indiana, and the vast and remote plains of the Columbia River; open, dry plains, interspersed with trees, or partially overgrown with shrub-oak, and prairie being their favorite haunts. In these localities they find food and shelter. In severe weather these birds approach barns and farm-houses, mix with the poultry to glean up the scattered grains of Indian corn, and seem almost domesticated. Many are at this time taken in traps, and the gun thins their numbers. Since the introduction of railroads, vast numbers of these delicious birds find their way to New York and other eastern cities, and are highly appreciated by those who are fond of game.

The male of the prairie hen weighs about three pounds and a half. The neck is furnished with a sort of winglet, composed of eighteen feathers, of which five are black, and the rest, which are shorter, black streaked with brown. The head is slightly crested, and over each eye is a semicircular comb of rich orange. During the pairing season, while uttering strange sounds, each strongly accented, the cock exhibits all the ostentatious gesticulations of a turkey-cock, erecting and fluttering his neck-wings, or pointed frills, and passing and strutting before his fellows as if in defiance. Now and then are heard some cackling notes, chiefly uttered by the males while engaged in battle, on which occasion they leap up against each other exactly in the same manner as turkeys, but seemingly with more malice than effect. The males begin their call before daybreak, and continue until eight or nine in the morning, when the parties separate to seek for food.

The hen of this species builds her nest on the ground, under brushwood, or a tussock of long grass, depositing from ten to fifteen eggs, of a dull, brownish color, upon which she sits eighteen or nineteen days. The young form coveys, or packs, which separate on the approach of spring.

*Description.*—Body robust; head, with its

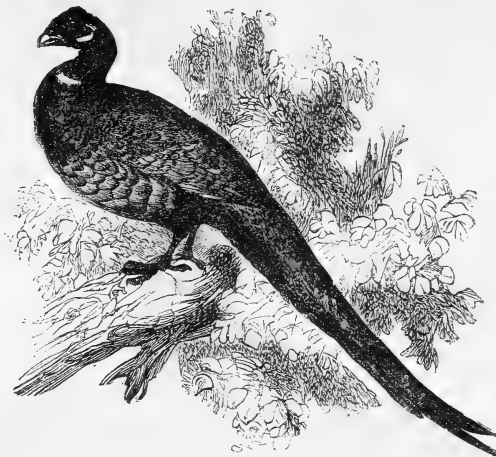

THE PHEASANT.

feathers, somewhat elongated, and forming at pleasure a slight erectile crest; a warty space over the eyes; tail short, rounded, and of a dusky color; head, with the bare space over the eyes, bright scarlet, and the bare space on the neck orange; throat and sides of the head cream-color; a dark, longitudinal stripe under the eye. The general plumage is variegated with transverse markings of black, reddish-brown, and white; breast and under parts brown, transversely marked with white; throat marked with touches of brown.

The female is considerably less than the male, of a lighter color, destitute of the neck-wings, of the naked sacculated appendages, and the semicircular comb over the eye. It feeds on green lichens, buds, clover leaves, and various kinds of berries; buds of the pine, grain, and insects, constitute the food of the prairie fowl.

The prairie hen is said to be easily tamed, and with a little care might soon be domesticated. Coops of these birds have occasionally been exhibited at several of our agricultural and poultry shows, but as yet we have no knowledge of any having been domesticated, although a number of attempts have been made. The

cause, however, may probably have been more from ignorance of their habits, than inattention to their wants. They sell at from 75 cents to \$1 per pair in our markets in the winter.

#### THE PHEASANT.

The so-called English pheasant was originally brought from the banks of the Phasis, a river in Calchis, Asia Minor, and has completely naturalized itself in England. It is a hardy bird, and bears the cold months very well. Although it can be tamed, and will come to be fed with the poultry, yet an innate timidity seems to prevent it from being thoroughly domesticated. Young pheasants that have been hatched under a hen, scamper off in terror if an unexpected intruder makes his appearance among them, although the remainder of the poultry remain perfectly unconcerned.

It is supposed, and believed by some, that the English ring-necked pheasant is a hybrid between the *pheasianus colchecus* and *p. torquator* of China. This cross is very prolific, and is said to be spreading faster than the ordinary breed.

Of the time of the introduction of the pheasant into England we have no positive evidence.

As early as 1299 it is mentioned as worth foppence, and two hundred of them made part of the great feast of the Archbishop of Neville, about the middle of the fifteenth century.

Of the habits of these birds in a state of nature we know little, and yet have no reason to doubt their similarity to those exhibited in their present half domesticated state in Europe and this country.

They are now found in preserves, woods with a thick undergrowth of brush, brambles, long grass, etc., interspersed with open glades, which some little stream refreshes and the sun enlivens, and which are their delight during the day, and from which they run, morning and evening, to the open skirts, where some favorite food abounds. It is in their way to such feeding-grounds that they are so easily secured by unscrupulous persons; for, never taking flight unless disturbed, they run and thread their way through these tangled brakes, and leave passages which are easily distinguished by the practiced eye of the poacher. During the winter the pheasant goes regularly to roost; but in the summer, and when moulting, they do not tree, but squat among the long grass, offering themselves in this way an easy prey to another class of enemies, as polecats, foxes, etc.

The males, in general, associate among themselves during the winter, and separate from the females. They come together again about the first of March, when the male assumes an altered appearance; the scarlet of his cheeks, and around his eyes, acquires additional depth of color; he walks with a more measured step, with his wings let down, and with his tail carried in a more erect position. Being polygamous, he now takes possession of a certain *beat*, from which he drives away every male intruder, and commences his crowing, attended with a peculiar clapping of the wings, which answers as the note of invitation to the other sex, as well as of defiance to his own.

We quote the following from Mr. Nolan, a writer in the *Poultry Chronicle*: "The pheasant is not only beautiful to the eye, but most delicate when served to the table. Its flesh is considered the greatest dainty. No matter with what care they have been bred or propagated,

they disdain the protection of man; and shelter in the thickest coverts and remotest forests. All others of the domestic fowl submit to the protection of man, but the pheasant never has, preferring the scanty produce of acorns and berries to the abundant supply of a farm-yard. The hen pheasant, in a wild state, hatches and brings up her brood with patience, vigilance, and courage; but when kept tame she never sits well. A substitute must be found in the clean, smooth-legged Bantam, the larger fowl being too heavy for the chicks. Her time of laying is about the middle of April, and, if in an aviary, the eggs should be immediately removed, and placed in dry bran or chaff, until you wish to set them. They are about twenty-four days coming out. After the young ones appear, they are not to be fed for twenty-four hours, after which give them hard-boiled eggs, chopped fine, and mixed with oatmeal, ant-mould, cheese, curd, lettuce cut fine, with flour wetted with milk, bread-crumbs, bread and milk, with very limited drink. Be particular to preserve them from cold and moisture. You have to confine the hen, so as to prevent her from eating their food; and you will have to provide them with maggots.

"In the neighborhood of Paris, where they rear large quantities of fowls for the market, they prepare what they call a *vermineer*, by digging a hole in a dry, sandy spot, in which they place a piece of flesh, which soon gets into maggots, with which they feed the young birds. My own *vermineer* is of much simpler and economic construction. I have an earthen pan, about two feet deep, and one foot in diameter, into which I put some bran; on this I place a piece of liver or carrion. I cover it with a common glass cap, and place it in the sun. The flesh soon gets fly-blown, and speedily creates quantities of maggots, and, with a long-handled spoon, I have thrown them to the young birds. They should not get more than one feed of these in the day. The more varied their food, and the more frequently renewed, the better. A little at a time, and fresh. The green leaves of barley are excellent. At three months old, feed them on barley with a little wheat, boiled carrots, or potatoes, mixed with bread-crumbs.

Give a small portion of boiled rice during the mout. If they should get the roup, give them fresh curd every day; a little curd and ants' eggs should be given to them twice a day in addition to their other food. Keep their vessels clean; and, if the disease still continues, give them every second day a small dose of garlic in a little fresh butter. They are subject to be vent-bound, which, if not attended to, will kill them. To remedy this take a pair of sharp scissors, cut close the down or feathers about the vent, and anoint it with sweet-oil, and be attentive that it be kept clean, otherwise you can not rear them; but in handling them, be particularly cautious that you do it with the greatest delicacy, as the least rough treatment will kill them. If they have a scouring the curd will cure it."

Although it is rather difficult to effect a cross between the pheasant and our domestic fowl, it has nevertheless, in several instances, been done; but beyond a first cross, the thing is generally regarded as impracticable. Poultry have been kept on the borders of a wood abounding with pheasants, and occasionally a few half-breed birds are procured. We will enumerate some of them. Sir William Jardine had a specimen of the cross in his possession, exhibiting all the mixed characters in perfection. M. Temminck also records a solitary instance of a mule between the female common pheasant and the male golden pheasant, which presented a curious but splendid mixture; all his endeavors, however, to procure a second specimen were ineffectual. The common pheasant breeds also freely with the ring-necked bird, and the offspring is productive; which by some is regarded as a proof that these two birds are identical.

"It is well known," says a writer in an English journal, "that the male pheasant frequently visits the hens in the poultry-yards adjoining preserves (or it may be *vice versa*), and in my own limited experience I know instances in which very good varieties of layers have been obtained by this means. In the autumn of 1846 I saw a large flock of poultry in a farm-yard close to a preserve of Lord Hatherton's, which was well stocked with pheasants, and the results of the cross between these birds and the

domestic fowls were very obvious. The poultry had originally been a mixed variety, bearing no resemblance whatever to the pheasant breed. In the cross to which I refer, the male birds generally show the greatest resemblance to the pheasants, and in one or two instances that I have noticed, the plumage was strictly similar to that of the cock pheasant."

We are informed, on the best authority, that many of the birds which compose the gallinaeous order appear to be less difficult to be brought to unite with strange species, than those of any other. From the great majority of pheasants, mongrels may be thus produced.

#### THE COCK OF THE PLAINS.

This species, which is a native of the barren, arid plains along the River Columbia and the interior of North California, appears to have been first recorded by Lewis and Clarke, and has been described by Mr. Douglass, who found it among the Rocky Mountains. From the slender form of the quill feathers of the wings and those of the tail, the flight of this species is slow, unsteady, and accompanied by a whirring sound. "When startled," says Mr. Douglass, "the voice—'Cuck, chuck, cuck!'"—is like that of the common pheasant. They pair in March and April. Small eminences on the banks of streams are the places usually selected for celebrating the weddings; the time generally about sunrise. The wings of the male are lowered, buzzing on the ground; the tail spread like a fan, somewhat erect; the bare, yellow œsophagus is inflated to a prodigious size—fully half as large as his body—in marked contrast with the scale-like feathers below it on the breast and the flexible silky feathers on the neck, which on these occasions stand erect. In this grotesque form he displays, in the presence of his intended mate, a variety of attitudes. His love-song is a confused, grating, but not offensively disagreeable tone—something that we can imitate, but have a difficulty in expressing—'Hurr, hurr-hurr-hurr-r-r-r-h,' ending in a deep hollow tone, not unlike the sound produced by blowing into a large reed. The hen builds her nest on the ground, under the shade of pursia and artemisia, or near streams, among *Phalaris arundi-*





CALIFORNIA PARTRIDGE.

naca, carefully constructed of dry grass and slender twigs. Eggs, from thirteen to seventeen, about the size of those of the common fowl, of a wood-brown color, with irregular chocolate blotches on the thick end. Period of incubation, twenty-one to twenty-two days. The young leave the nest a few hours after they are hatched. In the summer and autumn months these birds are seen in small troops, and in winter and spring in flocks of several hundreds."

## CALIFORNIA PARTRIDGE.

This beautiful species is common in the low woods and plains of California, where it was discovered by the unfortunate La Perouse, and, according to the editor of his voyage, was found in flocks of two or three hundred; the birds were fat, and well-flavored. Several living specimens were procured by Captain Beechy, with a view of being brought or carried to England, where it was hoped the species might be domesticated, or naturalized; but, unfortunately, the plan was defeated by the death of the fe-

males on the passage. The males were presented to the Zoological Society, and one of them lived for a considerable time.

Specimens of the California partridge or quail had, however, been previously carried to England by Mr. A. Menzies, who accompanied Vancouver in his expedition round the world, and were described by Shaw and Latham.

Several specimens of this beautiful bird were brought to New York a few years since by a citizen on his return from California, with a view of domesticating them.

In manners these birds closely resemble those of the partridge or quail, but hold themselves more erect; the graceful crest on the head adding much to their appearance. The general plumage is a dusky slate color; the crest, which is bent forward, is black, as is also the throat, encircled by a belt of white. The feathers at the back of the neck are small and triangular, of a slaty hue, with a narrow black margin and white tip. The female has but little crest, and the general tone of the coloring is browner and



THE GREAT BUSTARD.

more obscure. The figure is stout; length about nine inches.

#### THE GREAT BUSTARD.

This bird, although formerly tolerably common in England, is now scarcely ever seen there. It runs with great rapidity, and will never rise on the wing until forced, so that instances have been known of bustards being captured by greyhounds. It is exceedingly wary, and can hardly be approached within gun-shot, except by adopting some disguise—as of a laborer, with a gun in his wheel-barrow, or by driving a

cart or a carriage by the spot where it is feeding.

The male bustard possesses a membrane pouch on the fore-part of the neck, capable of holding six or seven pints of water. There is an opening to this pouch under the tongue, and its use is possibly, like that of the pelican, to carry water for the use of the young, but this is not ascertained. The length of the bird is rather more than three feet. Its nest is a loose heap of straw in the ground, and contains two pale-brown eggs, spotted with darker brown, rather larger than those of the turkey.

## CHAPTER XIX.

## POULTRY STATISTICS.

VERY few persons are aware of the enormous quantity of eggs consumed. It has grown to be a very important branch of business in this country as well as in Europe.

The annual consumption of poultry and small game in the city of Paris usually amounts to more than 22,000,000 pounds. The quantity of eggs used annually in France is said to exceed 7,250,000,000, of which enormous number Paris uses about 120,000,000.

The importation of eggs from Ireland in 1837, to Liverpool and Bristol alone, amounted in value to £250,000. The importation from France the same year was probably greater.

"It appears," says M'Culloch, "from official statements, that the eggs imported from France into England amount to about 60,000,000 a year; and supposing them to cost, on an average, fourpence per dozen, it follows that the people of Brighton (for it is to that place they are almost all imported) pay £23,000 a year for eggs; and suppose the freight, importer's and retailer's profit, duty, etc., raise their price to the consumer to tenpence per dozen, their total cost would be £213,000."

The number of eggs imported into England from various parts of the Continent, in 1839, was 83,745,723, and the gross amount of duty received for the same was £29,111.

"When we look," says M'Queen, "at the immense number of eggs brought from Ireland (50 tons of eggs, and 10 tons of live and dead poultry, having been shipped from Dublin alone in one day), and 66,000,000 eggs imported from France to London alone; and this immense number a trifle certainly to what are produced in this country [England], we shall cease to wonder at the large capital (£8,000,000)

invested in poultry of all kinds. The quantity of eggs imported into Liverpool from Ireland, in 1832, was 4097 crates, value £81,940 sterling; which, at sixpence per dozen, gives 3,297,600 dozens of eggs, and the number 39,331,200. In 1833 the import had increased to 7851 crates, or upward of 70,000,000. The number imported into Glasgow from Ireland in 1835, by the custom-house entries, was 19,321 crates, which, at nine eggs to the pound, gives the number 17,459,568."

Every where in France, it is stated, poultry is abundant and cheap, and eggs form an important article of diet. M. Legrand, a member of the French Statistical Society, says, "The consumption of eggs in Paris is calculated at 115½ eggs per head, or 101,052,400. The consumption in other parts of France may be reckoned at double this rate, as in many parts of the country dishes composed of eggs and milk are the principal items in all the meals. The consumption of eggs for the whole empire, including the capital, is estimated at 7,231,160,000: add to this number those exported, and those necessary for reproduction, and it will result that 7,380,925,000 eggs were laid in France during the year 1835."

The exportations from France in the same year were as follows:

To England .....	76,190,120
To Belgium .....	60,800
To United States (1) .....	49,696
To Switzerland .....	49,260
To Spain .....	34,800
To other parts of the world .....	306,304

It will be seen by the foregoing that the whole number of eggs exported from France in that year was 76,689,800. The total amount

of which was 3,829,284 francs (\$76,800). France is essentially a fowl-keeping and egg-producing country. The farms, owing to the subdivision of landed-property among the sons of a proprietor at his decease, are small, and poultry constitutes a profitable stock upon them, especially as they will feed but few cattle. Around every farm-house flocks of poultry are to be seen. They swarm every where, and the markets of every town are abundantly supplied. Much *breed* does not exist in any of them, but in some parts considerable attention is paid to their rearing. There is said to be a peculiar variety in great esteem in the peninsula of Caux. The fowls of this district are fattened in the environs of Barbezieux, La Flèche, and especially Mons, for the tables of the luxurious.

The following interesting statistical remarks are taken from a paper in the "English Penny Magazine" for March, 1837. After premising that in the year 1837 the number of eggs imported from France into England amounted to 69,000,000, the writer says, "These eggs can not be obtained from much fewer than 575,000 hens, each hen producing 120 eggs on an average, all beyond this number being required for domestic consumption. Assuming the grounds of this calculation to be correct, the 55,000,000 eggs, which a writer in a newspaper printed at Arras states to be the amount supplied to England from the Pas de Calais, are the production of 458,333 fowls, each of which furnishes ten dozen eggs, imported at a duty of tenpence, being a tax to that amount on each fowl. Allowing twelve fowls to each family engaged in supplying the demand for eggs, the number of families thus interested will be 39,861, representing a population of 198,000. In the Pas de Calais there can scarcely be a larger population than two families out of every five who are connected with the egg-trade; and if this were ascertained to be the real proportion, the population not directly engaged would be 457,000, which with the 198,000 above mentioned would comprise a total population of 665,000, which is the population of the department, the superficies of which being 2624 square miles. Over this extent of country must those who are engaged in the egg-trade keep a vigilant eye,

penetrating into the hamlet, and visiting the lone houses which are scattered in this part of France, perhaps more numerous than in any other departments. Some arrangements of a peculiar nature are obviously required to facilitate the transactions of the wholesale dealer, who probably resides at the port whence the eggs are shipped. The services of a subordinate class of dealers are doubtless called into activity; and as it would be a waste of time for each of these to visit every week, or at a stated period, every one of the 39,861 houses whence they draw the quantity required, other arrangements of a still more detailed character are necessary in order to bring the article within grasp."

The British census returns for 1841 present us with an *ad valorem* estimate of the poultry (of all sorts) kept in Ireland, the pecuniary value of each fowl being reckoned at the small sum of sixpence. This census, however, is only an approximation to the truth; for it is stated, on good authority, that the country people were not unnaturally suspicious of the intentions of the parties employed to ascertain the point in question, and apprehending that the inquiry was only the prelude to some new tax, they gave such statements as seemed most advantageous to their interests; hence their returns were below the mark numerically, and consequently, also, in a pecuniary point of view. The returns were as follows:

Leinster, 12 towns.....	£56,243
Connought, 5 towns.....	35,216
Munster, 6 towns.....	62,830
Ulster, 9 towns.....	47,883

The total, according to this estimate, is £202,172. Hence the number of poultry returned amounted to 8,088,680, reckoning them at sixpence per head; but, as stated above, this number is far below the mark.

The value of eggs shipped from Dublin to Liverpool and London in 1848 was more than five millions of dollars. France in 1835 had 73,000,000 dollars invested in poultry. England in 1840 had 50,000,000 dollars invested in poultry. Since that time the numbers, of course, have increased.

From the custom-house returns of the year

1838, it appears that eggs were imported into England (though loaded with heavy duties) from the Continent to the value of more than a million dollars.

"In 1835 the value of eggs exported from Ireland to Great Britain was £68,687, and at the present time may exceed £100,000. [Mr. McCulloch says the price paid by England to Ireland for eggs and poultry may be estimated at from £200,000 to £300,000 a year.] At fourpence per dozen the number of eggs which this sum purchases would be 72,000,000. From France and Belgium there were imported, in the year 1840, 96,000,000, on which the duty of 1*d.* per dozen produced £34,000. In the last three years the importations of foreign eggs were: In 1842, 89,548,747; in 1843, 70,415,931; in 1844, 67,487,920."

Richardson, in his little work on "Domestic Fowls," published in 1847, says, "I have had a statement furnished me by Mr. P. Howell, Secretary of the City of Dublin Steam-packet Company to the following effect: 'The number of boxes of eggs shipped by that Company's vessels for London, during the years 1844-45, was 8874; about the same number was shipped by the British and Irish Company, making a total of 17148 boxes. Each contained 13,000 eggs; but occasionally large boxes are used, containing more than four times that number. This gives the result of 23,072,400 eggs as annually shipped for London. To Liverpool were shipped 5135 boxes, containing 25,566,500 eggs, making a total of the shipments from Dublin alone, during the years 1844-45, to the two ports of London and Liverpool, of 48,639,900, the value of which, at the average rate of 5*s.* 6*d.* per every 124 eggs (the return made), gives a sum amounting to about £125,500 as the annual value of the eggs shipped from Dublin alone; and since this return the export of eggs has enormously increased. Assuming the export of Dublin to be equal to one-fourth of the exports of all Ireland (a calculation reaching much above the mark), we have very close on £500,000, or half a million, as the value of this branch of commerce to Ireland, showing also an increase of four-fold since 1835.'" The same writer adds in a note: "By the same returns I have ascer-

tained that the export of eggs is now nearly doubled, bordering on a million sterling."

A writer in the "Quarterly Review" gives some very useful information in regard to the rearing of poultry and eggs, but confines his observations to London alone: "There can be no doubt that the trade is a very valuable one, and it is much to be regretted that our farmers (who, by keeping poultry, admit the necessity of such stock on a farm) should throw away so great a source of profit. The following figures will show that the trade is very considerable. They refer only to the quantities brought into two of the principal markets of London, and are as follows: Eggs, 75,000,000; fowls, 2,000,000; turkeys, 100,000; ducks, 300,000; geese, 100,000; pigeons, 400,000.

"In addition to these quantities, the vast amount sent to poulterers and private houses must be considered. It is difficult to say what proportion of this comes from abroad, but the fact that 60,000,000 eggs are imported annually from France, and that the Brighton Railway alone carries yearly about 2600 tons of eggs brought from Belgium and France, are fair indications as to the rest."

The rearing and keeping of poultry has become a very important branch of rural economy. Until quite recently the subject, in this country, attracted little or no attention. Many at first viewed it as too insignificant to merit consideration. This is quite natural. Little things are frequently treated with contempt, although in the aggregate they assume magnitude surpassing credulity. This is so, literally, with poultry. Because a fair stock of fowls can be bought for two dollars or so, they are regarded as beneath the rank that entitles them even to kind treatment, more especially if viewed in connection with expected remuneration. But although the winter stock of hens on a common farm may be estimated at two dollars only, the fair valuation of these hens in the country gives them a commercial importance ranging with some of our best products.

In the absence of general statistics we must take isolated ones, and from them draw general conclusions; and it is believed that we shall be able to satisfy the reader that the culture of

poultry is of much more importance in this country than generally imagined; and that, consequently, it should become one of the first objects of attention with every family in the country.

The census of 1840 reveals the fact, and fixes the value of the poultry of the United States at that time to be about \$13,000,000. This we do not regard as unreasonable, as it only amounts to about fifty cents for each person. And this was sixteen years ago. Still, it is a very important item, and one which has been rapidly increasing ever since; and yet the markets are not sufficiently supplied with *good* poultry, while there is a constant scarcity of eggs, except, perhaps, in the months of April and May.

The whole amount of eggs yielded in a year we will suppose to be 480,000,000 dozen, that is nineteen dozen for each individual in the country to be used in a year, or a fraction more than four eggs a week for each person, or, in a family of six persons, an average allowance of two dozen a week. This is a moderate allowance, for in France the annual consumption of eggs is 8,000,000,000, being about twenty dozen to each person; and in Paris alone, the annual consumption is 140,000,000. We have no means or method of ascertaining the quantity of eggs used in New York, Boston, and the other large cities of this country, only as it is well understood that the inhabitants are fond of good fare, and will have it when the means are at command. In evidence of it, statistics show that in Boston the annual consumption, with a population less than 150,000, is to the amount of one million of dollars for poultry alone, and that in New York and its dependencies more than three times that amount is expended for the same article. And it is a fair calculation that nearly one million of eggs are consumed every month in the city of New York. One woman in Fulton market sold 175,000 eggs in ten weeks, supplying the Astor House each day with 1000 for four days in a week, and on Saturday, 2500.

The egg trade of Cincinnati, a few years since, was put down at 25,000,000. It was

stated in one of the public journals, that in one day there were shipped 500 barrels, containing 47,000 dozen of eggs. In May, 1842, seventy barrels, containing seventy dozen each, amounting in number to 58,800, were sent to Boston. One dealer in the egg trade of Philadelphia, sends to the New York market, daily, nearly one hundred barrels of eggs. It is estimated that the city of New York alone expends nearly \$2,000,000 per annum in the purchase of eggs.

By reference to the agricultural table of statistics of 1839, and published in 1840, it will be seen that the value of poultry in the State of New York was 2,373,029 dollars, which was more than the value of its sheep, the entire value of its neat cattle, and nearly five times the value of its horses and mules. It is probable that since then the value of poultry has nearly or quite doubled.

The value of eggs sold in and around Quincy market, in Boston, for 1848, was 1,125,735 dozen, which at 18 cents per dozen (the lowest price paid 11½ cents, and the highest 30 cents per dozen, as proved by the average purchases of one of the largest dealer's books), makes the amount paid for eggs to be nearly 203,353 dollars. And from information already obtained from other egg merchants in the same city, the whole amount of sales will not fall much, if any, short of \$1,000,000 for 1848. The average consumption of eggs at three of the hotels was more than two hundred each day for that year. And the value of eggs brought from the Penobscot and Kennebec rivers for that year, during the running season of the steamboats plying between Boston and those two rivers, was more than \$350,000.

It is stated in a Providence paper, that one sloop has regularly, for twenty-five years, made twenty-five trips a year from Westport, Massachusetts, to that port, during which period she has carried to that market, on an average, 400 dozen of eggs each trip, making altogether a total of 3,450,000, averaging twelve and a half cents per dozen, amounting to \$35,500.









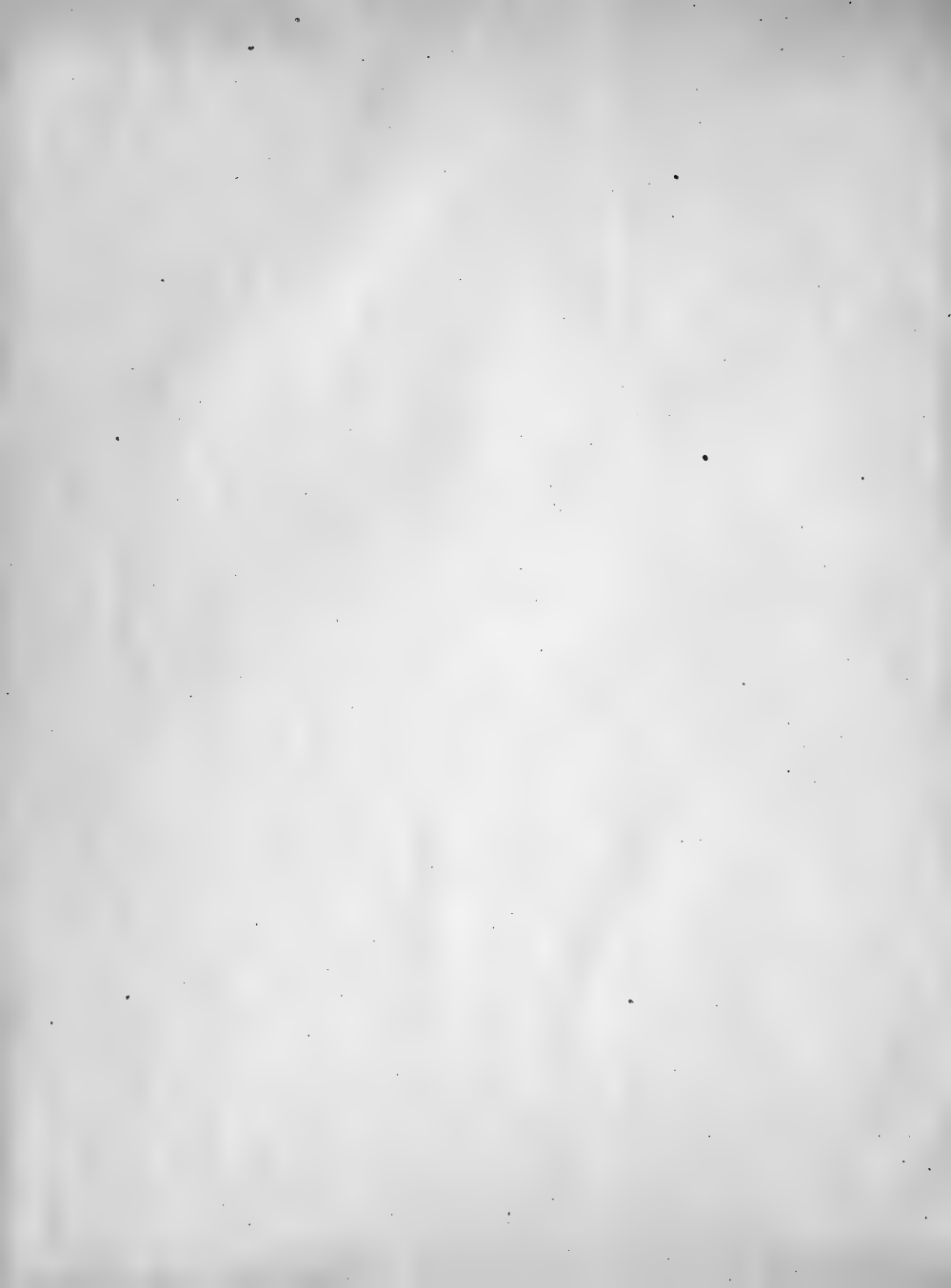



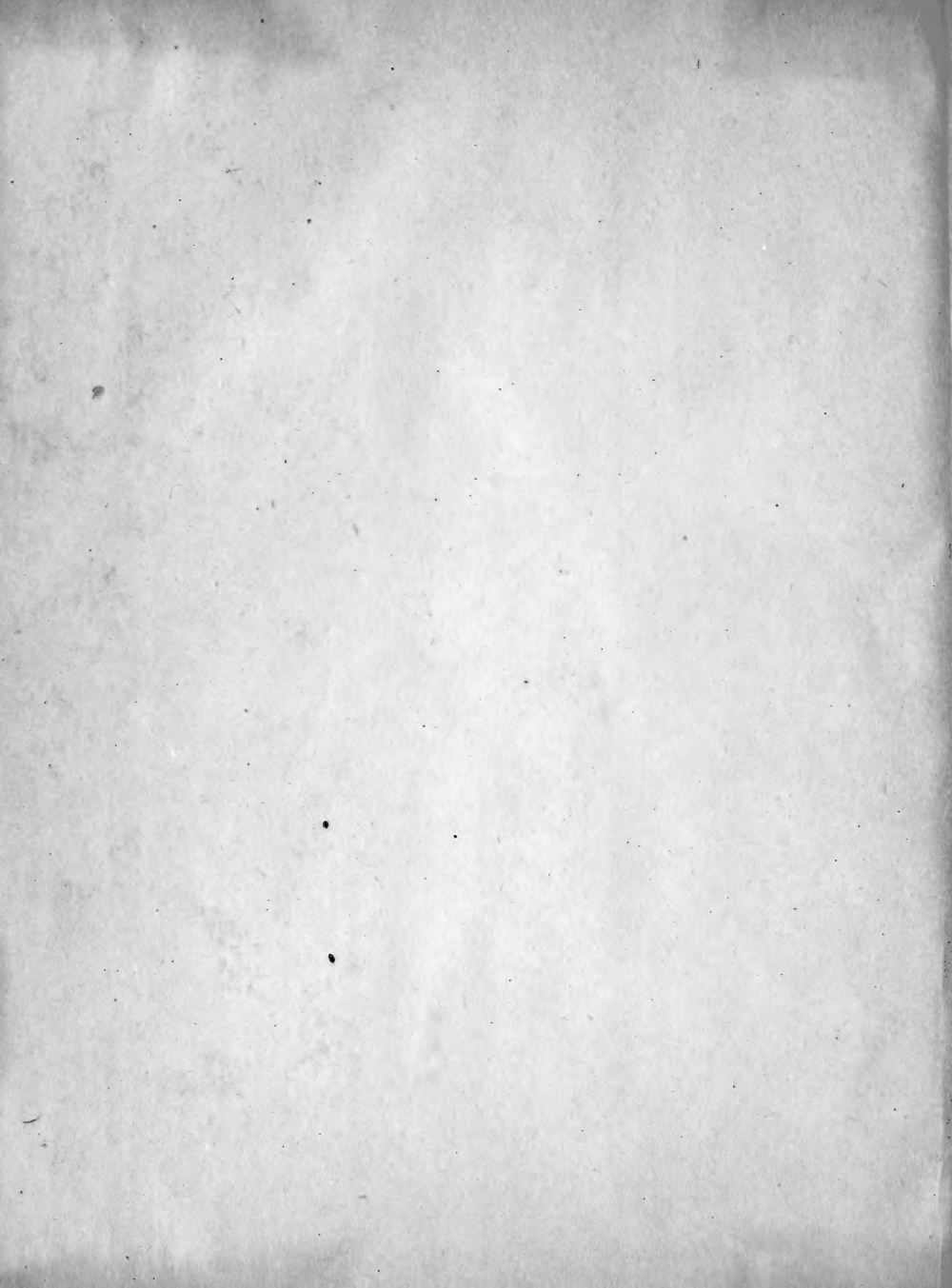

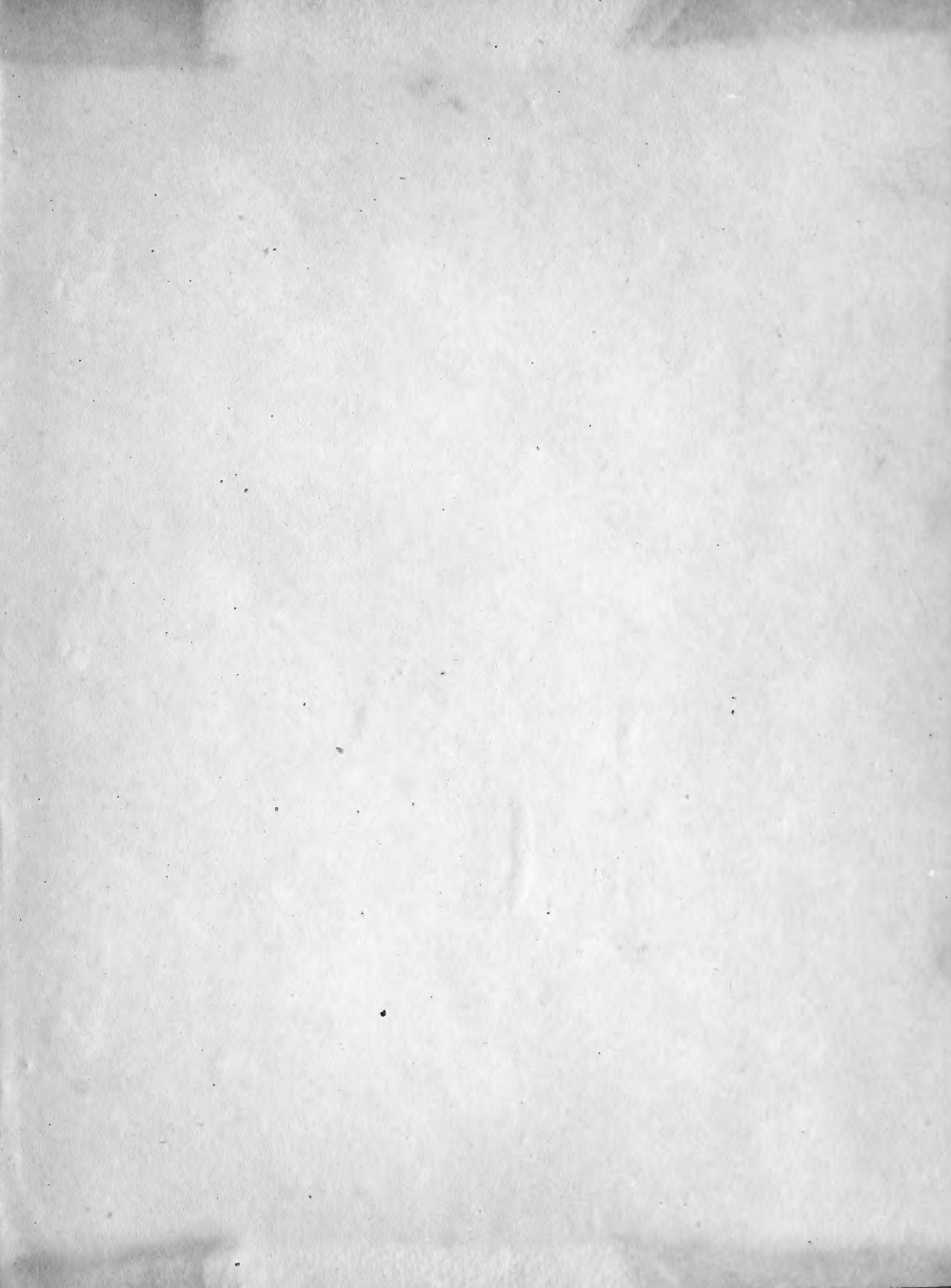

LIBRARY OF CONGRESS



0 002 840 047 0