







98  
P

# ANIMAL KEEPERS' FORUM

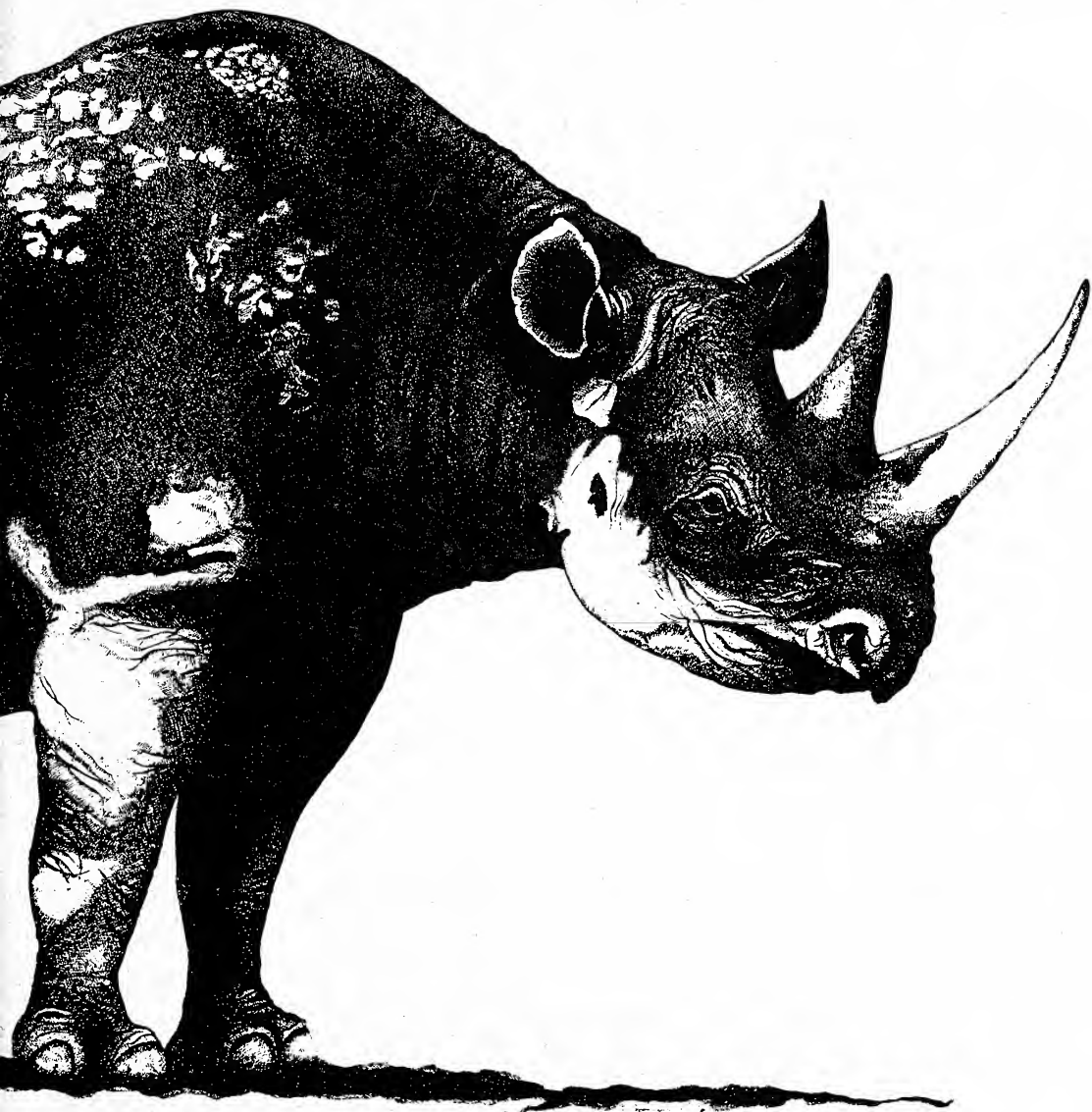

**The Journal of the American  
Association of Zoo Keepers, Inc.**

**JULY 1995**

**ANIMAL KEEPERS' FORUM**, 635 S.W. Gage Blvd., Topeka, KS 66606-2066

Phone: 1-800-242-4519 (U.S.) 1-800-468-1966 (Canada) FAX 913-273-1980

**Managing Editor:** Susan Chan

**Associate Editors/Enrichment Options Coordinators:**

Kayla Grams, Arizona-Sonora Desert Museum & Gretchen Ziegler, Sequoia Park Zoo

**Book Review Coordinators:** Melba T. Brown, National Zoo & Andrea Bernee, Chaffee Zoological Garden

**Legislative Outlook Column Coordinator:** Georgann B. Johnston, Sacramento, CA

**July 1995**

**Vol. 22, No. 6**

Animal Keepers' Forum (ISSN 0164-9531) is a monthly journal of the American Association of Zoo Keepers, Inc. Ten dollars of each membership fee goes toward the annual publication costs of Animal Keepers' Forum. Third Class postage paid at Topeka, KS. Postmaster: Please send address changes to: **American Association of Zoo Keepers, Inc., 635 S.W. Gage Blvd., Topeka, KS 66606-2066 - Attn: Barbara Manspeaker, Administrative Secretary**

**Executive Director:** Ed Hansen, AAZK, Inc.

#### BOARD OF DIRECTORS

Janet McCoy, Metro Washington Park Zoo, Portland, OR 97221-2799

President

Rachél Watkins Rogers, San Diego Zoo, San Diego, CA 92112

Vice President

Mark de Denus, Assiniboine Park Zoo, Winnipeg, Manitoba, Canada

Alan Baker, Burnet Park Zoo, Syracuse, NY 13204-2504

Ric Urban, Houston Zoological Garden, Houston, TX 77030

Marilyn Cole, Metro Toronto Zoo, Toronto, Ontario, Canada

Diane Callaway, Omaha's Henry Doorly Zoo, Omaha, NE 68107-2200

#### COMMITTEES

##### Nominations & Elections

Chair - Maria McManus, Indianapolis Zoo

##### Conservation, Preservation & Restoration

Chair - Brett Sellers, Metro Washington Park Zoo

##### Annual Conferences

Coordinator - Ed Hansen, AAZK, Inc.

##### Awards

Chair - Anna Michel, Metro Washington Park Zoo

##### Exhibit Design Resource Notebook

Michael Demlong, The Phoenix Zoo

AAZK Inspection Standards Manual — Rachél Watkins Rogers, San Diego Zoo

##### By-laws

Rachél Watkins Rogers, San Diego Zoo

##### Ethics

Mark de Denus, Assiniboine Park Zoo

##### Research/Grants

Vacancy

##### Publications Funding

David Luce, Chaffee Zoological of Fresno

##### AAZK Chapter Logo Products

Jay Christie, Cohanzick Zoo, Bridgeton, NJ

#### MEMBERSHIP SERVICES

##### L.I.N.K. Coordinator

Mark de Denus, Assiniboine Park Zoo

##### Zoo University List

Mike Illig, Metro Washington Park Zoo

##### Keeper Accommodations List

Todd Cleveland, Denver Zoo

International Outreach - Jeanette Beranger, Roger Williams Park Zoo (Chair/Coordinator Technical Assistance); Lesa Scheifele, Norwich, CT (Foreign AAZK Members/Sister Organizations); Lois Johannes, L.A. Zoo (Foreign Member Sponsorship Program); Kathy Kelly, National Zoo (Project M.A.R.C. - Making A Realistic Contribution)

Enrichment Committee — Dianna Frisch, Columbus Zoo

##### AAZK Training Materials

Laura Treschel, Continuing Education Coordinator, Minnesota Zoological Gardens

##### Animal Data Transfer Form

Bernie Feldman, Burnet Park Zoo

##### Staff Exchange

Dale Frerking, Kansas City Zoo

##### AAZK Historian

Heidi Fowle, Orlando, FL

#### PRESIDENTIAL ADVISORS

##### AZA Liaison

Ed Hansen, IPP, AAZK, Inc.

##### Bowling for Rhinos

Patty Pearthree, Indianapolis Zoo

##### Elephant Managers Association

Dinah Wilson, Marine World Africa USA

##### CAZPA Liaison

Oliver Claffey, Metro Toronto Zoo

#### AAZK PUBLICATIONS - CONTINUING DATA COLLECTION

##### Zoo Infant Development Project

Teri Maas/Maggie Liguori, Philadelphia Zoo (Birds/Nonpasserines); Kim Livingstone, L.A. Zoo (Passerines)

Jeanne Bocconelli, Newark Museum Mini-Zoo (Reptiles); Linelle Lone, Denver Zoo (Amphibians)

Diet Notebook, Mammals, Vol. II - Susan Bunn Spencer, Grand Rapids, MI



printed on recycled paper with vegetable-based ink products



## ***Table of Contents***

About the Cover/Information for Contributors.....	238
From the Editor's Desk.....	239 - 240
Scoops & Scuttlebutt.....	240
In Memorium ~ Elandra Aum.....	241
Coming Events.....	242
Tawny Frogmouth T-Shirt Order Form.....	244
Message from the President (By-law Revisions and Proxy Ballot).....	245 - 246
Ngare Sergoi Rhino Sanctuary Annual Report.....	247 - 249
The Birth of Samuel.....	249 - 252
Enrichment Options.....	253 - 254
World Rhino Population Estimates.....	254
Chute Restraint of White Rhinoceros.....	255 - 257
Rhino Knife Sharpener Order Form.....	258
Conditioning White Rhino for a Presentation.....	259 - 261
Legislative Update.....	262 - 265
Zimbabwe's Rhinos: Secure at Last?.....	266 - 268
Conference Pre/Post-Conference Trips.....	269
1994 Bowling for Rhino Results and the Ujung Kulon Project.....	270 - 271
The Exhibit Design Resource Notebook Update.....	272
STOP - Husbandry Alerts.....	273 - 274
Chapter News.....	274 - 275
H.O.R.N./NSSG Membership Information.....	276
AAZK Announces New Professional & Contributing Members.....	277
Black Rhino Husbandry and Breeding at the Cincinnati Zoo.....	278 - 279
Ujung Kulon.....	280 - 291
L.I.N.K. List of Regional Coordinators.....	292
Zoo Infant Development Order Form.....	293
Training as a Tool for Routine Collection of Blood from a Black Rhinoceros ( <i>Diceros bicornis</i> ).....	294 - 300
Opportunity Knocks.....	300
Denver Conference Registration/Hotel Forms/Day Rates.....	Center Spread

## About the Cover....

This month's cover features the black rhinoceros (*Diceros bicornis*) which is appropriate since this entire issue is dedicated to the AAZK symbol - the Rhino. All rhino species are endangered across their ranges and many find protection only within the confines of preserves and sanctuaries such as Ngare Sergoi (Lewa Wildlife Conservancy). While some rhino species have made modest population gains since 1970, the black rhino population has fallen from some 65,000 to a 1994 estimate of 1,700. This month's cover art was drawn by Geoff Creswell, a former elephant keeper at the Topeka Zoological Park. Since leaving the zoo, Geoff has worked with chimps for the Jane Goodall Institute in Burundi and the Congo; and most recently for John Aspinall and the Howlett's & Port Lympne Foundation at the gorilla release project in the Congo. Thanks, Geoff!



## Information for Contributors

Animal Keepers' Forum publishes original papers and news items of interest to the animal keeping profession. Non-members are welcome to submit articles for consideration. Articles should be typed or hand-printed and double-spaced. Articles may be submitted on disk by arrangement with the Editor. All illustrations, graphs, charts and tables should be clearly marked, in final form and should fit in a page size **no greater than 5.5" x 8.5"** (14cm x 22cm). Literature used should be cited in the text (Brown, 1986) and alphabetically in the final bibliography. Avoid footnotes. Include scientific name (as per ISIS) the first time an animal name is used. Thereafter use common name. Use metric system for weights and measurements (standard equivalents may be noted in parenthesis). Use the continental dating system (day-month-year). Times should be listed as per the 24-hour clock (0800, 1630 hrs. etc.). Glossy finish black and white photos **only are accepted**. Color slides should be converted to black and white prints (minimum size 3" x 5" [8cm x 14cm]) before submission. Clearly marked captions should accompany photos. Please list photo credit on back of photo.

Articles sent to Animal Keepers' Forum will be reviewed by the editorial staff for publication. Articles of a research or technical nature will be submitted to one or more of the zoo professionals who serve as referees for AKF. No commitment is made to the author, but an effort will be made to publish articles as soon as possible. Lengthy articles may be separated into monthly installments at the discretion of the editor. The editor reserves the right to edit material without consultation unless approval is requested in writing by the author. Materials submitted will not be returned unless accompanied by a stamped, self-addressed, appropriately-sized envelope. Telephone and FAX contributions of late-breaking news or last-minute insertions are accepted as space allows. However, long articles must be sent by U.S. mail. Phone 1-800-242-4519 (US); 1-800-468-1966 (Canada); FAX (913) 273-1980.

**Deadline for each regular issue is the 15th of the preceding month. Dedicated issues may have separate deadline dates and will be noted by the editor.**

Articles printed do not necessarily reflect the opinions of the AKF staff or the American Association of Zoo Keepers, Inc. Publication does not indicate endorsement by the Association.

Items in this publication may be reprinted providing credit to this publication is given and a copy of the reprinted material is forwarded to the editor. Reprints of material appearing in this journal may be ordered from the editor. Back issues are available from the editor for \$3.00 each.



## From the Editor's Desk....

Welcome to the new size and format for *Animal Keepers' Forum!* We have been considering making some changes in AKF for a number of years, and now have taken the plunge and hope you will enjoy the results.

The first issue of AKF was published in November of 1974 and consisted of a mere 3 1/2 pages of mimeographed copy. Back then the AKF was an independent publication and not associated with AAZK. In March of 1975 it did, however, become the official journal of the Association. From its inception the AKF has always carried the by-words "Dedicated to Professional Animal Care".

When I came on Board as Managing Editor in December of 1981, the AKF was averaging 16 pages per issue and was put out on an IBM Selectric I typewriter without a correction key! In 1987 the Administrative Offices moved into the 21st century with the acquisition of Macintosh computers which allowed for greater flexibility and quality in the publication of this journal. We began to average 40+ pages per issue and also experimented with doing issues dedicated to particular species or husbandry topics. In late 1994, AO experienced a computer upgrade which expanded the realm of possibilities and capabilities for all AAZK publications.

Some of the columns which have proven to be popular with the membership will continue. Among these are "Enrichment Options", "Legislative Update", "Chapter News", "Book Reviews" and "Opportunity Knocks". Some columns, including "Births & Hatchings" are currently being evaluated as to their usefulness and readership. Over the past year or so, we have also experienced a decided decline in information submitted for B&H. We feel this may be due to the more strict reporting requirements which we instituted a couple of years ago.

We are also going to experiment with some new column ideas. The first such appears in this issue and is entitled "Husbandry Cautions". The idea behind this column is to provide a forum for the dissemination of information of husbandry practices, diets, etc. which may have caused problems with or danger to captive animals. We invite you to submit information of this nature which may help your fellow professionals avoid possible dangers or hazardous situations with their animals.

We are also hoping to be able to include on a fairly regular basis information on zoo horticulture and how it impacts your job as animal keepers. We are working to increase communication ties with the Association of Zoological Horticulture in order to utilize their resources and expertise in this area. We are grateful to AZH Newsletter Editor Tran Asprodites for his encouragement of this project.

The new size of the AKF also offers us more options in design and we hope to be able to make this publication more visually attractive and interesting for the readership. The addition of a second color will also hopefully add interest and impact to the AKF. We will continue to use keeper-generated art on the cover as we feel this is one aspect of AKF which truly makes it unique. Keeper/Artists interested in submitting artwork for cover consideration are asked to contact our offices for new specifications on size and acceptable mediums.

We also plan to continue to publish several dedicated issues each year. Next month's issue is planned for Hand-Rearing and an issue dedicated to SSPs is in the works for later this year. One thing remains the same - we depend on you, our readers - to help supply the materials published in AKF. We hope that each of you will look for ways in which you can support your professional journal through the submission of articles, Chapter news items, significant birth and hatching information, husbandry or enrichment hints and ideas, etc. Please keep in mind that you do not have to be a professional writer to submit material—if you have the information, we can help you put it together for publication. We hope you will all make it a priority to support AKF and AAZK through your submissions.

We welcome your suggestions and comments. We also appreciate your patience while we continue to learn and explore the possibilities for AKF.

*--Susan D. Chan, Managing Editor*



## *Scoops & Scuttlebutt*

### **Election Results Announced**

The following Professional members have been elected to serve on the AAZK Board of Directors: Diane Callaway, Omaha's Henry Doorly Zoo; Marilyn Cole, Metro Toronto Zoo; David Luce, Chaffee Zoological Gardens of Fresno; and Lucy Segerson, North Carolina Zoological Park. These individuals will serve four-year terms commencing after the Denver Conference. Continuing on the Board will be Janet McCoy, Metro Washington Park Zoo; Alan Baker, Burnet Park Zoo; and Ric Urban, Houston Zoological Gardens. These individuals have two more years to serve in their present terms.

### **Comments Please: To All ADT Form Users**

May I please have your comments on the "Option" heading on the ADT Form? Have you used it, is it necessary, keep it, remove it, etc.? Your input is important to keep the ADT Form as valuable as it is now. Please send comments to: Bernie Feldman, Burnet Park Zoo, 1 Conservation Place, Syracuse, NY 13204; FAX (315) 435-8517. You may also contact me at this address/FAX if you need a supply of ADT Forms for animal shipments.

### **Corrections of Note**

1. Please be aware that in the June Enrichment Options column, the FAX number for the Larson Company in Tucson was listed incorrectly. The correct number is (520) 294-4715.
2. Several grammatical errors appeared in the article by Maria C. Franke (Metro Toronto Zoo) entitled "Early Development Chronology of a Matschie's Tree Kangaroo Through Daily standing Pouch Checks". These were not the author's errors, but rather occurred when the manuscript was typed into the computer. Our apologies to Maria.

# *In Memorium*

*Elandra Aum*  
1947 - 1995

The Puget Sound AAZK Chapter, Woodland Park Zoological Gardens, Seattle, WA, is saddened to announce the death of long-time AAZK member Elandra Aum. Elandra was born 26 November, 1947 in Schenectady, NY and died on 23 May, 1995 in Seattle, WA. Elandra was active in our local Chapter as well as serving AAZK on a national level.

Elandra was a active member of the Puget Sound Chapter and served as one of its first treasurers. She participated and helped out with most major fundraising Chapter activities including our annual "Zoo Bowl" which helped set the stage for "Bowling for Rhinos".

On a national level, Elandra was the originator and first coordinator for the AAZK Staff Exchange Project which serves as an information clearinghouse on formal and informal staff exchanges and working keeper visitations. Elandra worked for several years on the Manual of Resources (now called the AAZK Operations Manual, currently in production). This manual delineates all the policies of the Association. Elandra also served as an AAZK Regional Coordinator for the State of Washington.

Elandra began her zoo keeper career in the early 70's as a volunteer in the old snake house at Woodland Park Zoological Gardens. Over the years she worked in several areas throughout the zoo including Waterfowl, Penguins, Feline House, African Savanna, and as a night keeper on the graveyard shift.

She will be sadly missed by all of us at the Woodland Park Zoo.

In her memory, contributions may be sent to either the International Snow Leopard Trust, 4649 Sunnyside N., Seattle, WA 98103, or the Ngare Sergoi Support Group, Inc. , P. O. Box 29503, Columbus, OH 43229.

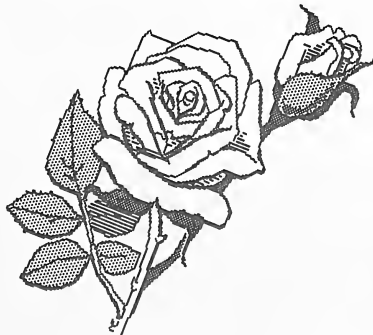

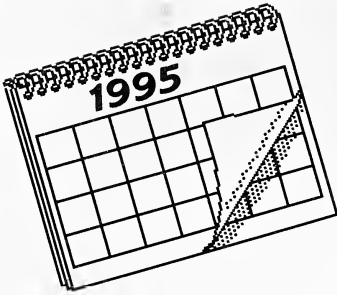

# Coming Events

## **21st Convention of the American Federation of Aviculture (AFA)**

August 9-12, 1995

New Orleans, LA

This year's conference will focus on Central and South American avian species. For more information contact the AFA Business Office at (602) 484-0931.

## **The International Society of Zooculturist Annual Conference**

August 23-26, 1995

Idaho Falls, ID

To be held at the Tautphaus Park Zoo. For more information contact: Bill Gersonde, Superintendent, Tautphaus Park Zoo, Box 50220, Idaho Falls, ID 83405. (208) 528-5552.

## **The 16th Annual Elephant Managers Workshop**

October 10-14, 1995

Tacoma, WA

Headquartered at the Tacoma Inn. For further information contact: Bruce Upchurch or Sally LaTorres, Point Defiance Zoo & Aquarium, 5400 N. Pearl St., Tacoma, WA 98407-3218, (206) 591-5337, ext. 154.

## **Second Annual Conference of the Association of Reptile and Amphibian Veterinarians**

October 26-29, 1995

Sacramento, CA

For conference registration information contact: Wilbur Amand, VMD, P.O. Box 605, 1 Smithbridge Rd., Chester Heights, PA 19017; Fax (215) 387-2165. tel: (410) 656-4256; Fax (410) 576-1080.

## **Association of Zoo Veterinary Technicians 15th Annual Conference**

Oct. 30 - Nov. 2, 1995

Baltimore, MD

To be held at the National Aquarium. Conference will include sessions on reptile, avian, primate, hoofstock and aquatic medicine, immobilization, hematology, clinical and gross pathology, hospital techniques, and case reports. In addition, there will be a wet-lab. For more information contact: Jenni Jenkins, LVT, National Aquarium in Baltimore, Pier 1, 501 E. Pratt St., Baltimore, MD 21202; tel: (410) 656-4256; Fax (410) 576-1080.



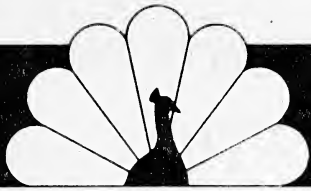

## Quality exotic animal diets

# SPECTRUM

**Nutritionally balanced**  
**Fixed formulation • Economical**

When you need a complete line of high-quality dry and frozen animal diets for your feeding program, call Animal Spectrum.

**NEBRASKA BRAND**



*Frozen feline diets*  
*Frozen bird of prey diets*  
*Frozen canine diet*  
*Chunk and chopped horsemeat, hearts, livers, rib, shank, knuckle bones, and tailbones*



*Banana flavored psittacine/primate, 20% protein, dry*  
*Banana flavored primate, Pro-Plus 25% protein dry*  
*Leaf Eater primate dry*                      *Omnivore dry*  
*Llama Vitamins & Minerals dry*        *Polar Bear dry*  
*Marmoset/Tamarin dry*                    *Ratite dry*  
*Hoofstock supplement, with Selenium dry*

### BROOD-RITE HEATERS

*Bulbless heaters—nothing to break*  
*Safe around all animals and bedding material.*  
*Even heat distribution in 240, 500, or 750 wattages.*

### One call does it all

TOLL FREE **1-800-228-4005**

**FAX 308-534-7015**

*Animal Spectrum, Inc.*  
*P.O. Box 721*  
*North Platte, NE 69101-0721*

TAWNY • FROGMOUTH  
*Podargus strigoides*

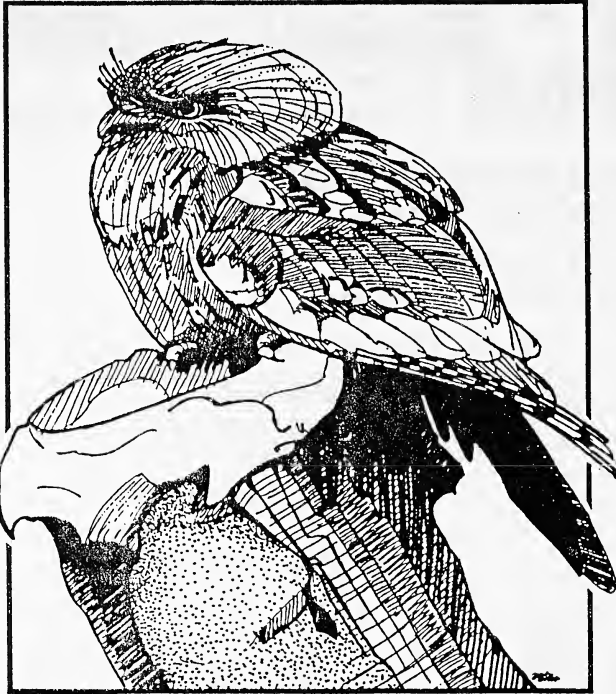

S H E R R I E • Y O R K

The Rocky Mountain AAZK Chapter, Denver, CO is offering T-shirts made especially for AAZK by Sherrie York, internationally known wildlife artist. The price is only \$12.00, plus \$2.00 postage. Please make check or money orders payable to Rocky Mtn. AAZK Conference Committee, and mail all orders to the AAZK Chapter at the Denver Zoo, 2900 E. 23rd Avenue, Denver, CO 80205

-----  
**YES!** I have enclosed \$ \_\_\_\_\_ for \_\_\_\_\_  
of your fine Tawny Frogmouth T-shirts.

Please mail to me at:

Name: \_\_\_\_\_

Address: \_\_\_\_\_

City, State, Zip: \_\_\_\_\_

**Available in X-Lg ONLY!**



# Message From the President

In this issue of *AKF* are the proposed Bylaw changes for the Associate Membership category. The Bylaw Committee has reviewed the Association's Bylaws and made the necessary changes under Article IV, Section 2 and Article VI, Section 1a and Section 2 to comply with Internal Revenue Service rulings concerning membership rights to participate in 501 (c)(3) nonprofit organizations.

I urge you to review the proposed changes and cast a proxy ballot if you will not be able to attend the Association's annual meeting to be held at the Denver Conference.



Janet McCoy, President AAZK  
Metro Washington Park Zoo  
Portland, OR

## NOTICE TO THE MEMBERSHIP Proposed Bylaw Revisions

Please be advised that the following are proposed changes to the AAZK Bylaws. Please note that the revised portions of the Bylaws are shown here in italic typeface. A proxy ballot is available on the following page.

**Article IV, Section 2 - Membership Categories - Associate:**  
“...Associate members *may hold appointed office on a national level and vote or hold elective office on a local level.*”

**Article IV, Section 2 - Membership categories - Contributing:**  
“...This category of membership; unless designated by the contributor as having the qualifications set forth in the Professional, Affiliate *or Associate* membership category, shall not retain the rights of a Professional, Affiliate *or Associate* member...”

**Article VI, Section 1 a. Chair, Coordinator and Advisor Requirements:** A Committee Chair, Coordinator or Advisor may come from among the Professional, Affiliate *or Associate* categories of membership.

**Article VI, Section 2. Standing Committees - Bylaws:** There shall be a Bylaws Committee consisting of a minimum of *five (5) members, two (2) of which shall be members of the Board of Directors.*



# PROXY

(Professional and Affiliate Members Only May Vote - Membership status will be verified at Administrative Offices)

The AAZK Board of Directors and the AAZK By-laws Committee recommend the adoption by the membership of the proposed revisions to the By-laws of the Association. They will be voted on at the General Membership Meeting to be held at the Denver Conference Sept. 24-28, 1995. If you will not be in attendance, you may return this proxy ballot to let your wishes be known. **CHOOSE ONE BELOW.**

.....

I, the undersigned, do hereby designate Janet McCoy, AAZK President, as my Proxy at the 1995 General Membership Meeting of AAZK. I wish my vote to be cast with the majority of members in attendance at the General Membership Meeting.

I, the undersigned, wish to vote against the following By-law revisions.  
(Please list below those revisions you wish to vote against.)

---

---

---

---

---

*(Please Print)*

Name \_\_\_\_\_

Address \_\_\_\_\_

City/State/Zip \_\_\_\_\_

Signature \_\_\_\_\_

Date \_\_\_\_\_

MAIL TO: PROXY BALLOT, AAZK Administrative Offices, 635 S.W. Gage Blvd., Topeka, KS 66606-2066.

**Ballots must be postmarked no later than 15 September 1995**

# Ngare Sergoi Rhino Sanctuary Annual Report



The closing months of '94 have brought to us here more than their usual share of drama and tragedy. It has also been a period of quite incredible natural beauty. The rains, which started late in October, continued for an incredible six weeks and have turned Lewa Downs into a lush green paradise. The dry river bed below my garden became, for a few days, a raging torrent and the sound of the waterfall filled the house with its music. Flowers blossomed in delicate profusion and the bird life is incredible as, at the time of writing, the grass plains are alive with huge flocks of European white storks searching for grasshoppers, and the air is alive with bird and insect song. The less said about the roads the better; they became a nightmare and we were all more or less grounded for considerable periods of time.

This autumn the Natal Parks Board, with considerable generosity, donated 20 white rhinos to the Kenyan Government. We also were the beneficiary of their largesse and received a lovely white female called Natal who has settled in well and joined up with Jagwai and N'Juku. Sungari and Gororika's calves, born May and June, are flourishing on the abundant grazing and eight months after giving birth, Sungari has been mated once more by Makora with her baby plus her previous calf, Lari, in interested attendance. Lari left his mother for seven months after the birth of her new calf and joined up with Marembo and Baraza but on the third week of December he joined her once more.

Tragedy has struck two of our black rhino cows. Twice during November one of our young translocated bulls, Ekili, attacked Narasha and her calf born in late September. Why did this happen? I do not know. Has this sort of behavior been reported in wild populations? Translocated animals sometimes behave in aberrant ways. Recently I read a report that in Pilaanesburg, South Africa young males from a translocated group of elephants attacked and killed ten white rhinos, some of whom had calves that also died. The second time Ekili attacked Narasha, the animals were out on a big black cotton soil plain where, because of the rains, there was no hope of getting a vehicle anywhere near them to try and separate them. With considerable personal courage, Ian took the "Bowling for Rhinos Supercub" and succeeded in driving off Ekili but not before he had seen the calf being flung up into the air by Ekili's horn.

He reported to all of us that the calf had landed with such a crash that he did not believe that it could survive. But it did, though three weeks later a huge swelling had developed under her armpit. These rhinos are the property of the Kenya Government and any mishap that befalls them, natural or otherwise, has to be reported to the K.W.S. Both fights had been reported as was this swelling. The K.W.S. vet came to have a look and decided that it required urgent attention. This, of course, meant that the mother had to be darted in order that her baby could be treated. What no one realized was that she had also been badly wounded in the fight. When the drug took effect and she went down, she died almost at once. The postmortem revealed that in the fight she had

received a severe blow which caused serious internal bleeding and a large clot of blood had lodged in the main artery of one lung. The lung had consequently filled with liquid. She fell on the side of the good lung and asphyxiated.

The pathetic little calf was delivered to me in the back of a truck together with Dryan, the tracker who had such an extraordinary relationship with the dead Narasha. For eight days she was kept in Samia's stable where her wound was treated and she was introduced to a bottle formula. Dryan stayed with her the whole time. But as a long-term solution this was not possible. My home is also Samia's home. She is believed to be highly pregnant and in the past has proven very jealous of interlopers. Visions of her chasing off the huge Makora and persecuting the baby eland I tried to hand-raise floated before my anxious eyes and I did not dare let the baby Tasha out of the stable lest further disaster follow. Now she is stronger and installed with Dryan over in Halvor's stables. From there she will be reintroduced to the wild.

Alas this has not been our only tragedy. The old female Juno disappeared over Christmas. The grass is incredibly high and the roads still very bad so searching for her was more difficult than usual. No vultures were flying and they are the normal sign of trouble. Eventually we found her below a high cliff in a narrow tree-shrouded part of the east valley. With her were the remains of a newborn calf. Juno was said to be old when she came to us in 1984. Out of the three calves she had here, she lost two. We must presume that she was simply too old to give birth again and this last baby killed her. Her horns, lower jaw and part of the baby's skeleton have gone down to Nairobi for analysis. Juno I shall miss sadly. She was one of my oldest friends here. I shall remember the time I hid behind a tree and she walked right up to me, touched me lightly with her nose, gave a disgusted snort and walked off. I shall remember the time my idiotic little collie, Remus, tried to round her up. She was a huge, gentle and beautiful rhino and I loved her and mourn her passing.

On a lighter note, I had two incredible encounters shortly before Christmas. One day, wholly unable to get out by car, Daniel and I walked down the valley below the house. Leopards here are heard with regularity but seldom seen. As I find the look in their eyes somewhat terrifying, I don't go searching for them. On this morning the strange behavior of a troop of baboons alerted Daniel to their presence. Sitting on a rock for 40 minutes we had the incredible good fortune to watch three adult leopards socializing in the valley just below us, a very large male, a smaller male and a female; it was both awe-inspiring and very beautiful.

The second encounter was wholly unexpected and with one of my favorite animals and one I have never before seen here. It was early morning and I was going to walk up the hill accompanied of course by the dogs, to call Francis on the radio. Round the bend we walked and there, sitting on the track with their backs to us were 11 hunting dogs. They were gazing intently at Samia who was on her way home but had stopped to look at these dogs she had not met before. Alas, my dogs barked at this unexpected encounter and the hunting dogs departed. As well as the 11 on the road, at least five more were in the long grass. These fascinating wild dogs are almost as endangered as rhinos throughout their range in sub-Saharan Africa.

Samia is looking to all of us, plus various vets, very pregnant but still nothing happens and still she is my friend, as was proved yet again on a recent evening walk. She had heard the dogs and come to join us on our way home but, to my considerable

consternation, the road home was blocked by three rhinos. While I was wondering what best to do, Samia took charge of the situation. Huffing and puffing she trotted toward them and they, all much larger than her, backed off. She then turned and came back to me, turned again and obviously said "come" so, with the dogs close at heel, I walked beside her and passed them. Having escorted us for what she considered a safe distance, she then went off on her own again. I wonder if anyone has ever had such a friend as I have in Samia.

I must end with a big thank you from all of us here to you for your continued support and a hope that we can continue to rely on you. We need your help badly to continue our work for the rhinos, for this whole ecosystem and the incredibly diverse fauna it supports. Our security can never be relaxed as long as rhino horn continues to be one of the most valuable and sought-after commodities on Earth. The future of these fascinating animals depends on your support and efforts.

*--Anna Merz  
founder Ngare Sergoi Rhino Sanctuary*

(Update: Narasha's baby, Tasha, died from her injuries. Samia has become a first-time mother to a healthy male calf that has been named Samuel. See details in the following article.)

## *The Birth of Samuel*

Sometimes life in the sanctuary is a bit like living in a theater, only most of the actors on the stage are rhinos, and how inextricably entangled my life seems to have become with theirs and their dramas and disasters. The little Tasha, who seemed to be doing so well, died suddenly on the 21st of January of colic and pneumonia leaving a gap in all our lives. But since then two births have brought us great joy. On the 9th of April, the white cow Marembo gave birth to a male calf. Her previous calf, Baraza, stayed in her vicinity for two days, appearing increasingly perplexed by his mother's behavior towards him and her refusal to permit him to investigate his tiny sibling. Then he left her and joined up with Sungari who is nowadays accompanied by both her nine-month-old daughter and her older calf, Lari, who rejoined her in December having spent the previous seven months with Marembo and Baraza.

Hardly had we recovered from the excitement of this birth when, for me, the major event took place. My beloved handraised Samia produced a son whom I am calling Samuel. He is, to me at least, quite the most wonderful and enchanting baby and, more importantly, Samia is proving to be a wonderful mother. I was so afraid that having been handraised herself, she would not know how to look after or how to protect her child. This so frequently happens with handraised animals. But, happily, all my fears on this score have proven to be groundless and day by day her baby grows, and day by day I watch the bond between them becoming stronger. Samia's affection for her baby is something very beautiful to watch and I am quite ridiculously proud of her.

While our females have delighted us with their babies, some of our bulls have provoked contrary emotions by their violent behavior. That bull rhinos should fight among

themselves is to be expected, but why they should suddenly take it into their heads to attack females I do not understand. When Ekili attacked Narasha at least he was not her mate and the calf was not his. (see "Ngare Sergoi 1994 Annual Report" elsewhere in this issue). But when Kelele launched a violent attack on Solia's three-year-old daughter, Sonia, this excuse could not be offered. He is not only her father, but we believe that he has recently re-mated Solia. I was with guests when we saw four rhinos together, Solia and Stumpy and their calves, both nearly three years old and both fathered by Kelele. Onto this peaceful scene erupted Kelele who launched a violent attack against Sonia. Solia tried to protect her, but Kelele got his horn under Sonia's groin and hoisted her up onto her front legs. She then fell onto her side and he knelt on her. At this moment I lost sight of the proceedings as I negotiated a gully with the Landrover. When I emerged, Sonia was back on her feet and Kelele was attacking her again. I managed to chase him off and she and her mother departed at full speed. Thankfully, Sonia is alright. No sooner had they departed that the furious Kelele turned around and set upon his other daughter, Nyota, who had been watching the proceedings with her mother from under a nearby bush. Luckily, I could once again separate them before damage was done and they departed in opposite directions, Kelele obviously furious.



**Samia, the black rhino handraised by Anna Merz is shown above with her first offspring, a male named Samuel who was born on 19 April 1995. Photo courtesy of Andy Lodge, Ngare Sergoi Support Group, Inc.**

Then on the same day that Marembo had her calf, Samia's wild husband Kenu, decided to launch an attack on the huge white bull, Makora, who must be at least twice his size. Luckily for Kenu, Makora had been dehorned and a helicopter was in the immediate vicinity and could separate them or Kenu could have paid for his foolishness with his life. But two days later, just before I had news of the birth of Samia's son, Kenu had another battle. This time it was with the black cow Shaba, whom he is believed to have mated, and her sub-adult male calf Shimba. I was wholly unsuccessful in my attempts

to intervene in this fracas. I called Francis on the radio and he came over in the "Bowling for Rhinos Supercub" and separated them. Both these bulls have been dehorned by the Kenya Wildlife Service (K.W.S.) vet. Dehorning does seem to lower levels of aggression and is a management tool that seemingly has to be used to prevent disasters with introduced populations of rhino.

In March we were delighted to welcome the winners of last year's "Bowling for Rhinos"; Diane Vellafeurte and her friend Penny from Lincoln Park Zoo, Chicago and Christine Bobko and her friend Michael from the Denver Zoo. I learned so much from these dedicated zoo keepers and I hope they enjoyed their visit here as much as we enjoyed having them. Christine brought with her the ashes of two black rhinos whose deaths she had mourned at Denver and we scattered them on the grave of my much-loved dog, Sambo. I think we all wondered if, one day in the future, live zoo-bred rhinos would ever return to their African homelands.

Early in the New Year elephants in large numbers, about 185, moved into the area of the old rhino sanctuary and are still here. The damage they are causing to the trees is overwhelming and goes well beyond their recovery potential. On the rest of Lewa there are approximately 100 additional elephants and, there too, the tree destruction is very serious. It has been estimated that Lewa could carry about 40 elephants which means we have at present about 260 over our carrying capacity. All over Africa where elephants remain in reasonable numbers they are posing a major problem. For 40 million years these great creatures have roamed Africa and for them time is measured in centuries and a continent was theirs. In a little more than 50 years their wilderness has vanished; now small protected pockets remain surrounded by cultivation, fences or men with guns. Their migratory routes are cut and they are wholly incapable of adapting to these changed circumstances. Their appetites are vast but they destroy many times what they eat and herein lies the problem. Driven by who knows what urges and impulses of rage and sex, the destructive capacities of the bulls are boundless. One morning I watched a solitary bull push down 42 mature *acacia tortilis* trees. He ate from none of them but with a sort of inner rage moved from one to the other

*"In a little more than 50 years their wilderness has vanished; now small protected pockets remain surrounded by cultivation, fences and men with guns."*

knocking them down in turn. These acacia woodlands, once destroyed, do not recover quickly and though the seeds of the next generation are carried by the elephants in their droppings, they will only mature if the elephants migrate. If the elephants remain and eat all the seedlings, the trees will be lost and with the trees go other browsers, which include black rhinos.

Apart from their impact on trees, the elephants' impact on water pipes is time-consuming and costly. But this is mainly individual bulls who take a delight in digging up and smashing water pipes; some bulls also make a habit of breaking fences. On top of this, elephants do sometimes kill rhinos, and not only rhinos. Their reputation as gentle giants is somewhat of a misnomer. In Kenya their numbers are estimated at 24,000 as against perhaps 400 black rhinos, so the rhino must be

given priority here. But the problem, neither here nor elsewhere, cannot be easily solved. These animals are all the property of the State and have to be managed in conjunction with the K. E.W. who is aware of our troubles here and the tree damage that is being caused.

In the last issue of H.O.R.N., you may have read the article by Patty Pearthree on the Ujung Kulon National Park in Java which is the only place in the world where the world's rarest rhino, the Javan, is protected (see reprint of this article elsewhere in this issue). Within that park there are 45-50 animals. Possibly another 12-20 still exist in Vietnam, but at least the Javan rhino has one sanctuary where it is protected. The Sumatran rhino has none. No one knows how many of these animals survive, but not more than 200-300 widely scattered in fragmented pockets of inaccessible terrain in southeast Asia. All that is known with total certainty is that its numbers are declining rapidly and the population may already be too fragmented for breeding to occur. Trying to breed this species in captivity has also proven a disaster. But now at last there is a glimmer of hope for this beleaguered creature. In March I received a most unexpected and so welcome visit from Jim Jackson of the International Rhino Foundation. Accompanied by two Indonesian officials, Jim told me of the proposed establishment of the very first Sumatran Rhino Sanctuary of approximately 9,000 hectares (35 sq. miles) within the Way Kambas National Park in S. E. Sumatra. This has to be one of the most exciting developments for an endangered species within recent years. I believe it is the only hope for the Sumatran rhino to continue to exist into the next century. I hope so much that it will prove to be an outstanding success, but for it to succeed it will need all the support that we can rally for it. Please find out how best you can help this sanctuary and this animal to survive; its future depends on all of us. *by Anna Merz, Founder*

*Ngare Sergoi Rhino Sanctuary*

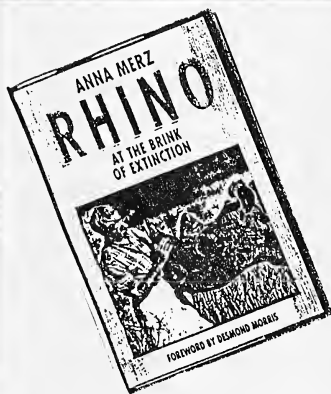

## *Rhino at the Brink of Extinction*

*By Anna Merz, Founder*

*Ngare Sergoi Rhino Sanctuary*

Enjoy and learn from Anna's story of the rhinos - how Ngare Sergoi was started and her adventures with the rhinos, including the heartwarming story of hand-raising Samia. Profits from this book go towards the operating expenses of the Sanctuary.

To Order: send \$20.00 plus \$2.50 s&h for each book ordered.. Make checks or money orders (U.S. Funds only) payable to: Ngare Sergoi Support Group. Please include your name and complete mailing address when ordering.

Also available is Anna's second book - *Golden Dunes and Desert Mountains* - which is available for \$12.50 plus \$2.50 s&h per copy.





# ENRICHMENT OPTIONS



Psychological Stimulation  
Behavioral Enrichment  
Activity Manipulation  
Occupational Husbandry

*By Kayla Grams, Arizona-Sonora Desert Museum  
and Gretchen Ziegler, Sequoia Park Zoo*

In keeping with this month's dedicated issue, all enrichment ideas in our column will be for rhinos, although many other pachyderms and ungulates enjoy these ideas as well. The sources we used did not specify the species of rhino, so some items may not work for all species.

## **RHINOS**

- Loose trunk (heavy) chain in the enclosure to push and test strength against an artificial sparring partner, and to rub horns on
- Water pool and mud pool, rhinos enjoy rolling themselves in mud and puddles and readily bathe on hot days
- Rubbing posts stimulate natural skin growth and peel off dry skin
- Spread part of food in various places in exhibit, throughout the day
- Exchange rhino dung with other zoos - new scents stimulate sexual activity; and increases marking behavior
- Split up the herd - separation stimulates sexual behavior when the animals are put together again
- Browse branches in high places stimulates natural foraging activity

*—A Catalogue of Ideas  
Coopenhagen Zoo, Denmark*

The following is a list of activities used with rhinos at the San Diego Zoo. Most are similar to the previous list, with some slight variations. One overriding observation is that it is quite often messy (and therefore time-consuming for keepers afterwards!) and due to rhinos' poor eyesight and nervousness, novel objects can result in flight or defense behaviors. Remember to introduce new items cautiously and gradually.

- Frequent browse (ficus, acacia, hibiscus, mulberry, elm, etc.), hung on stumps or on the ground
- Big, movable stumps throughout exhibit

- 55-gallon plastic drums for males to batter around
- Elephant or other rhino dung, males defecate on top and stomp into ground
- Apples in pool
- Fresh dirt, mud puddles
- The occasional bowling pin (usually preceding Bowling for Rhinos, of course!)

—Ron Ringer, Keeper, San Diego Zoo

We would also like to point out that operant conditioning is highly effective with rhinos, not only for specific behaviors such as blood draw, semen collection, etc., but as a noticeably rewarding activity (i.e. enrichment) for the rhino, one that the animal seems obviously to anticipate with eagerness and excitement. Operant conditioning also seems to have an overall calming effect on nervous rhinos, which is an advantage when introducing something new to an exhibit. For more information on this topic, see articles in this issue of *AKF* and refer to October 1993 issue of *AKF* for an article entitled "Rhino Training" by Matt Edmonds.



## World Rhino Population Estimates\*

### POPULATION IN YEAR:

	<u>1970</u>	<u>1983</u>	<u>1990</u>	<u>1992</u>	<u>1994</u>
<b>Indian Rhino</b> <i>(Rhinoceros unicornis)</i>	900	1,700	1,950	2,000	2,200
<b>Javan Rhino</b> <i>(Rhinoceros sondaicus)</i>	35	50	65	72	47
<b>Sumatran Rhino</b> <i>(Didermocerus sumatrensis)</i>	1,000	500	700	160	140
<b>White Rhino</b> <i>(Ceratotherium simum)</i>	3,500	3,000	4,900	4,950	5,000
<b>Black Rhino</b> <i>(Diceros bicornis)</i>	65,000	13,000	3,100	1,800	1,700

\* These counts do not include captive animals.

(Figures supplied to *Animal Keepers' Forum* by Andy Lodge, Coordinator of the Ngare Segoi Support Group, Inc., Columbus, OH.)

# Chute Restraint of White Rhinoceros



By Adam Eyres, Robin Radcliffe, and Meg Bommarito  
Fossil Rim Wildlife Center, Glen Rose, Texas

The management of white rhinoceros (*Ceratotherium simum simum*) at Fossil Rim incorporates exposure to a chute into the rhinos' daily routine. Many procedures which normally require immobilization of an animal can be performed in a chute without use of chemical agents. This can both decrease stress to the animal and increase the effectiveness of many treatments. These include skin care, foot care, and blood collections as well as other less invasive activities.

The rhinos are moved from the indoor facility to the outdoor pens each morning. Passage from the barn into the yard requires the rhinos to walk through the chute (see Figure 1). Once the rhinos are conditioned to the structure, further steps are taken to prepare them for the procedures. The animals are detained in the chute with either the front or back gate closed. They are released if they become uncomfortable. While in the chute, they are fed sweet feed and alfalfa hay continuously. The rhinos are given their daily feeding of hay and pellets after they leave the chute.

Figure 1

•Yard Design•

○ = gate  
▨ = chute  
yard = 10 acres  
scale: 1 cm = 4.8 m

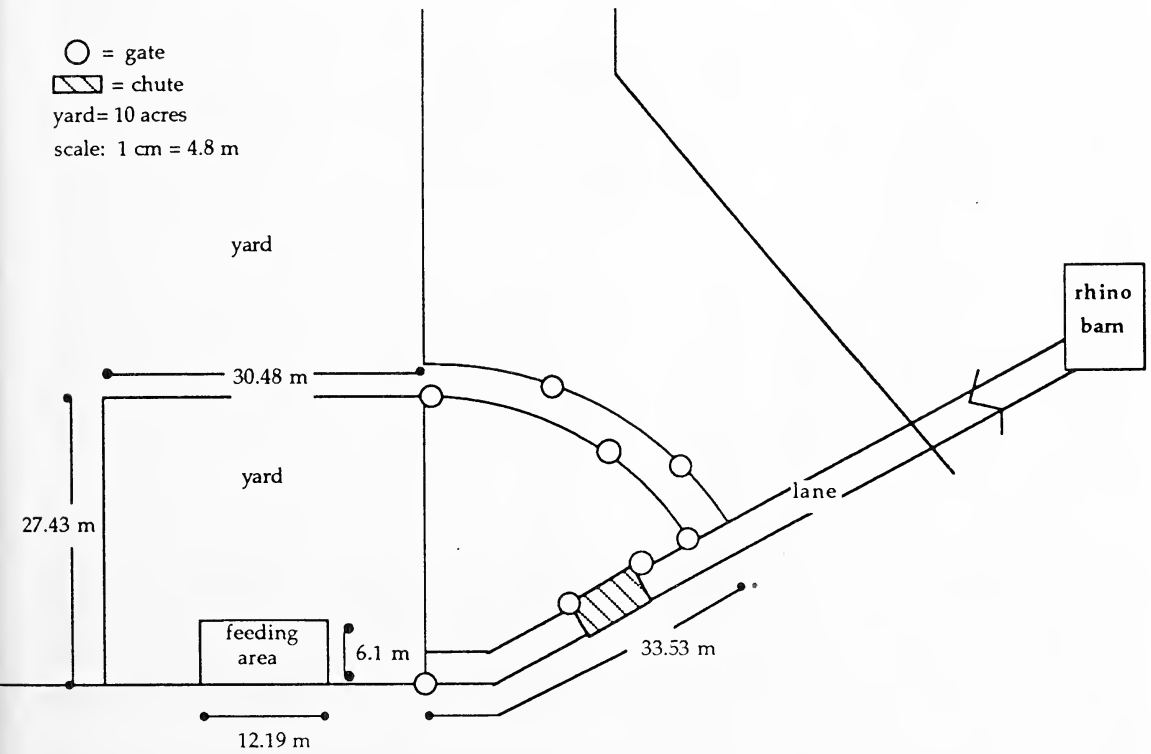

Two different chute designs are used in conditioning the rhinos: closed and free stall

chute. Each is unique in its function and structure and was designed to serve a particular purpose.

The closed chute (see Figure 2) has both front and back gates. The back gate restricts the animal's movement by sliding forward. The hind end of the rhino is supported by the v-design which prevents it from lying down, allowing additional safety to the staff while working on the animal.

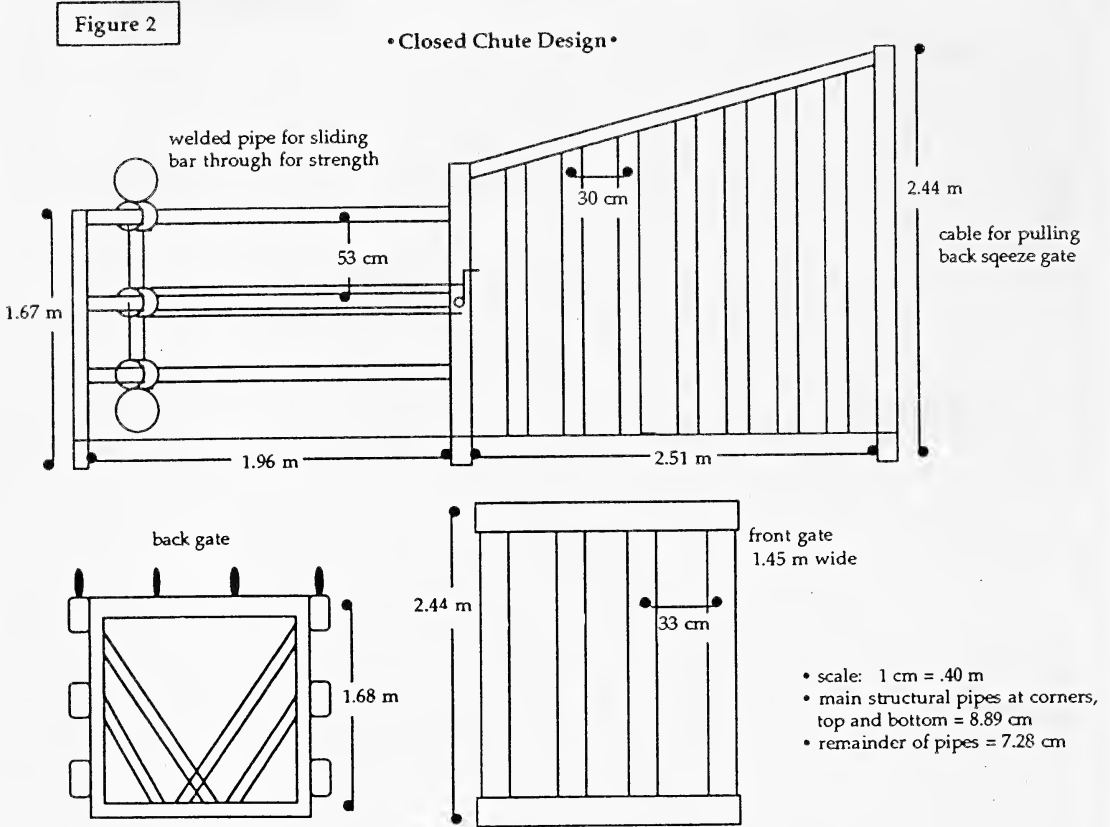

This design has allowed for successful treatment of several animals in critical situations. A female rhino with a urinary tract infection permitted the insertion of a catheter while in the chute. Care of infected lesions on the foot of a male rhino was possible. The initial portion of the procedure was successful without the use of chemical agents, and the remainder required only a low dose of immobilization agent. Collection of blood was also feasible.

The ability to restrain the animals with four (4) walls makes the closed chute practical in a variety of situations. Its use does not depend as strongly on the conditioning of the animals and it can be used in a greater variety of procedures. There are however, some limitations to the use of the closed chute. The outdoor location may restrict its use during bad weather. Reduction in the spacing between pipes in the front gate from 13" to 10" (33cm to 25 cm) is needed to increase effectiveness. This will prevent the rhino from pushing its head through the pipes.

The free stall chute (see Figure 3) was designed for an animal more sensitive to a

confined enclosure. The open back of this chute allows the animal to enter and leave the structure at will. It has been incorporated into the indoor pen. To protect staff working on the rhino, the back end of the chute is equipped with a wall constructed of vertical pipes. If the animal leaves the chute at any time during procedures, the person need only step out the 15 -inch (38cm) gap and behind the wall.

With the freedom offered by the free stall, the rhino is calmer and more receptive to procedures, therefore the risk of self-inflicted injury is greatly reduced. This chute has also been used for minor medical procedures and routine health checks.

The free stall chute design is specific to conditioned animals and relatively non-invasive procedures. While this limits its use, a more sensitive animal is much more receptive to treatments with no threat of complete four-wall restraint. An additional benefit to the free stall is the indoor location. Weather will not restrict use of this chute.

Figure 3

•Free-Stall Chute Design•

- vertical pipes at corners = 11.43 cm
- horizontal pipes = 7.31 cm
- vertical pipes = 7.31 cm
- total height = 2.18 m
- scale: 1 cm = .40 m

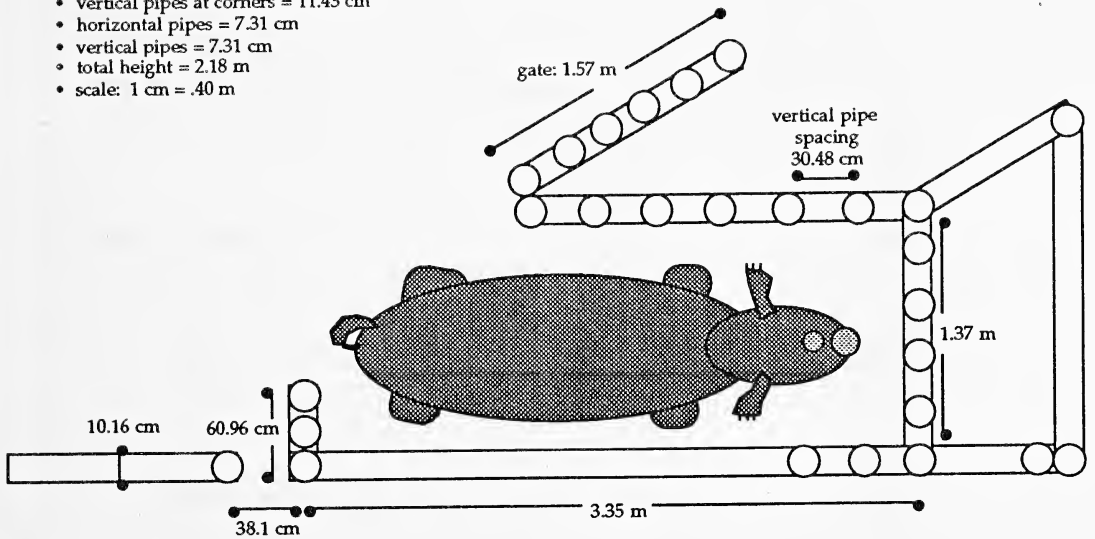

Both closed chute restraint and conditioned restraint in a free stall chute are effective means of treating and managing rhinos. The chute also holds great potential for research projects. A non-invasive ultrasound technique has been successful in providing information regarding reproductive functioning. Serial collection of blood and fresh feces is also possible. Overall physical appearance and weight can be monitored daily for nutritional studies.

A chute can offer alternatives to chemical immobilization. Its incorporation into the daily routine of the animals allows for better management and a wider variety of research opportunities.

**Acknowledgments:**

Thanks to all Fossil Rim staff, past and present, for their contributions made to this project.



# RHINO KNIFE SHARPENER

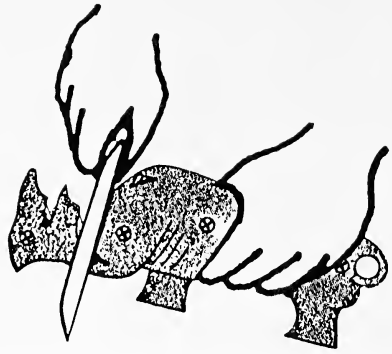

AAZK, Inc. is pleased to offer these unique knife sharpeners to the membership for \$10.00 each. This handy tool will sharpen and hone all knives using a tungsten carbide sharpener with two blades precisely angled to sharpen the cutting edge of your knife, and ceramic honing rods to put the final sharp edge on your blade. Lightweight, portable and dishwasher-safe, the Rhino Sharpener comes with an unconditional lifetime guarantee.

We have a limited quantity of these sharpeners available, so order now! The price includes domestic postage. Canadian orders need to add \$2.00 per sharpener for air mail postage. We are sorry we cannot fill orders from outside the U.S. and Canada on this particular item.

To order, complete the form below and return with your check or money order made out to AAZK, Inc. (U.S. Funds only, please).



## Rhino Sharpener Order Form

Please send \_\_\_\_\_ Rhino Knife Sharpener(s) at \$10.00 each, plus shipping if applicable to:

Name: \_\_\_\_\_

Address: \_\_\_\_\_

City: \_\_\_\_\_ State/Province: \_\_\_\_\_

Zip/Postal Code: \_\_\_\_\_

**Total enclosed:\$** \_\_\_\_\_

# Conditioning White Rhinos for a Presentation

By Richard Cody, Keeper  
Audubon Zoo, New Orleans LA



**Saba 1.0 white rhino**

This article is about the work two Audubon Zoo keepers (Linda Weaver and the author) did to condition two white rhinoceroses (*Ceratotherium simum*) to accept food rewards and for purposes of behavioral management.

The animals involved were Saba, a three-year-old male, and Yvonne, a four-year-old female. In April 1994, Yvonne and Saba were eating one 50 lb. bag of grain and about 3/4 of a bale of Bermuda grass each day. They were not given any kind of treat except for an occasional flake of alfalfa hay. The stimulus to which they best responded was having a keeper rub their inner thigh with a hand or brush. After coming from a zoo where the keepers do routine blood work on black rhinos (*Diceros bicornis*), I mentioned to our supervisor that I thought I could condition these white rhinos for similar work. He gave me permission to try it, so I began right away.

I felt fruit, such as bananas and apples, would work best as primary reinforcement during conditioning because, in my previous experience with the black rhinos, the black rhinos were given fruit to hold them steady during their blood work. Only positive reinforcement is used. It was a very slow start trying to get Saba and Yvonne to go near the bananas which I wanted to use as a reward for their behaviors. Each day when I would set up their hay and grain, I put some bananas on top of it hoping they would eat them while eating their usual diet. Over the next couple of weeks they ate the hay around the bananas, eventually pushing the bananas off their diet to get it out of the way. At that point I observed they were at least willing to touch the treat but still not taste it.

The next step was to bury the treat in the rhinos' diet. I hoped to sneak the treat into their mouths so they could begin to acquire a taste for it. The following mornings during my observations, I found chewed treat covered with saliva on the floor. This went on for a week, until I began to notice that some of the treats were missing. I wanted to make sure that it was indeed Yvonne and Saba who were getting the treat rather than some unwelcome rodent pests. So, I showed each of the rhinos a banana and then set it under their heads. Yvonne cautiously ate hers while Saba backed away. I then cut some apples for Yvonne, and along with the banana, fed half to her and put the other half on the hay. Saba ate from the same piles of hay as Yvonne, so he could eat the treats when he felt more comfortable about it. Soon after, when I was setting the treats on the floor for Yvonne, Saba began competing with Yvonne for keeper attention and would push her away. That never slowed Yvonne, however. Soon after eating treats on the ground, she took one out of my hand. Without giving any sign of being interested before, Saba then began taking treats offered to him.

At this point I began working with Linda so we could use the treats to condition the rhinos for a public presentation (the idea of medical work was dropped for the present

time). Working with them daily for the next two months, we encouraged Yvonne and Saba to raise their heads so we could get a better look at them. Keeping in mind that white rhinos are grazers, typically keeping their heads lower to the ground even while traveling, we were encouraged by their progress. Not wanting them to lower their heads right away, we kept the treat just out of reach for approximately 10 seconds. Yvonne really surprised us when, in order to get the offered treat, she opened her mouth and reached for it with her lips.

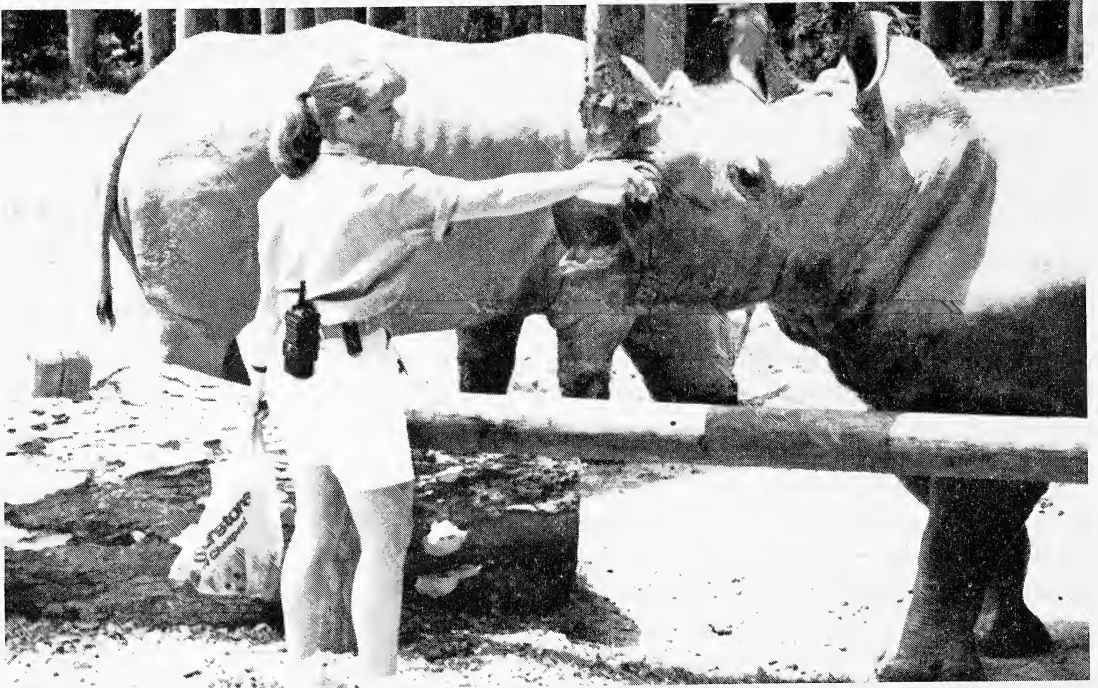

**During a public presentation, Keeper Linda Weaver works with 0.1 white rhino Yvonne to get her to raise her head, open her mouth and turn her head to the side.** *Photo by William J. Cody.*

Linda and I let our supervisor know we were ready for public presentations with the rhinos utilizing a safe area in which the keeper would stand. During these presentations, I usually talked while Linda fed Yvonne and Saba. While feeding them, Linda made them work for the treat by raising their heads, opening their mouths, then wresting it from her hand with their lips. Linda continued their training during the presentation by tapping the treat on the side of their faces. When the rhinos moved their heads toward the tapping, Linda would give them the treat.

Now when we show the rhinos a closed, palm up hand next to their faces, they respond as if looking for a reward. We used positive reinforcement to up this rapport and behavior with Yvonne and Saba, and we do not allow any reprimanding on the head or face. Occasionally, one of the rhinos will push the other or try to knock one of us down. In these situations, we use the "time out" method and work with the non-aggressive rhino. The learned behaviors came through the use of hand signals or targets. The next area we hope to work on is either ear movement using noise as a cue, or lifting a leg by using a noise as a secondary reinforcer and as a cue. Remembering that Yvonne lifts her leg a little when her thigh is rubbed, we have something to begin working with.



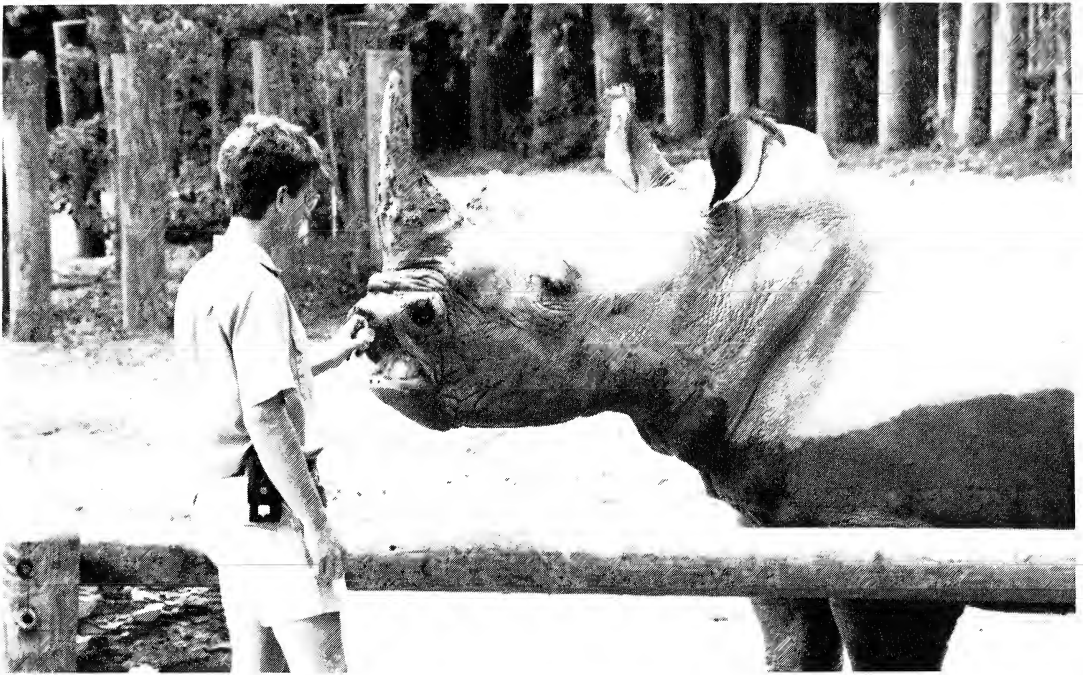

**0.1 white rhino Yvonne accepts a reward from author Rich Cody.**  
*(Photo by William J. Cody)*

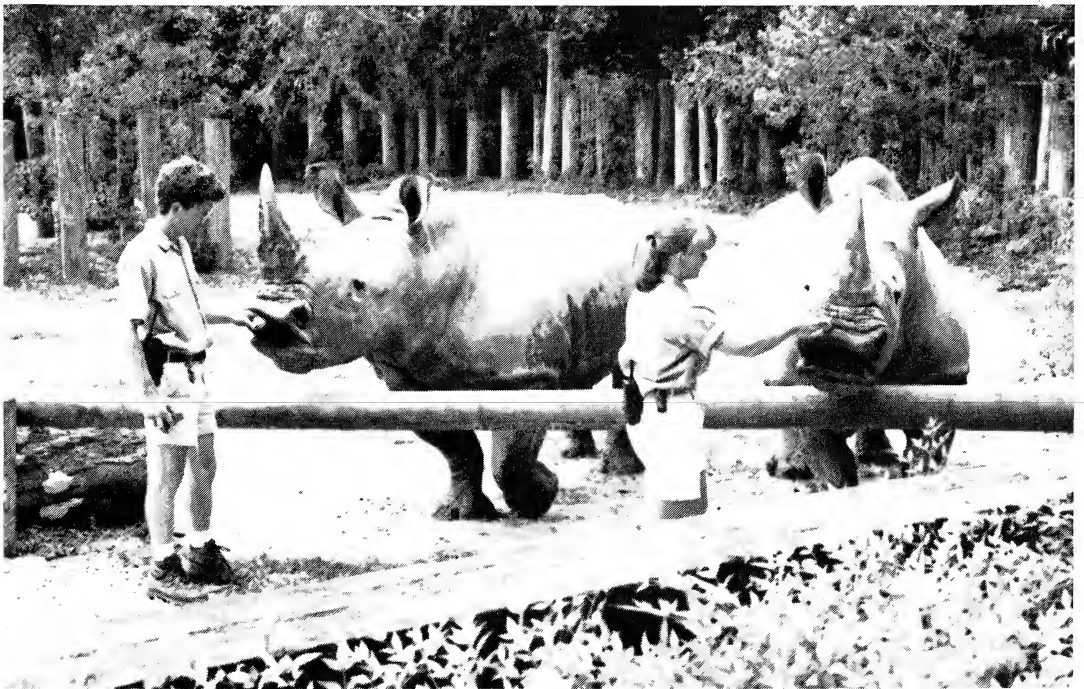

**Left to right Rich Cody, 0.1 Yvonne, Linda Weaver and 1.0 Saba during a public demonstration of conditioning the rhinos to accept rewards for desired behaviors.** *(Photo by William J. Cody)*

# Legislative Update

Compiled by Georgann B. John  
Legislative Adviser  
Sacramento, CA



---

## Exxon Oil Spill Proceeds Used to Buy Alaskan Habitat

Kodiak Island was the subject of an agreement, signed by Secretary of the Interior Bruce Babbitt and the presidents of two Alaska Native corporations, which provides protection for approximately 150,000 acres of land which provides the home for bears, salmon, bald eagles and a number of other species.

The agreement provides for preservation of the habitat along with improved facilities for sport fishing, hunting, and other recreational activities. The \$60.5 million in funds for the project came from proceeds of the settlement of the Exxon-Valdez oil spill lawsuit. Surface title to approximately 100,000 acres was purchased outright, with the remaining portion of land being protected through conservation easements in perpetuity.

A separate part of the agreement provides for protection of another 65,000 acres of nearby Sitkalidak Island as a private wildlife refuge to be used for ecotourism and in other economically feasible manners not inconsistent with the concept of maintaining the wildlife and wilderness of the area. The Interior Department is continuing to work with a third corporation in hopes of adding an additional 120,000 acres to the preserve.

The agreement was specifically designed to provide protection for species harmed by the oil spill, including pink salmon, sockeye salmon, pacific herring, sea otters, bald eagles, river otters, marbled murrelets, harlequin ducks, pigeon guillemots and harbor seals.

*Source: U.S. Fish & Wildlife Service News Release, 23 May 1995*

---

## Agreement to Protect Unique Island Environment

A number of conservation agencies and the government of Mauritius recently signed a cooperative agreement to establish a comprehensive program of habitat surveying and management, species reintroduction and captive propagation, and professional training related to conservation of wildlife and plants on the islands of Mauritius and Rodrigues. The Jersey Wildlife Preservation Trust is the major group involved in carrying out the terms of the agreement, including the provision of staff skilled in horticulture and conservation management, island restoration, and vertebrate captive breeding.

One goal of the project is to develop a model of integrated conservation management which can then be applied to other unique island habitats such as the Caribbean, Polynesia and the Philippines. Further information about the project is available from Mike Maunder, Royal Botanical Gardens, Kew, Richmond, Surrey, TW9 3AB, England; Fax 44-81-332-5582.

*Source: The GreenDisk, Paperless Environmental Journal, Feb/Mar 1995, Vol. 3, No. 5*

---

## India and China Unite to Protect Tigers

The governments of the People's Republic of China and India have agreed to work together in the fight to save the world's tiger population. In addition, they have vowed to share research and training facilities to improve management of wild tigers and their shrinking habitats. This agreement, which was signed in March of this year, requires the two countries to instigate more internal controls to halt the illegal trade in tiger parts.

"This agreement is particularly important because China has agreed to crack down on poaching, smuggling, and illegal use of tiger derivatives" said Judy Mills, Director of TRAFFIC East Asia, a monitoring program of WWF-World Wide Fund for Nature and IUCN-The World Conservation Union. "While China has made sales of tiger products illegal, it is important that it now focus on the black market within its borders." The agreement also contains a clause that encourages captive breeding of tigers with a view towards releasing them into the wild.

*Source: GreenDisk, Paperless Environmental Journal, Feb/Mar, Vol. 3, No. 5*

---

## National Biological Service's Funding Threatened

Budget resolutions passed by both the House and the Senate in late April 1995 include recommendations to the Appropriations Committee of both bodies to eliminate the National Biological Service (NBS) from the Congressional budget. The NBS, which was created in 1993 to collect and integrate scientific information from a wide variety of federal government organizations, received \$167 million of funding during the past fiscal year.

The information collected by the NBS, which includes data about wildlife and plants, is provided free of charge to government agencies, universities, industry and private landowners with the idea of encouraging sound resource management decisions. One project instigated recently by the NBS is the Gap Analysis Program (GAP) which proposed to map all of the United States' wildlife and vegetation using satellite visual scans coupled with computer technology. Proposed use of the data includes development of local and regional planning balancing wildlife protection with human activities and needs, with the ultimate goal being resource management to prevent the need for protection under the Endangered Species Act.

An open letter to Congress from 400 scientists, including ethnobiologist E. O. Wilson and author/illustrator Roger Tory Peterson, warned that the loss of the NBS would "be a short-sighted mistake with long-term consequences." Proponents of the budget resolution say that cutting of the NBS' funding will dispose of unneeded government bureaucracy and help balance the budget.

*Source: Defenders of Wildlife Rapid Response Mail Box Legislative Update, 31 May 1995*

---

## Criminal Sanctions Proposed for Harm to Exotic Animals

A bill entitled the "Captive Exotic Animal Protection Act of 1995" was introduced to the House of Representatives in March of this year. Bill No. H.R. 1202 proposes an amendment to title 18 of the United States Code, prohibiting interstate-connected conduct relating to exotic animals. The bill proposes criminal sanctions, including fines and imprisonment, "for anyone convicted of participating in the transportation of exotic animals for the purpose of allowing the killing or injuring of the animal for entertainment or the collection of a trophy."

The bill goes on to define an exotic animal as a "mammal of a species not historically indigenous to the United States that in fact has been held in captivity for the shorter of the greater part of the animal's life or a period of one year."

*Source: House of Representatives Pending Bill File*

---

## **Listing of Endangered Species Halted**

On 10 April 1995, President Clinton signed into law H.R. 889, an act which made emergency supplemental appropriations for the Department of Defense. The Act also contained a provision which rescinded \$1.5 million for listing threatened and endangered species and determining critical habitat needed for the recovery of those species, a moratorium which will last at least until 30 September 1995. President Clinton stated at the time that he was reluctant to sign because the endangered species provisions "will impair the Administration's ability to proceed on its recently announced package of reform principals and consequently, our ability to respond to the needs and concerns of private landowners."

*Source: White House Press Release "Statement by the President" 10 April 1995*

---

## **Secretary of Interior Decries Endangered Species Reform Act Bill**

In a statement to the Senate on 9 May, 1995, Secretary of the Interior Bruce Babbitt said that the endangered species bill just introduced could be summed up in seven words: "It will repeal the Endangered Species Act." Secretary Babbitt went on to analogize: "This bill is like a movie set for a western town. From the front it looks like the Endangered Species Act, but if you walk around to the back you'll find out it's fake. No one - not the Secretary of the Interior, not Federal agencies, not private landowners - is absolutely required by the bill to do anything to conserve endangered species."

The Secretary bemoaned the fact that the bill would narrow the requirement for consultation with Fish & Wildlife on thousands of projects, allowing construction to go forward in sensitive habitats "simply by declaring that the action was essential to (a government agency's) mission."

*Source: Department of the Interior News Release, 9 May 1995*

---

## **Ecosystem Management Plan for National Parks Service**

The National Park Service has completed a working draft on the application of the ecosystem management concept to the management of units of the National Park system. Entitled "Ecosystem Management in the National Park Service", the document is an effort to "develop a collaborative approach to natural and cultural resource management that integrates scientific knowledge of ecological relationships with resource stewardship practices for the goal of sustainable ecological, cultural and socioeconomic systems."

The NPS manages a wide variety of natural and cultural resources including parks, national battlefields, seashores, monuments, recreation areas and preserves. The goal of the plan is to balance the demands of the public for access to these areas with maintenance and protection of the resources themselves. Ecosystem management encompasses the concept that resources do not exist in isolation but, rather, in complex, interconnected systems; communities of living things within a dynamic physical environment. The goal of ecosystem management is "to preserve, protect, and/or restore ecosystem integrity (composition, structure and function) and also maintain sustainable societies and economies."

One of the primary objectives of ecosystem management is to maintain resources before crises arise. An example cited by the draft document is to look at key watersheds to protect anadromous fish in the Pacific Northwest and determine if those same areas can provide habitat for endangered spotted owls and marbled murrelets.

The NPS invites comments on this draft document, a copy of which is available from Peggy Lipton, Chief, Office of Ecosystem & Strategy Management, National Parks Service RNR, 12795 W. Alameda Parkway, Denver, CO 90228.

*Source: International Arid Lands Conference Online Newsletter, March 1995*

---

## Elephant Translocation in Zimbabwe Suspended

On 10 May the government of Zimbabwe suspended translocation of wildlife, primarily elephants, from its national parks and game reserves. The government also set a ban on all exports of live wild animals until a survey of the major wildlife species could be conducted. This action was directly contrary to an announcement made in March of this year, when the National Parks & Wildlife Management office had advertised the sale of 8,600 elephants.

The Minister of Environment, Chen Chimutengwende, stated that the decision to stop translocation was made "to ensure that there were no abuses and that the nation benefited from the transactions." The Wildlife Society of Zimbabwe had initially endorsed the translocation plan but withdrew its support when it felt "the program was no longer keeping the emphasis on the well-being of the elephants."

The government claims that the country's national parks cannot continue to support the number of elephants living there. For example, approximately 30,000 elephants can be found in Hwanga National Park but the government claims that only 20,000 can be sustained on the currently available resources.

*Source: African Wildlife Update, a publication of the African Wildlife News Service, May-June 1995*

---

## Hunting of Elephants to Resume in Botswana

Botswana's government has decided to allow the resumption of sport hunting of elephants in 1996. The basis for this decision is the growing elephant population, which the Minister of Trade & Commerce claims is damaging habitat and property. The elephant population is estimated at 79,000 and CITES has issued a quota of 80 elephant hunting permits.

*Source: African Wildlife Update, a publication of the African Wildlife News Service, May-June 1995*



### **Sterling Silver Animal Jewelry**



**Call or write for brochure.  
To order Rhino on hematite  
stone with 24" chain.  
Send \$36 to Zahara's**

**3570 Paddington Rd. • Troy, MI 48084  
(810) 642-2955**

## Zimbabwe's Rhinos: Secure at Last?

**In each issue of *African Wildlife Update* the results of current African wildlife research are summarized. In this reprint, the findings of three recent reports from Zimbabwe on the status of that nation's black and white rhinos are examined.**

For the first time in ten years, numbers of both black and white rhinos in Zimbabwe are inching upward. In early 1995, the total population of rhinos in Zimbabwe was estimated at 390 (260 black rhinos and 130 white rhinos).

With few exceptions, Zimbabwe's remaining rhino are found in eight areas: four Intensive Protection Zones (IPZs) and four private land conservancies. Each of these areas is described below.

### INTENSIVE PROTECTION ZONES

The Intensive Protection Zone strategy was adopted by Zimbabwean wildlife officials in September 1993. Greater manpower is deployed in these areas (as many as one specially-trained guard per 10 square miles), and the rhinos are intensively managed (dehorned, radio-collared, and monitored).

No rhinos have been lost to poachers in any of these areas in more than 14 months.

**Hwange National Park & Deka Safari Area:** This IPZ consists of Sinamatella sub-region of Hwange National Park and the adjoining Deka Safari Area. At least 60 black rhinos live here, making it the largest remaining population of black rhinos in Zimbabwe. Hwange was once a stronghold for the white rhino too, but the population was heavily poached in early 1993.

**Matusadona National Park:** The valley floor is generally considered to be the IPZ. (Matusadona is in the Zambezi Valley adjacent to Lake Kariba.) At least 26 black rhinos remain here. The population was augmented during 1993-94 with the introduction of 20 black rhinos, but a number of these died unexpectedly. According to wildlife officials, this IPZ has great potential because of its habitat, but some are concerned about its proximity to the Zambian border. No known black rhino births have occurred here since 1992, but the population is young and just nearing sexual maturity.

**Chipinge Safari Area:** This IPZ—the only one located in southeastern Zimbabwe—harbors the smallest number of rhinos, perhaps nine. There was considerable opposition to moving rhinos here in 1991, but political pressure prevailed.

**Matobo National Park:** Within this small national park southwest of Bulawayo lies the Whovi Game Park, which is considered the IPZ. There are at least 42 white rhinos in the Whovi and eight in the other section, making Matobo home to the largest remaining population of white rhinos in Zimbabwe. Twelve black rhinos also live here.

### PRIVATE LAND CONSERVANCIES

Three of the four private land conservancies are located in southeastern Zimbabwe (the

“lowveld”). The conservancies are individual properties joined together for ease of management. Each was established initially to further black rhino conservation. The rhinos on these private lands were once seen as merely an “insurance policies” for the species, but now these areas harbor more black rhinos than the IPZs (about 100 to 160).

Rhinos on these private lands remain the property of the State, with the landowners acting as custodians.

The three lowveld conservancies are:

**Bubiana Conservancy:** This conservancy, created in 1991, consists of 8 individual properties. Approximately 40 black rhinos reside here.

**Save Valley Conservancy:** Also created in 1991, the Save Valley Conservancy consolidates 23 individual properties and harbors an estimated 40 black rhinos.

**Chiredzi River Conservancy:** This conservancy was created in 1992. It consists of 12 individual properties. Eleven black rhinos are found here.

There has been talk of linking Save Valley Conservancy and Chiredzi River Conservancy (separated by a very narrow strip of land) and joining them with other ranches extending to Gonarezhou National Park. Gonarezhou itself could one day be linked with adjoining wildlife areas in Mozambique and South Africa, so it is possible that one of the world's largest wildlife areas could be created, eliminating all concerns about the viability of individual conservancies.

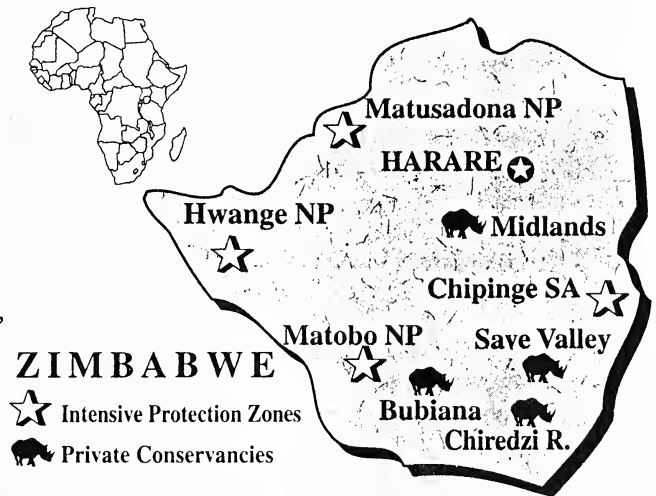

The remaining conservancy is:

**Midlands Conservancy:** This controversial conservancy contains 20-30 black rhinos. It has relatively poor quality black rhino habitat and was initially stocked with more rhinos than was warranted. Zimbabwe's wildlife department has moved some rhinos out of this conservancy to other areas and wants to move more, but opposition exists from some of the individual conservancy landowners.

Among the rhino controversies discussed in the reports:

### 1) Have Matobo's white rhinos exceeded their optimal level?

Forty two white rhinos now occupy the Whovi Game Park section (the IPZ) of Matobo National Park, up from the initial 13 re-introduced in the 1960s. But their rate of population growth has declined during the past decade as the density of rhinos has increased. (The annual rate of increase has dropped from 10.4% to 6.6%). The age at first calving has risen and the interval between births has increased. Nevertheless, ten white rhino calves were born here in 1994.

Should some of Matobo's rhinos be moved to other areas where the density is lower and where the rate of increase would be higher? According to Janet Rachlow, a doctoral candidate who has studied white rhino in both Hwange and Matobo, the Matobo population could be used as a breeding nucleus for restocking both private and State reserves. The government apparently agrees and planned to move out at least five of the rhinos beginning this past May.

## 2) Dehorning

Initiated in 1991 on an experimental basis with Hwange's white rhinos (most of which were subsequently killed), dehorning became a nationwide policy for both black and white rhinos in 1992. Despite its initial failures and its continuing controversial status, researchers consider dehorning to have played a major role in reducing rhino poaching in Zimbabwe, along with "the establishment of IPZs and **improved law enforcement** [emphasis in report]." No dehorned rhinos have been poached on private lands in two years.

Re-dehorning of rhinos has also become standard practice (every 1 1/2 to 2 years), except for older animals, which may have little or no regrowth at all.

In addition to the reports, information for this article was provided in March 1995 by Dr. Mike Kock, a veterinarian with the DNPWM, and Janet Rachlow, a doctoral candidate at the University of Nevada.

*Reprinted with permission from African Wildlife Update ©1995 March / April , Vol.4, No.2. African Wildlife Update is published by the African Wildlife News Service, Olympia, WA.*

Editor's Note: If you have not had an opportunity to view an issue of the African Wildlife Update newsletter, you are missing a great resource for current information on the wildlife conservation scene on the African continent. Published bimonthly by the African Wildlife News Service, a non-profit, all-volunteer organization, this graphically attractive publication began in 1992 and provides a wealth of information on what is happening with various African species, what conservation programs are attempting to do to preserve the area's flora and fauna, etc. The most current issue (May/June) contains articles on the following: Zimbabwe Halts Sale of Thousands of Elephants, Africans Seek Changes to Endangered Species Act, Botswana's Migratory Corridors Seen as Critical, Karisoke Shootout Kills One, Research Notes: The Impact of Village Hunting in Gabon, and Rare Floods hit Northwest Namibia.

Individuals may receive this publication by making a contribution to help cover costs of their news-gathering efforts. A minimum contribution of \$15.00 is required to receive African Wildlife Update (Contributors living outside North America should add \$7 for air mail postage). Limited back issues are available for \$2.00 each. Categories of support include: Contributor \$15-24; Institution (Library/Zoo, etc.) \$15.00; Supporter \$25-49; Sponsor \$50-99; News Hound \$100-249; and Editor's Circle \$250 or more. All but \$5.00 of your contribution is tax-deductible to the extent allowed by law. Send your name and complete mailing address along with a check or money order in U.S. Funds made payable to "African Wildlife News Service" to: African Wildlife News Service, P.O. Box 546, Olympia, WA 98507-0546.





# 1995 AAZK National Conference

Denver, Colorado

September 24-28, 1995



For those individuals who will not be attending the entire conference, the following rates show the cost of daily registration or single events. These rates apply ONLY to those individuals who do not pay the full registration fee. If you have registered and paid for the full conference, all events listed below are included in that fee. (Excepted is the optional Casino trip, which is an extra charge for full conference attendees.)

**Sunday, September 24**

**Cost: \$26.00**

Open Board meeting

Committee meetings

Evening Event: Icebreaker at the

Denver Museum of Natural History

**Monday, September 25**

**Cost: \$21.00**

Paper sessions

Workshops

AM Break and Lunch

**Cost: \$10.00**

\*Evening Event (optional): Casino

Night in Central City. Includes buffet dinner, 2 drinks, \$2.00 coupon for use in casino gift shop, ice cream cone and two Royal dollars at the Blackjack Table Match Play.

**Tuesday, September 26**

**Cost: \$21.50**

Day at the Denver Zoo. Includes

behind-the-scenes tours, workshops, lunch,

Zoolympics and dinner.

**Wednesday, September 27**

**Cost: \$30.00**

Paper sessions/Workshops

AM Break and Awards Luncheon

Tour of Rocky Mountain Arsenal

Wildlife Refuge

Evening Event: Silent Auction

**Thursday, September 28**

**Cost: \$38.50**

Paper sessions/Workshops

AM Break

Tour of Rocky Mountain Arsenal

Wildlife Refuge

Evening Event: Final Banquet

**\* Registered as a National Historic District, the communities of Black Hawk and Central City are rich in history and natural resources. Once dubbed the richest square mile on earth, the area has retained its mining heritage, and has evolved into Colorado's premier gaming attraction. With approximately 40 casinos offering limited stakes gaming, fine food and entertainment, new visitors are striking it rich!**

1995 AAZK National Conference  
Denver, Colorado  
September 24-28, 1995

CONFERENCE REGISTRATION FORM

Name \_\_\_\_\_

Address \_\_\_\_\_

City \_\_\_\_\_ State/Province \_\_\_\_\_

Zip/Postal Code \_\_\_\_\_ Phone (\_\_\_\_) \_\_\_\_\_

Zoo Affiliation \_\_\_\_\_ Position/Title \_\_\_\_\_

AAZK Chapter \_\_\_\_\_ AAZK Membership Status \_\_\_\_\_

Number of AAZK Conferences you have attended \_\_\_\_\_

AAZK Committee Member? \_\_\_\_\_

Presenting a Paper/Poster? (please circle) Yes \_\_\_\_\_ No \_\_\_\_\_

Title \_\_\_\_\_

Participating in Zoolympics? Yes \_\_\_\_\_ No \_\_\_\_\_

Bringing an Auction Item? Yes \_\_\_\_\_ No \_\_\_\_\_

Optional Activities: (extra charges involved)

Need table in Exhibitors Hall? Yes \_\_\_\_\_ No \_\_\_\_\_

Casino Trip on Monday night Yes \_\_\_\_\_ No \_\_\_\_\_

Pre-Conference Trip A Yes \_\_\_\_\_ No \_\_\_\_\_

Pre-Conference Trip B Yes \_\_\_\_\_ No \_\_\_\_\_

Post-Conference Trip Yes \_\_\_\_\_ No \_\_\_\_\_

Horseback riding on Post-Conf. Trip Yes \_\_\_\_\_ No \_\_\_\_\_

Vegetarian? Yes \_\_\_\_\_ No \_\_\_\_\_ What type? \_\_\_\_\_

T-Shirt? Yes \_\_\_\_\_ No \_\_\_\_\_ Size (L, XL) \_\_\_\_\_

Arrival Date and Time \_\_\_\_\_



**1995 AAZK National Conference**  
**HOTEL REGISTRATION FORM**

Name \_\_\_\_\_

Address \_\_\_\_\_

City/State/Zip \_\_\_\_\_

Telephone \_\_\_\_\_

Arrival Date/Time \_\_\_\_\_ Departure Date/Time \_\_\_\_\_

Rooms will be held after 6PM only if guaranteed with a major credit card. Once guaranteed, there will be no refund for cancellation.

**Credit Cards accepted: VISA, MasterCard, American Express, Diner's Club**  
*(Please Circle)*

Name as it appears on card \_\_\_\_\_

Card Number \_\_\_\_\_ Expiration Date \_\_\_\_\_

**ROOM RATES:**

\_\_\_\_\_ 1 Double Bed                      \$88.00

\_\_\_\_\_ 2 Double Beds                      \$96.00

**\*\*Cots may be set up in rooms for an additional charge of \$10.00\*\***

**\*\*Up to four (4) people may stay in one room\*\***

**\*\*Roommates are the responsibility of each registrant\*\***

**Hotel Check-in: 2:00 PM - Check-out: 12:00 noon**  
**Parking is available at the hotel for a fee of \$7.00 per day.**

**To make reservations by phone, dial 1-800-525-6651**

**Please return this form to:**

**Executive Tower Inn**  
**1405 Curtis Street**  
**Denver, CO 80202**

**Reservations MUST be made by 1 September 1995**  
**in order to receive special Conference rates.**

**1995 AAZK National Conference  
Denver, Colorado  
September 24-28, 1995**

**PRE- AND POST-CONFERENCE TRIPS**

**Pre-Conference Trip A: Friday, September 22**

Visit Colorado Springs with a stop at the Garden of the Gods—hiking trails surrounded by unusual red sandstone rock formations. Next stop is Cheyenne Mountain Zoo, whose base elevation is 6,800 feet! Lunch will be followed by behind-the-scenes tours. We will return to the Executive Inn Hotel in Denver for dinner on your own. **Cost: \$20.00 per person**

**Pre-Conference Trip B: Saturday, September 23**

Join us for a morning ride on the Cog Railway up 14,110 feet to Pikes Peak Summit. Then return for lunch on your own in historic Manitou Springs, filled with charming shops and a variety of restaurants. Early afternoon we will travel to the Pueblo Zoo for behind-the-scenes tours. The staff of this interesting 25-acre zoo then invites us to join them for dinner at their zoo. We will return to the Executive Inn Hotel in Denver after dinner. **Cost: \$35.00 per person**

**Post-Conference Trip: Friday September 29 through Monday, October 2**

Come stay with us at Big Thompson Timberline Lodge located near Rocky Mountain National Park and Estes Park village. We have reserved large 3-bedroom cabins that are fully furnished for all your needs. Activities planned include hiking tours of Rocky Mt. National Park; a scenic drive along Trail Ridge Road which is the world's highest continuous paved highway at 12,000 feet; a tour of the Stanley Hotel where "The Shining" was filmed; plus lots of relaxation and hot tubbing! An optional horseback riding tour, lasting at least two hours, through the secluded trails of the Rocky Mt. Nat'l Park is also available at an additional cost. Please note: We will be returning to the Denver area by approximately 2:00 p.m. on Monday, October 2. Those attending should make outgoing plane reservations AFTER 3 p.m. **Cost is \$150.00 per person . Additional horseback tour is \$30.00**



**Reservations for all Pre- and Post-Conference trips must be received by 1 August 1995. Due to the need to finalize our arrangements, we cannot accept any reservations after this date.**

**For more information about either the Pre- or Post-Conference trips please contact:**

**Linelle Lone (303) 331-5843 or (303) 320-1106**

# 1994 Bowling for Rhino Results and the Ujung Kulon Project

By **Patty Pearthree,**  
National Coordinator BFR  
Indianapolis Zoo, Indianapolis, IN

Fifty-nine zoos or institutions participated in the 1994 "AAZK Bowling for Rhinos" (BFR) fund-raiser. A total of 53 events took place with a few Chapters bowling together. Total monies raised in 1994 (including interest from BFR bank account) was \$106,475.00.

Ten new events took place in 1994. These included Caldwell, Capron, Cheyenne Mtn., Fort Worth, Great Plains, Knoxville, Minnesota, Queens Wildlife Center, The Jungle Club, and Werribee Australia. New events brought in about \$18,000. Overall, totals will be fairly close to last year's \$112,000, so one can say that we had another very successful year in 1994.

Although the top money raisers are singled out for their outstanding work, one significant fact must be pointed out. It is extremely important to have continued participation from everyone if we are going to continue in our success. It doesn't matter how little or how much money is raised by your event; every dollar is crucial to the project and the preservation of the black rhino. Public awareness of the plight of the rhino is a key priority, so whatever it takes to get the word out is incredibly helpful. Remember, it takes about five consecutive years for a fundraiser to take hold where people start to count on it, so it's very important to hold an event each year! It's also fun! In 1992, when Anna Merz, founder of Ngare Sergoi (now called Lewa Wildlife Conservancy or L.W.C.), visited the U.S., she

urged AAZK to expand their funding efforts to include all five species of rhino. Inspired by that request, we researched other conservation possibilities and found Ujung Kulon to be worthy of our support. This is a new area of conservation in its developmental stages, just as Ngare Sergoi was years ago. Ngare Sergoi is now regarded as one of the most successful sanctuaries in all of Africa. We hope to do the same for Ujung Kulon.



The first \$100,000 each year from BFR will continue to go to Ngare Sergoi. All additional money over \$100,000 will be sent to Ujung Kulon National Park in Java, Indonesia which works to save the last 47 Javan rhinos in the world. (Funding to Ujung Kulon will continue each year unless a financial emergency arises at Ngare Sergoi in which case all monies will be sent to Ngare Sergoi.) The folks at Ngare Sergoi are extremely pleased that AAZK is able to support this project as one of Anna Merz's goals is to help save all five species of rhino.

Ujung Kulon is a 300 square mile National Park that is home to some of the rarest plants and animals on earth. It is one of the last remaining lowland rain forests in the world, with hundreds of endangered plants and animals. The annual operating costs of Ujung Kulon is \$75,000, so our contributions go a long way to fund the conservation efforts at Ujung Kulon. Several new guard posts need to be built at the park in strategic locations to curtail poaching. Each new fully-equipped post costs approximately \$11,000

to build. Future projects include wells, a water tower, patrol equipment, patrol boats (Ujung Kulon is on the Western peninsula of Java and access to the park is easiest by boat), and global positioning systems to track the Javan rhino through dense rain forest.

### Note on 1995 Bowling for Rhinos

As of 21 March, 32 Chapters or institutions will be participating in 29 events (some Chapters bowl together). Approximately 30 chapters had not yet reported their intentions, but the potential exists for 52 events to take place in 1995. As a frame of reference, 43 Chapters participated in 1992; 45 in 1993; and 51 in 1994. First time participants this year include the Baltimore Zoo, the Calgary Zoo (Chinook AAZK), the Great Plains Zoo (Sioux Falls, SD), and the Vet Tech Club of Parkland College.

The top two individual fundraisers will

again receive a trip to the Ngare Sergoi Rhino Sanctuary (L.W.C.). Keep in mind that 1 September 1995 is the deadline to have monies sent to Patty Pearthree in order to qualify for the trip and winners must be members in good standing of AAZK, Inc.

### Additional Note:

As Coordinator of the Ngare Sergoi Support Group, I want to extend my heartfelt gratitude to the American Association of Zoo Keepers, Inc. for the time and hard work they have put into the BFR effort. The \$600,000 this fund raiser has donated over the years to the work of Ngare Sergoi proves what a dedicated and caring group of people keepers are. I am privileged to be able to work with such people. —Andy Lodge

Compiled from reports to AAZK, Inc. and to H.O.R.N., the newsletter of the Ngare Sergoi Support Group, Inc.

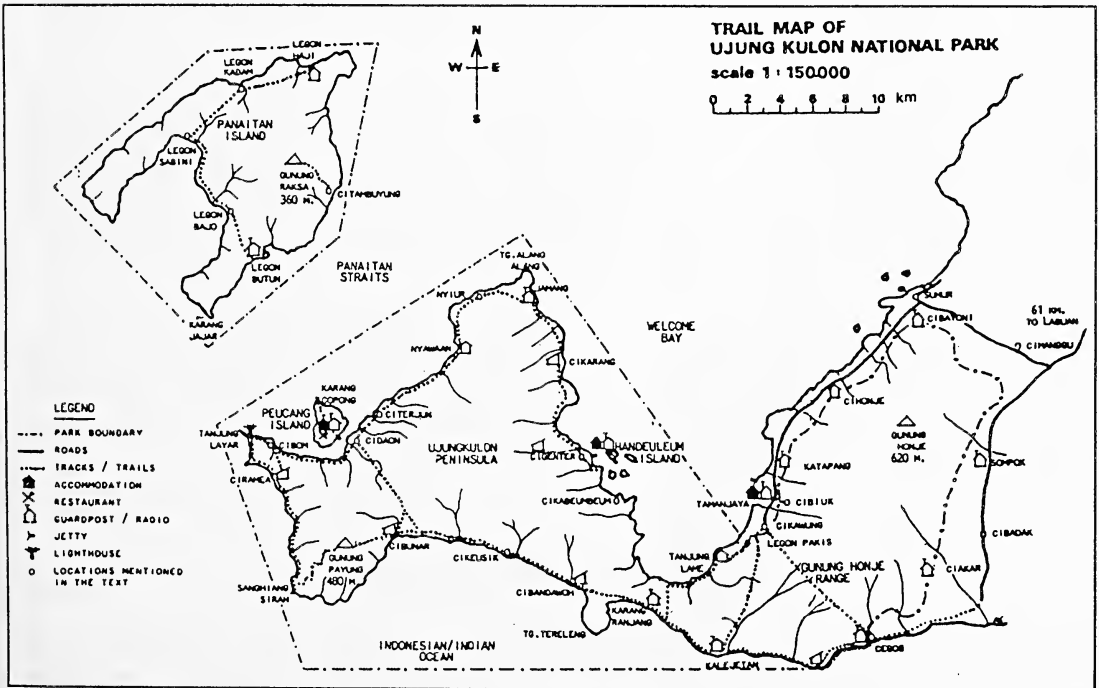

*An Update on....*

# The Exhibit Design Resource Notebook (EDRN)

*submitted by Mike Demlong, EDRN Coordinator  
The Phoenix Zoo, Phoenix, AZ*

**Project Purpose.** The intent of the EDRN is to document existing animal exhibits at zoos, aquaria, and conservation centers in North America and other continents. To accomplish this end, the committee had produced a comprehensive survey form designed to compile pertinent exhibit information on all species of animals: invertebrates, fish, mammals, birds and herptofauna. With a sufficient number of completed survey forms in hand, we hope to produce an informative reference for facilitating the creation or improvement of zoo animal exhibits. Ideally this notebook will provide useful exhibit design and maintenance information about specific species. The EDRN is intended to compliment, not substitute for, a comprehensive research format by exhibit designers, caregivers, curators, or architects.

To date participation in the project has been good with some individuals or institutions returning 10-20 completed forms, others one or two. Regardless, many more completed survey forms are needed to produce the quality publication AAZK is renown for. Without the support of dedicated caregivers - like yourself - the project may never make it to the printer. Keep in mind that your obligation as a member of AAZK doesn't end when you write your annual dues check. It has a non monetary component too which includes active participation at the local Chapter level and participation in national projects (e.g. EDRN, Bowling for Rhinos, articles for AKF, etc.).

The EDRN survey form is relatively painless to complete, taking 15-30 minutes of your time. We are not asking for you to document every exhibit on the grounds, just those you think work well or are of exceptional quality. If you call or write, I'll send you as many forms as you and your colleagues need, free of charge. However, please complete and return all the forms you request within 60 days. These forms are expensive to print and mail so we would appreciate you utilizing all those that you request.

A big Thank You to those who have returned one or more forms, and to those of you who anticipate participating. For EDRN forms or additional information concerning the project contact me at: The Phoenix Zoo, c/o Mike Demlong, Living Collections, 455 North Galvin Parkway, Phoenix, AZ 85008-3431. Office phone # (602) 273-1341 ext. 7426; Fax # (602) 273-7078; home phone (602) 841-6713.

## Information Please

I am presently researching the Owl Faced Guenon (*Cercopithecus hamlyni*). We have 2.1 at the Philadelphia Zoo and I would like any information on basic behavior, reproduction and diet; also exhibits and enrichment. Please send any information to: Denise McClelland, Philadelphia zoo, 3400 West Girard Avenue, Philadelphia, PA 19104.





# HUSBANDRY ALERTS

.....please take note

## Bats

From Susan M. Barnard, Morrow, GA

In 13 years of handraising bats, I have observed only one case of bloat in a big brown bat (*Eptesicus fuscus*), but during the spring of 1995, all bats being handraised bloated, including big brown bats. The sick bats were also hyperactive and many drew up into the fetal position. It was discovered that the milk-replacer, Esbilac®, was the cause of illness and high mortality. Pet-Ag, Inc., the manufacturer of Esbilac®, recently changed the formula to include butterfat, replacing vegetable and coconut oils as the dietary fat.

Because Pet-Ag, Inc. also manufactures Unilac® for The Upjohn Company, be sure to check the ingredients on the label, for this and all other milk-replacers, before feeding them to bats. Only vegetable-based oils may be suitable to supply dietary fat for pups.

If you know of a milk-replacer that has proven successful over several years, please share the information with other bat rehabilitators. Also, listed below is a successful alternative to milk formulas.

### Mealworm Milk-Substitute Infant Bat Formula

Blend together:

Mealworms*	.....	3g
Soy Oil.....	.....	1 dp
Vitamin/Mineral Water **.....	.....	1.5 ml

\*Large mealworms weigh approximately 0.10g

**Tap or distilled water.....	.....	30 ml
Avitron®.....	.....	1 drop (0.05 ml)
Avimin®.....	.....	2 drops (0.10 ml)

Freeze surplus and defrost as needed.

## Keas

From Judie Steenberg, Woodland Park Zoological Gardens, Seattle, WA

Keas (*Nestor notabilis*) are famous in New Zealand for removing rubber parts from around car windows in car parks, but there is a serious danger for keas in allowing them access to rubber. This caution also applies to small stones and wool socks.

A 1.0 kea that died at Woodland Park Zoological Gardens from other causes was found upon necropsy to have small stones and pieces of rubber in his crop. These foreign bodies were not the cause of death but certainly provided a secondary complication regarding his health.

He had acquired the rubber from:

- getting access to a rubber hose
- the metal and rubber stopper-like plugs he pulled out of the pools and chewed on
- a wool sock that appeared to be normal but that had fine rubber threads in it

The wool socks had been recommended as a kea "enrichment" item, but a piece of wool was also found in his crop.

There is always the danger that a bird that is as busy and inquisitive as a kea will ingest something it should not, even from "natural" items. We hope our experience will serve as a caution to others to avoid the use of items that could be chewed into pieces and ingested.

*(EDITOR'S NOTE: Do you have a caution about diet, enrichment items, husbandry practices which might help keep an animal from harm or injury? Share these ideas/experiences with your fellow professionals and help promote the best in quality animal care. Send items to Husbandry Cautions c/o AKF, 635 S.W. Gage Blvd., Topeka, KS 66606-2066.)*

# Chapter News Notes

## North Carolina Chapter

Our officers for 1995 are:

President.....Lucy Segerson  
Vice President.....Kris Swartzchick  
Secretary/Liaison...Jeffrey Phillips  
Treasurer.....Gisela Wiggins

Over the past few months we have assisted our local public television station by volunteering to answer phones during their annual pledge drive. This was a project we undertook last year and has proven to be a lot of fun for all who attend.

On 17 May we held our annual Bowling for Rhinos event; our preliminary total raised was \$2,300.00. At the end of May we hosted a cookout for the Old World Monkey Taxon Advisory Group that was holding its annual meeting at the North Carolina Zoo

At our June meeting, NC Zoo Associate Veterinarian Dr. Terry Norton gave a presentation on his efforts with the Bali Mynah SSP. An upcoming meeting will feature a presentation by Gail Laule of Active Environments.

We have approved the use of Chapter funds for postage to send school supplies to Andy Lodge for use at Ngare Sergoi Primary School. This project had previously been funded by one of our Chapter members.

We continue our fundraiser of selling original notecards featuring four designs: cougar, white rhino, giraffe, and gray wolf. The designs were created by Pilar Lichty and are available for \$1.25 individually or \$1.00 each if you purchase eight or more. You may purchase these by contacting Jeff Phillips at (910) 629-7168.

—Jeffrey Phillips, Sec/Liaison

## San Diego Chapter

Spring has brought many wonderful speakers to the San Diego Chapter. In March we had Bill Toone, Curator of Birds

& Bugs at the Wild Animal Park tell us about butterfly farming in Costa Rica and how it is a great conservation tool.

In April we had Mark Edwards, the San Diego Zoological Society's Nutritionist speak about his field research on howler monkeys and ongoing dietary research going on with a variety of animals.

Our Bowling for Rhinos event was held on 27 May over Memorial Day weekend. It was again a great time for such a good cause.

Officers for 1995 are:

President.....Nicki McGahey  
Vice President.....Trisha Olow  
Secretary.....Jo Ann Haddad  
Treasurer.....Vickie Steele  
New Board members elected were Diane Guerrero and Christina Simmons.

We hope everyone is successful in their fundraisers with Bowling for Rhinos.

—*Nicki McGahey, President*

### **Greater Cincinnati AAZK Chapter**

The past year has been an exciting one for our Chapter. We have been busy raising funds to buy equipment needed at the Emperor Valley Zoo (EVZ) in Trinidad, West Indies. At Christmas we held a very successful bake sale with the help of our generous zoo volunteers.

Spring brought a keeper exchange. Chapter Co-President Dawn Strasser and Emperor Valley Zoo head keeper Nirmal Biptah switched jobs for the month of March. Dawn traveled to Trinidad with equipment (snake hooks, hot feeders, thermometers, etc.) and lots of ideas and information to share. Biptah came to Cincinnati and learned a lot and also gave us an insight into the work of EVZ.

We are continuing to work on getting items for EVZ's wish list. If your Chapter would

like to help, they may contact Karen Creamer at (513) 281-4701 Ext. 8348. Many thanks to all the keepers and volunteers who have helped with this project.

--*K. Creamer, Secretary*

### **The Philadelphia Zoo Chapter**

The rhinos will beat this extinction thing yet, knock on wood...or knock down wood, as the case may be. The Philadelphia Chapter held its Sixth Annual Bowling for Rhinos event on 2 June and it was a pin-smashing success. We raised roughly \$5,000.00 in sponsoring money alone. After all was said and done, we raised over \$7,500.00 for rhino conservation.

This year we tried a couple of new ideas. We set up an AAZK Bowling for Rhinos table in front of our Indian rhino exhibit during Conservation Weekend and accepted donations from the general public. For our first effort at public donation, we met with moderate success, securing another \$200.00 for the rhinos.

Also this year, our Chapter sponsored its members 25 cents for every dollar it raised in sponsorship money. This was not only an effort to increase our money raised, but also to increase our membership. Well, it worked. In the past few months our Chapter picked up five new members and donated \$456.00 to support the efforts of its members. It was voted by our membership that this money, donated by our Chapter, would go directly to Ujung Kulon National Park in Indonesia.

As Chapter Liaison, it is my responsibility to write this report for the Chapter News. But as our Chapter's BFR Coordinator this year, it is my pleasure to express my gratitude for a job well done. This year, more than ever before, it was truly a group effort. My sincerest thanks to our membership and all others for making this year's event a striking success!

--*Ken Pelletier, Chapter Liaison*



# H.O.R.N.



Volume 2, Issue 2

*Help Our Rhinos Now*

Winter 1992

## **The Official Newsletter of the Ngare Sergoi Support Group**

The Ngare Sergoi Support Group would like to thank all the keepers for their support through Bowling for Rhinos. As a means to promote the rhino sanctuary and expand awareness of conservation issues, memberships in NSSG are available. As a member you will:

Receive a year's subscription to H.O.R.N. Newsletter. Quarterly updates on the Sanctuary, future plans at Lewa Downs, black rhino information, a children's column, and a variety of conservation articles appear in each issue.

Obtain a 10% discount on all Ngare Sergoi Support Group products.

Have the satisfaction of knowing that your dollars continue to support and enhance this important and successful wildlife conservation effort.

Your membership dues will help protect the Black Rhinos at the Ngare Sergoi Rhino Sanctuary. Basic membership (in one of the categories listed below) entitles you to the quarterly newsletter, which includes updates on the Sanctuary, and 10% discount on all Ngare Sergoi products.

*New*                       *Renewal*

- General Membership.....\$15.00
- National members, American Association of Zoo Keepers, Inc.....\$10.00
- Student membership.....\$10.00
- AAZK Chapters, Corporations.....\$25.00
- Other -- Contribution.....\$\_\_\_\_\_

Name \_\_\_\_\_

Address \_\_\_\_\_

City \_\_\_\_\_ State \_\_\_\_\_ Zip \_\_\_\_\_

*Ngare Sergoi Support Group is a 501(c)(3) non-profit and tax-exempt organization. Your donation is fully tax-deductible to the full extent allowed by law.*

**SEND Memberships to:**  
Ngare Sergoi Support Group, Inc.  
P.O. Box 29503, Columbus, OH 43229

# AAZK Announces New Professional & Contributing Members

Jim Wellehan, **New England Science Center** (MA); Peter Walsh, **Franklin Park Zoo** (MA); Shana Crook, **Buttonwood Park Zoo** (MA); Kendall B. Rausch and John Goldman, **Bronx Zoo** (NY); Sara B. Schrage, **Reston Animal Park** (VA); Beth Hartsel, **Mill Mountain Zoo** (VA); Dora L. Turner, no zoo listed (NC); Brenda A. McDaniel, **Riverbanks Zoo** (SC); Laine E. Burr, **Jacksonville Zoo** (FL); Carla K. Carson, **Central Florida Zoo** (FL); Amy E. Jameson, **Busch Gardens** (FL); Carry E. Blackwood, **Nashville Zoo** (TN); Willie J. Evans, Kimberly Deer, Ricky Millican, Elizabeth C. Mack and Tammy H. Fuller, **Memphis Zoo** (TN); Lisa M. Nicoll, **Indianapolis Zoo** (IN); Ardi Marlo Kornak, **Binder Park Zoo** (MI); Sandra Koslowski, **Minnesota Zoo** (MN); Robert W. Anderson, **Racine Zoo** (WI); C.J. Nyc, **Lincoln Park Zoo** (IL); Richard Ward, **Kansas City Zoo** (MO); Caryn Michelle Mosier and Natasha Avara, **Sedgwick County Zoo** (KS); Noel Newman and Valerie Beardsley, **Dallas Zoo** (TX); Tracy L. Rhodes, **Ellen Trout Zoo** (TX); J.C. Whitney and Amy Backo, **Houston Zoological Gardens** (TX); James Dobberstine, **Moody Gardens** (TX); Wendy Gardner, **Cheyenne Mountain Zoo** (CO); Mari Ellen Brown, **Tautphaus Park Zoo** (ID); Virginia A. Hinojosa, **Wildlife World Zoo** (AZ); Laurent Guilbault **Société Zoologic de Granby** (Quebec); Bridget Burke-Johnson, John Armstrong, Charles Van Vilet, Kim Meehan, Christine Whittles, Erin McMurray, Mellisa Viet, Jane Mueller, Lydia Attard, Randy Siwek, Andrew Lentini, Gavin Small, Dan Pearson, Luisa Steinsky and Mike Khambani, all from **Metro Toronto Zoo** (Ontario).

## Renewing Contributing Members

Andy Lodge, Ngare Sergoi Support Group, Inc., Columbus, OH

Richard Block, Vice President of Scientific & Program Development  
Indianapolis Zoo, Indianapolis, IN

# THE GOURMET RODENT™

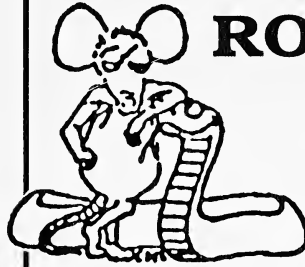

## RATS AND MICE

Bill & Marcia Brant  
6115 SW 137th Avenue  
Archer, FL 32618  
(904) 495-9024  
Fax (904) 495-9781

© All Rights Reserved

## Need to Reach AAZK?

1-800-242-4519 (U.S.)

1-800-468-1966 (Canada)

FAX: (913) 273-1980

or write

AAZK, Inc.  
635 S.w. Gage Blvd.  
Topeka, KS 66606-2066



# Black Rhino Husbandry and Breeding at the Cincinnati Zoo

*Submitted by Adrian Haft, Animal Keeper  
Cincinnati Zoo & Botanical Garden, Cincinnati, OH*

The black rhino (*Diceros bicornis*) at the Cincinnati Zoological and Botanical Garden began on 4 April, 1957, with the acquisition of our first pair of black rhinos. This pair produced its first offspring on 27 July, 1961. Since that first birth, we have had 16 additional births. The success of our breeding program has been a direct result of the commitment made by several people to save the black rhino from extinction - our Director, Ed Maruska, this institution and all of the people who have been involved in this program.

Presently, our black rhinos are housed in a facility that contains three stalls. The perimeter walls of these stalls are constructed of concrete block on the interior and gunite on the exterior. The walls between are constructed of eight-inch poured concrete and each wall is 9 ft. (2.74m) tall. Two walls measure 15 ft. x 16 ft. (4.57m x 4.87m), while the third is 12 ft. wide by 20 ft. long (3.65m x 6.0m). The floors are concrete with a light broom finish and slope toward a gutter that runs the length of all three stalls. Each stall is equipped with vertical bars, positioned in the front, that are seven inches in diameter (18 cm), spaced 13 inches (33cm) apart and are 7 ft. tall (2.13m).

Water is provided by troughs with walls that are four inches (10cm) thick, 13 inches (33cm) deep and 1 ft. 7 in. x 2 ft. 3 in. (.53m x .70m). These are filled by a manual fill line from outside of each stall. There is a barred window between each stall that measures 4 ft. x 5 ft. (1.2m x 1.5m).

There are shift doors between each stall and each stall has a door that is accessible to the outside enclosure or exhibit yard. These are solid doors, constructed of 4" x 6" (10cm x 15cm) wooden boards, framed by five-inch square tubular pipe, and operated on a hydraulic system. These doors measure 7ft. tall x 5ft. 6 in. wide (2.13m x 1.70m). A chute outside one of the stalls allows the opportunity to manipulate animals in a safe manner (i.e. medical exams, etc.). It is 4 ft. (1.2m) wide and can be lengthened from 7 ft. (2.1m) to 11 ft. (3.35m) easily. The building also has a load ramp that accesses the building directly into one of the stalls.

There are two exhaust fans in the ceiling that provide ventilation for the building. Lighting in stalls and service areas is provided by fluorescent lighting. The heat source is a forced-air furnace.

The outside enclosure is oval in shape and measures 100 ft. x 120 ft. (30.5m x 36.6m). The substrate is a mixture of limestone soil and grassy areas. There is a pool in the center of the enclosure which measures 26 ft. x 19 ft. x 3 ft. (7.9m x 5.8m x .91m) at the deepest part. A gunite wall surrounds the outside enclosure.

Food provided is 1-2 flakes of alfalfa in the morning; 3/4 - 1 whole bale alfalfa in the afternoon, along with 10 qts. Mazuri® ADF-16 large pellets, six apples, six carrots, and six

bananas with 2 Tbsp. trace mineral salt and six vitamin E capsules. Honeysuckle and mulberry are offered for browse as often throughout the year as it is available.

The rhinos are hosed thoroughly every morning, removing any fecal matter, urine, dead skin, and hay.

The temperature guidelines for giving animals access to the outside enclosure are as follows: 35°F (2° C) depending on cloud cover and dampness. During the colder temperatures, animals are only allowed outside for a few hours.

To tell if a female is cycling, we watch the behavior of the male. He is more aggressive, sprays urine more often, and vocalizes more. The female cycles approximately every 28-30 days and this behavior lasts for about two days. Once estrus is determined, the male and female are introduced. Heavy sparring may occur occasionally when the male will lift the female off of the ground. When the female comes into full estrus, the male usually places his chin on the female's rump and tests her and will then attempt to mount. If she's ready, she will stand for copulation which usually lasts for 20-30 minutes. Gestation is approximately 490 days.

At approximately 10-12 months into the pregnancy, the female is separated from the male. Additional bars are added between the existing bars of the stalls to aid in prohibiting the calf from walking between the bars. At the time the female is separated from the male, she is given access to two stalls. Alfalfa bedding is added after the calf is born. The calf is weaned and separated from the mother at approximately 8-10 months of age.

As zoo keepers, our responsibility doesn't only lie in the everyday husbandry of the animals in our care. Our responsibility is also in the concern that many of the species on this planet are in serious jeopardy. Although we may not contribute to saving the black rhino from extinction by being involved in SSP programs, etc., we all play an important role in our everyday husbandry of these animals. We should all feel proud to have the opportunity to care for these magnificent animals.

For further information on the Cincinnati Zoo's black rhino program, contact Paul Reinhart, Head Keeper, Ungulate Dept., Cincinnati Zoo, 3400 Vine St., Cincinnati, OH 45220-1399.

*(Editor's note: According to the June issue of the AZA Communiqué, the Cincinnati Zoo & Botanical Gardens recorded its 17th black rhino birth on 9 December 1994 and holds the world's record for black rhinoceros births in captivity.)*

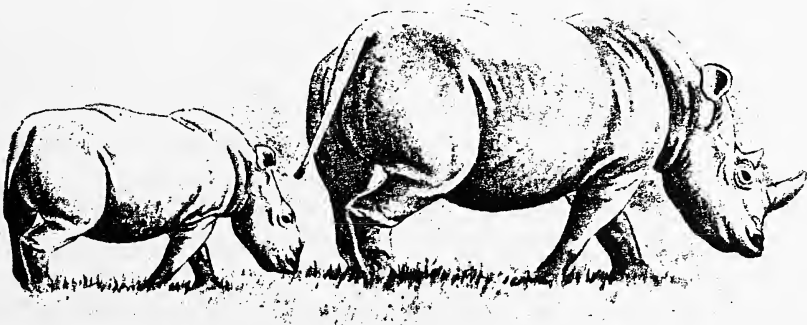

# Ujung Kulon



by Robert Berghaier, Senior Keeper  
The Philadelphia Zoo, Philadelphia, PA

Our land rover lurched from left to right and then quickly back to the left again, as Mr. Gatot tried to avoid the gaping holes on the road's surface. He managed to miss two out of every three. I had previously about journey to the Pearthree of the Zoo had told me it road she had ever I'd already seen having traveled remote areas of Tanzania, Peru, Zaire, but Patty this one beat them which runs from small fishing Sunda Strait, to the headquarters Kulon Park, is say that the route, constructed by the a complete understatement. thinks they should and start over). At

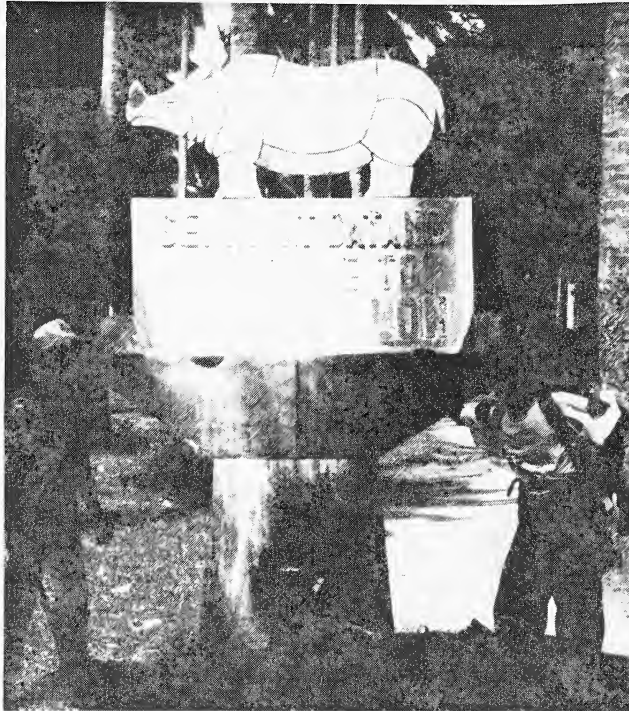

been warned this part of the park; Patty Indianapolis was the worst seen. I thought the worst, through Madagascar, and Eastern was right—all. This road Citeureup, a village on the Taman Jaya, of Ujung dreadful. To originally Dutch, needs overhaul is an (Mr. Gatot just scrap it its best it's

bad, and progressively turns into worse, horrible, and just plain unbelievable. Ruts, potholes, sections of asphalt gone, and entire pieces of the roadway missing; all were frequent features. It took three and one-half hours to travel the thirty kilometers to Taman Jaya.

Ujung Kulon may be known to many readers of *AKE*. It is the park in Indonesia that will be the recipient of extra monies raised by "Bowling for Rhinos"; money that will be used to protect the reserve's population of the Javan rhinoceros. My purpose in coming here was to get a first-hand look at the Minnesota Zoo's "Adopt a Park" program. This innovative project provides funds needed to upgrade the Ujung Kulon's infrastructure. The Philadelphia Zoo, my institution, would like to start a similar type of aid program for Sapo National Park in the West African nation of Liberia. Bill Konstant, Vice President of the Zoo's Conservation Department, thought it would be a good idea to get someone from the zoo's staff to see how "Adopt a Park" looks on the ground to a visitor to Ujung Kulon. He knew that such a visit could provide insights that could be useful when Philadelphia's Sapo program was ready to start. So, in late September 1994, I found myself in Java.

Our land rover carried five people. Only three of us, Benny the guide, Munif the cook, and myself, would travel into the park. My outfitter, Mr. Gatot, and his driver would return to Citeureup.



We finally arrived at park headquarters. It comprised some new and well-constructed buildings with an adjacent satellite dish. This piece of equipment extends the range of the park's radio network; radios which were recently put into place by the Minnesota Zoo. Inside the headquarters building were some great photos of the elusive Javan rhino, along with park information, maps, and regulations. It was here that two other members were assigned to our party: a porter and Zaikam, the ranger. All visitors entering the park must be escorted by a ranger and Zaikam turned out to be an excellent choice on Mr. Gatot's part.

It took us an hour to gather our supplies and gear and set off for our first destination, the ranger post at Kalejetan. We started off walking through the villages of Taman Jaya and Cikawung.

The area surrounding this part of the park is densely settled. There are houses grouped tightly together along both sides of the road. It was a particularly long, dry season. The rice paddies were nothing more than a brown, dried stubble. Scattered small groups of domestic water buffalo were grazing the remnants. Very little green was evident on the ground, and what little color there was was provided by coconut trees scattered around the dwellings or in clustered groves of trees.

The people, mostly of Sundanese origin, appeared healthy and cautiously friendly. Benny explained that each village or "kampung", has its own school and dispensary. The schools dressed their students in clean, neat uniforms, with each institution having a different color. Having grown up in Philadelphia, it reminded me of how the parochial schools within the city followed the same practice. The children were most curious about me, this "orang asing" (white foreigner), walking through their villages. When they saw me they would stop what they were doing, point me out to their classmates, and speak the only English most of them knew, "Hello, mister".

A kilometer south of Cikawung the dwellings and rice paddies petered out and changed to scrub as we passed the park entrance demarcated by a sculpture of a Javan rhino on the column. Short, thick sunlit brush changed quickly into tall, dark, shaded forest. Some of the trees started showing the thick buttresses indicative of more mature growth. We were now past the buffer zone and well within the park. A few times we heard a crashing noise as groups of wild pigs fled from our small party. A break for lunch gave us the opportunity to find two long-tailed macaques who hurried off in the trees 40 feet above our heads. We would come across the pigs and the macaques often during my six-day visit to the park. Ujung Kulon was quickly showing me why many consider it one of Asia's finest wildlife preserves.

The air temperature was hot and it was humid. However, the paths in this part of the park were level and easily traversed. About six kilometers into the journey I could hear the distant murmur of waves hitting a shore. At each bend in the trail the level of noise increased. We stopped to take a short break along a ravine.

Munif, Benny and Zaikam started puffing away on cigarettes. Indonesian men smoke like chimneys; although I'm sure if I would have asked them not to they would reluctantly have agreed. It seemed unfair of me to ask them to stop, so I didn't. These smoke breaks would be a frequent feature of my dealings with Indonesians.

As we sat a greater racket-tailed drongo with its long, thin tail feathers flew slowly at eye

level through the ravine. Back lit by sunlight filtering through the forest canopy, it appeared like an apparition.

The break was interrupted by the sudden appearance of four men walking towards us along the trail. Zaikam recognized them immediately and invited them to join us. Cigarettes were passed around. Benny explained that these men were the rangers who staffed the Kalejetan post and were en route to the park headquarters for a meeting. While sitting with us they told Benny and Zaikam that a rhino had been seen by the post a few days before. As we all got ready to leave for our respective destinations the lead ranger gave Zaikam the key to the station. That meant that we would sleep under a roof that night.

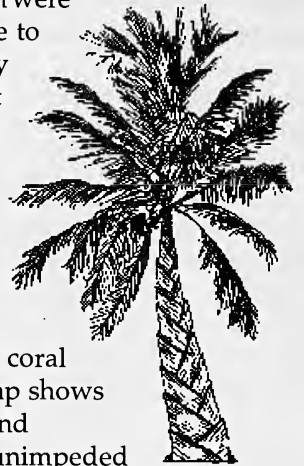

As we traveled closer to our destination the sound of the waves increased until it became a loud crescendo. The forest thinned out and changed into a Pandan tree thicket. The sea was now in view. Large waves crashed into seaweed-covered coral reefs. The noise was nearly deafening. A look at a world map shows that except for Christmas and the Cocos Islands, there is no land between Antarctica and southwest Java. A wave could travel unimpeded from one shore to the other, which helped explain both the size of the waves and the noise that they created on this wild south coast of the park.

We settled in for our first night in the park. The Kalejetan ranger post was a tiny ramshackle structure. The cabin steps and front deck were completely rotted away. The metal roof had several large gaping holes. The Indonesian word for station or post is "resort" and "Resort Kalejetan" was painted on this broken, worn, dilapidated structure. I was amused by the use of the word, "resort" on such a shack since it was far from a resort as far as I was concerned. Next to this disaster, the New Zealand Park Service had laid the foundation and wall for a more modern and comfortable structure. This would be the future guard post.

To me this was the essence of the "Adopt a Park" and other aid programs. How can we imagine that rangers, who live in conditions of such deprivation like Kalejetan, could properly perform their duties? If this assistance did not exist, should we expect that these men would be motivated to protect this park and the rhinos which we so cherish? I think any one of us would be hard pressed to carry on in such difficult living conditions.

Near dusk Zaikam took Benny and me for a walk in the forest. We saw a black giant squirrel, a draco flying lizard, and some large black bats with long, narrow wings. One of them had whitish wings which I eventually identified as a pouched tomb bat. Benny spotted the squirrel. He eventually turned out to be a good animal spotter, much to his own surprise. Munif had dinner ready when we returned. After the meal we washed up using fresh water drawn from a nearby well.

Before we retired to sleep a band of seaweed collectors crowded around the post. Benny suggested that I gather my gear and take it inside. He gave me no real reason, just the rather cryptic response that, "we are not alone now". Our party would come across these groups of men and, on occasion women, throughout this part of Ujung Kulon. They supposedly have permits to be here in the park to collect seaweed. The seaweed is gathered and dried on the beaches of the south coast. The dried seaweed is carried out of the park in

sacks and eventually processed to be used as a food additive. Except for some limited tourist income, it is probably the only source of real cash that local people can realize from Ujung Park. I have to question, however, whether a reserve whose main purpose is to protect such rare and easily poached species as the Javan rhino needs dozens of unsupervised individuals moving through its, "protected" environs. Throughout my travels in the south of the reserve the only ranger on patrol I saw was Zaikam. He diligently approached every group of seaweed collectors we came across. Zaikam would blow his whistle, which would sometimes scatter the collectors, then gather them together, check their papers, and either nod in acceptance or complain with obvious displeasure.

My night in Resort Kalejetan consisted of interrupted sleep. Four of us— Benny, Munif, Zaikam and I— were packed tight together on the wooden floor of the "resort". Several times throughout the night I awoke with the weight of some type of animal across my covers on my ankles. Whether it was geckos or rats, I don't know since I wasn't up to viewing my protagonist with a flashlight. I raised my feet under the covers and shook them. The weight would disappear and I would go back to sleep until I awoke to the next round of pressure on my ankles. The next day several welts appeared elsewhere on my body where some small creature had bitten me during the night.

We awoke at six, washed, ate breakfast, and headed down the trail to our next destination. Zaikam started pointing out animals almost immediately. There were more macaques and giant squirrels and a new species, the lutung- the Javan black langur. The langur was once considered by primatologists to be a subspecies of the silver langur, but has since been granted full species status. It is a graceful, agile creature, which moves through the forest quietly like other members of its genus. Langurs take long, almost noiseless leaps from tree to tree. The macaques, in comparison, give many clues to their whereabouts by their clumsy movements through the forest and frequent vocalizations.

We came upon several strangler figs, large vine-like trees which twist around a hollow center. This gap is the only evidence of the vanished tree that was used by the fig as a trellis to support its growth. This process causes the strangulation death and quick decay of its victim. On many of these fig trees were bird nest ferns, which are epiphytes. Epiphytes employ a tree as a support to reach sunlight, an important survival technique in a tropical forest. Its extended leaves collect rain and falling detritus from the forest canopy to be used as a source of water and nutrition. It was here that Zaikam pointed out a sapling that had been pushed over by a rhino —most likely the deed of the animal which had been spotted a few days ago.

The trail crossed open beach and I was able to identify Pacific reef-egret, Pacific golden-plover, and collared kingfishers. Getting an accurate ID of the birds throughout this trip proved to be a difficult undertaking. I consider myself to be a decent birder and I know the avafauna of South America, Africa, and North America fairly well. Learning to "bird" in a new region, Southeast Asia, was as difficult for me as attempting to learn a new language.

Within two hours we arrived at the ranger post Karang Ranjang. In contrast to Kalejetan this was a real "resort". This post had been recently built with the construction financed by the "Adopt a Park" program. It was a stark but sturdy concrete structure, able to survive the relentless onslaught of tropical termites. Concrete is also easy to keep clean and it is hard for vermin, such as those that inhabit Kalejetan, to get established. We slept on beds and mattresses. Bed linen was not provided, but I had brought my own.

The forest around the post held a wealth of wildlife. There were more giant squirrels, large water monitors, skinks, geckos, and small Indian civets that visited at night. On the beach I found fresh bantang track, white-bellied fish-eagles, and a blue colored sea snake. The snake appeared to be in distress. Since sea snakes are very poisonous, I carefully picked it up with a long stick and placed it in some shade. I came back a few hours later, but it had died.

A walk in the forest in late afternoon produced more langurs, macaques, pigs, and two new mammals- the black banded and striped ground squirrels. This stroll took us to the north shore of the reserve. The sheltered bay of this sector did not have the noise and turmoil of the south. The shore was packed with driftwood and huge fallen trees were strewn across the beach. We saw whimbrel and striated heron here.

The next morning the five of us set out for a trek to the Cibandawoh shelter, about six kilometers to the west. The route passed through an area that reportedly has a few families of the Javan gibbon. Although Zaikam tried diligently and we spent a few hours of hard walking through dense forest, we did not see or hear any gibbons. We saw more giant squirrels and macaques, and I got a good look at a tree shrew. Birds included a group of immature white-bellied fish-eagles, grey-headed fish-eagles, great crested terns, banded kingfishers, greater racket-tailed drongos, slender-billed crows, rufus woodpeckers, and scarlet minivets.

Again the scenery was spectacular. Wide sandy beaches, coral reefs offshore, and beautiful forest surrounded us. There was the wreckage of several fishing boats scattered along the beach, along with the more common flotsam of nets, buoys, and plastic containers.

The most engaging sight was two sets of cat tracks which traversed parallel to each other, for about two hundred yards up the beach until they disappeared into the forest. Zaikam identified the smaller of the two sets of tracks as the prints of a leopard. The larger set he identified as tiger. Tigers were reported to have become extinct in Ujung Kulon sometime during the 1960's. I took photos of the tracks with a ruler next to them. When I returned to the States I examined my slides, compared them to sketches of leopard prints from Africa, and found that both sets fell within the track size range of that species. It's unlikely that the larger prints were of a tiger; however, the issue continues to intrigue me.

We returned to Karang after lunch. A walk in the forest near dusk turned up more squirrels, tree shrews, and lesser mouse deer. Off in the distance we heard the vocalization of a barking deer. On our return, a walk to the post well gave me an excellent look at a hollow-faced bat and a water monitor that ran off quickly at our approach.

My porter told me that he had seen three bantang near the well that morning. He asked if I would be interested should he see others. I quickly said yes. At 6:30 p.m. I heard a slight knock at my door. I opened it and found the porter excitedly saying "Mister, bantang like morning". I grabbed my flashlight and followed him towards the well. Just before we reached the well I heard a snort, and a female bantang bolted back into the forest. The size of the animal ( as large as a Cape buffalo yet leaner) and its rapid departure startled me. I turned my flashlight into the forest and quickly picked up the white legged and impressive black body of a male bantang moving away from us. Seeing such big animals on foot and in such close proximity is an intense experience. Later that night two more civets returned to the station hoping to find some food scraps to eat.

Ujung Kulon is an incredible place to observe wildlife. Some of my luck had to do with having a good ranger— Zaikam. It was also a very long dry season which may have caused the animals to move about at a greater pace and therefore be more easily seen. The reserve is also primarily secondary tropical forest. This is a habitat that attracts a greater concentration of mammals than climax vegetation. Whatever the cause, I saw more wildlife here than I had observed during my visits to the Amazon forests of Peru and Ecuador.

At dinner Benny told me how frustrated Zaikam was in not finding gibbons that day. He told Benny that gibbons and the surili, the Javan gray langur, could be found within a fifteen minute walk from his house in Taman Jaya. This was a very interesting bit of news. From my previous discussions with people who had visited Ujung Kulon I knew that these endemic Javan primates were difficult to spot. Since we were heading back to Taman Jaya the next afternoon, Benny suggested a change in plans. We would now hike back to Zaikam's house first thing in the morning.

My fourth day in Ujung Kulon started at dawn. I was more charged up than usual, anticipating the day ahead so much that I ate breakfast while standing. Benny asked me twice to sit down and eat, and I was somewhat aware of the rest of the party and the post personnel looking at me oddly. Benny took me by the arms and sat me down on a bench in front of the building. He asked me to please understand that the Sundanese have lots of superstitions about the forest; one of which involves sitting while eating. It is considered an omen of bad luck if an individual stands while taking food.



Benny had already told me about another local superstition, the Nyl Loro Kidul, queen of the South Sea. This goddess allegedly lures male swimmers wearing green while bathing on the south coast of Java and Bali to her underwater realm, never to be seen again. This legend seemed to me to have a grain of truth though not from the intervention of any goddess. I mentioned previously how rough the waves are on this shore of Java. It seems conceivable that the bodies of drowning victims could easily be swept out to sea without a trace in such turbulent water.

By 7:00 a.m. we were on our way to Taman Jaya. We walked to the north coast and along the beach. The only wildlife we saw were a pair of macaques, but Zaikam pointed out the tracks of bantang, rusa deer, leopard, and a smaller cat that could have been a fishing or leopard cat. Both are the only small cats found on Java.

The distribution of mammal species throughout the Indonesian archipelago is a bit of a biological puzzle. For example, why does Java have two endemic species of langur and its own gibbon; while southern Sumatra, which is just a 20-mile distance across the Sunda Straits, share the agile gibbon and the silver langur with southern Borneo which is 300 miles to the east? The most puzzling to me is why the leopard is found only on Java and not elsewhere in Indonesia, while the tiger is still found in Sumatra and once ranged through Java to Bali?

Our walk through the north beach was blocked by a small brackish stream. Benny gave me the option of crossing the ankle-high water or using a nearby log bridge. My feet were showing the effects of three days of hiking by the appearance of some painful water blisters. I did not relish having to spend the rest of the day with wet and blistered feet, so I opted for

the foot bridge. The bridge consisted of two 30-foot logs with a thin wooden handrail laid across the banks of the stream about three feet above the water. Even though the mouth of the creek was ankle deep, this section was obviously of greater depth.

I started across confident of my ability to traverse this obstacle. After all, I had crossed more difficult and shaky structures in the Ecuadorian Amazon just last year. I was two-thirds across when I heard Benny asking me to be careful. I remember thinking that I was using my left hand to hold the railing, and that the left hand is considered unclean in this part of the world. At that exact moment the railing snapped. I staggered for a second, lost my balance, and plunged face first into the water. I went under, put my feet down, found the bottom, and stood up. Fortunately, the stream was only waist deep. All of a sudden it hit me. I was carrying all of my film and camera gear in my day pack and both it and I were soaking wet!

Benny and Munif quickly worked their way along the bridge and I handed them my pack. I slugged across the creek's muddy bottom and used some mangrove roots to pull myself out of the water. I was a wet and muddy mess, but my film and lens cleaning gear were wrapped in plastic sandwich bags. (I had always been taught to protect my equipment and clothes this way while traveling in tropical forests. You can bet that I'll continue to do so in the future). My camera and lens were not covered but they remained water tight. I had forgotten about my binoculars strapped to my waist, and they took some water in the right lens. Two days of drying in the sun cleaned the lens except for a few small water spots. Unfortunately however, they were useless that day. The value of carrying an extra pair, which I had lent to Benny to use, would now pay off.

Everyone was very helpful and worried about my welfare and the state of my gear. I was somewhat angry at myself at first, but I realized that the results could have been much worse. Zaikam and I started towards Taman Jaya. Ben, Munif, and the porter looked at each other and ran ahead of us. I could hear them laughing off in the distance. I knew that they had gotten an excellent view of my fall. It must have been an amusing sight, seeing my large body sway and topple into the water. I asked Benny about the incident later. He apologized sincerely and said that he

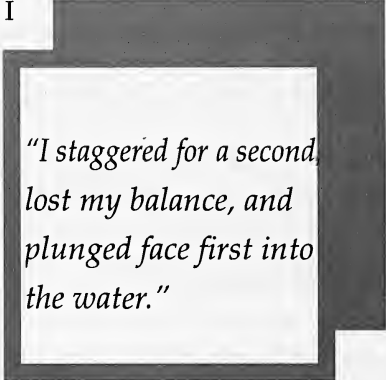

*"I staggered for a second, lost my balance, and plunged face first into the water."*

hoped I was not angry. He said that once they realized I was fine and my camera was safe, the humor of the incident took hold. He said that the three of them looked at each other and, realizing they could not control their laughter, ran up ahead so I would not be embarrassed. I told him that if I was in their place I probably would have laughed as well.

I later told Benny that I thought that it was a coincidence the bridge railing broke at the exact moment I was thinking about using my left hand. Benny disagreed, convinced my fall was caused by not sitting while I ate my breakfast. He then related an incident that he witnessed when he was undergoing his training as a tour guide.

Benny's class was visiting a Hindu temple on the island of Bali. One of his female classmates was boasting that she was going to enter the temple even though she was menstruating. I have seen notices in front of temples in Bali (written in English as well as Indonesian and Sanskrit), asking

women not to go in when they are in this condition. Benny said that after she crossed the temple doorway, she was on the floor within seconds having seizures. The others in the group carried her outside. The local Balinese insisted that a priest would have to exorcise her, this being the only way she could ever "return to normal". Sure enough, a priest arrived and after a few chants the seizures stopped and the woman recovered. Most Westerners would say that her dilemma was caused by a psychosomatic reaction to the poster warning. That incident, and my own on the bridge, not only make interesting stories but also give the skeptic (myself, for example) something to ponder.

On the rest of our walk through the mangroves the only wildlife I saw were a great-billed heron, banded kingfisher, and tiny fiddler crabs who waved their enlarged fighting claws at us when we ventured too close. They would then disappear into their burrows in the mud.

We trooped past the rhino statue at the park entrance and left the buffer zone. Zaikam invited us to stop for a short break at a house on the edge of the park. The occupants were getting prepared for a wedding the next day. They offered us candied rice cakes to eat and boiled water to drink. I asked if I could photograph the women and young girls of the house while they prepared rice for the wedding feast. They shyly agreed. It has been my experience that Indonesians like to have their pictures taken and seem to be flattered by the attention.

It was a short walk from here to Zaikam's house. It was here that the porter, who guided me to the bantang, parted company with us. He had shown me kindness throughout our trek as well, so I gave him a good tip. Ten U.S. dollars might not seem like a lot of money to us, but to an average Indonesian earning only \$2.00 per day it is quite considerable.

Zaikam's house was a stark but clean, comfortable structure made of wood and bamboo. The house sat on small concrete supports to raise it above ground level. The first thing I noticed upon entering was that in spite of the heat and humidity outside, the interior was dark and cool. I suspect that the materials used in its construction allowed a cooling exchange of air. The dwelling was shaded by a grove of coconut trees which probably helped keep the inside temperature low. The coconuts were used for food and the husks provided a source of fuel.

The family had its own well located at the rear of the structure. The water could be used for washing but had to be boiled for drinking. Indonesians were always sure to tell you that the water they were offering you was boiled and therefore safe to consume. Next to the well was an enclosure where the family bathed and did its toilet. The waste was washed down a stone slab to fertilize a small vegetable garden. A small chicken coop was located in the back and the birds were fed leftovers scraps from the family's meals. The entire complex appeared to stress simplicity and self-sufficiency as much as possible.

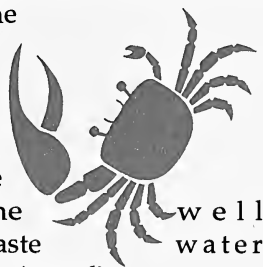

well  
water

Zaikam's wife cooked a tasty lunch of rice and fried eggs. After our meal I had Benny ask Zaikam how he had become a ranger. It seems that when Ujung Kulon was established, Zaikam's father was employed as a park laborer. He helped open up some of the original trails into the park and helped build the first ranger posts and bridges. Zaikam said that his father always impressed upon him the importance of the park and that he should respect the forest and the wildlife of the reserve. He was so moved by his father's dedication he

decided to become a ranger, and has been one for over 20 years.

At 1:00 p.m. we set off for Cibiuk, a hot spring just north of Zaikam's house. We walked through villages and then rice fields with grazing water buffalo until we reached a wooden fence that marked the boundary of the park. Crossing through a gate we entered a dry, almost leafless forest. We came to a small stream and Benny told me to place my hand in the water and take a swallow. The water was warm to the touch and had a slight sulfur flavor and odor. The temperature, odor, and taste of the water were an indication of volcanic activity in the area. Java, as well as most of Indonesia, is located on the so-called Pacific "Ring of Fire". The region is seismically active and is therefore prone to earthquakes and volcanic eruptions. The lack of human settlement of the Ujung Kulon peninsula is partially due to the eruption of one such volcano, the infamous Krakatau, in 1883. The eruption, one of the most violent in recent human history, devastated this region of Western Java.

After taking our leave of the hot springs I saw a form brachiating through the forest. It was a Javan gray gibbon. This species looks very much like the blond form of the white-handed gibbon. We counted three of them. I glanced at my watch. Fifteen minutes had passed since we had left Zaikam's house. The gibbons did not seem to be afraid of us, but they moved so quickly that they were difficult to photograph. While trying to do so I blundered into a nest of fire ants; a few of which landed on the back of my neck. They bit me several times before I could brush them off. While following the gibbons we found the surili, or Javan gray langur. This was the third of Java's endemic primate species. Satisfied, we left the forest and retraced our route back. While crossing the rice paddies, I heard the sharp screech of a raptor. I looked up and saw a black eagle, one of Indonesia's largest birds of prey, soaring overhead.

We continued our walk back through the villages to the Taman Jaya dock. It was here that I met Yanto and Iman, the captain and mate of our cabin cruiser. My next three nights in Ujung Kulon would be spent on this boat. We set out across Welcome Bay for a ten kilometer trip to Handeuleum Island, passing through a large flock of feeding lesser crested-terns.

Handeuleum is part of a small group of coral islands located off the north shore of the park. There is a comfortable guest house here along with a hiking trail. While Benny arranged some permits for me, I took a walk with Zaikam. There is a wealth of wildlife about, both terrestrial and aquatic. I saw rusa deer including several stags, long-tailed macaques, water monitors on the trail, and mudskippers, sea slugs, and sea cucumbers along the shore.

We left the island and anchored off the mainland near the mouth of the Cigenter River. At night we could see numerous kerosene lamps from fishing boats and bagangs, a type of fishing platform, off in the distance. There were so many they could almost be mistaken for distant stars low in the night sky. The lamps are used to attract fish which are either hooked, netted by hand or on the platforms, or scooped up by large underwater nets.

The Cigenter River is the best place to spot the Javan rhino. I knew that seeing one was going to be a matter of luck. For example, Zaikam, despite all the time he has spent in the park, has seen rhinos only 22 times. He has observed four of them while canoeing the Cigenter.

The next day Benny, Yanto, and Zaikam paddled a canoe up the river while I sat up front hoping to be one of the few to actually see this creature. While we saw no sign of rhinos, we did see a wealth of other animal life. Due to the extended dry season we had to do more



walking than usual, and had to hike to the rock terraces upstream that form the falls of the Cigenter. We spotted a common palm civet, giant squirrels, a tree shrew, more macaques, and lutungs. There were water monitors and the others saw crocodiles and pythons. (I was either slow to turn to look or trying too hard not to lose my balance so I missed them). Bird life was prolific; I identified crested serpent-eagle, pink-necked green-pigeon, hill myna, rhinoceros hornbills, and blue-eared and banded kingfishers.

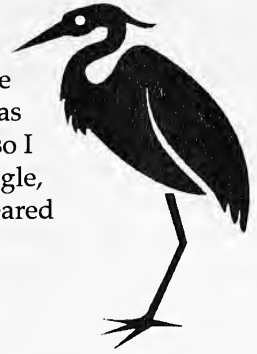

Near dusk we returned to an open grassland near the mouth of the river. Here we saw blue-tailed bee-eater, green jungle fowl, and several magnificent green peafowl. The males were particularly wary and ran or flew off quickly when they spotted us. A walk through the forest turned up plantain and black-banded squirrels.

Zaikam also found rhino tracks that were about a week old. The prints were the size of a large pie plate with two clefts that differentiated the toes. He also pointed out some small saplings that the rhino had pushed over. I am not sure if the animal does this to browse on the leaves of the trees. Whatever the reason, it does make a distinctive sign. I can see why biologists, rangers, or poachers for that matter, find rhinoceros so easy to track.

A recent photographic survey of the Javan rhino in the park estimated that 40-50 individuals survive. The researcher believes that Ujung Kulon's carrying capacity is 80 animals. He recommended that the park needs more effective patrolling. To accomplish that aim, the reserve's rangers will need to be better trained, motivated, and equipped. The value of "Adopt a Park" and "Bowling for Rhinos" funds to support Ujung Kulon now becomes apparent. However, it is up to the Indonesian Park Service and Government to develop the policies necessary to make this endeavor succeed. No amount of aid can influence the situation unless these agencies are ready to make the effort.

Our goal on this walk in the forest was to reach the alang-alang, 12-foot high grass at the rear of the savannah. The alang-alang was scattered amongst several sunbaked mud wallows. Though I have never been to India, the scene reminded me of pictures of Bengal tiger habitat. This reserve must have been wonderful tiger country at one time. There was lots of cover and water with a plentiful prey base. Instead of gaur, the wild cattle of India, we found three female and two young male bantang. No sambar, as in India, but we saw the tracks of the closely related rusa deer.

Back on board the boat we bathed in the ocean and had dinner. Through Benny I was able to follow the conversation. I got Zaikam talking about tigers and he related that he has seen three in his lifetime. Yanto, the boat captain, said that while acting as a beater in a wild pig hunt in Baluran Reserve in East Java, he saw a tiger run past him. This incident occurred in 1977. It was a convincing story, and Yanto described very clearly the difference between a tiger and a leopard. Although upon my return to the States I came upon a reference that stated that the last tiger sighting in Baluran occurred in 1964; Yanto's story makes that reference doubtful.

Early the next morning we returned to the savannah. Zaikam led me to a small clump of trees and we watched two bantang and their calves come close enough for photographs. Nearby were more peacocks and jungle fowl which proved to be too distant or elusive for

the camera. Zaikam took me back into the forest to retrace the route we had taken the day before. Bird life was more active at this time of day. I identified black drongo, slender-billed crow, and banded pitta.

Where we had seen bantang the day before, there was now a group of six rusa deer, hinds and fawn. I knelt to take pictures and Zaikam took his pack off. Still standing, he started moving his arms and swaying his body back and forth. I thought his behavior a bit odd, but turned my attention to getting pictures of the deer. The entire group stared at Zaikam until I started taking photos. At the first click of my camera the deer looked at me. At the second click they bolted deeper into the alang-alang and out of sight.

Zaikam and I walked further back in the high grass and we came to another small mud-caked clearing. I heard some movement to my left, and ducked low to see under some bushes. A group of wild pigs ran off before I could get a good look at them. Turning to my right I saw two large striking pigs. My first thought was to wonder what warthogs were doing here in Java. These pigs had tusks and some small growths coming from the sides of their faces. I raised my camera to take a picture, but the animals ran off before I could click the shutter. I realized then that I had most likely seen the Javan warty pig. Later, Benny asked Zaikam what it was and he identified it as the "new pig", the name local people have given the warty pig. They believe that this species is, in reality, a forest spirit and not a real animal. This endangered wild swine was reported to be extinct in Ujung Kulon in a 1987 survey of the species and was not found on a camera trip survey of the park's rhinos in 1993. It is however, still listed as being found in the park by the visitor's guide published in 1993. I later got to observe and photograph the common wild pig on Sumatra and Rinca Island. These animals did not look like the two pigs I had seen that day. I feel almost certain that it was the warty pig I had spotted that morning in the high grass. If that is the case, it was an excellent sighting of a rather rare creature.

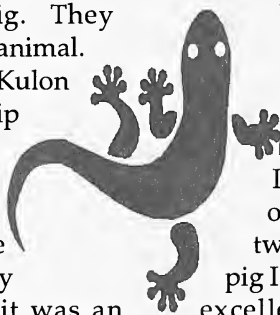

Zaikam and I walked back through the forest and found Benny. After questioning Zaikam, Benny started laughing and asked me if it was true that Zaikam danced for the deer. So that's what the ranger was doing when we spotted the rusa deer! We returned to the boat and Benny told the others about the deer dance. Yanto, Munif, and Iman thought it was rather amusing. Benny told me later that Zaikam said that he always dances when he finds rusa deer to keep them still. Zaikam's movements evidently mesmerize the animals and hold their attention so that others can see them better. It does seem to explain the actions of the deer I had seen that morning. A few days later back in the village of Citeureup, I met some men who were friends of Zaikam. They asked if he had danced for the deer in my presence. When I said he had, they laughed and told me that among the tour guides of the region Zaikam is well known for this particular antic.

We had to return to Taman Jaya a day sooner than expected because we had run low on fresh water. After docking the boat, Benny and I returned with Zaikam to his house. We ate an excellent lunch of chicken and rice and drank tea flavored with brown sugar. After a bath and a nap, the three of us headed back to Cibiuk hot spring.

We reached the forest by 3:00 p.m. and saw two surilis, the gray langur. At our approach they moved off quickly. There was no sign of the gibbons we had seen just a few days before. Zaikam led us to the east where we came upon a strip of green forest along the

Taman Jaya River. The river level was low and we were able to travel along it by hopping from rock to rock. The forest lined both sides of the banks and we could see up to the top of the canopy on either side. We soon found a group of five surilis and a pair of wreathed hornbills. Both species were active and not shy so we got excellent looks at them. This was an idyllic patch of forest. It was getting near dusk so we had to return to the boat. As we walked back along the river we heard several groups of gibbons start their round of late afternoon calls. On the way back to Zaikam's house we heard and saw a black eagle. It was near the same rice paddy at which we had spotted one a few days earlier, and this one was probably the same bird or its mate.

Ujung Kulon Park is one of the best areas for wildlife viewing I have ever seen, and its existence on the island of Java is indeed a surprise. Java is reputed to be the most heavily populated area for its size in the world. Agriculture and its accompanying pressures on wildlife has existed on the island for over 3,000 years. I find it remarkable that any wildlife can be found at all, much less in such numbers as in Ujung Kulon.

We returned to Zaikam's house and said our good byes. I would spend the night on the boat and leave the next morning by sea to Citeureup. Benny paid Zaikam his salary and I gave him a good tip. I also gave him a World Wildlife Fund T-shirt with a pygmy chimp on it that he had admired during one of our earlier hikes. In return, Zaikam handed me one of his hand-carved wooden Javan rhinos. It was a wonderful parting gift. Benny took a few pictures of us together, which I sent him prints of after I returned home.

Before I left, Zaikam asked me not to forget him. I know that I won't. Nor will I forget his country and its park, Ujung Kulon, which he works so hard to protect.



#### Please Help!

Even though C.I.T.E.S. (The Convention on International Trade in Endangered Species) has banned the international trade in rhino products, five countries still blatantly continue this bloody practice. The governments of these five countries, **Taiwan, China, South Korea, Thailand** and **Yeman** turn a blind eye to this trade and it is allowed to flourish. Help save the Rhino!

*Please Boycott products made in these countries and consider writing a letter to their representatives at these addresses:*

#### **China**

Ambassador Zhu Qizhen  
2300 Connecticut Ave NW  
Washington, DC 20008

#### **South Korea**

Ambassador Hong-Choo Hyun  
2320 Massachusetts Ave NW  
Washington, DC 20008

#### **Thailand**

Ambassador ML Birabhongse Kasemsri  
2300 Kalorama RD NW  
Washington, DC 20008

#### **Taiwan**

Coordination Council for North American Affairs  
4201 Wisconsin Ave NW  
Washington, DC 20016

#### **Yeman**

Ambassador Hohsin A Alaini  
2600 Virginia Ave NW  
Washington, DC 20037

# **L.I.N.K.**

## **(Liaison and Information Network for Keepers)**

Coordinator for the LINK System: Mark de Denus, Assiniboine Park Zoo, 2355 Corydon Ave., Winnipeg, Manitoba, Canada R3P 0R5. (204) 986-6921 [w]; (204) 837-2916 [h]. Assistant LINK Coordinator - Ric Urban, Houston Zoological Gardens, Houston, TX, 1513 MacGregor Way, Houston, TX 77030 (713) 520-3234 [w].

### **Regional Coordinators**

- ALABAMA** - Fred Alvey, Zoo Atlanta, 800 Cherokee Ave. S.E., Atlanta, GA 30315  
**ARKANSAS** - Debbie Jackson or Ann Rademacher, Little Rock Zoological Gardens, #1 Jonesboro Dr., Little Rock, AR 72205  
**CALIFORNIA (Northern)**- Jean Lai, Oakland Zoo, 9777 Golf Links Rd., Oakland, CA 94605  
and Ruby Lara, Sacramento Zoo, 3930 West Land Park Dr., Sacramento, CA 95822-1123  
**CONNECTICUT** - Jeanette Nadeau, Roger Williams Park Zoo, Providence, RI 02905  
**DELEWARE** - Theresa Maas, Philadelphia Zoo, 34th & Girard Ave., Philadelphia, PA 19104  
**FLORIDA** - Rick Smith, 4707 Walden Circle #409, Orlando, FL 32811  
**GEORGIA** - Fred Alvey, Zoo Atlanta, 800 Cherokee Ave. S.E., Atlanta, GA 30315  
**IDAHO** - Holly Liappas, Tautphaus Park Zoo, P.O. Box 50220, Idaho Falls, ID 83405  
**ILLINOIS** - Pat Swieca, 5710 W. Cullom Ave., Chicago, IL 60634  
**INDIANA** - Jan Weinig, P.O. Box 197, Michigan City, IN 46360  
**IOWA** - Carla Wieser, Omaha's Henry Doorly Zoo, 10th St. & Deer Park Blvd., Omaha, NE 68107  
**KANSAS** - Brian Kohler, Lee Richardson Zoo, P.O. Box 499, Garden City, KS 67846-0499  
**KENTUCKY** - Scott Wright, Cleveland Zoo, 3900 Brookside Park Dr., Cleveland, OH 44109  
**LOUISIANA** - Rhonda Votino, 3535 Houma Blvd., Apt. 109, Metairie, LA 70006  
**MAINE** - Jeanette Nadeau (see addresses under CT)  
**MARYLAND** - Theresa Maas, Philadelphia Zoo, 34th & Girard Ave., Philadelphia, PA  
**MASSACHUSETTS** - Jeanette Nadeau (see addresses under CT)  
**MICHIGAN** - Tim Sampson, John Ball Zoo, 1300 W. Fulton, Grand Rapids, MI 49504  
**MINNESOTA** - Tim Hill, Minnesota Zoological Gdns., 13000 Zoo Blvd., Apple Valley, MN 55124  
**MISSISSIPPI** - Jeannie Frazier, Jackson Zoological Park, 2918 W. Capitol, Jackson, MS 39209  
**MISSOURI** - Brian Kohler, Lee Richardson Zoo, P.O. Box 499, Garden City, KS 67846-0499  
**MONTANA** - Holly Liappas (see address under Idaho)  
**NEBRASKA** - Carla Wieser (see address under Iowa)  
**NEVADA** - Patricia Simonet, Wildlife Safaris, P.O. Box 6735, Incline Village, NV 89450  
**NEW HAMPSHIRE** - Jeanette Nadeau (see addresses under CT)  
**NEW JERSEY** - Frank Leonard, Bronx Zoo, 185th & Southern Blvd., Bronx, NY 10460  
**EAST NEW YORK** - Frank Leonard, Bronx Zoo, 185th & Southern Blvd., Bronx, NY 10460  
**WEST NEW YORK** - Alan Baker, Burnet Park Zoo, 500 Burnet Park Dr., Syracuse, NY 13204  
**NORTH CAROLINA** - Kristin LaHue, Riverbanks Zoo, P.O. Box 1060, Columbia, SC 29202-1060  
**NORTH DAKOTA** - Bob Debets, Assiniboine Park Zoo, 2355 Corydon Ave., Winnipeg, MB Canada R3P 0R5  
**OHIO** - Scott Wright, Cleveland Metroparks Zoo, 3900 Brookside Park Dr., Cleveland, OH 44109  
**OKLAHOMA** - Debbie Jackson or Ann Rademacher (see addresses under AR)  
**OREGON** - Anna Michel, Washington Park Zoo, 4001 SW Canyon Rd., Portland, OR 97221  
**PENNSYLVANIA** - Theresa Maas, Philadelphia Zoo, 3400 W. Girard, Philadelphia, PA 19104  
**RHODE ISLAND** - Jeanette Nadeau (see addresses under CT)  
**SOUTH CAROLINA** - Kristin LaHue, Riverbanks Zoo, P.O. Box 1060, Columbia, SC 29202-1060  
**SOUTH DAKOTA** - Bob Debets (see address under ND)  
**TENNESSEE** - Gail Karr or Cindy Pinger, Memphis Zoo & Aquarium, 2000 Galloway, Memphis, TN 38112  
**TEXAS** - Connie Dieringer, Caldwell Zoo, P.O. Box 4280, Tyler, TX 75712  
**VERMONT** - Jeanette Nadeau (see addresses under CT)  
**VIRGINIA** - Theresa Maas, Philadelphia Zoo, 34th & Girard, Philadelphia, PA 19104  
**WEST VIRGINIA** - Theresa Maas, Philadelphia Zoo, 34th & Girard, Philadelphia, PA 19104  
**WISCONSIN** - Wayne Hazlett, 3768 S. 89th St., Milwaukee, WI 53228  
**WYOMING** - Holly Liappas (see address under Idaho)  
**DISTRICT OF COLUMBIA** - Theresa Maas (see address under PA)  
**Provinces of Manitoba & Saskatchewan** - Bob Debets (see address under ND)  
**Provinces of Alberta & British Columbia** - Grant Tkachuk, 9955 114th St. Apt. A, Edmonton, AB T5K1P7  
**Atlantic Canada** - Bernard Gallant, RR # 7, 1081 Ryan Road, Moncton, N.B., E1C 8Z4

Vacancies exist for the following States or Provinces: Alaska, Arizona, Southern California, Colorado, Hawaii, New Mexico, Utah, Washington, Ontario and Quebec.

# Zoo Infant Development Two-Volume Reference Set

Edited by Harmony Frazier, LVT, Woodland Park Zoo, Seattle, WA and  
Kathleen Hunt, B.A., Dept. of Zoology, University of Washington



The American Association of Zoo Keepers, Inc. is pleased to announce the availability of an important reference work. This 1820-page, two volume set is a reference manual of the physical and behavioral development of parent-reared mammal infants in captive collections. These volumes include normal rearing information and weights for many species and can be quickly utilized for quick comparison and reference when deciding whether an infant is being properly cared for or is in need of intervention.

The volumes are divided into four sections: 1) Infant Development Data Sheets (a total of 419 individual records); 2) Weight Data (including many charts and graphs); 3) Bibliography (144 pages of bibliographic references) and 4) Index (species included are indexed by both common and scientific names). The Infant Development Data Sheets and the Weight Section are subdivided by color coded taxonomic order tabs. The Zoo Infant Development Notebook is packaged in two sturdy 2-inch expanded D-ring binders and include a full-size page lifter for ease of use.

To order, fill out the form below and return with your payment to: AAZK, Inc. ZIDP Notebook, 635 S.W. Gage Blvd., Topeka, KS 66606-2066 U.S.A. Checks or money orders should be made payable to "AAZK, Inc." (U.S. FUNDS ONLY). If using a credit card, make sure to complete all requested information on form. Prices are:

AAZK Members \$125.00

Nonmembers \$150.00

Prices include Domestic Book Rate Postage. Overseas orders must add \$40.00 for parcel post surface shipping. Canadian orders will be mailed within Canada. Please allow 4 - 6 weeks for delivery.



## ZIDP ORDER FORM

I wish to order \_\_\_\_\_ copy (ies) of ZIDP Notebook. (Please Circle)    AAZK Mem.    NonMem.

Name: \_\_\_\_\_

Address: \_\_\_\_\_ City: \_\_\_\_\_

State/Province: \_\_\_\_\_ ZIP/Postal Code: \_\_\_\_\_ Country: \_\_\_\_\_

I wish to pay by:    CHECK/MO    MASTERCARD    VISA

CREDIT CARD # \_\_\_\_\_ - \_\_\_\_\_ - \_\_\_\_\_ - \_\_\_\_\_    Expiration Date: \_\_\_\_\_

Name as it appears on credit card (please print) \_\_\_\_\_

Signature: \_\_\_\_\_    TOTAL ENCLOSED \$ \_\_\_\_\_

# Training as a Tool for Routine Collection of Blood from a Black Rhinoceros (*Diceros bicornis*)

by Anna Michel, Animal Keeper;  
Michael Illig, Senior Animal Keeper  
Metro Washington Park Zoo, Portland, OR

## Introduction

The black rhinoceros (*Diceros bicornis*) is one of the world's most critically endangered mammals. Black rhino numbers have dropped from an estimated 60,000 in 1960 to a current level of under 2500 (Maruska, 1993). The captive North American population as of 1 July 1993 was 98 individuals (Maruska, 1993). As wild populations decline, successful management of captive populations becomes increasingly important. Captive breeding of black rhinos has been disappointing and is not adequate to maintain the genetic diversity of the captive population (Maruska, 1993). The 1992-93 American Zoo and Aquarium Association (AZA) Rhino Taxon Advisory Group report emphasizes the need to intensify research on reproduction, nutrition, and health in these animals (Reece, 1993).

Basic information on reproductive cycles of black rhino females is critically needed. Equally important is the development of safe and consistent methods to monitor these reproductive cycles in captive rhinos. Reproductive physiologists have developed assays for saliva, urine, and feces with some success, as possible safe methods to monitor hormonal changes (Czekala, 1989; Berkeley, pers. comm.). Blood, however, remains the most direct medium for examining ovarian function (Czekala, 1989), and the development of non-invasive procedures such as fecal and urine steroid hormone analysis should be validated by correlation with serum hormone concentrations (Berkeley, pers. comm.). Blood hormone levels are measured less frequently due to the difficulty and risks of obtaining samples (Berkeley, pers. comm.). Techniques for safe routine blood collection in rhinos would facilitate not only reproductive research, but also nutrition studies, artificial insemination and veterinary work.

In 1991, animal keepers and researchers at Metro Washington Park Zoo (MWPZ), Portland, OR, became interested in following the onset of puberty in a young female black rhino. We planned to look simultaneously at behavioral and physiological measures of reproduction (behavioral observations four to five times each week and via serum progesterone levels in blood). Initially, it was intended to modify our existing restraint chute so that routine blood collection from an unanesthetized animal could be safely accomplished. It became apparent that a chute remodel was not possible given the restrictions of building design and budget. As an alternative to manual or chemical restraint of the female rhino, a program of training was initiated using an operant conditioning, positive reinforcement technique. Training offers the advantage of reduced stress to the animal (Bloomsmith, 1992; Laule, 1992; Reichard, 1992), and may allow for more reliable sample collection (Laule, 1992; Reichard, 1992). Additionally, we reduced the possible effects of stress or anesthetics on our blood samples and on the animal's behavior (Bloomsmith, 1992). The objective of this study was to train the female rhino to cooperate with keepers and to obtain weekly blood samples without the use of restraint or anesthesia.

## Method

MWPZ maintains 1.1 black rhinoceros: "Miadi", the female born 4 November 1988 at the Brookfield Zoo in Chicago and "Pete", the male born 7 May 1988 at the Denver Zoo. The rhino holding units are in the same building as the hippo holding areas. There are three indoor holding areas for rhino: one 5.5m by 5.8m (18 ft. x 19 ft.); one 5.8m by 6.4m (19 ft. x 21 ft.); one 4.6m by 5.5m (15 ft. x 18 ft.); and one partially covered outdoor holding area 5.5m by 4.9m (18 ft. x 16 ft.). Each is connected by hydraulically controlled doors. Holding units are divided by concrete filled metal posts spaced approximately 20cm (8 in.) apart. The outdoor exhibit yard is 36.6m by 12.2m (120 ft. x 40 ft.) with a pool at one end. The rhinos are housed separately, in adjacent rooms at night and share the exhibit yard during the day. Training takes place along a specific section of posts in Miadi's holding area. No other interaction with the rhino takes place in this specific area.

Our goal was to train voluntary cooperation with blood collection without the use of a restraint device or anesthesia. This involved two separate training phases. First, training Miadi to come on command and stand parallel to the bars with her head steady during the procedure. Second, to desensitize Miadi to the equipment and handling necessary to draw blood. One keeper was designated as the primary trainer until the rhino reliably executed the behaviors required for successful blood collection.

The first step was to train her to come to a specific spot; essentially to "target" to the trainer's hand on command. The command was "Miadi, come". The word "good" was used as a bridge and apples were used as the reinforcement for the appropriate behavior. After she was responding consistently to the "come" command, a second trainer was added to increase her reliability by scratching her belly with a long handled scrub brush. This continuous reinforcement also encouraged her to stand parallel to the bars.

The next step was to train the rhino to hold her head stationary. The primary trainer used the command "stay" while holding her front horn against the bars. These behaviors were shaped for approximately nine weeks until consistent.

Once the female rhino was reliably coming on command and holding her head still with her body parallel to the bars, desensitizing her to the procedures necessary for blood collection was begun. Two additional keepers, who would eventually be performing the actual venipuncture, were then introduced to the process. Manipulation of the rhino's ears was begun by rubbing and pinching them. A tourniquet was draped over Miadi's ear, working gradually toward tying it around the ear. The rhino was then desensitized to the smell of an iodine based antiseptic and to having her ear scrubbed.

Concurrently, the rhino was introduced to the equipment used for drawing blood. A 21-gauge butterfly infusion set with a 12" tube on a 6cc syringe was used. The keepers let the tube and syringe hang near her eye and face until the rhino showed no reaction to the equipment. A blunted practice needle was pressed against the dorsal surface of the ear, gradually adding pressure until again the rhino exhibited no reaction. The desensitization process took about five weeks.

The two keepers who drew the blood had previous experience performing venipuncture. Procedures were established by the zoo's research veterinarian and a training session

was done using pygmy goats to verify the correctness of the keeper/phlebotomist's techniques.

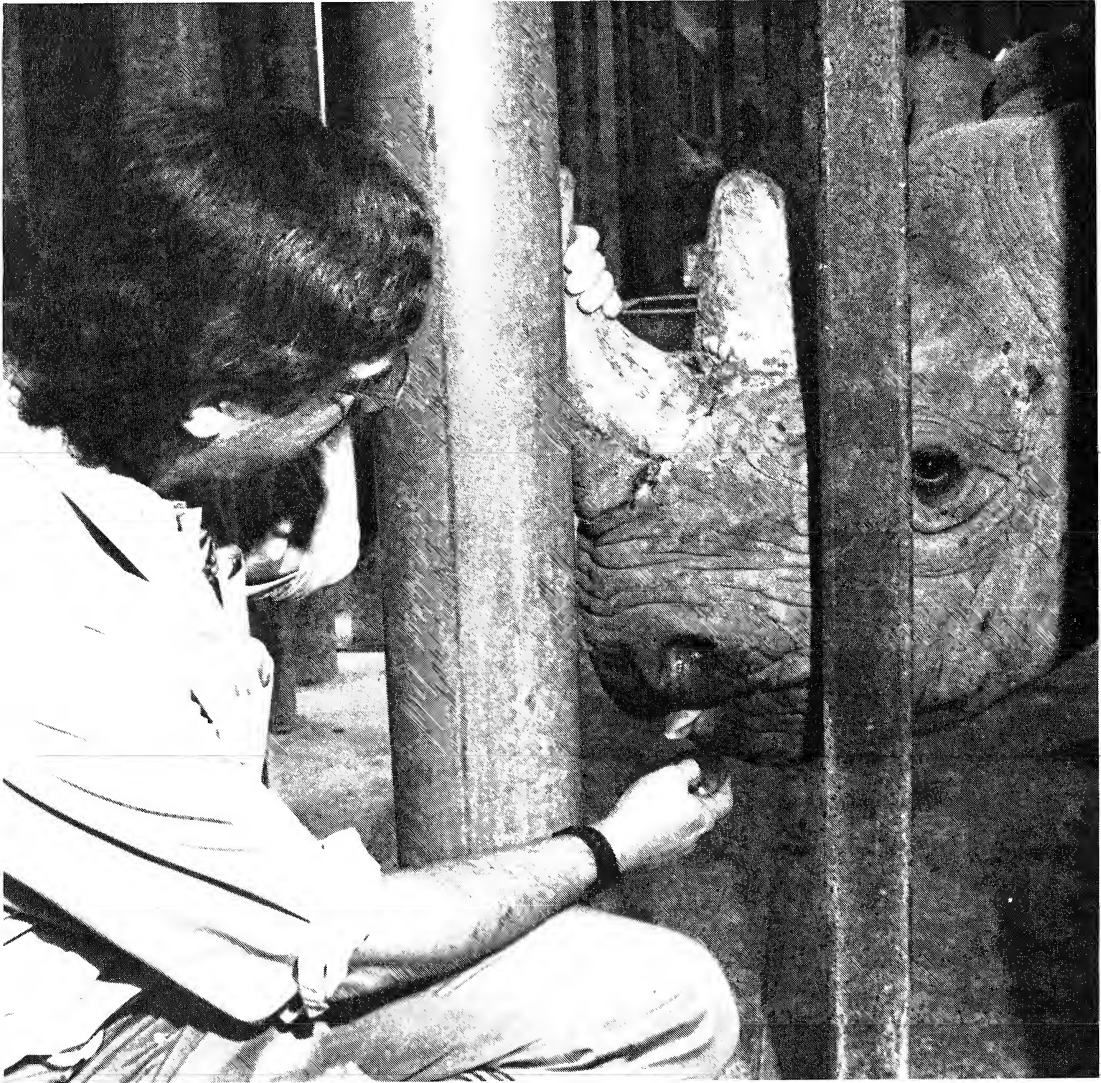

**Keeper Michael Illig delivers a reinforcement to the rhino for holding her head stationary.** (Photo by Michael Durham)

On days that blood was drawn, heat in the building was raised to approximately 85 ° F (29.4° C) for two hours prior to the procedure. This aided blood collection by dilating the veins of the ear and increasing blood flow. Signs were also posted outside the building warning that the blood draw was in progress to prevent unexpected interruptions that could startle the rhino or the phlebotomist. Blood was successfully drawn after a total of approximately five months of training. Weekly samples have been obtained from that time to the present with plans to continue indefinitely. Details from analysis of these blood samples are in preparation ( Michel et. al., in prep). We have confirmed that this female is cycling but to date, is not pregnant. Low levels of progesterone correspond with reproductive behavior (Mellen et. al., in prep).



Each week approximately 5cc of blood are drawn. The procedure takes five to ten minutes. The sample is centrifuged and the serum is frozen. At six-month intervals the samples are analyzed for progesterone levels. Since November of 1994 weekly hematocrit testing has also been done.

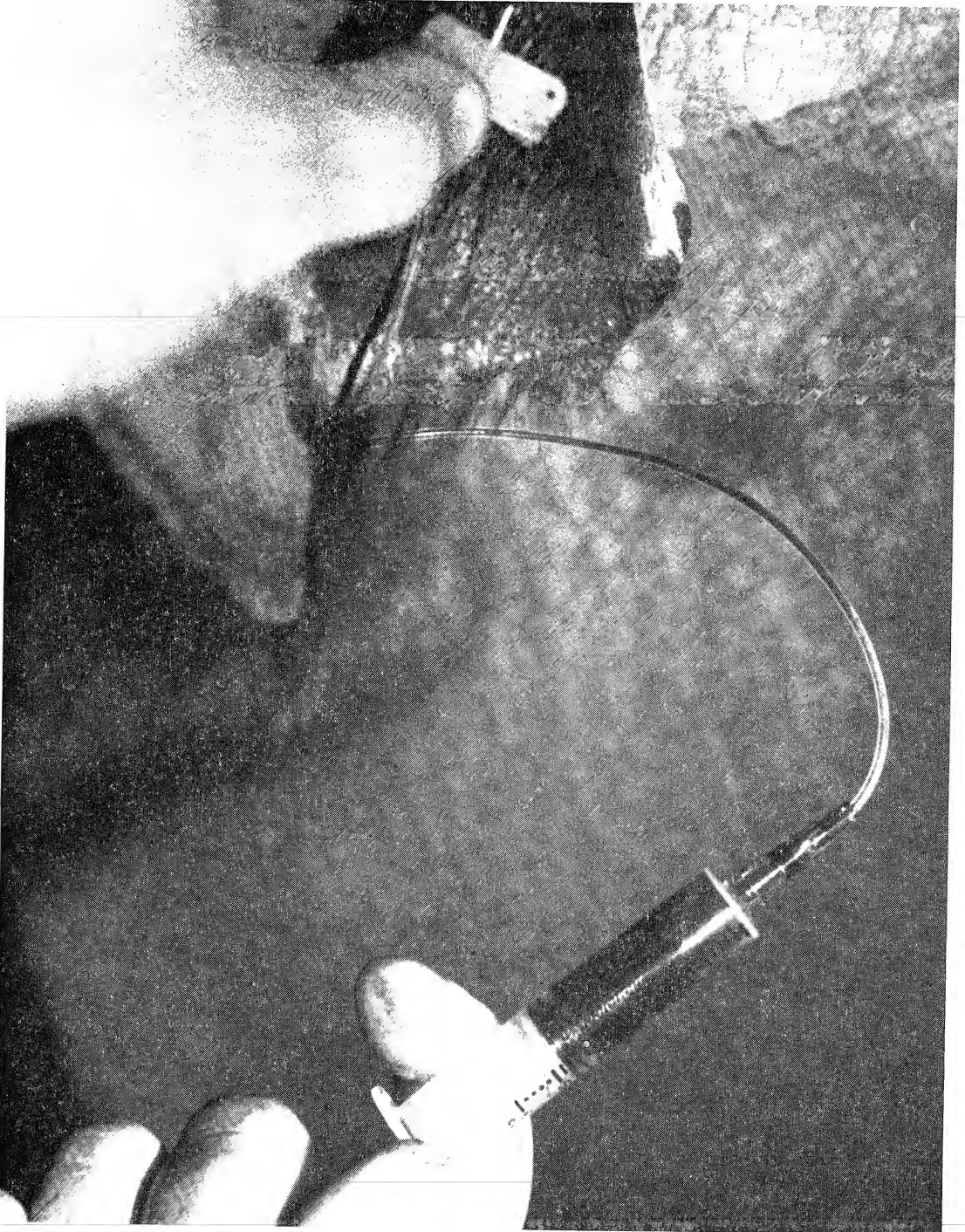

**Blood is drawn from an ear vein using a 21-gauge butterfly infusion set with 12-inch tubing. Keeper David Illig draws blood from our female rhino Miadi.**  
*(Photo by Michael Durham)*

## Discussion

The first blood draw from Miadi was performed on 15 May 1993, approximately five months after training was begun. The rhino exhibited almost no reaction during the initial blood draw and continues to fully cooperate with the procedure. She has become so comfortable with the procedure that she will tolerate observers and cameras as well as changes in personnel. It is felt that the success of this project may be due in part to the exclusive involvement of animal keepers, those who work routinely with the rhino, for training and blood collection.

Blood collection has become a routine procedure in which our female rhino readily cooperates. This procedure has been successful every week without the use of restraint or drugs at any time. This training regime has also allowed us to take temperatures and do simple physical exams and medical treatments, in addition to blood collection.

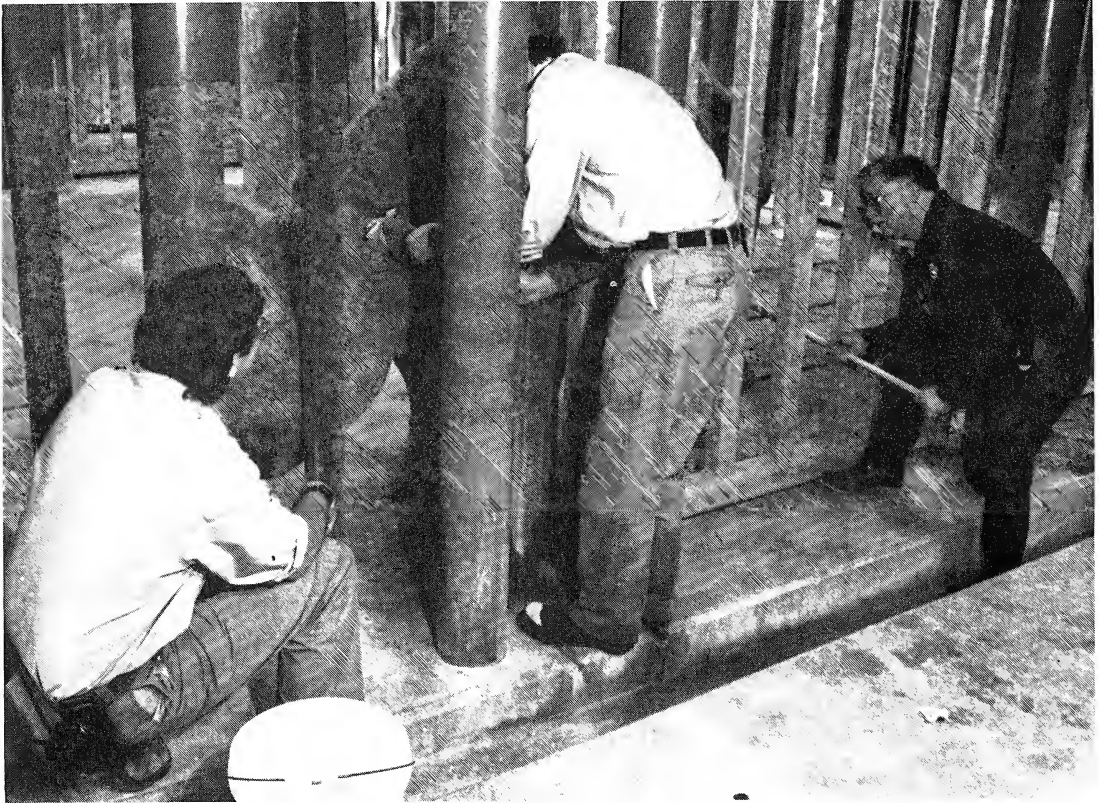

**Blood has been drawn from our female rhino every week for two years using positive reinforcement training. Michael Illig, David Illig and Lee Jensen are shown in the process of drawing blood. (Photo by Michael Durham)**

Data from these blood samples have allowed us to track the female rhino's estrous cycle and to monitor her for pregnancy. The procedure has proven safe for both the animal and staff. The rhino's ear can be accessed easily through the stall bars without danger of the phlebotomist becoming injured by an agitated animal. It appears to be non-stressful for the animal and after the initial training, requires little time. We have collected successfully on days when our female rhino has been in estrous and therefore in an excited state. In fact, the procedure may actually have a calming effect on her.

We feel that we will be able to get blood from her in the event of a medical emergency. After over a year and a half of weekly blood collection, it is felt that training is a safe and practical approach to blood sampling.



**Keeper Lee Jensen demonstrates continuous positive reinforcement. This aids in aligning the rhino parallel to the bars of her enclosure.** (Photo by Michael Durham)

### **Acknowledgments**

The authors gratefully acknowledge animal keepers David Illig and Lee Jensen for their weekly participation in this project; animal keeper Diane Gould, for discovering the continuous reinforcement technique, i.e. the use of the scrub brush on the rhino's belly, essential to the procedure; Veterinarians Dr. Michael Schmidt and Dr. Mitch Finnegan, for their support and assistance; Research Coordinator Dr. Jill Mellen for her support; and E. V. Berkeley of Deaconess Research Institute, Billings, MT for her assistance.

### **Reference**

Bloomsmith, M. Chimpanzee training and behavioral research: a symbiotic relationship. Pp. 403-408 in AAZPA/CAZPA 1992 Annual Conference Proceedings. 1992.

Czekala, N.M. Non-invasive monitoring of reproductive function in exotic animals. Pp.357-361 in AAZPA 1989 Annual Proceedings. 1989.

Laule, G. Addressing psychological well-being: training as enrichment. Pp. 415-422 in AAZPA/CAZPA 1992 Annual Conference Proceedings. 1992.

Maruska, E.J. Black rhinoceros (*Diceros bicornis*). Pp. 141-143 in AAZPA Annual Report on Conservation Science, Wiese R.J.; Willis, K.; Boudoin, J.; Hutchins, M. [eds] Bethesda, MD, American Association of Zoological Parks and Aquariums, 1993

Reece, R.W., Rhinoceros Advisory Group. Pp.139-140 in AAZPA Annual Report on Conservation Science, Wiese, R.J.; Willis, K.; Boudoin, J.; Hutchins, M. [eds] Bethesda, MD, American Association of Zoological Parks and Aquariums, 1993.

Reichard, T., W. Shellabarger, and G. Laule, Training for husbandry and medical purposes. Pp. 396-402 in AAZPA/CAZPA 1992 Annual Conference Proceedings. 1992

---

Institutions wishing to advertise employment opportunities are asked to send pertinent data by the 15th of each month to: Opportunity Knocks/AKF, 635 Gage Blvd., Topeka, KS 66606. Please include closing dates for positions available. There is no charge for this service and phone-in listings of positions which become available close to deadline are accepted. Our phone is 1-800-242-4519 (U.S.); 1-800-468-1966 (Canada). Our FAX is 913-273-1980.

**ZOO ATTENDANT I**...routine care of reptiles, birds, and mammals at the Sacramento Zoo and related cleaning and maintenance necessary for their health and well-being. Requires six (6) months of full-time experience working with captive, exotic animals. College level courses in biology, zoology, and animal science or a related field are desirable. Education may be substituted for part of experience if in the above fields. Salary: \$2,005.00 - \$2,438.00 per month plus benefits. Complete information and City of Sacramento applications available at 921 10th Street, Room 101, Sacramento, CA 95814. Out-of-area applicants call (916) 264-5762 for application. Final filing deadline **28 July 1995, 5 p.m.**

**GROUND S KEEPER**...(AZA Private Breeding Farm - Atlanta area). Full-time duties include, but not limited to, exhibit and landscape maintenance, construction and animal care. Must be physically fit, able to operate farm equipment. Quiet, picturesque environment with large kangaroo collection. Salary commensurate with experience, qualifications. Send resumé (including salary history) and three (3) references to: Nelson's Twin Oaks Farm, 13305 Bethany Rd., Alpharetta, GA 30201. FAX 404-475-6001. Position to be filled ASAP.

**ZOOKEEPER - PSITTACINES**...requires minimum of one year paid, hands-on experience with Macaws and degree or equivalent zoo-related experience. Duties include daily care, feeding, habitat upkeep, breeding programs, record keeping, medical coordination, training, acquisitions, supervising part-time staff/volunteers, and presenting educational programs, etc. Must be willing to work weekends/holidays. Starting salary \$15,000.00 - \$20,000.00 with year-end bonus and benefits. Excellent growth potential. Salary commensurate with experience. Send resumé/references to: Washington Zoological Park, 19525 SE 54th, Issaquah, WA 98027. Fax (206) 392-1076. Position open until filled.



**AAZK Membership Application** check here if renewal [ ]

Name \_\_\_\_\_  
Address \_\_\_\_\_  
City \_\_\_\_\_ State/Province \_\_\_\_\_ Zip \_\_\_\_\_

**U.S. Members**

- \$30.00 Professional/U.S.  
*Full-time Keepers*
- \$25.00 Affiliate/U.S.  
*Other staff & volunteers*
- \$25.00 Associate/U.S.  
*Those not connected with  
an animal facility*
- \$50.00 or up - Individuals  
Contributing/U.S.
- \$50.00 or up  
Institutional/U.S.  
*Organizations/Institutions  
(requires Board approval)*

**Canadian Members**

- \$35.00 Professional/Canada  
*Full-time Keepers*
- \$30.00 Affiliate/Canada  
*Other staff & volunteers*
- \$30.00 Associate/Canada  
*Those not connected with  
an animal facility*
- \$55.00 or up - Individuals  
Contributing/Canada
- \$55.00 or up  
Institutional/Canada  
*Organizations/Institutions  
(requires Board approval)*

**International Members**

**\$40.00 International**  
*All members outside U.S. &  
Canada regardless of category*

**Library Only**

**\$20.00 Library**  
*Available only to  
established libraries*

Zoo Affiliation (if any) \_\_\_\_\_  
Zoo Address \_\_\_\_\_  
Title \_\_\_\_\_  
Work Area \_\_\_\_\_

My check is enclosed (AAZK, Inc.)  Please charge my credit card

MASTERCARD \_\_\_\_\_ VISA \_\_\_\_\_ Card # \_\_\_\_\_ - \_\_\_\_\_ - \_\_\_\_\_ - \_\_\_\_\_

Name on card \_\_\_\_\_ Expiration Date \_\_\_\_\_

Signature \_\_\_\_\_

Mail this application to: AAZK Administrative Offices, Topeka Zoo, 635 S.W. Gage Blvd., Topeka, KS 66606-2066 U.S.A. Make checks/money orders payable to AAZK, Inc. Must be in U.S. FUNDS ONLY.

Membership includes a subscription to Animal Keepers' Forum. The membership card is good for free admission to many zoos and aquariums in the U.S. and Canada.

**of Zoo Keepers, Inc.  
635 S.W. Gage Blvd.  
Topeka, KS 66606-2066  
U.S.A.**

**U.S. POSTAGE PAID  
Permit # 646  
Topeka, KS 66603**

National Zoological Park 3776  
NIP Library  
Washington, DC 20016



*"Dedicated to  
Professional Animal Care"*

L  
6  
548  
29

# ANIMAL KEEPERS' FORUM



**The Journal of the American  
Association of Zoo Keepers, Inc.**

**AUGUST 1995**

**ANIMAL KEEPERS' FORUM**, 635 S.W. Gage Blvd., Topeka, KS 66606-2066

Phone: 1-800-242-4519 (U.S.) 1-800-468-1966 (Canada) FAX 913-273-1980

**Managing Editor:** Susan Chan

**Associate Editors/Enrichment Options Coordinators:**

Kayla Grams, Arizona-Sonora Desert Museum & Gretchen Ziegler, Sequoia Park Zoo

**Book Review Coordinators:** Melba T. Brown, National Zoo & Andrea Bernee, Chaffee Zoological Garden

**Legislative Outlook Column Coordinator:** Georgann B. Johnston, Sacramento, CA

**August 1995**  
**Vol. 22, No. 7**

Animal Keepers' Forum (ISSN 0164-9531) is a monthly journal of the American Association of Zoo Keepers, Inc. Ten dollars of each membership fee goes toward the annual publication costs of Animal Keepers' Forum. Third Class postage paid at Topeka, KS. Postmaster: Please send address changes to: **American Association of Zoo Keepers, Inc., 635 S.W. Gage Blvd., Topeka, KS 66606-2066 - Attn: Barbara Manspeaker, Administrative Secretary**

**Executive Director:** Ed Hansen, AAZK, Inc.

### BOARD OF DIRECTORS

Janet McCoy, Metro Washington Park Zoo, Portland, OR 97221-2799

Rachél Watkins Rogers, San Diego Zoo, San Diego, CA 92112

Mark de Denus, Assiniboine Park Zoo, Winnipeg, Manitoba, Canada

Alan Baker, Burnet Park Zoo, Syracuse, NY 13204-2504

Ric Urban, Houston Zoological Garden, Houston, TX 77030

Marilyn Cole, Metro Toronto Zoo, Toronto, Ontario, Canada

Diane Callaway, Omaha's Henry Doorly Zoo, Omaha, NE 68107-2200

President

Vice President

### COMMITTEES

#### Nominations & Elections

Chair - Maria McManus, Indianapolis Zoo

#### Conservation, Preservation & Restoration

Chair - Brett Sellers, Metro Washington Park Zoo

#### Annual Conferences

Coordinator - Ed Hansen, AAZK, Inc.

#### Awards

Chair - Anna Michel, Metro Washington Park Zoo

#### Exhibit Design Resource Notebook

Michael Demlong, The Phoenix Zoo

AAZK Inspection Standards Manual — Rachél Watkins Rogers, San Diego Zoo

#### By-laws

Rachél Watkins Rogers, San Diego Zoo

#### Ethics

Mark de Denus, Assiniboine Park Zoo

#### Research/Grants

Vacancy

#### Publications Funding

David Luce, Chaffee Zoological of Fresno

#### AAZK Chapter Logo Products

Jay Christie, Cohanzick Zoo, Bridgeton, NJ

### MEMBERSHIP SERVICES

#### L.I.N.K. Coordinator

Mark de Denus, Assiniboine Park Zoo

#### Zoo University List

Mike Illig, Metro Washington Park Zoo

#### Keeper Accommodations List

Todd Cleveland, Denver Zoo

International Outreach - Jeanette Beranger, Roger Williams Park Zoo (Chair/Coordinator Technical Assistance); Lesa Scheifele, Norwich, CT (Foreign AAZK Members/Sister Organizations); Lois Johannes, L.A. Zoo (Foreign Member Sponsorship Program); Kathy Kelly, National Zoo (Project M.A.R.C.- Making A Realistic Contribution)

Enrichment Committee — Dianna Frisch, Columbus Zoo

#### AAZK Training Materials

Laura Treschel, Continuing Education Coordinator, Minnesota Zoological Gardens

#### Animal Data Transfer Form

Bernie Feldman, Burnet Park Zoo

#### Staff Exchange

Dale Frerking, Kansas City Zoo

#### AAZK Historian

Heidi Fowle, Orlando, FL

### PRESIDENTIAL ADVISORS

#### AZA Liaison

Ed Hansen, IPP, AAZK, Inc.

#### Bowling for Rhinos

Patty Pearthree, Indianapolis Zoo

#### Elephant Managers Association

Dinah Wilson, Marine World Africa USA

#### CAZPA Liaison

Oliver Claffey, Metro Toronto Zoo

### AAZK PUBLICATIONS - CONTINUING DATA COLLECTION

#### Zoo Infant Development Project

Teri Maas/Maggie Liguori, Philadelphia Zoo (Birds/Nonpasserines); Kim Livingstone, L.A. Zoo (Passerines)

Jeanne Bocconelli, Newark Museum Mini-Zoo (Reptiles); Linellé Lone, Denver Zoo (Amphibians)

Diet Notebook, Mammals, Vol. II - Susan Bunn Spencer, Grand Rapids, MI





## ***Table of Contents***

About the Cover/Information for Contributors.....	302
From the Editor's Desk.....	303
Scoops & Scuttlebutt.....	304
Message from the President.....	305
Coming Events.....	306
Comparison of Hand-Rearing Leopard vs. Jaguar Cubs.....	308 - 312
Book Review (Hand-Raising Infant Mammals).....	312
Legislative Update.....	313 - 315
Chapter News Notes.....	315
Black & White Colobus Hand-Rearing Information.....	316 - 318
1995 Australasian Rap Session at Denver Conference.....	318
Conference '95 (Wildlife Near the City; Casino Night; Speaker List).....	320 - 322
Births & Hatchings.....	323
Neonatal Immune System as it Relates to Hand-Rearing.....	324 - 327
Enrichment Options (Chimps, Iguana, Psittacines, Coypu, Primates).....	328 - 330
African Journal (Lewa Downs Conservancy).....	330 - 332
Hand-Rearing the Red-throated Ant Tanager at Brookfield Zoo.....	332 - 337
Hand-Rearing an Emaciated Red Kangaroo Joey.....	338 - 341
AAZK Announces New Professional/Contributing Members.....	342
Opportunity Knocks.....	343 - 344
Information Please.....	344

## *About the Cover.....*

*This month's cover comes from AKF's past and also speaks eloquently to the dedication and caring required for hand-rearing exotic neonates. It is the original AKF logo - Zebra and Foal in Caring Hand - which was designed in the mid 1970s by Perry LaBelle. The logo was used on AKF from its inception and was coupled with the Association's bywords "Dedicated to Professional Animal Care". We dedicate this issue to all those involved in the difficult but rewarding process of hand-rearing, and applaud their efforts to ensure the continued survival of many endangered and threatened species.*

## Information for Contributors

Animal Keepers' Forum publishes original papers and news items of interest to the animal keeping profession. Non-members are welcome to submit articles for consideration. Articles should be typed or hand-printed and double-spaced. Articles may be submitted on disk by arrangement with the Editor. All illustrations, graphs, charts and tables should be clearly marked, in final form and should fit in a page size **no greater than 5.5" x 8.5"** (14cm x 22cm). Literature used should be cited in the text (Brown, 1986) and alphabetically in the final bibliography. Avoid footnotes. Include scientific name (as per ISIS) the first time an animal name is used. Thereafter use common name. Use metric system for weights and measurements (standard equivalents may be noted in parenthesis). Use the continental dating system (day-month-year). Times should be listed as per the 24-hour clock (0800, 1630 hrs. etc.). Glossy finish black and white photos **only are accepted**. Color slides should be converted to black and white prints (minimum size 3" x 5" [8cm x 14cm] ) before submission. Clearly marked captions should accompany photos. Please list photo credit on back of photo.

Articles sent to Animal Keepers' Forum will be reviewed by the editorial staff for publication. Articles of a research or technical nature will be submitted to one or more of the zoo professionals who serve as referees for AKF. No commitment is made to the author, but an effort will be made to publish articles as soon as possible. Lengthy articles may be separated into monthly installments at the discretion of the editor. The editor reserves the right to edit material without consultation unless approval is requested in writing by the author. Materials submitted will not be returned unless accompanied by a stamped, self-addressed, appropriately-sized envelope. Telephone and FAX contributions of late-breaking news or last-minute insertions are accepted as space allows. However, long articles must be sent by U.S. mail. Phone 1-800-242-4519 (US); 1-800-468-1966 (Canada); FAX (913) 273-1980.

**Deadline for each regular issue is the 15th of the preceding month. Dedicated issues may have separate deadline dates and will be noted by the editor.**

Articles printed do not necessarily reflect the opinions of the AKF staff or the American Association of Zoo Keepers, Inc. Publication does not indicate endorsement by the Association.

Items in this publication may be reprinted providing credit to this publication is given and a copy of the reprinted material is forwarded to the editor. Reprints of material appearing in this journal may be ordered from the editor. Back issues are available for \$3.00 each.

# From the Editor's Desk

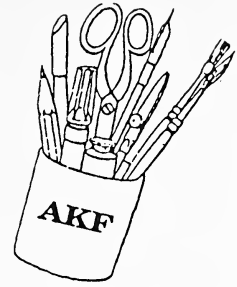

We hope all our readers are enjoying the new size and format of *Animal Keepers' Forum*. We are pleased this month to bring you an issue filled with articles on hand-rearing. The response to our call for papers on this topic was so great that readers can look forward to Hand-Rearing, Part II in the September issue of *AKF*. We thank all the authors who submitted material on this topic and are sorry for the delay in publication of some of the manuscripts.

We have several other special issues in the works as well. We are currently working on an issue dedicated to topics related to Species Survival Plans which we hope to publish later this Fall. Another possibility for a special issue is on Dealing With Zoo Animals During Natural Disasters. We would like to solicit articles from the membership on this particular topic—we especially want to hear from those facilities that have had to deal with such natural disasters as hurricanes and earthquakes. Natural disasters might include fire, floods, blizzards, tornados, etc. We would ask that articles be submitted **by 1 December 1995**.

For those individuals wishing to submit artwork for consideration for the covers of future issues, keep in mind that the artwork submitted should either (1) be no larger than 6 1/2" tall and 5 1/2" wide or (2) if larger, must be able to be proportionately reduced to fit within sizes listed above. For the moment we would ask that artists submit only artwork for use with a vertical cover format. Pen and ink works best for reproduction purposes. Light pencil sketches or poor quality photocopies are not suitable. If you have questions, contact the editor.

The *AKF* staff is currently conducting an advertising solicitation campaign in hopes of bringing in more revenue to fund the journal. The new size and format are more expensive to produce and the size (in number of pages) we will be able to publish will depend in great part on the positive result of this ad campaign.

We are hoping to conduct a survey on *AKF* at the Denver Conference and in an upcoming issue to get feedback from the readership on the new look of the journal. We hope you will participate in this survey and let us know your thoughts, concerns, criticisms, etc. Remember, this is your Association's journal and we want it to reflect the desires of the membership.

*Susan D. Chan*  
Managing Editor

# Scoops & Scuttlebutt



## AAZK Position Open

The post of the AAZK Historian is available. Any AAZK member continuing 'in good standing', who wishes to fill this vacancy is eligible. This position requires good reporting and records keeping skills; a desire to maintain a history of the AAZK and advise the Board Overseer and/or membership about historical information. Computer skills are desirable in executing this position, but not required. For information about submitting your name for consideration, please contact Board Overseer Diane Callaway at Omaha's Henry Doorly Zoo. You may write to Diane at Omaha's Henry Doorly Zoo, 3701 South 10th St., Omaha, NE 68107-2200 or call at (402) 733-8401.

## AZA Grant Opportunities Announced

The AZA Board of Regents announces two grant opportunities for the 1996 Management Schools:

Minority Grant: The Board of Regents is accepting applications for a minority grant for the School for Professional Management Development for February 1996. Upon successful completion of the first year of Management School, the grant will be renewed for the second year. The grant consists of a \$500 award plus tuition waiver each year.

Biology Grant: The Board of Regents is accepting applications for a Dinamation Grant for the School of Applied Zoo and Aquarium Biology for February 1996. The grant consists of a \$500 award upon successful completion of the course.

Applications for either grant must be received by 1 September 1995. For complete information on the grant application process, interested applicants should contact: Patty McGill, Vice-Chair AZA Board of Regents, Brookfield Zoo, 3300 Golf Road, Brookfield, IL 60513, (708) 485-0263 Ext. 445.

## TK-SSP Avian TB Research Fund Grows

*submitted by Judie Steenberg, Tree Kangaroo SSP Action Plan Facilitator*

To date, pledges and contributions have been received totaling \$31,000.00 to fund research to develop reliable diagnostic tests and a vaccine to protect tree kangaroos from Avian TB (*Mycobacterium avium*). This leaves only \$7,000.00 to go to reach our goal of \$38,000.00.

A very special thank you to the following AAZK Chapters and individual members who have contributed to this fund. Donations have been received from: Puget Sound (Seattle, WA), Platte River (Lincoln, NE), Jacksonville (FL), Columbus (OH), Cleveland (OH), Memphis (TN), Roger Williams Park Zoo (Providence, RI), and the Mt. Tahoma (Portland, OR) AAZK Chapters; and from Lyn Nadeau Rudd and Sherman Camp. These combined donations total \$4,176.50, a **very significant** contribution.

If your Chapter would like to help raise the last \$7,000, please send your donation to the attention of Judie Steenberg, Action Plan Facilitator, Tree Kangaroo SSP, Woodland Park Zoological Gardens, 5500 Phinney Ave. No., Seattle, WA 98103. (Please make checks payable to TK-SSP Avian TB Research Fund).

# *Message From the President*

**Conference 1998** - is your Chapter looking for a stimulating project? Have you considered hosting an AAZK, Inc. National Conference? Here is your chance to tout your city and your zoo!

Conference bids should include a letter of intent to host an AAZK, Inc. National Conference from the Chapter President and support letters of approval from the Zoo's Director as well as from the Mayor or other relevant person or agencies (i.e. Zoological Society, City Council, Convention & Visitors Bureau, etc.). Bids should be sent to Ed Hansen, Executive Director, who is oversight for conferences.

A formal bid presentation will be given at the 1995 National conference in Denver, Co. At this time, the AAZK delegates will vote on submitted bids for the site of the 1998 national Conference. Questions??? Please contact Ed Hansen, Executive Director, or myself.

Those Chapters interested in hosting a conference, may purchase the AAZK, Inc. Conference Book from the Administrative Offices. If you host a conference, the fee will be refunded.

Remember to send your proxy ballot on the proposed Bylaw revisions to Barbara Manspeaker, Administrative Secretary by 15 September. Your vote is important!

Board members will be meeting with the committee/project chairs for which they have oversight from 1:00 - 4:30 p.m. Sunday, 24 September. Members are invited to come and sit in on any sessions in which they have an interest. A complete time schedule will be posted at the Conference.

Committees/Projects which will be meeting Sunday afternoon and their Board Oversight are as follows:

**Janet McCoy, President** : Bowling for Rhinos; Elephant Managers Association (EMA)

**Rachél Rogers, Vice President**: Conservation, Preservation & Restoration (CPR);  
Nominations & Elections.

**Mark de Denus**: L.I.N.K. System; AAZK Publications (Zoo Infant Development, Diet Notebook and Exhibit Design Resource Notebook); Chapter Products;  
Bylaws.

**Ric Urban**: International Outreach; Enrichment Committee

**Alan Baker**: Research Grants; Inspection Standards Committee;  
Keeper Training Package.

**Diane Callaway**: Zoo/University List; Staff Exchange; AAZK Historian.

**Marilyn Cole**: Animal Data Transfer Form; Keeper Accommodation List; Awards Committee.



Janet McCoy, President AAZK  
Metro Washington Park Zoo, Portland, OR

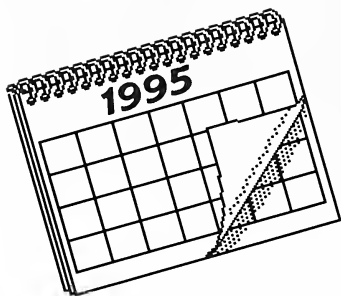

# Coming Events

## The 16th Annual Elephant Managers Workshop

October 10-14, 1995

Tacoma, WA

Headquartered at the Tacoma Inn. Presented by the Pt. Defiance Zoo & Aquarium and the Elephant Managers Association. For further information contact: Bruce Upchurch or Sally LaTorres, Point Defiance Zoo & Aquarium, 5400 N. Pearl St., Tacoma, WA 98407-3218, (206) 591-5337, ext. 154.

## Second Annual Conference of the Association of Reptile and Amphibian Veterinarians

October 26-29, 1995

Sacramento, CA

Will include Scientific Program, Wet Labs/Workshops and a Trip to the Sacramento Zoo. For conference registration information contact: Wilbur Amand, VMD, P.O. Box 605, 1 Smithbridge Rd., Chester Heights, PA 19017; Fax (215) 387-2165.

## Association of Zoo Veterinary Technicians 15th Annual Conference

Oct. 30 - Nov. 2, 1995

Baltimore, MD

To be held at the National Aquarium. Conference will include sessions on reptile, avian, primate, hoofstock and aquatic medicine, immobilization, hematology, clinical and gross pathology, hospital techniques, and case reports. In addition, there will be a wet-lab. For more information contact: Jenni Jenkins, LVT, National Aquarium in Baltimore, Pier 1, 501 E. Pratt St., Baltimore, MD 21202; tel: (410) 656-4256; Fax (410) 576-1080.

## The Annual International Small Felid Workshop

December 4-6, 1995

Las Vegas, NV

Co-sponsored by the San Diego Zoo and S.O.S. Care. For further information, contact Pat Quillen, 15453 Woods Valley Road, Valley Center, CA 92082. PHONE: (619) 749-3946 FAX: (619) 749-1324.

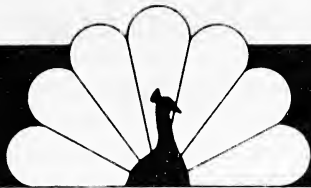

## Quality exotic animal diets

# SPECTRUM

**Nutritionally balanced  
Fixed formulation • Economical**

When you need a complete line of high-quality dry and frozen animal diets for your feeding program, call Animal Spectrum.

**NEBRASKA BRAND**



*Frozen feline diets  
Frozen bird of prey diets  
Frozen canine diet  
Chunk and chopped horse meat,  
hearts, livers, rib, shank,  
knuckle bones, and tailbones*



*Banana flavored psittacine/primate, 20% protein, dry  
Banana flavored primate, Pro-Plus 25% protein dry  
Leaf Eater primate dry                      Omnivore dry  
Llama Vitamins & Minerals dry            Polar Bear dry  
Marmoset/Tamarin dry                      Ratite dry  
Hoofstock supplement, with Selenium dry*

**BROOD-RITE  
HEATERS**

*Bulbless heaters—nothing to break  
Safe around all animals and  
bedding material.  
Even heat distribution in 240, 500,  
or 750 wattages.*

**One call does it all**

TOLL  
FREE **1-800-228-4005**

**FAX 308-534-7015**

*Animal Spectrum, Inc.  
P.O. Box 721  
North Platte, NE 69101-0721*

# Comparison of Hand-Rearing Leopard vs. Jaguar Cubs

by Nancy Vandermey, Sandy Masek, and  
Karla Losey of the EFBC, Rosamond, CA

It is desirable for many reasons to have captive felines mother-raise their cubs. Mother-raised cubs are generally larger and healthier than hand-reared felines, and often adapt better to captive breeding as adults. However, in some cases cubs must be taken from their mothers and hand-raised. This paper looks at a leopard cub and three jaguar cubs that had to be hand-raised at the Exotic Feline Breeding Compound (EFBC) in Rosamond, CA. The first eight weeks of life is presented in weight vs. age charts along with behavioral comments. First some background on why the cubs were hand-raised is given.

## Background Information

On 29 April 1994, a six year-old Northern Chinese leopard, Tai Chi, (*Panthera pardus japonensis*) gave birth to two cubs. She was being observed 24 hours; her first litter (2 cubs/1 stillborn) had been pulled and hand-raised, because Tai Chi did not take care of the surviving cub. Tai Chi had been hand-raised herself, as her mother, Lotus, had accidentally bitten off her first cub's front leg at birth. During late afternoon on 29 April, labor began very suddenly. As a keeper approached the den box to check on Tai Chi, mewling noises were heard from inside. One cub had been partially eaten, the second (male, Tao) was not cleaned off fully, weakly mewling, and not nursing. Tai Chi allowed the keeper to take the cubs, and Tao was successfully hand-raised.



**One-week-old Northern Chinese leopard Tao being bottle fed. Note the claws on this tiny kitten.** (Photo by Nancy Vandermey)



In 1994, a female jaguar, Twilight, (*Panthera onca*) became pregnant. Her due date came and went, while Twilight just got larger. At 10 days overdue with no onset of labor, a Cesarean section was preformed. Three cubs were stillborn, one was large and deformed, possibly blocking the birth canal. She came into heat again two months after the operation. When Twilight became pregnant again in early 1995, her due date was calculated and she was watched closely. On her due date she was given Oxytocin® to induce labor but nothing happened. Another Cesarean section was performed on 11 March. All three cubs survived after 1.5 hours of CPR and were hand-raised. There were two males (Butch and Bear) and one female, Casey. At three months of age, all three left EFBC for new homes.



**Three-week-old jaguar Casey at the Exotic Feline Breeding Compound.**

*(Photo by Nancy Vandermey)*

### **Weight vs. Age**

At birth, Tao weighed 570 grams (1.25 lbs.), and the jaguars weighed from 780-980 grams (approx 2 lbs.). Weight gain was steady, except for bouts of illness, as shown in Figure 1.

### **Weaning**

Formula was Esbilac® mixed with Pedialyte®, with some vitamins and neocalgluconate added, fed from baby bottles. The mixture of Esbilac® to Pedialyte® was gradually increased; in Tao's case, it went from 50/50 at birth to 75/25 at three days, and 100% Esbilac® was tried at four days. He took some formula, but required some Pedialyte® to be mixed in to eat a full bottle. At this time a puncture wound and scratches, thought to be inflicted by his mother at birth, were found on his abdomen. He was put on antibiotics and his formula was cut back to a 50/50 mixture. The Esbilac® was then increased again, to 60/40 at ten days, 70/30 at 13 days, 80/20 at 14 days, and 90/10 at 17 days. At 33 days, 1/4 teaspoon strained chicken baby food (Gerber's Second Foods®)

was blended in. This amount increased every day, to 1/2 jar baby food per bottle of formula at age 48 days. At 51 days he licked baby food chicken from a bowl, and sampled ground London broil steak. By age 55 days his diet was baby food chicken, ground London broil, calcium, and Esbilac® mixed together in a bowl (no more bottles). At age 59 days ground chicken was introduced (and enjoyed). A chicken leg was offered at 73 days (10 1/2 weeks) and both were played with and eaten. The bone was removed when the meat was eaten off it. The diet continued as chicken legs or breasts/turkey legs/horse meat along with a bowl (described above) until age 15 weeks, when he was given the same diet as adult cats (chicken and horse meat).

## **Jaguars**

The jaguars went through the same stages, but at earlier ages. By 12 days the formula was 100% Esbilac®. At age 13 days 1/4 teaspoon baby food chicken was blended in. The amount of baby food chicken was increased gradually every three days; at age 27 days the mixture was one teaspoon chicken to 6 ounces of Esbilac®; at 34 days two and one half teaspoons chicken; and at 37 days, one tablespoon chicken per 6 ounces Esbilac®. A bowl of strained baby food chicken and ground London broil was offered at 46 days; one cub refused the mixture, while the other two sampled the solid food. By eight weeks they received 1 1/2 cups ground London broil each per day, and were managing chicken legs at 61 days (8 1/2 weeks).



**2.1 jaguar cubs (Butch, Bear and Casey) at six weeks of age.**

*(Photo by Nancy Vandermey)*

## **Illnesses**

The male jaguars both fell ill at about seven weeks of age, losing approximately 10% of their body weight. They were given 1cc injections of Tribriksen® for 11 days and quickly recovered. The female jaguar did not become as ill as her brothers. Tao had several minor illnesses, requiring Cefa® drops or Tribriksen®. He never exhibited drastic weight loss, but had several stagnant growth periods while ill. Illnesses were manifested by diarrhea, fever, lethargy, and for refusing to eat.

# Comparison of Weight vs. Age for 4 cubs

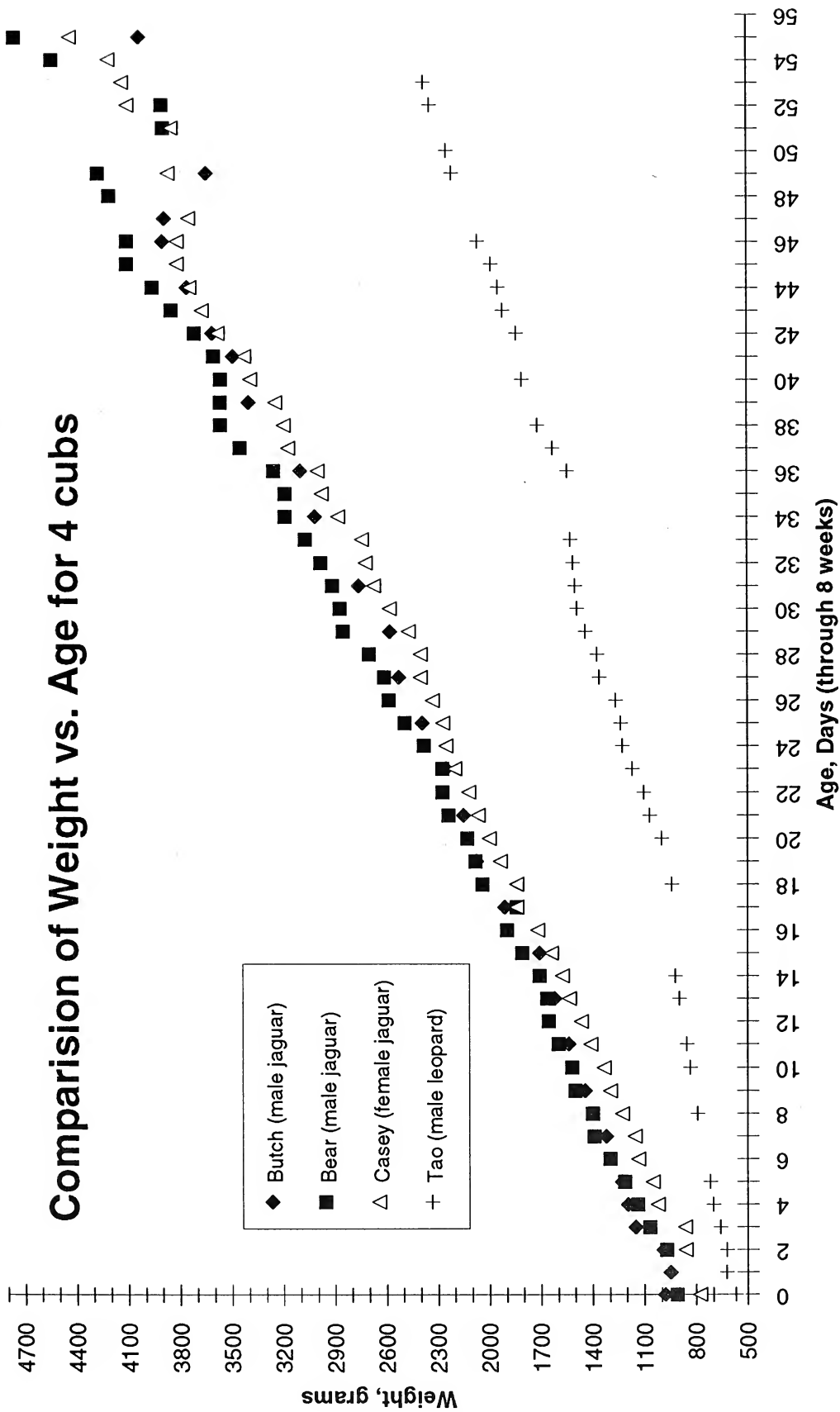

## Behavior

Tao started to open his eyes at seven days, while the jaguars' eyes were 75% open at birth. The jaguars' teeth came in earlier (15 days vs. 25 for Tao), and they were biting hard at six weeks of age. Hand-raised cubs are not allowed to use their teeth and/or claws on humans. This is important to learn from a young age on so they don't have bad habits when they are older. Humans do not roughhouse with the cubs. When cubs bite too hard, they are flicked in the nose with a finger. Light swats to the rear end are given for too-rough play with humans, and a chew-toy is given as a substitute. Rolled up socks, boots, and plastic baby toys all become chew toys. Toys must be removed when they become too damaged so that pieces are not ingested. Balls and pine cones are also good toys. Other cubs/animals are good play companions too. Tao occasionally socialized with a border collie. The jaguars had each other to chew on. When moved to an outdoor cage, Tao was curious about the other cats. He enjoys walking on a leash, and remains leash-trained as a young adult.

## Conclusions

In many ways, jaguar cubs are more similar to tiger cubs than to leopards. They are more developed at birth, and continue to develop and wean more quickly. With proper, consistent discipline, cubs can be hand-raised to become well-adjusted cats that both respond well to humans as adults while relating well to other cats.

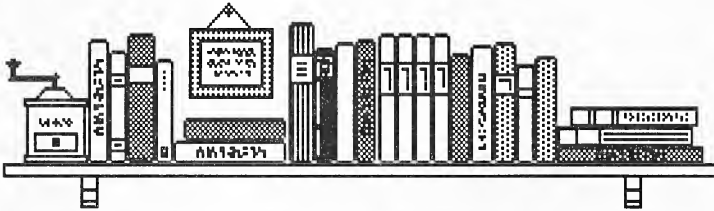

## Book Review

### Hand-Raising Infant Mammals

By Theresa Stockdale Dorsey  
Spring Valley Publications  
Centerville, OH 45459

*Review by Harmony Frazier, LVT  
Senior Veterinary Technician  
Woodland Park Zoo, Seattle, WA*

Also titled "The Essential Reference for Raising Everything from Aardvarks to Zebras", this 210-page, softcover publication is a practical working guide to hand-rearing. The author has obviously put a lot of thought into making this work clear, concise and easy to follow. I think in most ways she has met her goal "to provide information simple enough to recommend to the layperson and technical enough for the breeder." It would also make a nice addition to other zoo references, especially for use as a training guide for nursery personnel.

This reference is in two sections. Part 1 discusses all the basic procedures for hand-raising: Chapter 1 - "Deciding to hand-rear", includes brief discussions on reasons this might be necessary, behavioral implications, cost, etc. Chapter 2 - "Housing", is fairly complete but since this is a book for people new to hand-raising, it might have been a good idea to note the need for caution when it suggests using plants in enclosures, i.e.

*(Continued on page 341)*

# Legislative Update

Compiled by Georgann B. Johnston  
Legislative Advisor  
Sacramento, CA



---

## Revocation of Sea Turtles' Protection Proposed by Congressional Bill

Senator Slade Gorton (R-WA) introduced a bill on 9 May (S 768) which would exempt sea turtles, marine mammals, and other marine species (except fish) from the protection of the Endangered Species Act. More specifically, the bill would delete any prohibition against "taking" or otherwise killing these creatures during fishing or other activities in marine waters.

The bill eliminates ESA protection for marine species such as sea otters, dolphins, whales, sea lions and sea birds which could be killed during fishing, oil and gas drilling, mining and other activities that occur in coastal and ocean waters. Senator Gorton admitted in an interview with *The New York Times* in April this year that the bill was written by lawyers for industry coalitions with an economic stake in the outcome, but he stated, "I'm perfectly willing to get the free services of good lawyers in drafting my views."

Source: *Center for Marine Conservation Press Release, 12 May 1995, Senate Bill File, Lexos/Nexis 7/3/95*

---

## Grizzly Reintroduction Proposal from USFWS

The U.S. Fish and Wildlife Service has recently issued a document outlining several options for grizzly bear recovery in the Bitterroot ecosystem, a six million acre tract of mountainous wilderness areas and national forests in central Idaho and western Montana. Bitterroot was once the site of the largest population of the bears, but hunting, trapping and poisoning eliminated them from the area by 1955. Because the area is essentially still pristine wilderness, with virtually no roads, it is an excellent habitat for this species. Additionally, the Bitterroot area is situated so that it can link to bear habitat in northwest Montana and Yellowstone, thus eliminating the problem of isolated populations of this species.

The USFWS proposal includes three major alternatives: allowing bears to return on their own, reintroducing grizzlies as an experimental population under the Endangered Species Act, or accelerate reintroduction of the bears as a threatened population. A copy of the USFWS proposal can be obtained from Bitterroot Grizzly EIS, Box 5127, Missoula, MT 59806, (406) 329-3223.

Source: *Defenders of Wildlife Rapid Response Network, June 28, 1995*

---

## **U.S. Supreme Court Upholds Protection of Habitat as Part of Endangered Species Act**

The U.S. Supreme Court issued a decision on 29 June, 1995 in the case of *Babbitt vs. Sweet Home Chapter of Communities for a Great Oregon* and held that Congress, in enacting the Endangered Species Act in 1973, intended that the phrase "take endangered or threatened species" embraces the concept of significant habitat modification or degradation where it actually kills or injures wildlife. This decision endorsed the position put forward by the Department of the Interior, the agency charged with the primary enforcement of the Act, that the ESA's purpose was to provide comprehensive protection for endangered and threatened species.

Following the decision, opponents of the 1973 law vowed to rewrite it to ease restrictions on private landowners. Led by Senator Bob Packwood (R-OR) and Senator Slade Gorton (R-WA), opponents of the ruling stated that "This makes it imperative that Congress amend the Endangered Species Act so that people count as much as bugs and birds and plants."

In response to critics of the decision and the ESA in general, Secretary of the Interior Bruce Babbitt pointed to a congressional study which revealed that more than 90 percent of the 781 currently listed endangered or threatened species are found on privately owned land. Secretary Babbitt commented that: "Habitat conservation is the best single means to counter extinction" but he would "work to make the act less onerous on private landowners."

*Source: 95 Daily Journal D.A.R. 8566, case No. 94-859 and The Daily Recorder, July 3, 1995, report from Associated Press by H. Josef Herbert*

---

## **International Whaling Commission Passes Resolution Encouraging Norway to Recall Its Whaling Fleet**

The 47th annual meeting of the International Whaling Commission concluded with a 21-6 vote by its membership in favor of a resolution urging Norway to recall its whaling fleet and "reconsider" its objection to the global commercial whaling moratorium imposed in 1986. The commission also voted to direct Norway, Japan and any other nations with stored whale meat to produce annual reports on the volume held and on the country's effort to prevent illegal whale meat sales. A third resolution passed by the IWC called for Japan to limit its "scientific research" of whales to non-lethal methods of data collection. In response, Japan stated that it intends to kill 400 minke whales this year for research, including 100 whales found within the boundaries of the Southern Oceans Whale Sanctuary.

*Source: Animals Agenda July/August 1995*

---

## **Desert Tortoise Habitat Affected by Proposed Nuclear Waste Dump**

Interior Secretary Bruce Babbitt has issued a tentative decision to allow land in Ward Valley, CA to be used as a low-level radioactive waste facility. Ward Valley is one critical habitat for the endangered desert tortoise. Secretary Babbitt stated at a press conference that his decision to allow the nuclear waste dump was based, in part, on a report from the National

Academy of Sciences. The NAS undertook a review of scientific and technical concerns related to the waste facility but did not address questions about the effect on non-human species residing in the area.

In a public statement, Secretary Babbitt also stated that he would consider further input regarding the issue in general and specifically whether the NAS report adequately covered all of the scientific issues that should be considered to make a reasoned decision with regard to the use of the Ward Valley site. Public comment to the Secretary is invited.

*Source: ESA Today, 23 June, 1995; Dept. of the Interior Press Release, 11 May 1995*

# Chapter News Notes

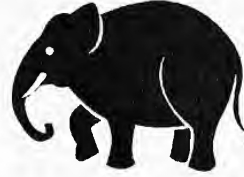

## Pueblo Zoo AAZK Chapter

New Chapter Officers are:

President.....Holly Tozier  
Vice Pres/Sec'y.....Charla Dawson  
Chapter Liaison.....Michele Smith  
Treasurer.....Dave Korber

Here in Pueblo we are busy getting ready for the Pre-Conference trip. A barbeque dinner, behind-the-scenes tours, and freebies for our fellow keepers are in the works. We are really excited to have everyone visit!

We just held a photo contest, and the winning photos are soon to be postcards. We had a lot of entries and were very pleased with the quality. One of the postcards-to-be was taken by a 13-year-old!

Hope to see you in September!

—*Michele Smith, Chapter Liaison*

## EFBC Chapter (Rosamond, CA)

The Exotic Feline Breeding Compound will be changing its name to the Feline Conservation Center. The name change will be gradual.

Our AAZK Chapter recently purchased a chip reader for EFBC for reading the identity microchips implanted in many cats. Babies born here will be receiving chips also.

In addition to bake sales, we recently began raising money by selling limited edition photo buttons in the EFBC gift shop, featuring photos of cubs/kittens. EFBC/FCC announces their WEB page address, <<http://www.cathouse-fcc.org/>>, and e-mail address, <[info@cathouse-fcc.org](mailto:info@cathouse-fcc.org)>.

—*Nancy Vandermeij, Secretary*

## Greater Houston Chapter

Our Chapter would like to welcome Connie Derringer, the AAZK Regional Coordinator for Texas, to the Houston Zoo.

The 1997 National AAZK Conference will be a joint conference between zoo keepers and registrars. It will be held at the Sheraton Astrodome from 5-9 October 1997.

Our Chapter gave a donation to HEART - Help Endangered Animals - Ridley's Turtle. We raised these funds from our 1994 Lone Star Keeper Symposium silent auction.

—*Sheri Leavitt, Secretary*

# Black and White Colobus (*Colobus guereza kikuyuensis*) Hand Rearing Information

By Tracy L. Anderson, Hospital Manager  
Cheyenne Mountain Zoo, Colorado Springs, CO

This information was compiled using the daily entries of the neonatal hand rearing records and the medical charts. Information was also retrieved from the article previously published in the *AKF* in December 1993, The Assisted Rearing of 0.1 Black and White Colobus (*Colobus guereza*) by Helen E. Harris.

On 1 February 1993, Lonnie, an eleven-year-old black and white colobus (*Colobus guereza kikuyuensis*), gave birth. Mother and baby were in apparent good health. On 4 February Lonnie was lethargic, anorexic, her stomach was bloated, and she had watery stools. She continued to care for the neonate. A parasite check on the abnormal feces was negative, so Lonnie was started on injectable antibiotics. She appeared slightly brighter on the second day of treatment and was started on oral supplements of Nutrament®, Calcet®, and Pedialyte®. By 7 February Lonnie was not eating or drinking and was very weak.

On 7 February the dam was immobilized to do a complete physical work-up. She was given Ketamine® and transported to the hospital. During the procedure, she went into cardiac arrest. Emergency CPR and epinephrine were unsuccessful. Histopathology revealed inflammatory bowel disease as the cause of death.

The death of Lonnie left us with an orphaned seven-day-old neonate. Hand rearing a colobus is difficult due to their complex digestive system.

The infant was placed with an adult surrogate non-lactating female who displayed interest in protecting the neonate. The adult female was netted six times a day (0800, 1100, 1400, 1700, 2000, 2300 hours) to bottle feed the neonate. Feedings consisted of 25 ml (0.8 oz.) of Enfamil® with Iron. The 0800 bottle had .5 ml (.5cc) of the multi-vitamin Poly-Vi-Sol® added. The baby sustained slight bruising and some superficial wounds due to this netting. The stress to the adult female and potential physical danger to the neonate led us to pull the baby and place her in an isolette. At this time the neonate was 10 days old.

The baby was named Wamblenica (Wom-bluh-nee-cha) which is a Native American word meaning "orphan". Wamblenica was still being bottle fed six times a day by the zoo staff. The Enfamil® with iron was now replaced by a new formula consisting of:

- 1 tea bag (fruit or herbal) brewed in 296 ml (10 oz.) distilled water
- 90 ml (3 oz.) of this brew added to 90 ml (3 oz.) evaporated milk
- 3/4 tsp. of rice flour added to liquids (mixed thoroughly but not shaken to avoid bubbles which could cause intestinal bloating and gas)

Her feces varied from soft to formed and was yellow in color. She experienced frequent bloating and stomach distension throughout the first few months. This was a concern



and was watched closely, but never caused her any significant problems. The stomach of the colobus consists of two distinct compartments, instead of the usual one found in other primates. The alkaline forestomach ensures that any acidic content of the food is reduced before reaching the small intestine where the risk of fermentation, so harmful to the colobus, is high.

Wamblenica was doing well in the isolette, however our next concern was that she needed more socialization than we were able to provide. She would get extremely agitated when she was placed back into the isolette after feedings. Due to this need for company, we again attempted a surrogate situation. On 26 February, Wamblenica and the same adult female were placed together in a squeeze cage. The surrogate immediately took to the baby. During feeding times the two were squeezed up to get the neonate to the front of the cage to be bottle fed through the bars. Soon this was not necessary as the surrogate would freely allow the infant to come to the front alone. After the feeding the surrogate would retrieve Wamblenica, or Wamblenica would return to the surrogate on her own.

There was concern that the adult female may begin to feel isolated herself. It was feared that she may relate the infant to the separation from her group, and reject the infant. To help alleviate this problem, the two colobus were placed in a perched den that was adjacent to a den connected to the exhibit housing the group, thus allowing minimal contact with the others.

By this time, the baby was strong and eagerly came to the den bars to be fed. Six days later, 5 March 1993, a second young adult female was introduced to the baby. This provided a companion for the surrogate and exposed the baby to another member of the group. The original surrogate remained the primary caregiver, although the responsibilities were shared between the two adults. On 18 March, the formula was increased to 35 ml (1.2 oz.) per feeding and on 20 March, the feedings were reduced to five times a day, eliminating the 2300 hour feed.



**Female black and white colobus, Wamblenica, with surrogate mother.**

One month after the second female was introduced, the three were allowed into the main exhibit to explore, exercise, and allow the infant to familiarize herself with the permanent exhibit. This was done routinely while the rest of the group were shifted outside. One month later the three were allowed to go outside. This took some coaxing, but Wamblenica eventually succumbed to her curiosity.

On 23 April, the formula was increased to 40 ml (1.4 oz.) five times a day. Wamblenica was first seen attempting to eat solids on 29 April. By this time she was also climbing very well. On 18 May, the formula feedings were reduced to three times a day (0800,

1300, 1700 hrs. ) but the amount was maintained at 200 ml (7 oz.) total per day. This feeding schedule was incorporated to encourage self feeding of solid food items.

In order to prevent the second adult female from being alienated from the group, she was reintroduced, and the alpha male was introduced to the surrogate and Wamblenica. For the first few days, the two adults had to be shifted to an upper den area due to the hesitation exhibited by the infant to come over for the bottle when the alpha male was in the same den. After the initial fears passed, the feeding regimen returned to normal.

When Wamblenica was 14 months old, the three member group was reintroduced into the main group. Other than curiosity and interest expressed by a few of the group members, the introduction went smoothly. Wamblenica was accepted, bottle feedings were eliminated gradually one by one as the consumption of solid food increased, and she actively foraged for food with the entire group with the original surrogate always protecting and teaching her.

### **Conclusion**

Surrogating this neonate was a first time experience for us and so was somewhat experimental. The success level in this situation was greater than we could have ever hoped. The socialization given to Wamblenica by her surrogates was better than we could have given to her. The constant attention and teaching she received made it easier to reintroduce her into the group and as a result she learned to forage and interact much earlier than if she had not been with a surrogate.

### **References**

Harris, Helen E., The Assisted Rearing of 0.1 Black and White Colobus (*Colobus guereza*)  
Animal Keepers' Forum, Dec. 1993



## **1995 Australasian RAP Session at the Denver AAZK Conference**

Coordinated by: Judie Steenberg, Woodland Park Zoological Gardens, Seattle, WA

The Australasian Rap Session (ARS), to be held at the National AAZK Conference in Denver this September, is an opportunity for keepers of animals indigenous to the Australasian region to share information and discuss problems in husbandry. The ARS format is to have a few keepers give 5-10 minute presentations on a particular species or situation at their zoo, followed by questions and general discussion.

During the ARS questions are often raised that someone has an answer for or information about. An update on the Monotreme and Marsupial Taxon Advisory Group meeting at the 1995 AZA Conference and the Tree Kangaroo SSP Master Plan meetings will also be presented.

If you have information you would like to present, please contact Judie Steenberg, Woodland Park Zoological Gardens, (206) 684-4011 or FAX (206) 684-4854, **before 10 September 1995.**

# HAND DECORATED OSTRICH EGGS



The Los Angeles Chapter of The American Association of Zookeepers is proud to be able to offer for sale these unique, one of a kind pieces of art. Five dollars from the sale of each egg will be donated to National AAZK for the benefit of Lewa Downs.

The eggs used are infertile, and come from an African ostrich ranch. Each egg is individually hand-crafted in South Africa by wildlife artist Hugh.

The cost of each egg is forty-three dollars, plus five dollars shipping and handling (U.S.Funds).

The eggs are available depicting the following animals:

Cheetah, Gemsbok, Sable Antelope, White Rhino, Leopard, Eagle Owl, Ostrich, Crocodile, Warthog, Zebra, Secretary Bird, Bald Eagle, Giraffe, Lion, Kudu, Cape Buffalo, Springbok, Asian Tiger, Porcupine, Bison, African Elephant, Black Rhino, Wildebeest

The eggs are in a very limited supply, and because they are hand drawn, no two are exactly alike. Orders will be filled on a first come first served basis.

Fill out the order form below, and please, **PRINT CLEARLY !!!**

Name: \_\_\_\_\_

Shipping Address: \_\_\_\_\_

(NO P.O. BOXES)

Please list AT LEAST six animal choices, in order of preference: \_\_\_\_\_

If none of my preferences is available, I will let AAZK/LA select a piece for me

YES       NO

Please enclose \$48.00 for each egg purchased. (U.S.Funds)

Make check or Money Order payable to AAZK/LA

Mail order form(s) to:  
AAZK/LA

c/o 29653 Wistaria Valley Rd.  
Canyon Country, CA 91351 USA

# 1995 AAZK National Conference

Denver, Colorado

September 24-28, 1995



## WILDLIFE NEAR THE CITY

Join us on a bus tour of The Rocky Mountain Arsenal. The arsenal site was once native prairie, home to Plains Indians and native wildlife. In 1942 the U.S. Army acquired the land to manufacture chemical and incendiary weapons for WW II. Following WW II, the property was leased to a private company that manufactured agricultural pesticides until 1982. Now a major environmental clean-up is under way to protect people, environment and wildlife. Surrounded by a city of two million people, the 27 square miles of land at the Rocky Mountain Arsenal National Wildlife Area offer important food, shelter and space for a diversity of wildlife — from wintering bald eagles to spring songbirds to herds of mule deer. On the grasslands, along lakes and streams, and in the woodlands surrounding this former weapons and chemicals plant, over 330 species of mammals, birds, fish, reptiles and amphibians make their homes.

Tours of the Rocky Mountain Arsenal will be held on Wednesday, 27 September and Thursday, 28 September. **Please Note:** Space for these tours is limited to 280 people over the two-day period. Therefore, it is important that you sign-up for one of the two trips when you pick up your registration packet at the conference.

## CASINO NIGHT - Monday 25 September 1995

Casino night \$10.00 package includes:

1. \$1.00 match play for blackjack
2. \$22.00 for \$20.00 poker buy-in
3. \$5.00 roll of quarters (no buy-in)
4. Two free drinks
5. A 15% discount in gift shop
6. Free Buffet Meal
7. A coupon to purchase a \$10.00 value T-shirt for only \$3.99
8. A \$6.00 value hat for only a \$1.99

On the bus there will a drawing for a free key chain, hat, and T-shirt.

## Papers And Workshops Planned for Denver Conference

Judie Steenberg, Woodland Park Zoo, Seattle, WA  
PAPER: Then and Now—20 Years of Zoo Keeping  
WORKSHOP: Australasian Rap Session  
VIDEO: The Keeper's Role in Zoo Animal Health

- Gisela Wiggins, North Carolina Zoological Park, Asheboro, NC  
PAPER: Management of Rabies in a Colony of Pallid Bats (*Antrozous Pallidus*) at the North Carolina Zoo
- Cindy Weaver, Fallbrook, CA  
PAPER: Nesting Site Enhancement for the Western Snowy Plover at Baquitos Lagoon, Carlsbad, CA
- Kelley Bullen, Burnet Park Zoo, Syracuse, NY  
PAPER: The Successful Birth and Rearing of Ruffed Lemur Triplets in a Newly Formed Mixed Exhibit with Ringtail Lemurs
- Jacque Blessington, Kansas City Zoological Gardens, Kansas City, MO  
PAPER: Red Kangaroo Management in a Five-Acre Walk About
- Chad Stewart, Denver Zoo, Denver, CO  
PAPER: Integrated Pest Management Program Presentation in Tropical Discovery at the Denver Zoo
- Susie Haeffner, Denver Zoo, Denver, CO  
PAPER: Problems and Solutions Involved in Breeding and Rearing of the Crested Screamer, Including Artificial Incubation Techniques, at the Denver Zoo
- Andy Lodge, Ngare Sergoi Support Group, Inc., Columbus, OH  
PAPER: Ngare Sergoi Rhino Sanctuary Update
- Shane Good, Cleveland Metroparks Zoo, Cleveland, OH  
PAPER: Pest Control at the Cleveland Metroparks Zoo
- Christina Smith, Houston Zoo, Houston, TX  
PAPER: The History of the Houston Zoo Enrichment Committee
- Thomas LaBarge, Burnet Park Zoo, Syracuse, NY  
PAPER: Small Scale Exhibit Renovation at the Burnet Park Zoo
- Penny Cram, Kansas City Zoo, Kansas City, MO  
PAPER: African Elephant Introductions at the Kansas City Zoo
- Kathleen Harward/Sheri Leavitt, Houston Zoo, Houston, TX  
PAPER: Positive Reinforcement Training of a Crested Caracara
- Jeffrey Phillips, North Carolina Zoological Gardens, Asheboro, NC  
PAPER: Warthog Operant Conditioning
- Jay Ferreri, Riverbanks Zoo and Botanical Garden, Columbia, SC  
PAPER: Operant Conditioning of a Diabetic Hamadryas Baboon
- Sue Woods, Aurora, CO  
PAPER: Ear Covering by Captive Great Apes: A Shared Behavior Related to Stress

Margaret Abadie, Houston Zoo, Houston, TX  
PAPER: Getting Involved: Keeper Participation in Taxon Advisory Groups

John Phillips, Wildlife Safari, Winston, OR  
PAPER: Lion Introductions

Christine Bobko, Denver Zoo, Denver, CO  
PAPER: Bowling For Rhinos Winner

Scott Fuller, Miami Metro Zoo, Miami, FL  
PAPER: Hurricane Andrew - The Aftermath and Recovery

William Baker Jr., Houston Zoo, Houston, TX  
PAPER: Development of a Crisis Management Team in a Zoological Institution

Megan Phillips, Denver Zoo, Denver, CO  
PAPER: Conditioning of Nyala and Bongo to Blood Sampling in a Crate with Positive Reinforcement

Chris Hamlin, San Diego Zoo, San Diego, CA  
PAPER: Zookeepers and Field Research - Partnership Between San Diego Zoo and Koala Field

Marcy Miller-Lebert, Pt. Defiance Zoo & Aquarium, Tacoma, WA  
PAPER: Waterfowl Breeding on a Budget

Lucy Segerson, North Carolina Zoological Park, Asheboro, NC  
PAPER: Initiating a Gorilla Training Program at North Carolina Zoo

Connie Phillips, Memphis Zoo & Aquarium, Memphis, TN  
PAPER: Operant Conditioning with the Great Apes

Patty Pearthree, Indianapolis Zoo, Indianapolis, IN  
WORKSHOP: Bowling for Rhinos

Bob Wiese, AZA Executive Office, Bethesda, MD  
WORKSHOP: Understanding SSP Recommendations

Rosemary Krussman, National Aquarium at Baltimore  
WORKSHOP: Ecosystem Survival Plan

Norm Gershenz, Center for Ecosystem Survival, San Francisco, CA  
WORKSHOP: Conservation for the Twenty First Century:  
Partnerships for Saving Wildlife in Nature

Maria McManus, Indianapolis Zoo, Indianapolis, IN  
POSTER: The Behavioral Effects of Whole vs. Sliced Food Items on *Hylobates Lar*

Amy Backo, Houston Zoo, Houston, TX  
POSTER: Exhibit Design for Breeding Fennec Fox

1995 AAZK National Conference  
Denver, Colorado  
September 24-28, 1995

CONFERENCE REGISTRATION FORM

Name \_\_\_\_\_

Address \_\_\_\_\_

City \_\_\_\_\_ State/Province \_\_\_\_\_

Zip/Postal Code \_\_\_\_\_ Phone (\_\_\_\_) \_\_\_\_\_

Zoo Affiliation \_\_\_\_\_ Position/Title \_\_\_\_\_

AAZK Chapter \_\_\_\_\_ AAZK Membership Status \_\_\_\_\_

Number of AAZK Conferences you have attended \_\_\_\_\_

AAZK Committee Member? \_\_\_\_\_

Presenting a Paper/Poster? (please circle) Yes \_\_\_\_\_ No \_\_\_\_\_

Title \_\_\_\_\_

Participating in Zoolympics? Yes \_\_\_\_\_ No \_\_\_\_\_

Bringing an Auction Item? Yes \_\_\_\_\_ No \_\_\_\_\_

Optional Activities: (extra charges involved)

Need table in Exhibitors Hall? Yes \_\_\_\_\_ No \_\_\_\_\_

Casino Trip on Monday night Yes \_\_\_\_\_ No \_\_\_\_\_

Pre-Conference Trip A Yes \_\_\_\_\_ No \_\_\_\_\_

Pre-Conference Trip B Yes \_\_\_\_\_ No \_\_\_\_\_

Post-Conference Trip Yes \_\_\_\_\_ No \_\_\_\_\_

Horseback riding on Post-Conf. Trip Yes \_\_\_\_\_ No \_\_\_\_\_

Vegetarian? Yes \_\_\_\_\_ No \_\_\_\_\_ What type? \_\_\_\_\_

T-Shirt? Yes \_\_\_\_\_ No \_\_\_\_\_ Size (L, XL) \_\_\_\_\_

Arrival Date and Time \_\_\_\_\_

1995 AAZK National Conference  
Denver, Colorado  
September 24-28, 1995

CONFERENCE FEE SCHEDULE

AAZK Member	\$100.00*	_____
Member Spouse	\$100.00*	_____
Non-Member	\$110.00*	_____
Non-Member Spouse	\$110.00*	_____
Casino Trip Charge	\$ 10.00	_____
Exhibitors Table Fee    # Tables _____ (\$30.00 full table, \$15.00 half table)		_____
Daily Fee                                    (which day) _____ (See Day Rates Schedule on next page)		_____
Pre-Conference Trip A	\$ 20.00	_____
Pre-Conference Trip B	\$ 35.00	_____
Post-Conference Trip	\$150.00	_____
Horseback Riding on Post-Conf. Trip	\$ 30.00	_____
Late Fee (after August 1, 1995) (only for full conference, not for individual days; no reservations for Pre- or Post-Conference trips accepted after August 1.)	\$ 10.00	_____
TOTAL FEE ENCLOSED	\$	_____

\*Fee includes a \$20.00 contribution to AAZK National.

\*Fee does not include cost of Conference Proceedings.

Please make checks payable (in U.S. funds) to: "AAZK Conference 1995"

Send Registration form and all fees to:

Vickie Kunter  
Rocky Mt. AAZK  
Denver Zoo  
2900 E. 23rd Ave.  
Denver, Colorado 80205



**1995 AAZK National Conference**  
**HOTEL REGISTRATION FORM**

Name \_\_\_\_\_

Address \_\_\_\_\_

City/State/Zip \_\_\_\_\_

Telephone \_\_\_\_\_

Arrival Date/Time \_\_\_\_\_ Departure Date/Time \_\_\_\_\_

Rooms will be held after 6PM only if guaranteed with a major credit card. Once guaranteed, there will be no refund for cancellation.

**Credit Cards accepted: VISA, MasterCard, American Express, Diner's Club**  
*(Please Circle)*

Name as it appears on card \_\_\_\_\_

Card Number \_\_\_\_\_ Expiration Date \_\_\_\_\_

**ROOM RATES:**

\_\_\_\_\_ 1 Double Bed                      \$88.00

\_\_\_\_\_ 2 Double Beds                      \$96.00

**\*\*Cots may be set up in rooms for an additional charge of \$10.00\*\***

**\*\*Up to four (4) people may stay in one room\*\***

**\*\*Roommates are the responsibility of each registrant\*\***

**Hotel Check-in: 2:00 PM - Check-out: 12:00 noon**  
**Parking is available at the hotel for a fee of \$7.00 per day.**

**To make reservations by phone, dial 1-800-525-6651**

**Please return this form to:**

**Executive Tower Inn**  
**1405 Curtis Street**  
**Denver, CO 80202**

**Reservations MUST be made by 1 September 1995**  
**in order to receive special Conference rates.**

# AAZK Book Sale

## Sug. Price      Sale Price

- \$14.95 \$12.15 **One Small Square Pond** by D. Silver. A delightful children's book explores how "ordinary" bodies of water teem with life. Also includes instructions for further activities. 48 pgs., full color illustrations, hardcover.
- \$10.95 \$ 8.95 **Hawks in Flight: A Guide to Identification of Migrant Raptors** by P. Dunne & C. Sutton. 254 pgs., paperback with b&w photos and drawings.
- \$47.50 \$38.00 **South American Birds: A Photographic Aid to Identification** by J.S. Dunning. Includes over 1400 color photos with species identification information, habitat keys, range maps and more. Hardcover.
- \$16.95 \$13.60 **The Naturalist's Garden: Bringing Your Yard to Life with Plants that Attract Wildlife** by R.S. Ernst 274 pgs., paperback with b&w illustrations and charts.
- \$15.95 \$12.95 **Twilight Hunters: Wolves, Coyotes and Foxes** by G. Turbak & photos by A. Carey. A book of wild canines filled with facts and full-color photos. 100 pgs., paperback.
- \$40.00 \$32.00 **Bears: Their Life and Behavior** by W. Ashworth & photos by A. Wolfe. A beautiful compilation of photos and facts on North American bears. 224 pgs., 175 photos, hardcover.
- \$27.95 \$22.40 **The Encyclopedia of Insects** edited by C. O'Toole. 24 distinct groupings of insects are discussed and photographed. 160 pgs., hardcover.
- \$14.95 \$12.15 **Sea Turtle: So Excellent A Fishe** by A. Carr. A lively and authoritative account of this unusual creature by a world expert in the field. 280 pgs., paperback.
- \$14.95 \$12.00 **Animal Minds** by D.R.Griffin. A thoughtful and thought-provoking look at how animals perceive the world. 310 pgs. paperback.
- \$ 8.95 \$ 7.35 **Unnatural Selections: A Far Side Collection** by G. Larson. Need we say more? The right book when you need a laugh and it makes a great gift! 96 pgs., paperback.

Previous books offered are still available, some with price increases. Call (203) 576-8126 and ask for Jeanne Yuckienuz to get price update. **TO ORDER:** List the books you want along with your name and complete mailing address. Include shipping fee of \$2 for the first item and \$1 for each additional item. Make checks or money orders payable to "AAZK Book Sale" (U.S. FUNDS ONLY - no cash or CODs, please). Mail order to: AAZK Beardsley Chapter, attn: Jeanne Yuckienuz, 1875 Noble Ave., Bridgeport, CT 06610-1600.

# Births & Hatchings



**Pangaea Productons (Miami, FL)**....I am pleased to announce that 0.0.1 greater bushbaby (*Galago garnettii*) was born on 17 June 1995. The infant (see photo below) weighed 50.15 grams (1.8 oz.) at birth and as of this writing was 62.20 grams ( 2.2 oz.) [4 days of age]. In addition to this announcement, if I can be of any assistance in providing data on daily weights of this subspecies or observations made on the infant's physical development as well as maternal behavior, please let me know. I am keeping careful records of this on a daily basis. I was also privileged to witness the end of the birth which occurred at 11:45 p.m. The birth took place very fast, in only about 10 minutes. The female was in an upright sitting position with her front legs outstretched in front of her. She assisted herself with delivery by pulling the baby out, using her hands. The baby was groomed and the afterbirth eaten. Also, if useful, I can provide my protocol which I used as well as changes made to adjust for pregnancy. *submitted by Jason Abels, Keeper/Trainer, Pangaea Productions, 15272 S.W. 104th St., #635, Miami, FL 33196.*



**Greater Bush Baby (*Galago garnettii*) born 6-17-95**

(Continued on page 327)

# Neonatal Immune System as it Relates to Hand-Rearing

*Presented by Marcia B. Morse, Sr. Keeper / Mammal Dept.  
Non-Domestic Neonatal Symposium, October 1990*

*Revised by K. Michelson, Lead Keeper / Veterinary Services  
Zoological Society of San Diego, San Diego, CA*

For those of us involved in the hand-rearing of exotic neonates, the serum immunoglobulin levels of the animals we receive are a matter of concern. Various factors affect the condition of the infants' immune systems, ranging from the placentation of the species, whether the neonate has nursed before being pulled, the condition of the dams' immune system, etc. Having a good understanding of the neonatal immune response makes it easier to provide the care needed to successfully bridge the critical first days of life.

Immunoglobulins (Igs) are divided into three classes, designated IgG, IgM, and IgA. Additionally, IgG can be subdivided into IgG1 and IgG2. In most species, the predominant factor in colostrum is IgG, which may account for 60-90% of total Ig content. As colostrum changes to milk, IgG remains dominant in ruminants, but in nonruminants IgA becomes dominant as IgG levels in the milk drop rapidly (Fig. 1).

## Figure 1.

### Colostrum Ig Levels (mg/ml)

	IgA	IgM	IgG
Horse	.5 - 1.5	1.0 - 3.5	25.0 - 90.0
Cow	1.0 - 7.0	3.0 - 13.0	34.0 - 39.0

### Milk Ig Levels (mg/ml)

	IgA	IgM	IgG
Horse	.5 - 1.0	.05 - .10	.20 - .50
Cow	.10 - .50	.10 - .20	1.5 - 7.5

When presented with an animal to be hand-reared, it is helpful to be familiar with the placentation of the species (Fig. 2). As seen from the table, felines, canines, primates

and rodents receive some level of Ig transfer through the placenta before birth. Therefore, while an infant from an immunodeficient dam would still be cause for concern, we can expect young of these species to be at least partially equipped with immunities from birth. While it would still be desirable for these neonates to receive colostrum, it is not as crucial.

**Figure 2**

Species	Type of Placenta	Placental Transfer of Igs	Colostrual Transfer of Igs
Pig, Horse	Epitheliochorial	0	+ + +
Ruminants	Syndesmochorial	0	+ + +
Felines, Canines	Endotheliochorial	+	+ + +
Primates	Hemochorial	+ +	+
Rodents	Hemendothelial	+ + +	+

Of greater concern are the hoofed animals, which receive no Igs placentally. It is of extreme importance that neonates of all hoofed species receive colostrum or a substitute in a timely fashion. Most of the research on patency, or the period when colostrual proteins can be absorbed in unchanged form by the small intestine, has been done on domestic cattle. Figures range from 24 to 36 hours, with an average of 27 hours, during which the efficiency of Ig absorption decreases at a variable rate dependent on many factors, such as species, individual physiological differences, etc. These figures can be applied to exotic ungulates as well, although ideally some studies done on various exotics could provide us with more accurate information.

In evaluating the neonate's immune status, several methods can be used. The most accurate test is probably serum protein electrophoresis, but this is a costly and time-consuming method. There are two methods used at the Wild Animal Park and San Diego Zoo; the sodium sulfite test, and the glutaraldehyde test respectively. The glutaraldehyde test acts by coagulating the serum proteins. The advantage of this method is the fact that it is not geared towards any one species, so it detects a wider range of Ig levels. Disadvantages are that it needs to be read at several intervals throughout the test period, so is more difficult to interpret.

The other test, commercially produced for the cattle industry, is named Bova-S®. This test also coagulates the serum using a sodium sulfite reagent, causing an increase in turbidity in the test solution that can be sight read. Advantages of this method are: the test is available ready to use and is less time-consuming than the glutaraldehyde method. A disadvantage is the fact that the test is geared to a single species, and the proteins of exotics may not react predictably with the reagent. Of course, all test methods are

complicated by the fact that no baseline serum Ig levels have been established for most of the exotics we deal with. Thus, what may constitute a negative result for a cow, may not necessarily be a negative for a Bongo or Sika deer. We simply don't know what normal levels are in most of these animals.

There are several ways to provide a neonatal ungulate with Igs so that it can develop adequate passive immunity. Colostrum milked from the dam and subsequently bottle fed is a method commonly used in domestic cattle. This method is seldom practical when dealing with exotic hoofed stock, for obvious reasons. A more workable method is to obtain colostrum from domestic cattle, which when suitably processed and frozen, can be stockpiled in anticipation of future need. Care must be taken that colostrum obtained in this way comes from suitably vaccinated and inspected herds. This method has been used with great success at the Wild Animal Park.

In the absence of a supply of bovine colostrum, a substitute can be used such as Colostryx® or Immu-Start®. Both are a powdered concentrate of broad spectrum Igs produced for the commercial cattle industry. Designed to be mixed with water, it is convenient to store and use when needed. In some cases, fresh goats' or mares' colostrum or substitute is used, it is desirable to include it as 10% of the regular formula for several weeks past the point of gut closure. The Igs in colostrum have a local effect against pathogens in the digestive tract, even though no more can enter the bloodstream via this route.

The older immunodeficient neonate, one that is already past the point of gut closure, or infants with absorption problems need to be provided with Igs parenterally if possible. This can be attempted by plasma transfusions from like or closely related species. Whole blood drawn from healthy animals can be spun down to separate the serum then frozen. All appropriate information must be recorded on the plasma including the immobilization agent, if any, as traces of the chemical used will be circulating in the plasma when it is administered to the patient, and it is prudent to have the appropriate drugs available for reversal or treatment of respiratory distress in the event of a reaction. The plasma can be quick thawed and administered via I.V. therapy, or subcutaneously if necessary. In this way the infant is provided with Igs in unchanged form directly into the system.



The plasma program at the Wild Animal Park was started by Dr. Jack Allen early in 1990. A logbook is kept with taxonomic categories that record the donor I.D., date plasma was collected, immobilizing agent (if any), and the recipient of the plasma. As of this writing (1995), units of plasma from 16 sub-families have been stored, with over 90 units used to benefit the animal collection.

To conclude, while information gathered from domestic animals can provide a starting point in evaluating the immune status of the exotic neonates we raise, it is clear, as in so many aspects of our profession, that much more research is needed to provide an understanding of these issues in exotics.

## Bibliography

1. Butler, J.E. 1983. Bovine Immunoglobulins- An Augmented Review. *Veterinary Immunology and Immunopathology* 4:43-152
2. Olson, D.P. 1989. Comparison of Two Methods for Thawing Colostrum Before Supplemental Feeding To Newborn Calves. *Bovine Practitioner* 24:83-86.
3. Robbins, C.T. and Oftedal, O.T. 1987. Lactation, Early Nutrition, and Hand-rearing of Wild Ungulates, with Special Reference to Deer. *Research Symposia of the National Zoological Park*. Smithsonian Institution Press, Washington, D.C.
4. Scott, G.H., et al. 1979. Colostral Immunoglobulin Transfer in Calves. *Journal of Dairy Science* 62:1766-1773.
5. Tizard, Ian R. 1977. *Introduction to Veterinary Immunology*. Saunders Publications.

---

## ***Birthe & Hatchings*** (Continued from page 323)

**Miller Park Zoo (Bloomington, IL)**....would like to report the following B&H from 1 January to 1 June 1995:

Mammals - 0.0.1 black-tailed wallaby (*Wallabia bicolor*) [1st for institution].

Birds - 1.0 crested quail dove (*Geotrygon versicolor*) [1st for institution].

Invertebrates - 0.0.25 giant cockroaches (*Blaberus giganteus*) [1st for institution]; 0.0.2 red velvet ants (*Dasymutilla* sp.) [1st for institution].  
*submitted by Jan Outlaw, Keeper, Miller Park Zoo, Bloomington, IL.*

**The Exotic Feline Breeding Compound/Feline Conservation Center (Rosamond, CA)**....announces the following births from April 1994 - May 1995:

Mammals - on 30 May 1995 - 0.0.1 Amur leopard (*Panthera pardus orientalis*) [E/SSP, 1st for pair, 1st for institution]; 1.0.1 northern Chinese leopard (*Panthera pardus japonensis*) [E/SSP - 0.0.1 DNS]; 0.2.1 fishing cat (*Felis viverrinus*) [0.0.1 DNS]; 2.1 jaguar (*Panthera onca*) [1st for pair]. *submitted by Nancy Vandermeij, Secretary, EFBC AAZK Chapter.*

**Little Rock Zoo (Little Rock, AR)**....announces B&H from Dec. 1994 - June 1995:

Mammals - 0.1 sloth bear (*Melursus ursinus*); 3.2 maned wolves (*Chrysocyon brachyurus*); 0.2 warthog (*Phacochoerus aethiopicus*); 0.0.2 King's Island wallaby (*Macropus rufogriseus*); 4.2 capybara (*Hydrochoerus hydrochaeris*).

Birds - 0.0.4 Black swan (*Cygnus atratus*).

Reptiles - 2.2 eastern indigo (*Drymarchon corais couperi*). *submitted by Marie Schmude Greene, Chapter Liaison, Little Rock Zoo AAZK Capter.*



# ENRICHMENT OPTIONS

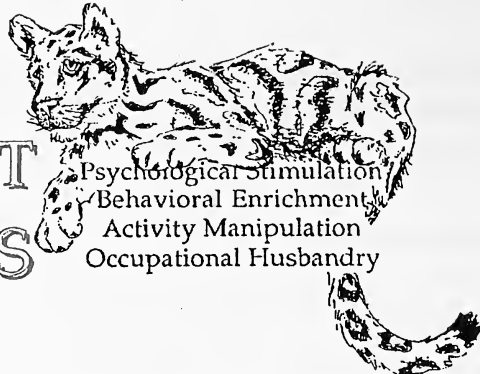

Psychological Stimulation  
Behavioral Enrichment  
Activity Manipulation  
Occupational Husbandry

*By Kayla Grams, Arizona-Sonora Desert Museum  
and Gretchen Ziegler, Sequoia Park Zoo*

**CHIMPANZEES** - the North Carolina Zoo had an artificial tree installed in the chimpanzee exhibit which resulted in the chimps being held in their night quarters for about three weeks. To help relieve boredom and stress, the keepers were encouraged to come up with several enrichment ideas using different foodstuffs and other items (many of which were introduced for the first time). Some of the items we used were going to be thrown away and consequently were "recycled".

## 1. Empty Feed Bags

-placed in the caging empty for chimps to tear up, or males to use in their displays  
-put regular diet items or special treats inside and fold up or roll bag up and tie a string (from hay bales) around it, then hang from caging wire, monkey bars, or benches (this can also be done with empty paper bags).

2. Boxes - put treats in boxes and close back up; or tie string around it and hang from monkey bars (chimps treat them like a pinata).

3. Paper Towel Tubes - fill with food treats and stuff straw in the ends.

4. PVC Pipe cut into 6 to 10-inch lengths - fill with fruit or put string through it and tie to caging wire or monkey bars.

5. Empty Water Jugs or Bleach Bottles - put peanuts, raisins, or sunflower seeds inside.

6. Old Telephone Books

7. Scraps from computer print-out sheets that are torn from the sides.

8. Old T-shirts that are cleaned out of peoples' closets.

These enrichment ideas may also be used with other apes.

*—Lucy Segerson, Keeper  
North Carolina Zoo, Asheboro, NC*

**IGUANA** - offered hibiscus leaves and flowers besides regular diet.

**LARGE PSITTACINES** - given different sizes and lengths of fruit and vegetables such as apple, orange, carrot, celery, and banana. Fruit is chunked, sliced thin, halved,



or given whole on occasion. Other treats include peanuts, rye crackers, and dry pasta. On occasion they are given a limb of a ficus or elm tree, and small bits of Bird of Prey diet.

**COYPU** - given a variety of logs, branches, pieces of wood on land and in the water. Given fresh browse all year round (ficus, elm or willow).

—*Fawn Prevost-Dyck, Keeper  
Topeka Zoological Park, Topeka, KS*

**NATURALISTIC TREAT BOX** - has hinged lid with mesh sized for species; increases eating time. Sunk into hollow tree trunk may make it more appropriate for public display.

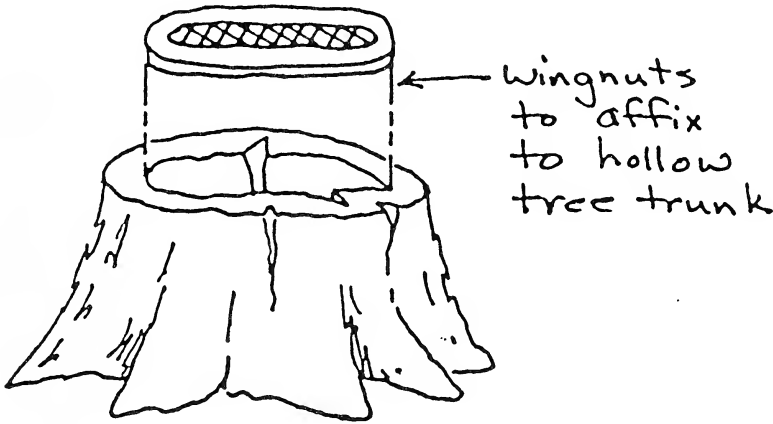

**GREENS DISPENSER** - sandwich between leaves and hang in or outside cage; much activity spent in proximity.

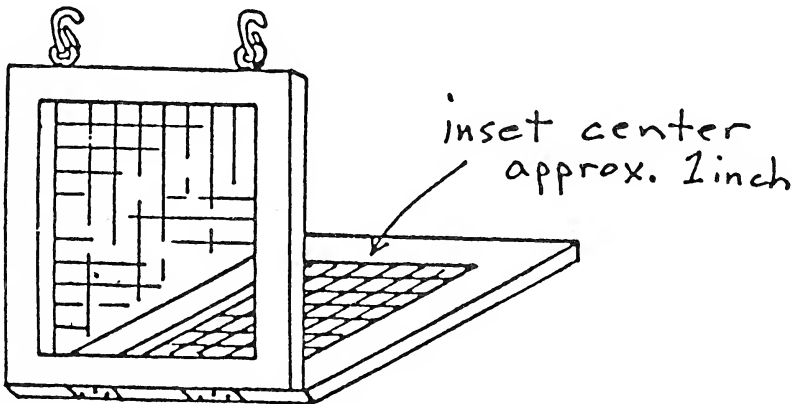

—*Bruce Clark, General Curator  
Jackson Zoo, Jackson, MS*

**SMALL PRIMATES** - put fruit pieces on different branches in holding or on exhibit. Put mealworms or crickets in log hollows. This has been tried with tamarins.

**SMALL CATS** - logs with bark were added to holding cages for climbing and scratching. Rats were given once a week for plucking. Den boxes were built for hiding and made into a squeeze box. These are used with jaguarundis and margays.

—*Darlene Klimek, Assistant Supervisor Small Mammals,  
Henry Doorly Zoo, Omaha, NE*

*Remember, we are always needing more ideas to include in this enrichment column. Send your suggestions, ideas, etc. to: Gretchen Ziegler and Kayla Grams, AKF, 635 S.W. Gage Blvd., Topeka, KS 66606-2066. We are counting on you to help us continue to fill this column with ideas that will make life better for our captive charges. Make it a Chapter project to gather ideas already in use or come up with new ones to try.*

## *African Journal*

Lewa Downs Conservancy, Isiolo, Kenya  
May 31, 1995

*by Patty Peathree, National Coordinator  
AAZK Bowling for Rhinos*

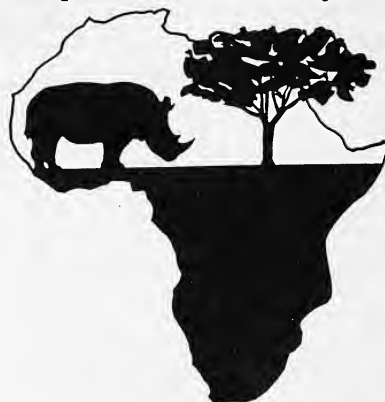

I awoke at 6:00 a.m. to the calls of Hadada ibis “hadada...hadada” as they flew over our tented research camp towards the swamp—no need for an alarm clock here! I climbed out of my tent which I’ll call home for the next two months to see a troop of vervet monkeys scatter away from us into the yellow fever acacia trees. In this early morning light, the trees glow like gold and the monkeys are yellowish-green, except for their very black faces.

Graham, a wildlife management specialist from the University of Peoria, South Africa, my husband Herbie and I jump into the Land Rover and head out for three hours of observations. Using a global positioning system (GPS), binoculars, and our knowledge, we head for a different area of the Conservancy each day to gather data. We travel down the rocky road a short distance until we spot some of the study animals, the grazing animals of Lewa Downs. We count the numbers, identify the males, females and juveniles, list their activity, habitat type, association with other animals, and other data to complete a habitat selection study. Near noon we return to the camp for lunch, enter the data into the computer, take care of our personal effects, and head back out to gather more data around 4:30 p.m.

Graham is employed by Lewa Downs Conservancy (LDC - formerly Ngare Sergoi Rhino Sanctuary and Lewa Downs) to help them learn to analyze their habitat and to encourage proper wildlife management. Wildlife management has long been in practice in South Africa but is a fairly new concept in Kenya because much of the wildlife areas are somewhat recently enclosed by protective fences, or surrounded by farms and people which creates a fencing effect. This fencing effect brings with it many of the same management problems that are faced in the zoo world.

On these data collecting trips I've realized how lucky we are to be involved in supporting LWC. The climate is nearly ideal, on the equator but nearly one mile high in elevation. The days are warm and dry, and the nights are cool—perfect for sleeping. The area includes all habitats one would expect throughout Africa (except desert). There are great grassy plains speckled by acacia; rocky buttes pointing upward out of the rolling plains; the swamp with tall reeds and abundant with wildlife; a newly constructed dam (actually a place that collects rainwater and where the elephants LOVE to play); streams that are fed by the runoff of Mount Kenya that breakup the plains with reeds, yellow fever trees, and figs; the Ndare Forest is thick in vegetation with waterfalls, oak, cedar, and many trees with berries. The acacia forests are grouped in areas with red and yellow seyal acacia (the bull elephants seem to love the sound the seyal makes when they snap it apart—hardly any left!).

Lewa Downs Conservancy started as a private cattle ranch called Lewa Downs, named after the Lewa springs which runs through its heart. Since 1945, the Craig family directive was "always make room for wildlife". In 1985, Anna Merz approached David Craig to start a rhino sanctuary on their property. David agreed and allowed 5,000 acres for the start of the Ngare Sergoi Rhino Sanctuary. Due to the success of the Rhino Sanctuary, this 5,000 acres soon became 10,000 acres. Since 1990, through the efforts of Andy Lodge of the Ngare Sergoi Support Group, Inc., AAZK, Inc. has been helping Lewa through the Bowling for Rhinos project and has sent over \$560,000 to the Conservancy. These funds have been used to purchase a surveillance airplane, a large lorry (truck), patrol jeeps, fencing materials, and to pay the salaries of the armed guards needed near every rhino to keep them safe from the shifta (poachers). Recognizing the tremendous success of Lewa Downs, the government allowed 15,000 acres of the Ndare Forest to be enclosed under the protection of Lewa Downs Conservancy. The LWC management staff hopes to include a huge area to the north of Lewa as part of their wildlife management plan as the local people have realized the benefits offered by wildlife and tourism.

Now one can watch the black and white rhinos roam the hills and plains, intermixed with livestock, and the other African wildlife. Included are 12% of the world's population of the endangered Grevy's zebra, many plains zebra, warthogs, reticulated giraffe, African buffalo, common eland, greater kudu, waterbuck, gemsbok, impala, hartebeest, oryx, dikdik, Thompson's and Grant's gazelle, gerenuk, aardvark, rock and bush hyrax, savanna baboon, vervet and

*...the Craig family directive was "always make room for wildlife".*

colobus monkeys, bushbabies, hundreds of elephants, crowned cranes, ibis, bee-eaters, monkey-eagles, and thousands of other birds and insects to name just a few.

Saving the rhino habitat is what Bowling for Rhinos is all about and my first three days at Lewa reminded me of this. While staying in the guest house of Anna Merz, I was awakened each morning by the pig-like squeals of the 200-pound Samuel, the two-month-old male offspring of Samia, the rhino Anna Merz hand-raised. Many were concerned about Samia's mothering ability, since she learned hers from a human, but as you watch mother and son together, it is apparent that Samia is doing an excellent job. In the evenings, Samia brings Samuel near Anna's garden for safety. At sunrise, Samia leads Samuel out onto the plains, browsing on her favorite acacia and responding to Samuel's squeaks "Mom, where are you?". Samia browses constantly while walking,

until she pauses to feed Samuel. In the heat of the day, they lay beneath a large acacia in the shade, mother resting with one ear up listening while Samuel suckles or sleeps. Once rested, Samia leads into the bush, with Samuel romping in the grasses behind her. It is obvious that Anna was a very good mom, so is Samia.

Note: Patty returned from Africa early this month. She will be giving a presentation at the Denver Conference on her findings at LWC this year, in addition to the 1995 Bowling for Rhinos Workshop.

## Hand-rearing the Red-throated Ant Tanager at Brookfield Zoo

by Scott Schiller, Keeper  
Brookfield Zoo, Brookfield, IL

The red-throated ant tanager (*Habia fuscicauda*) is a member of a large family of tropical tanagers, most of which inhabit the forest canopy. This species, however, spends much of its time following ant swarms on the ground to feed on insects escaping the ants' path. Although primarily insectivorous, fruit does form a part of its diet. Red-throated ant tanagers typically breed May through August. The female alone incubates two to three eggs for 12-14 days, and nine days after hatching the chicks fledge. They clamber to the ground and are led to dense cover by the parents until they are able to fly some time later.

### 1992 CHICKS

In 1992 one breeding pair of red-throated ant tanagers was set up in a mixed-species free-flight aviary 15.8m x 9.75m x 9.75m (52' x 32' x 32') where they produced and partially reared their first clutch. Two chicks fledged 10 days after hatching and made their way to their parents on the ground. Both chicks were weighed (avg. = 27.9 g or 1 oz.) and briefly examined. They were well-feathered but could not fly. Due to potential aggression from a pair of Malayan peacock pheasants (*Polyplectron malacense*) in the exhibit, we decided it would be best to remove the chicks and hand-rear until weaned.

The chicks were housed together in a ventilated wooden box 91cm x 61cm x 61cm (36" X 24" X 24") in our hand-rearing room. The room was kept at 26-27° C (78-80°F)(dry bulb) and 23° C (74°F) (wet bulb). We fed the chicks hourly from 0730 to 1700 hrs. Their diet consisted of diced newborn mice (pinkies), waxworms, mealworms, moistened pieces of Reliable Protein Products' Softbilled Bird-Fare® and the moist base mix from Brookfield Zoo's frugivore diet (the staple diet item of our tanagers). The chicks were weighed every morning before the first feeding.

Both chicks displayed eager begging responses when hand-fed. Many times feedings were lengthy due to the birds' frenzied bouts of activity, which included wing-flapping, preening and just hopping about. By Day 20 one chick was beginning to take food pieces from the forceps and eating on its own. At this point we offered a pan of food items to the chicks inside their cage. By Day 22 the chicks were accepting small pieces of diced fruit in their diet (grapes, apples and blueberries). We reduced feedings to six a day at this time.

By Day 25 we were allowing the chicks to fly around the room to exercise their wings. It was also at this time that they began to perch on the lip of the food pan at every feeding. We began to feed each bird directly from the food pan to create an association between the two. The young ant tanagers were eating live crickets for the first time at Day 25.

By 34 days of age we reduced feedings to just four a day. By this time we discovered food items missing from their food pan, specifically waxworms. Videotaping of the chicks between feedings proved that they were not only self-feeding, but one was feeding the other! At this time we offered the birds a pan with the adult ant tanager diet: frugivore diet, Softbilled Bird-Fare®, shredded leafy greens and insects (waxworms, mealworms, mighty mealworms and legless crickets). On Day 36 we discontinued hand-feeding the chicks.

Over the next week the two young birds were eating well on their own, their weights were stable and were considered completely weaned. By 42 days of age the ant tanager juveniles were moved from the hand-rearing room to a small, mixed tanager exhibit 33cm x 18cm x 20cm (13' X 7' X 8'). Both began to molt in reddish throat feathers at approximately eight weeks. However, some six months later they developed the distinctly yellowish throat feathers of females.

## 1995 CHICK

In June 1995, our only adult breeding female ant tanager, the same dam of the 1992 chicks, died of old age. She left behind a newly-laid clutch of three eggs. The decision was made to artificially incubate the eggs and hand-rear the young. No one had ever artificially incubated red-throated ant tanager eggs before, not to mention hand-reared hatchlings. All we had to guide us was the data from our 1992 ant tanager fledglings and our experiences with other tanager species (e.g. blue-greys).

We transferred the three eggs from the nest to a Humidaire® incubator immediately and incubated at 38°C (99.5°F) (dry bulb) and 30-31° C (86-87°F) (wet bulb) for 13 days. After seven days it was found that only two eggs were fertile. One chick hatched in the late morning on 15 June 1995; the second chick died in the shell, just after entering the air cell. The red-throated ant tanager hatchling weighed 3.38 g (0.1 oz.) and was sparsely covered with grey down on its head, back upper wings, flanks and scapulars (Fig. 1). Its yolk sac was quite prominent and it already displayed a healthy begging response. By late afternoon it was even vocalizing soft "peeps". To prevent possible infection, its umbilicus was swabbed with Prepodyne Scrub®.

The chick was not fed the day of its hatching, allowing its yolk sac to be absorbed. We attempted to feed it the next morning, after it was transferred to a Lyon® chick brooder. This brooder was set at 37°C (99°F) (dry bulb) and 27°C (80°F) (wet bulb); we decreased the temperature and humidity 1°F a day, to achieve 80°F (dry bulb) and 21°C (70°F) (wet bulb) at 13 days of age (this is the temperature of the aviary where the bird would normally have fledged). Inside, the chick was placed in a small crock lined with layers of facial tissue.

Our hand-rearing diet was based upon what the parents would feed: lots of insects. We fed quartered cross-section slices of newborn mice (2-3g/0.1 oz. pinkies), waxworms and white (molting) mealworms cut into thirds, whole house fly maggots, and the insides of cricket abdomens. All insects were lightly coated in an insect supplement (a commercially

available cricket and mealworm breeding and maintenance diet) before being fed. All pinkie pieces were dipped in water before feeding. At one of the feedings, usually late morning, one or two food items were dipped in diluted liquid infant vitamins (1ml Poly-vitamin:20ml water) and coated lightly with bone meal powder. This was done as an added nutritional supplement.



**Figure 1. Red-throated ant tanager hatchling (1995) at approximately one day of age. ©1995 CZS Photo by M. Greer**

We began feeding the chick nine times a day, beginning at 0700 hrs. and again every 75 minutes. The chick displayed excellent begging responses throughout the day. It produced its first fecal sac at the midday feeding. The few times the chick appeared to have difficulty eliminating its fecal sac we lightly coated a food item with mineral oil, and this seemed to resolve the matter quickly. Days 3-7 we weighed the fecal sacs; each averaged 0.40 g (400 mg), though a couple of early morning sacs weighed as much 0.97-1.63 g (970-1630 mg).

It became routine for the chick to quickly become sleepy after consuming the first one or two food items. Patience while hand-feeding was essential at this stage. While feeding, we tried to imitate adult ant tanager vocalizations, to which the chick often responded with its own "peeps" Interestingly, the chick would immediately become still and silent whenever we imitated the rasping call of the adults (remember, this call is believed to function as an alarm call). At three days of age, we decreased daily feedings to eight, as the chick was gaining weight too quickly. At five days of age, pin feathers began to develop on the wings. We moved the chick to a slightly larger crock, with a couple of twigs on the bottom for the chick to grasp. At six days, feather tracts were forming and wing feather quills were elongating; its left eyelid was also beginning to open.

At seven days of age the chick weighed almost 20.0 g (0.7 oz.) and was moved to a Foster Parrot® brooder. At eight days feather tracts were well-developed along the chick's

back. At nine days the chick was found standing in its crock, stretching its wings and preening. Feedings were reduced to seven a day.

At ten days of age the young ant tanager displayed an abrupt increase in activity. From early morning to early evening, the chick was very vocal and active, stretching its wings, preening its feathers, and generally hopping around the floor of the brooder. Efforts were made to return the chick to its crock for feedings, but the bird continually hopped out, often too distracted by its own energy to be fed! We considered this to be the chick's "fledging", and subsequently moved it to a large, ventilated wooden box, identical to the one used to house the 1992 chicks. This box allowed the bird much more room to move about. It was also at this time that the chick's droppings were no longer encased in sacs.

In an effort to avoid imprinting on its human "parents", an artificial brown bird, purchased from a local crafts store, was placed in the box with the chick. We also attached it to our finger while feeding the chick (Fig. 2). A small mirror was also placed inside the cage to allow the chick to "socialize" with itself.



**Figure 2. Red-throated ant tanager chick (1995) being hand-fed with dummy "mother bird" on keeper's finger. ©1995 CZS Photo by M. Greer**

At 11 days of age, the chick continued its high level of activity. This, along with its intense interest in its reflection, made it a struggle to get the chick interested in its food. At Day 12, the chick was spending more time preening and bouncing around on its perches during its feedings.

At 13 days of age we switched the chick's diet to the same "fledgling" diet we used for the 1992 chicks. The only significant change made was a decrease in the number of pinkie pieces that were offered to the chick (pinkie pieces are very high in protein). The chick did not refuse the new food items, but its begging response was markedly decreased for much of the day. The bird was very sleepy, slightly puffed and perched sternally; its right wing was drooped and it seemed reluctant to swallow any food item offered. Our

veterinarian administered subcutaneous fluids to help hydrate the bird and prescribed 0.04cc Trimethoprim sulfa twice a day for seven days, to be injected in a waxworm.

The very next day the chick had perked up remarkably well. Its eyes were open and bright, it was vocal and alert, and its begging response was much improved. At Day 15 the young ant tanager continued to improve. Its wing was no longer drooped and its appetite returned. Its tail feathers had begun to emerge and it was observed bill-wiping after some feedings. By 16 days, the chick was taking food aggressively from the forceps. It was also wing-fluttering and peeping in the typical "baby bird" manner at nearly every feeding. At this point we resumed offering the new food items, including small bits of fruit, and the chick took them all very well. Overall, this chick appeared to have an appetite similar to the 1992 chicks (Table 1). At Day 17 the chick continually hopped to the box's door ledge, so we decided to test its flying ability. It took only short flights, but it flew and landed with coordination and balance.

By all accounts, the 1995 chick's growth pattern was normal and consistent with the average of the 1992 chicks' weights (Fig. 3). It is encouraging to observe that the red-throated ant tanager chicks we have worked with, whether parent-reared or hand-reared for the first 13 days, have developed at the same rate. Though we could never offer the same quality of care as the chicks' real parents, it is rewarding to think that our best efforts are good enough for them.

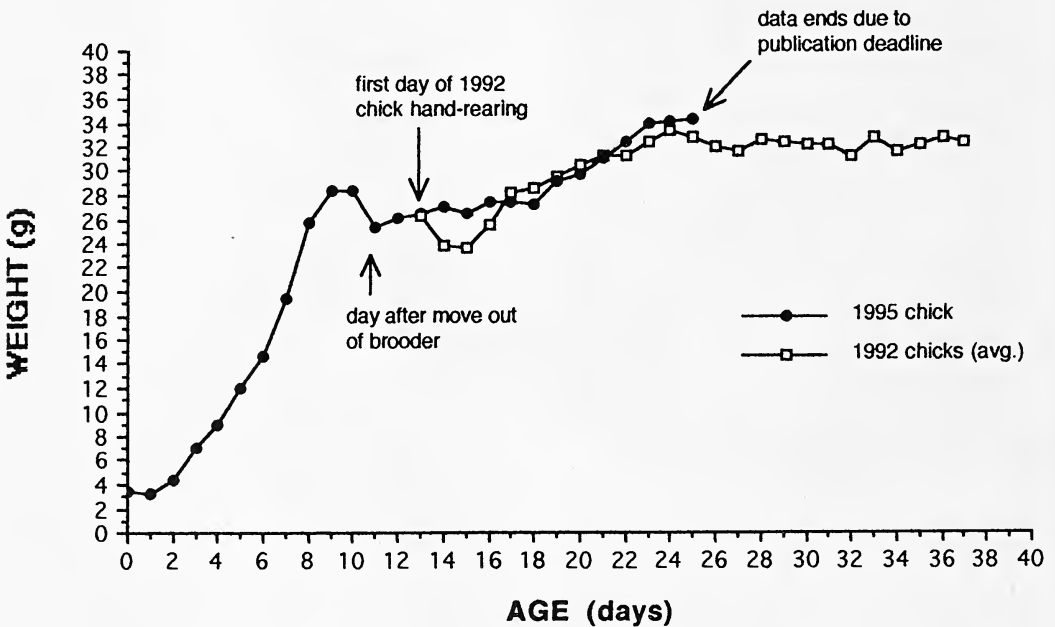

**Figure 3. Growth curve of hand-reared 1992 and 1995 Red-throated ant tanager chicks.**

Acknowledgements: Thanks to Dr. Patty McGill, Curator, and Celia Falzone, Collection Manager, for assistance in editing this manuscript. Also to Marcia Arland and the entire staff of the Bird Department for assistance in breeding and hand-rearing.



Table 1. Number of food items consumed by 1992 and 1995 hand-reared Red-throated Ant Tanager chicks during an 8-hour feeding day.

Age (days)	Number of birds	pinkie slice (0.15-0.30g)†	cricket abdomen (0.18-0.22g)	waxworm (0.18-0.22g)	mealworm (0.05-0.15g)	maggot (0.06g)	frugivore base mix (0.25-0.35g)	Softbill piece (0.10-0.15g)	blueberry (0.25-0.30g)	grape slice (0.20-0.25g)
0	1	0	0	0	0	0	0	0	0	0
1	1	2.75 <sup>^</sup>	2.50 <sup>^</sup>	3.67 <sup>#</sup>	1.33 <sup>#</sup>	0	0	0	0	0
5	1	2	14	14	15	0	0	0	0	0
10	1	3	14	8	14	5	0	0	0	0
15	3	9-23 *	7	14-17	10	6	0	0	0	0
20	3	4-19 *	0	14-18	3-6	0	6-17	2-6	5	0
25	3	0-7 *	3	10-13	2-8	0	4-12	1-2	3-6	1-2

† Numbers in parentheses denote average weight of average-sized food pieces.

\* Low end of range represents decrease of high-protein pinkie piece in 1995 chick's diet

# Waxworms and mealworms were fed in thirds due to chick's small size.

^ Pinkie slices were quartered due to chick's small size.

# Hand-Rearing an Emaciated Red Kangaroo Joey

by Yvonne Strode, Curator,  
Racine Zoo, Racine, WI

Although the red kangaroo (*Megaleia rufa*) is the world's largest marsupial, at birth it weighs a mere .75g (750mg). Approximately 150 days later the joey will weigh about 1600g and start protruding its head from its mother's pouch. At an average of 190 days, the joey will start leaving the pouch and will be permanently out at 235 days of age.



**A thin Jordan shown with feeding tube.**

On 31, July 1994, staff members at the Racine Zoo observed a red kangaroo joey fully emerged from its mother's pouch for the first time. Our pleasure at this sight soon disappeared as we saw the joey's lower body. Based on its extremely thin appearance and the fact that the mother had previously "dumped" a joey, we pulled the joey to evaluate its condition. With an approximate birth date of 15 January 1994, the joey should have weighed about 2500g (6 lbs.). Our joey, later named Jordan, weighed only 1100g (2 lbs.).

We attempted to feed Jordan using a special latex roo nipple we had left after hand-rearing an orphaned joey earlier in the year. After several unsuccessful attempts, he was taken to our veterinarian's clinic where an IV line was placed in his forearm to help in rehydration. The doctor also prescribed Cephalexin® as a precaution against infection due to Jordan's poor overall health.

Food was offered every two hours but Jordan still refused to take any significant amount of formula (3 parts water: 1 part Esbilac®). So, the next morning the decision was made to insert a stomach tube that was stitched to the right nostril. Feeding then became relatively easy and was done every two hours around the clock.

Jordan was housed in a cotton pillowcase (flannel would have been preferred but was unavailable due to the season) which was attached to the side of a portable, soft-sided playpen using heat lamp clamps. To provide heat, the pillowcase was placed on a heating pad set on low and a heat lamp was placed above the playpen. During the day, Jordan was placed in a small stall adjacent to our kangaroo stall. At night, he was transported to a staff member's home (the portable playpen was invaluable for this). When he was old enough to leave his pouch on his own, a screen was placed between the two stalls to introduce Jordan to our other kangaroos and wallaroos.

A severe case of diarrhea developed on 6 August which was resolved by adding lactaid to the formula. At the same time, Jordan started losing hair on his back and sides. He

lost the hair on almost one half of his body before the application of Lotrimin® medicated powder ended the problem.

On 7 August, Jordan was noticeably more active and alert. This led to a problem when he pulled his feeding tube out. Even though we had continued to encourage him to take formula from a bottle, Jordan rarely took more than 10cc at a time. After the feeding tube was removed, we were more persistent in our attempts to bottle feed. He did take more, but not enough to sustain himself so the feeding tube had to be reinserted.

On 16 August, one night feeding was deleted and Jordan was getting the majority of his formula from a bottle, although it continued to be a struggle to get him to accept feedings this way. The next day he pulled his feeding tube out again and it was decided to leave the tube out. At this time, the formula was concentrated (2 parts water: 1 part Esbilac®) and baby food was given at each feeding. We also put small pieces of fruit, vegetables, and bread in his pouch (as well as supplying calories, this gives the joey something to chew on besides himself). This feeding regime worked extremely well and was used throughout the remainder of Jordan's rearing (see Fig. 1 for weight gain information).

Jordan did develop a respiratory infection on 13 August which was successfully treated with Amoxicillin®. He also had periodic bouts of gas, which is common in hand-reared roos, for which he was given Simethicone®.

We closely monitored the solid food Jordan was eating and started weaning him after he was eating well on his own. The weaning period was prolonged (see Table 1) based more on the staff's enjoyment of feeding him than on Jordan's needs. Immediately after weaning, we started introducing all of the roos. Jordan was initially intimidated by his father and mostly ignored his mother. He occasionally fought with another unrelated adult female and soon started and continues to spend a great deal of his time with three adult female wallaroos.

At this time, we are preparing for Jordan's departure as he has been sold to another institution. We are also closely monitoring his mother who has a new joey in the pouch that has just started poking its head out. We hope that the mother can raise this joey on her own, but if not we are ready.

**Jordan shown in November of 1994 at about four months of age has filled out and recovered vigor due to careful feeding and caretaking.**

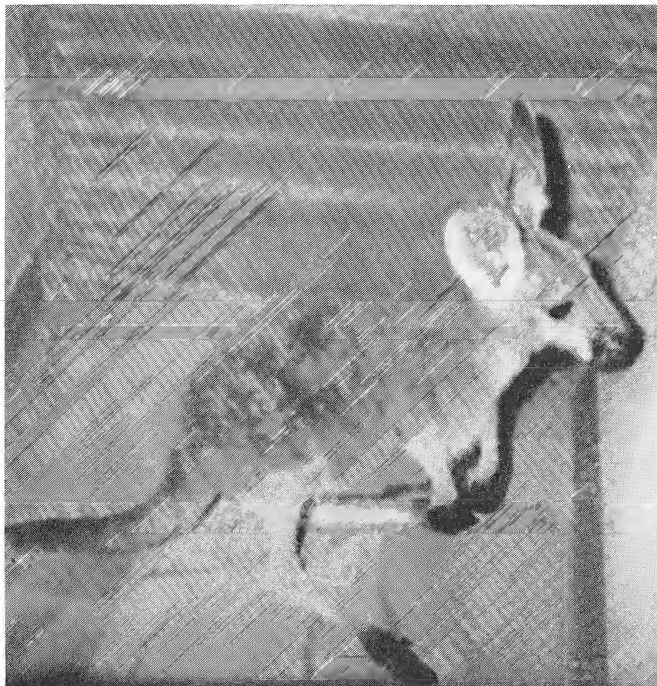

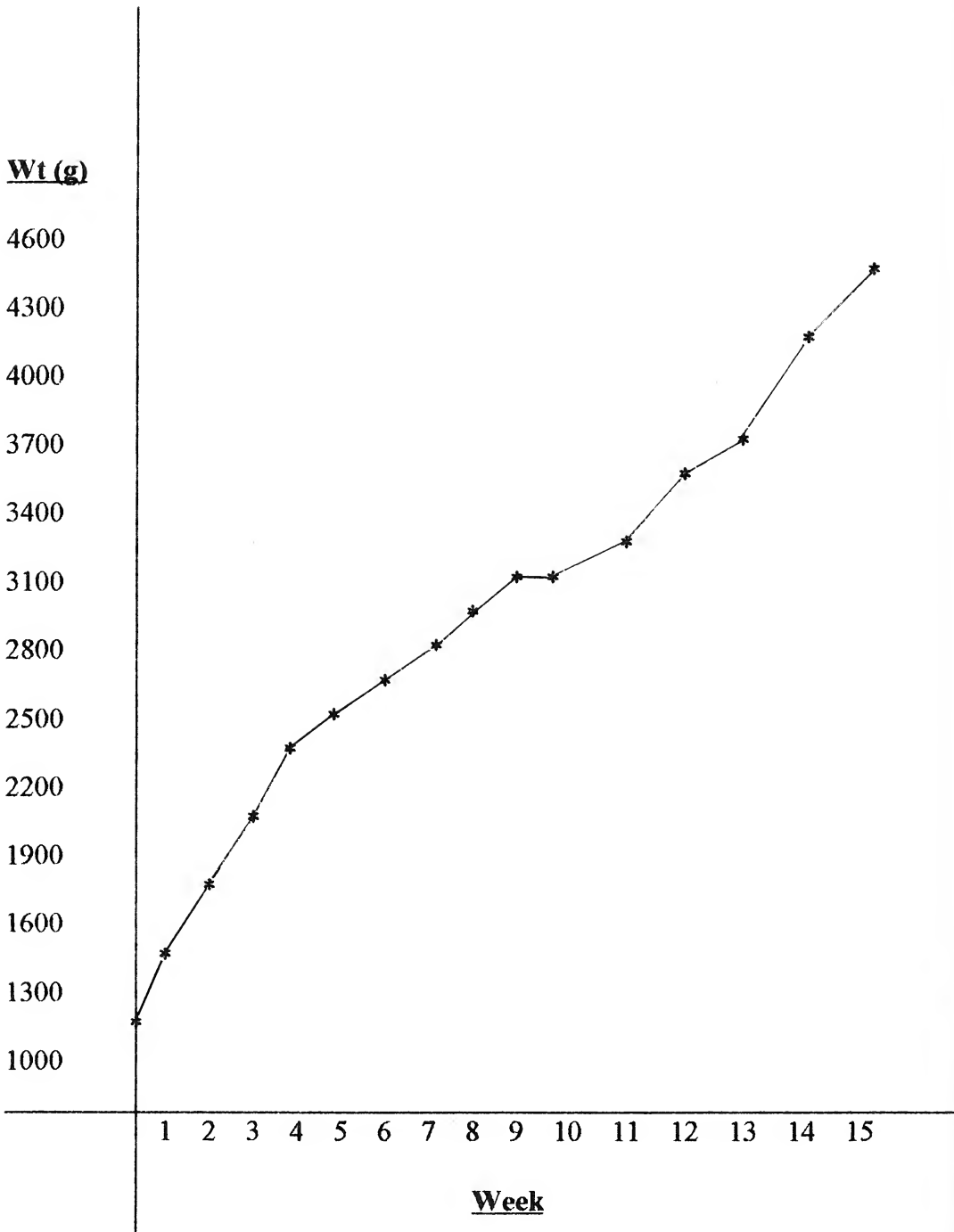

**Figure 1. Weight gain of a hand-reared red kangaroo that was initially emaciated.**

## Table 1: Significant Events

31 July	joey pulled, wt. 1.1kg, IV line inserted, Cephalexin® started
1 Aug.	feeding tube placed in nostril, formula 3 parts water/1 part Esbilac®, 12 feedings/day
5 Aug.	last dose Cephalexin®, 11 feedings/day
6 Aug.	IV line removed, started losing hair
7 Aug.	lactaid added to formula to treat diarrhea, Lotrimin® applied to body for hair loss, joey pulled feeding tube out
8 Aug.	feeding tube reinserted
13 Aug.	started Amoxicillin® due to congestion
17 Aug.	joey pulled feeding tube out, feeding: formula from bottle (2 parts water/ 1 part Esbilac®), baby food and food* left in pouch, 10 feedings/day
22 Aug.	last dose of Amoxicillin®
25 Aug.	lactaid remove from formula
27 Aug.	last application of powder
31 Aug.	7 feedings/day
5 Sept.	out of pouch on his own for first time
8 Sept.	6 feedings/day
13 Sept.	5 feedings/day
27 Sept.	4 feedings/day
19 Oct.	3 feedings/day
5 Nov.	2 feedings/day
14 Nov.	removed "pouch" and playpen
17 Nov.	last feeding

\*wheat bread, herbivore pellets, strawberries, banana, yam, apple, wheat grass

## Book Review (Continued from page 312)

toxicity. Chapter 3 - "Milk composition", includes a discussion on the importance of colostrum (although it's not stressed how imperative the need is in hoofstock), and when to feed it. There is also a discussion on milk components, general formulas, creating a new formula and choosing additives. Additional Chapters are: 4 - "Preparing the Formula", 5 - "Feeding Equipment, and Procedures", 6 - "Weaning", 7 - "Handling & Routine Care", 8 - "Veterinary Care", 9 - "Release" and 10 - "How to Use Part 2".

Part 2 has species listed in taxonomic order by family, then in alphabetical order by species. Here 185 genus and/or species are addressed. Brief notes about care and feeding as well as diets for each are offered.

A very useful appendix at the end covers such things as: constructing a brooder/incubator; formula analysis and conversions (a wonderful addition!); caloric requirements and body temperatures.

A true layperson would probably need some further clarification/assistance if using this publication as a sole reference source. Also, the author does not address possible state licensing requirements and/or permits that might be required to do rehabilitation work or to own and raise exotics. But, using this book in conjunction with assistance from a veterinarian or zoo keeper would make this a useful guide. In a zoo setting, this reference would work well as a "quick care" infant guide and a great training tool for new nursery workers and volunteers.

# AAZK Announces New Professional & Contributing

Lisa Ruggiero, Roger Williams Park Zoo (RI) Jennifer Mattive, T & D's Mountain Road (PA); Andrew C. Keech, National Zoological Park (DC); Willie M. Campbell, North Carolina Zoo (NC); Joe Purcell, Busch Gardens (FL); Seana M. Lammers, Knoxville Zoo (TN); Brad Young, Hattiesburg Zoo (MS); Michele Naddy, Lincoln Park Zoo (IL); Brenda Herron, Wildlife Prairie Park (IL), Calvin T. Harpe, Kansas City Zoo (MO).

## Renewing Contributing Members

Discovery Island,  
Walt Disney World,  
Lake Buena Vista, FL

Debra Burch, Miami, FL

Charles H. Hoessle, Director,  
St. Louis Zoological Park,  
St. Louis, MO.

# THE GOURMET RODENT™



## RATS AND MICE

Bill & Marcia Brant  
6115 SW 137th Avenue  
Archer, FL 32618  
(904) 495-9024  
Fax (904) 495-9781

© All Rights Reserved

## Need to Reach AAZK?

1-800-242-4519 (U.S.)

1-800-468-1966 (Canada)

FAX: (913) 273-1980

or write

AAZK, Inc.  
635 S.w. Gage Blvd.  
Topeka, KS 66606-2066



Institutions wishing to advertise employment opportunities are asked to send pertinent data by the 15th of each month to: Opportunity Knocks/AKF, 635 S.W. Gage Blvd., Topeka, KS 66606-2066. Please include closing dates for positions available. There is no charge for this service and phone-in listings of positions which become available close to deadline are accepted. Our phone is 1-800-242-4519 (U.S.); 1-800-468-1966 (Canada). Our FAX is (913) 273-1980.

**ZOOKEEPER - BIRDS**...responsible for maintenance of exhibits/facilities, diet preparation, record keeping and related duties for extensive bird collection. Requires high school diploma and one year working avian experience in zoo or related facility. Degree in Biology or related field preferred. Starting salary \$19,302.00 per year with benefits. Submit resumé **by 31 August 1995** to: Nancy Foley, Director of Human Resources, The Toledo Zoological Society, P.O. Box 4010, Toledo, OH 43609-0010.

**KEEPER**...the Tallahassee Museum of History and Natural Science is seeking a keeper to work with a collection of native Florida wildlife including birds of prey, reptiles, felids, ursids, canids, etc. Responsibilities include feeding, husbandry, exhibit maintenance (some light construction). Enrichment skills desired. One year experience in captive wild animal husbandry required. College level courses in biology and related courses preferred. Send resumé to: Tallahassee Museum of History and Natural Science, 3945 Museum Dr., Tallahassee, FL 32310.

**EDUCATION CURATOR**...Reid Park Zoo, Tucson, AZ. Requires experience in a supervisory capacity in conservation or life science education programming; Bachelor's degree in natural sciences, education or related field; two years experience including volunteer coordination at a zoo, aquarium, or museum. Duties include planning, implementing, and evaluating education programs; education services; graphics; and public relations involvement. Salary \$29,988.00 to \$40,188.00 plus excellent benefits. Apply **by 30 August 1995**. Contact: City of Tucson Human Resources, 110 E. Pennington, Tucson, AZ 85726-7210, or call (520) 791-4241 for application materials.

**EDUCATION CURATOR**...requires energetic professional who is excited about educational opportunities offered by zoos, experience training and working with volunteers, teaching experience, the ability to work well with a diverse staff and public, and enthusiasm for zoo education. Responsible for all aspects of management, expansion and future development of an existing education program. Animal training experience a plus. Salary \$19,000.00 - \$21,000.00 and full benefits based on education, abilities and experience. Available immediately. Send resumé and cover letter **by 20 August** to: Dr. Gail E. Foreman, Executive Director, Utica Zoo, Steele Hill Road, Utica, NY 1501.

**ZOOKEEPER II**...Cypress Swamp - responsible for the care of alligators, cougars, waterfowl, and small amphibian exhibits. Work is performed under the general supervision of the head keeper and curatorial staff. This position involves a lead role in the routine care and maintenance of an exhibit area along with training, coaching and evaluation of zookeeper I's, and interaction with zoo visitors. Prefer a Bachelor of Science degree in zoology or related field and at least four years of experience with birds, reptiles, and/or mammals in an accredited zoo, or comparable combination of education and experience. Strong interpersonal skills and/or prior supervisory experience desirable. Send resumé to: Cami Bunting, Reference Position #10256, North Carolina Zoological Park, 4401 Zoo Parkway, Asheboro, NC 27203 **by 30 August 1995**.

**KEEPER/CHILDREN'S ZOO (SAN DIEGO ZOO)**...requires one to two years experience working with exotic animals; college-level courses in biology, zoology and animal-science-related field desired. Education may be substituted for part of experience. Responsible for care of birds and mammals; possibly noenates. Related experience in direct animal handling and animal presentations required. Will work in a team environment; excellent interpersonal skills desired. Competitive salary with benefits. Relocation cost not paid by employer. Send resumé **by 25 August 1995** to: San Diego Zoo/Human Resources Dept., Attn: Children's Zoo, P.O. Box 551, San Diego, CA 92112.

**BAT KEEPER POSITION**...The Lube Foundation is currently accepting applications for one full-time animal keeper in their bat department. Duties include, but are not limited to: feeding, cleaning, medicating, manipulating, and daily record upkeep of one of the largest Flying Fox collections in North America. Must have had at least one year exotic animal experience. Bat handling experience preferred. Must have TB test and updated tetanus inoculation prior to hiring. Pay scale is \$6.00-\$8.00 per hour plus some benefits. Please send updated resumé if you have applied for positions previously. Please direct all inquiries and resúmes with references to: Keith Atkinson, Curator, Bat Department, The Lube Foundation, Inc., 1309 Northwest 192nd Ave., Gainesville, FL 32609. No phone calls please. EOE, drug-free workplace. Applications accepted **until 31 August 1995**.

## Information Please

The Panaewa Rainforest Zoo will be adding cargo netting for primate enrichment. Primates involved are black and white colobus, spider, and squirrel mokeys, as well as lemurs. We would like to hear from any zoo now using nets. We need information on rope diameter and mesh size, also any problems encountered with the netting. Send information to: Patti Carney, c/o P.O. Box 1099, Keaau, HI 96749.

---

I would like to correspond with other keepers about all facets of amphibian husbandry and display. Information on successful or failed attempts at breeding frogs without hormones, amphibians used in education programs, and techniques for displaying secretive and burrowing species would be especially appreciated. Contact: Rebecca Choquette, c/o Reptile Section, Honolulu Zoo, 151 Kapahulu Ave., Honolulu, HI 96815.

---

I am compiling data on both mega- and microchipterans for future editions of *Bats in Captivity*, now being published by Wild Ones, Springville, CA; and a forthcoming publication, *Handbook of Exotic Animals*, Manson Publishing Ltd., London. The following information is needed: captive longevity data; methods of wing repair and results (radiographs would be a plus); interesting pathological reports (e.g., myopathies, neoplasms, other); blood and urine values, especially from megabats, and electrolyte content of plasma or serum samples. Please send information to: Susan M. Barnard, Department of Herpetology, Zoo Atlanta, 800 Cherokee Ave. SE, Atlanta, GA 30315-1440; FAX (404) 627-7514.



**AAZK Membership Application** check here if renewal [    ]

Name \_\_\_\_\_  
 Address \_\_\_\_\_  
 City \_\_\_\_\_ State/Province \_\_\_\_\_ Zip \_\_\_\_\_

- U.S. Members**
- \$30.00 Professional/U.S.  
*Full-time Keepers*
- \$25.00 Affiliate/U.S.  
*Other staff & volunteers*
- \$25.00 Associate/U.S.  
*Those not connected with  
 an animal facility*
- \$50.00 or up - Individuals  
**Contributing/U.S.**
- \$50.00 or up  
**Institutional/U.S.**  
*Organizations / Institutions  
 (requires Board approval)*

- Canadian Members**
- \$35.00 Professional/Canada  
*Full-time Keepers*
- \$30.00 Affiliate/Canada  
*Other staff & volunteers*
- \$30.00 Associate/Canada  
*Those not connected with  
 an animal facility*
- \$55.00 or up - Individuals  
**Contributing/Canada**
- \$55.00 or up  
**Institutional/Canada**  
*Organizations / Institutions  
 (requires Board approval)*

**International Members**

**\$40.00 International**  
*All members outside U.S. &  
 Canada regardless of category*

**Library Only**

**\$20.00 Library**  
*Available only to  
 established libraries*

Zoo Affiliation (if any) \_\_\_\_\_  
 Zoo Address \_\_\_\_\_  
 Title \_\_\_\_\_  
 Work Area \_\_\_\_\_

My check is enclosed (AAZK, Inc.)  Please charge my credit card

MASTERCARD \_\_\_\_\_ VISA \_\_\_\_\_ Card # \_\_\_\_\_ - \_\_\_\_\_ - \_\_\_\_\_ - \_\_\_\_\_

Name on card \_\_\_\_\_ Expiration Date \_\_\_\_\_

Signature \_\_\_\_\_

Mail this application to: AAZK Administrative Offices, Topeka Zoo, 635 S.W. Gage Blvd., Topeka, KS 66606-2066 U.S.A. Make checks/money orders payable to AAZK, Inc. Must be in U.S. FUNDS ONLY.

Membership includes a subscription to *Animal Keepers' Forum*. The membership card is good for free admission to many zoos and aquariums in the U.S. and Canada.

**OT 200 Keepers, Inc.  
635 S.W. Gage Blvd.  
Topeka, KS 66606-2066  
U.S.A.**

Address Correction Requested

U.S. POSTAGE PAID  
Permit # 646  
Topeka, KS 66603

National Zoological Park 3/96  
NMP Library  
DC 20008  
Washington,



*“Dedicated to  
Professional Animal Care”*

L  
16  
578  
4

# ANIMAL KEEPERS' FORUM

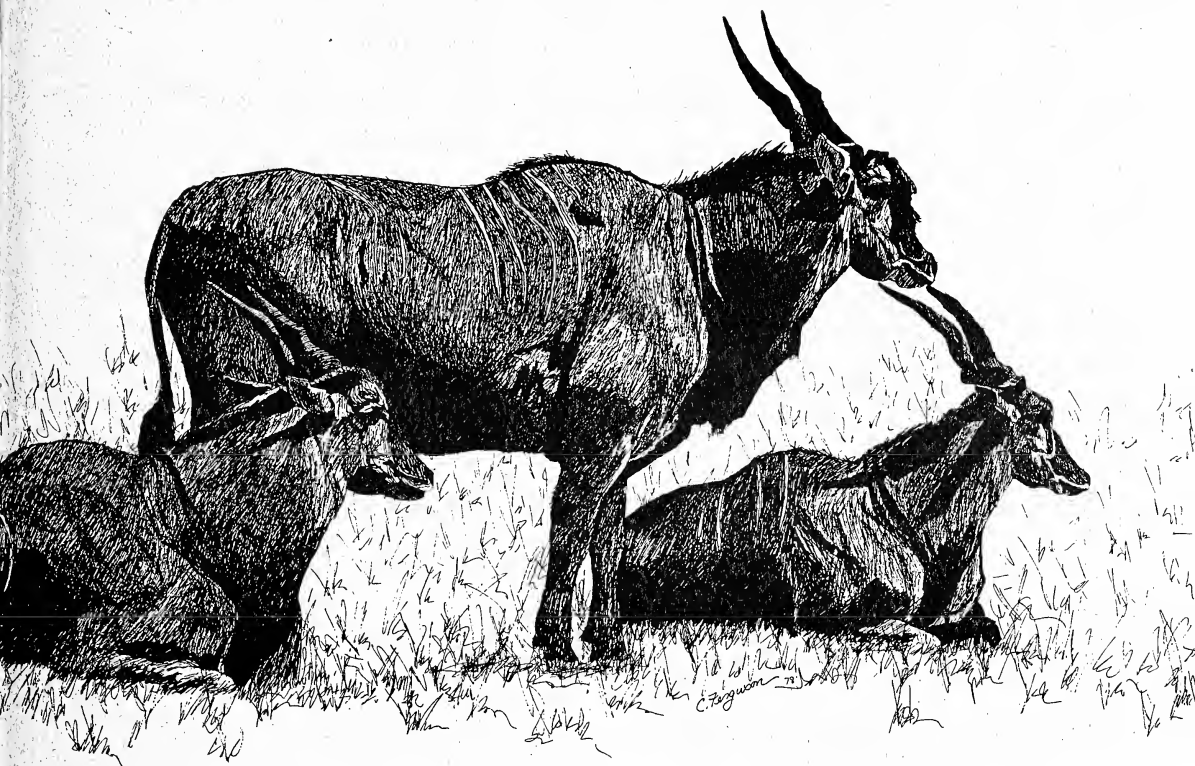

**The Journal of the American  
Association of Zoo Keepers, Inc.**

**SEPTEMBER 1995**

**ANIMAL KEEPERS' FORUM**, 635 S.W. Gage Blvd., Topeka, KS 66606-2066

Phone: 1-800-242-4519 (U.S.) 1-800-468-1966 (Canada) FAX 913-273-1980

**Managing Editor:** Susan Chan

**Associate Editors/Enrichment Options Coordinators:**

Kayla Grams, Arizona-Sonora Desert Museum & Gretchen Ziegler, Sequoia Park Zoo

**Book Review Coordinators:** Melba T. Brown, National Zoo & Andrea Bernee, Chaffee Zoological Garden

**Legislative Outlook Column Coordinator:** Georgann B. Johnston, Sacramento, CA

**September 1995**

**Vol. 22, No. 9**

Animal Keepers' Forum (ISSN 0164-9531) is a monthly journal of the American Association of Zoo Keepers, Inc. Ten dollars of each membership fee goes toward the annual publication costs of Animal Keepers' Forum. Third Class postage paid at Topeka, KS. Postmaster - Please send address changes to: **American Association of Zoo Keepers, Inc., Administrative Offices, 635 S.W. Gage Blvd., Topeka, KS 66606-2066 - attn: Barbara Manspeaker, Administrative Secretary**

**AAZK Executive Director:** Ed Hansen, AAZK, Inc., Topeka KS

### **BOARD OF DIRECTORS**

Janet McCoy, Metro Washington Park Zoo, Portland, OR 97221-2799

Rachél Watkins Rogers, San Diego Zoo, San Diego, CA 92112

Mark de Denus, Assiniboine Park Zoo, Winnipeg, Manitoba, Canada

Alan Baker, Burnet Park Zoo, Syracuse, NY 13204-2504

Ric Urban, Houston Zoological Garden, Houston, TX 77030

Marilyn Cole, Metro Toronto Zoo, Toronto, Ontario, Canada

Diane Callaway, Omaha's Henry Doorly Zoo, Omaha, NE 68107-2200

President

Vice President

### **COMMITTEES**

#### **Nominations & Elections**

Chair - Sheri Leavitt, Houston Zoo

#### **Conservation, Preservation & Restoration**

Chair - Brett Sellers, Metro Washington Park Zoo

#### **Annual Conferences**

Coordinator - Ed Hansen, AAZK, Inc.

#### **Awards**

Chair - Anna Michel, Metro Washington Park Zoo

#### **Exhibit Design Resource Notebook**

Michael Demlong, The Phoenix Zoo

**AAZK Inspection Standards Manual** — Rachél Watkins Rogers, San Diego Zoo

#### **By-laws**

Rachél Watkins Rogers, San Diego Zoo

#### **Ethics**

Mark de Denus, Assiniboine Park Zoo

#### **Research/Grants**

Vacancy

#### **Publications Funding**

David Luce, Chaffee Zoological of Fresno

#### **AAZK Chapter Logo Products**

Jay Christie, Cohanzick Zoo, Bridgeton, NJ

### **MEMBERSHIP SERVICES**

#### **L.I.N.K. Coordinator**

Mark de Denus, Assiniboine Park Zoo

#### **Zoo University List**

Mike Illig, Metro Washington Park Zoo

#### **Keeper Accommodations List**

Todd Cleveland, Denver Zoo

#### **Enrichment Committee**

Dianna Frisch, Columbus Zoo

**International Outreach** - Jeanette Beranger, Roger Williams Park Zoo (Chair/Coordinator Technical Assistance); Lesa Scheifele, Norwich, CT (Foreign Members/Sister Organizations); Lois Johannes, L. A. Zoo (Foreign Member Sponsorship Program); Kathy Kelly, National Zoo - Project M.A.R.C. (Making A Realistic Contribution)

#### **Animal Data Transfer Form**

Bernie Feldman, Burnet Park Zoo

#### **Staff Exchange**

Dale Frerking, Kansas City Zoo

#### **AAZK Historian**

Vacancy

#### **AAZK Training Materials** - Laura Treschel,

Continuing Education Coordinator, Minnesota Zoo

### **PRESIDENTIAL ADVISORS**

#### **AZA Liaison**

Ed Hansen, IPP, AAZK, Inc.

#### **Bowling for Rhinos**

Patty Pearthree, Indianapolis Zoo

#### **Elephant Managers Association**

Dinah Wilson, Marine World Africa USA

#### **CAZPA Liaison**

Oliver Claffey, Metro Toronto Zoo

### **AAZK PUBLICATIONS - CONTINUING DATA COLLECTION**

#### **Zoo Infant Development Project**

Teri Maas/Maggie Liguori, Philadelphia Zoo (Birds/Nonpasserines); Kim Livingstone, L.A. Zoo (Passerines)

Jeanne Stevens, Newark Museum Mini-Zoo (Reptiles); Linelle Lone, Denver Zoo (Amphibians)

**Diet Notebook, Mammals, Vol. II** - Susan Bunn Spencer, Grand Rapids, MI



# ***Table of Contents***

About the Cover/Information for Contributors.....	346
Scoops and Scuttlebutt.....	347
Coming Events.....	348
Births & Hatchings.....	349
Center for Ecosystem Survival Reaches \$1 Million Milestone.....	350
Diet Notebook Survey.....	352
Two for One Special Delivery!.....	353- 354
Chapter News.....	354
AAZK Announces New Members.....	355
Legislative Update (ESA Update).....	356 - 359
Hand-raising Spider Monkeys.....	360 362
Ungulate Neonatal Feeding Techniques.....	363 - 365
See You in Denver!.....	366
Aspergillosis in a Hand-reared Flamingo Chick.....	367- 372
Down Under (Kangaroos Blinded by Mysterious Virus).....	373 - 374
Wild News (National Wildlife Refuge Week).....	374
Enrichment Options.....	375 - 376
Book Review (Cheetahs of the Serengeti Plains).....	377
Hand-rearing <i>Orycteropus afer</i> at the Philadelphia Zoo.....	378 - 384
L.I.N.K. List of Regional Coordinators.....	385
Opportunity Knocks.....	386 - 388
Information Please.....	388

## About the Cover....

*This month's cover features the Eland (*Taurotragus oryx*), the largest member of the antelope family which may reach a length of 6 1/2-10 feet, a height of 5-6 feet and a weight up to 2,000 pounds. Native to the vast, grassy plains of African continent, eland family groups will consist of one male, several cows and calves. Young are born singly after a gestation period of 250 days and may be born at any time of the year, although most are born during the rainy season. Both sexes sport oblique, spiral horns which are used for defense. The animals are browsers feeding on grasses and leaves and are able to go a long time without water. The eland's only real enemies in the wild are the lion and man. We thank Cindy Ferguson, a freelance artist from Carmel, NJ for this month's cover art.*

## Information for Contributors

*Animal Keepers' Forum* publishes original papers and news items of interest to the animal keeping profession. Non-members are welcome to submit articles for consideration. Articles should be typed or hand-printed and double-spaced. Articles may be submitted on disk by arrangement with the Editor. All illustrations, graphs, charts and tables should be clearly marked, in final form and should fit in a page size **no greater than 5.5" x 8.5"** (14cm x 22cm). Literature used should be cited in the text (Brown, 1986) and alphabetically in the final bibliography. Avoid footnotes. Include scientific name (as per ISIS) the first time an animal name is used. Thereafter use common name. Use metric system for weights and measurements (standard equivalents may be noted in parenthesis). Use the continental dating system (day-month-year). Times should be listed as per the 24-hour clock (0800, 1630 hrs. etc.). Glossy finish black and white photos **only are accepted**. Color slides should be converted to black and white prints (minimum size 3" x 5" [8cm x 14cm] ) before submission. Clearly marked captions should accompany photos. Please list photo credit on back of photo.

Articles sent to *Animal Keepers' Forum* will be reviewed by the editorial staff for publication. Articles of a research or technical nature will be submitted to one or more of the zoo professionals who serve as referees for *AKF*. No commitment is made to the author, but an effort will be made to publish articles as soon as possible. Lengthy articles may be separated into monthly installments at the discretion of the editor. The editor reserves the right to edit material without consultation unless approval is requested in writing by the author. Materials submitted will not be returned unless accompanied by a stamped, self-addressed, appropriately-sized envelope. Telephone and FAX contributions of late-breaking news or last-minute insertions are accepted as space allows. However, long articles must be sent by U.S. mail. Phone 1-800-242-4519 (US); 1-800-468-1966 (Canada); FAX (913) 273-1980.

Deadline for each regular issue is the 15th of the preceding month. Dedicated issues may have separate deadline dates and will be noted by the editor.

Articles printed do not necessarily reflect the opinions of the *AKF* staff or the American Association of Zoo Keepers, Inc. Publication does not indicate endorsement by the Association.

Items in this publication may be reprinted providing credit to this publication is given and a copy of the reprinted material is forwarded to the editor. Reprints of material appearing in this journal may be ordered from the editor. Back issues are available for \$3.00 each.

# *Scoops & Scuttlebutt*



## **New Officers Elected for AAZK Board of Directors**

Congratulations are in order for Ric Urban, Houston Zoological Gardens, and Diane Callaway, Omaha's Henry Doorly Zoo. Ric was recently elected President-elect for AAZK, Inc. and Diane was elected Vice-President-elect. Both Ric and Diane will be formally installed in their offices at the close of the Annual Membership Meeting in Denver. Ric and Diane, along with newly elected Board members Marilyn Cole, Metro Toronto Zoo; Lucy Segerson, North Carolina Zoo; and David Luce, Chaffee Zoological Gardens will assume their positions at the close of the Conference. Janet McCoy and Alan Baker, Burnet Park Zoo, will continue on the Board for two more years. Rachél Watkins Rogers, San Diego Zoo; and Mark de Denus, Assiniboine Park Zoo, will be retiring from the Board.

## **Diet Notebook Project Seeks Reptile Coordinator**

Diet Notebook Coordinator Susan Bunn Spencer reports that the Project is back on track and working to prepare for publication of additional volumes including Mammals, Vol. II, Birds, Reptiles & Amphibians, and Fish & Invertebrates. Coordinators are in place for all sections except Reptiles.

**WANTED:** Person willing to work long hours as the Reptile Coordinator for the Diet Notebook Project. New diets need to be solicited, all diets need to be entered onto a database, and proofreading for a finished product is needed. There will be a deadline schedule to meet. A job description can be furnished upon request.

If interested, send a resumé and letters of reference to: Susan Bunn Spencer, 8336 Courtland Drive NE, Rockford, MI 49341 OR CALL (616) 866-7455.

## **Book Reviewers Sought for AKF**

Book Reviewers wanted...must have a willingness to meet deadlines...If you have time and are able to write a review I would like to hear from you. I am collecting names now and areas of interest for book reviews. The only requirement is that the book be read and I receive a review within eight weeks --you get to keep the book. Please contact Andrea Bernee, Book Review Coordinator, c/o Chaffee Zoological Gardens, 894 W. Belmont, Fresno, CA 93728. Some books on hand for review now are: The New Ecological Order by Luc Ferry; In the Country of Gazelles by Fritz R. Walter; SNAKES: The Keeper and the Kept and Snakes and Snake Hunting both by Carl Kauffeld. Individuals with book reviews still outstanding are not eligible to receive additional books until their current reviews are turned in to AKF.

***Editor's Note:*** Because of space constraints, several of the hand-rearing articles originally planned for this issue are having to be held until the October issue. We apologize to the authors for this delay, although we were thrilled with the excellent response we received on this topic. Thanks to all who contributed hand-rearing material.

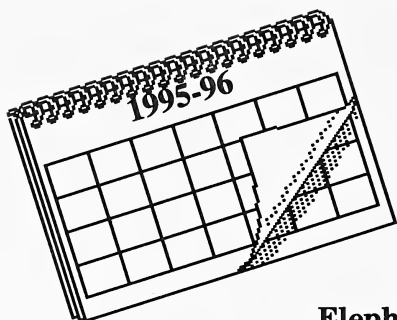

# Coming Events

## The 16th Annual Elephant Managers Workshop

October 10-14, 1995

Tacoma, WA

Headquartered at the Tacoma Inn. Presented by the Pt. Defiance Zoo & Aquarium and the Elephant Managers Association. For further information contact: Bruce Upchurch or Sally LaTorres, Point Defiance Zoo & Aquarium, 5400 N. Pearl St., Tacoma, WA 98407-3218, (206) 591-5337, ext. 154.

## Association of ZooVeterinaryTechnicians 15th Annual Conference

Oct. 30 - Nov. 2, 1995

Baltimore, MD

To be held at the National Aquarium. Conference will include sessions on reptile, avian, primate, hoofstock and aquatic medicine, immobilization, hematology, clinical and gross pathology, hospital techniques, and case reports. In addition, there will be a wet-lab. For more information contact: Jenni Jenkins, LVT, National Aquarium in Baltimore, Pier 1, 501 E. Pratt St., Baltimore, MD 21202; tel: (410) 656-4256; Fax (410) 576-1080.

## The Annual International Small Felid Workshop

December 4-6, 1995

Las Vegas, NV

Co-sponsored by the San Diego Zoo and S.O.S. Care. For further information, contact Pat Quillen, 15453 Woods Valley Road, Valley Center, CA 92082. PHONE: (619) 749-3946 FAX: (619) 749-1324.

## 1996 AZA REGIONAL CONFERENCES

Central Regional - Feb. 28-March 2, 1996 - to be held in New Orleans, LA. For further information contact Craig Dinsmore, Audubon Zoo, P.O. Box 4327, New Orleans, LA 70178 (504) 861-6112.

Eastern Regional - April 10-13, 1996 - to be held in Greenville, SC. For further information contact Bob Wilson, Greenville Zoo, 150 Cleveland Park Dr., Greenville, SC 29601 (803) 467-4300.

Western Regional - May 15-18, 1996 - to be held in Denver, CO. For further information contact Angela Baier, Denver Zoo, 2300 Steele St., Denver, CO 80205 (303) 331-5805.



# Births & Hatchings



**Denver Zoo (Denver, CO)**...announces the following B&H from April through June 1995:

**Mammals** - 0.1.1 goral (*Nemorhaedus goral*) [CITES I]; 0.0.1 pale-headed saki (*Pithecia pithecia*) (CITES II); 1.0 Blesbok (*Damaliscus dorcas phillipsi*); 0.0.2 pygmy marmoset (*Callithrix pygmaea*) {CITES II/0.0.1 DNS; 2.3 Arctic wolf (*Canis lupus hudsonicus*) [CITES II/Second litter for this female].

**Birds** - 0.0.3 Bartlett's bleeding heart dove (*Gallicolumba criniger*) [CITES II/0.0.3 DNS]; 0.0.1 Galah (*Eolophus roseicapillus*) {CITES II}; 0.0.1 yellow-billed cardinal (*Paroaria capitata*) [CITES II/0.0.1 DNS]; 0.0.1 hooded vulture (*Necrosyrtes monachus*) [CITES II/0.0.1 DNS]; 0.0.2 giant kingfisher (*Dacelo novaeguineae*) 0.0.6 snowy owl (*Nyctea scandiaca*) [CITES II].

**Reptiles** - 0.0.1 Madagascar day gecko (*Phelsuma dubia*) {CITES II}. submitted by Vicki Sawyer, Chapter Liaison, Rocky Mountain AAZK Chapter, Denver Zoo, Denver, CO.

**Houston Zoological Gardens**...announces the following significant B&H for January through June 1995:

**Mammals** - 0.1 Asian elephant (*Elephas maximus*) [1st calf born into captive management system; 2.0 red-capped mangabey (*Cercocebus torquatus*); and 0.1 Francois langur (*Presbytis francoisi francoisi*).

**Birds** - 0.0.1 Mariana crow (*Corvus kubaryi*); 0.0.20 Attwaters prairie chicken (*Tympanuchus cupido attwateri*); 0.0.1 hooded parrot (*Psephotus chrysopterygius dissimil*); 1.1 great blue turacos (*Corythaedola christata*) [recent acquisition/only exhibited at two institutions]. submitted by Jennifer Lippold, Chapter Liaison, Houston AAZK Chapter, Houston, TX.

**Lubee Foundation, Inc. (Gainesville, FL)**...announces the following B&H from January through August 1995:

**Mammals** - 5.0 dog-faced fruit bat (*Cynopterus brachyotis*) [only U.S. institution]; 0.2 golden-mantled flying fox (*Pteropus pumilus*) [only U.S. institution]; 1.2 island flying fox (*P. hypomelanus*); 1.3 Rodrigues flying fox (*P. rodricensis*) [SSP]; 2.6 giant flying fox (*P. vampyrus*) [CITES II/1st captive born twins]. submitted by Betsy Stevens and Dana LeBlanc, The Lubee Foundation, Gainesville, FL.



# Center for Ecosystem Survival Reaches \$1,000,000 Milestone

The Center for Ecosystem Survival recently surpassed \$1,000,000 raised for *in-situ* conservation of threatened and endangered ecosystems throughout Latin America. Presently there are 66 zoos, aquaria, and AAZK Chapters that are consortium participants in the Ecosystem Survival Plan's *in-situ* conservation programs. These institutions along with their dedicated staff have taken a leadership role in encouraging their members and visiting public to make a direct contribution to saving wildlife in nature.

Part of the evolving role of zoos and aquaria is the preservation of biological diversity found *in-situ*. The Center for Ecosystem Survival has created innovative tools to spur direct public action such as the Conservation Parking Meter® and Adopt an Acre® programs. Presently there are 160 Conservation Meters in place throughout the United States and Canada. The Adopt An Acre program has proven a valuable action resource for increasing awareness and active participation of school children in Europe, Canada, Australia, and 45 States in the U.S.

To date, through the combined efforts of all the keepers, zoos, aquaria, school children, and The Nature Conservancy, the Center for Ecosystem Survival has supported the purchase and protection of more than 34,000 acres of endangered and threatened habitat in the countries of Costa Rica, Peru, Bolivia, Guatemala, Belize, and Panama. Together these areas comprise more than 11 million acres of critically important biological diversity.

The Center for Ecosystem Survival, based on the strength of the partnerships developed since its inception in 1988, has unveiled a new Marine Conservation Initiative to engage the public, aquaria, and zoos in supporting critical aquatic habitat protection. CES has developed a Marine Conservation Meter® to raise funds for threatened marine systems worldwide.

Future conservation sites for marine protection will include Palau, Micronesia; Komodo Island National Park, Indonesia; and Parque del Este in the Dominican Republic. Funding will support surveys of marine resources, establish marine park boundaries, install mooring buoys, build ranger stations, strengthen enforcement activities, and assess marine recreation tourism, fisheries, and mariculture industries.

For more information about the Center for Ecosystem Survival's Marine Conservation Initiative and Ecosystem Survival Plan, contact Norman Gershenz, Center for Ecosystem Survival, Department of Biology, San Francisco State University, 1600 Holloway Ave., San Francisco, CA 94132 (415) 338-3393/FAX (415) 338-2295.

The Center for Ecosystem Survival would like to congratulate and acknowledge all of the dedicated keepers across the country and around the world for their efforts in raising \$1 million for preserving wilderness for the future generations!

*submitted by Norman Gershenz, Director, Center for Ecosystem Survival*



## Quality exotic animal diets

# SPECTRUM

**Nutritionally balanced  
Fixed formulation • Economical**

When you need a complete line of high-quality dry and frozen animal diets for your feeding program, call Animal Spectrum.

**NEBRASKA BRAND**



*Frozen feline diets  
Frozen bird of prey diets  
Frozen canine diet  
Chunk and chopped horsemeat,  
hearts, livers, rib, shank,  
knuckle bones, and tailbones*



*Banana flavored psittacine/primate, 20% protein, dry  
Banana flavored primate, Pro-Plus 25% protein dry  
Leaf Eater primate dry                      Omnivore dry  
Llama Vitamins & Minerals dry        Polar Bear dry  
Marmoset/Tamarin dry                      Ratite dry  
Hoofstock supplement, with Selenium dry*

## BROOD-RITE HEATERS

*Bulbless heaters—nothing to break  
Safe around all animals and  
bedding material.  
Even heat distribution in 240, 500,  
or 750 wattages.*

**One call does it all**

TOLL FREE **1-800-228-4005**

**FAX 308-534-7015**

*Animal Spectrum, Inc.  
P.O. Box 721  
North Platte, NE 69101-0721*

# Diet Notebook Survey

The Diet Notebook Committee is currently trying to complete the remaining volumes of the Diet Notebook series. The new volumes will include: Mammals, Volume II; Birds' Reptiles & Amphibians; and Fish & Invertebrates. With the survey below we are interested in finding out who is using the first volume and are soliciting any suggestions for improvements for the new volumes. Several changes are already being made for the upcoming volumes.

If your zoo has not previously submitted diets or would like to submit updated diets, please contact me for the proper forms.

Send survey and/or requests for diet forms to:

**Susan Bunn Spencer, M.S.**  
**8336 Courtland Drive NE**  
**Rockford, MI 49341**

1) Please list your title or position at your facility (keeper, curator, etc.)

2) Have you ever used the *AAZK Diet Notebook, Mammals, Vol. I*?

**YES**                      **NO**

3) Does your zoo have a copy?    **YES**                      **NO**

4) If yes, is the zoo's copy readily available?    **YES**                      **NO**

5) Do you have a personal copy of the *AAZK Diet Notebook, Mammals, Vol. I*?

**YES**                      **NO**

6) Who formulates the animals' diets at your zoo?

7) If any, what changes would you like to see in the upcoming volumes?  
(If you need more room, please attach a separate sheet of paper)

# Two for One Special Delivery! The First Twin Birth of the Malayan Flying Fox (*Pteropus vampyrus*) in Captivity

By Dana LeBlanc, Betsy Stevens and  
Rick Gutman  
The Lube Foundation, Inc.,  
Gainesville, FL

The keepers at the Lube Foundation, Inc. had been waiting weeks for a Malayan flying fox (*Pteropus vampyrus*) named "Kali" to give birth. Malayan flying foxes are one of the largest bats in the world and can attain wing spans of five and a half feet or more. These fruit bats are only kept at a handful of zoological institutions participating in ISIS (International Species Inventory System). They are listed under CITES (Convention on International Trade in Endangered Species of Wild Fauna and Flora) as an Appendix II species, and some subspecies are locally common.

On 28 June 1995, the keepers discovered Kali in labor during their early morning rounds, and were able to catch some of the birth on videotape. The flying foxes at the Lube Foundation, Inc. give birth during early morning hours or late in the afternoon.

The gestation period for this megabat is between 160 and 200 days. As the birth was observed, the head of the new pup could be seen just outside the vulva. Kali was in the normal birthing position, in which the thumbs are utilized to bring the main body parallel with the ceiling of the enclosure. Then she grabbed the head of the pup with a foot and the pup was born. The pup immediately responded, and used its own rear legs to grab onto her mother. Then the pup started its trek to the nipple. The birth appeared normal due to the fact that most *Pteropus* species give birth to one pup which is delivered head first.

Following the birth of the first pup, a female, the pair were separated from most of the group for further observation and fecal collection. The female pup was named "Bali". Both Kali and Bali were observed throughout the day and it appeared that we had a routine birth.



## 1.1 Malayan flying fox twins

The next morning, Kali and the pup were to be returned to their normal quarters when, to the surprise of the staff, the first pup was found to have a sibling. The second pup was a male, later named "Java". Java was smaller, had less hair, and his eyes remained closed for five days. This marks the first recorded birth of twins in captivity for this species. Twins have been documented in other species of the genus *Pteropus* such as grey-headed flying fox (*P. poliocephalus*), little-red fruit bat (*P. scapulatus*), Indian fruit bat (*P. giganteus*), and Rodrigues flying fox (*P. rodricensis*).

It was unknown at first if Kali could obtain sufficient nutrition from the diet offered to the bat collection to support two pups. Therefore, Kali was offered 1/2 Tbs. of vegetable protein powder daily, to assist her in milk production. Female flying foxes may nurse their pups over a period of six months, and the mother-pup relationship in this genus is well developed.

The twins were weighed and measured every two weeks in order to obtain a good idea if both pups were developing without problems. This is a regular research practice at the Lube Foundation, Inc. and there has been no observed side effects associated with this practice. Java and Bali and their relationship with their dam will be studied in more detail in hopes of providing more clues into the mother-pup relationship in flying foxes.



## Chapter News Notes

### South Florida AAZK

New officers for 1995 are:

President.....Chris Breder

Vice Pres/Chapter Liaison.....

Patty Leon Singer

Secretary.....Von Henry

Treasurer.....Susan Kong

The South Florida AAZK Chapter has been busy with fundraisers. We began the year with a "Reptile Photo Opportunity" for zoopatrons. The Everglades Herpetological Society and SFAAZK worked together, giving zoogoers a chance to get an up close look at reptiles, while raising funds for both organizations.

Chapter. We've also been selling raffle tickets to win a behind-the-scenes tour of Metrozoo (an added attraction has been the arrival of the Komodo Dragon). In July, we held our annual "Bowling for Rhinos" event, raising over \$2,000.00 for the Ngare Sergoi Support Group.

All the hard work has paid off though; five keepers will be attending the National AAZK Conference in Denver! The following months will consist of our annual summer Bar-B-Que, and the 2nd Annual Wildlife Art & Awareness Weekend, with our final fundraiser, The 15th Annual Awards Banquet & Auction. We also said goodbye to our president, Connie Philipp. Best of luck to you at the Memphis Zoo!

—Chris Breder, President

Then came "Breakfast with the Keepers", successfully raising \$1,145.00 for our

(Continued on page 365)

## **AAZK Announces New Professional & Contributing Members**

Susan DeFrancesco, **East Coast Exotics (CT)**; Kevin A. Elb, **Six Flags Safari Park (NJ)**; Michael P. O'Neill, **Pittsburgh Zoo (PA)**; Betsy Henderson, **Fairless Hills, PA**; David S. Kessler, **National Zoo (DC)**; Janice Hudson and Lillian Felz, **Lion Country Safari (FL)**; George Wallace and Steve A. Wilbur, **Ober Gatlinburg Municipal Black Bear Habitat (TN)**; Ryan Crawford, **African Safari Wildlife (OH)**; Bruce L. Elkins, **Indianapolis Zoo (IN)**; Aimee Cochell, **Detroit Zoological Park (MI)**; Scott Schiller, **Brookfield Zoo (IL)**; Colleen Wirrick and John Grey, **Hensen Robinson Zoo (IL)**; Emily Stancil, **Kansas City Zoo (MO)**; Betty Taverner and Sandi Shoemaker, **Oklahoma City Zoo (OK)**; Deanna Brown, **Jungle Cat World, Inc. (Ontario)**; Lori Kemp, **Bowmanville Zoo (Ontario)**.

### **New Contributing Members**

Susan DeFrancesco, **East Coast Exotics, Newtown, CT**

### **Renewing Contributing Members**

Robert Leslie Whitt  
**Alexandria Zoological Park,  
Alexandria, LA**

Cate Werner, Ex-Keeper  
**Denver Zoo, Denver, CO**

Marilyn R. Lemrow, **Spring Valley, CA**

## **THE GOURMET RODENT™**

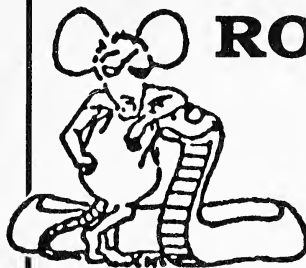

### **RATS AND MICE**

Bill & Marcia Brant  
6115 SW 137th Avenue  
Archer, FL 32618  
(904) 495-9024  
Fax (904) 495-9781

© All Rights Reserved

### **ONE OF A KIND**

Talon & Mammal Gloves  
327 E. Lake St.  
Horicon, WI 53032  
(414) 485-4369

LK-16/MK-16 Ladies or Men's  
Kevlar lining, 16" - \$31.00 pair

LS-16/MS-16 Ladies or Men's  
Sheepskin, 16" - \$35.00 pair

M6-1L/MG-1M Ladies or Men's  
Mammal w/Kevlar lining - \$48.00 pair

E61L/E61M Ladies or Men's 25",  
Kevlar-lined Eagle Gloves - \$72.00 pair

Shipping for orders under \$50 is \$5.50  
Shipping for orders over \$50 is \$8.50

**Write for Free Literature**

# Legislative Update

Compiled by Georgann Johnston  
Legislative Advisor



**DON'T READ THIS COLUMN BECAUSE IT'S TOO UPSETTING AND YOU CAN'T DO ANYTHING ABOUT THESE PROBLEMS ANYWAY.** I know that is what goes through the mind of many readers of *Animal Keepers' Forum* when they get to the page with the Legislative Update column on it. The truth is, that attitude is wrong and there is something you can do. In fact, you can make a difference and make yourself feel good about yourself and it only takes 20 cents and three minutes of your time.

Your representatives in Congress do listen to what their constituents have to say for the basic reason that they want to make enough voters happy that they can be reelected to another term. The second truth is that Congressional representatives and Senators do not read the mail sent to them by the voters. Instead, "legislative aides" keep a running tally of "for" and "against" comments received about a particular piece of legislation and your representative's vote is usually influenced by the winner in this year or nay contest.

Therefore, all you need to do to have an impact is to send a postcard (there's the 20 cents) with a one sentence handwritten comment like: "Please vote yes on H.R. 123, the Act to Reauthorize the Endangered Species Act because we need continued protection of America's dwindling resources". Sign your name, put in your address (to show you live in their district), and mail it off. Your comment is tallied as a yes vote just the same as a three-page, well-reasoned letter analyzing all the sound economic and environmental reasons for voting in favor (or against) a particular measure and you have done in three minutes what takes others an hour or more to do.

For those of you who are surfing the 'Net', many Representatives and Senators now have e-mail addresses where you can send a similar comment and save the 20 cents in the process. If you need Congressional addresses, e-mail me at [gbatty@ix.netcom.com](mailto:gbatty@ix.netcom.com) and I can provide them to you.

---

## Endangered Species Act Legislative Update

The Endangered Species Act, originally enacted in 1973, requires reauthorization by Congress on a periodic basis. The time for the periodic review has arrived and Congress has pending before it a number of bills which pose a threat to the basic environmental regulations which have helped to preserve and protect endangered species and their habitats including wetlands and forests. Some of this legislation has been mentioned in previous columns but the following is an attempt to offer a comprehensive list of the most significant pieces of proposed legislation with a brief summary of their contents and the possible effects on species of interest to the zoo keeper community.



H.R. 1158: A salvage logging rider to the 1995 Fiscal Year rescissions bill which proposes timber sales from federal land to be made without analyzing the environmental impact. The bill defines "salvage timber sales" in broad terms which would include the cutting of live and healthy trees. The major impact of the passage of this bill would be felt in the forests of the Pacific Northwest and could impact such species as the marbles murrelet and spotted owl.

H.R. 961: Proposes to eliminate all wetlands from federal protection. In effect, the bill repeals the clean Water Act which regulates the discharge of sewage, oil, toxic chemicals, animal waste and other pollutants into the nation's lakes and rivers. This bill has already passed the House by margin of 240 to 185 and will come before the Senate in the early fall of this year. Species affected by passage of this bill are extensive but include river otters, alligators, manatees, whooping cranes, and salmon, a prime food source for grizzly bears.

S. 191: The Farm, Ranch and Homestead Protection Act which proposed an 18-month halt to the listing of endangered species and the designation of critical habitat. This bill would perpetuate the temporary moratorium signed by President Clinton earlier this year, which precludes the addition of any new species until after 30 September 1995.

S. 219: The Regulatory Transition Act of 1995, which has already passed the House in a slightly different form, proposes to repeal all of the ESA critical habitat and species listings issued since November 1994. Additionally, the act expressly bars federal agencies from taking steps to protect health, safety or the environment.

S. 605: The Omnibus Property Rights Act of 1995 would eliminate the protection of habitats or species found on land used for logging, mining, or grazing, whether held by the government or by private individuals or companies.

S. 768: Commonly called the Gorton Bill (for its author Senator Slade Gorton R-WA), this proposed Act essentially repeals all of the provisions of the existing Endangered Species Act. The main thrust of the bill gives authority to the Secretary of the Interior to choose a "conservation objective" for each endangered species which could be as limited as a mere prohibition on the direct killing of individuals of the species. The bill eliminates all of the ESA's habitat protection provisions and also removes a number of already listed species from the protected roster, primarily marine mammals and seabirds including sea turtles, dolphins, sea otters, walruses and a plethora of wading birds.

As new bills are introduced and these bills move through Congress, I will try to keep you updated as to their status.

*Source: Endangered Species Update, an Online Journal, Vol. 12, No. 3, 1995; National Wildlife EnviroAction, the Environmental News Digest of the National Wildlife Federation, May and June 1995; LEXIS/NEXIS, Pending Congressional Bill Files; ESA Today Action Alerts, July25, 1995.*

---

### **Bald Eagle Reported Back from the Brink of Extinction**

The Department of the Interior issued a press release on 12 July 1995 reporting that

after a year-long review, the U. S. Fish and Wildlife Service would be acting to change the status of the bald eagle from "endangered" to the less critical category of "threatened". This proposal applies to the 48 contiguous states and results from a study showing that the current number of documented nesting pairs is nearly 4,500, up from 417 pairs counted in the early 1960's. The new threatened status will become effective 30 days from the date that the publication of the USFWS's final rule appears in the *Federal Register*.

The complete text of the four-page news release may be obtained from the DOI public information office by calling either Georgia Parham or Hugh Vickery at (202) 208-5634 or the document may be downloaded from the World Wide Web site [www.fws.gov/news.html](http://www.fws.gov/news.html)

*Source: Department of the Interior News Release, 12 July 1995*

---

### **Litigation Regarding Florida and Alaska Offshore Drilling Settled by Interior Department**

The Department of the Interior announced on 31 July 1995 that an agreement had been reached with nine petroleum companies to settle litigation regarding Outer Continental Shelf oil and gas development leases in southwest Florida and Bristol Bay, AK. The leases were granted to the nine companies prior to a Congressional moratorium on development in these and other coastal areas.

Governor Lawton Chiles of Florida stated that "Our pristine coastline is a great asset to Florida's quality of life," and noted that the settlement would "close the door" on oil and gas development offshore of the Florida Everglades now and for the foreseeable future.

Alaska's Governor Tony Knowles stated that "The prospect of discovering oil was slight and it was far outweighed by the value of Bristol Bay's fisheries. The environmental values of the Bristol Bay region are incalculable. Everyone wins with this resolution."

Seven claims arising out of leases off the coast of North Carolina are still pending and the Interior Department, along with counsel from the U. S. Department of Justice, are continuing to work for resolution of those lawsuits as well.

*Source: Department of the Interior Press Release, 31 July 1995*

---

### **Public Comment Sought on Marbled Murrelet Draft Recovery Plan**

The USFWS is seeking public comment on a draft recovery plan for the marbled murrelet in Washington, Oregon, and California. The murrelet has been listed as a threatened species in those three states since 1992.

The bird is a small diving seabird whose habitat occurs along the north Pacific coast from the Aleutian Islands south to central California. It nests in mature and old-growth forests up to 55 miles inland from the ocean where it uses large limbs of mature conifers. The population of this species has been on a continual downward spiral, attributed primarily to nesting habitat loss, oil spills, net fishing and El Nino climatic changes.

A copy of the complete draft recovery plan may be obtained by writing to the State Supervisor, USFWS, Oregon State Office, 2600 S. E. 98th Ave., Suite 100, Portland, OR 97266. A four-page summary of the plan, contained in the press release, may be downloaded from the World Wide Web site [www.fws.gov/news.html](http://www.fws.gov/news.html).

*Source: USFWS Press Release, 1 August 1995*

---

### **Proposed Congo Road Construction May Adversely Impact Habitat/Species**

A variety of flora and fauna, including bongos, leopards, gorillas, duikers and elephants, are likely to be affected by the proposed improvement of a road which traverses a 125-mile stretch of northern Congo between the towns of Makoua and Ouesso. The Congolese government is currently considering a proposal to widen and improve the existing road, a project which would include clear-cutting up to 300 square miles of forest. Such action would effectively divide the northern forests of the Congo into two separate blocks with a two-mile swath down the center.

The motivation for the construction project is to open up the northern portion of the Congo for development and increase timber exports. The Director General of the Environment for Congo stated on 19 July 1995 that there was no final proposal yet, but some believe that the Ministry of Environment might waive the need for an environmental impact assessment which would otherwise be required under 1986 legislation.

*Source: African Wildlife Update, July-August 1995*

---

### **U.S. Sanctions Against Taiwan Regarding Rhino and Tiger Parts Lifted After Only 10 Months**

President Clinton issued an announcement on 30 June 1995 lifting the limited trade sanctions imposed on Taiwan last year, stating that he felt that country had taken "substantial steps" to stop the trade in rhinoceros and tiger parts and products. The President pointed to amendments to Taiwan's Wildlife Conservation Law enacted by that country's government which purport to strengthen enforcement activities and "enable law enforcement authorities to impose high penalties for dealing in rhino and tiger parts." The ban was limited to wildlife products from Taiwan sold in the United States and valued at approximately \$25 million per year.

*Source: African Wildlife Update, July-August 1995*



# Hand-raising Spider Monkeys

by Carol L. Newby, Volunteer  
Sedgwick County Zoo, Wichita, KS

## Introduction

The Sedgwick County Zoo in Wichita, Kansas was involved in hand-raising three spider monkeys (*Ateles fusciceps robustus*), from 1989 to 1994. This was due to the necessity of delivering each of them by Cesarean section, and the mothers' refusal to accept them after birth.

## Methods

After it has been determined that the infant is to be hand-raised, a small towel or baby blanket is rolled up lengthwise so that the infant can wrap its arms and legs around it; then the infant and blanket are wrapped in another baby blanket in order to help maintain body temperature. We feel that the infant should be held as much as possible, either in our arms or in a cloth baby carrier on our body. Otherwise, an incubator is used; the temperature between 85-90° F. When the incubator is no longer necessary to maintain body temperature, a Pet Taxi® is used for transportation and night sleeping. If dry skin occurs, baby oil is applied with a cotton ball used every few days.

Newborn disposable diapers are used after the third day. They are cut in half, then a slit for the tail is made in each half. The most effective way to diaper is to have the infant face down on your lap, put the diaper on with the tabs on the front side, and then fasten it on the back. The diapers are cut accordingly as the infant grows. Desitin® is used for diaper rash if it occurs. The first stool appears at two days of age. If there is ever a problem with loose stools, we substitute formula with 1/2 Pedialyte® (or water), 1/2 formula for a day, graduate to 1/3 Pedialyte® (or water), 2/3 formula the next day, then back to total formula.

Low iron Enfamil® or Similac® is used for the formula with Special Care® being used if deemed necessary to increase caloric intake. A 1cc syringe placed in a pet nurser nipple is used until the infant has gotten the idea of sucking. We then graduate to a premature nipple unit placed on a Volu-feed® disposable nurser. When a strong sucking reflex is established, the final graduation to a standard nipple unit is made. The feeding utensils are soaked in Nolvasan® then washed thoroughly after each use for the first six weeks. As a general rule, initially the infant is fed 20% of its body weight per 24 hours, feeding every two hours. At 7-10 days of age, 1/10 cc of Poly-Vi-Sol® with Iron is added to the bottle once a day. The infant is piddled after each feeding until it no longer needs stimulation for urination or defecation. When the weight is close to 800 grams (approximately five weeks), baby rice cereal mixed with formula is spoon-fed with each feeding; one baby spoon of cereal mixed with 3 oz formula. After a week of the cereal/

formula mix, baby apple sauce/cereal mix is started. A new food item is introduced about every 7-10 days; mashed banana, baby peaches, baby sweet potatoes, etc. The amount of cereal and baby food is increased accordingly as the formula intake increases. When the infant is two months old, fresh fruit is offered to nibble on. At four months we offer fresh vegetables and monkey chow.



### **The author with infant spider monkey at Sedgwick County Zoo.**

The infant begins reaching out towards objects at about four weeks of age. We are always adding to and upgrading the toys and “jungle gyms” made available for the physical and mental stimulation of the infant as it grows. As soon as possible, we start daily visits to our spider monkey group with the infant.

It is our conclusion that there should be no more than two or three designated caregivers. This appears to give consistency and stability to the infant.

### **Introduction to a Spider Monkey group**

Our infants were transferred to Riverside Zoo in Scottsbluff, NE, for introduction to a group. It is our conclusion that if such a move is to be made, it is less traumatic for the infant if it is transferred either a few days after birth, or at the age of nine months. At nine months the monkey has grown out of the “clingy stage” and is becoming more independent of the caregivers.

## **A few developmental milestones.....**

### **Age**

1 week	Incisors through gums
3 weeks	Two distinct vocalizations: Chuckle, squawk Pushing own body up by straightening arms and legs Crawling
4 weeks	Two lower molars through Reaching for objects
5 weeks	Sitting up
6 weeks	Canines through Crawling fast Vocalization-high pitched chirp
7 weeks	Mouth full of teeth, cannot tell which are new
9 weeks	Pulling self hand-over-hand from one hanging object to another
10 weeks	Pulling entire body off of floor onto lowest bar of play structure



**Infant spider monkey exercising on wooden clothes drying rack.**

# ***Ungulate Neonate Feeding Techniques***

*by Michele Gaffney-Sr. Keeper / Mammal Dept.  
AAZK 18th National Conference: Neonatal  
Workshop, S.D. Wild Animal Park (Sept. 1992)  
Revised by K. Michelson-Lead Keeper / Vet. Serv.*

With the increased destruction of suitable wild habitats and decline of many animal populations, there is a growing awareness by zoos for maintaining a healthy, viable, and genetically fit population of many species of animals. Here at the San Diego Wild Animal Park Animal Care and Infant Isolation Units, the keeper staff is primarily involved with the hand-raising of ungulate neonates. Due to the design of the Park, which consists of multiple free-ranging enclosures, it is by far more desirable to exhibit many species of hoofstock as opposed to the more familiar assemblage of ungulates, carnivores, and a host of other small mammals generally found in contemporary zoos. Since there is a definite restriction on the number of animals sustainable in each area, it becomes necessary to control behavioral and husbandry problems which may arise from overpopulation. Many of the resulting offspring are chosen for shipment out of our collection. We've found that ultimately it's better for the animals if they're pulled when first born for hand-raising, and thus avoiding problems later when they have to be taken out of a large field enclosure. In addition to future shipments, neonates are hand-raised if there's an apparent illness or injury to either the neonate or dam, due to maternal neglect, inclement weather, or harassment by another animal.

After determining that a particular youngster needs to be hand-reared, it is brought to one of our nurseries by the field keeper. It is then quickly processed by weighing, taking its temperature, and giving routine medical treatment. The neonate is given its permanent Wild Animal Park identification by tagging and/or notching the ears. This is the numbering system that works best at the Park. We've found that the more common metal ear tags are often ripped out, so we use a round, plastic tag which is inserted into the center of the ear. Ear notches can be read from a distance with binoculars, a great benefit when you can't get close to a herd of animals running about in a large enclosure. Finally, the neonate will be bathed with betadine scrub (an antimicrobial wash), have its umbilical dipped with 3% iodine and placed in a comfortable stall. Following this "initiation" ceremony, the animal is usually allowed a short break before offering the first bottle. Although it would be nice for the neonates to receive colostrum from their dams and the subsequent benefits, in the long run it's best for both the keepers and the neonate if we can receive them as soon as possible to begin the hand-rearing process. The longer a kid is with its dam, the more difficult it is for us to get it nursing, possibly compromising its health.

We utilize a wide assortment of bottles and nipples. Various sized bottles along with calf, lamb, pritchard, human preemie, and a nipple specially designed at the San Diego Zoo for use on very small ungulates such as water deer, muntjac, or suni are selected for use appropriate to the neonate. The bottles and nipples are cleaned with disinfectants after each feeding. The wash sink contains a quaternary ammonium solution while the rinse sink contains a quaternary ammonium rinse. All bottles are made up prior to the feeding times, that way they only need to be taken out of the refrigerator and heated. Heat the bottles until the milk is lukewarm. It's important to not overheat the formulas

because it can destroy certain carbohydrates and proteins resulting in a malnourished meal for the neonate. Furthermore, if an animal is not yet nursing, any formula with colostrum or colostrum substitute is warmed only once, and regular formulas twice before remaking the bottle. It is advised against using microwaves for heating milk since they heat unevenly producing "hot" spots in the formula, bringing back the problem of ruining valuable nutrients.

The main concept in trying to get animals to nurse is to work from the simplest to the more involved methods. With new babies it's important to use various stimulation tactics to try and elicit a nursing response. Start by approaching it slowly and quietly, while making the appropriate vocalizations for the species. If there is no recognition or response from the animal, make your way over to it and try standing it up. If it will remain standing, back it into you or straddle the kid over your knees. If you have a "problem child", for instance the baby wants to remain tucked, is skittish, or a fighter, it might be better to fold it up and place it on your lap or next to you on the ground. Next gently rub and pat their hindquarters for added stimulus, while lowering your face down to the baby to see if it will start to nuzzle your neck, chin, or underarm. If it becomes very excited, it will actually chew and /or suck on your neck or clothing. At this point, if the neonate is still not taking the nipple on its own, you need to put it in its mouth. Go ahead and open the mouth just enough to insert the nipple. Try to complete this step quickly to minimize the chances of agitating the youngster. If you are having difficulty, the animal starts jumping or becomes very vocal, you will need to stop and start over from the beginning.

Next, make sure the tongue is forward and cupped around the nipple to help facilitate proper nursing. Gently hold the sides of the mouth to prevent the baby from just chewing on the nipple. By letting the neonate just chew and swallow down the formula, you will allow it to receive a small amount of food which can diminish its hunger and further retard bottle nursing. For additional stimulus, the bottle can be jiggled causing the nipple to move back and forth. The nursery keepers will normally try several different types of nipples initially because sometimes the slightest variation in textures will make a difference.

Once the youngster begins to nurse, it is very helpful to lift the nipple at its base just enough to allow air in the bottle. Many babies will stop sucking as it becomes harder to get the milk out due to increasing pressure inside of the bottle while nursing. They can learn to let air in on their own by releasing the nipple several times during nursing. This is desirable when several kids are being fed at once. It is crucial to remember not to overwork the baby to a point where it becomes agitated. Otherwise the whole experience will be negatively reinforced hindering the correct nursing response. On the average, 10-15 minutes are spent with a new kid.

With all these steps followed, if there is still no feeding success, try putting the baby in with an older and larger kid of the same or different species. Hopefully it will be considered a mother figure and entice the newborn to start looking to nurse. Now the keeper should try getting the neonate to accept a nipple by either putting it near its mouth and see if it will latch on or by quickly pulling it back and inserting the nipple. These series of steps will probably require several attempts before there is any success.

Another practice less frequently utilized is that of offering milk in a pan. Fill a low sided pan or dish partway with formula and present it to the neonate. You can see if the



baby will become interested by trying to get it to suckle milk off of a finger. Bring the pan right up to its muzzle. Hold the pan in this position until the neonate starts sipping down the formula or just doesn't seem motivated after a short time.

Whichever method is used, it's necessary to first continue offering a bottle in the previously mentioned format at every feeding. This way you can hopefully have the neonate nursing early on in its life. Remember, we are working towards the best scenario which is having the neonate approaching you after the proper vocalization, taking the nipple, and nursing on its own. Even if a youngster has been nursing fine for some time, it can stop nursing after becoming sick. Just start at the beginning steps, treating it like it was a newborn. Usually it will begin nursing normally again.

If at all possible, babies can be successfully bottle fed while remaining in their exhibits, giving them the necessary socialization not possible in a nursery environment. Generally, this will only work in smaller enclosures with animals reasonably calm around humans. Then again, we have been able to (very cautiously) supplement Indian rhino calves in the field enclosures due to their tractability. Of course, feeding on exhibit can only be accomplished if the neonates are taking bottles on their own with minimal intervention from the keepers.

Now that we've been exposed to the Wild Animal Park's animal care facilities "Protocol to Proper Nursing", I hope good practical information and examples have been given. Remember, feeding neonates can take a lot of time, patience, flexibility, and in some cases ingenuity. Basically, stay one step ahead of the neonate. It is important to learn particular behaviors of the species and to observe your animals individual behaviors as well, so they can be worked with as effectively as possible. Good luck and Bon Appetit!

### **Chapter News Notes** (Cont'd from page 354)

#### **San Diego AAZK Chapter**

The spring and summer months of 1995 have been very busy for our Chapter. In May, our Chapter was visited by John Olguin, the Director Emeritus of the Cabrillo Marine Museum. Memorial Day weekend hosted our annual Bowling for Rhinos fundraiser and despite a slightly lower turnout, we raised over \$5,000.00. Our top fundraiser was our newly elected president Nicki Boyd who raised just short of \$600.00.

In June, we heard from Chuck Traisi of the local Fund for Animals Wildlife Rehabilitation Center. We learned a lot about the work they do and how similar their work is to ours though on a different scale. The month of July was dedicated to gearing up for and holding our swap meet fundraiser. Our Chapter will match the

funds raised and donate the proceeds to the Tree Kangaroo SSP Avian TB Research Project.

We visited Sea World in August for an entertaining and enlightening behind-the-scenes tour of the Beached Marine Mammal Program with Animal Care Supervisor Bill Winhall.

We've had a few delays in the publishing of the *Keeper* magazine due to a slow return rate on requested article submissions. We hope to have the next issue out soon. Our 1996 Animal Buns calendar is scheduled to go to the printers shortly, so watch for publication this fall.

We hope you've all had as fun and productive a summer as we've had. See you in Denver.

--Jo Ann Haddad, Sec'y/Liaison

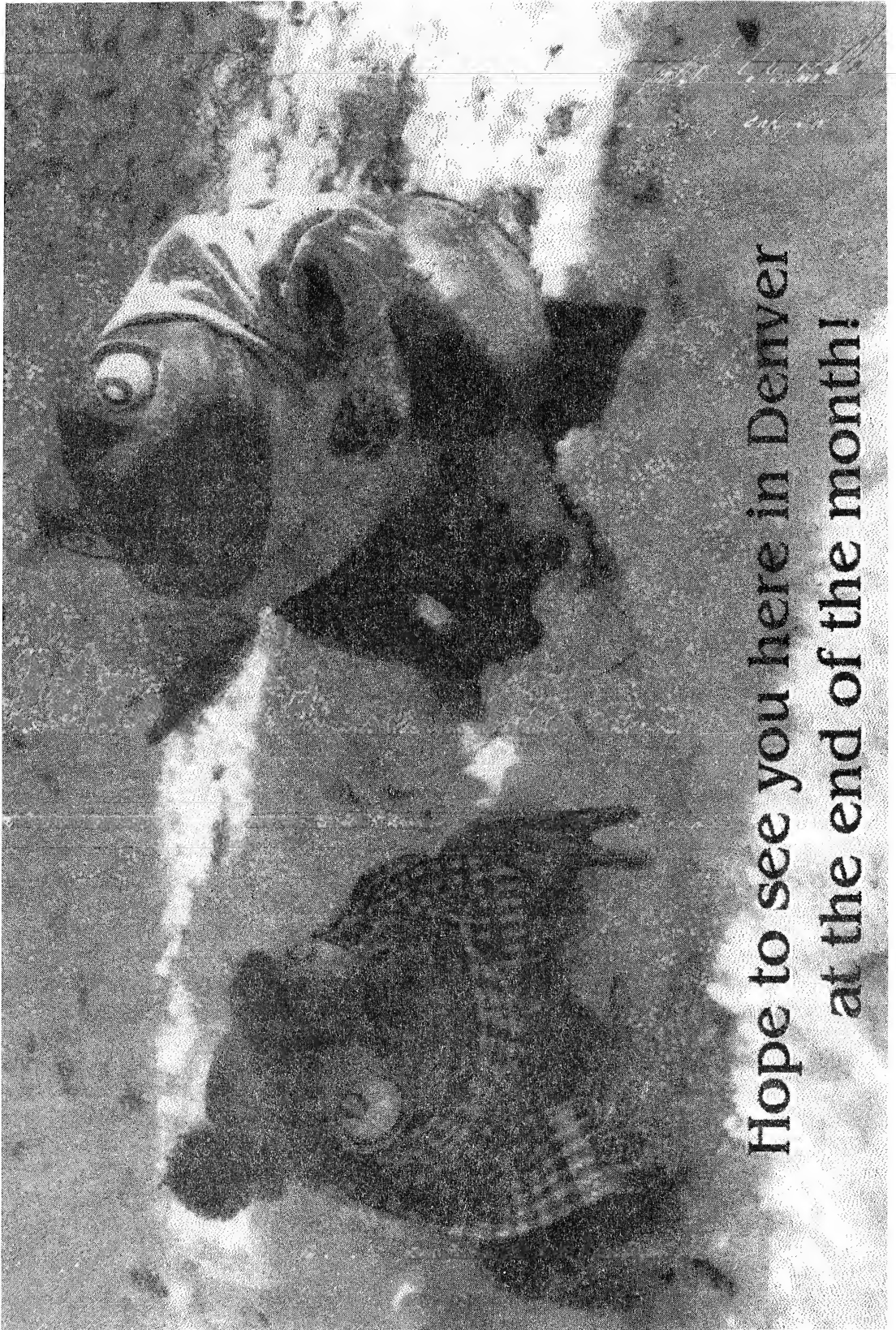

Hope to see you here in Denver  
at the end of the month!

# *Aspergillosis in a Hand-reared Flamingo Chick*

by Sara Hallager, Bird Keeper  
National Zoological Park, Washington D.C.

American flamingos (*Phoenicopterus ruber*) have been exhibited at The National Zoological Park (NZN) since 1899. However, not until 1992 did the first chick hatch, only to die several weeks later. In 1993, two chicks were hatched, one of which survived. The surviving chick was left with its parents for three weeks before it was pulled for hand-rearing. This paper describes the hand-rearing of the first flamingo chick to survive to adulthood at NZN.

## **History**

At NZN, all flamingo eggs laid are left for a period of ten days before being pulled from the nest and placed in an incubator with a dry bulb of 37.5°C (100° F) and a wet bulb of 55%. A dummy egg is placed under the parents. If, after candling, the egg is proven to be infertile, the dummy egg is removed and the pair will often lay another egg. If fertility is detected, the egg is left in the incubator until it is pipping, at which time it is placed back under the parents for hatching.

The chick described in this paper hatched on 15 July 1993 after an incubation period of 28 days. The parents had been in the collection since the mid-1970's and this was their first chick.

During the first week after hatching, the chick appeared to be well cared for by both its parents. Frequent feedings were observed and the chick was well protected. After two days, the chick was already off the nest walking around, and by five days, it was swimming. The chick was quite active and wandered around the exhibit always in the company of one or both of its parents.

At about Day 7, the chick's mother began to pay noticeably less attention to her chick, although she would come to its defense if it was being harassed by other birds. The chick's father remained attentive and appeared to be the one doing most of the feeding. By Day 10, the chick was being left alone frequently by both its parents. They would still defend it, although they were not always feeding it at times it begged for food.

Over the next nine days, the parents slowly abandoned their chick. They would not protect it when other birds were aggressive to it, and they were never observed feeding the chick. At times, they would even run away from it when it approached them. It was at this stage that the decision was made to pull the chick for hand-rearing. The chick was 19 days old, and this was NZN's first attempt at hand-rearing a flamingo.

## **Hand-rearing**

Obtaining the chick from inside the exhibit proved to be no problem since the parents had abandoned it. Upon initial examination by the veterinary staff, the chick was

noted to be weak, thin, and dehydrated. Since the bird appeared to have nothing in its crop, attempts to feed it began immediately. After attempting several methods of feeding, tube feeding was finally employed and this ended up being the sole method of feeding throughout the hand-rearing.

The diet developed by San Antonio Zoo (Kunneman and Perry, 1990) was followed as were many of the recommendations detailed in their paper in the AAZPA 1990 Regional Proceedings Flamingo Workshop. After an initial feeding of 8 ml, (1 Tbs.) the chick was placed inside a brooder to stabilize. Several small feedings throughout the day were subsequently given.



**Author tube feeding the 25-day-old flamingo chick.** (Photo by Jessie Cohen, NZP/Smithsonian Institution)

The following day, the chick was doing much better and appeared stronger. It was moved to an indoor enclosure used by the adult flamingos during bad wintertime weather. The house had a pool at one end, with a sand substrate flooring covering the remainder of the house. Carpeting was placed around the edges of the pool to protect the chick's feet, and a heat bulb was suspended in one corner for supplemental heat. Six green-winged teal (*Anas crecca*) (a mother and five chicks) and one smew (*Mergus albellus*) were already inside the house. Feeding times were set at three times/day and the chick was weighed prior to each morning's feed to ensure a weight gain of no more than 10% day (Table 1). A pan with adult flamingo food (Zeigler's Flamingo Fancier®) was placed in the house to encourage self-feeding.

The chick progressed well until seven days after it had been pulled for hand-rearing. On the morning of 10 August, the chick made some gurgling noises during feeding. An antibiotic injection of Chloramphenicol was administered by the vets to treat a possible case of pneumonia. The antibiotic treatment continued for the next two weeks. During this time, the chick seemed to improve and exhibited a constant weight gain along with a healthy appetite. No further signs of difficulty in breathing were noted.

Three weeks after pulling the chick for hand-rearing, the chick took a turn for the worse. At the morning feed, it would accept only half of the normal amount of formula. It seemed to have trouble breathing again while being fed and seemed depressed. After the second feeding of the day, it still would not eat more than half of its food. It was brought to the hospital for blood work and a tracheal wash.

The following day, the chick was still exhibiting signs of labored breathing. It was 25 August, and the humidity in Washington D.C. was oppressive. This high humidity further compromised the chick's ability to breathe and so it was moved to an air conditioned stall. The chick was placed on Ancobon® and Diflucan®, two anti-fungal drugs, three times a day to treat a highly suspected case of Aspergillosis, an often fatal lung disease in birds. At the morning feed the following day, the chick was extremely upset. It was shaking and had lost weight. Two green winged teal were brought into the stall for company, and this quickly calmed the chick.

Over the next six days, the chick's health began to slowly improve. Daily weight gains occurred, and the chick's appetite returned. The chick was placed on Piperacillin®, an antibiotic injection given once a day as a additional precaution. Self-feeding was observed for the first time when the chick was about 45 days old. During this period, the chick was seen eating its own feces. However, after adding a dish of fresh grass and dirt, the chick ceased this behavior and ate the grass and dirt instead. To encourage strong bones in the rapidly growing chick, it was taken out of its stall several times a day for 20-minute bouts of moderate exercise.

When the chick was 60 days old, it was moved outside to a large holding pen and the process of weaning was initiated. At 68 days, the chick appeared well enough to discontinue the noon medications. It was self-feeding well and probably did not need supplemental feedings except for the fact that the medication it was still on needed to be given with food.

On 30 September, the chick went to the hospital for another round of blood work, X-rays, and a tracheal wash. Results indicated no signs of the Aspergillosis, and the chick was reduced to one medication (Diflucan®). The following day, the chick's wing was slightly swollen. Several days later, it was so swollen that it was taped to the chick's body to provide more comfort. Palpitation of the wing was very painful for the chick and so a thorough examination was not possible. It appeared that the chick had somehow sustained injury during the X-raying process which caused a large hematoma to form.

The chick's appetite decreased over the next five days and it appeared to be depressed. It was feared that stress from the examination had brought back the Aspergillosis and so the chick was placed back on the Ancobon® and Piperacillin® in addition to the Diflucan®. To prevent further stress on the bird, it was decided not to X-ray the wing again.

By 10 October, the chick's appetite had improved. The swelling in the wing was down considerably. The weaning process continued, and by 18 October when the chick was 95 days old, it was weaned. It was still however, being tube-fed a small amount of food twice a day when medication was given.

On 27 October, the chick was well enough to discontinue all medication. Palpitation of the previously swollen wing revealed a disturbing discovery. The humerus had previously broken, and although the wing was completely healed, it had healed with a slight droop to it.

On 9 November, the chick was released into the flock. As of the writing of this paper, no further sign of Aspergillosis has been noted, and the chick appears healthy in every respect.



**A final weighing of the 117-day-old chick before release into the flock.**  
*(Photo by Jessie Cohen, NZP/Smithsonian Institution)*

## **Discussion**

Several points and recommendations can be made about this hand-rearing.

- 1) At the first signs of neglect on behalf of the parents towards the chick, the chick should have been pulled. Because the chick was left for too long, its general health was compromised and this most likely contributed to the development of the Aspergillosis.
- 2) The sand substrate on which the chick was initially placed provided a constant source of dust inside the house. This, combined with the high humidity and poor ventilation inside the house also probably contributed to the formation of the Aspergillosis.
- 3) The lack of sunlight early on in the hand-rearing process was most likely the cause for the ease with which the wing broke.
- 4) The dirt and grass given to the chick provided a source of minerals and bacteria obviously missing from the chick's diet. Had the chick been hand-reared outside, it would have been foraging in the grass and mud.
- 5) The teal and smew with which the flamingo was housed proved to be invaluable in terms of the chick's behavior. Being such social birds, flamingos often have difficulty being housed alone. This chick was no exception, and was constantly interacting with the ducks. Another flamingo would have been preferred, but the ducks proved to be a acceptable substitute.
- 6) Imprinting was a concern with this chick. Several weeks after pulling the chick from the flock, it appeared to be extremely imprinted. However, by following the recommendations of the San Antonio Zoo on introducing the chick back into the flock by three months of age, permanent imprinting was avoided.
- 7) Two flamingo chicks were hand-reared in 1994 with no complications. Lessons learned from 1993 included pulling the chicks at the first sign of neglect, and rearing the chicks in an outside, grass-covered enclosure with plenty of room to exercise. The 1994 chicks were reared within hearing distance of the adult flock. Whether this had any effect on the birds is difficult to say, although they did at times appear to react to certain vocalizations made by the flock.

## **Author's Comments**

For those individuals attempting hand-rearing of flamingos for the first time, any suggestions are helpful. When we were faced with the reality of hand-rearing this chick, I was able to find extremely little published information on hand-rearing of this species. Although American flamingos have been hand-reared for nearly 20 years, there is little published information available to those new to the process. It is hoped that this paper can provide some guidelines as to what has worked at NZP, and what has not, for anyone who is hand-rearing flamingos.

## **Acknowledgments**

I thank the entire staff of the Bird House for their assistance in this hand-rearing, but especially Frank Cusimano and Kathy Ruffino for their help and great devotion with

this difficult hand-rearing. I thank Charles Pilckett, Curator of Birds, for his support and encouragement. I am especially thankful to Dr. Lisa Tell, and Dr. Suzan Murray, without whose extraordinary veterinary skills, this chick would not have survived.

## References

Kunneman, F., and J. Perry. Hand-rearing of the Caribbean flamingo, *Phoenicopterus r. ruber* at the San Antonio Zoo.  
In: AAZPA 1990 Regional Proceedings: 225-231.

## Products mentioned in the text

Zeigler Flamingo Fancier® Diet  
Zeigler Bros., Inc.  
P.O. Box 95  
Gardners, PA 17324

Piperacillin® Sodium Lederle  
Piperacillin Inc.,  
Carolina, Puerto Rico 00630

Flucytosine (Ancobon®)  
Hoffman LaRoche, Inc.  
Nutley, NJ 07111

Chloramphenicol Sodium Succinate  
Warner Lambert Co.  
Morris Plains, NJ 07950

Fluconazole (Diflucan®)  
Pfizers, Inc.  
New York, NY 10017

**Table 1.** Weight gain of a male hand-reared American flamingo chick pulled at 19 days and released back into the flock at 117 days.

<u>Age of chick (days)</u>	<u>Weight of chick (grams)</u>
19	235
25	342
30	480
35	705
40	997
45	1255
50	1595
55	1830
60	2050
65	1950
70	2140
75	2430
100	2870
117	3030





# DOWN UNDER

By Judie Steenberg, Keeper  
Woodland Park Zoo  
Seattle, WA

DOWN UNDER is an information column about Australasian animals. While there are a number of keepers who work in Australasian units, or routines, oft times a Keeper will have a few species of animals from the Australasian zoogeographical region on their string or routine. It is hoped this section will contain information on birds, mammals and reptiles of the area.

This column is intended to:

- share experiences and information to improve the care and management of Australasian animals.
- seek information and advice on problems that occur.
- serve as a forum through which to make comment, to ask questions, to critique or to verify information.

Please send your materials (a question, a paragraph, or an article) directly to *Animal Keepers' Forum*, Topeka Zoological Park, 635 S. W. Gage Blvd., Topeka, KS 66606-2066.

## **Kangaroos Blinded By Mysterious Virus**

Across the bushlands of Southern Australia and into neighboring New South Wales, a new threat has risen for the gray kangaroos living there. According to official reports, one-tenth of the 500,000 western gray kangaroos and 2.8 million of the gray kangaroos in these areas have become mysteriously blind over the last year.

Although some anecdotal evidence points to undiagnosed outbreaks of the blinding disease in the 1930's and 1950's, there have been no modern traces of the virus on record. However, in the small, remote mining town of Broken Hill New South Wales, farmers and ranchers were noticing strange behavior in the local kangaroo population around March of 1994. Seeking answers to the problem, carcasses of kangaroos found in the region were sent to Bill Hartley, a pathologist at the Taronga Park Zoo in Sydney.

Examining the samples, he found the animals had severe inflammation and lesions on their retinas and optic nerves; sometimes even spreading into their brain. Under the microscope, the very structure of the retina appeared to be dissolving right in front of him.

He quickly ruled out the possibility of poisoning; while the lack of the classic telltale sign of bacteria, pus, brought him to the conclusion that the blindness must have been caused by a virus.

“As it spread so rapidly over a couple of months, we are of the opinion that the only possible way it could have spread was by insects,” Hartly said.

Also blamed for the rapid infection of the virus is a severe drought this year that is believed to have physically stressed the kangaroos. This, perhaps, has caused them to crowd around remaining water holes and streams, accelerating the spread of the disease. Unfortunately, the gray and western gray are not the only marsupial species affected by the blinding virus. The Red and European kangaroos have been noted to be afflicted, as well as some wallabies. Though these cases have been reported, the number of these victims is much smaller than that of the grays.

As of yet, the disease is not threatening the plentiful kangaroo population, but some officials are worried that it could spread to endangered marsupials, like the yellow-footed rock wallaby. Of which there are only a few hundred reported to be alive.

Peter Durham, a veterinary virologist with the Department of Agriculture Laboratories in Adelaide, believes the disease to be from the Bunya family of more than 80 viruses that can afflict marsupials and other mammals.

According to Durham, a vaccine could be developed to protect endangered marsupial species; but this can not be confirmed until he can test the cultivated virus on kangaroos.

As to what can be done in the short-term to relieve the suffering animals, Durham had this to say: “In terms of the wild population, it will just have to run its course.”

*Source: Topeka Capital-Journal, Topeka, KS, 24 June 1995 after AP Release*

---

---

*Wild  
News* Wildlife art and photography festivals, bird counts, and 5K runs for wildlife conservation are just some of the special events planned for October at refuges across the country to launch the first-even National Wildlife Refuge Week this year. President Theodore Roosevelt established the first NWR in 1903, Pelican Island in Florida, to protect herons, egrets, and other colonial nesting birds from slaughter by market hunters. He established 50 more refuges during his presidency. Today, that legacy has grown to more than 500 refuges, covering 92 million acres in all 50 states and several territories. They range in size from a half-acre to 20 million acres and include every kind of ecosystem in the country, from deserts and mountains to swamps and remote islands. Most refuges were established to provide habitat for migratory birds, whose fall migration will be in full swing in October. USFWS Director Mollie Beattie said the second week in October will be observed as National Wildlife Refuge Week, leading up to the 100th anniversary in 2003. “It's time for all Americans to learn about and celebrate this magnificent collection of lands we as a people have set aside for wildlife,” said Beattie.

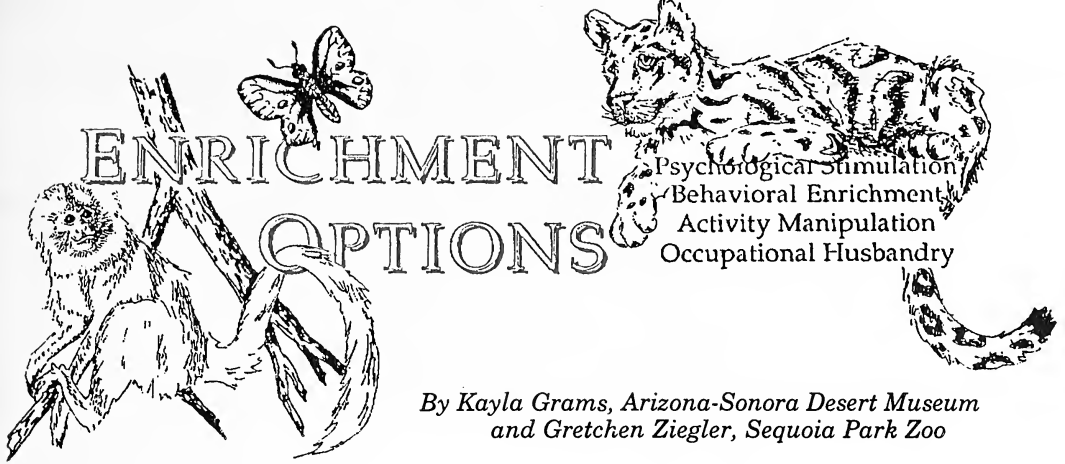

*The following are ideas which can be used with various animals and were submitted by Melanie Haynes, Pueblo Zoological Society, Pueblo, CO:*

1. Mealworm Dispenser - use PVC tubing with holes large enough for mealworms to fit through. Hang it from the top of the exhibit and the mealworms slowly crawl out and drop down into the substrate where the animals have to forage for them. (Used for tamarins, meerkats, and others)
2. Boomer Balls® - various sizes with holes drilled in for raisins, and grapes (bears and lemurs love it, but try it with other animals as well).
3. Kong Toy - filled with grapes
4. One half coconut shells to smear with banana
5. Corn husks to wrap around food
6. For Squirrels use a suet feeder and put in large pieces of produce, 1/4 oranges, corn on the cob. Hang from a limb, but not secure so that it moves.
7. Cats - towels to tear up, ropes tied on the edge of a cage to tug on, burlap bag with sand in it hung from the exhibit, blocks of wood hung.
8. Ice sickles - freeze fruits in sickles for primates, accouchies, squirrels. Fish frozen in sickles for bears and cats. This can be tried with many other animals as well.
9. Bamboo - bears, lemurs, tamarins and other animals.

*Donna Versteeg, Walk in the Wild Zoo, Spokane, WA submitted these ideas:*

1. Tennis balls with small slits with treats inside for small primates
2. Kegs to cats and bears
3. Split logs with treats inside for bears

Provide Children's Petting Zoo rabbits the climbing opportunities they have in nature by elevating logs or platforms. Or offer them play structures such as the ones made by Little Tykes® (approx. 2 1/2' x 2 1/2' x 5 1/2' long). This mini-rex rabbit uses the slide as a ramp to the top platform ( 1 1/2' high) (See Fig. 1) and the cut-outs as portholes ( see Figure 2). Although most Little Tykes® structures come in bright colors, some have recently come on the market in softer grays and greens. They are durable, easy to clean and sanitize, and fairly inexpensive (\$65 - \$165 depending on the size). If you don't want them on display, consider placing them in off-exhibit areas. Raccoons and small primates such as capuchins and squirrel monkeys make use of these structures too (see Figure 3).

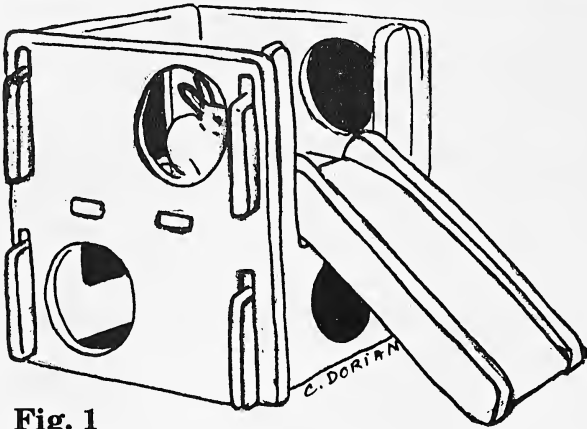

**Fig. 1**

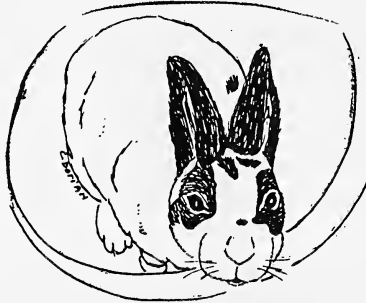
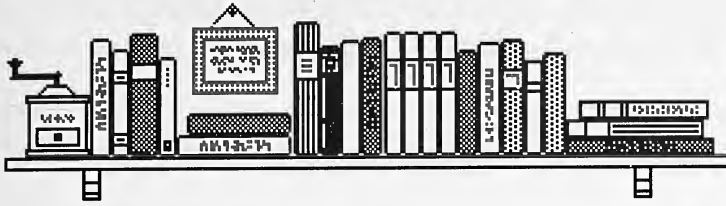

**Fig. 2**



**Fig. 3**

**RAVEN** - Each year our female raven plucks her feathers. To try and curb this activity, our keepers have come up with some successful ideas. First we tried a feather duster, the idea being that if she wanted to pluck feathers, we'd give her feathers to pluck. It was an astounding success! Within two days she had plucked the feather duster clean. With this in mind we tried offering bundles of turkey and vulture feathers from molting birds. This was an effort in finding more natural options that could be used on exhibit. She eventually broke most of these feathers but it did seem to be a favorite. But the keepers offered several other items that do seem to work well. Palm fronds are a favorite, thought the smaller the better, corn in the husk is great (idea from "Enrichment Options"! ) and dates hanging from the original branches seem to inspire plucking. Most recently we tried a straw broom which she plucked practically clean. We cannot tell if she has discontinued plucking her own feathers yet, but we may not have put as much effort in if there wasn't an obvious symptom. We are glad that she is at least occupying herself these days. Submitted by Arizona-Sonora Desert Museum Keepers, Department of Mammalogy and Ornithology, Tucson, AZ.



# Book Review

## **Cheetahs of the Serengeti Plains: *Group Living in an Asocial Species***

By Dr. Tim Caro, Associate Professor, Center for Population Biology and the Department of Wildlife and Fisheries Biology; University of California Davis.

University of Chicago Press, 1994  
5801 S. Ellis Ave., Chicago, IL 60637  
478 pgs. Paperback \$26.00

*Review by Stuart A. Wells, Biologist  
Cheetah Conservation Stn.  
National Zoological Park  
Smithsonian Institution  
Washington, DC*

**Cheetahs of the Serengeti** is the long anticipated result of Dr. Caro's 12-year study of free-ranging cheetahs living in the Serengeti Plains of East Africa. Free-ranging cheetahs in this region have been studied by others—Schaller, Burney and Frame & Frame—but Caro has compiled the most recent synopsis covering all aspects of *in situ* social ecology of cheetahs. Caro points out that cheetahs are an especially important species for studying origins of sociality, because they exhibit great variation in their social organization. From an empirical statement, this enabled Caro to examine hypotheses about group living without the confounding effects of phylogeny.

Caro has organized his book to reflect variations in cheetah social groupings. Of the book's 13 chapters, the first is a literature review on group living and cooperative hunting in mammals, and especially carnivores. Chapter 2 is an overview of cheetah natural history and a description of his study area. Chapter 3 summarizes his sampling methods and techniques used throughout his study. The subsequent chapters report in-depth on cheetah sociality—females, mothers with cubs, sibling groupings, and finally males and the importance of male cheetah coalitions. Caro examines cooperative hunting in Chapter 10. Chapter 11 is devoted to highlighting the evolutionary and ecological findings from his work and compares differences in cheetah sociality with sociality in other felids. Caro concludes by defining problems and outlining specific approaches to *in situ* and *ex-situ* conservation. He concludes that habitat destruction is the principle threat to their continued survival in the wild.

With respect to *ex-situ* propagation, Caro has recognized the enormous contribution that Dr. Stephen O'Brien and associates have made toward our understanding about how the cheetah's lack of genetic diversity may effect cub mortality and resistance to disease. He concludes, however, that poor breeding success in captivity can be attributed to behavioral rather than genetic or physiological factors.

I find Caro's work extraordinarily useful for my ongoing work in captive cheetah behavioral studies and efforts to formulate optimum breeding conditions. It helps to fill the chasm between understanding the complexity of this magnificent animals' sociality and applying that understanding towards developing more effective and consistent captive propagation strategies.

# Hand-rearing *Orycteropus afer* at the Philadelphia Zoo

by Kay Hauber- Relief Keeper, Small Mammal House  
Philadelphia Zoo, Philadelphia, PA

The Philadelphia Zoo had a unique opportunity in hand-rearing an aardvark this year. Fewer than 10 zoos in this country breed and raise *Orycteropus afer*. This was the fifth infant born to our female, Aava, but only the second to survive. For most zoos that breed aardvarks, keeping the newborns alive can be challenging. This infant would be no different.

Philadelphia (Phil), was born on 6 Jan. 1995. On his birth date he weighed 1.612 kg. All appeared well. Aava behaved maternally and the baby was observed nursing. However, by midday on Day 3, nursing was not observed and the infant's physical condition had markedly deteriorated. At 1400 hrs. on 9 Jan. 1995, Phil was removed from the exhibit and taken to the hospital.

Upon arrival at the hospital, it was discovered that the infant was seriously dehydrated. It was determined that Aava had not been lactating sufficiently. His condition did not look good nor did it stabilize for several days. However, by 18 Jan. 1995, even though Phil was still battled constipation, decreases in appetite, and abscesses, he had begun to urinate on his own and was drinking from a bottle. On 25 Jan. 1995, the decision was made to attempt a reintroduction to the dam.

There were several reasons for attempting to reintroduce the baby to the female. The hospital staff did not have the space to raise an aardvark; it was possible for the keeper staff to intervene if he was not readily accepted; and even though the baby would have to be supplementally fed, it was believed that both mother and infant would benefit. Following are the keepers' log book entries after the reintroduction.

## Log book Entries for 1.0 Aardvark born 6 Jan. 1995

**27 Jan. 1995--** A successful reintroduction was achieved. The female was attentive, not indifferent as feared. Baby is supplementally fed 3x's daily. He is pulled at 1700 hrs. and put in an incubator for the night.

**28 Jan. 1995--** Baby is fed formula from a bottle. The process is difficult. He does not readily accept the nipple. We need to force open his mouth and then hold his head stationary.

**30 Jan. 1995--** Keeper observed Phil actively rooting and suckling from Aava. The keeper is able to express milk from all four teats, but it is determined not to be enough to sustain life.

**31 Jan. 1995--** Infant is no longer pulled at night.

**1 Feb. 1995--** Baby is still fed formula 3x's daily. He is becoming increasingly hard to handle while feeding or weighing.

**2 Feb. 1995**--Hospital staff weighed baby after last night's feeding and prior to today's a.m. feeding, to determine if he gains weight from nursing overnight. The result is no weight loss, but no weight gain overnight either.

**3 Feb. 1995**--Keeper notes baby is not always hungry at a.m. feeding. He may be getting more of mother's milk. Formula still offered 3x's daily.

**4 Feb. 1995**--When mother leaves nestbox, baby is making the first attempts to follow.

**7 Feb. 1995**--Adult female is making what are interpreted as aggressive vocalizations toward keepers when they remove infant from box to bottle feed. Formula feedings are reduced to twice daily, as Phil continues to gain weight, but has decreased appetite for the bottle.

**8 Feb. 1995**--Baby lost 3.5 ounces (99 grams) from yesterday. He is returned to three daily feedings.

**12 Feb. 1995**--Baby making several serious attempts to follow dam from nestbox. Keeper staff lowers restraining lip on the door and "baby proofs" the exhibit, including removing mulch litter box and deep bucket of free standing water.

**21 Feb. 1995**--Breeding male is returned to exhibit from holding area. Introduction goes well. Male is most interested in Aava. Phil shows some mildly agitated behavior. He paces the exhibit alone, but eventually calms down. By late afternoon, all three are sleeping together in the nestbox.

**9 Mar. 1995**--Baby has been readily accepting the bottle nipple for the past several days. Recently, he does not seem as interested in the bottle feedings. Adult diet was seen on his face today.

**2 April 1995**--Baby actually observed eating the adult diet today.

**4 April 1995**--Adult diet increased to allow for increased consumption by infant.

**8 April 1995**--Phil observed eating a significant amount of adult diet. Formula is still offered by bottle 3x's daily, though he does not always eat at each of these feedings.

**11 April 1995**--Formula being offered twice daily. Infant often seen at adult food dishes with parents.

**5 May 1995**---Once daily keepers offer as much formula as he'll eat.

**26 May 1995**--Formula feedings are discontinued as the baby continually refuses the bottle. He is observed feeding alone at the adult dishes and occasionally nursing from dam.

**29 May 1995**--Keeper reports not having observed any nursing for a few days.

**14 June 1995**--Keeper observes baby suckling dam. It is unclear if he is getting any milk.

**21 June 1995**--Keeper heard baby suckling dam. Under observation, she noticed all four nipples distended and the udder slightly swollen. The keeper was able to express milk from all four teats.

**22 June 1995**--Aardvarks consuming all of increased adult diet.

Critical information on the nutritional requirements of a pregnant and lactating female was gathered after Aava unexpectedly began producing milk upon Phil's reintroduction. Even though the volume of milk was not consistent enough to sustain life, it is hoped that the information gained by hand-rearing this infant will promote raising mother-reared infants in the future.

### **Diet for PZG *Orycteropus afer***

#### **Infant Formula:**

One part Esbilac™ Puppy Replacer (powered form)  
to two parts water

---

#### **Gruel mixture for all three Aardvarks:**

65 oz. dry dog kibble  
5 cans wet dog food  
20 oz. baby cereal  
3 Tbs. peanut oil  
3 multivitamins  
2.75 g of Lacto-Sacc®  
Enough water to make a soupy mixture  
Mix all ingredients thoroughly in a blender

---





## Aardvark Weight Chart

Date	Age in Days	Weight in Kgs	mL Fed
06/01/95	0	1.612	nursing
07/01/95	1	-	nursing
08/01/95	2	-	nursing
09/01/95	3	1.335	20
10/01/95	4	1.605	Given IV
11/01/95	5	1.946	250
12/01/95	6	2.074	285
13/01/95	7	2.145	255
14/01/95	8	2.088	270
15/01/95	9	2.131	
16/01/95	10	2.102	270
17/01/95	11	2.216	209
18/01/95	12	2.244	280
19/01/95	13	2.358	340
20/01/95	14	2.415	260
21/01/95	15	2.486	285
22/01/95	16	2.500	320
23/01/95	17	2.614	348
24/01/95	18	2.727	260
25/01/95	19	2.784	305
26/01/95	20	2.827	305
27/01/95	21	2.912	260
28/01/95	22	2.955	327
29/01/95	23	2.997	277
30/01/95	24	3.040	320
31/01/95	25	3.281	270
01/02/95	26	3.480	280
02/02/95	27	3.665	340
03/02/95	28	3.906	215
04/02/95	29	4.034	200
05/02/95	30	4.176	235
06/02/95	31	4.318	242
07/02/95	32	4.418	135
08/02/95	33	4.318	260
09/02/95	34	4.602	275

Date	Age in Days	Weight in Kgs	mL Fed
10/02/95	39	4.773	350
11/02/95	36	5.043	195
12/02/95	37	5.114	225
13/02/95	38	5.256	230
14/02/95	39	5.398	230
15/02/95	40	5.568	195
15/02/95	41	5.739	320
17/02/95	42	5.909	290
18/02/95	43	6.051	325
19/02/95	44	6.307	240
20/02/95	45	6.392	305
21/02/95	46	6.634	325
22/02/95	47		375
23/02/95	48	7.273	420
24/02/95	49		395
25/02/95	50	7.472	465
26/02/95	51		305
27/02/95	52	8.068	235
28/02/95	53		325
01/03/95	54	8.210	255
02/03/95	55		340
03/03/95	56	8.665	340
04/03/95	57		345
05/03/95	58	9.261	330
06/03/95	59		295
07/03/95	60	9.290	380
08/03/95	61		305
09/03/95	62	9.801	290
10/03/95	63		385
11/03/95	64	10.369	455
12/03/95	65		385
13/03/95	66	10.881	500
14/03/95	67		340
15/03/95	68	11.250	390
16/03/95	69		305
17/03/95	70	11.676	450

Date	Age in Days	Weight in Kgs	mL Fed
18/03/95	71		280
19/03/95	72	12.244	355
20/03/95	73		335
21/03/95	74		370
22/03/95	75		325
23/03/95	76		390
24/03/95	77	13.182	360
25/03/95	78		430
26/03/95	79		345
27/03/95	80		385
28/03/95	81		660
29/03/95	82		665
30/03/95	83		685
31/03/95	84	15.909	450
01/04/95	85		665
02/04/95	86		450
03/04/95	87		560
04/04/95	88		545
05/04/95	89		580
06/04/95	90		645
07/04/95	91		650
08/04/95	92		685
09/04/95	93	18.182	720
10/04/95	94		490
11/04/95	95		420
12/04/95	96		580
13/04/95	97		780
14/04/95	98		500
15/04/95	99		435
16/04/95	100		350
17/04/95	101		210
18/04/95	102	18.864	535
19/04/95	103		405
20/04/95	104		470
21/04/95	105		165
22/04/95	106		365

Date	Age in Days	Weight in Kgs	mL Fed
23/04/95	107		360
24/04/95	108		145
28/04/95	109		215
29/04/95	109		260
27/04/95	111		355
28/04/95	117		490
29/04/95	113		225
30/04/95	111		610
01/05/95	115		410
02/05/95	115		260
03/05/95	117		260
04/05/95	118		160
05/05/95	119		175
06/05/95	120		295
07/05/95	121		0
08/05/95	122		290
09/05/95	123		275
10/05/95	124		260
11/05/95	125		260
12/05/95	126		275
13/05/95	127		0
14/05/95	128		0
15/05/95	129		65
16/05/95	130		130
17/05/95	131		420
18/05/95	132		260
19/05/95	133		260
20/05/95	134		195
21/05/95	135		195
22/05/95	136		0
23/05/95	137		65
24/05/95	138		160
25/05/95	139		0
26/05/95	140		weaned from formula
01/07/95	176	36.90	

# **L.I.N.K.**

## **(Liaison and Information Network for Keepers)**

Coordinator for the LINK System: Mark de Denus, Assiniboine Park Zoo, 2355 Corydon Ave., Winnipeg, Manitoba, Canada R3P 0R5. (204) 986-6921 [w]; (204) 837-2916 [h]. Assistant LINK Coordinator - Ric Urban, Houston Zoological Gardens, Houston, TX, 1513 MacGregor Way, Houston, TX 77030 (713) 520-3234 [w].

### **Regional Coordinators**

**ALABAMA** - Fred Alvey, Zoo Atlanta, 800 Cherokee Ave. S.E., Atlanta, GA 30315  
**ARKANSAS** - Debbie Jackson or Ann Rademacher, Little Rock Zoological Gardens, #1 Jonesboro Dr., Little Rock, AR 72205  
**CALIFORNIA (Northern)**- Jean Lai, Oakland Zoo, 9777 Golf Links Rd., Oakland, CA 94605  
and Ruby Lara, Sacramento Zoo, 3930 West Land Park Dr., Sacramento, CA 95822-1123  
**CONNECTICUT**- Jeanette Nadeau, Roger Williams Park Zoo, Providence, RI 02905  
**DELEWARE** - Theresa Maas, Philadelphia Zoo, 34th & Girard Ave., Philadelphia, PA 19104  
**FLORIDA** - Rick Smith, 4707 Walden Circle #409, Orlando, FL 32811  
**GEORGIA** - Fred Alvey, Zoo Atlanta, 800 Cherokee Ave. S.E., Atlanta, GA 30315  
**IDAHO** -Holly Liappas, Tautphaus Park Zoo, P.O. Box 50220, Idaho Falls, ID 83405  
**ILLINOIS** - Pat Swieca, 5710 W. Cullom Ave., Chicago, IL 60634  
**INDIANA** - Jan Weinig, P.O. Box 197, Michigan City, IN 46360  
**KANSAS** - Brian Kohler, Lee Richardson Zoo, P.O. Box 499, Garden City, KS 67846-0499  
**KENTUCKY** - Scott Wright, Cleveland Zoo, 3900 Brookside Park Dr., Cleveland, OH 44109  
**LOUISIANA** - Rhonda Votino, 3535 Houma Blvd., Apt. 109, Metairie, LA 70006  
**MAINE** - Jeanette Nadeau (see addresses under CT)  
**MARYLAND** - Theresa Maas, Philadelphia Zoo, 34th & Girard Ave., Philadelphia, PA  
**MASSACHUSETTS** - Jeanette Nadeau (see addresses under CT)  
**MICHIGAN** - Tim Sampson, John Ball Zoo, 1300 W. Fulton, Grand Rapids, MI 49504  
**MINNESOTA** - Tim Hill, Minnesota Zoological Gdns., 13000 Zoo Blvd., Apple Valley, MN 55124  
**MISSISSIPPI** - Jeannie Frazier, Jackson Zoological Park, 2918 W. Capitol, Jackson, MS 39209  
**MISSOURI** - Brian Kohler, Lee Richardson Zoo, P.O. Box 499, Garden City, KS 67846-0499  
**MONTANA** - Holly Liappas (see address under Idaho)  
**NEVADA** - Patricia Simonet, Wildlife Safaris, P.O. Box 6735, Incline Village, NV 89450  
**NEW HAMPSHIRE** - Jeanette Nadeau (see addresses under CT)  
**NEW JERSEY** - Frank Leonard, Bronx Zoo, 185th & Southern Blvd., Bronx, NY 10460  
**EAST NEW YORK** - Frank Leonard, Bronx Zoo, 185th & Southern Blvd., Bronx, NY 10460  
**WEST NEW YORK** - Alan Baker, Burnet Park Zoo, 500 Burnet Park Dr., Syracuse, NY 13204  
**NORTH CAROLINA** - Kristin LaHue, Riverbanks Zoo, P.O. Box 1060, Columbia, SC 29202-1060  
**NORTH DAKOTA** - Bob Debets, Assiniboine Park Zoo, 2355 Corydon Ave., Winnipeg, MB Canada R3P 0R5  
**OHIO** - Scott Wright, Cleveland Metroparks Zoo, 3900 Brookside Park Dr., Cleveland, OH 44109  
**OKLAHOMA** - Debbie Jackson or Ann Rademacher (see addresses under AR)  
**OREGON** - Anna Michel, Washington Park Zoo, 4001 SW Canyon Rd., Portland, OR 97221  
**PENNSYLVANIA** - Theresa Maas, Philadelphia Zoo, 3400 W. Girard, Philadelphia, PA 19104  
**RHODE ISLAND** - Jeanette Nadeau (see addresses under CT)  
**SOUTH CAROLINA** - Kristin LaHue, Riverbanks Zoo, P.O. Box 1060, Columbia, SC 29202-1060  
**SOUTH DAKOTA** - Bob Debets (see address under ND)  
**TENNESSEE** - Gail Karr or Cindy Pinger, Memphis Zoo & Aquarium, 2000 Galloway, Memphis, TN 38112  
**TEXAS** - Connie Dieringer, Houston Zoo, 1513 N. MacGregor, Houston, TX 77030  
**VERMONT** - Jeanette Nadeau (see addresses under CT)  
**VIRGINIA** - Theresa Maas, Philadelphia Zoo, 34th & Girard, Philadelphia, PA 19104  
**WEST VIRGINIA** - Theresa Maas, Philadelphia Zoo, 34th & Girard, Philadelphia, PA 19104  
**WISCONSIN** - Wayne Hazlett, 3768 S. 89th St., Milwaukee, WI 53228  
**WYOMING** - Holly Liappas (see address under Idaho)  
**DISTRICT OF COLUMBIA** - Theresa Maas (see address under PA)  
**Provinces of Manitoba & Saskatchewan** - Bob Debets (see address under ND)  
**Provinces of Alberta & British Columbia** - Grant Tkachuk, 9955 114th St. Apt. A, Edmonton, AB T5K1P7  
**Atlantic Canada** - Bernard Gallant, RR # 7, 1081 Ryan Road, Moncton, N.B., E1C 8Z4

### **Vacancies**

Vacancies exist for the following States or Provinces: Alaska, Arizona, Southern California, Colorado, Hawaii, Iowa, New Mexico, Nebraska, Utah, Washington, Ontario and Quebec.

*Institutions wishing to advertise employment opportunities are asked to send pertinent data by the 15th of each month to: Opportunity Knocks / AKF, 635 S.W. Gage Blvd., Topeka, KS 66606-2066. Please include closing dates for positions available. There is no charge for this service and phone-in or fax listings of positions which become available close to deadline are accepted. Our phone is 1-800-242-4519 (U.S.); 1-800-468-1966 (Canada). Our FAX is 913-273-1980.*

**ZOOKEEPER**...requires A.S. or B.S. in an animal-related field and experience working with herptiles and fish. Responsible for the daily care of herps, fish, and invertebrates. Will also be trained for occasional work in other areas of the zoo. Salary \$7/hr. with excellent benefits. Send resumé/references **by 16 October 1995** to: Mike Borders, Director, Scovill Children's Zoo, 71 S. Country Club Rd., Decatur, IL 62521-4470.

**ANIMAL TRAINER**...the Ardastra Gardens & Zoo in Nassau, Bahamas invites applications for persons skilled in training animals/birds for the purpose of entertainment and who can maintain the show already in place. Salary is negotiable and would depend largely on qualifications & previous experience. Please send usual personal & professional resúmes by fax or AIR MAIL (not first class mail) to: Norman S. Solomon, P.O. Box N-4882, Nassau, Bahamas or FAX (809) 393-5210.

**ZOO SUPERVISOR**...assigns, supervises and reviews the work of personnel engaged in the care of zoo animals and the maintenance and security of the Sacramento City Zoo facilities. Requires: 5 years of progressively responsible experience working with captive exotic animals; including 2 years lead supervisory experience. Completion of related college level courses in biology per month, plus benefits (starting salary dependent upon qualifications). City of Sacramento application packets available 9/5/95 at 921 10th St., Room 101, Sacramento, CA 95814, (916) 264-5726. **Filing deadline is 25 September 1995.**

**CURATOR OF MAMMALS**...applications are now being accepted for the position of Curator of Preserve. University degree in a related field is preferred or equivalent experience in a recognized zoological facility is acceptable. Supervisory experience desired. The successful applicant will be responsible for daily care and management of a diversified collection of hoofstock, carnivores, birds and primates, including maintenance, diets, veterinary procedures, capture and restraint and record keeping. He/she will supervise a staff of 12 keepers. Excellent benefits package and salary commensurate with education and experience. Send resumé, salary requirements and 3 references to: Lion Country Safari, P.O. Box 16066, West Palm Beach, FL 33416-6066, Attn: Cathey Toomey - Personnel.

**ANIMAL TECHNICIAN**..Greater Baton Rouge Zoo, Baton Rouge, LA - requires high school diploma (some college in a related field desired). This is a general keeper position and may require working in any area of the zoo; however, previous elephant keeper experience is desired. Will be responsible for the daily care of zoo animals, security, exhibit design and maintenance, daily reports and record-keeping. Salary \$1,243/month plus excellent benefits. Please apply by sending resumé and letter to Director of Human Resources, P.O. Box 15887, Baton Rouge, LA 70895 or fax/phone (504) 273-6430. **Applications due by 25 September 1995.**

**KANGAROO KEEPER**...requires experience in management/care of zoological animals, marsupials preferred. Full-time duties include, but not limited to, animal care, exhibit

maintenance. Must be physically strong, willing to work outdoors year-round, some weekends and holidays. Private breeding farm - not open to the public. Salary commensurate with qualifications. Send resumé (including salary history) and three references to: Nelson's Twin Oaks Farm, 13305 Bethany Rd., Alpharetta, GA 30201. Fax (770) 475-6001. Position to be filled ASAP.

**KEEPER**...keeper with a minimum of two (2) year's experience in captive animal care in a zoo, demonstrated ability to maintain records and talk to the public, and an interest in working with a variety of animals. Send cover letter and resumé to: Human Resources, Philadelphia Zoo, 3400 West Girard Ave., Philadelphia, PA 19104.

**SPECIES & ECOSYSTEM PROGRAM COORDINATOR**...African Wildlife Federation (AWF) is seeking a species & ecosystem program coordinator to provide effective coordination and technical direction, management and fundraising support to the Species & Ecosystem Program (SEC). Post is based in Nairobi, Kenya. Candidate must have: higher degree in natural sciences or related field; at least seven (7) years experience in wildlife conservation, preferably in Africa, proven project management abilities, fundraising experience and ability to communicate effectively. SEC Coordinator works with colleagues to set program objectives, coordinates staff, integrates SEC with AWF's community conservation and institutional development focus, and with Development identifies funding sources and develops proposals. Salary commensurate with experience. Contact AWF, 1717 Massachusetts Ave., NW, Washington, DC 20036.

**ELEPHANT KEEPER**...the Lee Richardson Zoo is seeking resúmes from highly motivated, team-oriented individuals. The position requires a high school diploma and zookeeping experience. Elephant experience is preferred. A basic understanding of operant conditioning and its application to a protected contact management system is desirable. Responsibilities would include the care and maintenance of two female African elephants in a protected contact situation, as well as care of other species. Salary \$6.69-\$8.83/hr. depending on education and experience, plus excellent benefits. Send resumé to: Jeff Bullock, Lee Richardson Zoo, P.O. Box 499, Garden City, KS 67846. The position will remain open until filled.

**ZOO ATTENDANT**...Blank Park Zoo, City of Des Moines, IA. \$18,360 - \$21,830 annually. Permanent, full-time position with excellent benefits. Performs animal care maintenance and maintenance of exhibits, grounds and facilities of the Blank Park Zoo. Requires high school graduation or GED and one year of experience in the husbandry of agricultural, zoological, or wild animals. Completion of two years college with major coursework in biology, zoology or related natural science may substitute for the one year experience requirement. Possession of a valid motor vehicle license is required. IF SUBSTITUTING COLLEGE EDUCATION FOR EXPERIENCE REQUIREMENT, SUBMIT COLLEGE TRANSCRIPTS AS VERIFICATION. SUBMIT A COPY OF YOUR DRIVING RECORD IF YOU POSSESS A NON-IOWA DRIVER'S LICENSE. Only serious candidates willing to relocate to Des Moines, IA need apply. Reimbursement for interviewing or moving expenses will not be provided. For application materials contact: Civil Service/Personnel Dept., Room 103-City Hall, 400 E. First St., Des Moines, IA 50309, (515) 283-4213. **Application deadline is 6 October 1995.** AA/EOE.

**ANIMAL KEEPER (Oakland Zoo, Oakland, CA)**....full-time, permanent position. This position requires at least six months experience working with animals in a zoo setting. It requires a high school diploma; however a degree in zoology or a related field

is preferred. Operant conditioning, behavioral training and hoofstock experience helpful. Salary \$10.00/hr. Medical, dental, life insurance. Send resumé to: Colleen Kinzley, General Curator, Oakland Zoo, P.O. Box 5238, Oakland, CA 94605.

**ZOO ATTENDANT/Elephants....**requires a minimum of a high school diploma and one year's experience in the hands-on care of African elephants. Responsible for other animals, feeding, observations, cleaning and exhibit maintenance. Send resumé to: Suzanne Moran, Superintendent, Seneca Park Zoo, 2222 St. Paul St., Rochester, NY 14621-1097.

**ZOOKEEPER...**We are seeking an energetic self-starter to work with a wide variety of animals including 85+ sp. of mammals, birds, herps, fish and invertebrates. Applicant must have a working knowledge of the care of exotic animals in a progressive zoo situation; nutrition, husbandry, enrichment, and exhibit design and maintenance. **Minimum qualifications:** college degree preferred; experience working with exotic animals desired; knowledge of current zoo philosophy; willingness to accept responsibility and work with a team. Salary \$5.50/hr; benefits package included. Send resumé to: Randy Scheer, Animal Curator, Folsom Children's Zoo & Botanical Gardens, 1222 S. 27th St., Lincoln, NE 68502. **Closing date is 30 September 1995.**

## Information Please

I am interested in any information on pools for the animals' use in orangutan exhibits. Recommendations on construction, maintenance, durability, cost, benefits, and problems (especially from the keeper's perspective) would be greatly appreciated. Please send all replies to: Maria Schwalbe, Keeper, World of Primates, Philadelphia Zoological Gardens, 3400 West Girard Avenue, Philadelphia, PA 19104.

---

I am seeking information on the use of Oloeresin Capsicum (OC Pepper) spray and if it is used by any zoo staff as a protective device against animal attacks in the normal line of duty. We are assessing OC pepper sprays as a protective device for our keeping staff and the literature that we have received indicates that it has been used by wildlife staff against bears and other carnivores in North America, plus is in use in zoos. If this is so, are there any documented reports that are available to read, as I would like to read some reports on its actual use, other than laboratory reports saying it's effective against a list of animals. Please send any information to: Geoffroy Kidd, Manager Exhibits, Taronga Zoo, P. O. Box 20 Mosman, NSW 2088 Australia

---

Can anyone provide me with any written information on the Swift Fox (*Vulpes velox*)? Please send to: Fran Essex, 5207 Tobacco Road, Hutchinson, KS 67502

---

Please send any information or suggestions for signs concerning animal enrichment or recycling to: Christina Smith, Houston Zoological Gardens, 1513 N. MacGregor Dr., Houston, TX 77030.



# AAZK Membership Application check here if renewal [ ]

Name \_\_\_\_\_

Address \_\_\_\_\_

City \_\_\_\_\_ State/Province \_\_\_\_\_ Zip \_\_\_\_\_

## U.S. Members

**\$30.00 Professional/U.S.**  
*Full-time Keepers*

**\$25.00 Affiliate/U.S.**  
*Other staff & volunteers*

**\$25.00 Associate/U.S.**  
*Those not connected with  
an animal facility*

**\$50.00 or up - Individuals  
Contributing/U.S.**

**\$50.00 or up  
Institutional/U.S.**  
*Organizations / Institutions  
(requires Board approval)*

**International Members**

**\$40.00 International**  
*All members outside U.S. &  
Canada regardless of category*

## Canadian Members

**\$35.00 Professional/Canada**  
*Full-time Keepers*

**\$30.00 Affiliate/Canada**  
*Other staff & volunteers*

**\$30.00 Associate/Canada**  
*Those not connected with  
an animal facility*

**\$55.00 or up - Individuals  
Contributing/Canada**

**\$55.00 or up  
Institutional/Canada**  
*Organizations / Institutions  
(requires Board approval)*

**Library Only**

**\$20.00 Library**  
*Available only to  
established libraries*

Zoo Affiliation (if any) \_\_\_\_\_

Zoo Address \_\_\_\_\_

Title \_\_\_\_\_

Work Area \_\_\_\_\_

My check is enclosed (AAZK, Inc.)  Please charge my credit card

MASTERCARD \_\_\_\_\_ VISA \_\_\_\_\_ Card # \_\_\_\_\_ - \_\_\_\_\_ - \_\_\_\_\_ - \_\_\_\_\_

Name on card \_\_\_\_\_ Expiration Date \_\_\_\_\_

Signature \_\_\_\_\_

Mail this application to: AAZK Administrative Offices, Topeka Zoo, 635 S.W. Gage Blvd., Topeka, KS 66606-2066 U.S.A. Make checks/money orders payable to AAZK, Inc. Must be in U.S. FUNDS ONLY.

Membership includes a subscription to *Animal Keepers' Forum*. The membership card is good for free admission to many zoos and aquariums in the U.S. and Canada.

**of Zoo Keepers, Inc.  
635 S.W. Gage Blvd.  
Topeka, KS 66606-2066  
U.S.A.**

Address Correction Requested

U.S. POSTAGE PAID  
Permit # 646  
Topeka, KS 66603

National Zoological Park 3/76  
N.Z.P. Library  
Washington, DC 20008



*"Dedicated to  
Professional Animal Care"*

L  
76  
598  
12P

# ANIMAL KEEPERS' FORUM

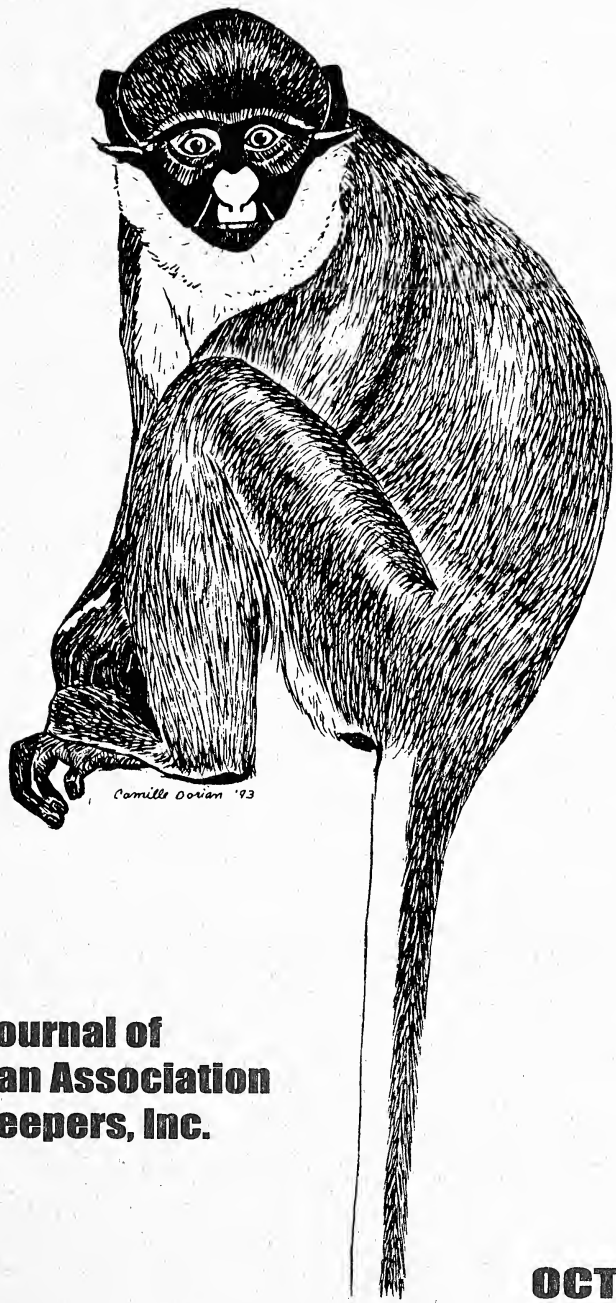

**The Journal of  
the American Association  
of Zoo Keepers, Inc.**

**OCTOBER 1995**

**ANIMAL KEEPERS' FORUM**, 635 S.W. Gage Blvd., Topeka, KS 66606-2066

Phone: 1-800-242-4519 (U.S.) 1-800-468-1966 (Canada) FAX 913-273-1980

**Managing Editor:** Susan Chan

**Associate Editors/Enrichment Options Coordinators:**

Kayla Grams, Arizona-Sonora Desert Museum & Gretchen Ziegler, Sequoia Park Zoo

**Book Review Coordinators:** Melba T. Brown, National Zoo & Andrea Bernee, Chaffee Zoological Garden

**Legislative Outlook Column Coordinator:** Georgann B. Johnston, Sacramento, CA

**October 1995**  
**Vol. 22, No. 10**

Animal Keepers' Forum (ISSN 0164-9531) is a monthly journal of the American Association of Zoo Keepers, Inc. Ten dollars of each membership fee goes toward the annual publication costs of Animal Keepers' Forum. Third Class postage paid at Topeka, KS. Postmaster - Please send address changes to: **American Association of Zoo Keepers, Inc., Administrative Offices, 635 S.W. Gage Blvd., Topeka, KS 66606-2066 - attn: Barbara Manspeaker, Administrative Secretary**

**AAZK Executive Director:** Ed Hansen, AAZK, Inc., Topeka KS

### **BOARD OF DIRECTORS**

Ric Urban, Houston Zoological Garden, Houston, TX 77030

Diane Callaway, Omaha's Henry Doorly Zoo, Omaha, NE 68107-2200

Janet McCoy, Metro Washington Park Zoo, Portland, OR 97221-2799

Alan Baker, Burnet Park Zoo, Syracuse, NY 13204-2504

Marilyn Cole, Metro Toronto Zoo, Toronto, Ontario, Canada M1E 4R5

Lucy Segerson, North Carolina Zoological Park, Asheboro, NC 27203-9416

David Luce, Chaffee Zoological Gardens of Fresno, Fresno, CA 93728-2891

President

Vice President

Immediate Past President

### **COMMITTEES**

#### Nominations & Elections

Chair - Sheri Leavitt, Houston Zoo

#### Conservation, Preservation & Restoration

Chair - Brett Sellers, Metro Washington Park Zoo

#### Annual Conferences

Coordinator - Ed Hansen, AAZK, Inc.

#### Awards

Chair - Anna Michel, Metro Washington Park Zoo

#### Exhibit Design Resource Notebook

Michael Demlong, The Phoenix Zoo

AAZK Inspection Standards Manual — Rachel Watkins Rogers, San Diego Zoo

#### By-laws

Rachel Watkins Rogers, San Diego Zoo

#### Ethics

Mark de Denus, Assiniboine Park Zoo

#### Research/Grants

Vacancy

#### Publications Funding

David Luce, Chaffee Zoological of Fresno

#### AAZK Chapter Logo Products

Jay Christie, Cohanzick Zoo, Bridgeton, NJ

### **MEMBERSHIP SERVICES**

#### L.I.N.K. Coordinator

Mark de Denus, Assiniboine Park Zoo

#### Zoo University List

Mike Illig, Metro Washington Park Zoo

#### Keeper Accommodations List

Todd Cleveland, Denver Zoo

#### Enrichment Committee

Dianna Frisch, Columbus Zoo

International Outreach - Jeanette Beranger, Roger Williams Park Zoo (Chair/Coordinator Technical Assistance); Lesa

Scheifele, Norwich, CT (Foreign Members/Sister Organizations); Lois Johannes, L. A. Zoo (Foreign Member Sponsorship Program); Kathy Kelly, National Zoo - Project M.A.R.C. (Making A Realistic Contribution)

#### Animal Data Transfer Form

Bernie Feldman, Burnet Park Zoo

#### Staff Exchange

Dale Frerking, Kansas City Zoo

#### AAZK Historian

Vacancy

#### AAZK Training Materials - Laura Treschel,

Continuing Education Coordinator, Minnesota Zoo

### **PRESIDENTIAL ADVISORS**

#### AZA Liaison

Ed Hansen, IPP, AAZK, Inc.

#### Bowling for Rhinos

Patty Pearthree, Indianapolis Zoo

#### Elephant Managers Association

Dinah Wilson, Marine World Africa USA

#### CAZPA Liaison

Oliver Claffey, Metro Toronto Zoo

### **AAZK PUBLICATIONS - CONTINUING DATA COLLECTION**

#### Zoo Infant Development Project

Teri Maas/Maggie Liguori, Philadelphia Zoo (Birds/Nonpasserines); Kim Livingstone, L.A. Zoo (Passerines)

Jeanne Bocconelli, Newark Museum Mini-Zoo (Reptiles); Linelle Lone, Denver Zoo (Amphibians)

Diet Notebook, Mammals, Vol. II - Susan Bunn Spencer, Grand Rapids, MI

# Table of Contents

About the Cover/Information for Contributors.....	390
Scoops & Scuttlebutt.....	391 - 392
From the President.....	393 - 394
1995 American Association of Zoo Keepers Awards.....	395 - 397
Coming Events.....	398
Coalition Seeks User Fees to Support Wildlife/Habitat Protection.....	400 - 401
Information Please.....	401
Hand-Raising a Siamang at the Houston Zoo.....	402 - 406
AAZK Announces New Professional/Contributing Members.....	407
Book Review (World of the Coyote).....	408
Florida Panther Shows Severe Lack of Genetic Diversity.....	409
Living Fossils Arrive at San Diego.....	410 - 411
Chapter News Notes.....	411
Legislative Update.....	412 - 414
Hoofstock Nursery Protocol Seminar.....	415 - 418
The Early Introduction of a Hand-Raised Orangutan to a Surrogate Mother.....	419 - 423
Enrichment Options.....	424 - 425
Births & Hatchings.....	425
L.I.N.K. List of Regional Coordinators.....	426
Opportunity Knocks.....	427 - 428
<i>Animal Keepers' Forum Survey</i> .....	<b>CENTER INSERT</b>



## About the Cover.....

*This month's cover art features the Lesser Spot-nosed Guenon (*Cercopithecus buttikoferi*) drawn by Camille Dorian from Monkey Zoo in Orinda, CA. One of the 26 species of guenons, the spot-nosed is native to Africa from Guinea to the Congo and from Zaire north to the Congo River. Guenons live in dominant-male led groups in a variety of habitats from rainforests to open savannahs. Their diet is varied but consists mainly of fruits, leaves, grain, and roots and also may include young birds, bird eggs, small reptiles and insects. Guenons are diurnal and are most active early in the morning and late in the afternoon. Some forms spend nearly all their time in the trees. The tail of young guenons is prehensile, but adults normally use their tails for balancing. While some guenon populations breed throughout the year, there is evidence for reproductive seasonality, with births taking place at the end of the dry season, thereby allowing lactation to proceed when rainfall is high. Twins are born occasionally, but a single young is the rule. Gestation is six months. Thanks, Camille!*

### Information for Contributors

*Animal Keepers' Forum* publishes original papers and news items of interest to the animal keeping profession. Non-members are welcome to submit articles for consideration. Articles should be typed or hand-printed and double-spaced. Articles may be submitted on disk by arrangement with the Editor. All illustrations, graphs, charts and tables should be clearly marked, in final form and should fit in a page size **no greater than 5.5" x 8.5"** (14cm x 22cm). Literature used should be cited in the text (Brown, 1986) and alphabetically in the final bibliography. Avoid footnotes. Include scientific name (as per ISIS) the first time an animal name is used. Thereafter use common name. Use metric system for weights and measurements (standard equivalents may be noted in parenthesis). Use the continental dating system (day-month-year). Times should be listed as per the 24-hour clock (0800, 1630 hrs. etc.). Glossy finish black and white photos **only are accepted**. Color slides should be converted to black and white prints (minimum size 3" x 5" [8cm x 14cm] ) before submission. Clearly marked captions should accompany photos. Please list photo credit on back of photo.

Articles sent to *Animal Keepers' Forum* will be reviewed by the editorial staff for publication. Articles of a research or technical nature will be submitted to one or more of the zoo professionals who serve as referees for *AKF*. No commitment is made to the author, but an effort will be made to publish articles as soon as possible. Lengthy articles may be separated into monthly installments at the discretion of the editor. The editor reserves the right to edit material without consultation unless approval is requested in writing by the author. Materials submitted will not be returned unless accompanied by a stamped, self-addressed, appropriately-sized envelope. Telephone and FAX contributions of late-breaking news or last-minute insertions are accepted as space allows. However, long articles must be sent by U.S. mail. Phone 1-800-242-4519 (US); 1-800-468-1966 (Canada); FAX (913) 273-1980.

Deadline for each regular issue is the 15th of the preceding month. Dedicated issues may have separate deadline dates and will be noted by the editor.

Articles printed do not necessarily reflect the opinions of the *AKF* staff or the American Association of Zoo Keepers, Inc. Publication does not indicate endorsement by the Association.

Items in this publication may be reprinted providing credit to this publication is given and a copy of the reprinted material is forwarded to the editor. Reprints of material appearing in this journal may be ordered from the editor. Back issues are available for \$3.00 each.

# *Scoops & Scuttlebutt*



## **From the Editor's Desk**

Please note that in the center section of this month's AKF is a survey on the journal. Beginning with the July 1995 issue we have been making formatting changes including the size of this publication. We are interested in hearing your comments about what you like, don't like, etc. Please take a few minutes to fill in the survey and return to the address given no later than 1 December 1995. You may complete, fold, and tape the insert closed to mail, or put it in an envelope. We appreciate your input - it is important in our planning for the future of AKF.

## **AAZK Seeks Historian Candidates**

The post of the AAZK Historian is available. Any AAZK member continuing 'in good standing' who wishes to fill this vacancy is eligible and encouraged to apply. This position requires good reporting and records keeping skills; a desire to maintain a history of the AAZK and advise the Board Overseer and/or membership about historical information. Computer skills are desirable in executing this position, but not required. For information about submitting your name for consideration, please contact Board Overseer Diane Callaway at Omaha's Henry Doorly Zoo, 3701 South 10th St., Omaha, NE 68107-2200 or call at (402) 733-8401.

**"Thank You" to Columbus Zoo**—from Bernie Feldman, ADT Form Coordinator  
Burnet Park Zoo, Syracuse, NY

On behalf of the Board of Directors and the AAZK membership, may I extend this most sincere note of gratitude and appreciation to the Columbus Zoo (Powell, OH) which has underwritten the printing costs of the Animal Data Transfer Form for 1995. May I also say "Thank You" to Beth Pohl who was the contact person for this entire undertaking.

The Animal Data Transfer Form (ADT) is a vital document for use whenever an animal is shipped between facilities. It provides an avenue for the transfer of important diet, medical and breeding information between zoo staffs. If you are not already using the ADT Form, please encourage your institution to initiate its use. Forms are available free as a professional courtesy from AAZK and may be ordered by contacting Bernie Feldman, Burnet Park Zoo, One Conservation Place, Syracuse, NY 13204.

## **A Note on 1995 Conference Proceedings**

Be sure to look in the November and December issues of *Animal Keepers' Forum* for the order form for the 1995 Conference Proceedings from the Denver National AAZK Conference. This is the only way in which you may order a copy. All paper presenters who submit a manuscript in the appropriate format for publication will receive a gratis copy, but all others must purchase their copy by order form. The form will contain a list of the papers which will be included as well as any information on workshops or poster sessions which will be part of the Proceedings. The cost is anticipated to be \$25.00 for members and \$40.00 for nonmembers. Orders will be taken **until 10 January 1996**. Orders may be paid for by check, money order or on a Master Card or VISA. Phone orders by credit card only.

## CHAPTER ALERT

Please be aware that Chapter Recharter Packets will be sent out the first week in January and are due back no later than 1 March 1996. A \$50.00 late fee (in excess of recharter fee) will be assessed for those returned after this deadline. So now is the time to start putting together your financial records so you have them in order when the forms arrive. Once you receive the packet, if you have questions contact Barbara Manspeaker at Administrative Offices.

## Orangutan Awareness Week Being Planned

The Orangutan Foundational International has announced that it will be organizing the First International Orangutan Awareness Week (OIAW-1) from November 4-10, 1996. These dates reflect the fact that it was on November 4, 1971 that a young anthropologist named Biruté Galdikas first stepped into the swamps of Tanjung Puting Nature Reserve where she built Camp Leakey and went on to conduct the most intensive and extensive orangutan research and conservation program in the history of science. As a result of her work and her many publications, orangutan behavior, ecology and life histories have become better understood, orangutans in Central Kalimantan have become better protected, and awareness of orangutans and their plight has been increased.

To celebrate Dr. Galdikas's silver anniversary in the field, events will be held at various sites around the country and in all countries where OFI has international chapters. If you would like more information on how to become involved in this celebration, please call (310) 207-1655.

*From Jack A. Brown, Director  
Santa Fe Community College  
Teaching Zoo  
Gainesville, Florida*



Dr. Richard C. Rosen died on 12 August, 1995 after a long battle with AIDS. Born in New York City, he graduated from the University of Denver with his Bachelor's Degree and the University of Vermont with his Doctorate. He began teaching in the Zoo Animal Technology Program at Santa Fe Community College, Gainesville, FL in 1980, and continued until the Fall of 1994. He will be greatly mourned by his zoo colleagues and former students all over the country.



# *From the President. . . . .*

Many thanks to the members of the Rocky Mountain AAZK Chapter as well as the staff and volunteers of the Denver Zoo for being gracious hosts for the 1995 National Conference. It was a time to renew friendships and gain ideas from fellow keepers. AZA has expressed an interest in increasing interaction between our two associations and presented a workshop on why and how recommendations are made concerning the Species Survival Plan.

In July, I asked Ric Urban to be the AAZK representative to the American Federation of Aviculture, Inc. working group meeting concerning the Endangered Species Act and Wild Bird Conservation Act. The impact of the proposed changes on aviculture activities in the public and private sectors was discussed. In August I was invited to speak at the opening breakfast of the Association of Zoo and Aquarium Docents (AZAD) National Conference held in Portland, OR.

Chapter Presidents and Regional Coordinators should have received the AAZK Operations Manual by the first part of October. Many thanks to Ed Hansen and Mark de Denus for spending months compiling the information and to Susan Chan for the final edit. I can truthfully say I'm familiar with every page — it took me awhile to print and assemble the manuals. **Please note: it is mandatory that Chapters maintain a copy in their possession.** A personal goal of mine was to develop a Chair/Coordinator's Handbook and a President's Handbook. These were distributed at the Denver Conference. Many thanks to the Portland Chapter for their financial support of these two handbooks.

As outgoing President, I would like to thank the membership, fellow Board Members, the Executive Director and staff for being a support system to the Association and myself. Special thanks to Vice President Rachél Rogers - we can truly say we worked as a team! I look forward to serving the membership as the Immediate Past President. As always, the Board of Directors is here to serve you, our members.

## ***Keeper Thanks***

*I was asked by AZAD to speak at the opening breakfast of their National Conference in August in Portland. Since many of our zoo keepers work with volunteers in various capacities, I met with a group of keepers to list reasons why we appreciate our volunteers. I spoke for all of us keepers who find working with volunteers can be an enjoyable experience. The text of my address follows:*

“Good morning and welcome to the City of Roses and Elephants! On behalf of the Metro Washington Park Zoo Keepers and those in the United States and Canada who have the pleasure of working with you, I am here to thank you for your support and work at your respective institutions.

In 1975, I began at the zoo as a volunteer in the nursery. To this day I can remember my first assignment - feed the lion cubs. Since lions are one of my favorite animals, you can imagine how thrilled and excited I was. But there was one problem - I hadn't a clue as to what Zooprem® was - do you put it in a bowl or set it on the ground? Do you walk

in with the cubs or lock them outside? Oh, my, all the questions! I think I now have some of the answers.

Being the keeper responsible for the Education Program animals, I have the opportunity to work with many volunteers from animal handling to husbandry tasks. It is exciting to see Zoo Teens develop self-confidence and interpretive skills. Our education programs would not be the success they are without volunteers who are dedicated to instructing others about the wonderful world of animals.

As volunteers, you reinforce our enthusiasm and the reasons why I and many of my fellow keepers chose the zoo keeping profession. You remind us not to take the zoo too seriously and can get us out of that negative arena, this needs fixing and why can't we do this or that, rut where we sometimes find ourselves. You provide another set of eyes for animal observations, and can notice things we see everyday in a different perspective. Volunteers are someone to share ideas with, to help with enrichment and other projects to better the life of animals in our care. A few even offer to help with those animal records. When we think we have most of the answers, you manage to ask questions that make us go hmmm...

We feel that a symbiotic relationship exists between the American Association of Zoo Keepers and the Association of Zoo and Aquarium Docents. We appreciate the time, energy and financial assistance you give to our Bowling for Rhinos Project. Your assistance in helping stage our own conferences contributes to their success. A strong volunteer force reflects the support of the community. As volunteers, you can obtain firsthand experience with the workings of a zoo and we hope an appreciation of the wide diversity of animals. Those of you who assist keepers can go home with a perfume that you can't purchase anywhere in a store.

When the other keepers and I met to discuss things to mention in our thank you, I was told not to forget one very important item - thanks for feeding us. Again, from zoo keepers everywhere, we thank you for caring and appreciate all that you do for us and our institutions."



Janet McCoy, AAZK, Inc. President  
Metro Washington Park Zoo, Portland, OR



The following awards were presented at the 22nd National AAZK Conference held in Denver, CO from 24-28 September 1995. The Jean M. Hromadka Excellence in Zoo Keeping Award is selected by the AAZK Awards Committee from nominations received from the membership. Anna Michel, Metro Washington Park Zoo, Portland, OR chaired the Awards Committee this year. The Certificates of Recognition and Appreciation are given by the AAZK Board of Directors. The Excellence in Journalism Awards are selected by the editorial staff of *Animal Keepers' Forum*.

### **The Jean M. Hromadka Excellence in Zoo Keeping Award Recipient**

*In recognition of her professional attitude, true dedication, superb application of animal husbandry practices and contributions to the welfare of the animal life placed in her charge, AAZK presents the following individual with this award:*

**Mona Keith, Calgary Zoo, Botanical Garden & Prehistoric Park  
Calgary, Alberta, Canada**

*Specifically noted were her volunteer work, efforts in husbandry, conservation and education, as well as her work with Red Pandas.*

### **Certificates of Recognition and Appreciation Recipients**

*These awards are given by the AAZK Board of Directors to individuals or groups who have provided volunteer efforts and/or services to the Association. Certificates of Appreciation are to recognize those outside of the Association and Certificates of Recognition acknowledge contributions made by AAZK members on Association projects.*

### **Certificate of Recognition Recipients**

**Susan M. Barnard, Zoo Atlanta, Atlanta, GA**

*in recognition of her service as Chair of the AAZK Research Grants Committee*

**David Luce, Chaffee Zoological Gardens of Fresno, Fresno, CA**

*in recognition of his service as Chair of the Publications Funding Committee*

**Tom Aversa, Franklin Park Zoo, Boston, MA and**

**Melba T. Brown, National Zoological Park, Washington, DC**

*in recognition of their service as Book Review Coordinators for Animal Keepers' Forum*

**Phyllis Nilson-Wojcik, formerly of John Ball Zoo, Grand Rapids, MI**  
*in recognition for her service as Legislative Advisor to AAZK, Inc.  
and Animal Keepers' Forum*

**Ed Hansen, Reid Park Zoo, Tucson, AZ and  
Mark de Denus, Assiniboine Park Zoo, Winnipeg, MB, Canada**  
*in recognition for their service as Co-Editors/Coordinators of the  
AAZK Operations Manual*

**Rachél Watkins Rogers, San Diego Zoo, San Diego, CA**  
*in recognition of her service on the AAZK Board of Directors  
from January 1992 until October 1995*

**Mark de Denus, Assiniboine Park Zoo, Winnipeg, MB, Canada**  
*in recognition of his service on the AAZK Board of Directors  
from January 1992 until October 1995*

**Todd Cleveland, Denver Zoological Gardens, Denver, CO**  
*in recognition of his service as Chair of the 22nd National AAZK Conference*

**Sheila Lindquist, Linelle Lone, Susan Nolan, Karen Stern and Ann Zobrist**  
**Denver Zoological Gardens, Denver, CO**  
*in recognition of their service on the 1995 Conference Committee Board of Directors*

### **Certificate of Appreciation Recipients**

**Denver Zoological Gardens, Denver, CO**  
*in appreciation for serving as the Host Institution for the  
22nd National Conference of the American Association of Zoo Keepers, Inc.*

**Columbus Zoological Gardens, Powell, OH**  
*in appreciation for their underwriting of the printing of  
the 1995 Edition of the Animal Data Transfer Forms*

### **Distinguished Service Plaque**

*was presented to*  
**Rocky Mountain Chapter AAZK**  
*for their service as Hosts of the 1995 AAZK National Conference*

## Excellence in Journalism Awards

*Outstanding Recognition: "A Lightweight, Easily Disinfected  
Shift Box for Venomous Snakes"*  
**Chuck Smith, West Columbia, SC**

*Outstanding Recognition: "Managing Herps in an Aquarist's World"*  
**Rico Walder, Tennessee Aquarium, Chattanooga, TN**

*Outstanding Recognition: "Creating a Mixed Exhibit of  
Ringtail Lemurs and Ruffed Lemurs"*  
**Kelley Bollen and Margaret Louer, Burnet Park Zoo, Syracuse, NY**

*Outstanding Recognition: "Exhibiting Alcids"*  
**Rick Smith, Sea World of Florida, Orlando, FL**

*Outstanding Recognition: "Application of Confined Contact of Giraffes"*  
**Ruby M. Lara, Sacramento Zoo, Sacramento, CA**

*Outstanding Recognition: "The Black-Footed Ferret Breeding  
Program at Metro Toronto Zoo"*  
**Ariel Shamir, Metro Toronto Zoo, Toronto, Ontario, Canada**

*Outstanding Cover Art: Jaguar (Panthera onca)*  
**Stacy L. Palm, Arizona-Sonora Desert Museum, Tucson, AZ**

---

---

Complete Line of Quality Herptile and Small Animal Supplies



We specialize in providing our customers  
with professional, personally researched products.  
Learn from our experience!

**Call for Free Catalog!**

VISA and Mastercard Accepted

32514 Ne 77th St.  
Carnation, WA. 98014-6701

Phone (206) 861-7964  
Fax (206) 333-4205

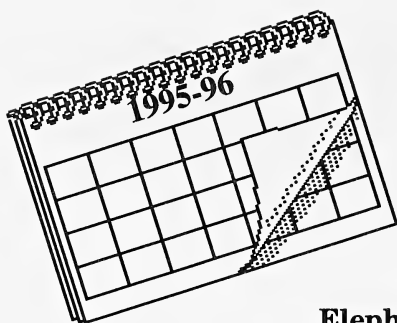

# Coming Events

## The 16th Annual Elephant Managers Workshop

October 10-14, 1995

Tacoma, WA

Headquartered at the Tacoma Inn. Presented by the Pt. Defiance Zoo & Aquarium and the Elephant Managers Association. For further information contact: Bruce Upchurch or Sally LaTorres, Point Defiance Zoo & Aquarium, 5400 N. Pearl St., Tacoma, WA 98407-3218, (206) 591-5337, ext. 154.

## Association of ZooVeterinaryTechnicians 15th Annual Conference

Oct. 30 - Nov. 2, 1995

Baltimore, MD

To be held at the National Aquarium. Conference will include sessions on reptile, avian, primate, hoofstock and aquatic medicine, immobilization, hematology, clinical and gross pathology, hospital techniques, and case reports. In addition, there will be a wet-lab. For more information contact: Jenni Jenkins, LVT, National Aquarium in Baltimore, Pier 3, 501 E. Pratt St., Baltimore, MD 21202; tel: (410) 659-4256; Fax (410) 576-1080.

## The Annual International Small Felid Workshop

December 4-6, 1995

Las Vegas, NV

Co-sponsored by the San Diego Zoo and S.O.S. Care. For further information, contact Pat Quillen, 15453 Woods Valley Road, Valley Center, CA 92082. PHONE: (619) 749-3946 FAX: (619) 749-1324.

## 1996 AZA REGIONAL CONFERENCES

Central Regional - Feb. 28-March 2, 1996 - to be held in New Orleans, LA. For further information contact Craig Dinsmore, Audubon Zoo, P.O. Box 4327, New Orleans, LA 70178 (504) 861-6112.

Eastern Regional - April 10-13, 1996 - to be held in Greenville, SC. For further information contact Bob Wilson, Greenville Zoo, 150 Cleveland Park Dr., Greenville, SC 29601 (803) 467-4300.

Western Regional - May 15-18, 1996 - to be held in Denver, CO. For further information contact Angela Baier, Denver Zoo, 2300 Steele St., Denver, CO 80205 (303) 331-5805.

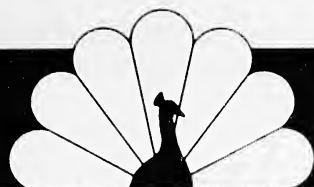

## Quality exotic animal diets

# SPECTRUM

**Nutritionally balanced**  
**Fixed formulation • Economical**

When you need a complete line of high-quality dry and frozen animal diets for your feeding program, call Animal Spectrum.

**NEBRASKA BRAND**



*Frozen feline diets*  
*Frozen bird of prey diets*  
*Frozen canine diet*  
*Chunk and chopped horsemeat, hearts, livers, rib, shank, knuckle bones, and tailbones*



*Banana flavored psittacine/primate, 20% protein, dry*  
*Banana flavored primate, Pro-Plus 25% protein dry*  
*Leaf Eater primate dry*      *Omnivore dry*  
*Llama Vitamins & Minerals dry*      *Polar Bear dry*  
*Marmoset/Tamarin dry*      *Ratite dry*  
*Hoofstock supplement, with Selenium dry*

## BROOD-RITE HEATERS

*Bulbless heaters—nothing to break*  
*Safe around all animals and bedding material.*  
*Even heat distribution in 240, 500, or 750 wattages.*

### **One call does it all**

TOLL FREE **1-800-228-4005**

**FAX 308-534-7015**

*Animal Spectrum, Inc.*  
*P.O. Box 721*  
*North Platte, NE 69101-0721*

Over 100 conservation and recreation groups and businesses are championing a national effort to prevent declines of fish and wildlife, to ensure high quality outdoor recreation, and to meet the rising demand for conservation education.

The Fish & Wildlife Diversity Funding Initiative, heralded as Teaming With Wildlife, offers a simple, proven mechanism to raise \$350 million annually that will return to state fish and wildlife agencies for the three-fold purpose of conservation, recreation and education.

It is a natural investment. By paying a very small user fee on a wide range of outdoor equipment, from binoculars to camping gear, everyone who has a stake in a wildlife-rich outdoors will benefit.

What's been done once can be done again. For more than half a century, hunters and anglers have paid user fees on equipment through the Sport Fish & Wildlife Restoration



## TEAMING WITH WILDLIFE

Acts. Those dollars have funded the restoration of the white-tailed deer and striped bass, as well as the conservation of millions of acres of habitat.

Yet, as more people seek the outdoors for pleasure and solace, the pressures on wildlife and their habitats are increasing dramatically. We are seeing declines of familiar songbirds like the meadowlark and wood thrush. Wildlife watchers are experiencing elbow-to-elbow crowds. The need for nature centers, watchable wildlife interpretation, and educational materials for teachers has never been greater.

With your help, we can achieve a vision of wildlife watching experiences across America, from backyards to refuges: of proactive conservation that reverses declines of wildlife before they reach the endangered state; and of an informed citizenry who cares about the future of wildlife and habitats.

Join Team Wildlife! You can help by using your buying power as a consumer. Write letters to outdoor equipment manufacturers and retailers, such as REI, LL Bean, Coleman and Pentax. Tell them you want to invest in conservation through a dedicated user fee.

Coalitions are forming in most states. For more information on the initiative and a list of companies, please contact the International Association of Fish and Wildlife, 444 N. Capitol Street, NW, Suite 544, Washington, DC 20001. (201) 624-7890, or your closest state fish and wildlife agency headquarters.



**EDITOR'S NOTE:** Among the 100+ organizations which are part of the Teaming With Wildlife Coalition are the following:

American Bird Conservancy  
Audubon Naturalist Society  
Center for the Study of Tropical Birds  
Environmental Defense Fund  
National Audubon Society  
North American Wolf Society  
Sierra Club  
World Wildlife Fund

American Ornithologists Union  
Bat Conservation International  
The Conservation Fund  
Humane Society of the U.S. Int'l  
National Wildflower Resource Cntr.  
National Wildlife Federation  
The Wildlife Society  
The Wildfowl Trust of North America

**\*\*All 50 State Fish and Wildlife agencies are members of the Coalition**

## Information Please

Desperately seeking information on diets for a diabetic chimpanzee (*Pan troglodytes*). Any information or ideas on where I can get information is needed. I have exhausted all avenues so far. Please contact Virginia Brauer at Animal Haven FAX (805) 867-2576.

---

The Oakland Zoo, Oakland, CA is currently building a new, large Malayan sun bear habitat to house 1.1 sun bear. We would like to include a variety of "bear-proof" mechanical enrichment devices in the exhibit. Any plans for proven devices and/or conceptual ideas will be appreciated. Please include any food scattering or dispensing mechanisms as well as auditory and olfactory devices and environmental conditioners (mistifiers, heaters, etc.). Please send information or suggestions to: The Oakland Zoo, c/o Amy Burgess, Enrichment Committee, 9777 Golf Links Road, Oakland, CA 94605.

---

I would like to correspond with other keepers and facilities about a viable alternative for public feeding of black bears and white-tailed deer. We would like to have any information on: why your facility ended public feeding; how your facility keeps the animals visible; what things can be done to enrich habitat environments; and, problems associated with the transition from public feeding to non-public feeding. If your facility currently allows public feeding, we would be interested in knowing what types of food you allow, how often the animals are fed by the public, and how much food the animals receive. Contact: Eddie Clark, Habitat Manager, Grandfather Mountain, Inc., P.O. Box 129, Linville, NC 28646.

---

I am researching the training of American river otters (*Lutra canadensis*) using operant conditioning for management and enrichment purposes. Any information regarding otter training in a zoo setting will be greatly appreciated. Please send to: Sue Barker, c/o The Oakland Zoo, 9771 Golf Links Road, Oakland, CA 94605.

# ***Hand-Raising a Siamang at the Houston Zoo***

*By Christina M. Smith, Zoo Keeper  
Houston Zoological Park, Houston, TX*

## **Background**

Muggette is a hand-raised adult siamang (*Hylobates syndactylus*) at the Houston Zoo. She was housed with her brother for the first 15 years of her life. Her brother was shipped out and a four-year-old male siamang took his place. Muggette and this new male, Boomer, seemed to form a mother/son relationship and sexual behavior was never observed. When Boomer was six years old he was shipped out, but returned within three months. Immediately upon reunion, Muggette presented to Boomer and he mounted her, but copulation did not take place. For the last three years no sexual activity between the two has been observed. On 9/08/93, the two siamangs were sedated for a move to a new exhibit. During a routine physical, a large and hard mass was felt in Muggette's abdomen. She was radiographed and it was a real surprise to see an almost full term fetus.

Muggette was 20 years old and had never given birth. It was thought that she may have lost the flexibility in her pubic symphysis and would have a difficult delivery.

On 13/09/93 it was apparent the Muggette was in labor. Her water broke, she had a bloody discharge, and with each contraction her vulva extended. The International Center for Gibbon Studies and the veterinarian at the Gladys Porter Zoo warned that captive siamangs usually give birth at night and zoo personnel rarely see any signs of distress beforehand. When Muggette's condition had not changed eight hours later, the veterinarian decided to sedate her and do a Cesarean section. "Jocama", a female, was delivered 13/09/93 weighing 588 grams. The infant was blue due to a knot in the umbilical cord and her head was flattened from the force of the contractions. The infant was immediately placed in an incubator and rubbed to increase circulation. Soon she stabilized and passed the meconium. Muggette recovered normally from surgery.

## **Introduction to the Mother**

The morning after her birth, the infant was shown to Muggette. She appeared interested and licked the infant's head. At 1530 hrs. Muggette was put back into her original cage. One hour later, the infant was put in with her. The infant distress called for five minutes, but the mother showed no interest. Late in the afternoon on 16/09/93, the infant was fed in front of Muggette, who was interested briefly then ignored the infant. The infant showed no reaction toward Muggette. When it became apparent that Muggette was not going to raise her baby, phone calls were made to other zoos looking for a siamang surrogate mother.

## **Health Care of the Infant**

To prevent the spread of zoonotic diseases, everyone near the infant was instructed to wear a mask and gloves at all times.

The infant was given a toy gorilla (46 x 30 cm) to serve as a surrogate mother. She was kept in an incubator set between 90-99°F with the humidity kept fairly high. As she got older, the incubator temperature was gradually decreased until it reached room temperature. At five weeks of age she was put into a "playpen" (95 x 61 x 66 cm) which was actually a broken incubator with a clear lid.

Her temperature and weight were taken at the same time every morning. We also recorded how she was eating and whether or not she was defecating and urinating normally. A soft gauze moistened with warm water was used to stimulate her to urinate and defecate. After three days she had her first bowel movement on her own, in the middle of the night, at which time we stopped stimulating her.

## **Feeding**

The first two feedings consisted of 4-5 ml warmed Pedialyte™. Then every two hours she was offered 5 ml 1:1 liquid Similac With Iron™ to Pedialyte™ (Table 1). After approximately one week we switched her to No Iron Similac™ because she was constipated. Since she required such a small amount of formula we switched from using the liquid form to the powdered form so we could make just enough formula for the day, thus it was always fresh.

At first she had problems suckling, so a syringe with a French or urethral catheter was used and she learned to bite or chew then lap up the formula. When her appetite increased, we switched her to a regular infant nipple and she quickly learned to suck. Care was taken that the nipple hole was very small to prevent the aspiration of milk. Milk should not drip out of the bottle when inverted, if it does the hole is too large.

She seemed to prefer the formula very warm. Often the bottle was reheated during feedings to stimulate her to finish. She was always fed sitting up, as she would have been if suckling on her mother. She was burped halfway through the bottle and again at the end. After three days she was sucking aggressively at each feeding.

Initially the amount of formula offered daily was based on 10% of her body weight. The formula was then increased by 1 ml per feeding (approximately 20% of body weight) when the infant's weight stopped increasing.

## **Hand-raising**

From day one we used a gorilla toy as a surrogate mother. Initially we never took the infant off of the surrogate; we hoped that this would prevent her from bonding with us, although we did touch and groom her during and after feedings. She constantly rooted around on the surrogate and often times found herself underneath it or tangled up in blankets. This would usually start her screaming as if distressed or agitated.

She stayed at the veterinary clinic during the day and the veterinary staff (10 people) took turns feeding her. At night she was brought home (with her incubator) with one of the five primate keepers assigned to her nighttime feedings.

She started sucking her thumb (and sometimes her toes) at two days old. She would suck on a pacifier if it was put in her mouth but, if she dropped it, she was unable to find it. Sometimes during feedings (25-30/9/93) she would chew on the nipple more than

suck. She was probably teething, so we sewed a pacifier onto the surrogate's chest. She figured out where it was very quickly and sucked and chewed on it continuously. Whenever she became apprehensive about something she would always suck on the pacifier for security. We also gave her a teething ring (sometimes cold) that we could securely attach around the surrogate's arm. (To prevent strangulation, the teething ring should be smaller than the infant's head.) She liked to lick on the ring, but preferred the pacifier.

A second surrogate was used as a backup when the original surrogate was being washed. Although the other surrogate was different (but about the same size and also with a pacifier), she accepted it readily.

When she was one week old, we decided to start exercising her in preparation for introducing her to an actual surrogate siamang. She didn't cling very tightly to the surrogate when we picked it up for weighing, etc. Every two hours (in between her feeding schedule) we would pick her surrogate up and move it around in such a way that she would have to hold on tight. She seemed to have no fear of falling; she would let go whenever she got tired. At two weeks of age it was obvious that she had bonded with the human primates, so we began taking her off the surrogate and making her cling to us as we moved about (she was still fed on the surrogate).

At five weeks of age she was moved out of the incubator and into a "playpen" (95 x 61 x 66 cm). The playpen had a clear lid which allowed her to see a fairly busy area giving her much visual stimulation.

Unfortunately, we could carry her around for only about 15 minutes every 2-3 hours, so we hung her surrogate a few inches off of the ground inside her playpen for varying intervals (10-25 minutes) so that she would have to climb up and cling to it to suck on her pacifier. At home we would hang the surrogate on a doorknob. This worked fairly well, but initially she had a hard time holding on because the surrogate had very short fur. We sewed long (2.54 cm) fake fur onto the surrogate so that she would have something to hang onto. This worked well except that she could pull out the fur easily (even after several washings). She ingested a lot of it and we were worried that her intestines could get impacted, so one week later we removed the fur.

By this time we could already see a dramatic improvement in her coordination and strength. At this point she started moving a few inches away from the surrogate for short periods. We continued to hang the surrogate up and soon added some large branches for her to play on. One branch stretched all the way across the top of her playpen. She seemed fascinated with this branch and was soon straining to reach it. At six weeks she was holding onto it, and a few days later she was doing pull ups on it. At eight and a half weeks she attempted brachiating, by nine weeks she was brachiating from one end of her play pen to the other. She still seemed very attached to her surrogate during this time, still taking naps on it and sucking on her pacifier for comfort.

For enrichment, we gave her balls of paper and paper bags to play with, which she liked to taste and scratch with her fingernails to make noise. We also took her outside on warm days and, when indoors, let her watch a fish tank.

## **The Perfect Surrogate**

The Milwaukee County Zoo housed Suzy. Suzy was the oldest captive siamang at 41

years old and had had 11 pregnancies. Unfortunately only four survived. Last August, she finished being the successful surrogate mother to a spider monkey. At 10 weeks of age we decided to take Jocama to the Milwaukee County Zoo to meet Suzy. A transport problem developed because Jocama was still too young to fly cargo and commercial airlines do not allow non-human primates in with the other passengers. Our problem was solved when a Houston Zoological Society member donated his Lear Jet and pilot to take us to Chicago.

At the Milwaukee County Zoo, a zoo keeper simply went into Suzy's cage with Jocama and sat on the floor holding her. It didn't take long for Suzy to come over and take the infant. Suzy sat on the floor for a long time while Jocama slept in her arms. Jocama had very little problem adjusting to Suzy except when she wanted to explore her new surroundings. This surrogate didn't let her go and this frustrated Jocama a bit. At the first feeding Suzy wasn't so sure about letting anyone too close to her and her new prize. But with patience and determination Suzy was convinced that we weren't going to take the baby away. Soon Suzy allowed the zoo keepers to feed and examine the infant regularly. By the end of the first day, Suzy was brachiating and swinging around her cage and Jocama was able to cling onto her with no problem, although she was a little wide eyed.

## **Discussion**

We feel that the introduction to Suzy went well, not only because of Suzy's wonderful personality, but because Jocama was used to so many different people and ways of being held that Suzy was simply another (although hairier) caretaker. Jocama never bonded with just one person, as she had many caretakers. Watching Suzy move about the cage we were very glad that we exercised and prepared Jocama for such movements. Below is a list of suggestions to consider for future hand-rearings.

## **Surrogate**

1. Put a tightly closed hot water bottle inside the surrogate to provide more comfort for the infant. The bottle could be reheated at each feeding.
2. If possible, use a life size toy surrogate with species specific fur length (check that fur does not pull out easily). This infant outgrew her toy surrogate quickly.
3. Sew shredded rags instead of fake fur to the surrogate (with short fur) to enhance clinging response. Rag material should not fray or be so long that the infant can get tangled in it. This technique has been discussed at the Houston Zoo, but never tested.

## **Health Care**

1. Have a written protocol outlining (in great detail) what is expected for all infant caretakers. This will avoid misunderstandings, etc. Although variation can be a good thing, too much can be detrimental.
2. Introduce infant to adult food so smell and tastes will be familiar. Jocama was never given adult food, so these smells were also new to her in Milwaukee, increasing possible stress.

3. When initiating defecation and urination, don't stimulate with wet gauze, instead gently knead belly and barely touch genitals and anus. Primates rarely lick their young, instead they are more tactile.

### Stimuli

1. Hang up a mobile, set infant close to a fish tank, or give the infant a rattle.
2. If the infant is healthy, keep the infant at the primate house so it can hear, see, and smell others of its species. If this is not feasible, one could play tapes of species specific calls, play video tapes, or take the infant to areas periodically to view conspecifics.

### Acknowledgments

I would like to thank the Houston Zoo primate staff and the veterinary staff for all the suggestions, ideas, and concerns raised during this experience. I would also like to thank Lynn Kilam for reviewing this paper and giving me editorial advice. Thank you to the Gladys Porter Zoo and the International Center for Gibbon Studies for sharing your siamang experiences. A very special thank you goes to the primate staff at the Milwaukee County Zoo for their wonderful work with Suzy and Jocama.

---

**Table 1. Feeding and Weight Chart up to 12 weeks**

age (weeks)	formula (ml/feeding)	feeding interval (hours)	weight (g)
1	13	2	652.0
2	16	3	699.0
3	16	3	757.6
4	20	3	766.1
5	22	3	802.2
6	29	4	830.7
7	30	4	835.7
8	30	4	869.3
9	30	4	940.1
10	35	4	935.0
11	35	4	1009.2
12	38	4	1020.0

---

*Reprinted from the Proceedings of the 21st. National Conference of the American Association of Zoo Keepers, Inc. Omaha, Nebraska October 9-13, 1994.*

# AAZK Announces New Professional & Contributing Members

Joy Williams, no zoo listed **Bloomfield, NJ**; Scott Gunther and Robin Beth Sobelman, **Bronx Zoo (NY)**; Kenneth Billin, **Pittsburgh Zoo (PA)**; Dianna Rubly, **Discovery Island (FL)**; Laura Gleason, **Lion Country Safari (FL)**; Robert D. Brock, **Nashville Zoo (TN)**; Millicent W. Ross, **Knoxville Zoo (TN)**; Judy Stephens, **Detroit Zoo (MI)**; Stephanie Coryell, **Blank Park Zoo (IA)**; Mary Schmidt, **Henry Vilas Zoo (WI)**; Robert Beaupre, **Lake Superior Zoo (MN)**; Jennifer Timmel, **Lincoln Park Zoo (IL)**; Jennifer Weekley, **Niabi Zoo (IL)**; Ned D. Warner, **Kansas City Zoo (MO)**; Misty Mitchell, **Dickerson Park Zoo (MO)**; Tanya Tims, **Topeka Zoo (KS)**; Kelly P. Schroer, **Lee Richardson Zoo (KS)**; Chuck Pond, **Omaha's Henry Doorly Zoo (NE)**; Jenny B. Preamuk, **Audubon Zoo (LA)**; Frankie Lindsey and Bruce Burch, **Caldwell Zoo (TX)**; Tonya Boyd, **Moody Gardens (TX)**; Dawn Neptune, **Utah's Hogle Zoo (UT)**; Kristin Zabawa, **Los Angeles Zoo (CA)**; Christine Eddy, **Sea World of California (CA)**; Becky Leinenwever, **Metro Washington Park Zoo (OR)**; and Craig Moran **Washington Zoological Park (WA)**.

## New Contributing Members

Gabrielle Feldman, Pullman, WA

## Renewing Contributing Members

Jeanette Rilling, Exotic Animal Rescue,  
Ottsville, PA

Philip E. Foster, Memphis Zoo,  
Memphis, TN

Dan Kohl, The Larson Company,  
Tucson, AZ

# THE GOURMET RODENT™



## RATS AND MICE

Bill & Marcia Brant  
6115 SW 137th Avenue  
Archer, FL 32618  
(904) 495-9024  
Fax (904) 495-9781

© All Rights Reserved

## Need to Reach AAZK?

1-800-242-4519 (U.S.)

1-800-468-1966 (Canada)

FAX: (913) 273-1980

or write

AAZK, Inc.

635 S.W. Gage Blvd.

Topeka, KS 66606-2066  
U.S.A.



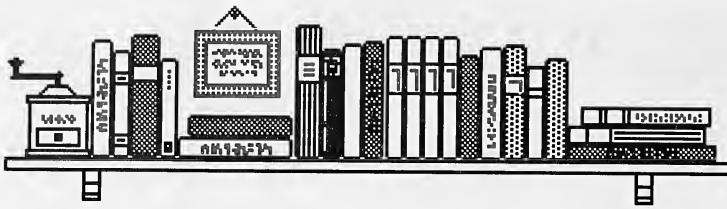

# Book Review

## **The World of the Coyote**

Text by Wayne Grady  
Sierra Club Books, 1994  
100 Bush Street, San Francisco, CA  
Hardback 143 pgs. \$25.00

*Review by Taylor Edwards  
Keeper-Mammalogy/Ornithology  
Arizona-Sonora Desert Museum  
Tucson, AZ*

A lone coyote howls as the sun sets over the Tucson Mountains. I stop hiking and pause to listen and contemplate its song. The coyote is as much a part of the Sonoran Desert as the dry heat and tall, columnar cactus. These elusive and mysterious creatures are here to stay, despite all attempts to eradicate them. The World of the Coyote sheds some light on the plight of these curious survivors.

The World of the Coyote is a large format, Sierra Club coffee table book with glossy pages and 72 full-color photographs. From cute, heartwarming shots of pups to teeth baring, blood-stained portraits, a variety of photographers detail the many facets of coyote life. Wayne Grady's text is clear and concise which is necessary for the light reading and skimming usually associated with a primarily picture book. However, he does not let this weaken the content as he covers risky subjects like predator control and human connections with nature.

The book is broken down into three parts. Part One focuses on "Coyotes and Nature". Citing various studies, Grady gives a comprehensive overview of coyote natural history. It is clear when his text is written as personalized opinion versus accredited scientific fact and he stays true to both modes of information. At times he is anthropomorphic, but appropriately so. He makes a few statements such as, "Sometimes coyotes howl for the sheer joy of self expression" and used words like "shy", but the picture he paints is positive, avoiding the common misconceptions of coyotes being "slinking" and "sulking".

Part Two, entitled "Coyotes and Us", bridges a time span from the Aztec and native American legends through the predator control programs that continue today. Since the mid-1800's as settlers moved west, coyotes have been exterminated along with wolf, bison, prairie dogs, Native Americans, and anything thought to be a competitor with game and cattle. Grady explores controversial territory as he describes the methods Animal Damage Control (ADC, now "Wildlife Services") uses in exterminating coyotes. "In 1992 alone, ADC 'biological science technicians' killed 97,966 coyotes...as 'nuisance animals'." Grady boldly gives gruesome descriptions of the inhumane methods still used to trap and kill coyotes. This section is accompanied by disturbing photos of a coyote in a leg-hold trap and a carcass hung from a barbed wire fence.

The final section is on "Coyotes and Common Sense". Grady calls for a re-examination of our national policy in managing wildlife; "Abuses seem almost to have been built into the legislation". He gives feasible alternatives to avoid coyote predation on livestock



# ***Animal Keepers' Forum Survey***

To help the AKF staff better meet the needs and desires of the membership through the journal, we would appreciate your filling out the following questionnaire and returning it to us **by 1 December 1995**. Your input will help us determine both future content and format changes. Use extra paper is necessary. Thank you for your cooperation.

1. How long have you been a keeper? a. 1-5 yrs.    b. 6-10 yrs.    c. 11-15 yrs  
(Please Circle Response)    d. 16-20 yrs.    e. over 20 yrs

If you are not a keeper, what is your position? \_\_\_\_\_

2. How long have you been reading AKF? (Please Circle Response)

a. less than 1 yr.    b. 1-5 yrs.    c. 6-10 yrs.    d. 11-15 yrs.    e. over 15 yrs.

3. In what state/province/country is your facility located? \_\_\_\_\_

4. Do you read your monthly AKF? a. always    b. sometimes    c. rarely

5. Of the numerous regular and semi-regular sections of AKF, how do you rate the frequency with which you read the following? (Please Circle Response)

	<b>Always</b>	<b>Sometimes</b>	<b>Rarely</b>
Scoops and Scuttlebutt	1	2	3
Births and Hatchings	1	2	3
Coming Events	1	2	3
Chapter News	1	2	3
Book Reviews	1	2	3
Legislative Update	1	2	3
Information Requests	1	2	3
Opportunity Knocks	1	2	3
Viewpoint	1	2	3
From the President	1	2	3
DOWN UNDER	1	2	3
Enrichment Options	1	2	3
Husbandry Articles	1	2	3
Research Articles	1	2	3
Narrative Articles	1	2	3

6. Do you feel there is enough information in AKF about what is happening in AAZK to keep you informed about your Association? (Please Circle Response)

YES

NO

NO OPINION

If NO, please let us know what kinds of information you would like to see published about AAZK and its activities. \_\_\_\_\_

7. Of the wide variety of articles printed in AKF, including research, husbandry, narrative and short articles, which do you enjoy most or find most helpful? (Please elaborate) \_\_\_\_\_

8. Are you still finding the Enrichment Options column helpful? What changes would you like to see in this column? \_\_\_\_\_

9. Do you find the Births & Hatchings column useful? Can you easily extract information? Should we continue this column? \_\_\_\_\_

10. Do you find the Legislative Update column informative and helpful in keeping you aware of current legislative trends concerning wildlife? YES NO  
If NO, why and how can we improve this column? \_\_\_\_\_

11. Over the past 3 years, what is your rating of the quality of cover art?  
Excellent Fair Poor

How would you improve it? (Please offer suggestions for improvement) \_\_\_\_\_

12. Do you find the Table of Contents helpful? YES NO NO OPINION

13. Regarding the recent format changes in the AKF, how do you view these changes? POSITIVE NEGATIVE NEITHER

Please give detailed comments below:

Use of Two-color \_\_\_\_\_

Larger Size \_\_\_\_\_

Print Style & Size \_\_\_\_\_

New Graphics \_\_\_\_\_

14. How would you rate the job being done by the editors in putting together the AKF and in covering topics of interest to the membership?

Formatting of AKF	<b>Excellent</b>	<b>Good</b>	<b>Fair</b>	<b>Poor</b>
Contents of AKF	<b>Excellent</b>	<b>Good</b>	<b>Fair</b>	<b>Poor</b>
Grammar/Spelling	<b>Excellent</b>	<b>Good</b>	<b>Fair</b>	<b>Poor</b>

15. If you could change any part of AKF, what would you change and why?

---

---

16. Please add any further comments about the present state and future possibilities for AKF.

---

---

Please return this survey **by 1 December 1995** to:

AKF Survey/AAZK  
635 S.W. Gage Blvd.  
Topeka, KS 66606-2066  
USA

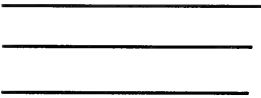

Place First  
Class Stamp  
Here

**AKF Survey/AAZK  
635 S.W. Gage Blvd.  
Topeka, KS 66606-2066  
U.S.A.**

**FOLD AND TAPE SHUT HERE - DO NOT STAPLE**

and makes clear the scientific proof that, "Coyotes have caused relatively little damage to wildlife or livestock". Grady addresses the underlying root of the issue which is truly how humans' destructive view of nature is what needs to be controlled, not coyotes. His ending note is that the most important change we need to make is learning our own place in nature.

Grady has complemented the allure of beautiful photography and an interesting subject with a responsible message and good, factual information. The World of the Coyote is a pleasant change from the usual portrayal of wildlife. We tend to focus our attention on the endangered animals in the world which are either pitifully doomed or reliant on human management. Perhaps we should also pay attention to the success stories. Despite every attempt to eliminate this beautiful, majestic animal, it has survived and, in fact thrived, in the face of human opposition. It is with insight into this species, so close to home, that we learn humility and our true place in nature; not as controller but as a co-inhabitant of this little blue planet.

---

## Florida Panther Shows Severe Lack of Genetic Diversity in Remanent Populations

Low numbers are the least of the Florida panther's problems. Florida panther's have been in trouble for several years. Their range once covered the Southwest, but by the 1920s land development and hunting had reduced the subspecies to a small isolated population. The panther was listed as endangered in 1967; today, fewer than 50 animals roam south Florida, including Everglades National Park. The Florida group is one of some 30 subspecies of puma found in North and South America.

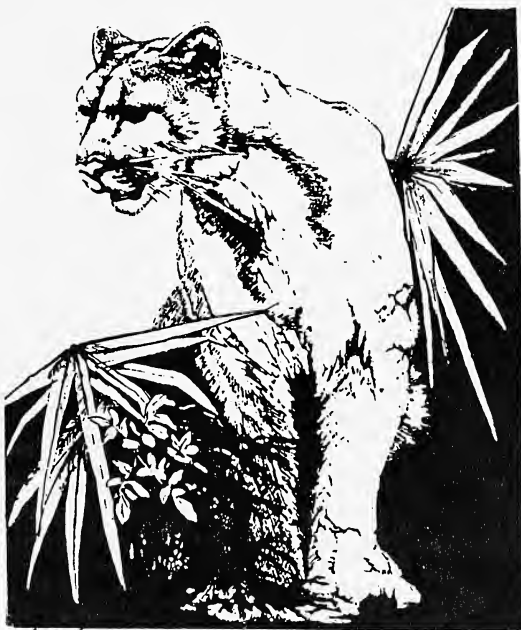

Biologists have estimated that the panthers could vanish from the state in little more than two decades. The main problem is not a lack of animals, though the population is dangerously small, but a lack of genetic variety in these remaining individuals. Because there are so few mates for panthers to choose from, cousins and siblings, both healthy and weak, are mating.

Examinations of the panthers have revealed the distressing results of inbreeding: 80% have heart murmurs and many have another heart deformity; 90% of the males have one undescended testicle; 22% are sterile and more than 90% of their sperm are malformed. Many animals also have trouble fighting off disease, raising concerns about immune deficiencies.

# Living Fossils Arrive at San Diego

In a dramatic New Zealand tribal ceremony, the San Diego Zoo was presented with ten critically endangered Brothers Island tuataras (*Sphenodon punctatus*). The April ceremony was held at the Zoo's Klauber Shaw Reptile House with Te Atiawa Iwi tribal chieftain Ilan Love making the presentation.

Only 300 Brothers Island tuataras remain in the wild. The species clings to existence on a single rocky island off the New Zealand coast, measuring only 10,000 square meters in size. San Diego will begin a captive breeding program whose ultimate goal will be returning the zoo-hatched reptiles to their native habitat in New Zealand. The arrival of these rare reptiles in San Diego culminates years of



Photo by Ken Kelley ©1995 Zoological Society of San Diego

cooperative tuatara conservation and captive breeding efforts in New Zealand. The tuatara loan will establish the first captive breeding colony for the species outside of its native Brothers Island.

With the approval of the tribe, Brothers Island tuatara eggs were collected in wild nests by San Diego Zoo herpetologists and personnel from the Victoria University of Wellington, artificially incubated and hand-raised at the university's Tuatara Research Program.

Tuatara are the last surviving descendents of the dinosaur era, 225 million years ago, hence their designation as "living fossils". Although they resemble lizards, tuatara are classified in their own order (Rhynchocephalia) and their closest living relatives are now fossils. Unique in the world of reptiles, tuatara, like other lizards, can regenerate a lost tail. Unlike most reptiles, they prefer cold climates. They can live to be 100 years old, their eggs take a year to hatch, and they don't reach sexual maturity until age 20.

One of the mysteries of the tuatara is its "third eye", known as the parietal or pineal eye. The "eye" contains a crude lens and retina, and is connected to the brain by a nerve, but is covered by opaque scales, which render the eye sightless. Fires, land-clearing and predation by humans, rats, cats and dogs have driven the tuatara to extinction on the New Zealand mainland, and the only remaining populations survive on rugged islands.

So important is the tuatara gift that Air New Zealand airlines allowed Zoo officials to hand-carry the animals in the passenger section during the long flight. It is the first time in more than 55 years that the airline has waived its "no animals on board" rule.

Because tuatara spend much of their time underground, the new San Diego Zoo residents will be housed out of public view in an off-exhibit breeding group. They will be housed in a new temperature and humidity controlled chamber designed specially for tuatara. The chamber also controls the photoperiod, which will be reversed to facilitate scientific observation of this nocturnal species. *—from San Diego News Release of 4/4/95*

## Chapter News Notes

### Dallas Chapter AAZK

We met our target goal of \$5,000 with our BFR event this year. Our devoted bowlers brought in over \$3,000 while our silent auction grossed just under \$2,000. The highest bid was \$375 for the Southwest Airlines ticket. Jimmy Mitchell met the "Director's Challenge" by beating last year's top bowler Rich Buickerood. Rich's donation and challenge money put us over the top of the \$5,000 goal. Thanks to Lisa Fitzgerald for chairing the event and to all who helped and donated time and items.

The PR from the event brought an invitation to our Chapter to talk to 200 elementary school children about rhinos. Four members, armed with slides, a video, a skull and two horns presented rhino and African school children information to the pre-K through 4th graders. Before leaving, the children donated school supplies to be sent to the Ngare Sergoi Rhino Sanctuary. The teachers arranged for 343 used math, reading and writing textbooks to be donated as well.

We held a weekend garage sale in July and

raised \$665.00 for our Conservation Endowment Program. For our Enrichment Fund, we had an Arts and Crafts booth at our zoo's annual Big Cat Weekend where we raised \$550.00. Both events would not have been possible without the generous support of donations from staff, volunteers and docents. Many thanks to them all.

*--Ann M. Stevens, Treasurer / Liaison*

### The Virginia Chapter of AAZK

The Virginia Chapter of AAZK announces with great sadness the death of its President, Jonathan Bronson. Jonathan was a long-time member of AAZK, and the President of our Chapter for five years. He was a fantastic person - easy to talk to and compassionate. He had great animal know-how, and was very conservation-oriented. He specialized in birds, mammals, and insects at the Virginia Living Museum in Newport News, VA.

Our Vice President, Jim Kirkman, has taken over the role as President. Our other officers are Betty Jean Schmitt, Treasurer; Steve Truman, Chapter Liaison; and Kathy White, Secretary.

*--Kathy White, Secretary*

*(AAZK extends its sincere sympathies to the friends and family of Jonathan Bronson)*

# Legislative Update

Compiled by *Georgann Johnston*  
*Legislative Advisor*  
*Sacramento, CA*



---

## Elephant Hunting Moratorium in Tanzania

The Tanzanian Ministry of Natural Resources, Tourism and the Environment has issued a temporary hunting ban on elephants. The ban is primarily concerned with that country's border with Kenya, where elephants migrate across the border from Kenya's Amboseli National Park. The ban will run through March 1996, during which time the governments of Tanzania and Kenya will try to work out an agreement regarding tourists and hunting along the border.

*Source: African Wildlife News, July-Sept. 1995, Vol. 30, No 4, published by the African Wildlife Foundation; and African Wildlife Update, July/Aug. 1995, Vol. 4, No. 4, published by African Wildlife News Service.*

---

## Park Proposed for Madagascar

The government of Madagascar, in a joint project with CARE-International, the Wildlife Conservation Society, and The Peregrine Fund, has proposed to set aside 810-square miles of wilderness in the central region of the Masoala Peninsula. The area is on the northeastern portion of the island and includes some of the only remaining coastal rainforest land in the country. The Masoala Peninsula is home to a number of species including red-ruffed lemurs, the Madagascar red owl, the Madagascar serpent eagle, and many recently discovered species of butterfly, gecko, and palm trees.

The plan includes designation of two-thirds of the area as a national park and the remaining one-third as a forest management zone. These management zones could be used by local villagers to meet basic needs in accordance with sustainable forestry practices.

*Source: African Wildlife Update, July-Aug. 1995, Vol. 4, No. 4*

---

## Joint Endangered Species Management Program Developed by Native American Tribal Governments and USFWS

A new joint wildlife management policy was announced on 31 August 1995 by the U.S. Fish and Wildlife Service and the National Marine Fisheries Service. The goal of the policy is to involve Native American Tribal governments throughout the U.S. in all aspects of the endangered species program. This plan would include providing information to the tribes



from which species should be protected to active management of recovering species on or near tribal lands.

The policy calls for both federal agencies to consult with and use the expertise of Native American Tribal governments when determining which species should be listed, when surveying populations of species, and when implementing conservation measures. Two examples of joint efforts already underway are the development of a habitat conservation plan by the Navajo Nation (Arizona, New Mexico) regarding the Mexican spotted owl, ferrets, and other species and an agreement with the Nez Perce Tribe (Idaho) to manage reintroduced wolves and grizzly bears in the Bitterroot Wilderness.

*Source: USFWS Press Release, 31 August 1995*

---

## **Tapirs' Habitat at Stake in Ecuador**

The mountain tapir, along with eight species of parrots, endangered bats, the spectacled bear and the Andean condor will be impacted by the construction of the Guamote-Macas road through the interior of the "Purshi" sector of Sangay National Park. The park, comprised of almost 60,000 hectares (232 square miles) of Andean forest, represents the last 2% of the original forest in the Ecuadorian state of Chimborazo.

A recent environmental impact study commissioned by three agencies of the Ecuadorian government "deplored" the devastation to the habitat but failed to recognize many of the unique and endangered species in the area. The tripart government commission recommended changes in the road plan, including a narrower road, dumping rocks and dirt on the remainder of the construction and an effort to control further colonization of the area. Since publication of the EIR report and the recommendations of the commission, road construction has continued unabated. For further information and addresses of officials in Ecuador who have the ability to stop the road's construction, contact Craig C. Downer, P.O. Box 456, Minden, NV 89423 (702) 267-3484.

*Source: Wildlife Conservation NYZS-Wildlife Conservation Society, 20 June 1995*

---

## **Nevada Adopts Fee for Protection of Desert Tortoise**

Fees from land development in Clark County, NV will be used to fund protection efforts for the endangered desert tortoise. The "Habitat Conservation Plan" calls for \$1 million per year over the next 30 years to protect the species. The plan has been endorsed by federal agencies in exchange for federal approval of loss of significant tortoise habitat.

*Source: ESA Today, 20 July 1995, published by the Endangered Species Coalition*

---

## **Possibility of a Canadian ESA?**

Canada does not currently have an Endangered Species Act, but a report issued by the Canadian Endangered Species coalition states that more than 80 groups have expressed

support for a federal ESA in Canada. The groups include such diverse organizations as the National Farmers Union, the United Church of Canada, and the Canadian Bar Association. The Coalition's report also indicates that it expects to see preliminary ESA legislation filed soon with the Canadian Parliament. For more information, contact the Endangered Species Coalition at ((202) 547-9009.

*Source: ESA Today, 27 July 1995, published by the Endangered Species Coalition*

---

## **Protection Plan for Florida Keys Drafted**

The Florida Keys National Marine Sanctuary has drafted a new management plan for the area which includes coral reefs, mangroves, and seagrass meadows. This sanctuary provides habitat for a variety of wildlife including a number of endangered species of birds. The plan would create zones, similar to land zoning, where only certain kinds of activities could occur. Additionally, other areas would be set aside completely to preserve the habitat and allow undisturbed scientific research.

The plan was developed in conjunction with a desire of a number of governmental agencies, both state and federal, to improve the water quality in the Florida Keys. The plan, still tentative, has yet to be formally adopted by the directors of the Sanctuary. Further information can be obtained by calling Sanctuary Manager Bill Causey (305) 743-2437.

*Source: Environmental Defense Fund letter, Aug. 1995, Vol. 26, No. 4*

---

## **House Protects Funding for Elephants, Rhinos and Tigers**

Programs to protect the elephant, rhino and tiger got support in the House of Representatives from a seemingly unlikely source on 13 July when Speaker of the House Newt Gingrich defended the Interior Department's \$600,000 appropriation for the African Elephant Conservation Fund and the \$200,000 appropriation for the Rhinoceros and Tiger Conservation Fund. Over the past few years, World Wildlife Fund has played a key role in promoting funding for both programs.

Gingrich's appeal followed an amendment that would have eliminated funding for the programs. After the Speaker's comments, the program were preserved on a 289-132 vote.

"That the Republican House overwhelmingly defeated the amendment to eliminate the programs can be considered a major political victory for U.S. species conservation programs," said WWF President Kathryn S. Fuller.

*Source: World Wildlife Fund FOCUS, Sept./Oct. 1995*

# ***Hoofstock Nursery Protocol Seminar No. 4 Wild Animal Park Nursery Personnel May, 19, 1993***

*P.K. Ensley, D.V.M.  
Zoological Society of San Diego, San Diego, CA*

## **Emergency Care and Assessment**

### **Introduction:**

Nursery personnel encounter many situations in the day to day care of neonates that may require special care or treatment. The keepers at the nursery facilities at the Wild Animal Park are given instruction on how to deal with these situations through seminars or veterinary guidance. Several of these situations have been identified and characterized in the following outline and chart.

### **1. Emergency Care**

- May involve a neonate upon entry to the nursery or a well baby that destabilizes.
- Requires a level of care which involves special procedures and considerations.
- May involve either life-threatening or nonlife-threatening situations.

### **2. Things to consider**

- Early recognition and prioritization with current work load.
- Mobilization of resources and delegation of efforts.
- Coordination of support care until resolution.
- Communication and medical records.

### **3. Once recognition of the emergency is established**

- Triage the case and determine level of response required.
- If AHT or veterinary response is needed, inquire about what to have ready and if any special equipment is needed to be set up prior to arrival.

### **4. How to help the AHTs and Veterinarians**

- Early recognition and communication regarding emergency situations.
- Have adequate personnel ready to work with the AHT/ Veterinarian.

### **5. Remember**

- Emergency situations test your skills and patience.
- Treatment of emergencies require that you reduce time given to more stable neonates.
- Learn from each emergency.
- Learn the results of all post mortem reports.

### **6. Factors that effect optimal emergency care**

- Slow recognition and response time.
- Fatigue, stress, and high nursery work load.
- Inadequate support and follow-up after initial resolution.
- Employee turn over and loss of experience.
- 24-hour care.

**III/ACC COMMONLY ENCOUNTERED SITUATIONS**

LIFE THREATENING SITUATIONS	SIGNS	CAUSES	DIAGNOSIS	RESOLUTION	SPECIFIC KEEPER TASKS
<b>HYPOTHERMIA</b> -subnormal body temperature	-cool lower limbs -cool oral mucous membranes -shivering	-cold weather -cold environment -low condition	-low rectal temperature -cool limbs -cool mouth	<b>WARMTH</b> -snyder unit -lamps,coils -heat pads	-Identify condition -provide heat -protect from cold stress -monitor body temperature
<b>HYPOLYCEMIA</b> -subnormal blood glucose levels	-general weakness -slow suckling response	-low condition due to sepsis, anorexia, low calorie intake, diarrhea	-Dextrostix -low serum glucose	<b>MILD CASES</b> -Oral glucose(1cc of 50%) <b>SEVERE CASES</b> -iv fluids support, including iv glucose	-Identify condition -notify veterinarian -monitor recovery
<b>PYREXIA</b> -fever:mild or severe	-increased respirations -weakness -maybe no signs	-hyperactivity -sepsis -warm environment	-elevated rectal temperature	<b>COOL DOWN</b> -cold water or alcohol rubdown <b>OTHER OPTIONS</b> -Cold water enema -Drug TX, Banamine	-Identify condition -cool down -notify veterinarian
<b>DYSPNEA</b> -labored respirations	-difficulty getting breaths -open mouth breathing	-thoracic injuries -pneumonia -congestion -cardiac problems -overheating -airway obstruction	-auscultation -chest X-rays -oral exam	-diagnose the problem and treat accordingly	-Identify condition -airway exam -calm the animal down -O2 enrichment in severe cases
<b>COLIC</b> -Severe abdominal pain	-tucked up posture -stretching of limbs -straining to urinate/defecate -tender abdomen -distended abdomen	-peritonitis -tympany -constipation -inflamed gut -gut obstruction	-exam	-treat the cause	-Identify condition -notify the veterinarian

LIFE THREATENING SITUATIONS	SIGNS	CAUSES	DIAGNOSIS	RESOLUTION	SPECIFIC KEEPER TASKS
URINARY BLOCKAGE -urethral obstruction	-straining -oliguria -strangury	-urethral calculi; associated with increased calcium intake	-frequency in males -dribbling urine or no urine production -elevated blood urea nitrogen	-relieve obstruction	-identify condition -notify veterinarian
SEPSIS -presence of bacteria or their toxins in the bloodstream	-fever -anorexia -low condition	-bacteria -bacterial toxins	-blood culture -clinical, examination, fever -CBC	-antibiotic therapy -supportive care	-supportive care
DIARRHEA -poorly formed stools and fluid loss	STOOL CHARACTER -mucousy -runny -watery -foul smelling	-nutritional -bacterial -viral -parasitic	-stool character changes -rectal culture & sensitivity -slide exam -fecal floatation	-fluid therapy -antibiotic therapy -dietary adjustments -supportive care	-identify condition -diet adjustments -fluid support -supportive care
SEVERE TRAUMA -concussion -fractures -deep wounds	-ataxia -limb dysfunction -bloody wounds	-birthing trauma -restraint procedures -crate transfers -exhibit injuries	-physical exam -radiographic exam	-supportive care -wound care -fracture reduction	-identify condition -supportive care -wound care
DRUG REACTIONS -allergic responses -side reactions	-difficulty breathing -ataxia -muscle tremors -collapse -anorexia	-vaccination reaction -drug allergy -drug inserts list side reactions associated with each drug	-physical exam -recent drug administration history	-supportive care -antishock medication if appropriate	-monitor response to drug administered
PLASMA ADMINISTRATION REACTION	-muscle tremors -ataxia -collapse	-reaction to foreign protein administration	-Response during an iv plasma administration	-stop plasma administration -supportive drug therapy (AHT/DVM) -oxygen	-monitor response during plasma administration

NON-LIFE THREATENING SITUATIONS	SIGNS	CAUSES	DIAGNOSIS	RESOLUTION	SPECIFIC KEEPER TASKS
ANOREXIA -inappetence	-lack of appetite	-unpalatable formula -illness -weak for any reason -adapted to maternal diet -weaning adjustments	-refusal to eat	-determine the cause	-monitor the degree of seriousness -initiate subcutaneous fluid support
IV LINE MALFUNCTION	-IVAC beeper -fluid leakage s.c. -fluid leakage on dressing	-line obstruction -catheter malfunction	-trouble shoot IVAC and line	-correct malfunction -contact AHT/DVM -remove catheter	-correct malfunction -contact AHT/DVM -remove catheter
TRAUMA -horn buds -abrasions	-hemorrhage	-minor/major trauma	-bleeding at base of horns	-clean -wound powder -dressing if necessary	-clean -wound powder -dressing if necessary
CONGENITAL DEFECTS -patent urachus	-urine stains from umbilicus	-umbilicourinary fistula	-physical exam	-topical cautery or surgery	-identify condition -monitor resolution
CARDIAC	-shortness of breath -ataxia	-inefficient cardiovascular pump	-auscultation -ECG -Chest X-Rays	-surgery -euthanasia	-request neonate exam
BOVA-S negative status	-poor doer -diarrhea -low weight gain	-lack of maternal antibodies	BOVA-S -glutaraldehyde test	-plasma administration	-request BOVA-S at 24 hours post parturition, or post plasma administration

# *The Early Introduction of a Hand-Raised Orangutan Infant to a Surrogate Mother*

*By Carolyn Kennedy, Keeper IV  
Audubon Zoo, New Orleans, LA*

It has been well documented that mother-rearing an infant ape provides the best environment for development. Mother-reared infants typically develop to be socially and sexually normal adults. In the past, hand-reared apes often exhibited stereotypes as infants; such as rocking and self-clasping. As zoos learned more about hand-rearing great apes, they recognized how important it was to introduce a hand-reared infant to conspecifics as early as possible. Exposure to peers and adults during the hand-rearing period would also benefit the infant when later adjusting to group life. In the last ten years, our two adult female orangutans (*Pongo pygmaeus abelii*) have produced five offspring between them. Due to maternal neglect, all five of these infants have been hand-reared and reintroduced into the orangutan group.

In July of 1991, the Audubon Zoo orangutan group consisted of a thirty-one year old adult male named Frankie, two adult females; Mama and Sara, ages thirty and twenty-one respectively, and three juveniles: Jambu, a male of six years and Siabu and Feliz, two females both approximately thirty months old.

Mama, who was pregnant and due anytime, had shown no interest in her previous two off-spring. There was little hope of her raising this infant. Sara, a hand-reared animal, had produced twins in 1985. These two females were hand-reared due to neglect. Sara's next off-spring, born the following year, was mother-reared until its death at eight days of age. Sara showed excellent maternal skills by nursing and caring for the baby, however the baby was found to be malnourished. Two months later, three hand-reared juveniles were reintroduced to the group. Sara cared for them and allowed both to nurse. A recent physical has shown that Sara continues to lactate.

In the past at Audubon Zoo, orang infants have been hand-reared until weaned at approximately 18 months old. During these months the infants receive exposure to the orang group through daily visits to the orang night house area accompanied by keepers or volunteers. The infants have also been reared with conspecifics. Prior to reintroduction, the young orangs were housed in a night house adjacent to the adults and received plenty of time in the exhibit and night house to become familiar with the furnishings and to be comfortable moving about the enclosures. Their diet consisted mostly of solid food as they were close to being weaned from bottle feedings. These young orangs adapted well to group life and showed none of the abnormalities associated with hand-rearing.

With parturition eminent, several factors prompted the primate staff to discuss a change in the hand-rearing protocol. 1) The staff felt confident in Sara's ability to be a surrogate mother to Mama's baby. 2) Hand-rearing an ape is very time consuming to the keeper staff. This time could be reduced by returning the baby to the group at an earlier age. 3) Although the 18-month-old reintroduced infants have done very well, introducing an infant earlier would be even closer to a natural rearing situation. It was decided that the baby would be hand-reared as in the past, but at six months of age it would be given

to Sara to raise. This six-month period would give the staff time to make the necessary preparations and by this age the infant would no longer require night-time feedings.

This plan had many considerations. At six months, a hand-reared infant still requires bottle feedings. Although Sara was lactating, there were concerns regarding the quality and quantity of the milk. In addition, it was not certain that this baby would even nurse. Therefore, Sara would be required to allow the baby to receive feedings from the keepers. This method had been successful with a female gorilla and her most recent offspring at Audubon Zoo (Thorpe, 1989). The gorilla would not allow her infant to nurse but was otherwise an adequate mother. As with the gorilla, a long neck beer bottle and lambs nipple would be used to feed the baby. The long neck of the bottle could pass easily through the night house bars to the baby. Sara would then be rewarded for allowing the baby to drink.

This procedure was going to be complicated by Sara's temperament. Sara had been aggressive toward most of the primate staff. Keepers were confident that the baby would not be harmed by Sara, however the proximity required to feed the baby through the night-house bars with Sara present would put the keepers at risk. A training program was developed to shape Sara's behavior using Sara's two preferred keepers as trainers. The intensive training program began with the birth of Mama's baby, Ibu. In the beginning, three training sessions a day were held. Each session lasted about fifteen minutes, but this was determined by Sara's mood. There was a primary trainer and a relief trainer who was taught the behaviors as Sara learned them. Sara was isolated for all the training sessions, however the other orangutans could watch. All the animals were rewarded at the sessions' end so that no one got jealous of the extra attention given Sara.

The plan was to teach Sara fun behaviors that would occupy her hands. She was taught to present different body parts, to turn around, and to move to the other end of the house. She was taught to target wooden spoons with both hands and to hold all commands until the trainer released the behavior. Initially, Sara showed some aggressiveness, often trying to grab the trainer or breaking the wooden spoons. However, Sara also craved the attention and food rewards. She was reinforced for calm behavior but the training session would end with any display of aggressiveness. The session ending or her being ignored was not what Sara wanted. Once Ibu was placed with Sara, the training sessions would be held to keep Sara in position while Ibu fed.

Sara was an excellent student. She would sometimes become impatient if the rewards were not frequent enough. Sara soon realized that her patience would be rewarded with longer training sessions and extra attention from the trainers afterwards. The keepers were encouraged by how quickly she learned behaviors and, as novice trainers, they were hard pressed to keep ahead of her. Sara was eager to please her trainers whether it involved a food reward or just verbal praise. Her improved attitude was felt by the other primate keepers. Previously, Sara would display by spitting and slamming the bars when the other keepers were near. Now, she is much more tolerant of their presence.

Naturally, there were concerns for the keepers' safety while Sara learned the desired behaviors. It was agreed that if any of the keeper staff were injured in the training process the program would be canceled. Precautions were taken. Extra metal strips were welded to the night house bars in areas where Sara could reach an arm through.



In some areas, welded wire was attached to the vertical bars. Two removable barred panels were made and attached with "u-bolts" to the night house bars to form a grid. Once Ibu was introduced to Sara, a device made from PVC pipe would be used to hold the bottle to the panels (figure 1). Ibu was fed using the holder prior to her introduction to Sara. The use of a bottle holder freed the trainer's hands so they could conduct the training sessions during the feedings. The trainer's full attention could then be given to Sara. The holder also served to protect the glass bottle should it become jarred against the bars. In addition, the grid formed by the panels provided extra assurance that only Sara's fingers could reach through the bars.

Ibu's introduction to Sara went very smoothly. The night house was prepared with extra ropes at Ibu's level and the floor was deep-bedded with hay. The infant was placed in the night house with Sara in an adjoining night house. On 17 February, 1992, Sara was introduced to Ibu. Ibu was very distressed both at being left by her human caregivers and at the approaching large red ape and she had many screaming bouts. Sara was calm approaching Ibu, but she did not attempt to pick her up. Occasionally, Sara would pat Ibu's back in an effort to comfort her. By early evening, Ibu was quiet and exploring the night house. That night Sara slept up on a platform and Ibu on the floor in the hay. A 24-hour watch was held for the first three days of the introduction. On the second day, it was necessary to shift the oranges to an adjoining night house for cleaning and Sara pulled Ibu into the adjoining den. By the fourth day, Ibu finally climbed onto Sara for the shift. At one week, Ibu was no longer content to be left on the floor at night and would cry until Sara brought her up onto the platform. From then on she and Sara slept together.

Feeding Ibu did not prove to be a problem. Ibu's mobility allowed her to be fed without Sara's assistance. Once the two oranges bonded, Sara promptly brought Ibu up to the bars for the four feedings. Although the training sessions were designed to be held while Ibu ate, this seemed distracting to Ibu. Instead it was decided to give Sara her own drink using a rabbit water bottle filled with juice. Drinking from the water bottle is slow, allowing Ibu time to finish.

After ten days together, Sara and Ibu were let out into the exhibit alone. Finally, Ibu really clung to Sara and was not to let go all day. This was also the first day Ibu was observed nursing.

Three weeks after Ibu and Sara's introduction, the three juveniles were allowed into the night house with them. The juveniles were fascinated with their new playmate, poking and pulling her. Sara allowed this unless Ibu vocalized, and then she would intervene. This phase of the introduction was quickly moved outside to the exhibit where the juvenile oranges took turns carrying Ibu. The two other adult oranges, Frankie and Mama, were introduced to Sara and Ibu on 24 March, 1991. Mama showed no interest in the baby and Frankie's interest consisted of a close inspection of Ibu.

Since the end of March, all seven orangutans are left together for most of the day. Sara and Ibu are separated from the others at night so that Ibu can get a rest from the juveniles' persistent handling. In addition, they are separated for all the feedings so Ibu has a chance to eat. Ibu is becoming very independent and Sara frequently leaves her to play on her own. However, at the first sound of distress, Sara returns to comfort the baby.

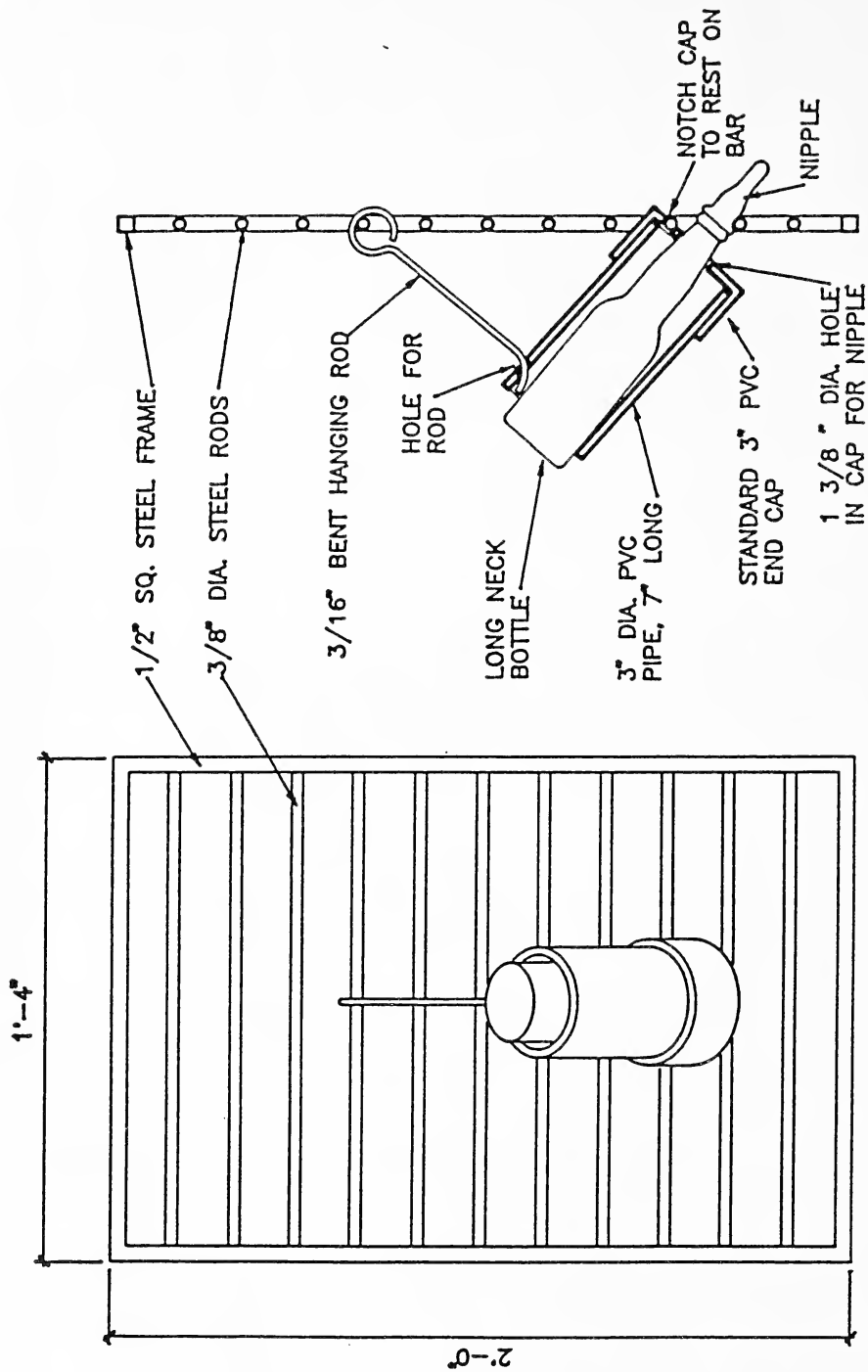

SECTION

FRONT ELEVATION

(Figure 1)

Our training program did prove time consuming. During the first six months of training, the sessions lasted 1-2 hours per day. However, these sessions aided in developing a trust between the orangutan and her two keepers which certainly determined the success of the project. Sara's life is also enriched by the training. Perhaps what was considered aggressiveness was actually a need for attention. Enrichment through training has helped diminish her aggressive behaviors. The plan is to continue with the training sessions for this reason. Sara is now being trained to allow a hand-injection. Also, as Ibu is eating more solid food, Sara is being reinforced for allowing Ibu to receive her share.

The entire program required a commitment from all the primate staff. Work schedules were adjusted to incorporate training sessions and feedings. Communication between the trainers was essential and because of opposite schedules, often required weekly meetings outside of work hours. Also, there were many meetings with other animal staff to discuss protocols, progress, and problems that may be encountered.

The training program was an exciting new experience. As Ibu grows older, keeper schedules are returning to normal. Watching Ibu interact with the orang group is very rewarding. It is possible that in the future infants can be returned to surrogate mothers even earlier. Although it has been a busy first year, the work has been lessened through this program and Ibu's integration into the group makes the work worthwhile.

### **Acknowledgments**

I would like to thank all the primate staff for their patience, Eve Watts and Roger Iles for their confidence in the trainers and the oranges, Kristine Manceaux for back-up, Carolyn Boling and David Wilson for training advice, and the orang volunteers for helping to ease the load. Special thanks to Sara and Ibu, who are such a pleasure.

### **References**

Cole, M., Devison, D., Eldridge, P.J., Mehern, K.G., and Ripley, W.A. 1979. Notes on the Early Hand-rearing of an Orangutan and its Subsequent Reintroduction to the Mother. International Zoo Yearbook. Vol. 19:263-264.

Demitros, C. 1989. The Gorillas of Tropic World. Gorilla Gazette. Vol. 3, No. 3: 9-10.

Meder, A. 1990. Integration of Hand-reared Gorillas into Breeding Groups. Zoo Biology. Vol.9, No.2: 157-164.

Miser, A. 1989. Progress of two Young Orangs at the Topeka Zoo. International Zoo News. Vol. 36/2, No.213: 7-9.

Thorpe, L. 1989. Development of A Supplemental Feeding Protocol for a Western Lowland Gorilla. Animal Keepers' Forum, Vol.16, No.10: 341-346.

*Reprinted from the Proceedings of the 19th National Conference of the American Association of Zoo Keepers, Inc. San Diego, California September 27-October 2, 1992.*



# ENRICHMENT OPTIONS



Psychological Stimulation  
Behavioral Enrichment  
Activity Manipulation  
Occupational Husbandry

By Kayla Grams, Arizona-Sonora Desert Museum  
and Gretchen Ziegler, Sequoia Park Zoo

**CARNIVORES** - We have discovered a “toy” for our bobcats that provides much entertainment. It is a coconut, with the “eyes” punched out and catnip placed in the holes. The bobcats bat it around the exhibit or just spend time nuzzling it. It is also a natural “toy”. It blends in well with the surroundings.

—Kathy White, Keeper  
Virginia Living Museum, Newport News, VA

**RAPTORS** - Some species of raptors will spend time manipulating sticks during nest building season. This provides both exercise and mental stimulation for them. A female Cooper’s hawk (*Accipiter cooperi*) also spends time plucking feathers from an empty paper towel tube. The feathers are stuck into holes punched in the tube or stuffed in the ends of the tube. If given a “mirror”, she will have short agonistic encounters with herself by puffing her feathers and feinting high and low with her head, occasionally striking out with her feet.

She is a well-acclimated Cooper’s hawk; very calm for this nervous species. She will attempt to build nests from sticks, and will lay eggs. Since in this species the male does most of the nest building, her attempts at nest building are rather futile, but she does get needed exercise.

—Jo-Ann Jennier  
Busch Gardens, Tampa Bay, FL

**COYOTES** - Pig ears and hooves purchased from a local pet store proved to be an inexpensive, weekly enrichment option. As an added treat, we rubbed them on our domestic sheep for additional scent before tossing them into the exhibit. The coyotes work as a team, circling in on their “prey” before settling down to a long afternoon of gnawing.

**POTBELLIED PIGS** - To encourage rooting behavior we hide treats such as carrots and apples in a sand box.

—Diane Bogdan, Keeper  
Queens Wildlife Center, Flushing, NY

(Editor's Note: We apologize for not printing the following text submitted by Camille Dorian along with the Little Tykes Swing for Primates featured in last month's column.)

The swing was purchased at a toy store and came with a rope which we attached to a double snap lock and clipped inside the cage. When the swing was first hung in February, during cold weather, the primates in the enclosure seemed to show little interest. Sometimes new objects are routinely ignored for a length of time, but in this case, closer examination revealed that the tilt of the seat had allowed a puddle of icy rain water to accumulate. Once the back of the seat was drilled through with several small holes in order to solve the drainage problem, this female adult white-faced capuchin (*Cebus capucinos*) began to show particular interest and eventually began seating herself inside the swing in various positions. Her usual method of approach was to first leap from a nearby perch to the swing rope, and from there to lower herself into the seat. The impact of her initial contact was enough to provide a residual swinging motion after she was seated. So far, she has maintained her interest over a three-month period.

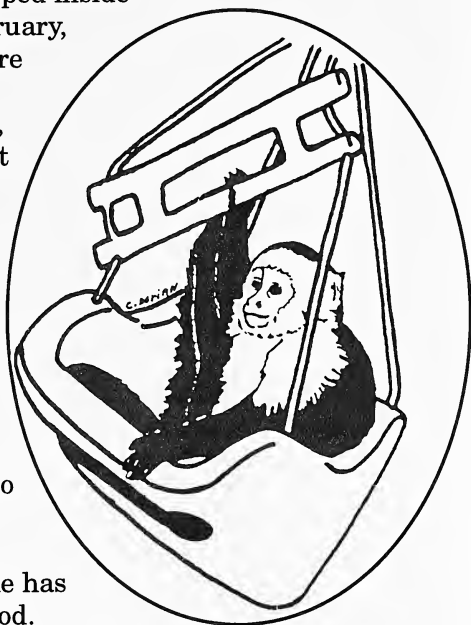

Other small primates (i.e. squirrel monkey and spot-nosed guenon) have also developed an interest in using this swing. The swing is easy to clean and so far shows no signs of wear.

---

## Births & Hatchings



**Philadelphia Zoo (Philadelphia, PA)...**announces the following B&H from January through August 1995:

**Mammals** - 1.0 Malayan tapir (*Tapirus indicus*) [CITES I]; 0.1 western lowland gorilla (*Gorilla gorilla*) [CITES II]; 0.1.1 blue duiker (*Cephalophus monticola*) [CITES II]; 1.0 armadillo (*Oryzomys azer*) [CITES II]; 0.0.4 Rodriguez fruit bat (*Pteropus rodricensis*) [CITES II]; 0.0.2 lesser slow loris (*Nycticebus pygmaeus*) [CITES II]; 3.1 bicolor tamarins (*Sanguinus bicolor*) [CITES I]; 1.0 mongoose lemur (*Lemur mongoz*) [CITES I]; 0.0.1 gray baboon lemur (*Hapalemur griseus*) [CITES]; 0.0.1 pygmy marmoset (*Callithrix pygnaea*) [CITES II]; 0.0.2 red panda (*Ailurus fulgens*) [CITES II].

**Birds** - 0.0.6 Humboldt penguin (*Spheniscus humboldti*) [CITES I/0.0.2 DNS]; 0.0.4 Caribbean flamingo (*Phoenicopterus ruber*) [CITES II/0.0.1 DNS]; 0.0.2 bald eagle (*Haliaeetus leucophalus*) [CITES I/0.0.1 DNS]; 0.0.2 hermit ibis (*Geronticus eremita*) [CITES I]; 0.0.4 Bali mynah (*Leucopsar rothschildi*) [CITES I/0.0.2 DNS].

**Reptiles/Amphibians** - 0.0.3 prehensile-tailed skink (*Corucia zebrata*) [CITES II/0.0.1 DNS]; pancake tortoise (*Malacochersus tornieri*) [CITES II]; eyelash viper (*Borhrops schlegel*) [CITES III]; 0.0.6 tye-dye poison dart frog (*Dendrobates auratus*) [CITES II].  
submitted by Ken Pelletier, Chapter Liaison, Philadelphia AAZK Chapter, Philadelphia, PA.

# L.I.N.K.

## (Liaison and Information Network for Keepers)

Coordinator for the LINK System: Mark de Denus, Assiniboine Park Zoo, 2355 Corydon Ave., Winnipeg, Manitoba, Canada R3P 0R5. (204) 986-6921 [w]; (204) 837-2916 [h]. Assistant LINK Coordinator - Ric Urban, Houston Zoological Gardens, Houston, TX, 1513 MacGregor Way, Houston, TX 77030 (713) 520-3234 [w].

### Regional Coordinators

- ALABAMA** - Fred Alvey, Zoo Atlanta, 800 Cherokee Ave. S.E., Atlanta, GA 30315  
**ARKANSAS** - Ann Rademacher, Little Rock Zoological Gardens, #1 Jonesboro Dr., Little Rock, AR 72205  
**CALIFORNIA (Northern)**- Jean Lai, Oakland Zoo, 9777 Golf Links Rd., Oakland, CA 94605  
and Ruby Lara, Sacramento Zoo, 3930 West Land Park Dr., Sacramento, CA 95822-1123  
**CONNECTICUT**- Jeanette Beranger, Roger Williams Park Zoo, Providence, RI 02905  
**DELEWARE** - Theresa Maas, Philadelphia Zoo, 34th & Girard Ave., Philadelphia, PA 19104  
**FLORIDA** - Rick Smith, 4707 Walden Circle #409, Orlando, FL 32811  
**GEORGIA** - Fred Alvey, Zoo Atlanta, 800 Cherokee Ave. S.E., Atlanta, GA 30315  
**IDAHO** - Holly Liappas, Tautphaus Park Zoo, P.O. Box 50220, Idaho Falls, ID 83405  
**ILLINOIS** - Pat Swieca, 5710 W. Cullom Ave., Chicago, IL 60634  
**INDIANA** - Jan Weinig, P.O. Box 197, Michigan City, IN 46360  
**KANSAS** - Brian Kohler, Lee Richardson Zoo, P.O. Box 499, Garden City, KS 67846-0499  
**KENTUCKY** - Scott Wright, Cleveland Zoo, 3900 Brookside Park Dr., Cleveland, OH 44109  
**LOUISIANA** - Rhonda Votino, 3535 Houma Blvd., Apt. 109, Metairie, LA 70006  
**MAINE** - Jeanette Beranger (see addresses under CT)  
**MARYLAND** - Theresa Maas, Philadelphia Zoo, 34th & Girard Ave., Philadelphia, PA  
**MASSACHUSETTS** - Jeanette Beranger (see addresses under CT)  
**MICHIGAN** - Tim Sampson, John Ball Zoo, 1300 W. Fulton, Grand Rapids, MI 49504  
**MINNESOTA** - Tim Hill, Minnesota Zoological Gdns., 13000 Zoo Blvd., Apple Valley, MN 55124  
**MISSOURI** - Brian Kohler, Lee Richardson Zoo, P.O. Box 499, Garden City, KS 67846-0499  
**MONTANA** - Holly Liappas (see address under Idaho)  
**NEVADA** - Patricia Simonet, Wildlife Safaris, P.O. Box 6735, Incline Village, NV 89450  
**NEW HAMPSHIRE** - Jeanette Beranger (see addresses under CT)  
**NEW JERSEY** - Frank Leonard, Bronx Zoo, 185th & Southern Blvd., Bronx, NY 10460  
**EAST NEW YORK** - Frank Leonard, Bronx Zoo, 185th & Southern Blvd., Bronx, NY 10460  
**WEST NEW YORK** - Alan Baker, Burnet Park Zoo, 500 Burnet Park Dr., Syracuse, NY 13204  
**NORTH CAROLINA** - Kristin LaHue, Riverbanks Zoo, P.O. Box 1060, Columbia, SC 29202-1060  
**NORTH DAKOTA** - Bob Debets, Assiniboine Park Zoo, 2355 Corydon Ave., Winnipeg, MB Canada R3P 0R5  
**OHIO** - Scott Wright, Cleveland Metroparks Zoo, 3900 Brookside Park Dr., Cleveland, OH 44109  
**OKLAHOMA** - Ann Rademacher (see addresses under AR)  
**OREGON** - Anna Michel, Washington Park Zoo, 4001 SW Canyon Rd., Portland, OR 97221  
**PENNSYLVANIA** - Theresa Maas, Philadelphia Zoo, 3400 W. Girard, Philadelphia, PA 19104  
**RHODE ISLAND** - Jeanette Nadeau (see addresses under CT)  
**SOUTH CAROLINA** - Kristin LaHue, Riverbanks Zoo, P.O. Box 1060, Columbia, SC 29202-1060  
**SOUTH DAKOTA** - Bob Debets (see address under ND)  
**TENNESSEE** - Gail Karr, Memphis Zoo & Aquarium, 2000 Galloway, Memphis, TN 38112  
**TEXAS** - Connie Dieringer, Houston Zoo, 1513 N. MacGregor, Houston, TX 77030  
**VERMONT** - Jeanette Nadeau (see addresses under CT)  
**VIRGINIA** - Theresa Maas, Philadelphia Zoo, 34th & Girard, Philadelphia, PA 19104  
**WASHINGTON** - Joe Sullivan, Cat Tales, N. 17020 Newport Hwy., Mead, WA 99021  
**WEST VIRGINIA** - Theresa Maas, Philadelphia Zoo, 34th & Girard, Philadelphia, PA 19104  
**WISCONSIN** - Wayne Hazlett, 3768 S. 89th St., Milwaukee, WI 53228  
**WYOMING** - Holly Liappas (see address under Idaho)  
**DISTRICT OF COLUMBIA** - Theresa Maas (see address under PA)  
**Provinces of Manitoba & Saskatchewan** - Bob Debets (see address under ND)  
**Provinces of Alberta & British Columbia** - Grant Tkachuk, 9955 114th St. Apt. A, Edmonton, AB T5K1P7  
**Atlantic Canada** - Bernard Gallant, RR # 7, 1081 Ryan Road, Moncton, N.B., E1C 8Z4

Vacancies exist for the following States or Provinces: Alaska, Arizona, Southern California, Colorado, Hawaii, Iowa, New Mexico, Mississippi, Nebraska, Utah, Ontario and Quebec.

*Institutions wishing to advertise employment opportunities are asked to send pertinent data by the 15th of each month to: Opportunity Knocks/AKF, 635 S.W. Gage Blvd., Topeka, KS 66606-2066. Please include closing dates for positions available. There is no charge for this service and phone-in or fax listings of positions which become available close to deadline are accepted. Our phone is 1-800-242-4519 (U.S.); 1-800-468-1966 (Canada). Our FAX is 913-273-1980.*

**VETERINARY TECHNICIAN**...part-time position, some experience preferred. Will assist with medical procedures, administer vaccines and other medications, and provide other routine vet tech functions as needed. Send resumé to: Tim Gunther, Bergen County Zoological Park, 216 Forest Ave., Paramus, NJ 07652, or call (201) 262-3771 for more information.

**ZOO KEEPER**... at Topeka Zoological Park - requires a degree in animal science, biology or related field. Experience is preferred, but not required. Will be responsible for animal care, exhibit care, and other duties. Annual salary is \$17,000.00 to start. Benefits include paid vacation, plus health, dental and retirement plan. Contact City of Topeka, Personnel Dept., 215 SE 7th St., Topeka, KS 66603 (913) 295-3867. **Closing date for application is 15 November 1995.**

*The following two (2) positions are available at the Utica Zoo. To apply for either position send resumé to: Gary Zalocha, General Curator, Utica Zoo, Steele Hill Road, Utica, NY 13501.*

**SENIOR ANIMAL KEEPER**...requires minimum of four-year degree in animal related science field and four years paid experience working with exotic animals in a zoo setting. Team attitude and the ability to work effectively with people and interact with the public; good organizational, supervisory and communication skills required. Responsibilities include, but are not limited to, complete husbandry of animals/exhibits, record keeping and sea lion training. Will assist with movement of animals, implementation of animal enrichment, exhibit design and construction, education and all aspects of zoo related programs. Competitive salary with benefits based on experience and education.

**ZOO ATTENDANT I (nutrition/commissary)**...degree in animal science/biology preferred with experience in nutrition. Must be able to lift and/or carry objects weighing 50 pounds and must have an interest in animal nutrition, monitoring diets and commissary management. Responsible for the preparation of diets, diet research, diet monitoring and commissary ordering, receiving and management. Will work in team environment and occasional coverage of other areas. Entry level position. Higher level will be considered for qualified applicants.

**ANIMAL KEEPER (Reptiles & Amphibians)**...one position working with reptiles and amphibians. Duties: maintain a healthy environment for animals at the Little Rock Zoo. Requirements: completion of high school; at least one year of experience working with and around exotic animals in a controlled environment; OR equivalent experience and training. Venomous reptile experience required. May be required to assist with the care of some primates on a limited basis. Salary Range \$15,432.00 - \$22,109.00. Must submit an original City of Little Rock application, and a training and experience questionnaire **by 5:00 p.m., Friday, 29 October, 1995.** To apply contact: City of Little Rock, Personnel Dept., 500 West Markham, Room 130W, Little Rock, AR 72201-1428 (501) 371-4590. AA/EOE.

**HEAD KEEPER, ANIMAL ENCOUNTERS**...prefer four-year college degree in life sciences or zookeeping plus ability equal to that resulting from satisfactory completion of courses required for graduation from an accredited college or university with a Master's degree. Minimum of six (6) years experience in zoo or similar work. Minimum of four (4) years practical zoo experience is required. The successful applicant will be responsible for directing and supervising daily activities of the keeper staff and performs daily routine animal and plant care tasks of domestic and show animals, and supervises Senior Keepers, Keepers, Volunteers, Seasonal Keepers, and Interns. Send resumé and cover letter to: Mary Jane Bennett, Director of Human Resources, Indianapolis Zoo, 1200 W. Washington St., Indianapolis, IN 46222. EOE.

**ANIMAL CARE KEEPER**...must have a minimum of two (2) full years of experience with captive exotics in a professional zoo setting. The successful candidate will be exposed to a diverse animal collection within a small progressive zoo environment. Salary is \$11,400.00 - \$13,500 with added benefits. Send resumé with references **by 20 October 1995** to: Dale Bakken, Director, Heritage Zoo, 2103 West Stolley Park Rd., Grand Island, NE 68801.

**ZOOKEEPER**...requires one (1) year exotic animal experience. College degree preferred. Rotates to all areas of the zoo. Salary \$6.00/hr. plus benefits. Send resumé to: M. McBirney, Pueblo Zoo, 3455 Nuckolls Ave., Pueblo, CO 81005, or call (719) 561-8686 for more information.

**ZOOKEEPER I.**The North Carolina Zoological Park is accepting resúmes from keepers with pinniped experience to work in the Rocky Coast Habitat with California sea lions, harbor seals, polar bears and Arctic fox. Pinniped training experience, a degree in a biological science, as well as experience at an accredited zoo are preferred. Starting salary is \$16,760.00 plus benefits. Send resumé and cover letter **by 20 October 1995** to: Human Resources, Attn: Guy Lichty, North Carolina Zoological Park, 4401 Zoo Parkway, Asheboro, NC 27203. You may respond by FAX #910-879-2891

**ANIMAL KEEPER**...a full-time position is being offered at the Metro Washington Park Zoo, Portland, OR. Annual starting salary range is \$27,645.12 - \$32,196.96 after one year (June 94 pay schedule). Excellent benefits. The successful candidate is likely to have at least two years experience at an accredited AZA institution where they excelled as an animal keeper in all facets of animal care including enrichment and training, visitor interaction, and communication. Application materials, position description, and deadline date are available from the Metro Personnel Office located at 600 N.E. Grand Avenue, Portland, OR 97232 (503) 797-1570. **Resúmes are not accepted.** EOE.

**ANIMAL TECHNICIAN/AREA SUPERVISOR (Kansas City Zoo)**...prefer an accredited Associate degree in life science; two (2) years experience in zoo animal husbandry and exhibition; bird experience desirable; supervisory experience in animal related capacity preferred. Will participate in maintaining and exhibiting of diverser animal collection; development and implementation of public programs; and direct supervision of zookeeper staff. Nonresidents, if appointed, must establish residency within the city limits of Kansas City, MO. Salary range \$1,853.00 - \$2,592.00 monthly plus excellent benefits. Send resumé **by 1 December 1995** to: Reta Gaebler, 414 E. 12th St., 12th Floor, City Hall, Kansas City, MO 64106. EOE/ME/D.

**ZOOKEEPER**...the Austin Zoo has a full-time position open for a hard-working, well-rounded person who would enjoy working at a growing, privately owned zoo. Duties include care and feeding of nearly 300 animals representing 70+ species, including birds, reptiles, hoofstock, primates, and other mammals. Work is in all areas of zoo/petting zoo, requiring feeding, enclosure maintenance and cleaning, record keeping, and public interaction. One year paid experience and high school diploma required; related college course work a plus. Will work some weekends and holidays. Competitive wages and benefits. Send resumé **by 1 November 1995** to: Austin Zoo, Attn: Keeper Dept., 10807 Rawhide Trail, Austin, TX 78736. 1-800-291-1490, Ext. 19.



# AAZK Membership Application check here if renewal [ ]

Name \_\_\_\_\_

Address \_\_\_\_\_

City \_\_\_\_\_ State/Province \_\_\_\_\_ Zip \_\_\_\_\_

## U.S. Members

**\$30.00 Professional/U.S.**  
*Full-time Keepers*

**\$25.00 Affiliate/U.S.**  
*Other staff & volunteers*

**\$25.00 Associate/U.S.**  
*Those not connected with  
an animal facility*

**\$50.00 or up - Individuals  
Contributing/U.S.**

**\$50.00 or up  
Institutional/U.S.**  
*Organizations / Institutions  
(requires Board approval)*

**International Members**

**\$40.00 International**  
*All members outside U.S. &  
Canada regardless of category*

## Canadian Members

**\$35.00 Professional/Canada**  
*Full-time Keepers*

**\$30.00 Affiliate/Canada**  
*Other staff & volunteers*

**\$30.00 Associate/Canada**  
*Those not connected with  
an animal facility*

**\$55.00 or up - Individuals  
Contributing/Canada**

**\$55.00 or up  
Institutional/Canada**  
*Organizations / Institutions  
(requires Board approval)*

**Library Only**

**\$20.00 Library**  
*Available only to  
established libraries*

Zoo Affiliation (if any) \_\_\_\_\_

Zoo Address \_\_\_\_\_

Title \_\_\_\_\_

Work Area \_\_\_\_\_

My check is enclosed (AAZK, Inc.)  Please charge my credit card

MASTERCARD \_\_\_\_\_ VISA \_\_\_\_\_ Card # \_\_\_\_\_ - \_\_\_\_\_ - \_\_\_\_\_ - \_\_\_\_\_

Name on card \_\_\_\_\_ Expiration Date \_\_\_\_\_

Signature \_\_\_\_\_

Mail this application to: AAZK Administrative Offices, Topeka Zoo, 635 S.W. Gage Blvd., Topeka, KS 66606-2066 U.S.A. Make checks/money orders payable to AAZK, Inc. Must be in U.S. FUNDS ONLY.

Membership includes a subscription to *Animal Keepers' Forum*. The membership card is good for free admission to many zoos and aquariums in the U.S. and Canada.

**American Association  
of Zoo Keepers, Inc.  
635 S.W. Gage Blvd.  
Topeka, KS 66606-2066  
U.S.A.**

Address Correction Requested



*"Dedicated to  
Professional Animal Care"*

National Zoological Park 3796  
MWP Library  
Washington, DC 20008

Non-Profit Organization  
U.S. POSTAGE PAID  
Permit # 646  
Topeka, KS 66603

# ANIMAL KEEPERS' FORUM

DL  
76  
A548  
N2P



**The Journal of the American  
Association of Zoo Keepers, Inc.**

**NOVEMBER 1995**

**ANIMAL KEEPERS' FORUM**, 635 S.W. Gage Blvd., Topeka, KS 66606-2066

Phone: 1-800-242-4519 (U.S.) 1-800-468-1966 (Canada) FAX 913-273-1980

**Managing Editor:** Susan Chan • **Associate Editors/Enrichment Options**

**Coordinators:** Kayla Grams, Arizona-Sonora Desert Museum & Gretchen Ziegler, Sequoia Park Zoo • **Book**

**Review Coordinator:** Andrea Bernee, Chaffee Zoological Garden • **Legislative Outlook Column Coordinator:**

Georgann B. Johnston, Sacramento, CA.

**Animal Keepers' Forum** (ISSN 0164-9531) is a monthly journal of the American Association of Zoo Keepers, Inc. Ten dollars of each membership fee goes toward the annual publication costs of **Animal Keepers' Forum**. Third Class postage paid at Topeka, KS. Postmaster - Please send address changes to: **American Association of Zoo Keepers, Inc., Administrative Offices, 635 S.W. Gage Blvd., Topeka, KS 66606-2066** - attn: Barbara Manspeker, Administrative Secretary

**November 1995**

**Vol. 22, No. 11**

**AAZK Executive Director:** Ed Hansen, AAZK, Inc., Topeka KS

### **BOARD OF DIRECTORS**

Ric Urban, Houston Zoological Garden, Houston, TX 77030

Diane Callaway, Omaha's Henry Doorly Zoo, Omaha, NE 68107-2200

Janet McCoy, Metro Washington Park Zoo, Portland, OR 97221-2799

Alan Baker, Burnet Park Zoo, Syracuse, NY 13204-2504

Marilyn Cole, Metro Toronto Zoo, Toronto, Ontario, Canada M1E 4R5

Lucy Segerson, North Carolina Zoological Park, Asheboro, NC 27203-9416

David Luce, Chaffee Zoological Gardens of Fresno, Fresno, CA 93728-2891

President

Vice President

Immediate Past President

### **COMMITTEES**

#### **Nominations & Elections**

Chair - Sheri Leavitt, Houston Zoo

#### **Conservation, Preservation & Restoration**

Chair - Brett Sellers, Metro Washington Park Zoo

#### **Annual Conferences**

Coordinator - Ed Hansen, AAZK, Inc.

#### **Awards**

Chair - Janet McCoy, Metro Washington Park Zoo

#### **Exhibit Design Resource Notebook**

Michael Demlong, The Phoenix Zoo

**AAZK Inspection Standards Manual** — Rachel Watkins Rogers, San Diego Zoo

#### **By-laws**

Rachel Watkins Rogers, San Diego Zoo

#### **Ethics**

Janet McCoy, Metro Washington Park Zoo

#### **Research/Grants**

Vacancy

#### **Marketing Resources**

David Luce, Chaffee Zoological of Fresno

#### **AAZK Chapter Logo Products**

Jay Christie, Cohanzick Zoo, Bridgeton, NJ

### **MEMBERSHIP SERVICES**

#### **L.I.N.K. Coordinator**

Mark de Denus, Assiniboine Park Zoo

#### **Zoo University List**

Mike Illig, Metro Washington Park Zoo

#### **Keeper Accommodations List**

Todd Cleveland, Denver Zoo

#### **Enrichment Committee**

Dianna Frisch, Columbus Zoo

**International Outreach** - Jeanette Beranger, Roger Williams Park Zoo (Chair/Coordinator Technical Assistance);

Lesa Scheifele, Norwich, CT (International Affairs); Lois Johannes, L. A. Zoo (Foreign Member Sponsorship Program); Kathy Kelly, National Zoo - Project M.A.R.C. (Making A Realistic Contribution)

#### **Animal Data Transfer Form**

Bernie Feldman, Burnet Park Zoo

#### **Staff Exchange**

Dale Frerking, Kansas City Zoo

#### **AAZK Historian**

Vacancy

#### **AAZK Training Materials**

Adrian Whitley, Burnet Park Zoo

### **PRESIDENTIAL ADVISORS**

#### **AZA Liaison**

Ed Hansen, IPP, AAZK, Inc.

#### **Bowling for Rhinos**

Patty Pearthree, Indianapolis Zoo

#### **Elephant Managers Association**

Dinah Wilson, Marine World Africa USA

#### **CAZPA Liaison**

Oliver Claffey, Metro Toronto Zoo

### **AAZK PUBLICATIONS - CONTINUING DATA COLLECTION**

#### **Zoo Infant Development Project**

Teri Maas-Anger/Maggie Liguori, Philadelphia Zoo (Birds/Nonpasserines); Kim Livingstone, San Diego Zoo (Passerines) Jeanne Stevens, Newark Museum Mini-Zoo (Reptiles); Linelle Lone, Denver Zoo (Amphibians)

**Diet Notebook, Mammals, Vol. II** - Susan Bunn Spencer, Grand Rapids, MI



# *Table of Contents*

About the Cover/Information for Contributors.....	430
From the Editor's Desk.....	431
Scoops & Scuttlebutt.....	432 - 433
From the President.....	434
Bowling for Rhinos Update.....	435
Coming Events.....	437 - 438
1995 Conference Proceedings Order Info/Form.....	439 - 440
Births & Hatchings.....	441
Legislative Update.....	442 - 445
Information Please.....	445
Selling T-Shirts to the Natives.....	446 - 452
Animal Husbandry Record Keeping	
Using Computer Databases.....	453 - 461
The Bobcats Are Back!.....	461
Book Review (The General Care and Maintenance of Day Geckos)..	462
DOWN UNDER.....	463
AAZK Announces New Professional/Contributing Members.....	464
Enrichment Options.....	465 - 466
Chapter News Notes.....	467 - 468
Zoos Join AZA Push for Safe Antifreeze.....	468
Trailside Museums and Zoo Make	
Animal Enrichment a Holiday Event.....	469 - 470
White Rhinos Reintroduced to Etosha National Park.....	470
L.I.N.K List of Regional Coordinators.....	471
Opportunity Knocks.....	472



## About the Cover.....

This month's cover art features Schlow's touraco (*Tauraco schalowi*) of the family *Masophagidae*. Pronounced (toor'-a-kos'), this magnificently colored bird is one of the 15 species and subspecies that have been bred and reared at the Houston Zoological Gardens over the past 20 years. This piece was drawn by Autumn Beckman, a volunteer in the Houston Zoo's bird department and a sophomore at the High School for the Performing and Visual Arts. Thanks, Autumn!

## Information for Contributors

*Animal Keepers' Forum* publishes original papers and news items of interest to the animal keeping profession. Non-members are welcome to submit articles for consideration. Articles should be typed or hand-printed and double-spaced. Articles may be submitted on disk by arrangement with the Editor. All illustrations, graphs, charts and tables should be clearly marked, in final form and should fit in a page size **no greater than 5.5" x 8.5"** (14cm x 22cm). Literature used should be cited in the text (Brown, 1986) and alphabetically in the final bibliography. Avoid footnotes. Include scientific name (as per *ISIS*) the first time an animal name is used. Thereafter use common name. Use metric system for weights and measurements (standard equivalents may be noted in parenthesis). Use the continental dating system (day-month-year). Times should be listed as per the 24-hour clock (0800, 1630 hrs. etc.). Glossy finish black and white photos **only are accepted**. Color slides should be converted to black and white prints (minimum size 3" x 5" [8cm x 14cm] ) before submission. Clearly marked captions should accompany photos. Please list photo credit on back of photo.

Articles sent to *Animal Keepers' Forum* will be reviewed by the editorial staff for publication. Articles of a research or technical nature will be submitted to one or more of the zoo professionals who serve as referees for *AKF*. No commitment is made to the author, but an effort will be made to publish articles as soon as possible. Lengthy articles may be separated into monthly installments at the discretion of the editor. The editor reserves the right to edit material without consultation unless approval is requested in writing by the author. Materials submitted will not be returned unless accompanied by a stamped, self-addressed, appropriately-sized envelope. Telephone and FAX contributions of late-breaking news or last-minute insertions are accepted as space allows. However, long articles must be sent by U.S. mail. Phone 1-800-242-4519 (US); 1-800-468-1966 (Canada); FAX (913) 273-1980.

Deadline for each regular issue is the 15th of the preceding month. Dedicated issues may have separate deadline dates and will be noted by the editor.

Articles printed do not necessarily reflect the opinions of the *AKF* staff or the American Association of Zoo Keepers, Inc. Publication does not indicate endorsement by the Association.

Items in this publication may be reprinted providing credit to this publication is given and a copy of the reprinted material is forwarded to the editor. Reprints of material appearing in this journal may be ordered from the editor. Back issues are available for \$3.00 each.

## From the Editor's Desk....

You will notice an additional change in this issue of *Animal Keepers' Forum*. In July of this year, we went to the larger 6 1/2" x 9 1/2" sized format and have received many positive comments on this new size. However, printing in this size also meant an substantial increase in the costs of each issue. After evaluating the costs of the journal since the July format change, the Board of Directors, in consultation with the editorial staff, have decided to reduce the *AKF* size to what you see with this edition (6" x 9"). While this is not a dramatic reduction, it is going to prove must more cost effective in the way the publication is printed and will end up saving both paper costs and press run time and charges. We estimate an approximate savings of \$1000 per month with this size reduction.

In conjunction with the original format changes in July, the *AKF* editorial staff and the Publications Funding Committee under the chairmanship of David Luce (Chaffee Zoological Gardens of Fresno, CA) undertook a advertising solicitation campaign to about 250 potential advertisers. Unfortunately, we have not received the response for which we had hoped, but will continue to do follow-up contacts with potential advertisers. It is necessary to continue to work at securing more *AKF* advertisers on a regular basis in order to be able to afford to publish the journal in its new format and, more importantly, be able to do so without having to raise individual membership fees. We ask for your patience and support as we work to not only make *Animal Keepers' Forum* a more professional publication, but also to make it affordable for the Association.

We would like to thank those of you who have already turned in your *AKF* surveys and encourage those of you who have not to please do so as soon as possible. The survey appeared in the October 1995 issue and copies may also be obtained by contacting AAZK Administrative Offices. All surveys must be returned **no later than 1 December 1995**. Associate Editors Kayla Grams and Gretchen Ziegler will be tabulating the surveys and we will report the results to you early in 1996. Your input is important, so please take a few minutes to fill out your survey and send it in now.

In previewing some of the surveys already submitted, we have found that respondents want to see more husbandry articles, more enrichment ideas, information on captive diets, and more detailed reports (including photos) of significant births and hatchings. This is where each and every one of you play a vital role - we cannot fabricate material for *AKF* out of thin air—we *depend* on members out there to make it part of their professional responsibility to share information through the pages of the Association's journal. We need to hear from you—whether it be a brief husbandry tip, a recounting of a successful birth, a report on your Chapter's activities, or a full-blown article complete with photos and charts. All of these elements are important in making *AKF* a true forum for all keepers. We will be happy to work with you in putting your material in proper form for publication, so don't let any concerns you may have about your ability as a writer keep you from contributing the information you have about the animals you work with or your institution's efforts at captive breeding. We appreciate your contributions and your continued support.

---Susan D. Chan  
Managing Editor

# **Scoops & Scuttlebutt**



## **A Last Word from the '95 Conference Committee**

On behalf of the Rocky Mountain Chapter AAZK Conference Committee, we would like to thank everyone who attended the Conference in Denver. We hope everyone had a wonderful time. We'd like to thank all of the speakers and presenters as well as our many sponsors. You all helped to make it fun and successful. Our three years of hard work seemed to pay off and we could not have done it without the help of our docents and volunteers.

AAZK, Inc.'s share of the registration fees totaled \$4,240.00 (\$20.00 of each full registration fee returns to national to help support AAZK's programs and projects).

The Rocky Mountain AAZK Chapter donated an item for our live auction in memory of Elandra Aum, longtime AAZK member from Woodland Park Zoo, Seattle, WA, who died in May. The \$165.00 raised from the auction of that item was donated to the International Snow Leopard Trust in Elandra's memory. *submitted by Vicki Sawyer, Chapter Liaison*

## **Conference Lost and Found Note**

Susan Nolan, a member of the 1995 National Conference Board, has notified our offices that a number of items, both personal and Conference-related such as notepads, etc., were left behind by delegates. If you are missing something, please call (303) 331-4114 and leave a message for Susan.

## **Operations Manuals Completed/Chapters Assist in Funding**

The AAZK Board of Directors wishes to thank the Virginia, Minnesota and Dallas AAZK Chapters for their generous donations to help cover the printing expenses of the recently completed AAZK Operations Manual. This manual delineates and clarifies the policies of the Association in relation to all aspects of its operation. Each Chapter will receive a copy of the manual gratis for use in answering questions they may have about AAZK and its policies. Each Chapter is responsible for keeping this manual with the Chapter records and for making certain it is passed along to new officers. If a Chapter loses their copy, there will be a copying fee for obtaining another.

Special thanks go to Ed Hansen (Reid Park Zoo, Tucson, AZ) and Mark de Denus



(Assiniboine Park Zoo, Winnipeg, Canada) for their time and efforts in completing the writing of the manual's text and to Janet McCoy (Metro Washington Park Zoo, Portland, OR) who handled the printing and collating of these important reference books. As policies are changed or new policies adopted, update sheets will be sent to all Chapters.

### **Hurricane Luis Wrecks Havoc on St. Maarten Zoo**

This year's severe hurricane season has caused mass destruction in a number of areas. AAZK recently received a fax from the St. Maarten Zoological and Botanical Garden in the Netherlands Antilles. This small facility specializes in animals of the Caribbean and South America and has only been open for five years. They house about 100 animals of 35 species. On 5 September, Hurricane Luis caused major damage to this facility. Careful emergency planning by the young staff prevented major loss or injury to the animal collection, but many exhibits were either damaged or destroyed. The botanical garden is totally gone and will take several years to reestablish. The major problem is the loss of all perimeter fencing around the zoo which has left the animal collection at risk from looters and hungry stray dogs. If you or your Chapter or Zoo would like to offer assistance of any kind, you may contact Zoo Manager, Mrs. Monique A.M. Kliffen at St. Maarten Zoo, Dominicanroad #1, Lower Princess Quarter, P.O. Box 531, Philipsburg, St. Maarten, Netherlands Antilles. She can be reached by phone at 011-5995-23672 or fax at 011-5995-24738

### **CHAPTER ALERT**

Please be aware that Chapter Recharter Packets will be sent out the first week in January and are due back **no later than 1 March 1996**. A \$50.00 late fee (in excess of recharter fee) will be assessed for those returned after this deadline. So now is the time to start putting together your financial records so you have them in order when the forms arrive. Once you receive the packet, if you have questions contact Barbara Manspeaker at Administrative Offices.

### **Books Available to Review**

The following books are available to be reviewed for AKF. If you are interested in reviewing any of these titles, contact Susan at Administrative Offices. Your review will be due within 60 days of receipt of the book and upon completion, the book is yours to keep.

Books available are: *Self-Assessment Color Review of Reptiles and Amphibians* by Frederic L. Frye and David L. Williams; *Our Living Resources: A report to the Nation on the Distribution, Abundance, and Health of U.S. Plants, Animals, and Ecosystems* from the U.S. Department of Interior; *Herpetology in Australia, A Diverse Discipline* edited by Daniel Lunney and Danielle Ayers; and *Minnesota's Natural Heritage: An Ecological Perspective* by John R. Tester.

## From the President

Greetings from the Lone Star State!

On behalf of the Association and all of the delegates who attended the 21st Annual Conference of the American Association of Zoo Keepers, I would like to extend our sincere appreciation and gratitude to our hosts, the Rocky Mountain AAZK Chapter and the Denver Zoo. The zoo staff, docents and volunteers worked long and hard to make this conference enjoyable and educational. I was encouraged by the sight of new faces and the return of old friends. This gathering offered each and every one of us a forum to share stories and develop new ideas.

Thanks also to Bob Wiese, Assistant Director/Conservation and Science, AZA. Mr. Wiese offered a workshop on "Understanding SSP Recommendations". This type of workshop is just the beginning of AAZK/AZA sponsored programs. At each conference we will offer a program that will enhance the development of the professional keeper.

I would like to also extend a heartfelt thank you to all of the delegates who expressed their best wishes to me and to Diane Callaway on our recent inductions as the new AAZK Executive Officers. Your support is very important to us.

Remember this is your Association. What you do can make a difference. Please participate in any capacity that you can. Write an article for the *Animal Keepers' Forum*, attend meetings or hold an office in your local Chapter. Participate in national events such as Bowling for Rhinos or attend a National Conference. Your participation in your Association will prepare you as your dedication matures, and you will find yourself as a leader of your peers. Please feel free to contact me, Diane or any one of the Board of Directors with your questions, comments or your willingness to take a more active role in AAZK.

Respectfully,



Ric Urban, AAZK, Inc. President  
Houston Zoological Gardens  
Houston, TX



# Bowling for Rhinos

## An Update



from Patty Pearthree, BFR Coordinator  
Indianapolis Zoo, Indianapolis, IN

Since 1990, BFR has raised over \$670,000.00 for Ngare Sergoi Rhino Sanctuary (now called Lewa Wildlife Conservancy or LWC) in Kenya & Ujung Kulon National Park in Java, Indonesia. Over \$109,000.00 has been raised so far this year with 10 more Chapters still needing to turn in their money. The first \$100,000.00 will continue to support LWC with the remainder each year going to Ujung Kulon.

The 1995 top money raising Chapter was once again Portland which raised \$11,398.35. The top individual money raisers were Patty Pearthree with \$1,767.00 (winners can only win the trip once). Katrina Osborne from Miami Metrozoo with \$1,488.00 and Ken Smith from Jacksonville, FL with \$850.00 were the second and third place winners and received the two-week trips to Lewa in 1996.

It is very important to remember that BFR advertises that 100% of all donor money goes to the two areas of conservation. In order for this to hold true, all donations must be sent through AAZK's BFR accounts. Ngare Sergoi Support Group (NSSG) is **not** the same as BFR. If you send your money to NSSG, 100% does not go to LWC as NSSG pays the administrative costs of BFR, pays for trip winners & operating costs of NSSG. NSSG relies on donations and memberships to cover these costs and allows our "100% to conservation" to be a selling point for Bowling for Rhinos. So remember when supporting BFR, write checks to: AAZK, Inc. and mail to:

Patty Pearthree  
c/o Bowling for Rhinos  
P.O. Box 199026  
Indianapolis, IN 46219-9026

**Now** is a great time to start thinking about BFR '96, so form a committee and pick a date so your event can go into next year's calendars! Some other BFR funds are raised through "Rock'n for Rhinos", "Rummage for Rhinos", "Run for Rhinos", "Recycle for Rhinos", or donations.

If your Chapter has not turned in their 1995 BFR money, please do so as soon as possible so that I may include it in the 1995 totals. If you have any questions about BFR, please feel free to contact me at (317) 322-8723.

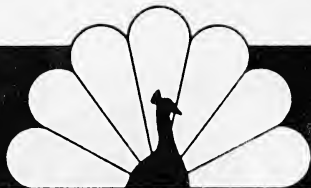

## Quality exotic animal diets

**SPECTRUM** Nutritionally balanced  
Fixed formulation • Economical

When you need a complete line of high-quality dry and frozen animal diets for your feeding program, call Animal Spectrum.

### NEBRASKA BRAND



*Frozen feline diets*  
*Frozen bird of prey diets*  
*Frozen canine diet*  
*Chunk and chopped horsemeat, hearts, livers, rib, shank, knuckle bones, and tailbones*



**SPECTRUM**

*Banana flavored psittacine/primate, 20% protein, dry*  
*Banana flavored primate, Pro-Plus 25% protein dry*  
*Leaf Eater primate dry*      *Omnivore dry*  
*Llama Vitamins & Minerals dry*      *Polar Bear dry*  
*Marmoset/Tamarin dry*      *Ratite dry*  
*Hoofstock supplement, with Selenium dry*

### BROOD-RITE HEATERS

*Bulbless heaters—nothing to break*  
*Safe around all animals and bedding material.*  
*Even heat distribution in 240, 500, or 750 wattages.*

**One call does it all**

TOLL FREE **1-800-228-4005**

**FAX 308-534-7015**

*Animal Spectrum, Inc.*  
*P.O. Box 721*  
*North Platte, NE 69101-0721*



# Coming Events

## **The Annual International Small Felid Workshop**

December 4-6, 1995

Las Vegas, NV

Co-sponsored by the San Diego Zoo and S.O.S. Care. For further information, contact Pat Quillen, 15453 Woods Valley Road, Valley Center, CA 92082. Phone: (619) 749-3946; Fax: (619) 749-1324.

## **The AZA School for Professional Management Development of Zoo & Aquarium Personnel and School for Applied Zoo & Aquarium Biology**

February 4-8, 1996

Wheeling, WVA

Schools held concurrently at Oglebay Park. For further information and an application, contact the AZA Office of Membership Services, Oglebay Park, Wheeling WVA 26003 (304) 242-2160.

## **The AZA Conservation Academy**

February 17-22, 1996

St. Louis, MO

Will be held concurrently with School for Zoo & Aquarium Animal Management, Studbook Keeper's Course, and SSP Coordinators' Course. For further information contact Debra Boyster, Conservation Academy Coordinator, c/o St. Louis Zoo, Forest Park, St. Louis, MO 63110 (314) 781-0900, ext. 297.

## **17th Biennial Pronghorn Antelope Workshop**

June 5-7, 1996

Kings Beach, CA

Sanction by the Western Association of Fish and Wildlife Agencies, the workshop has issued a CALL FOR PAPERS relative to the biology and management of pronghorn. Proposed session topics are: Management of Private Lands; Population Modeling and Survey Techniques; Capture and Translocation Techniques; Habitat Management; Genetics, Anatomy and Physiology; and Recovery Planning. An abstract of 250 words or less is **due by 19 January 1996**. Send abstracts and inquiries to Workshop Chairperson

Laura Colton, California Department of Fish and Game, 1416 Ninth Street, Room 1280-9, Sacramento, CA 95814; Phone (916) 653-6886; Fax (916) 653-1019; and e-mail 73430.210@compuserve.com.

**ZOOMANIA - 96**  
**Southeast Regional Docent Conference**

September 13-15, 1996

Gulf Breeze, FL

Focus of the conference will be educational programs and endangered species. Registration forms and hotel information is now available by contacting the Docent Council or Curator of Education at THE ZOO, 5701 Gulf Breeze Parkway, Gulf Breeze, FL 32561 or by calling (904) 932-2229, ext. 27.

**1996 AZA REGIONAL CONFERENCES**

**Central Regional** - Feb. 28-March 2, 1996 - to be held in New Orleans, LA. For further information contact Craig Dinsmore, Audubon Zoo, P.O. Box 4327, New Orleans, LA 70178 (504) 861-6112.

**Eastern Regional** - April 10-13, 1996 - to be held in Greenville, SC. For further information contact Bob Wilson, Greenville Zoo, 150 Cleveland Park Dr., Greenville, SC 29601 (803) 467-4300.

**Western Regional** - May 15-18, 1996 - to be held in Denver, CO. For further information contact Angela Baier, Denver Zoo, 2300 Steele St., Denver, CO 80205 (303) 331-5805.

***Working Trip to Madagascar.....***

In November-December of 1994, an assessment team journeyed to Mauritius and Madagascar to observe conservation projects and explore the possibilities of professional animal keepers becoming more actively involved in field conservation efforts and foreign zoos. Through our observations and meetings with the staff of the programs we visited, we have formed the basis to set "Innovative Conservation Projects" into motion. The first of these projects is being initiated in Madagascar in **April 1996**. If you have interest in participating in this project or you may want to participate in future projects, **AND** you feel that you may be able to make a valuable contribution to the projects at hand, please contact us for information regarding timeline, costs, and specific projects. Contact Project Coordinator, Barbara Palmer, Innovative Conservation Projects, P.O. Box 8, Yampa, CO 80483.

# 1995 Conference Proceedings

## Order Information

If you are interested in obtaining a copy of the Proceedings containing the papers presented at the 22nd National AAZK Conference held in Denver, CO, you will need to fill out and return the form on next page no later than **10 January 1996**. All orders **must** be prepaid in U.S. Funds ONLY. Allow 4-6 weeks following deadline for receipt of publication. Prices are as follows:

AAZK Member	\$25.00
Non Member	\$35.00

Postage for U.S. orders is included. Canadian and overseas orders should add \$4.00 for Air Mail postage to Canada and Surface postage elsewhere. Overseas orders wishing Air Mail service should add \$10.00. Make checks payable to AAZK, Inc.

Note: Individuals who presented papers at the Conference **and** submitted a manuscript for inclusion in these Proceedings will receive a gratis copy. If a manuscript was **not** submitted, a gratis copy will not be sent, and those individuals will need to order a copy.

Cost of the Proceedings was NOT part of the Conference Registration fee and delegates wishing a copy will need to order one.

**The following papers are among those included in the Proceedings:** The Western Snowy Plover Controversy Surrounding the "Enhancement" of Batiquitos Lagoon, Carlsbad, California ~ Beyond the Ark: Charting New Waters ~ Getting Involved: Keeper Participation in Taxon Advisory Groups ~ Small Scale Exhibit Renovation at the Burnet Park Zoo ~ Problems and Solutions Involved in Breeding and Rearing of the Crested Screamer, *Chauna torquata*, Including Artificial Incubation Techniques at the Denver Zoo ~ Waterfowl Breeding on a Budget ~ Teaching a Handreared Goodfellow's Tree Kangaroo to be an Educational Ambassador ~ Positive Reinforcement Training of a Crested Caracara ~ Conditioning of Nyala (*Tragelaphus angasi*) and Bongo (*Tragelaphus eurycerus*) to Blood Sampling in a Crate ~ Operant Conditioning of a Diabetic Hamadryas Baboon ~ Operant Conditioning of Great Apes ~ Initiating a Training Program with Gorillas at the North Carolina Zoo ~ THEN AND NOW - 20 years of Zoo Keeping ~ The History of the Houston Zoo Enrichment Committee ~ Red Kangaroo Management in a Five-Acre 'Walk-About' ~ Pest Control at the Cleveland Metroparks Zoo ~ Management of Rabies in a Colony of Pallid Bats (*Antrozous pallidus*) at the North Carolina Zoo ~ The Birth of Ruffed Lemur (*Varecia variegata*) Triplets in a Newly Formed Mixed Species Exhibit with Ringtail Lemurs (*Lemur catta*) ~ Lion Introductions ~ Okapi Milk Collection ~ and African Elephant Introductions at the Kansas City Zoo.

We also plan to include any other papers, workshop summaries and poster session abstracts that become available to us by our publication deadline.

Feel free to photocopy the form on the adjoining page to place your order. Phone orders may be placed at 1-800-242-4519 (U.S.) or 1-800-468-1966 (Canada) when using either a Mastercard or VISA credit card.

# Proceedings Order Form

(Please Type or Print)

I wish to order \_\_\_\_\_ copy(s) of the 1995 Denver Conference Proceedings.

# of copies x price per copy = \$ \_\_\_\_\_ Additional postage is \$ \_\_\_\_\_  
(if applicable)

Total payment for this order is \$ \_\_\_\_\_

(Make checks/money orders payable to AAZK, Inc.)

My check is enclosed \_\_\_\_\_ Please charge by VISA or MASTERCARD (circle)

Card # \_\_\_\_\_ - \_\_\_\_\_ - \_\_\_\_\_ - \_\_\_\_\_ Expiration date: \_\_\_\_\_

Name on card \_\_\_\_\_

Signature \_\_\_\_\_

Please mail to me at the address given below:

Name \_\_\_\_\_

Address \_\_\_\_\_

City \_\_\_\_\_ State/Province \_\_\_\_\_

Country \_\_\_\_\_ Zip/Postal Code \_\_\_\_\_

Send this Order Form along with check or money order or payment authorization via credit card to: AAZK Conference Proceedings, 635 S.W. Gage Blvd., Topeka, KS 66606-2066.

**Orders Must be Received by 10 January 1996**

Proceedings are only available by sending in your order form now. A very limited number of copies beyond prepaid orders will be printed. Once these are sold, complete sets of Proceedings will no longer be available. After this, copies of individual papers will be available for \$3.00 each. So **ORDER NOW!**



# Births & Hatchings



**Riverglenn Feline Conservation Park (West Fork, AR)**...announces the birth of 2.3 white tiger (*Panthera tigris*) cubs. Penny, the dam gave birth to the snow white, blue-eyes cubs on 20 August 1995. The cubs weighed about 680 grams (1.5 lbs) at birth. This is a large number of cubs for a litter. It is Penny's first litter and both cubs and dam are doing very well. *submitted by Betty Young, Director, Riverglenn Feline Conservation Park.*

**Jackson Zoological Park (Jackson, MS)**... announce the following B&H for 1995:

**Mammals** - 0.1 dama gazelle (*Gazella dama*); 0.1 Grant's zebra (*Equus burchelli bohmi*); 0.1 giant anteater (*Myrmecophaga tridactyla*); 0.1 Nile lechwe (*Kobus megaceros*); 0.1 Springbok (*Antidorcus marcipialis*) and 2.3 African pygmy hedgehogs (*Atelerix albiventris*).

**Birds** - 1.0 Ringed teal (*Anas leucophrys*); 0.1 yellow-shouldered Amazon (*Amazona barbadensis*); 2.0 Kookaburra (*Dacelo novaeguinea*); 2.1 Von der Decken's hornbill (*Tockus deckeni*); and 0.2 trumpeter swan (*Cyngus c. buccinator*). *submitted by Tom Brown, Keeper, Jackson Zoological Park.*

**San Diego Zoo (San Diego, CA)**... announces that Thelma & Louise, the facility's two headed corn snake (*Elpha guttata*) is a mother to 15 one-headed babies. The four-foot-long female was introduced to a male and mated last spring and a clutch of 16 eggs was laid on 16 July 1995. Reptile keepers transferred the eggs to an incubator, where 15 of them hatched on 17 and 18 September. The sixteenth egg was infertile. The heads of Thelma & Louise are identical twins that are connected to one body that has one spine and one set of internal organs. Even though both heads are physically capable of eating, the right head is dominant and does all of the eating. Because eight and a half-year-old Thelma & Louise was hatched in captivity, she is expected to live a normal corn snake lifespan which can be up to 21 years.

On 1 October, the Zoo also experienced the birth of a rare bonobo or pygmy chimpanzee (*Pan paniscus*). The as-yet-unnamed female infant was born to ten-year-old Kuni. Although this is her first offspring, Kuni is proving to be an attentive mother. The identity of the infant's father will not be known for several months until genetic paternity tests can be run on the two adult male chimps, Maiko and Congo, who are the most likely candidates. This birth is the second for this species at San Diego during 1995. In January, the dominant female Lana gave birth to a male named Junior. New mother Kuni sharpened her own maternal skills with Junior serving as "aunt" to the youngster.

# *Legislative Update*

*Compiled by Georgann Johnston  
Legislative Advisor  
Sacramento, CA*



---

## **Galapagos Inhabitants Block Tourists in Protest**

On 6 September 1995, residents of the Galapagos Islands blocked visitors from the Charles Darwin National Park in an effort to draw attention to the Ecuadorian government's refusal to allow the island residents to manage the tourism industry. About 10,000 people, mostly fishermen, live on the Galapagos archipelago, a wildlife haven made famous by Charles Darwin. The islands are approximately 625 miles (1,000 km) off the Pacific coast of Ecuador.

Demands of the islanders include limiting tourism to Ecuadorian citizens, with foreigners being banned from entering the archipelago. Earlier in the week, local residents took over certain parts of the Park, a popular area in the islands and one which provides a home to a number of rare species including the giant Galapagos tortoise.

In response, Ecuador's president Sixto Duran Ballen sent an urgent bill to Congress to restructure the administration of the islands. The bill includes a provision that islanders can have more say in the affairs of the islands but would keep most of the tourism industry in the hands of the Ecuadorian government.

*Source: Reuter News Service - Central and South America, 6 September 1995*

---

## **Australian State Bans Cuddling of Koalas**

Visitors to New South Wales, Australia's most popular state for tourism, will not be able to hug a koala after January 1997 if the state government has its way. The government passed the ban on cuddling, saying that it feared all the physical contact and attention was distressing the koalas and could disrupt their breeding. The ban extends to zoos and wildlife parks. Tourists will not be allowed to hug koalas but can continue to pat them while the koala sits on a designated perch.

The Tourism Council of Australia, a national governmental entity, issued a statement that there was no conclusive evidence that hugging koalas distressed them. The Council wants the state government to wait until other states agree on a national koala hugging code.

*Source: Reuter News Service - Australia & New Zealand, 15 September 1995*

---

## **South Africa Plans to Sell Ivory Once Again**

A number of states in southern Africa are developing a plan to sell ivory from their elephant herds. Boniface Mkoko, the Director of Wildlife for the Southern African Development Community (SADC) told reporters at a late August press conference that the Centre for Ivory Marketing in Botswana, a marketing system comprised of a number of member states, was in the process of developing a mechanism to ensure that ivory from non-member states did not become part of the product pool.

Mkoko stated that the members of the marketing organization have "healthy elephant populations" and that they were negotiating with the Convention on International Trade in Endangered Species (CITES) which currently bars any trade in ivory. Member states want their elephant populations moved from CITES Appendix I (which bars any trade in their products), to the less restrictive Appendix II.

SADC members promoting the reopening of ivory trade include Angola, Botswana, Lesotho, Malawi, Mozambique, Namibia, South Africa, Swaziland, Tanzania, Zambia and Zimbabwe.

*Source: African Economic Digest, 11 September 1995*

---

## **U.S. Reopens Comment Period on Spotted Owl Regulations**

The U. S. Fish and Wildlife Service (USFWS) published proposed special rules regarding the incidental taking of spotted owls in the 17 February 1995 issue of the Federal Register. The comment period was scheduled to end in September but has now been reopened and will run until 24 November 1995.

In summary, the regulation replaces the blanket prohibition against incidental taking of spotted owls with a narrower, more tailor-made set of standards that reduce prohibitions applicable to timber harvest and related activities on non-Federal forest lands in Washington and California.

A copy of the proposed rule can be found in the Federal Register or may be obtained from Curt Smitch, Assistant Regional Director, North Pacific Coast Region, 3704 Griffin Lane SE, Suite 102, Olympia, WA 98501, (360) 534-9330.

*Source: Federal Register, 25 September 1995, Vol. 60, No. 185.*

---

## **Proposed Regulations for Protection of Sea Turtles in the Atlantic and Gulf of Mexico**

The National Oceanic and Atmospheric Administration and the National Marine Fisheries Service announced that they are considering proposing regulations that would identify sea turtle management areas in the southeastern Atlantic and Gulf of Mexico and impose additional conservation measures to protect turtles in these

areas. The proposed regulations will be aimed primarily at shrimp trawlers which influence sea turtle mortality due to incidental capture in the trawl nets.

NMFS is soliciting public comment on the plan, including requests for identification of certain areas in the southeastern United States that requires special management measures and what those measures should be.

The initial report entitled "Shrimp Fishery Emergency Response Plan" may be obtained from Charles A. Oravetz (813) 570-5312 or Phil Williams (301) 713-1401.

*Source: Federal Register, 13 September 1995, vol. 60, No. 177*

---

## **Congress Protects Funding for Elephants, Rhinos and Tigers - an update**

As reported in this column last month, in July the House did vote by a 289-132 margin to fund the Interior Department's requested appropriations for the African Elephant Conservation Fund (\$600,000.00) and the Rhinoceros and Tiger Conservation Fund (\$200,000.00). These amounts are about half of the amounts authorized for the prior fiscal year.

House Speaker Newt Gingrich (R-GA) spoke against an amendment to eliminate all funding and stated: "This is an amendment which means well, but I think does wrong. This is a very small amount of money, but it is symbolically very important...in part for the signal that it sends to people, particularly in Africa and Asia, about whether or not the United States is prepared to reach out and be helpful. We do not have to cut mindlessly just because we want to get a balanced budget."

*Source: FOCUS, a newsletter of the World Wildlife Fund, Sept./Oct. 1995, Vol. 17, No. 5 and African Wildlife Update, a publication of the African Wildlife News Service, Sept./Oct. 1995, Vol. 4, No. 5*

---

## **Saudi Arabia Takes More Aggressive Approach to Environmental Care**

Saudi Arabia's National Commission for Wildlife Conservation and Development (NCWCD) is undertaking an ambitious plan to create environmental awareness throughout the Kingdom, especially in remote areas. The NCWCD has trained rangers and scouts who have undertaken the distribution of books, informative bulletins, and other materials on conservation and environmental issues to citizens of villages and towns throughout the country. The major emphasis in this program is pollution control and improved sanitation and hygiene among the Saudi population. A separate program developed by the NCWCD is to develop precautionary measures to protect the land and marine environment from any eventuality of an oil spill in the future.

Furtherance of a previously limited plan to reintroduce rheem and Arabian oryx in the Uruq Bani Ma'arid protected area has been initiated and the proposed locations have been identified. Four ranger stations with vehicles, radio communications, and staff qualified to spread the message of environmental protection generally

and protection of these two species in particular have been established to maintain a constant vigil in the protected areas.

The Commission has also developed plans for a permanent center for sanctuary management, marine research and education. The plan includes an exhibition hall, museum, and educational resources on marine life protection techniques, environmental awareness, and improving zoological collections. One of the first goals of the center will be to evaluate the data gathered in a recent inventory of terrestrial reptiles and mammals which reside in the immediate vicinity of the proposed sanctuary area. Marine species have also been given some attention with a continuing program to capture, mark and release green and hawksbill turtles for purposes of evaluating populations and related ethnological data.

The commission receives some support from UNESCO, particularly with respect to training programs on protected areas management in the Arab world.

*Source: Moneyclips, 13 September 1995, reprinting an article from the Riyadh Daily, the national newspaper of Saudi Arabia*

---

## Information Please

Requesting ideas and creative solutions to control excessive and uneven bill growth in cranes or other long-billed birds. Goal is to reduce trimming and handling time by providing cranes with a means to self-maintain their bills. Please write or fax: Nancy Businga, Aviculture Dept., International Crane Foundation, P.O. Box 447, Baraboo, WI 53913-0447; FAX (608) 356-9465.

---

Can anyone provide us with information on whistle training black-backed jackals (*Canis mesomelas*) to come in at night or any other methods used as an option to running the animals in? We are also interested in any non-food enrichment used with these animals. Please send information to: Beth Moore, Kansas City Zoological Gardens, 6700 Zoo Drive., Kansas City, MO 64132.

---

We are looking to compare fruit dove handrearing diets and methods from other institutions which have successfully handreared fruit dove from hatch. Please include diet ingredients, protocol, success rate and fledging age for each species. Send information to the Avian Propagation Center, Zoological Society of San Diego, P.O. Box 551, San Diego, CA 92112-0551, Fax: San Diego Zoo Hospital (619) 230-1256; Phone: (619) 557-3975.

# *Selling T-shirts To The Natives:*

A paper on public education  
Presented at the 1995 Lone Star Keeper Symposium

*by Harry F. Noyes III, Volunteer Docent  
San Antonio Zoo, San Antonio, TX*

The title of this paper, "Selling T-shirts To The Natives," recalls an anecdote I read many years ago in Reader's Digest. It concerned a World War II military chaplain appalled to see Pacific-island women walking around topless in front of American GIs. He obtained a shipment of T-shirts and passed them out to the native women, who accepted them gratefully.

The chaplain was relieved and quite pleased with himself, until he saw the women a few days later. Each woman had carefully cut two holes in strategic locations on the front of her T-shirt.

As zoo educators, we are somewhat like that chaplain. We try to influence a public whose values and thought processes are so alien to us that they (or we) might just as well be from Mars. Even when we think we are getting through, we may just be giving them new ammunition for their misunderstanding.

It does not help that we are trapped between two opposing prejudices. We are flanked on one side by a public blithely indifferent to the survival of the biosphere. On the other side stands an animal-rights movement that wants the human race to leave planet Earth and regards zoos as part of the problem instead of part of the solution.

Our only allies are a beleaguered few mainstream conservation and environmental organizations. No, let us call them moderate, not mainstream. "Mainstream" falsely suggests that we enjoy wide public understanding and support. But are these allies helpful?

Environmentalists who boldly boasted just months ago that the American public was environmentalist, now stand dazed and reeling before the magnitude of their rejection in the 1994 elections. Perhaps the elections were not about environmental issues, but the results are unquestionably harmful to the cause; at least as that cause is defined by most environmental groups.

Those groups now stand on the defensive, trying to salvage tattered remnants of the Endangered Species Act. I have predicted for several years that this would happen. I warned friends that if environmental organizations continued to ignore human economic interests and push the Endangered Species Act to its limits for marginal animal types (types so obscure in some cases that one may question the legitimacy of classifying them as separate species); the American people would simply abolish the Endangered Species Act.

Unfortunately, a salient trait of political fanatics of all stripes is the SFL, or Severe Failure to Listen syndrome. People like this are so busy feeling smug, self-righteous, and superior that they cannot perceive the rising anger of a public whose greatest concern is always its own short-term economic interest.

That public recently has been speaking out in public hearings all around Texas. And they are there to demand better protection for their own property rights, not for Mother Nature.

Is there basis for compromise, for reconciling the seemingly conflicting needs of nature and economic man? One must hope so. But to win and hold the support of the American people it must be a scheme to protect truly distinctive kinds of creatures, and it must be at very little economic cost to the public. I think such a compromise is possible, but what its details might be are beyond my expertise and certainly beyond the scope of this paper. This paper will focus on how zoo people can help our fellow citizens work towards such a worthwhile, sustainable compromise. It seems to me that zoos will play a critical role in this process, or rather they can, if they seize the opportunity.

Perhaps I am too pessimistic, but I suspect the environmental and conservation groups may prove a weak reed for some time. They will lose many shell-shocked supporters to despair, weakening the organizations financially and politically. Extremists will battle for the movement's soul, driving more and more moderates away. Historian Crane Brinton observed that revolutionary movements are characterized by a momentum towards extremism. He called it "no enemies to the left."

Moderates are accused of being reactionaries, are afraid to defend themselves, and are driven from power by more extreme leaders---who are in turn ousted by even more extreme people. We have already seen this effect in parts of the civil-rights and women's movements. I think I detect a touch of such a shift to the left in the environmental movement, for example in editorials in their magazines. However, I am not sufficiently well-studied in this area to insist upon the point.

Perhaps it won't be as bad as I fear. Just in the past few weeks there have been some news reports suggesting that perhaps some environmental organizations are already waking up. Some of them seem already to be adjusting their platforms to accommodate political realities by showing a newfound appreciation for something like the so-called "wise-use" concept. However this may turn out, it is clear that many Americans regard environmentalists as radical wackos. At best, it will take time to overcome that.

That leaves us, the zoo people, as the centrist sheet anchor to which the hopes of environmental protection must cling. The American people accept us. True, they accept us mainly because they do not understand us, because they still see us as a "bread-and-circuses" spectacle for their entertainment. Also, they accept us partly because they are reassured by the very contempt in which some animal-rights extremists hold us.

Whatever the reason, the critical fact is that they do accept us. We can exploit that fact to hold down the moderate fort until environmental organizations regroup, refurbish their platforms, and start to win back the American people's hearts. After that we can continue to hold a leading position in the environmental movement and help keep it on a common-sense path.

Okay, accepting for the sake of argument that this analysis is correct, what then should zoo people be doing with our special entrée to the hearts and minds of the American people? The answer is that we should continue doing pretty much what we have been doing; but with more focus, more intensity, and an ever-increasing application of imagination and creativity. Our methods are basically sound, but we need to continually improve them. We also need to refine the content of our messages to reach new and more influential audiences.

Zoos long ago realized that their primary reason d'être is to 1) preserve endangered species against the hoped-for day when they can be reintroduced into the wild and 2) educate the public on the vital importance of preserving our wild heritage.

Active species preservation, the Noah's ark mission, lies outside my knowledge and the scope of this paper. I will only note that it will doubtless become even more important. There may be many more endangered species to protect, at home and abroad, as tree-huggers reel before the onslaught of checkbook-huggers. In the area of education, however, I can offer some more detailed and concrete suggestions.

First, let us examine again the concept of focus. I think it is impossible to overestimate the importance of focus to success for individuals or groups. There is an excellent zoological metaphor. We have all seen film of lions chasing zebras; and been astounded to see a lion dash right past a zebra much closer than the one she is chasing. Evolution has taught lions that success is more likely to attend the dogged, focused pursuit of one well-selected zebra than it is to result from a series of mad dashes after many different zebras. So it is with human effort.

Zoo educators must pick a target and focus all their efforts on it. It would be nice if we could conduct formal surveys to determine what the public really needs to know and what actions would most effectively influence it. Lacking resources, we must just follow news reports, listen to our friends and neighbors, and use common sense to determine what messages we need to sell.

We need to decide what we want the public to know, to care about, and to do. We need to pick audiences more systematically. It's great that we reach huge numbers of school children, but they are too young to save species that are dying right now. We must also reach adult political influences. When is the last time you have taken a presentation to a Rotary Club meeting?

Having determined our message and audience, we must then decide how best to sell our T-shirts to the specified natives. Let's start by facing reality. The majority of Americans do not really care about nature, wilderness, species survival, biodiversity, the beauty and personality of animals, biological knowledge, or any of those values



held so dear by the people reading *AKF*. Most Americans care mainly, if not exclusively, about their own comfort, convenience, and prosperity. We cannot win these people over by direct appeals to their better nature. They would simply cut holes in our T-shirts.

To accomplish our mission, we must be guerrilla warriors of conservation. We must use our entertainment value as a loophole through which we can infiltrate American hearts and minds. We must then subvert their selfishness, gradually and subtly reforming the national mindset over a period of some years. To do this, we must accept the old salesman's adage that people buy for their own reasons, not ours. This means we must focus our message overwhelmingly on the interests the general public holds dear, its own health and prosperity.

We must never miss a chance to stress biodiversity's role in protecting human health and economic well-being. Always citing all the arguments we know so well such as organism-derived medicines, the availability of disease-resistant food strains for cross-breeding, the value of wilderness and wildlife to tourism, etc.

So what's new? We already hit these points, because we see their importance instinctively. Still, there may be some value in stressing explicitly that this is the **only** approach that will create any immediate and significant sense of concern or urgency about species preservation in the average American's mind. To maximize our effectiveness, we must redouble our efforts to include these points in all our contacts with the public.

When we organize any educational program, whether it be a school visitation or a casual walk through the zoo to answer questions, we must focus the effort on a specific high-value selling point; not just an animal type or whatever the public sees fit to ask us about. We must guide and lead any discussion and make sure it heads somewhere important.

When we show a frog to the public, we must break the habit of saying, "This is a man-eating African dragon toad, an amphibian, much like the toads in your yard that are one-tenth his size...blah..blah...and by the way (as they wander off, having already forgotten us) they're important because they have chemicals in their skins and they're all dying off all over the world."

We must turn the traditional message on its head: "We want to show you one of the most important animals in the world, an animal your life may depend on some day; that is if we get smart and stop killing them all with pollution. All amphibians have powerful chemicals in their skins, and some of these chemicals have turned into valuable medicines. Scientists think we can get more medicines from amphibians like this toad. Unfortunately, amphibian populations are dropping all over the world. Nobody's sure, but we suspect pollution is the cause. We'd better keep these animals alive for our own good. Zoos are trying to save amphibian species by breeding them in captivity, but there aren't enough zoos to save them all. So it's really important to preserve their wild habitats all over the world."

Every contact with the public should be governed by a simple but carefully designed lesson plan based on a comprehensive zoo education ideal. Each plan must support a major theme of the local zoo's mission, which will usually include (but need not be limited to) such global themes as biodiversity, habitat and wild species preservation, captive breeding, etc. In support of the theme, the lesson plan will have one or more key points to be explicitly discussed; and some specific natural history comments that are selected to support and enhance those key points.

In other words, we need to get organized and hard-sell these points because soft-selling them probably isn't going to work. However, a hard-sell approach is only effective for messages people will immediately and unquestioningly agree with; the ones directly affecting their health and welfare.

The subversive messages on more esoteric themes, things we care about and which we hope the general public will someday learn to care about, must be sold much more subtly. To a degree, merely exposing people to animals is a potent soft-sell approach. However, we must identify, adopt, and consistently employ certain proven tactics for enhancing and expediting that effect.

The wildlife rescue group I work with has a firm rule: no one ever calls an animal "it". Even if gender is unknown, staffers and volunteers always refer to the animal as either "he" or "she". Usually before the conversation is over, the caller is using the same terminology and is expressing much more concern about the animal's welfare, and not just about human convenience.

The psychology is sound. The language used in talking about animals predisposes people to think of them either as things or as living beings like ourselves. For wildlife rescuers and zoo people alike, it is desirable to encourage the public to think of animals as living beings. As non-human persons with minds, feelings, and lives that are worthwhile in their own right.

This is where a little harmless subversion comes in handy. Many people are not ready for the notion of animals as living beings with a value in themselves, let alone as persons with minds and feelings. Let's be fair, until recent years even most scientists opposed any discussion of animal mentality as baseless anthropomorphism. It's hard to see how anyone who ever owned a dog could fail to see the personality and the intelligence there, but some did. Today, thankfully, more and more evidence is being amassed for consciousness, thought, and feeling even in such animals as turtles and cephalopod mollusks. Few biologists now doubt the existence of brain work in birds and mammals, though arguments over the extent of that brain work continue to flourish.

This isn't really anthropomorphism. It's more accurate to call it the animalization of *Homo sapiens*, a belated recognition that we share many behavioral and psychological traits with our animal cousins as well as physical ones. Much of the public is still not ready to hear that. But people will listen to anecdotes about particular behaviors. Such stories can slowly break down their prejudices and pave the way for recognizing animals as sentient beings. And that paves the way for the idea that animals have lives that are valuable, regardless of their usefulness.

With well-chosen true stories, zoo educators can conjure for the public an image of a vibrant nature full of personality and interest, of creatures with whom human beings can enjoy fascinating interactions. In short, we can make animals more fun and prove they are worth having around, just to enrich our spirits, even when they have no direct economic value. And that is a powerful, profoundly subversive notion that may eventually lead to a whole new ethic for human interaction with the wilderness and its creatures. At least we hope so.

Therefore, all zoo educators should arm themselves with a plenitude of anecdotes to illustrate the personality of individual zoo animals, and more generally of their cousins in the wild. Also, every individually identifiable animal in a zoo, not just the lions and elephants, should receive a personal name. And the names should not be a secret of the zoo staff; names should be posted on enclosures along with photos or descriptions to enable zoo-goers to identify individual animals. Furthermore, the signs should include personal histories of the individual animals and brief descriptions of any individual personality or behavioral traits that distinguish them.

Incidentally, signs are the most important single tool zoos have for reaching the public. Live educators can only reach a tiny percentage of zoo-goers, but signs reach all of them. Zoo educators must be involved in developing signage and ensuring that it is not only comprehensive, accurate, and effective; but also that it reflects the important messages we are selling.

However, in all these efforts, we must be careful not to lose sight (or let the public lose sight) of the fact that animals are still different from us in many ways and need their own special places and ways of life to flourish. As educators we must walk a tightrope, personalizing animals without humanizing them.

There is one more "subversive" step zoos should take whenever possible. Experience shows that the critical step in converting people to a new faith (religious, political, or environmental) is to persuade them to commit themselves to some concrete action.

The first step must be easy and cost-free, a step that does not require them to sacrifice their self-interests; because at this stage they will reject the new faith if it demands very much of them. Once the first step is taken, and they feel the joy of believing and acting on that belief, they will begin to gravitate towards ever greater commitments of thought, word, and deed. Yet the first step must be a real, personal contribution to preservation of the wild kingdom. It cannot be simply the easy cop-out of dropping a few dollars in a donation bucket. Not that there's anything wrong with collecting money too if you can.

To nudge people to this decisive action stage, zoos must become active promoters of the protection of local wildlife; since that opens the door to things zoo visitors can actually do. Every zoo should have an integrated local wildlife exhibit. "Integrated" means this must not just be a few animals scattered in cages all over the zoo. It must be a well conceived educational center, with an emphasis on local animals that are endangered, threatened, or distressed by human activity.

There should be information people need to know about the rarity of wild rabies, the danger of taking baby animals home, the pest control services performed by snakes and bats, etc. There should be a prominently displayed list of concrete steps individuals can take to protect wildlife, such as driving slower at night (a chart comparing how fast a raccoon can cross a road to how fast a car arrives after its light become visible, for example.) Finally, there should be handouts of similar information and of literature for local wildlife groups which can answer additional questions or come to the aid of distressed wildlife.

While desirable, it is not really necessary to display living animals in such an exhibit. The exhibit could be something as simple as a hall of placards people must pass through on their way to the ticket booth, or a series of placards erected in high-traffic areas such as snack bars and restrooms.

A child who saves a raccoon by getting their dad to slow down on a wooded road will probably grow up wanting to save gorillas from poachers. Action, however small, begets more action; a psychological principle we should be exploiting more fully.

To summarize:

The world's animals face unprecedented and unremitting peril from human activity, just as the American people are drastically reducing the priority they place on protection of the biosphere. At this critical moment, and perhaps partly in explanation of it, environmental organizations have largely forfeited public confidence by refusing to compromise with economic realities.

As a result, zoos are uniquely positioned to take over leadership of the conservation effort, exploiting their public popularity to get the necessary medicine down the public's throat. As educators, zoo people must learn how to package that medicine for maximum effectiveness without forgetting to include the spoonful of sugar that helps the medicine go down.

Some simple, inexpensive tools can be applied to that task very effectively. Some are already in wide use, some crop up sporadically but need to become universal, others remain to be invented by the fertile minds of zoo educators.

However, these tools will win real victories in the historic battle for conservation of the wild kingdom only if zoo educators know where they want to go, and have a plan for getting there. We must be more purposeful, more focused, more consistent, and more systematic. We must have a greater sense of urgency.

We face a challenge of historic proportions. If we accept it, we can make a difference of global importance to humankind and all the biosphere's creatures. If we fail, we will live in a deeply impoverished biological world. **WE MUST NOT FAIL!**

# ***Animal Husbandry Record Keeping Using Computer Databases***

*by Greg Shortess, former Information Systems Manager  
Oregon Coast Aquarium, Newport, OR*

In an ideal world, we could track just about any piece of information about our animals without using paper. Anyone with a need to know could walk up to the nearest computer and locate that information quickly. When the boss or a colleague asks for “everything you have on *Anarrhichthys ocellatus*” or any number of other facts such as medications used, feeding history, blood test results or water quality charts, you could extract the data in minutes and produce a finished report in less than an hour. Sound like fiction? It’s not. This is *exactly* what we’ve done at the Oregon Coast Aquarium.

This article will outline how we’ve implemented an electronic record-keeping system at the Aquarium and show how such a system helps the keepers here on a day to day basis. Obviously everyone’s circumstances are different. However, this should provide some insight into what’s involved with going “paperless” and demonstrate some of the awesome potential available through the use of the relatively inexpensive computer technology available today. If you are new to computers, don’t worry. It takes time to get used to them and to understand how they can manage the information you need to get things done.

Computers are tools for processing information. Routine tasks, such as sorting and filing pieces of information, are handled by the computer in terms of nanoseconds. Searching through large sets of data (databases) are similarly fast. For those of you who do your record keeping on paper, consider for a moment how many staff hours are spent moving information around your department. Filling out forms, copying information from one place to another, filing, making sure the files won’t get lost or destroyed. Then ask yourself how easy it is to get at that information. What do you have to do when you need to put together a report or chart? And where would you be if something destroyed your paper files?

In animal husbandry, we want to collect and record all kinds of information about the animals we’re taking care of and then we want to see that information in a way that helps us optimize the care given to those animals. This is our basic goal when we talk about electronic record keeping for zoos and aquariums. It’s not just about collecting the data, it’s about making the data available to the staff who need it in a way that’s easy to use, reliable, and meaningful. With a computer system, keepers can search, collate and produce reports and charts that chronicle aspects of each animal’s history. This can identify trends in animal health and behavior, help form care and treatment plan, and provide valuable research data to others.

Most of you keep or have kept records on paper, so you are already aware of some of the problems with paper records. They are bulky, require a lot of handling to process, may get lost or destroyed or worse, may wind up never being used. Paper records also make it a very tedious and time-consuming process to search and collate the data. For example, how long would it take you to produce a chart of white blood cell counts for the past year for a particular animal? How about a case history of each animal in a particular exhibit, or all the animals that have been given a particular drug? Would it take a day? A week? Or do you just laugh at the idea? With the information stored in a computer database, you could produce any of these reports in about an hour.

Another important advantage to computerized record keeping is that the information is stored in a central location but can be accessed by any authorized computer on the network. Access is restricted only to those who have a valid user name and password. The database files are backed up daily and the backup tapes are rotated off-site so the information can never be lost, stolen, or destroyed.

On the downside, the initial cost of hardware can be high, especially if your organization has older computer equipment or lacks a network. But consider what it's worth to have the complete history of your collections online 24 hours a day. Figure how many staff hours are spent a year processing the information you keep now - costs of paper, storage space and time spent working with the paper records. Consider that a computer can be used to do things besides track animal information, such as word processing and spreadsheets. Today computers are considered by many to be just another machine necessary to get things done, like photocopiers and fax machines, and networks are the logical extensions of those computers.

Other obstacles you may encounter are apathy or technophobia. People often resist change simply because they don't have the time or desire to learn something new, or they're frightened by what they don't understand. One way these attitudes can be changed is by breaking the project down into smaller steps and let the users accomplish each step in turn. When people see they *can* do the smaller steps, they realize the change wasn't that bad after all. Another way to overcome resistance is to take the lead, demonstrate that the technology works and then let others join in. If people can see something work, they'll be more inclined to trust it and work with it.

### Software search

If you decide to pursue a record-keeping system, finding software to meet your needs is the first step. Your computers are only as useful as the software they run. Figure out what you want your ideal database to do. Make a list. If you don't know anything about software, find a co-worker who does and who can help you look at what's feasible. Then consider one of three approaches:

- 1) Buy a commercial program that will hopefully do most, if not everything, you want it to do. This approach gets you up and running quickly but you

will probably run into limitations either in capacity or functionality or both. You will be using a program designed by someone else who may or may not be familiar with your needs. Be sure to read the fine print and check the return policy. Watch out for programs that limit the number of records you can enter, are not well documented, or have not been around very long. Ask yourself questions like: How well does it run in a multi-user environment? How much disk space does it require? Will it run properly under Windows or other popular platforms you may be using? What kind of support does the vendor offer? Do not be afraid to ask questions until the answers make sense.

- 2) Develop it in-house. Find the nearest salaried programmer on the payroll and find a way for them to write a program for you. This is a relatively low-cost method that can provide good results depending on the capabilities of the programmer. On the downside, it can take some time to develop especially if the programmer has to start from scratch or has a lot of other things to do.

If you wind up being that programmer, take the list of features you want and break it down into its basic parts. Give each one a priority and your best estimate of how long it will take you. Be conservative. Then multiply each of those times by three. That's how long you can expect to spend, even with the best of programming tools.

- 3) Hire a consultant to do a custom job. Most expensive method, good results as long as everyone understands *exactly* what you expect and agrees on how much it will cost ahead of time. Can take just as long as an in-house programmer and may not produce the results you wanted. You can also run into problems maintaining or enhancing the program in the future if the consultant closes shop, raises his rates or simply gets too busy to accommodate changes in a timely manner.

Another important consideration is that most of your staff's time will be spent in making sure that the information in the database reflects the real world. This means updating the information in the computer whenever something happens to the animal or the exhibit. If you don't pay attention to this, you'll wind up with a bunch of meaningless information. This is what is meant by the computer axiom "Garbage in, garbage out." For example, if you don't maintain your animals-by-location matrix, when you go to run an inventory report it will be useless. Likewise if you constantly misspell or use different abbreviations for, say medications, searching for them later will become a problem. It is a good idea to set some naming conventions and get people used to using them.

When choosing your source for software, bear in mind that computers are only as good as the software they run, and the software is only as good as its ability to deliver the information you need.

### A little history

The Oregon Coast Aquarium has been open to the public since May 23, 1992. During the first three years, two million visitors have had the opportunity to see and learn about creatures native to the Pacific Northwest. Our focus is on regional wildlife - sea otters, sea lions, tufted puffins, wolf eels, jellyfish, salmon, frogs, turtles and others. The collections are grouped into four sections: 1) fish and invertebrates, 2) mammals, 3) birds and 4) herpetology. The Aquarium currently employs seventeen animal husbandry staff members and several interns.

Right now we have a total of 38 computers, nine of which are assigned to Husbandry staff. All computers are a 386 or 486 based machines. All but two are equipped with at least 4Mb RAM, SVGA color monitors and Windows. All the computers are connected to a local area network (LAN) which supports everything from word processing to accounting. A LAN makes management and sharing of resources much easier. We currently use Novell™ Netware v3.12 running on an Ethernet 10BaseT topology.

Early in our development, I conducted a "needs analysis" of all departments to find out what kinds of things people needed our computer system to do. Animal husbandry staff wanted an electronic record-keeping system. They had a somewhat sketchy vision of what they wanted it to do, mainly because they weren't sure how far they could go with it.

At that time, the only software we could find for the MS-DOS environment was the "ARKS" software put out by ISIS. Soon after buying the software, we found that it would not meet our needs. It was designed primarily to track veterinary and pedigree information for mammals, and provide census data to ISIS. Unfortunately at the time it had no capability for tracking fish and invertebrate information, something critical to daily operations at an aquarium. It also lacked key features that we wanted such as free-form notes and the ability to track exhibit information, such as water quality test results and exhibit maintenance, independently of the animals.

As a programmer, I knew what we wanted was possible, and it was clear that our best course was to develop our own database. When you develop your own program, you get exactly what you want and have the ability to change it to meet future needs. You are not dependent on an outside entity for program changes and features and you can make the software fit the way you handle your specimens instead of changing your procedures to satisfy the program.

The next step was in finding a reliable database platform on which to build. As the Aquarium's full-time Information Systems Manager, I was also working on providing applications for our membership database, group scheduling and others. For those I was using a product called Clarion™ Database Developer. It was a natural step to also use Clarion™ to also create our own custom record-keeping system.



Clarion™ is a “fourth generation” general-purpose programming language specifically designed to develop databases. Its programs run very fast and use an extremely reliable relational database file format (Clarion™ currently supports other file formats such as btrieve™, dBASE™, Paradox™, and others) and features an easy-to-use design interface. Some major features of Clarion™ are:

- Create stand-alone executable programs. No run-time libraries or royalties needed.
- 100% MS-DOS compatible
- Network ready. Shared files allows an unlimited number of simultaneous users to access the system with no extra programming.
- Record length and file sizes limited only by available disk space. After three years of daily use, the entire 80 module database takes up 25Mb (Megabytes) of disk space.

There are many other database development programs available on the market today. Clarion™ is just one of them. There are advantages and disadvantages to each. If you are contemplating creating your own system, examine the options, requirements and limitations of each system. Then investigate those that appear to meet your needs. Evaluating demos, talking to computer professionals and salespeople, or reading literature are just some of the ways to find the one that's right for you.

### A quick tour

So how does the program work? Basically, the session begins with logging into the network as normal. Only those who have been given rights can access the husbandry database and its related files. This ensures that only those who have a need to know can get at the information. When the program is run, all data files and their associated key and memo files are opened for access (takes about 4 seconds). {see Figure 1}

The keeper enters his or her initials and selects the section they want to work in (for example: fish and invertebrates). From then on all records they see or add will relate to fish and invertebrates. {see Figure 2} The user then selects the function they want from the pull-down menus.

All databases process records using “tables” and “forms.” A table is a list that shows a bunch of records at a time. {see Figure 3.} A form is what is used to view, update, add or delete a single record. So you browse through the records in the table, highlight the record you want to work with and press “Enter” (“Return” on some keyboards). The information in the record is displayed and may then be edited. If instead of “Enter” you press “Insert”, it adds a new record. Likewise pressing “Delete”, deletes the record after asking you for confirmation. Couldn't be easier. Other functions such as searching, printing

Records Headers Maintenance Exit

Animal Husbandry Database  
Oregon Coast Aquarium

(C) Copyright 1993-1995 Greg Shortess  
All rights reserved.

WARNING

The information contained in this database  
is CONFIDENTIAL and for Aquarium use only!  
Violators may be subject to disciplinary  
and/or criminal prosecution.

Press any key to continue.

Figure 1: The introductory screen and main menu of the Oregon Coast Aquarium's husbandry database.

Records Headers Maintenance Exit

Initials : GS                      Fins  
Database : Fins Fur Feathers Herps

( K )

Figure 2: The keeper enters his or her initials and selects which section they want to work in: fish and invertebrates ("fins"), mammals ("fur"), birds ("feathers"), or herpetology ("herps"). For the rest of the session, all records they see or add will relate only to the section selected.

reports and exporting data, are done with "Control" or "Alt" key combinations or may be assigned to the function keys F1 through F12. Any of these functions could also be assigned to items on the menu.

Comments						
Time	ACode	ECODE	Case	Kpr	Type	
↑ 6/23/95		SEC		PD	EM	RESERVOIR WATER TEMP IS UP TO 58F. PLEASE USE CAREFULLY AND MINIMALLY IN ALL AREAS BUT SANDY.
6/23/95		KELF		PD	EM	BACKWASHED KELF WITH FSW. DID NOT DO CARTRIDGE FILTERS NOR Y SCREENS.
6/22/95		TFS	OJPS	145	PD ML	ADDED 375 MG NALAGRAM TO TANK = 10PPM NALADYXIC ACID. FLOW OFF ALL DAY. DR. BROWN WOULD LIKE US TO DO A GILL SNIP AND SWAB OFF WOUND. DISCONTINUE NALAGRAM C/O PD DUE TO LACK OF FEEDING, WATER QUALITY. PLEASE FEED. DID NOT EAT ABS TODAY.
6/22/95		WE94-4	WOLF		AMC AD	TODAY HE ATE SQUID FOR THE SECOND TIME EVER, THE FIRST BEING JUST TWO DAYS AGO. HE HAS TO COMPETE STRONGLY WITH WEL, AS SHE IS AN AGGRESSIVE FEEDER.

↓

F1-Help F2-Log ^Report Fins

**Figure 3: The table of keeper's comment records. Note that each record has a date and time. It can also be tagged with a seven-character animal code, exhibit code, case number, keeper initials and comment type for easy searching. Codes are assigned by the keepers themselves and are not hardcoded into the software. The notes can be viewed by date, animal code, exhibit code or case number.**

One of the main features is the free-form comments and keepers' log. With it, keepers can record information that applies to an animal and/or exhibit by entering the date and time and identifying the comment by animal code, exhibit code, type, case tracking number and/or keeper's initials. A similar but even less structured module is a general log that gives keepers an area to enter more general notes or subjective observations. Any log entries can be copied to the comment area if they are pertinent to an animal's history.

Every record is automatically put into order as it is entered. No separate indexing or building of keys is needed. As the information is entered at one station, it is immediately available to any other station. This means that right out of the box, Clarion™ databases support unlimited simultaneous user accesses and updates, which is extremely important in a networked environment. It uses a compare-record and record-lock-during-commit process to accomplish this. In the three years I've been using Clarion™ I have yet to encounter a problem with it's performance on the network.

We have modules for accession records, feeding records, blood test results, exhibit records, water quality tests and daily weather data. We also track all accession and disposition information and use a location matrix to keep track of which exhibits hold which animals. {see Figure 4.} Running current inventory reports of accessioned animals is a snap. {see Figure 5.}

Location Matrix

	Common Name	mm.ff.uuuu	ECode
f WALL	WALLEYE SURFPERCH	00.00.0001	SC
WCL	WHITE-CAP LIMPET	00.00.0009	RC
WE1	WOLF-EEL (F)	00.00.0001	WOLF
WE94-1	WOLF-EEL (F)	00.01.0000	FHC
WE94-2	WOLF-EEL	00.00.0001	KELP
WE94-3	WOLF-EEL (M)	00.00.0001	WOLF
WE94-4	WOLF-EEL (M)	00.00.0001	FHC
WEJ2	WOLF-EEL, JUV.	00.00.0001	RS-05
WHIP	SEA WHIP	00.00.0003	RS-05
WPD	WHITE PLUME DORID	00.00.0001	TV
WS	WHITE STURGEON	00.00.0005	SP
WSC	WHITE SEA CUCUMBER	00.00.0012	IWC
WSP	WHITE SEAPERCH	00.00.0001	SC
WSRA	WHITE-SPOTTED ANEMONE	00.00.0002	RC
YELL	YELLOWFIN SOLE	00.00.0001	LD1
YEYE	YELLOWEYE ROCKFISH	00.00.0001	KELP
YEYE	YELLOWEYE ROCKFISH	00.00.0001	REEF
YSC	YELLOW SHORE CRAB	00.00.0008	RS-02
YTRF	YELLOWTAIL ROCKFISH	00.00.0001	KELP

F1-Help Report

Fins

Figure 4: The location matrix ties together the animal code and quantity with the exhibit code. The table can be viewed alphabetically by animal code or by exhibit code.

10/13/95

Oregon Coast Aquarium  
Animal Husbandry Accession Records  
Fins

11:21AM

Accessn	Scientific/Common Name	mm.ff.uuuu
G910093	CNIDARIA ANTHROZOA ACTINIARIA ACTINIIDAE ANTHOPLEURA XANTHOGRAMMICA GIANT GREEN ANEMONE	00.00.0443
G910096	ECHINODERMATA ASTEROIDEA SPINULOSIDA ECHINASTERIDAE HENRICIA LEVIUSCULA BLOOD STAR	00.00.0033
G910102	ARTHROPODA CRUSTACEA DECAPODA CANCRIDAE CANCER OREGONENSIS OREGON CANCER CRAB	02.01.0002
<b>Total .....</b>		<b>02.01.0478</b>

Figure 5: A sample page from an inventory report on accessioned animals in our collection. Reports may be viewed on the screen, sent to the printer or saved in a file. All quantities are totaled by gender.

In the near future, we'll be expanding the acquisition and disposition tracking, adding overlay templates for the free-form comments, and some more reports. I've found making changes to existing Clarion™ programs relatively easy. This is important because I have a lot of other things to do besides writing programs!

This system is a natural result of what happens when computer staff and husbandry staff come together with a "can do" attitude. The technology is there; you just need someone to sit down and mold a program to do what people want. It makes the investment in computers and networks pay off in the long run. We now live in a time in which powerful data-processing machines sit on our desks, and networks spring up everywhere like bacteria blooms. This is the Information Age. The question to ask is: *How can we best harness that information?*

The Oregon Coast Aquarium is a privately owned, non-profit, 501c(3) organization. For more information please contact:

Greg Shortess  
P.O. Box 210  
South Beach, OR 97366  
76270.3050@compuserve.com

---

## *The Bobcats Are Back!*

Unlike many of our beautiful wild creatures that have been driven to the edge of extinction by man's expansion, the sturdy bobcat (*Lynx rufus*) is more than holding its own. There are more of these 25-pound house cat look-alikes in the U.S. now than there were in colonial times- 700,00 to 1.5 million of them, according to the U.S. Fish and Wildlife Service.

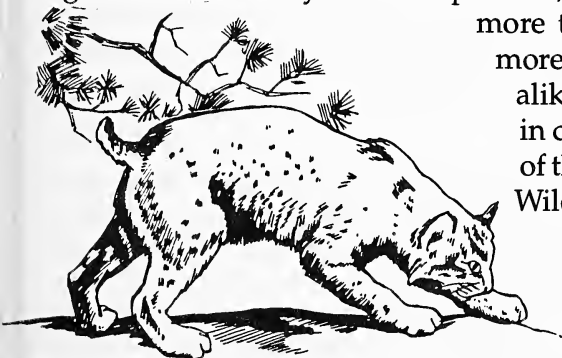

That's because the bobcat, like the coyote, is adaptable -- it eats whatever presents itself (usually avoiding domestic animals in favor of wild prey), and makes its home just about anywhere, from rocky crags to brush piles and abandoned dens. You probably won't see a bobcat, but they're at home in all 48 contiguous states.

--From *Nature News* Vol. 10, No. 14  
The Nature Book Society

# Book

# Review

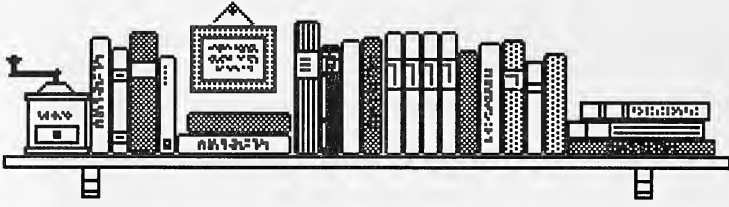

## **The General Care and Maintenance of Day Geckos**

By Sean McKeown, former Curator of Reptiles

Chaffee Zoological Gardens, Fresno, CA

Advanced Vivarium Systems, Lakeside, CA 92040

Pgs. 140+

*Review by Howard E. Lawler  
Curator Herpetology / Ichthyology  
Arizona-Sonora Desert Museum  
Tucson, AZ*

Advanced Vivarium Systems has published an important contribution to our knowledge of the husbandry and captive management of day geckos in the genus *Phelsuma*. The author's rich knowledge of the Indian Ocean herptofauna, combined with his extensive experience in the management of captive herptofauna, accrued over 20 years, had produced the first comprehensive work on these lizards which will serve zoo technicians for years to come. It is an essential reference for all who work with this beautiful and increasingly threatened genus.

All species of *Phelsuma* are listed under appendices I or II of CITES. Many are severely threatened by habitat alteration and exploitation by the pet trade. Long-term management of genetically-diverse captive populations is therefore likely to enhance the survival of many species.

The book combines characteristics of both field and laboratory guides in over 140 pages of text and photography. It provides detailed information on natural history, geographic distribution, state-of-the-science husbandry and propagation techniques, and innovative vivarium design.

The author describes general care and often highly-specialized husbandry requirements in significant detail. Individual species accounts are written in standard field guide format. Comments on species-specific captive management and husbandry vary in detail based on available information. Beautifully illustrated, the book includes over 67 spectacular color photographs of rare *Phelsuma* taxa, many of which have never before been published. A strong conservation ethic is espoused throughout the book.

Author Sean McKeown is former Curator of Reptiles at the Chaffee Zoo, an AZA Professional fellow, and a member of the AZA Lizard Advisory Group. As the foremost U.S. authority on these lizards, he has produced an excellent practical reference on day geckos which also served as a model for future publications combining natural history and captive management. I recommend it highly.

# **DOWN UNDER**



## **Australian Genetic Test to Aid Zoos Worldwide**

*submitted by Trevor Rees, Melbourne, Australia*

Australian researchers at the University of Queensland have developed and successfully used what is believed to be the world's first DNA-based paternity test for vulnerable and endangered captive equine species. A research team in the University's Australian Equine Blood Typing Research Laboratory (AEBTRL) has developed the genetic test, which is expected to be an important species management tool for zoos internationally.

The test will enable researchers to rapidly assess the accuracy of existing information about species pedigrees, and to monitor breeding populations. Research spokesman, Dr. Matthew Breen, said the test had been used with a high degree of precision in determining parentage in such captive equine species as zebra, Przewalski's horses (a primitive horse type now found only in captivity), and African and Asiatic Asses.

He said the genetic test would have significant benefits for any institution involved in captive management of equine species. "At the present time DNA typing can detect more than 99 percent of incorrect thoroughbred horse pedigrees and we recently calculated that the test has an even higher success rate in Przewalski's horses," he said. "In addition to using blood samples, we can perform DNA typing on a variety of specimens such as semen, muscle, nasal swabs, and even hair follicles. This makes the collection of samples much easier, and in many cases obviates the need for anesthesia, which has potential dangers for animals."

Dr. Breen said this research had been very successful and with international collaboration, the AEBTRL had achieved parentage verification in thoroughbred horses with an efficacy greater than 99.7 percent, compared with tradition blood typing techniques, with an efficacy of approximately 97-98 percent. He believes the test, with further refinement, will have an efficacy greater than 99.9 percent within the next few months.

*(Readers are invited to submit articles, news briefs, breeding successes, etc. relating to Australasian fauna for publication in the DOWN UNDER column.)*

# AAZK Announces New Professional & Contributing Members

Darcy K. Wyer, **Acadia Zoo (ME)**; Peter Laline, **Staten Island Zoo (NY)**; Julie Breeden, **Virginia Living Museum (VA)**; Johnny D. Richardson, **Zoo Atlanta (GA)**; Pau DiMaio, **Miami Sequarium (FL)**; John Swank, Jr., **Columbus Zoo (OH)**; Robyn Pero, **Toledo Zoo (OH)**; Michael A. Zedekar and Jodi M. Tarr, **ME's Zoo (IN)**; Christine Prah, **Lincoln Park Zoo (IL)**; Marilee M. Joyce, **Lee Richardson Zoo (KS)**; Sheila D.A. Barries, **Audubon Zoo (LA)**; Lee Ann Whitt, Laura Yerby, Mark E. Meylian, Carla Oncay, Rhonda Napier, and Karen Bauman, **Alexandria Zoological Park (LA)**; Janet Sandler Scmid, **Little River Zoo (OK)**; Thom Barrows and Carolyn E. Johnson, **Ft. Worth Zoo (TX)**; Greg Whittaker, **Moody Gardens (TX)**; Lori L. Braun, **El Paso Zoo (TX)**; Cindy Choules, **Tracy Aviary (UT)**; Joe Blackham, **Willow Park Zoo (UT)**; Ralph Jackson and Patricia Fabian-Chavez, **Rio Grande Zoo (NM)**; Werner Edling, **no zoo listed, Las Vegas, NV**; Deborah Hewitt, **San Diego Zoo (CA)**; Tania Prebble, **Santa Barbara Zoo (CA)**; Marilyn F. Omlor, **Walk in the Wild (WA)**; Joan Gellatly, **Calgary Zoo (Alberta)**; and Brenda McComb, **Valley Zoo (Edmonton)**.

## Renewing Contributing Members

Jack Brown, Director, Santa Fe  
Community College Teaching Zoo,  
Gainesville, FL

Jim Fleshman, Abilene Zoological  
Gardens, Abilene, TX

William H. Disher, San Diego Zoo &  
Wild Animal Park, San Diego, CA

# THE GOURMET RODENT™

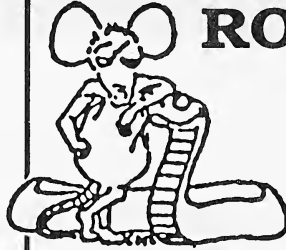

## RATS AND MICE

Bill & Marcia Brant  
6115 SW 137th Avenue  
Archer, FL 32618  
(904) 495-9024  
Fax (904) 495-9781

© All Rights Reserved

## Need to Reach AAZK?

1-800-242-4519 (U.S.)  
1-800-468-1966 (Canada)

FAX: (913) 273-1980

or write  
AAZK, Inc.

635 S.W. Gage Blvd.  
Topeka, KS 66606-2066  
U.S.A.







Again this year the AAZK Enrichment Committee hosted a workshop at the National AAZK Conference in Denver. We'll include some highlights for those who couldn't attend. Enrichment Committee updates from the past year were given, and Lee Houts, Sacramento Zoo, shared her thoughts about the Enrichment Conference in Copenhagen (look for more details on these subjects in future columns). An excellent video demonstrating operant conditioning by Marty Sevenich from Brookfield Zoo was shown, and copies of her training evaluation form were distributed. Judy Knapp, Folsom City Zoo, developed a rough draft of enrichment evaluation forms which were also handed out. It is hoped that with feedback from everyone about the forms, a usable standardized form can be developed for use among all zoos so that we're all "speaking the same language" about enrichment, making information exchange easier. Those who wish to give these forms a try may contact Kayla Grams for copies. Dianna Frisch showed slides from her wildly successful enrichment workshop at Columbus Zoo, where volunteers gathered on a Saturday to make a huge variety of enrichment implements and devices. Linda King from Dallas showed a "horse ball" video and shared their enrichment fundraiser ideas. Karen Worely, San Diego, showed the "Best of *Shape of Enrichment*" video, which was wonderful and is available through the "*Shape...*" video library. And of course, Kayla and Gretchen whined about needing fresh ideas for this column - a never-ending request! All in all, many great ideas were exchanged and inspiration abounded! Keep up the good work, everyone!

**ELEPHANTS** - 3' rawhide bones

*-Teresa Crowder, Mesker Park Zoo., Evansville, IN*

**WOLVES** - porcupine-scented logs, and a waterhole filled with a hose (really helped them cool off this summer)

*-Jane Larson, Hogle Zoo, Salt Lake City, UT*

The following is environmental enrichment for captive felines submitted by Dwight P. Knapik from The International Society for Endangered Cats Canada, Inc., Calgary, Alberta. Thanks Dwight!

We have gathered the following ideas for enriching the captive environments of captive felids from a variety of sources, and we will continue to add to and expand this list as time goes on.

1. Live and/or whole carcasses of rabbits, rats, mice, guinea pigs, chickens, chicks, etc.; also live fish in pool, live insects
2. Feed in as much variety as possible, including organ meat, fish, cheese, bones, etc. (also eggs)
3. Give vegetable matter such as sprouted grasses or grains for use as a aid to digestion; also fruits such as small melons for use as supplemental moisture source (especially on hot summer days) as well as occupational use.
4. Present food in a variety of forms (e.g. - frozen meatsicles, fishsicles), and present the food in novel ways to the cat, such as a log or stick pile with food chopped up inside, or putting food inside a box with a hole in it so the cat will have to reach inside to get it; distribute the food in different areas of the cage to stimulate the cat to search for it.
5. Feed in smaller amounts more than once a day to help reduce pacing and stimulate a variety of activities.
6. Insure that there is a variety of "cage furniture" in place, the more "natural" the surfaces the better; these would include trees and/or logs, soil, sand and turf substrates, leaf litter that can easily be changed and replaced periodically, sandbox or peat-filled litterboxes that enable the cats to bury their feces without having to defecate in the water bowl, pool, or other undesirable location.
7. Utilize the vertical component of the enclosure to the fullest extent, with angled logs leading up to a variety of platforms and nestboxes/tree holes.
8. Introduce novel scents into the enclosure (e.g. - catnip, allspice, hunting lure scents, musk oils, appropriate prey scents).
9. Provide a variety of "cat toys" to stimulate activity, including frozen or unfrozen pieces of skins and fur from carcasses, a variety of balls, pine cones, conifer and deciduous branches, a variety of objects hanging on a rope from the ceiling.
10. Set up a speaker to play various recorded vocalizations and "natural" sounds to stimulate the cat's auditory senses.
11. Hang a fresh horsetail or some other "meat treat" from a bungee chord (i.e. - a flexible rubber strap) attached to a tree branch; cats will jump at it and chew it for hours.

**Ideas appearing in this column have not necessarily been tested by the editors for safety considerations. Always think ahead and use good judgement when trying new ideas.**

# Chapter News Notes

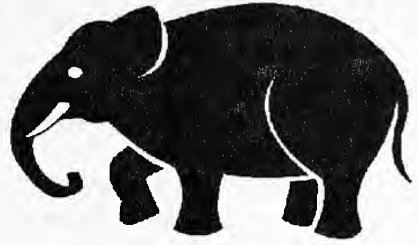

AAZK, Inc., would like to welcome two new Chapters to the Association. We wish them much success with their projects and programs. The newly chartered Chapters are:

## Alexandria UTOBIA AAZK Chapter

This Chapter is located at the Alexandria Zoological Park, P.O. Box 71, Alexandria, LA 71301. Its officers are:

President.....Rhonda Napier  
Vice President.....Carla Oncay  
Secretary.....Laura Yerby  
Treasurer.....Jeanne Frazier  
Chapter Liaison.....LeeAnn Whitt  
Educational Resource  
Chairman....Mark Meylian

## Greater Austin Chapter of AAZK

This Chapter is located at the Austin Zoo, 10807 Rawhide Trail, Austin, TX 78736. Its officers are:

President.....Carin Peterson  
Vice President.....Jennifer Cassaday  
Secretary.....Gavin Jarrard  
Treasurer.....Sara Kirby  
Chapter Liaison.....Jennifer Cassaday

## Pueblo Zoo AAZK (Colorado Springs, CO)

The Pre-Conference trip was a great success with 43 keepers coming down for the day. They were treated to

behind-the-scenes views in much of the zoo, including the lion house, savannah barn, penguins and herpetarium. All of the staff were present to help out, and we all enjoyed talking to the visiting keepers. Dinner was well-received and not much was left! We'd like to thank everyone for coming!

Our keepers were all able to attend the Conference for one day, and brought back information to all of us. It was a really wonderful experience for our new keepers, just starting their careers.

Now we have been working on our Third Annual Zoo Boo, a Halloween event for young children. It has become very popular and provides a great turnout. Costume contests, pumpkin decorating and seasonal decorations delight visitors. And all those pumpkins for enrichment!

—Michele Smith, Chapter Liaison

## Southern Ontario Zookeepers AAZK Chapter

The Metro Toronto Zoo Chapter is now the Southern Ontario Zookeepers AAZK Chapter. The name change will accommodate keepers from other zoos in the area who wish to be part of a larger, more open Chapter, and will also, hopefully, increase the flow of information and ideas.

Earlier this year we increased our membership substantially when the Chapter subsidized dues by covering the difference between U.S. and Canadian \$35.00 for national membership. We hope to regain this expense through the sale of our new Tasmanian Devil T-Shirts and through our new wishing well at Bowmanville Zoo. We are indebted to Bowmanville Zoo for allowing us to build it there and are particularly grateful to the efforts

of Ted and Deb Strikwerda, our members there, for making it happen and maintaining it.

Bowling for Rhinos remains a popular and successful annual event for M.T. Z. Holding it in June enables seasonal staff to participate and this year it raised almost \$3000.00. Our thanks to the organization for a job well done.

—Eric Cole, Chapter Liaison

## ***Zoos Join AZA Push for Safe Antifreeze***

From veterinary trucks to double-decker buses to animal care carts, the San Diego Zoo is converting its 100-vehicle fleet to an antifreeze that is safer for animals and humans. The Zoo's anti-freeze conversion program is part of a national campaign sponsored by the American Zoo and Aquarium Association (AZA) and Sierra™ antifreeze (Safe Brands Corp., Omaha, NE), which produces a propylene glycol-based antifreeze that reduces the concerns associated with the poisonous conventional antifreeze made with ethylene glycol.

According to Joan Embery, goodwill ambassador for the San Diego Zoo and well-known animal authority, this campaign is designed to raise awareness and educate the public of the potential danger of conventional antifreeze. "Antifreeze poisonings of wildlife and pets is a well-documented threat," she said. "Spills, radiator leaks, boil-overs and improper disposal are common sources of accidental poisonings of pets and wildlife. Converting to a safer and less toxic product is another way zoos can help preserve wildlife," said Embery, who also serves as spokesperson for the conversion program.

According to the American Association of Poison Control Centers, approximately 700 children under the age of six are exposed to antifreeze each year. Veterinary studies show that antifreeze is a leading cause of accidental animal poisonings, while animal welfare experts believe antifreeze is the leading cause of deaths of tens of thousands of companion and wild animals each year. One teaspoon of EG antifreeze can cause a cat's death, less than two ounces is enough to kill a dog, and as little as two tablespoons can be hazardous to a small child.

In addition to the San Diego Zoo, participating zoos include: The Baltimore Zoo, Cincinnati Zoo & Botanical Gardens, Cleveland Metroparks Zoo, Denver Zoo, Minnesota Zoo, Philadelphia Zoo, Pittsburgh Zoo, Metro Washington Park Zoo in Portland, OR, Roger Williams Park Zoo in Providence, RI, Sacramento Zoological Society, Woodland Park Zoo in Seattle, WA, St. Louis Zoo, and the Toledo Zoo in Ohio.

Participating zoos will offer free or discounted children's admissions through December 1995. Call 1-800-432-9306 for information on these special admission rates.

# Trailside Museums and Zoo Makes Animal Enrichment a Holiday Event

by Jennifer A. Verstraete, Head Keeper Mammals & Amphibians/Reptiles  
Trailside Museums/Zoo, Bear Mountain State Park, Bear Mountain, NY

In 1993, Trailside held an event we called "Halloween: Trick-or-Treat with the Bears". Since Trailside is situated in Bear Mountain, NY, our three resident black bears (*Ursus americanus*) are always a popular attraction. Their den is our largest exhibit and is also the lowest point along the Appalachian Trail.

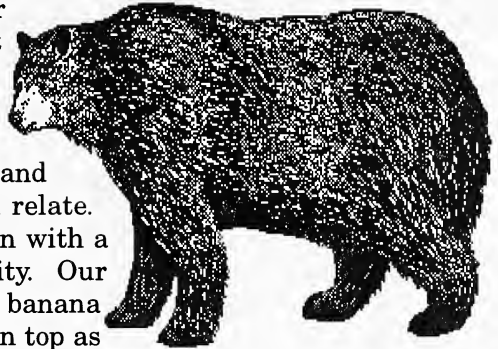

Trick-or-Treat with the bears consisted of many fun ideas that the bears loved and with which children of all ages could relate. Each bear had their own jack-o-lantern with a face to resemble that bear's personality. Our sweet bear had lettuce hair and a big banana smile. Our rebel had pig ears placed on top as horns. Naturally the pumpkins were filled with yummy treats, mealworms, raisins, acorns and peanuts.

The bears also bobbed for apples in their pool, and took swats at a cardboard box pinâta (free of tape and staples) that was glued together with honey. This box was also filled with treats. Mini pumpkins and gourds hung from their tree and a nearby pile of hay also contained hidden bear treasures.

A favorite with the public was a scarecrow (free of zippers and buttons) that was filled with straw and fish. A public concern was whether or not this human shape would provoke the bears to relate keepers to straw and fish, but luckily the bears seem to know it is only a yearly treat and there have been no problems. Next came the winter holidays. Each bear had about a dozen evergreen trees that they loved to play with and cart around. In addition, we decorated them with pine cones and fish. Under the trees we used boxes again. This time we painted them with peanut butter to resemble gifts.

For those of you who live in climate where snowfall is common, try building snow animals in your exhibits when your animals are locked up. Decorated with treats or *aux natural*, our bears loved them. They approached with caution at first but once they realized there was no threat they had a jolly old time destroying the sculptures.

As spring of 1995 rolled around, we expanded our holidays events. On St. Patrick's Day we scattered around cabbage and red potatoes. This turned out to be simply enrichment toys and not a favorite snack. The females did enjoy

the green marshmallow fluff shamrocks that were painted on tree trunks and rock ledges. Also a hit was the sugarfree green Jello™. They seemed amazed to 'watch it wiggle as they saw it jiggle'.

The most recent event that we have done is an Easter Egg Hunt! Brightly colored hard-boiled eggs were scattered around the den in open view. This way the kids watching this event had fun spotting the eggs as the bears sniffed them out. You see, since black bears' most predominant sense is smell, each egg was dipped in nice smelly honey for them to sniff out.

At last month's AAZK National Conference I learned that some directors do not care for unnatural enrichment items on display. However, at Trailside, we deal with only native, non-releasable wildlife. Because of this we rely on enrichment to stimulate our physically injured or imprinted wildlife. Luckily our director also seems to feel the same was about our collection's welfare.

I hope this article provokes some new holiday fun at all your zoos and please write in, share your holiday fun and other ideas, too!

---

## White Rhinos Reintroduced to Etosha National Park

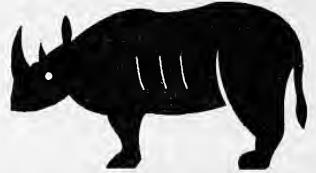

Ten white rhinos (*Ceratotherium simum*) have been released in Namibia's Etosha National Park, the first free-ranging white rhinos in the park this century, according to a press release from Namibia's Ministry of Environment and Tourism.

White rhinos were extirpated in Namibia before 1900. Prior to the Etosha release, which occurred on 21 July, white rhinos had been re-established in Waterberg Plateau Park and on several Namibian game farms.

The ten new arrivals were part of an exchange of wildlife between the northern Namibian park and Kruger National Park in South Africa. Kruger received 30 giraffe (*Giraffa camelopardalis*) from Etosha about four years ago, but unfavorable climatic conditions and threats from wildlife diseases delayed the conclusion of the transaction until this year.

In a separate transaction involving Etosha, eight black rhino (*Diceros bicornis*) from the park were recently sold to a South African game-farming consortium for about \$25,000 each. The purchaser and exact destination were not disclosed by the Ministry for "security reasons".

Namibia has the second largest rhino population in Africa. The most recent estimates from the African Rhino Specialist Group (May 1994) are 98 white rhinos and 583 black rhinos.

Source: *African Wildlife Update*, Sept./Oct. 1994, Vol. 4, No. 5, a bimonthly publication of the African Wildlife News Service, P.O. Box 546, Olympia, WA 98507-0546

# L.I.N.K.

## (Liaison and Information Network for Keepers)

Coordinator for the LINK System: Mark de Denus, Assiniboine Park Zoo, 2355 Corydon Ave., Winnipeg, Manitoba, Canada R3P 0R5. (204) 986-6921 [w]; (204) 837-2916 [h]. Assistant LINK Coordinator - Ric Urban, Houston Zoological Gardens, Houston, TX, 1513 MacGregor Way, Houston, TX 77030 (713) 520-3234 [w].

### Regional Coordinators

**ALABAMA** - Fred Alvey, Zoo Atlanta, 800 Cherokee Ave. S.E., Atlanta, GA 30315 • **ARKANSAS** - Ann Rademacher, Little Rock Zoological Gardens, #1 Jonesboro Dr., Little Rock, AR 72205 • **CALIFORNIA** - (Northern) Jean Lai, Oakland Zoo, 9777 Golf Links Rd., Oakland, CA 94605 and Ruby Lara, Sacramento Zoo, 3930 West Land Park Dr., Sacramento, CA 95822-1123 • **CONNECTICUT** - Jeanette Beranger, Roger Williams Park Zoo, Providence, RI 02905 • **DELEWARE** - Theresa Maas-Anger, Philadelphia Zoo, 34th & Girard Ave., Philadelphia, PA 19104 • **FLORIDA** - Rick Smith, 4707 Walden Circle #409, Orlando, FL 32811 • **GEORGIA** - Fred Alvey, - Zoo Atlanta, 800 Cherokee Ave. S.E., Atlanta, GA 30315 • **IDAHO** - Holly Liappas, Tautphaus Park Zoo, P.O. Box 50220, Idaho Falls, ID 83405 • **ILLINOIS** - Pat Swieca, 5710 W. Cullom Ave., Chicago, IL 60634 • **INDIANA** - Jan Weinig, P.O. Box 197, Michigan City, IN 46360 • **KANSAS** - Brian Kohler, Lee Richardson Zoo, P.O. Box 499, Garden City, KS 67846-0499 • **KENTUCKY** - Scott Wright, Cleveland Zoo, 3900 Brookside Park Dr., Cleveland, OH 44109 • **LOUISIANA** - Rhonda Votino, 3535 Houma Blvd., Apt. 109, Metairie, LA 70006 • **MAINE** - Jeanette Beranger (see addresses under CT) • **MARYLAND** - Theresa Maas-Anger, Philadelphia Zoo, 34th & Girard Ave., Philadelphia, PA • **MASSACHUSETTS** - Jeanette Beranger (see addresses under CT) • **MICHIGAN** - Tim Sampson, John Ball Zoo, 1300 W. Fulton, Grand Rapids, MI 49504 • **MINNESOTA** - Tim Hill, Minnesota Zoological Gdns., 13000 Zoo Blvd., Apple Valley, MN 55124 • **MISSOURI** - Brian Kohler, Lee Richardson Zoo, P.O. Box 499, Garden City, KS 67846-0499 • **MONTANA** - Holly Liappas (see address under Idaho) • **NEVADA** - Patricia Simonet, Wildlife Safaris, P.O. Box 6735, Incline Village, NV 89450 • **NEW HAMPSHIRE** - Jeanette Beranger (see addresses under CT) • **NEW JERSEY** - Frank Leonard, Bronx Zoo, 185th & Southern Blvd., Bronx, NY 10460 • **EAST NEW YORK** - Frank Leonard, Bronx Zoo, 185th & Southern Blvd., Bronx, NY 10460 • **WEST NEW YORK** - Alan Baker, Burnet Park Zoo, 500 Burnet Park Dr., Syracuse, NY 13204 • **NORTH CAROLINA** - Kristin LaHue, Riverbanks Zoo, P.O. Box 1060, Columbia, SC 29202-1060 • **NORTH DAKOTA** - Bob Debets, Assiniboine Park Zoo, 2355 Corydon Ave., Winnipeg, MB Canada R3P 0R5 • **OHIO** - Scott Wright, Cleveland Metroparks Zoo, 3900 Brookside Park Dr., Cleveland, OH 44109 • **OKLAHOMA** - Ann Rademacher (see addresses under AR) • **OREGON** - Anna Michel, Washington Park Zoo, 4001 SW Canyon Rd., Portland, OR 97221 • **PENNSYLVANIA** - Theresa Maas-Anger, Philadelphia Zoo, 3400 W. Girard, Philadelphia, PA 19104 • **RHODE ISLAND** - Jeanette Beranger (see addresses under CT) • **SOUTH CAROLINA** - Kristin LaHue, Riverbanks Zoo, P.O. Box 1060, Columbia, SC 29202-1060 • **SOUTH DAKOTA** - Bob Debets (see address under ND) • **TENNESSEE** - Gail Karr, Memphis Zoo & Aquarium, 2000 Galloway, Memphis, TN 38112 • **TEXAS** - Connie Dieringer, Houston Zoo, 1513 N. MacGregor, Houston, TX 77030 • **VERMONT** - Jeanette Beranger (see addresses under CT) • **VIRGINIA** - Theresa Maas-Anger, Philadelphia Zoo, 34th & Girard, Philadelphia, PA 19104 • **WASHINGTON** - Joe Sullivan, Cat Tales, N. 17020 Newport Hwy., Mead, WA 99021 • **WEST VIRGINIA** - Theresa Maas-Anger, Philadelphia Zoo, 34th & Girard, Philadelphia, PA 19104 • **WISCONSIN** - Wayne Hazlett, 3768 S. 89th St., Milwaukee, WI 53228 • **WYOMING** - Holly Liappas (see address under Idaho) • **DISTRICT OF COLUMBIA** - Theresa Maas-Anger (see address under PA) • **Provinces of Manitoba & Saskatchewan** - Bob Debets (see address under ND) • **Provinces of Alberta & British Columbia** - Grant Tkachuk, 9955 114th St. Apt. A, Edmonton, AB T5K1P7 • **Atlantic Canada** - Bernard Gallant, RR # 7, 1081 Ryan Road, Moncton, N.B., E1C 8Z4

Vacancies exist for the following States or Provinces: Alaska, Arizona, Southern California, Colorado, Hawaii, Iowa, New Mexico, Mississippi, Nebraska, Utah, Ontario and Quebec.

*Institutions wishing to advertise employment opportunities are asked to send pertinent data by the 15th of each month to: Opportunity Knocks / AKF, 635 S.W. Gage Blvd., Topeka, KS 66606-2066. Please include closing date for positions available and when setting these dates keep in mind that because of bulk-mail most readers do not receive the AKF until the middle of the month or later. There is no charge for this service and phone -in or fax listings of positions which become available close to deadline are accepted. Our phone is 1-800-242-4519 (U.S.; 1-8000-468-1966 (Canada). Our FAX is 913-273-1980.*

**ANIMAL KEEPER**...prefer degree in biological sciences and animal care experience. Responsible for the daily care of diverse collection, including husbandry, exhibit maintenance/design, assist with vet procedures, and public relations. Salary \$12,500.00 plus benefits. Send resumé and references **by 20 November 1995** to: Liz Harmon, General Curator, Great Plains Zoo, 805 S. Kiwanis Ave., Sioux Falls, SD 57104.

**ZOO KEEPER**...requires a minimum of one year paid zoo experience. Degree in zoology preferred. The candidate must be a team player who can work with a minimum of supervision. Duties include the care and feeding of over a hundred species of mammals, reptiles, and birds, as well as presenting educational programs. Send resumé and references to: Vince Hall, Claws 'N' Paws Wild Animal Park, RD 6, Lake Ariel, PA 18436.

**ANIMAL CARE SPECIALIST**...twelve-month, entry level position, incorporating all aspects of animal husbandry, record keeping, and daily observations of semi-free ranging hoofstock, rhinoceros, carnivores and birds. Requires Associate Degree and prior experience or an internship in an AZA-accredited zoological facility. Housing provided as part of salary compensation. Send resumé to: Fossil Rim Wildlife Center, P.O. Box 2189, Glen Rose, TX 76043 Attn: DeAnna Hansen. Position open until filled.

**ANIMAL TECHNICIAN/AREA SUPERVISOR (Kansas City Zoo)**...prefer an accredited Associate Degree in life science; two (2) years experience in zoo animal husbandry and exhibition; bird experience desirable; supervisory experience in animal related capacity preferred. Will participate in maintaining and exhibiting of diverse animal collection; development and implementation of public programs; and direct supervision of zookeeper staff. Nonresidents, if appointed, must establish residency within the city limits of Kansas City, MO. Salary range \$1,853.00 - \$2,592.00 monthly plus excellent benefits. Send resumé **by 1 December 1995** to: Reta Gaebler, 414 E. 12th St., 12th Floor, City Hall, Kansas City, MO 66106. EOE/ME/D.

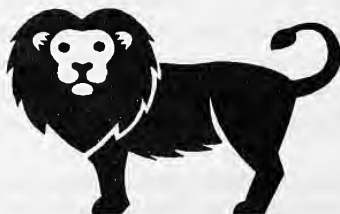



# AAZK Membership Application check here if renewal [ ]

Name \_\_\_\_\_

Address \_\_\_\_\_

City \_\_\_\_\_ State/Province \_\_\_\_\_ Zip \_\_\_\_\_

## U.S. Members

**\$30.00 Professional**  
*Full-time Keepers*

**\$25.00 Affiliate**  
*Other staff & volunteers*

**\$25.00 Associate**  
*Those not connected with  
an animal facility*

**\$50.00 or up - Individuals**  
**Contributing/U.S.**

**\$50.00 or up**  
**Institutional/U.S.**  
*Organizations / Institutions  
(requires Board approval)*

**International Members**  
**\$40.00 International**  
*All members outside U.S. &  
Canada regardless of category*

## Canadian Members

**\$35.00 Professional**  
*Full-time Keepers*

**\$30.00 Affiliate**  
*Other staff & volunteers*

**\$30.00 Associate**  
*Those not connected with  
an animal facility*

**\$55 or up - Individuals**  
**Contributing/Canada**

**\$55.00 or up**  
**Institutional/Canada**  
*Organizations / Institutions  
(requires Board approval)*

**Library Only**  
**20.00 Library**  
*Available only to  
established libraries*

Zoo Affiliation (if any) \_\_\_\_\_

Zoo Address \_\_\_\_\_

Title \_\_\_\_\_

Work Area \_\_\_\_\_

My check is enclosed (AAZK, Inc.)

Please charge my credit card

MASTERCARD \_\_\_\_\_ VISA \_\_\_\_\_ Card # \_\_\_\_\_ - \_\_\_\_\_ - \_\_\_\_\_ - \_\_\_\_\_

Name on card \_\_\_\_\_ Expiration date \_\_\_\_\_

Signature \_\_\_\_\_

Mail this application to: AAZK Administrative Offices, Topeka Zoo, 635 S. W. Gage Blvd., Topeka, KS 66606-2066. Make checks/money orders payable to AAZK, Inc. Must be in U.S. FUNDS ONLY. Membership includes a subscription to *Animal Keepers' Forum*. The membership card is good for free admission to many zoos and aquariums in the U.S. and Canada.

**American Association  
of Zoo Keepers, Inc.  
635 S.W. Gage Blvd.  
Topeka, KS 66606-2066  
U.S.A.**

Address Correction Requested



*“Dedicated to  
Professional Animal Care”*

National Zoological Park 3/96  
N.Z.P. Library  
Washington, DC 20008

Non-Profit Organization  
U.S. POSTAGE PAID  
Permit # 646  
Topeka, KS 66603

8  
p

# **ANIMAL KEEPERS' FORUM**



Hours 95

**The Journal of the American  
Association of Zoo Keepers, Inc.**

**DECEMBER 1995**

**ANIMAL KEEPERS' FORUM**, 635 S.W. Gage Blvd., Topeka, KS 66606-2066

Phone: 1-800-242-4519 (U.S.) 1-800-468-1966 (Canada) FAX 913-273-1980

**Managing Editor:** Susan Chan • **Associate Editors/Enrichment Options**

**Coordinators:** Kayla Grams, Arizona-Sonora Desert Museum & Gretchen Ziegler, Sequoia Park Zoo • **Book**

**Review Coordinator:** Andrea Bernee, Chaffee Zoological Garden • **Legislative Outlook Column Coordinator:**

Georgann B. Johnston, Sacramento, CA.

**Animal Keepers' Forum** (ISSN 0164-9531) is a monthly journal of the American Association of Zoo Keepers, Inc. Ten dollars of each membership fee goes toward the annual publication costs of **Animal Keepers' Forum**. Third Class postage paid at Topeka, KS. Postmaster - Please send address changes to: **American Association of Zoo Keepers, Inc., Administrative Offices, 635 S.W. Gage Blvd., Topeka, KS 66606-2066 - attn: Barbara Manspeaker, Administrative Secretary**

**December 1995**

**Vol. 22, No. 12**

**AAZK Executive Director:** Ed Hansen, AAZK, Inc., Topeka KS

### **BOARD OF DIRECTORS**

Ric Urban, Houston Zoological Garden, Houston, TX 77030

Diane Callaway, Omaha's Henry Doorly Zoo, Omaha, NE 68107-2200

Janet McCoy, Metro Washington Park Zoo, Portland, OR 97221-2799

Alan Baker, Burnet Park Zoo, Syracuse, NY 13204-2504

Marilyn Cole, Metro Toronto Zoo, Toronto, Ontario, Canada M1E 4R5

Lucy Segerson, North Carolina Zoological Park, Asheboro, NC 27203-9416

David Luce, Chaffee Zoological Gardens of Fresno, Fresno, CA 93728-2891

President

Vice President

Immediate Past President

### **COMMITTEES**

#### **Nominations & Elections**

Chair - Sheri Leavitt, Houston Zoo

#### **Conservation, Preservation & Restoration**

Chair - Brett Sellers, Metro Washington Park Zoo

#### **Annual Conferences**

Coordinator - Ed Hansen, AAZK, Inc.

#### **Awards**

Chair - Janet McCoy, Metro Washington Park Zoo

#### **Exhibit Design Resource Notebook**

Michael Demlong, The Phoenix Zoo

**AAZK Inspection Standards Manual** — Rachél Watkins Rogers, San Diego Zoo

#### **By-laws**

Rachél Watkins Rogers, San Diego Zoo

#### **Ethics**

Janet McCoy, Metro Washington Park Zoo

#### **Research/Grants**

Alan Baker, Burnet Park Zoo

#### **Marketing Resources**

David Luce, Chaffee Zoological of Fresno

#### **AAZK Chapter Logo Products**

Jay Christie, Cohanzick Zoo, Bridgeton, NJ

### **MEMBERSHIP SERVICES**

#### **L.I.N.K. Coordinator**

Mark de Denus, Assiniboine Park Zoo

#### **Zoo University List**

Mike Illig, Metro Washington Park Zoo

#### **Keeper Accommodations List**

Todd Cleveland, Denver Zoo

#### **Enrichment Committee**

Dianna Frisch, Columbus Zoo

**International Outreach** - Jeanette Beranger, Roger Williams Park Zoo (Chair/Coordinator Technical Assistance);

Lesa Scheifele, Norwich, CT (International Affairs); Lois Johannes, L. A. Zoo (Foreign Member Sponsorship

Program); Kathy Kelly, National Zoo - Project M.A.R.C. (Making A Realistic Contribution)

#### **Animal Data Transfer Form**

Bernie Feldman, Burnet Park Zoo

#### **Staff Exchange**

Dale Frerking, Kansas City Zoo

#### **AAZK Historian**

Vacancy

#### **AAZK Training Materials**

Adrienne Whitley, Burnet Park Zoo

### **PRESIDENTIAL ADVISORS**

#### **AZA Liaison**

Janet McCoy Metro Washington Park Zoo

#### **Bowling for Rhinos**

Patty Pearthree, Indianapolis Zoo

#### **Elephant Managers Association**

Dinah Wilson, Marine World Africa USA

#### **CAZPA Liaison**

Oliver Claffey, Metro Toronto Zoo

### **AAZK PUBLICATIONS - CONTINUING DATA COLLECTION**

#### **Zoo Infant Development Project**

Teri Maas-Anger/Maggie Liguori, Philadelphia Zoo (Birds/Nonpasserines); Jeanne Stevens, Newark Museum

Mini-Zoo (Reptiles); Linelle Lone, Denver Zoo (Amphibians)

**Diet Notebook, Mammals, Vol. II** - Susan Bunn Spencer, Rockford, MI



printed on recycled paper with vegetable-based ink products

# *Table of Contents*

About the Cover/Information for Contributors.....	474
Scoops & Scuttlebutt.....	475
Message from the President.....	476
Coming Events.....	478 - 479
Births & Hatchings.....	480 - 482
Further Wolf Releases Planned.....	482
1995 Conference Proceedings Info/Order Form.....	484 - 485
Ear-Covering by Captive Primates: A Survey.....	486
The Zoo Keeper Grant in Conservation.....	487 - 488
Cypress Gardens Hosts International Wildlife Sculpture Exhibition.....	488
Geology 101: An Introduction to Rockwork.....	489 - 492
AAZK Book Sale.....	494
In Search of the Dragon.....	495 - 501
Enrichment Options (Primates,Aardwolf, Hyenas).....	502 - 504
Puget Sound Chapter Assists Tree Kangaroo SSP.....	504
AAZK Announces New Professional/Contributing Members.....	505
Chapter News Notes.....	506
Bongo and Nyala Crate Training Papers Available.....	506
Play Behavior and It's Role in Evaluating Animal Health.....	507 - 509
Information Please.....	509
Book Review (The Timber Wolf of Wisconsin).....	510
Legislative Update.....	511 - 513
L.I.N.K List of Regional Coordinators.....	514
Opportunity Knocks.....	515 - 516



## ***About the Cover....***

*This month's cover features the Spotted Hyena (Crocota crocuta) drawn by Lee Houts of Sacramento, CA. The largest and most common of the three species of hyena found throughout much of Southern Africa, spotted hyenas live in territorial, matriarchal clans. Boundaries are communally marked using a paste from the anal gland. Vocalizations include the famous laugh (when being chased or attacked), grunts, yells, whines, groans and giggles. The "whoop" summons other clan members. Be sure to note the enrichment ideas for hyenas under this month's Enrichment Options column. Thanks, Lee!*

## **Information for Contributors**

Animal Keepers' Forum publishes original papers and news items of interest to the animal keeping profession. Non-members are welcome to submit articles for consideration. Articles should be typed or hand-printed and double-spaced. Articles may be submitted on disk by arrangement with the Editor. All illustrations, graphs, charts and tables should be clearly marked, in final form and should fit in a page size **no greater than 5.5" x 8.5"** (14cm x 22cm). Literature used should be cited in the text (Brown, 1986) and alphabetically in the final bibliography. Avoid footnotes. Include scientific name (as per ISIS) the first time an animal name is used. Thereafter use common name. Use metric system for weights and measurements (standard equivalents may be noted in parenthesis). Use the continental dating system (day-month-year). Times should be listed as per the 24-hour clock (0800, 1630 hrs. etc.). Glossy finish black and white photos **only are accepted**. Color slides should be converted to black and white prints (minimum size 3" x 5" [8cm x 14cm] ) before submission. Clearly marked captions should accompany photos. Please list photo credit on back of photo.

Articles sent to Animal Keepers' Forum will be reviewed by the editorial staff for publication. Articles of a research or technical nature will be submitted to one or more of the zoo professionals who serve as referees for AKF. No commitment is made to the author, but an effort will be made to publish articles as soon as possible. Lengthy articles may be separated into monthly installments at the discretion of the editor. The editor reserves the right to edit material without consultation unless approval is requested in writing by the author. Materials submitted will not be returned unless accompanied by a stamped, self-addressed, appropriately-sized envelope. Telephone and FAX contributions of late-breaking news or last-minute insertions are accepted as space allows. However, long articles must be sent by U.S. mail. Phone 1-800-242-4519 (US); 1-800-468-1966 (Canada); FAX (913) 273-1980.

Deadline for each regular issue is the 10th of the preceding month. Dedicated issues may have separate deadline dates and will be noted by the editor.

Articles printed do not necessarily reflect the opinions of the AKF staff or the American Association of Zoo Keepers, Inc. Publication does not indicate endorsement by AAZK, Inc.

Items in this publication may be reprinted providing credit to this publication is given and a copy of the reprinted material is forwarded to the editor. Reprints of material appearing in this journal may be ordered from the editor. Back issues are available for \$3.00 each.

# *Scoops & Scuttlebutt*



## **Chapter Reminder - Recharter Packets**

Please be aware that Chapter Recharter Packets will be sent out the first week in January and are due back **no later than 1 March 1996**. A \$50.00 late fee (in excess of recharter fee) will be assessed for those returned after this deadline. So now is the time to start putting together your financial records so you have them in order when the forms arrive. Once you receive the packet, if you have questions contact Barbara Manspeaker at Administrative Offices.

## **Books Available to Review**

The following books are available to be reviewed for *AKF*. If you are interested in reviewing any of these titles, contact Susan at Administrative Offices. Your review will be due within 60 days of receipt of the book and upon completion, the book is yours to keep.

Books available are: *Self-Assessment Color Review of Reptiles and Amphibians* by Frederic L. Frye and David L. Williams; *Our Living Resources: A report to the Nation on the Distribution, Abundance, and Health of U.S. Plants, Animals and Ecosystems* from the U.S. Department of Interior; *Iguana Iguana - Guide for Successful Captive Care* by Frederic L. Frye.

## **ADT Forms Available Upon Request**

Animal Data Transfer Forms for zoos and aquariums are available free of charge upon request. This is a professional service provided by AAZK. Contact: Bernie Feldman, Burnet Park Zoo, 1 Conservation Place, Syracuse, NY 13204. If your facility is not already using the ADT form, please encourage your administration to implement its use whenever an animal is shipped.

## **Be a Milkman for a Macaw**

Suzanne Chacoan from the Avian Propagation Center at the San Diego Zoo sent *AKF* the following: "A non-profit endangered species project in Costa Rica working with scarlet macaws can use a volunteer to bring them formula which is easy (and legal) to carry on, but difficult for them to get. If you will be traveling to Costa Rica from January through March 1996 you can help. Contact Suzanne Chacoan at (619) 436-8187.

*Reminder - Conference Proceedings Orders Due by 10 January 1996!*

# *Message from the President....*

Greetings from the Lone Star State!

At the Annual Meeting in Denver, the membership exercised the right to vote on an amendment to change the Bylaws. The membership passed the Bylaw's change as follows: Associate members are able to hold appointed office locally or nationally (committee chair or member; a coordinator; advisory positions, appointed Chapter position). The exception to these appointments are the Ethics and the Nominations and Elections Committees where the Association retains the right to govern certain aspects of operation under the direct supervision of the peer membership category (Professional). Associate members may hold elected office and vote at the local (Chapter) level as well. With this, we abide by an IRS regulation concerning Unrelated Business Taxable Income (UBTI). The UBTI states that all membership categories provide the same benefits or services (voting rights, equitable membership fees, equal and open participation in the activity of the Association).

The Research Grants Committee reported that two grants were offered in 1995. Grants for 1996 will not be offered in order to allow outstanding grant monies to be collected. Recipients now have a limited amount of time in which to be reimbursed for their work and to fulfill the necessary grant requirements. More of the various AAZK Committee/Project reports will be discussed in the State of the Association report to be published in January.

The 1995 Annual Meeting meant the end of the terms of Rachél Watkins Rogers (San Diego Zoo) and Mark de Denus (Assiniboine Park Zoo) on the AAZK Board of Directors. Their dedication to the Association has gone far beyond the call of duty. Both Rachél and Mark promise to remain active. Rachél is the Chair of the Inspection Standards Committee. Mark will continue to be the L.I.N.K. Coordinator and is giving a new look to the L.I.N.K. newsletter. New Board of Directors were sworn in for their four-year terms: Diane Callaway (Omaha's Henry Doorly Zoo), Marilyn Cole (Metro Toronto Zoo), Lucy Segerson (North Carolina Zoological Park), and David Luce (Chaffee Zoological Garden of Fresno). Welcome aboard.

Other Annual Meeting highlights included a delegate vote for the host of the 1998 AAZK National Conference. Enticing presentations were given by representatives of the Columbus Chapter and the Indianapolis Chapter. The delegates gave a majority vote to go to Indianapolis in 1998. The 1996 and 1997 Conference Hosts, Detroit and Houston respectively, offered impressive previews of their wonderful cities and what we have to look forward to in the years to come.

Have a safe and pleasant holiday season.

A handwritten signature in black ink, appearing to read 'Ric Urban', with a long horizontal flourish extending to the right.

Ric Urban, AAZK President  
Houston Zoological Gardens, Houston, TX





## Quality exotic animal diets

# SPECTRUM

**Nutritionally balanced  
Fixed formulation • Economical**

When you need a complete line of high-quality dry and frozen animal diets for your feeding program, call Animal Spectrum.

**NEBRASKA BRAND**



*Frozen feline diets  
Frozen bird of prey diets  
Frozen canine diet  
Chunk and chopped horsemeat,  
hearts, livers, rib, shank,  
knuckle bones, and tailbones*



**SPECTRUM**

*Banana flavored psittacine/primate, 20% protein, dry  
Banana flavored primate, Pro-Plus 25% protein dry  
Leaf Eater primate dry      Omnivore dry  
Llama Vitamins & Minerals dry      Polar Bear dry  
Marmoset/Tamarin dry      Ratite dry  
Hoofstock supplement, with Selenium dry*

**BROOD-RITE  
HEATERS**

*Bulbless heaters—nothing to break  
Safe around all animals and  
bedding material.  
Even heat distribution in 240, 500,  
or 750 wattages.*

**One call does it all**

TOLL FREE **1-800-228-4005**

**FAX 308-534-7015**

*Animal Spectrum, Inc.  
P.O. Box 721  
North Platte, NE 69101-0721*

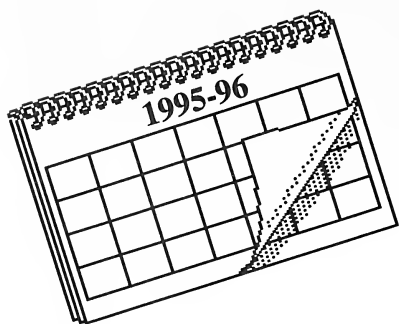

# Coming Events

## **The AZA School for Professional Management Development of Zoo & Aquarium Personnel and School for Applied Zoo & Aquarium Biology**

February 4-8, 1996

Wheeling, WVA

Schools held concurrently at Oglebay Park. For further information and an application, contact the AZA Office of Membership Services, Oglebay Park, Wheeling WVA 26003 (304) 242-2160.

## **The AZA Conservation Academy**

February 17-22, 1996

St. Louis, MO

Will be held concurrently with School for Zoo & Aquarium Animal Management, Studbook Keeper's Course, and SSP Coordinators' Course. For further information contact Debra Boyster, Conservation Academy Coordinator, c/o St. Louis Zoo, Forest Park, St. Louis, MO 63110 (314) 781-0900, ext. 297.

## **AZA Principles of Elephant Management**

February 18-21, 1996

St. Louis MO

Course held in conjunction with the courses offered by the Conservation Academy (see above listing). For further information contact Debra Boyser, c/o St. Louis Zoo, Forest Park, St. Louis, MO 63110 (314) 781-0900, ext. 297.

## **Zoo Nutrition Seminar**

March 16-17, 1996

Ithaca, NY

Offered at Cornell University, the course is designed for zoo veterinarians, nutritionists, and others with an interest in zoo animal nutrition and welfare. For further information, contact Zoo Nutrition, Box 101, Cornell University, B20 Day Hall, Ithaca, NY 14853-2801 (607) 255-7259, fax 255-9697, e-mail (sp@sce.cornell, edu).

## **17th Biennial Pronghorn Antelope Workshop**

June 5-7, 1996

Kings Beach, CA

Sanctioned by the Western Association of Fish and Wildlife Agencies, the workshop has issued a CALL FOR PAPERS relative to the biology and management of pronghorn. Proposed session topics are: Management of Private Lands; Population Modeling and Survey Techniques; Capture and Translocation Techniques; Habitat Management; Genetics, Anatomy and Physiology; and Recovery Planning. An abstract of 250 words or less is **due by 19 January 1996**. Send abstracts and inquiries to Workshop Chairperson Laura Colton, California Department of Fish and Game, 1416 Ninth Street, Room 1280-9, Sacramento, CA 95814; Phone (916) 653-6886; Fax (916) 653-1019; and e-mail 73430.210@compuserve.com.

## **ZOOMANIA - 96** **Southeast Regional Docent Conference**

September 13-15, 1996

Gulf Breeze, FL

Focus of the conference will be educational programs and endangered species. Registration forms and hotel information is now available by contacting the Docent Council or Curator of Education at THE ZOO, 5701 Gulf Breeze Parkway, Gulf Breeze, FL 32561 or by calling (904) 932-2229, ext. 27.

## **1996 AZA REGIONAL CONFERENCES**

**Central Regional** - Feb. 28-March 2, 1996 - to be held in New Orleans, LA. For further information contact Craig Dinsmore, Audubon Zoo, P.O. Box 4327, New Orleans, LA 70178 (504) 861-6112.

**Eastern Regional** - April 10-13, 1996 - to be held in Greenville, SC. For further information contact Bob Wilson, Greenville Zoo, 150 Cleveland Park Dr., Greenville, SC 29601 (803) 467-4300.

**Western Regional** - May 15-18, 1996 - to be held in Denver, CO. For further information contact Angela Baier, Denver Zoo, 2300 Steele St., Denver, CO 80205 (303) 331-5805.



# Births & Hatchings



**The Southern Ontario Zookeepers Association AAZK Chapter (Toronto, Ont. Canada)**... announces the following significant births and hatchings through 1995:

**Mammals** - 1.2 Siberian tigers (*Panthera tigris altaica*) [E/SSP/1st for pair]; 1.1 red panda (*Ailurus fulgens fulgens*) [E/SSP/1st for pair]; 1.3 Tasmanian devils (*Sarcophilus harrisii*) [1st for facility]; 0,0.1 Matschie's tree kangaroo (*Dendrolagus matschiei*) [SSP]; 0.0.2 golden lion tamarin (*Leontopithecus rosalia*); 1.1 Prevost's squirrel (*Callosciurus prevosti*) [E].

**Birds** - 0.0.1 hyacinth macaw (*Anodorhynchus hyacinthinus*) [E/dam raised chick alone after sire died].

**Reptiles** - 0.0.4 banded rock lizard (*Petrosaurus mearnsi*) [female brought in gravid]. *submitted by Eric Cole, Chapter Liaison, Southern Ontario Zookeepers Association AAZK Chapter.*

**Brookfield Zoo (Brookfield, IL)**...reports the following significant births and hatchings for September 1994 - September 1995:

**Mammals** - 0.1 aardvark (*Orycteropus afer*) [U/mother-reared]; 1.0 black rhinoceros (*Diceros bicornis*) [E/SSP/1st offspring for dam]; 1.0 bottle-nosed dolphin (*Tursiops truncatus*) [dam's first successful birth]; 1.3 Goeldi's monkey (*Callimico goeldi*) [T/SSP]; 2.2 golden-headed lion tamarin (*Leontopithecus rosalia chrysomelas*) [E/SSP - parents founders/most productive pair in SSP with 18 offspring to date]; 1.0 greater kudu (*Tragelaphus strepsiceros*) [1st birth for pair]; 1.1 Grevy's zebra (*Equus grevyi*) [E/SSP]; 0.0.6 Kowari (*Dasyuroides byrnei*) [1st birth for pair]; 0.1 lesser slow loris (*Nycticebus pygmaeus*) [T/SSP/U/females rarely born in captivity]; 0.0.16 naked mole-rat (*Heterocephalus glaber*) [U]; 1.1 okapi (*Okapia johnstoni*) [E/SSP] [0.1 hand-reared; 1.0 mother-reared]; 5.2 Rodriguez flying fox (*Pteropus rodricensis*) [U]; 0.1 Short-eared elephant shrew (*Macroscelides proboscideus*) [U]; 0.2 western lowland gorilla (*Gorilla gorilla gorilla*) [E/SSP] - [0.1 was pair's first offspring - sire "Abe" was wild-caught and died at about 39 years of age in May, this is his only living offspring] - 0.1 (sire's first offspring) - sire was first gorilla to have brain surgery].

**Birds** - 2.1 Bali/Rothchild's mynah (*Leucopsar rothschildi*) {E/SSP/hand-reared}; 0.0.2 Inca tern (*Larosterna inca*) [1st time birth from pair/parent-reared]; 1.2 Micornesian kingfisher (*Halcyon cinnamomina cinnamomina*) [E/

SSP/hand-reared per SSP]; 0.0.1 red-throated ant tanager (*Habia fuscicauda*) [U/dam died prior to hatching; first time hand-rearing from egg for any North American institution; BZ is the only zoo to have successfully fledged this species]; 4.1 green aracari (*Pteroglossus viridis*) [1st time birth for pair/all parent-reared/2.0 older siblings assisted in feeding the second clutch].

Reptiles - 0.0.10 green and black poison arrow frog (*Dendrobates auratus*) [1st time at BZ fifth generation froglettes have completed metamorphosis/10 years passed between fourth and fifth generations]; 0.0.3 Indefatigable Island tortoise (*Geochelone elephantopus porteri*) [E/U]; 0.0.1 Amur ratsnake (*Elaphe schrencki*) [U]. *submitted by Elizabeth Green, Primate Keeper, Brookfield Zoo, Brookfield, IL.*

**Denver Zoo (Denver, CO)**...announces the following B&H from June through October 1995:

Mammals - 0.0.1 hooded capuchin (*Cebus apella cay*) [CITES II/DNS]; 1.0 black howler monkey (*Alouatta caraya*) [CITES I/T]; 0.0.1 golden lion tamarin (*Leontopithecus rosalia chrysomelas*) [CITES I/E/SSP] DNS; 1.1 Grevy's zebra (*Equus grevyi*) [CITES I/T/SSP] 1.0 DNS; 3.3.0 scimitar horned oryx (*Oryx dammah*) [CITES I/SSP] 1.0 DNS; 0.1.0 Celebes black ape (*Macaca nigra*) [CITES II].

Birds - 0.0.1 Inca tern (*Larosterns inca*) DNS; 0.0.2 Bartlett's bleeding heart dove (*Gallicolumba criniger*) [CITES II/DNS]; 0.0.7 crested screamer (*Chauna torquata*) 0.0.3 DNS; 0.0.1 galah (*Eolophus roseicapillus*) [CITES II]; 0.0.1 Lady Ross' plantain eater (*Musophaga rossae*) DNS; 0.0.1 Nicobar pigeon (*Calaenas nicobarica*) [CITES I].

Reptiles - 0.0.3 Madagascar day gecko (*Phelsuma dubia*) [CITES II]; 0.0.1 Fiji Island banded iguana (*Brachylophus unk. sp.*) [CITES I/E]. *submitted by Vicki Sawyer, Chapter Liaison, Rocky Mountain Chapter AAZK, Denver, CO.*

**San Diego Zoo, Avian Propagation Center (San Diego, CA)**...the following birds were hand-reared from November 1994-October 1995 (parent-reared birds and chicks raised in other departments are not included in this listing):

Birds - 5.2 red-billed pintail (*Anas erythrorhyncha*); 6.8 Arabian sand partridge (*Ammoperdix beyi intermedia*); 1.4 Ferruginous wood partridge (*Caloperdix oculea*); 1.0 northern helmeted curassow (*Crax pauxi pauxi*) [a 1st for the Society]; 0.1.1 Malay great argus (*Argusianus argus argus*); 0.1 Palawan peacock pheasant (*Polyplectron emphanum*) [CITIES I]; 1.0 Temminck's tragopan (*Tragopan temminckii*); 0.2 buff-crested bustard (*Lophotis ruficrista*); 0.1 northern gray-winged trumpeter (*Psophia viridis*); 3.2 cream-colored courser (*Cursorius cursor cursor*); 0.1 northern Celebes quail dove (*Gallicolumba tristigmata tristigmata*); 0.0.4 black-winged lory (*Eos cyanogenia*); 0.1 Salvadori's black-capped lory (*Lorius lory salvadorii*); 0.0.2 northern Desmarest's fig parrot

(*Psittaculirostris desmarestii desmarestii*); 1.0.1 Edward's fig parrot (*Psittaculirostris edwardsii*); 0.0.2 Javan red-billed malcoha (*Zanclotomus javanicus javanicus*); 0.0.1 violet turaco (*Musophaga violacea*) [a 1st for the Society]; 0.0.1 wrinkled hornbill (*Aceros corrugatus corrugatus*) [a 1st for the Society]; 0.0.2 blue-backed fairy bluebird (*Irena puella sikkimensis*); 1.2 Javan crested jay (*Platylophus galericulatus galericulatus*) [a 1st for the Society]; 0.0.2 natal southern boubou (*Laniarius ferruginus tongensis*) [a 1st for the Society]; 2.2 San Clemente loggerhead shrike (*Lanius ludovicianus mearnsi*) [a federally endangered species]; 0.0.1 North Island brown kiwi (*Apteryx australis mantelli*) [SSP managed]; 3.7 African open-billed stork (*Anastomus lamelligerus lamelligerus*) [a 1st for the Society and North America].

The following birds were puppet-reared to avoid imprinting: 1.0 harpy eagle (*Harpy harpyja*) [CITES I - the first in North America to be successfully artificially incubated and hand-reared]; 2.1 East African pygmy falcon (*Polihierax semitorquatus castanotus*); and 0.0.2 Micronesian kingfisher (*Halcyon cinnamomina cinnamomina*) [SSP managed]. *submitted by Suzanne Chacoan, Keeper, San Diego Zoo, San Diego, CA.*

### Births & Hatching Code:

E - endangered

T - threatened

U - unusual in captivity

SSP - covered by SSP

CITES - included on one of the indices of the Convention on International Trade in Endangered Species of Flora & Fauna

DNS - did not survive

---

## Further Wolf Releases Planned



Ten months after releasing 15 wolves along the Salmon River in Idaho, the U.S. Fish and Wildlife Service (USFWS) is planning a second release for January 1996. The USFWS called the first release a success, since most of the wolves are surviving and pairing up. The long-term plan includes recovery zones in central Idaho, Montana and Yellowstone National Park, and aims to have a minimum of ten packs of ten wolves each by the year 2003.

Ted Koch of the USFWS said, "We don't have a schedule yet, but we're coordinating with British Columbia...to gather more wolves sometime this winter. The second release will send 15 wolves to Idaho and 15 to Yellowstone National Park.

DEAN'S ANIMAL SUPPLY, INC.

OFFERS

# THE BROODER

Perfect For Small Mammals, Birds, and Reptiles!  
Used By Breeders, Zoos, and Veterinarians Everywhere!

Microprocessor  
Controller

Hi/Lo Temp  
Alarms

Large  
Digital  
Display

Filtered Air

Indefinite  
Memory

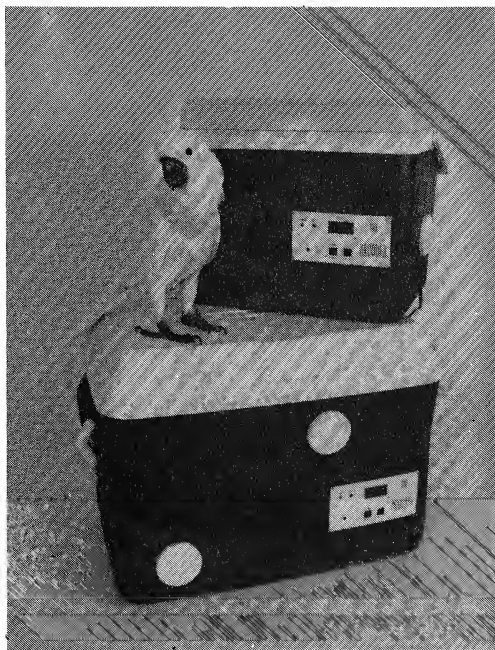

Easy  
Programming

Clear Inner  
Lid

Precise Temp  
Regulation

One Year  
Warranty

Power Supply  
Included

With The Brooder you get two brooders in one! With The Power Supply included with each unit, The Brooder will run indefinitely in your home or office. Each unit is also totally portable - able to run from your cars cigarette lighter. We also offer a rechargeable battery, perfect when power is unavailable. Extremely advanced technology provides digitally controlled, proportional power output for accurate and reliable heating. Our units are incredibly easy to use and all are backed with a one year warranty. Complete systems start at \$325.00, multi-order discounts available. Call or write for free brochure.



Dean's Animal Supply, Inc.

P.O.Box 691418

Orlando, FL 32869

(407) 521-2963

# 1995 Conference Proceedings

## Order Information

If you are interested in obtaining a copy of the Proceedings containing the papers presented at the 22nd National AAZK Conference held in Denver, CO, you will need to fill out and return the form on next page no later than **10 January 1996**. All orders **must** be prepaid in U.S. Funds ONLY. Allow 4-6 weeks following deadline for receipt of publication. Prices are as follows:

AAZK Member	\$25.00
Non Member	\$35.00

Postage for U.S. orders is included. Canadian and overseas orders should add \$4.00 for Air Mail postage to Canada and Surface postage elsewhere. Overseas orders wishing Air Mail service should add \$10.00. Make checks payable to AAZK, Inc.

Note: Individuals who presented papers at the Conference **and** submitted a manuscript for inclusion in these Proceedings will receive a gratis copy. If a manuscript was **not** submitted, a gratis copy will not be sent, and those individuals will need to order a copy.

Cost of the Proceedings was NOT part of the Conference Registration fee and delegates wishing a copy will need to order one.

**The following papers are among those included in the Proceedings:** The Western Snowy Plover Controversy Surrounding the "Enhancement" of Batiquitos Lagoon, Carlsbad, California ~ Beyond the Ark: Charting New Waters ~ Getting Involved: Keeper Participation in Taxon Advisory Groups ~ Small Scale Exhibit Renovation at the Burnet Park Zoo ~ Problems and Solutions Involved in Breeding and Rearing of the Crested Screamer, *Chauna torquata*, Including Artificial Incubation Techniques at the Denver Zoo ~ Waterfowl Breeding on a Budget ~ Teaching a Handreared Goodfellow's Tree Kangaroo to be an Educational Ambassador ~ Positive Reinforcement Training of a Crested Caracara ~ Conditioning of Nyala (*Tragelaphus angasi*) and Bongo (*Tragelaphus eurycerus*) to Blood Sampling in a Crate ~ Operant Conditioning of a Diabetic Hamadryas Baboon ~ Operant Conditioning of Great Apes ~ Initiating a Training Program with Gorillas at the North Carolina Zoo ~ THEN AND NOW - 20 years of Zoo Keeping ~ The History of the Houston Zoo Enrichment Committee ~ Red Kangaroo Management in a Five-Acre 'Walk-About' ~ Pest Control at the Cleveland Metroparks Zoo ~ Management of Rabies in a Colony of Pallid Bats (*Antrozous pallidus*) at the North Carolina Zoo ~ The Birth of Ruffed Lemur (*Varecia variegata*) Triplets in a Newly Formed Mixed Species Exhibit with Ringtail Lemurs (*Lemur catta*) ~ Lion Introductions ~ Okapi Milk Collection ~ and African Elephant Introductions at the Kansas City Zoo.

We also plan to include any other papers, workshop summaries and poster session abstracts that become available to us by our publication deadline.

Feel free to photocopy the form on the adjoining page to place your order. Phone orders may be placed at 1-800-242-4519 (U.S.) or 1-800-468-1966 (Canada) when using either a Mastercard or VISA credit card.



# Proceedings Order Form

(Please Type of Print)

I wish to order \_\_\_\_\_ copy(s) of the 1995 Denver Conference Proceedings.

# of copies x price per copy = \$ \_\_\_\_\_ Additional postage is \$ \_\_\_\_\_  
(if applicable)

Total payment for this order is \$ \_\_\_\_\_

(Make checks/money orders payable to AAZK, Inc.)

My check is enclosed \_\_\_\_\_ Please charge by VISA or MASTERCARD (circle)

Card # \_\_\_\_\_ - \_\_\_\_\_ - \_\_\_\_\_ - \_\_\_\_\_ Expiration date: \_\_\_\_\_

Name on card \_\_\_\_\_

Signature \_\_\_\_\_

Please mail to me at the address given below:

Name \_\_\_\_\_

Address \_\_\_\_\_

City \_\_\_\_\_ State/Province \_\_\_\_\_

Country \_\_\_\_\_ Zip/Postal Code \_\_\_\_\_

Send this Order Form along with check or money order or payment authorization via credit card to: AAZK Conference Proceedings, 635 S.W. Gage Blvd., Topeka, KS 66606-2066.

**Orders Must be Received by 10 January 1996**

Proceedings are only available by sending in your order form now. A very limited number of copies beyond prepaid orders will be printed. Once these are sold, complete sets of Proceedings will no longer be available. After this, copies of individual papers will be available for \$3.00 each. So **ORDER NOW!**

# Ear-Covering By Captive Primates: A SURVEY

I am collecting information on primates that cover their ears. Data collected thus far seems to indicate this behavior is shared across all the great ape species, and that ear-covering may be a behavioral response to stress.

If you have observed primates exhibiting ear-covering behavior, kindly complete the following information and return to: Sue Woods, Ph.D., 1609 S. Ivory Circle #E, Aurora, CO 80017, U. S. A. Thank you in advance for your assistance.

Your name & mailing address: \_\_\_\_\_

\_\_\_\_\_  
\_\_\_\_\_

Are you a keeper \_\_\_\_\_ researcher \_\_\_\_\_ other \_\_\_\_\_

Primate's name \_\_\_\_\_

Species \_\_\_\_\_

Sex \_\_\_\_ Age \_\_\_\_ Name of Zoo \_\_\_\_\_

Please describe the circumstances under which the ear-covering occurs. I would also appreciate any additional comments you might have.



# **THE ZOO KEEPER GRANT IN CONSERVATION**



The Zoo Keeper Grant in Conservation has been developed to promote and support efforts in conservation by keepers and aquarists in Zoological Parks and Aquariums around the world.

Members of AAZK, Inc. in good standing are encouraged to apply for the two \$500 (minimum) grant awards offered annually by AAZK, Inc. through the Conservation, Preservation and Restoration Committee.

The Committee will review and select the two most qualified applicants from that particular calendar year. Applicants will be notified by August 1st of the same calendar year of the outcome of the grant application process.

This grant was designed to lend support to a broad range of conservation endeavors. All appropriate applications are considered as to their beneficial impact on species of flora and fauna within defined ecosystems "in situ" or "ex situ" for captive-bred species.

We have intended for AAZK, Inc. members to be conduits for conservation efforts and, as long as they are actively involved, are eligible for financial support.

Applications will be evaluated in 10 subject areas by the CPR Committee members.

These subject areas are as follows:

1. Long-term commitment demonstrated to project.
2. Other financial support the project receives.
3. Resources available to the project and personnel support.
4. Preparedness of application.
5. How well the project is conceived.
6. Include project's significance in relation to the endangerment or specific threats to the species involved.
7. Impact of information learned on existing data.
8. The extent of the applicant's resumé and expertise of others involved in the project.
9. How well does the project fit into the goals of CPR?
10. What is the extent of the applicant's involvement in the project?

Applicants should consider the above mentioned categories when preparing their application.

**The Zoo Keeper Grant in Conservation is designed to be used for buying equipment, supplies and materials for projects. Travel expenses, wages and animal purchases are not valid. Other grants should be pursued for these type of expenditures.**

Currently the Zoo Keeper Grant in Conservation, if awarded, will have funds allocated on a reimbursement basis. If large sums of money are necessary early in the project year, AAZK's Executive Director shall be contacted for special permission.

**Applications will be accepted through  
31 March for each year's grants**

For applications please write: Bret Sellers, Chair/AAZK Conservation, Preservation and Restoration Committee (CPR), Metro Washington Park Zoo, 4001 SW Canyon Rd., Portland, OR 97221-2799.

---

---

## Cypress Gardens Hosts International Wildlife Sculpture Exhibition

A koala in a tree, a whitetail fawn and an African elephant will join grizzly bear cubs and green sea turtles as part of the 1995-96 Cypress Gardens' "Wildlife Sculpture Series". These creatures- crafted from bronze, wrought iron, concrete and wood- will be part of the more than 30 life-size figures expected in this outdoor garden display, which debuts November 1.

This 12-month display showcases more than \$750,00 of monumental sculpture along the paths of the park's original botanical gardens. Nineteen artists from the United States and England are represented in the show.

The pieces are available for purchase, and the artists have agreed to donate 5% of the proceeds from each sale to the National Wildlife Federation. The sculptures will be a permanent part of the original gardens from November 1995 to October 1996.

Cypress Gardens is located near Winter Haven, Fla. 40 minutes south west of Orlando and one hour east of Tampa on the shores of Lakes Eloise and Summit. For more information on Cypress Gardens, call (800) 237-4826.



**"Baby Giraffe"  
by David & William Turner**

# **Geology 101:**

## ***An Introduction to Rockwork***

*by Chuck Smith  
West Columbia, SC*

Most of the zookeepers that I know take great pride in their exhibits. Yet they're constantly looking out for ways to make improvements, whether that means a little touch-up here and there or perhaps even a major overhaul. The prospect of completely gutting an exhibit and starting over from scratch, however, especially when it entails artificial rockwork, can be an intimidating prospect. It doesn't have to be though. Making good looking artificial concrete rocks is not a science, it's simply a matter of a little practice and a little learned technique. Over the years I have gathered the tips provided here; both from observing the work of others, as well as my own trial-and-error experience (admittedly with more than my share of errors!).

### **Making the Form**

There are three important factors to consider when trying to create a believable rock... shape, texture, and color. With regard to shape, it is probably easiest to follow an example taken straight from nature. Go for a walk around the zoo grounds or similar setting, look at how the rocks fit into the surroundings, where plants grow around them or even from cracks within them, and then pick out a few of the more interesting examples. With your exhibit dimensions in hand, measure those that interest you to see how a similar fabricated rock might fit into your exhibit.

Once you've decided upon one or more rocks to replicate, it is time to make a form. One of the best materials for concrete rock forms is diamond mesh or expanded metal lathe. This material is available in 4'x8' (1.2m x 2.4m) and 2'x8' (.6m x 2.4m) sheets and is normally used in applying stucco to the exterior of buildings, however, it works equally well for fabricating concrete rocks. Unlike other types of wire mesh, such as hardware cloth, expanded metal lathe can be formed easily. It holds its shape well and is very inexpensive. The only drawback is that the cut edges are **EXTREMELY** sharp, so be sure to wear a pair of good leather gloves when working with it.

The expanded lathe can actually be formed using the rocks that you've selected by carefully (to avoid damaging the rock or vegetation) "pounding" the mesh into shape over the rock using a rubber mallet. After you are satisfied with the form's shape, planting pockets may be added by bending small depressions into the mesh. Larger planting pockets can be made by cutting out areas of mesh, then wiring a mesh "basket" into the opening.

## **Installing the Form**

Several different techniques are used for readying the form for the application of concrete. Which technique to use depends primarily on the size of rockwork to be constructed and how permanent it will be.

For medium-sized rockwork jobs (such as a waterfall or rock wall using several or separate forms placed together) the forms should be permanently attached to the exhibit wall and/or floor. Start with the form closest to the exhibit floor and secure it in place using a generous number of fasteners appropriate for the material used in the construction of the exhibit. For example, with a concrete or cement block exhibit wall use cement screws backed by "fender" washers for attaching the forms. Work your way up from the lowest to the highest form making sure all are firmly in place. If necessary, fill in any gaps between the forms by wiring in small sections of mesh.

Smaller installations, such as one or two concrete rocks in a rear-serviced exhibit, can be either permanent or removable. If the installation will be permanent, then use the technique described above. However, if you like the idea of being able to switch the rockwork in and out of the exhibit (and even between exhibits), then it's possible to construct the rockwork in such a way that it can be removed at a later date. To do this, a plywood mock-up of that part of the exhibit where the rockwork will be located needs to be made.

As an illustration, imagine that you wish to create a rock to hide the rear corner of a small exhibit, but rather than simply having a rock placed in the corner (where animals can hide behind it), you want the rock to blend into the exhibit wall. In this case, a corner is constructed out of plywood slightly larger than the rock will be. The form is then temporarily tacked onto the plywood corner. Note that you only need a mock-up of those sections that the rockwork will contact. That means for this example only three sections are needed (side, back, and bottom). For a rock resting on the floor you would use only one section of plywood. (bottom).

In addition to avoiding damage to the exhibit, a plywood mock-up also helps ensure that all the angles of the rockwork that will contact the exhibit are correct, as well as helping support the form during the application of concrete. After the rockwork is complete, it is simply detached from the mock-up, moved into the exhibit and sealed in place using clear silicon.

## **Applying the First Coat of Concrete**

After the form (or forms) is securely attached to either the exhibit or a plywood mock-up, it is ready for the first coat of concrete. I have found Portland cement to be the best choice for this type of work. Water is added to the dry concrete until it is roughly the consistency of loose bread dough. It should not be so watery that it falls through the mesh form, nor should it be so dry that it crumbles. After it's mixed, the concrete can be applied using either a trowel or

the preferred alternative, your hands. If you do use your hands, make sure to wear heavy latex gloves. Also, be sure to mix enough concrete so that you do not have to stop in the middle of the job to mix another batch.

On the first coat don't worry to much about appearances, simply try to cover the form evenly with a 3/4 inch layer of concrete.\* Work the concrete into the spaces of the expanded mesh. Also, coat the inside of any planting pockets. After the form has been completely covered, allow the concrete to set. The setting time will vary with humidity and temperature, but as a guideline, before applying the second coat you'll want the concrete to be hard enough so that you cannot press your finger into it, yet you can still chip it with the tip of a screwdriver. Once this hardness is attained, a 1/2 inch second coat is applied paying special attention to those areas that did not receive enough concrete during the first coat. As this second coat will be the final coat and the one that is textured, decide beforehand how you will go about creating the texture you desire. Some ideas for this are provided below.

### **Texturing the Concrete**

Numerous techniques can be used to give the second coat of concrete a convincing rock-like appearance. Professional exhibit makers often use crumpled heavy gage tin foil pressed into the damp concrete to create texture. Others use knives and trowels to carve the concrete. An alternative method that works quite well involves tossing handfuls of dry concrete powder at the damp second coat, creating high spots, bumps and ridges. Be sure to use a dust mask when doing this! Once the shape looks satisfactory, lightly mist the concrete powder using a spray bottle being careful not to saturate the dry concrete because it will begin to run.

Before this misted coat has hardened, cracks, crevices, flakes, and other irregularities can be created by chipping away at it with the tip of a screwdriver or cement trowel. Once the concrete has completely hardened (overnight to several days), use a chisel and hammer to further chip away at the surface.

A similar technique involves using a mixture of sand, soil, and gravel to toss at the damp concrete. Some of the material will stick, some will fall off, and some will create interesting depressions. When the concrete has hardened, a stiff wire brush can be used to remove loose material as well as give the concrete a weathered appearance.

The bottom line in creating texture is don't be afraid to experiment. Try going over the damp second coat with a dry sponge, paint roller, or anything else you may find lying around the workshop. You can even make realistic impressions in the concrete by pressing smaller rocks into it. Use your imagination!

### **Coloring the Rockwork**

One of the more difficult tasks in making natural-appearing rocks is recreating

the color. Color can be added by using a combination of cement dyes and stains. Dyes are available in powder form and are mixed with the dry concrete before adding water. Stains are available as a liquid and are applied much like paint after the concrete has hardened. Both dyes and stains come in a wide variety of colors. One method for using the dye involves adding a dark color to the concrete used in the second coat. While this coat is still damp, a lighter colored dye is added to the dry concrete powder and this dry mixture is tossed at the damp second coat and misted as outlined earlier. After all the concrete has completely dried, chipping away at the light outer coat or going over it with a wire brush will expose some the the darker undercoat, with interesting results. It is also possible to dust the damp second coat with a light colored dye and then brush off the excess. Cement stains are applied with either a spray bottle or paint brush and can be used to create the illusion of mineral deposits or lichens. For mineral deposits, lightly spray the cement with a dark color first and let it dry. Then apply progressively lighter colors, allowing the stain to dry between each application. Follow this up with a wire brush to take the shine off the stain and to give the rock a weathered look.

For lichens, use a small paint brush to apply patches of tan or gray stain to the concrete and allow the stain to dry. Next, apply a light green stain over this, leaving a ring of the tan or gray stain uncovered. Again, after the stain has dried, use a wire brush to lessen the shine and create a weathered appearance.

**In today's modern zoos, the need for animal enrichment and good environmental health is constantly being weighed against the availability of funds to the institution. While both sides of this equation hold valid points; there can be achieved a happy middle ground where the exhibit's remodeling can be enhanced by the keepers themselves, keeping costs low and increasing keeper pride in their exhibits. This works out well for the administrators, keepers, public, and especially for the animals.**

\*If you are constructing a rock wall or waterfall, complete the lower rocks first and then cover them with plastic. Once hardened, the completed rocks will help support the forms above them.

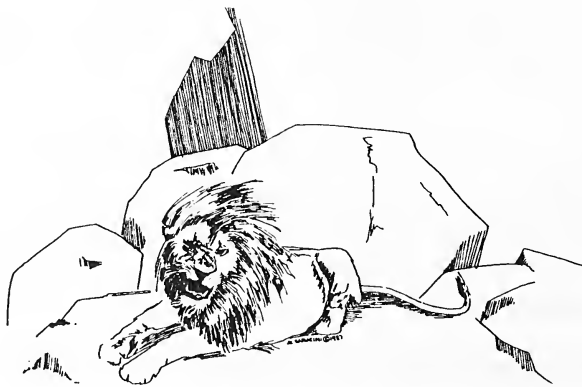



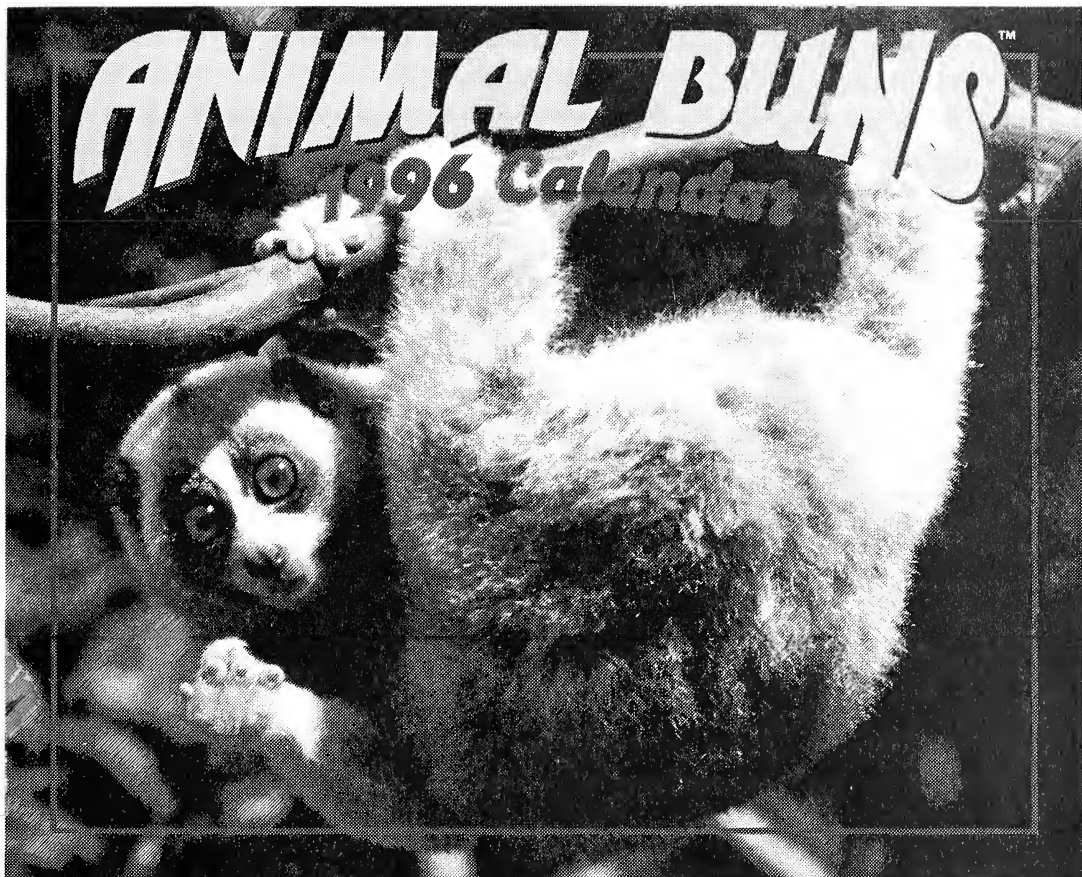

## The 1996 Animal Buns Calendar

From tree frog fannies to gorilla gluteus maximi to okapi keisters, the 1996 Animal Buns calendar celebrates the bun-derful world of wildlife with a dozen exceptional posterior portraits. Although an animal aft is a critical part of a creature's anatomy, beasily behinds are often overlooked by fauna fans. This behind-the-scenes calendar is devoted to dorsals and derrieres, which are unique in their own right. The 1996 Animal Buns calendar captures the colors, shapes, patterns, symmetry and style of critter cans in photos taken in the

wilds of Africa and in Australian and American animal parks and zoos

Fifty percent of the proceeds from this cheeky calendar is being donated to global wildlife conservation projects. The other fifty percent benefits keeper education and professional development programs of the San Diego Chapter of the American Association of Zoo Keepers (AAZK), the producer of the 1996 Animal Buns calendar.

**For ordering information, please call**  
**1-619-231-1515 x4672**

Retail \$9.95 ea. • Wholesale, 50 or more: \$4.95 ea.

**AAZK c/o San Diego Zoo • P.O. Box 551 • San Diego, CA 92112-0551**

# AAZK Book Sale

*Sale price is 20% off list price*

- | <u>Sug. Price.</u> | <u>Sale Price</u> |   |
|--------------------|-------------------|---|
| \$17.95            | \$14.35           | <b>Bird Nests</b> by Sharon A. Cohen - a charming book which delights in the simple, seemingly haphazard beauty of avian artists and their homes. 128 pgs. hardcover, full color photos.  |
| \$14.95            | \$11.95           | <b>Where Have All The Birds Gone?</b> by John Terborgh<br>A summary of our knowledge of the subtle combination of circumstances that is devastating our bird populations. 202 pgs., paper, photos & line drawings.  |
| \$29.95            | \$23.95           | <b>A Dictionary of Scientific Bird Names</b> by James Jobling - Gives derivation & meaning of all valid scientific bird names and discusses the ways in which birds have been named. 272 pgs. hardcover, line drawings.   |
| \$19.95            | \$15.95           | <b>A Neotropical Companion</b> by John C. Kricher - An introduction to the animals, plants and ecosystems of the New World Tropics. 450 pgs., paper, 100 illus.   |
| \$19.95            | \$15.95           | <b>Skulls and Bones</b> by Glenn Searfoss - A guide to the skeletal structures and behavior of North American mammals. 288 pgs., paper, line drawings.  |
| \$19.95            | \$15.95           | <b>Walker's Bats of the World</b> by Donald M. Nowak - the section on Chiroptera (bats) from Walker's Mammals of the World as a separate volume. 240 pgs., paper, B&W photos.   |
| \$16.00            | \$12.80           | <b>The Field Guide to Wildlife Habitats</b> by Janine M. Bengus - guides to observing animals in the wild, through an understanding of their habitats. <u>Specify</u> Eastern U.S. <u>OR</u> Western U.S.. 336 pgs. each, paper, line drawings.                               |
| \$25.00            | \$20.00           | <b>Habitats</b> edited by Tony Hare - fourteen gatefold panoramas of the world's ecological zones including information about habitats, food chain, seasonal change, and the causes & effects of animal migration on that habitat. 144 pgs., hardcover, 120 full-color illus. |

Previous books offered are still available, some with price increases. Call (203) 576-8126 and ask for Jeanne Yuckienuz to get price update. TO ORDER: List the books you want along with your name and complete mailing address. Including shipping fee of \$2 for the first item and \$1 for each additional item. Make checks or money orders payable to "AAZK Book Sale" (U.S. FUNDS ONLY - no cash or CODs, please). Mail to: AAZK Beardsley Zoo Chapter, Attn, Jeanne Yuckienuz, 1875 Noble Ave., Bridgeport, CT 06610-1600.

# *In Search of the Dragon*

*By Robert Berghaier, Senior Keeper  
Zoological Society of Philadelphia  
Philadelphia, PA*

I consider myself to be primarily a mammalogist, although that doesn't mean that I am not interested in other forms of life. I have often remarked that I became a birder by default rather than by design. It's a skill developed more because mammal sightings, particularly in the Eastern U.S., are few and far between. Birds are, in comparison, easily observed. Reptiles have always been a distant third in the criterion that I use when I choose a region for my travel plans.

So why did I decide to visit the Komodo Islands? I must admit that, "searching for the dragon" was not my primary reason for going. I had read that the Komodos are an intriguing travel destination in their own right. Part of my overall purpose in visiting Indonesia was to evaluate the country's tourist potential for the Philadelphia Zoo's Zoofari Travel Program. Seeing the dragon was, at most, a secondary consideration for traveling so far from the traditional mammal hot spots of Sumatra, Java, and Kalimantan.

Getting to the Komodo Islands can be a difficult logistical feat. The islands are remote and can only be reached practically by boat. My journey to the Komodos started in Bali. From there I caught a flight to the island of Sumbawa via Lombok. The islands are beautiful when seen from above in a small plane. They appear to be lush green gems surrounded by an azure sea. Each have several volcanos, dormant at present and visible from the air, rising up from the surface; dwarfing all other land features.

I landed at Bima, Sumbawa and was greeted at the airfield by my guide Suhada, a very striking Indonesian woman, and her younger brother Arif. Suhada wore a scarf which covered her hair, ears, and neck. Her arms were covered by a long sleeve blouse and her legs by full ankle length pants. This form of dress in Indonesia is an indication that Suhada was a traditional Muslim woman. She was quick to assure me that she was not an Islamic Fundamentalist however. I was to find out later that Suhada was not only attractive, but well educated, articulate, and an excellent guide. I realized that Arif, a pleasant and talkative young man, was along as a chaperone for his sister. It would not have been proper for a traditional Muslim woman to spend even one night unescorted by a man not of her family; let alone the four nights that Suhada would be spending on the boat with its crew and me.

Before leaving town we picked up the fourth member of our party, Mr. Sagee who would serve as the cook on our voyage. Mr. Sagee was one of those people whom you know within minutes you're going to like. From Bima we drove across Eastern Sumbawa towards the port of Sape. We passed through an agricultural region in route. The major food crop of the island, as well as most

of Indonesia, is rice. The main domestic animals include chickens, goats, and cattle. The cattle looked like smaller versions of the wild banteng found on Java and Bali. The cows are a light brown color, and the bulls are black with white legs and bellies. There's an abundance of horses on the island, many of which are used to pull pony carts. These carts are the major means of transportation for the local people and take the place of taxis on the island.

We crossed over the pass that would take us to Sape. The gap is surrounded by forest, and we passed a troop of long tailed macaques who were sitting along the side of the road. If there is an animal which should be selected as Indonesia's national symbol, it has to be this macaque. They can be found throughout the archipelago.

As we descended the pass we came upon the "rice houses" of the inhabitants of the Maria village. Suhada told me that these people build an entire village in which to store their rice harvest. This is intended to fool the evil spirits who will otherwise bewitch and destroy the harvested rice if they find it in the villager's homes.

We finally came to the port of Sape, and Suhada located our boat. It was a comfortable and clean sixty-foot wooden Phinisi schooner with a crew of four. We set sail at 3:00 PM. The voyage from Sape to the Komodos was through a beautiful region of the Lesser Sundas. The waters of the Sape Straits are a bright blue, and numerous scenic islands and inlets dot the horizon. We soon came in sight of our destination, the island of Komodo. As we approached the west side, I noticed high, steep cliffs with colored bands that are indicative of different geological strata. Marine life was scarce. I saw only a few small sea birds which I think were shearwaters and storm petrels. Near dusk we passed a small group of bottlenose dolphins.

By the time we arrived just off the Komodo Park Headquarters it was dark. Mr. Sagee prepared an excellent fresh fish dinner by lantern light. Suhada always served my meals on a set of bone china, which provided a nice touch of civilization in this remote area.

I awoke shortly after dawn to the calls of a flock of lesser sulfur-crested cockatoos. We docked and I disembarked with Suhada and Arif. There were numerous other tourists already ashore. Several other boats had arrived in the park harbor during the night, and there were over twenty tourists milling around. The park headquarters area contains ranger quarters, a few tourist bungalows, and a small museum and restaurant. There were several old, rather battered looking rusa deer stags wandering through the complex. I wondered if the stags stayed close to the post to avoid the dreaded dragon. There were also some interesting birds about: gray-headed fish-eagle, Brahminy kite, spotted dove, island collared-dove, and slender-billed crow.

At 8:00 a.m., escorted by two park rangers, all the tourists started out on a two kilometer walk to the Komodo dragon feeding grounds. In the past the dragons

were given a goat whenever tourists arrived at the feeding site. The goat was killed, tossed to the dragons, demolished, and devoured in front of the spectators. The Indonesian Park authorities, after getting advice from foreign scientists, had since decided to end this practice to get the Komodo dragons to return to their more natural feeding patterns. They are still fed a goat every two weeks, but not when tourists are present. The rangers told Suhada that a goat would be fed to the dragons later that week.

The Komodos, a type of monitor, can be either hunters or scavengers. The dragon's serrated teeth make it a formidable predator. The attack and subsequent loss of blood often kills its prey outright. If the target survives the initial assault its problems are not over. The saliva of the monitor contains a highly toxic bacteria which causes blood poisoning, and the eventual demise of its victim. The smell of the decaying carcass draws any Komodo in the vicinity for a meal. Their most common prey are rusa deer, but they will also attack feral horses (pregnant mares are reputed to be a specialty), water buffalo, macaques, pigs and other small animals, including younger and smaller Komodos. In fact, the most common cause of death in the species is being preyed upon by their larger relatives.

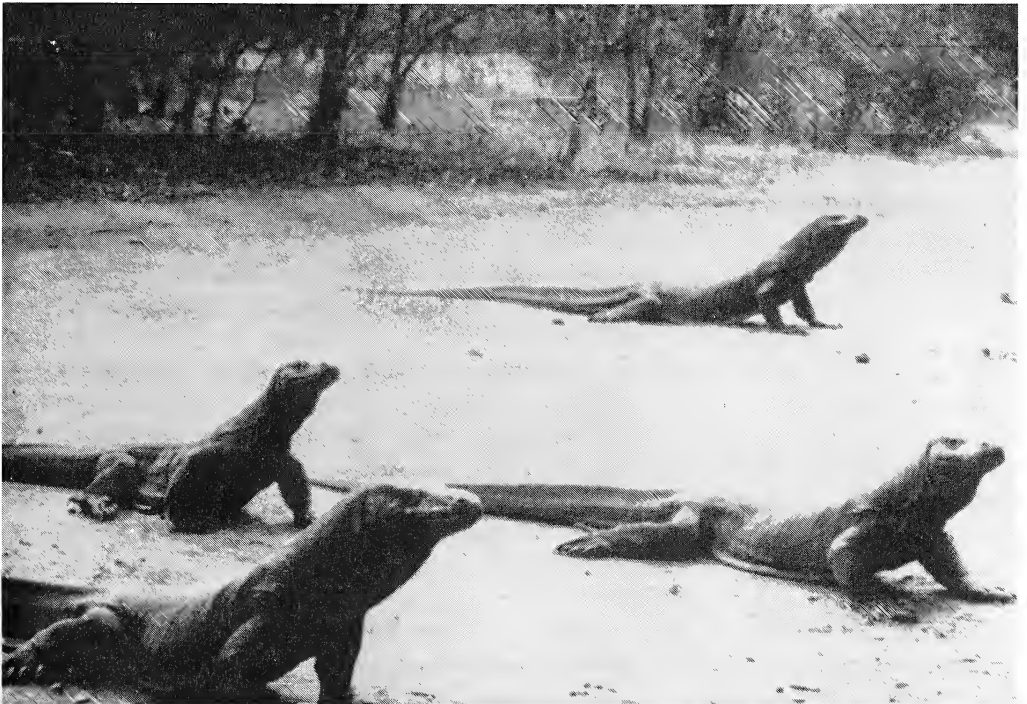

**Komodo dragons can be either hunters or scavengers and often times will prey on smaller members of their own species. (Photo by Robert Berghaier)**

As we neared the feeding grounds, we saw several signs which warned us to stay on the path and that the dragons could be dangerous. The monitors can reach the length of three meters (9.8 ft.) and weigh seventy to ninety kilograms

(150-200 lbs.). On rare occasions people have been killed by the dragons. Over the years several villagers on the main island have fallen victim to the dragon's toxic bite. One tourist, a Dane in his eighties, was probably devoured by dragons while lost on a hike some years back. There have been a few other fatalities reported to the park service over the years. Suhada, in spite of her numerous trips to Komodo escorting tourists, feared the dragon with all her heart.

Our ranger escort carried forked sticks, which Suhada explained would be used to turn the dragons aside if they came too close. On the trail we passed some megapode birds or orange-footed scrub fowl. Megapode birds are interesting in themselves. The bird buries its eggs under a mound of vegetation. The mound acts as a natural incubation chamber. The decaying vegetation incubates the eggs. If the bird feels that the mound is too hot, it clears some of the debris away to form vents that lower the temperature insuring a successful hatching.

We came in sight of the monitor feeding area which was enclosed by a waist-high wooden fence. Suddenly, I caught some movement in the corner of my eye and the dragons appeared. They still associate the rangers with food, and a half-dozen larger Komodos started surging toward us. The rangers tried to hold the dragons away with their sticks, and at the same time shepherd us behind the stockade.

In retrospect it was a comical scene; the dragons charge towards the rangers causing the tourists to run in panic towards the viewing area. To complicate matters a pair of large Dutchmen, these guys could have easily played defensive tackle for any NFL team, inadvertently blocked the stockade entrance as they calmly photographed their fellow tourists being chased about by the Komodos. We all eventually pushed past them and got behind the stockade. Once we were all behind the wooden fence both the dragons and tourists finally relaxed.

There were at least a dozen reptiles roaming about outside the stockade. They are a magnificent animal. I freely admit that the dragons left me in a state of awe. They are large, agile, and the most imposing reptile I have ever seen. We had one hour in which we could photograph and observe them. The dragons were milling around the stockade and if they got too close to one another, the larger animal would lunge towards its smaller neighbor with its mouth open, drooling saliva.

As the heat of the morning increased, the Komodos slowed down. It was then, as they raised up on their front legs to cool themselves, that I discovered that a large dragon comes up to my waist; about three feet high! A very large reptile indeed. Nearby, in the old feeding pit, were several rusa stags which did not seem to be put out by being so close to such a formidable predator. Our time was up so the rangers escorted us back to the park headquarters. Our departure was much less eventful than our arrival had been.

A few of the smaller monitors were moving through the post area. The tourists, in view of our recent experience that morning, gave them a wide berth. Back at

the park headquarters I visited the park museum. Inside was a wealth of information about Komodos. There were skeletons, skins, and eggs of the dragon plus information about their ecology.

There are an estimated 3,000+ dragons remaining in the wild. Most are found on the island of Komodo with smaller populations on Padar Island, Rinca Island, and the western end of Flores Island. The Indonesian Park Service is currently looking into the possibility of reintroducing Komodos to some nearby smaller islands on which the dragons used to be found. They are currently waiting for genetic analyses which will determine which form is most closely related to the vanished types; that genotype will be used for the reintroduction project. The dragons found on Flores, unlike those on the smaller islands, are in great danger due to overhunting and habitat destruction. However, overall the Komodo dragon still inhabits as much of its original range as it did when first discovered by Europeans. Few other large predators on this earth can make a similar claim.

Unlike most of the other tourists who visit the park for a brief visit of a few hours, I was going to have three more nights in the region. After lunch we set sail for Merah, meaning "red", Beach. It was here that I did some snorkeling and swimming. There was a small coral reef twenty yards offshore that contain numerous tropical fish. The water and air were warm but neither were oppressive. It was a wonderful break. We saw other birds here including frigate bird, purple heron, pacific reef-egret, white-bellied fish-eagle, and collared kingfisher.

Our next destination was the village or "kampung", of Komodo. This kampung supports over 1,000 people. Their only source of income is fishing, and every evening dozens of small boats leave the harbor to fish the water around the park. These waters also support a vibrant marine mammal and fish eating bird population. According to Suhada the people of Komodo have one of the highest birth rates in Indonesia. If this population increase is allowed to proceed unchecked, I can foresee a collapse of the local fishery and a resultant decline in the populations of marine mammals and sea birds.

Komodo village is a rather battered looking place. Most of its residents live in rickety wooden structures. The largest and best constructed buildings are the two mosques, school, and dispensary. Suhada told me that the dispensary does not rate a full-time doctor; he only stays two weeks a month. However, a nurse lives in the village full-time. The ranger staff from Komodo Park live here also, but their dwellings are more elaborate and presumably more comfortable than those of their neighbors.

The main drawback to living on the island, besides the obvious lack of a diverse source of income, is a shortage of fresh water. The only dry season source of potable water for the residents is a gasoline-driven pump which provides a thick trickle of well water. Suhada pointed out a crowd of women and young girls waiting their turn to fill numerous plastic buckets with fresh water for their families' use. This process must take up a good part of their day. In spite of the

poverty, the children were as curious and as friendly as I have found throughout Indonesia. They always asked to get their pictures taken and posed enthusiastically.

After leaving the village we sailed to a small inlet offshore which was a roost for large flying fox fruit bats. The trees of the island first appeared to contain nesting birds until, after using my binoculars, I realized the birds were actually bats hanging upside down. We pulled up close to the island. The crew started shouting and clapping their hands. This, unfortunately, disturbed the bats which started flying over the island in panic. We backed away and headed for another nearby island to anchor for the night. While performing this maneuver a group of bottlenose dolphins passed near our schooner. We had to move due to some winds which blew up after midnight. As a result we had to move to the leeward side of the island and closer to the village. I awoke the next morning at 4:30 to the voices of mullahs using a speaker system calling the faithful to the first prayers of the day.

After a short trip to Komodo village to get some fresh squid, we set out to our harbor for the next two nights; the island of Rinca. This island, part of Komodo Park, is a bit wilder than the main island. It took us two hours to reach the small harbor near the ranger post. Again the scenery was striking. Rinca is called "Serengeti by the Sea" in tourist brochures. It does have a sort of African feel to it. The terrain of the island is rolling grassy hills with scattered tall palm trees. The wildlife here, while not prolific, is easily seen. Instead of Cape buffalo, zebra, and warthog there are water buffalo, feral horses, and wild pig. In lieu of antelopes, rusa deer can be found. In place of baboons are long-tailed macaques.

However, there are none of the great mammalian predators that can be seen in the African savannah. In their place is the Komodo dragon. The dragons of Rinca are not as large as those of Komodo. They are a dark green almost black color. There are other smaller animals about and I saw scrub fowl, house, and tokay geckos. I also saw a bat flying early one morning over the sheltered inlet in which we anchored. I eventually identified it as a Horfield's myotis. The bird life has many of the same species as those found on Komodo. I saw rainbow bee-eater, little egret, striated heron, common sandpiper, pick-headed imperial pigeon, stork-billed kingfisher, zebra dove, rufus winged buzzard and Australian kestrel. The kestrel was hunting geckos at dusk. It was quite skilled at this; waiting until the geckos called then swooping down to carry them off.

The midday heat was oppressively hot, so Suhada arranged morning and evening walks. With our ranger escort we would always find something of interest. The lone male buffalos we saw were particularly impressive with their large, sweeping horns. An evening walk turned up a small herd of horses with a young foal. On a morning walk I spotted two adult female pigs coming up the trail with a small piglet behind them. I waited until they came close before I started taking pictures. This startled them and the adults ran away towards my left. The baby bolted towards the right. Our route back to the ranger post



was straight ahead so we had to continue down the trail. The adults ran away from us and away from the piglet. The piglet was in an obvious state of panic and it ran from us to the right in the opposite direction of the adults. It appeared that the adults were eventually going to circle back towards the piglet but I have no idea if they ever did. I still worry about that little pig; there were numerous dragons nearby. It showed me that even the most benign tourist, such as myself, can inadvertently cause harm while viewing animals.

My last night on the schooner was a memorable one. Mr. Sagee cooked and Suhada served another excellent dinner, using the squid purchased to the Komodo kampung. Later that evening she got Arif, Mr. Sagee, and the crew together on the deck and arranged an impromptu farewell party. The major part of this turned out to be a group sing-along. Mr. Sagee, who had a good voice, did the main vocals. The others clacked spoons, tapped bottles with a knife, and clapped their hands. They sang several traditional Indonesian songs. They asked me to contribute and I provided my version of Simon and Garfunkle's "It's All Happening at the Zoo", and my high school fight song. They seemed to enjoy my efforts and applauded enthusiastically.

We awoke early for the voyage back to Sape, leaving at dawn. This time the route took us past the north of Komodo. The most striking scenery was on Banta Island located to the east of Komodo. Like Komodo, it had cliffs where the shores were worn away by the sea. There was not much visible marine life; however, I saw some more shearwaters and some storm petrels. The highlight was seeing the huge black tail fluke of a whale disappear beneath the waves off in the distance. It was probably the fluke of a sperm whale, a species that is very common in these waters.

We were pushing hard against the prevailing currents and the sea at times was rough. I noticed that the crewmen on several occasions were bailing out the hull where the boat engine was located. We arrived safely in Sape after an eight-hour voyage. I spent the night in Bima and left the next morning for Bali and Samarang West Java. From there I would reach my eventual destination, Kalimantan, the home of the red ape.

---

---

## **Please Note New AKF Deadline**

**Beginning in 1996 the monthly deadline for  
*Animal Keepers' Forum*  
will be the 10th of each month**



*By Kayla Grams, Arizona-Sonora Desert Museum  
and Gretchen Ziegler, Sequoia Park Zoo*

**PRIMATES:** An indoor rainy day activity: squirrel monkey using a foraging container. Anything with a wide mouth will work easily for filling (this was a plastic salsa container) with hay and bits of special food—mealworms and grapes. The monkeys become occupied with tugging and pulling the long strands of hay through an arm sized hole cut in the side of the jar. If possible, provide one or more containers for each monkey.



*—Camille Dorian  
Monkey Zoo, Orinda, CA*

The following are excerpts from a survey on aardwolves and hyenas compiled by The Enrichment Resource Committee (TERC) at the San Diego Zoo, using information from 16 different zoos.

**AARDWOLF:**

**Water:** water is a constant in every enclosure for ad lib consumption in crocks, rubber tubs, bowls and lixits. It is also used as a pond, misters, pools, as a litter for defecation and a bubbler on the floor.

**Enclosure:** Most had a flat geography or sloped downward. Live (evergreens/

banana plant) and dead vegetation were used to soften the environment of enclosures. Rocks were used as decoration and hiding places were provided with browse, slopes and shrubbery could also serve this purpose. Most were housed with access to outside and one was housed in a nocturnal exhibit. Outside dirt enclosures had protection as base of fence lines to prevent digging out of enclosure. One animal is given access to a procupine exhibit, when its empty, to scent mark and play inside.

**Diet:** Items such as Nebraska Brand® canine diet, Nebraska Feline Diet®, a soaked kibble/feline combination, a pureed fruit/feline combination and a gruel.

**Treats:** Mostly treats were identified as waxworms, mealworms and/or crickets that were scattered or hidden in the exhibit. Also including sweet potato, beef bone, chicks and a honey/relish mix painted in exhibit furniture.

**Toys:** Toys were Boomer Balls®, branches, boxes, bags, rawhide, small sticks, milk crates, plastic toys and decaying logs.

**Substrate:** Most substrates are either cement or natural dirt yards. Many are combinations of cement with dirt, sand, sandy soil or mulch. Loose substrates are used to hide treats or toys. One animal had straw substrate for a burrow.

**Mixed Species Attempts:** One animal was housed with 13 meerkats, until the meerkats became too aggressive. Four animals were housed with Colobus monkeys, crowned guenons and rock hyrax.

## **STRIPED HYENA/ BROWN HYENA/ SPOTTED HYENA :**

**Water:** Ad lib sources of water include metal tubs, lixits and a pool fill water valve. Many have ponds and one specifically noted for bathing.

**Enclosure:** Most had a sloped moat and only one had a flat geography. Most had cement flooring and one had a combined dirt yard/inside cement enclosure. One had a tunnel for public with viewing windows into exhibit. Dead climbers and live plants (papyrus, grass, trees, shrubs) used in naturalistic exhibits. One exhibit had five levels and a dry moat.

**Diet:** Included; Nebraska Brand® feline and canine, Animal Spectrum® frozen canine dry dog food as sources of protein. As a source of roughage and gum stimulation the following foods were used; pig/cow ears, tail bones, leg bones, rawhide and milk bones, whole - rabbits, chicken, mice, horse meat and chicks.

**Treats:** There is much written about hyenas eating produce as a treat including; cucumber, carrot, yam, pear, banana, apple and raisins. Also food like carrot, bagel, monkey biscuits, hard-boiled egg and scattering kibble in hay. Other examples of treats were vienna sausages, liver, giant mealworms, cheese, popcorn and cookies. Also sheep/cow heads, whole chicken/rabbit/organ meat, tilapia fish in ponds, horse tails, and shank bones.

Toys: Among the responses were: Boomer Balls®, milk crates, branches, coconuts, browse, rock/brush piles, keeper interactions, bamboo, christmas trees, rawhide chew bones, cardboard boxes/tubes, boots, tires, feral animals and plastic barrels.

Substrate: Substrates mentioned were; hay, dirt on cement, gravel places, a sand box and grass with lime dust.

Scent Stimulation: Spices and cologne are used on logs and ground. Also elephant/rhino dung are used very successfully.

—*Rachél Watkins Rogers*  
*San Diego Zoo, San Diego, CA*

**Ideas appearing in this column have not necessarily been tested by the editors for safety considerations. Always think ahead and use good judgement when trying new ideas.**

---

## **Puget Sound Chapter Works to Assist Tree Kangaroo SSP**



Special Offer - The Puget Sound AAZK Chapter has a supply of the Tree Kangaroo posters designed for the Tree Kangaroo Species Survival Plan (SSP) by Conservation International. The posters depict all ten species of tree kangaroos and include text in both English and Bhasa or pidgin English. For those Chapters at zoos with tree kangaroos, these posters are a great tool for raising public awareness of tree kangaroo conservation, in addition to being a great fund-raising item.

These posters will be available for a limited time only at a cost of \$6.00 per poster or 25 posters for \$105.00. The cost includes U.S. postage and handling. **100% of sales goes for the Tree Kangaroo SSP In Situ Conservation Program..** Make checks payable to: Puget Sound AAZK Chapter and mail to the attention of Tina Mullett, Woodland Park Zoological Gardens, 5500 Phinney Avenue North, Seattle, WA 98103.

## AAZK Announces New Professional & Contributing Members

Missie Langley , Stone Zoo (MA); Susan Maiorano, Popcorn Park Zoo (NJ); William Robert, Utica Zoo (NY); Marc D. Ankerud, Buffalo Zoological Gardens (NY); Bradley Hange, Baltimore Zoo (MD); Jayne Tardona, Jacksonville Zoological Gardens (FL); Paul F. Onesky, Central Florida Zoological Park (FL); Marco Proiette Conti, Lion Country Safari (FL); Lisa Hopson, Knoxville Zoo (TN); Brian Craft, Rebecca Burnette, Brenda Dyson and Jennifer LaGura, Jackson Zoological Park (MS); Claire Irmiter, Cleveland Metroparks Zoo (OH); Thomas S. Brown, Detroit Zoo (MI); Richard L. Schroeder, Species Survival Center (MI); Carmen Murach, North Eastern Wisconsin Zoo (WI); Jennifer London, Central Wisconsin Wildlife (WI); Kristin M. Krawczyk, Niabi Zoo (IL); Greg Campbell, Wildlife Prairie Park (IL); Jennifer Shilcox, Kansas City Zoo (MO); Thomas S. Larimer, Lee Richardson Zoo (KS); Shannon Rogers, Dallas Zoo (TX); Melanie Haynes, Dale R. Berryman, Jason W. Garnett, Audrey Adams and Ted Mort, Pueblo Zoo (CO); Jennifer E. Yocom, Rio Grande Zoo (NM); Kimberly Holt, San Diego Zoo (CA); Antonietta Cauteruccio, San Francisco Zoo (CA); and Kenneth L. MacKay, Valley Zoo (Edmonton).

### New Contributing Members

Fort Wayne Children's Zoo, Ft. Wayne, IN  
Moody Gardens, Inc., Galveston, TX  
Chaffee Zoological Gardens, Fresno, CA

### Renewing Contributing Members

Mark & Kate Hofling, Bronx Zoo  
(NYZS), Bronx, NY  
Bruce M. Thomas, Takoma Park, MD  
Steve H. Taylor, Director,  
Cleveland Metroparks Zoo  
Cleveland, OH

# THE GOURMET RODENT™



## RATS AND MICE

Bill & Marcia Brant  
6115 SW 137th Avenue  
Archer, FL 32618  
(904) 495-9024  
Fax (904) 495-9781

© All Rights Reserved

## Need to Reach AAZK?

1-800-242-4519 (U.S.)  
1-800-468-1966 (Canada)

FAX: (913) 273-1980

or write

AAZK, Inc.

635 S.W. Gage Blvd.  
Topeka, KS 66606-2066  
U.S.A.



# Chapter News Notes

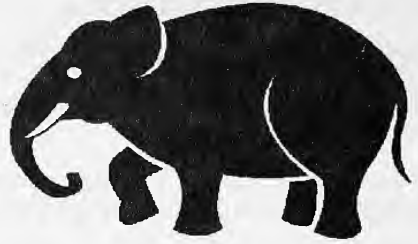

## Central Florida Chapter

In July, members of the Central Florida Chapter gathered at Disney's Discovery island for a cook-out and "Bunny Bingo" fundraiser. Although our bunny failed to "poop" we did manage to raise Chapter funds. Everyone who participated enjoyed the evening's festivities.

Also in July, members of the Chapter headed east to Melbourne Beach for a turtle walk led by Paul Bertourney of the Sea Turtle Preservation Society. July is the peak time of the year for sea turtles to come ashore and build their nests.

Due to hazardous weather, created by Hurricane Erin, no meeting was held this August. September's guest

speaker was Virginia Edmonds, Lowry Park Zoo) who spoke about river otter training. On 12 and 13 October, we held our annual camp-out at "Earth Camp", an education facility run by Silver Springs Park. All the Florida Chapters were invited, and those who attended were treated to a classic example of southern hospitality! Many thanks to the Silver Springs staff.

Other Chapter activities include: an animal print raffle to raise funds for National AAZK; printing our newsletter "ZU"; and we are investigating the possibilities of a workshop in May.

—Rick Smith, President

---

## Bongo and Nyala Crate Training Papers Available

Copies of two papers detailing crate training procedures for bongo and nyala are available from the authors upon request. The papers describe in detail the procedures used to train these species to cooperate with blood sampling and other procedures, while confined in a specially designed handling crate at the Denver Zoological Gardens. Those individuals who supplied an address to the collection envelope at the AAZK National Conference will have to request copies again, as that envelope was lost in the shuffle and never made it back to me (sorry!). We will pay for copies and shipping, but self-addressed, stamped envelopes are welcome.

Please send your request for copies of the papers to: Temple Grandin, Dept. of Animal Sciences, Colorado State University, Fort Collins, CO 80523 OR Fax Denver Zoo Hospital, Attn: Megan Phillips (303) 370-8006. Please include name, address, institution and position. We welcome further questions anyone may have regarding this crate training method. Dr. Grandin may be reached at Grandin Livestock Systems (970) 229-0703. Megan may be reached by leaving a message at the Denver Zoo Hospital (303) 331-4121.

---

# *Play Behavior and It's Role in Evaluating Animal Health*

*By James Bousquet  
CAT TALES, Spokane, WA*

I have long believed that play behavior in captive animals is an expression of high spirits and good health. Therefore, it is an excellent resource we can use on an everyday basis to evaluate the health of our animal collection. **An animal that never plays has been damaged developmentally, and is probably severely depressed.** Scientific studies indicate that animals, human and nonhuman, **MUST** engage in play behavior as youngsters in order to develop the skills necessary to become successful adults. Human and nonhuman young play for developmental learning while adults play as an expression of mental and physical health, as well as the sheer joy of living.

The behavior of captive animals, whether it is normal or abnormal, depends on the richness or emptiness of their lives as youngsters and the quality of their habitat as adults. Captive animals that never play, are depressed, adapt poorly, and have grown up in, or are now living in, a sterile environment. Finding a way to release normal behaviors thorough enrichment programs may help developmentally unstable animals. Since play behavior is an excellent indicator of your animals' health, it can be used as a measure of your animals' vigor.

Thankfully, innate behaviors represent a large portion of an animal's behavioral repertoire. By studying our animals "species typical behavior", we can develop an "ethogram" which will guide the implementation of our animal management program. The propensity of an animal to utilize an innate behavior is controlled by an "**innate releasing mechanism**", (**IRM**) which is stimulated by external factors called, "**releasers**". (We create "releasers" for our animals with enrichment projects.) They release normal "species typical behaviors" by enrichment items, naturalistic exhibits, and behavior modification.

**"How an animal uses its morphological and physiological equipment is of vital adaptive importance, and forms the substance of behavior".** The function of behavior is to "**enable an animal to adjust to external and internal conditions i.e., to maintain homeostasis**". The environmental conditions we provide for our animals are the things it uses to maintain homeostasis. So how important is behavior in evaluating our animal collection? It means everything. Behavior is the instruction book we use to guide our efforts to create the perfect habitat for our animals. (An animal that does not behave normally is existing, not living.) Play behavior, along with many other normal behaviors, are excellent tools to use in evaluating the health of your animal collection.

In my article "Building a Relationship with Your Animals" (Vol. 20, No. 4, April 1993 *Animal Keepers' Forum*), I mentioned how I encouraged my animals to

play. I felt it was beneficial to them and I loved to see them cut loose. The latest scientific studies of play behavior clearly show its importance to a healthy lifestyle and further reinforces my belief in the value of encouraging your animals to play. Encouraging your animals to play through the use of rewards, verbal cues, and enrichment items is one of the most important things you can do for them.

Apparently the scientific study of play in human and nonhuman animals has been going on for some time. There has been little agreement on how to define play, but all agree that it is beneficial and necessary for normal development. Renowned naturalist Edward O. Wilson wrote, "No behavioral concept has proved more ill-defined, elusive, controversial and even unfashionable". In a wonderful article in *National Geographic*, "Animals At Play" (Vol. 186, No. 6, Dec. 1994 National Geographic Society), author Dr. Stuart L. Brown described play as "spontaneous behavior that has no clear-cut goal and does not conform to a stereotypical pattern. The purpose of play is simply play itself; it appears to be pleasurable".

I believe play does have a goal. It is the release of an abundance of energy only good health can produce. It is the expression of the joy of living for all to see. To animals of the same species it means "see me, I feel good, come play with me." It is also a declaration of fitness and alertness to predators, who I am sure see a listless animal as an easy meal. Predatory animals' play surely displays its alertness and ability to defend its territory. So play is not only an expression of good feelings, it is an overt signal to others of their fitness. It is meant to be seen by others. That's why it is such an important tool for us.

Dr. Stuart's definition of play alluded to the absence of stereotypical behavior. That part of his description brings up a lot of interesting thoughts. In play there is an absence of stereotypical behavior. Isn't it logical that other enrichment activities which release normal behaviors will further reduce stereotyped behavior? Now we begin to see how important our role is in shaping our animals' lives. The richness or poorness of their lives literally depends on what we provide for them.

In "Building a Relationship with Your Animals", I discussed the micro management of our animals in order to give them more freedom and a more normal life. This seems to be a contradiction. How can we achieve freedom for our animals if we exert more control over their lives? The real question is how can they behave normally if we don't take control of their lives by providing the releasers they require to behave normally? How normal or abnormal they are depends on how well we meet their species-specific needs. We must provide the required releasers through research, observations and exhibit modifications to free an animal's innate behavioral repertoire. Once improvements are in place, recognizing and evaluating play behavior will be an excellent source of knowledge in evaluating the quality of the environment you have created.

Stuart described five different types of play behavior which begins with "less



complex play” and graduates to “more complex play”. I would like to share these with you so you can become more familiar with the behavior patterns associated with play. Stuart describes play patterns as follows:

**Solitary Play-** Many mammals and birds play alone. Spontaneous solitary games include leaping, twisting the body, and boisterous kicking.

**Play Fighting-** This social behavior involves facial signals and body postures saying, “no harm will come”. An animal may play carefully with a weaker opponent to prolong the fun.

**Object Play-** Sticks or rocks often become toys for mammals and birds.

**Social Play With Objects and Landscape-** Play with parts of the environment and throughout the environment teaches animals texture; how their habitat feels.

**Complex Social Play-** In primates tickling games, tug-of-war, playing with objects together, wrestling, and so on helps them develop intricate and creative play behavior.

I hope this description of play will be useful in developing a play “ethogram” for your animals. Recognizing and encouraging play in your animals will go a long way toward BREAKING THROUGH with them so they can be free to live a more normal life.

## Information Please

I am looking for information regarding reintroduction of a hand-reared lion cub to the pride. Our pride consists of 1.2 adults. The cub is a male, age two months presently. Any suggestions would be greatly appreciated! Please write or fax: Michelle Schireman, Zoo Atlanta Mammal Dept., 800 Cherokee Ave. S.W., Atlanta, GA 30315; Fax# (404) 624-5684.

---

I am an intern at the International Crane Foundation working on a project concerning excessive and uneven bill growth in several of ICF's cranes. I am attempting to design and implement a simple mechanism whereby a crane can “file” its own bill to reduce time spent trimming and handling the birds. For example, wooden blocks covered in sandpaper, or pumice-like rocks mixed with food may provide rough substances at which cranes could repeatedly strike. Such mechanisms may be thought of as enrichment tools to promote thorough foraging in addition to providing a potential solution to a medical problem. If anyone has any information, suggestions or ideas for such mechanisms, please send to: Gwen Stevens, International Crane Foundation, P.O. Box 447, Baraboo, WI 53913.

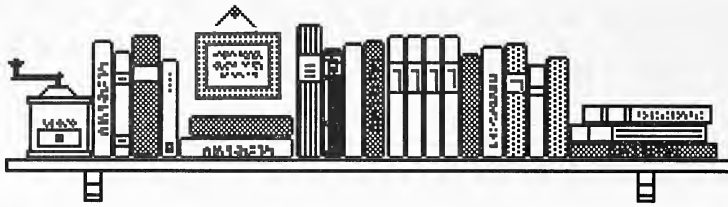

# Book Review

## **The Timber Wolf in Wisconsin: The Life and Death of a Majestic Predator**

By Richard P. Thiel

Forward by David Mech

The University of Wisconsin Press, 1993

114 North Murry Street, Madison, WI 53715

Paperback 253 pgs.

*Review by Dennis Davis  
Animal Keeper  
National Zoological Park  
Washington, DC*

The story of the timber wolf in the United States, and the rest of the world for that matter, has been a sad one. Part of the grim tale is recounted in this excellent book. In nine chapters, Richard Thiel takes us through the demise, extermination and final recovery of this extraordinary animal.

Chapter One gives a simple overview of the wolf's life history for those who may be unfamiliar with wolf ethology. Chapters Two and Three detail the history of humans and wolves in Wisconsin and upper Michigan. In the fourth chapter, anecdotal accounts are given by the people who are most familiar with the extermination of the wolves, namely, the trappers who brought it about. Chapters Five and Six touch on the politics that revolve around the wolves and official dealings with them. Chapters Seven and Eight reveal aspects of Wisconsin's 'secret wolf study' and describes the wolf's decline to extinction. The final chapter deals with the recovery in Wisconsin, a process that began in the 1970's and still continues today.

In addition to its nine chapters, this outstanding book contains over 30 photographs, seven tables, three maps and several graphs that help bring this interesting tale to life. Also, it contains a large reference section to guide the reader to further study on wolves. For anyone remotely interested in wolf recovery, this is a must-read book. I recommend it highly. Although based on scientific fact, most of which is contained in its five appendices, this publication is written in a non-scientific style which makes it easy and enjoyable to read.

Richard Thiel is currently the coordinator of the Sandhill Outdoor Skills Center. This outfit is part of the Wisconsin Department of Natural Resources in Babcock, WI. He has published many scientific papers on wolves and was chairman of Wisconsin's Wolf Recovery Plan Team in the late 1980's. The Timber Wolf in Wisconsin: The Life and Death of a Majestic Predator is a riveting account and one that should not be missed.

# Legislative Update

Compiled by *Georgann Johnston*  
*Legislative Advisor*  
*Sacramento, CA*



---

## U. S. Fish & Wildlife Funds Elephant Study in Mali

Mali, located in the northwestern portion of Africa, is the target of a \$50,000 grant for a survey of that country's desert elephants. The elephants, with a population estimated at 600, inhabit the Gourma region, which is just east of Timbuktu. The project will be carried out by the U.S. Embassy in Mali, Mali's Water and Forests Department and a private conservation organization known as "Elwan", the word for elephant in the language of the Tuareg tribe which resides in the Gourma region.

The money will be used to purchase communications and camping equipment and vehicles, and provide for operating expenses and educational material. One objective of the study is to investigate the migration patterns of the elephants, that are believed to travel nearly 500 miles per year - much farther than any other elephants.

Currently it is believed that the elephants face a number of serious long-term challenges, including desertification, a limited water supply, and competition for space with humans and their livestock. On the positive side though, these elephants have not been the target of poachers because their tusks are naturally short, probably a result of dietary deficiencies.

*Source: African Wildlife Update Sept./Oct. 1995, Vol. 4, No. 5*  
*from African Wildlife News Service*

---

## Endangered Species Can Be Saved, It Just Takes Time

In a report issued 30 October 1995, the USFWS said that America's efforts to save endangered species has prevented the extinction of more than 99 percent of animals and plants on the Endangered Species List and that 60 percent of the species listed the longest are stable or increasing in number. "This report shows that we can save endangered species, but it takes time," said Assistant Secretary George Frampton, citing examples of the Aleutian Canada goose, the Columbian white-tailed deer, and the greenback cutthroat trout.

From 1968 to 1973, 106 species were listed and today 61 are considered to be "stable or increasing". Unfortunately, the same positive status can be given to only 64 of the 294 species added between 1989 and 1993. Seven species listed between 1968-1993 have now been officially declared extinct.

Mollie Beattie, Director of the USFWS responded to critics of the Endangered Species Act who target the difficulty and cost of recovering a species: "Recovery is like emergency room medicine. It costs more than seeing your regular doctor for preventive care. And it costs more to recover endangered species than it would have cost to prevent their decline in the first place. Nevertheless, I doubt a single American would say that saving the bald eagle wasn't worth the time or money."

Beattie also pointed out that the budget for recovery programs for all 962 listed U.S. species was \$39.7 million in 1995, the cost of building just one mile of urban highway. "Americans spend 40 times more than our recovery budget on popcorn at the movies every year," Beattie said.

The report, entitled "1994 Report to Congress: Endangered and Threatened Species Recovery Program" is for sale by the Superintendent of Documents, U.S. Government Printing Office, Washington, DC 20402.

*Source: USFWS News Release, 30 October 1995*

---

## **Tigers and Rhinos Subject of Public Education Program**

Los Angeles, CA and its diverse Asian community is the initial target of a public education program launched by the USFWS. The rhino-tiger outreach program plans to tell Americans that certain products in Asian medicine shops may contain parts of these endangered species as well as toxins potentially harmful to human health. According to Assistant Secretary George Frampton: "The effort will provide new information for consumers regarding health risks associated with certain traditional Asian products. It will also clarify United States' law enforcement responsibilities regarding endangered species."

In a statement to the press, Frampton said that products made of tiger bone and rhino horn are believed by many to have therapeutic powers. However, when products purportedly containing rhino or tiger parts were purchased covertly in the Los Angeles area, analysis by the Service's National Fish and Wildlife Forensics Laboratory found that the majority of the products sold and labeled as containing rhino or tiger parts had no measurable amounts of either species present. Additionally, the scientists found a number of foreign substances and toxic levels of poisons such as arsenic and mercury in some of the products.

The purpose of the education program includes dissemination of information that importation of products containing rhino or tiger into the U.S. is prohibited under the Endangered Species Act and CITES and that by purchasing these products, whether they actually contain any trace of these animals or not, fuels the illegal trade.

*Source: USFWS News Release 19 October 1995*

---

## **Zambia Earns \$2 Million from Safari Hunting**

During the first nine months of 1995, the Department of National Parks and Wildlife in Zambia has earned \$2 million from safari hunting. The Ministry of that Department

has developed a safari hunting lease agreement which will be used as the controlling document with various safari industry companies. The leases will allocate areas of the country, including portions of national parks, to these companies in an effort to boost competition in the safari business. The Ministry also proposed a review of the National Parks and Wildlife Act of 1991 in an effort to "provide reforms in the department" with respect to this commercial endeavor.

*Source: Africa Economic Digest, 11 September 1995*

---

## **Lake Naivasha Designated Wetland of International Importance**

Kenya has designated Lake Naivasha and the surrounding riparian land as a "wetland of international importance" under the Ramsar Convention of 1971. This lake is located in Kenya's Rift Valley and its waters and shores provide habitat for 350 species of birds and a large number of mammals including hippo, waterbuck, bushbuck, impala, eland, Thompson's gazelle, giraffe and zebra.

Lake Naivasha does not have protected status since it is surrounded by privately-owned lands; mostly used for farming and growing flowers for export. A number of adjacent property owners formed a Lake Naivasha Riparian Owners Association and that organization supports the Ramsar designation.

The Ramsar Convention, which went into effect in 1975, was created to ensure the conservation of wetlands. The 90 signatories to the Convention are obligated to designate at least one wetland to the list of "wetlands of international importance" and by this action Kenya has now complied with that requirement.

No particular changes in the management of the wetlands is proposed at this time. Nearby residents who use the area for water, food and flower growing, fishing, and tourism will continue with those activities. Reportedly, the primary threat to the area includes excessive water extraction, soil erosion, and the use of agricultural chemicals but at this point no plan or governmental action has been developed to regulate or control those problems.

*Source: African Wildlife Update Sept./Oct. 1995, Vol. 4, No. 5  
from African Wildlife News Service*

---

## **Lebanon Confirms Ban on Hunting**

The Cabinet of Lebanon reaffirmed a national ban on hunting which went into effect 1 January 1995. Previously, Lebanon had a 14-week hunting season, which commenced in mid-September, for deer, elk, and various waterfowl. Despite a push by a lobbying group for gun manufacturers and retailers, the Cabinet, in early September 1995, reconfirmed its earlier ban and declined to reinstate the hunting time period.

*Source: Animal People News for People Who Care About Animals, October 1995*

# L.I.N.K. (Liaison and Information Network for Keepers)

Coordinator for the LINK System: Mark de Denus, Assiniboine Park Zoo, 2355 Corydon Ave., Winnipeg, Manitoba, Canada R3P 0R5. (204) 986-6921 [w]; (204) 837-2916 [h]. Assistant LINK Coordinator - Ric Urban, Houston Zoological Gardens, Houston, TX, 1513 MacGregor Way, Houston, TX 77030 (713) 520-3234 [w].

## Regional Coordinators

**ALABAMA** - Fred Alvey, Zoo Atlanta, 800 Cherokee Ave. S.E., Atlanta, GA 30315 • **ARKANSAS** - Ann Rademacher, Little Rock Zoological Gardens, #1 Jonesboro Dr., Little Rock, AR 72205 • **CALIFORNIA** - (Northern) Jean Lai, Oakland Zoo, 9777 Golf Links Rd., Oakland, CA 94605 and Ruby Lara, Sacramento Zoo, • **COLORADO** - 3930 West Land Park Dr., Sacramento, CA 95822-1123 • **COLORADO** - Susan Nolan, Denver Zoo, 2300 Steele St., Denver, CO 80205 • **CONNECTICUT**- Jeanette Beranger, Roger Williams Park Zoo, Providence, RI 02905 • **DELEWARE** - Theresa Maas-Anger, Philadelphia Zoo, 34th & Girard Ave., Philadelphia, PA 19104 • **FLORIDA** - Rick Smith, 4707 Walden Circle #409, Orlando, FL 32811 • **GEORGIA** - Fred Alvey, - Zoo Atlanta, 800 Cherokee Ave. S.E., Atlanta, GA 30315 • **IDAHO** - Holly Liappas, Tautphaus Park Zoo, P.O. Box 50220, Idaho Falls, ID 83405 • **ILLINOIS** - Pat Swieca, 5710 W. Cullom Ave., Chicago, IL 60634 • **INDIANA** - Jan Weinig, P.O. Box 197, Michigan City, IN 46360 • **KANSAS** - Brian Kohler, Lee Richardson Zoo, P.O. Box 499, Garden City, KS 67846-0499 • **KENTUCKY** - Scott Wright, Cleveland Zoo, 3900 Brookside Park Dr., Cleveland, OH 44109 • **LOUISIANA** - Rhonda Votino, 3535 Houma Blvd., Apt. 109, Metairie, LA 70006 • **MAINE** - Jeanette Beranger (see addresses under CT) • **MARYLAND** - Theresa Maas-Anger, Philadelphia Zoo, 34th & Girard Ave., Philadelphia, PA • **MASSACHUSETTS** - Jeanette Beranger (see addresses under CT) • **MICHIGAN** - Tim Sampson, John Ball Zoo, 1300 W. Fulton, Grand Rapids, MI 49504 • **MINNESOTA** - Tim Hill, Minnesota Zoological Gdns., 13000 Zoo Blvd., Apple Valley, MN 55124 • **MISSOURI** - Brian Kohler, Lee Richardson Zoo, P.O. Box 499, Garden City, KS 67846-0499 • **MONTANA** - Holly Liappas (see address under Idaho) • **NEVADA** - Patricia Simonet, Wildlife Safaris, P.O. Box 6735, Incline Village, NV 89450 • **NEW HAMPSHIRE** - Jeanette Beranger (see addresses under CT) • **NEW JERSEY** - Frank Leonard, Bronx Zoo, 185th & Southern Blvd., Bronx, NY 10460 • **EAST NEW YORK** - Frank Leonard, Bronx Zoo, 185th & Southern Blvd., Bronx, NY 10460 • **WEST NEW YORK** - Alan Baker, Burnet Park Zoo, 500 Burnet Park Dr., Syracuse, NY 13204 • **NORTH CAROLINA** - Kristin LaHue, Riverbanks Zoo, P.O. Box 1060, Columbia, SC 29202-1060 • **NORTH DAKOTA** - Bob Debets, Assiniboine Park Zoo, 2355 Corydon Ave., Winnipeg, MB Canada R3P 0R5 • **OHIO** - Scott Wright, Cleveland Metroparks Zoo, 3900 Brookside Park Dr., Cleveland, OH 44109 • **OKLAHOMA** - Ann Rademacher (see addresses under AR) • **OREGON** - Anna Michel, Washington Park Zoo, 4001 SW Canyon Rd., Portland, OR 97221 • **PENNSYLVANIA** - Theresa Maas-Anger, Philadelphia Zoo, 3400 W. Girard, Philadelphia, PA 19104 • **RHODE ISLAND** - Jeanette Beranger (see addresses under CT) • **SOUTH CAROLINA** - Kristin LaHue, Riverbanks Zoo, P.O. Box 1060, Columbia, SC 29202-1060 • **SOUTH DAKOTA** - Bob Debets (see address under ND) • **TENNESSEE** - Gail Karr, Memphis Zoo & Aquarium, 2000 Galloway, Memphis, TN 38112 • **TEXAS** - Connie Dieringer, Houston Zoo, 1513 N. MacGregor, Houston, TX 77030 • **VERMONT** - Jeanette Beranger (see addresses under CT) • **VIRGINIA** - Theresa Maas-Anger, Philadelphia Zoo, 34th & Girard, Philadelphia, PA 19104 • **WASHINGTON** - Joe Sullivan, Cat Tales, N. 17020 Newport Hwy., Mead, WA 99021 • **WEST VIRGINIA** - Theresa Maas-Anger, Philadelphia Zoo, 34th & Girard, Philadelphia, PA 19104 • **WISCONSIN** - Wayne Hazlett, 3768 S. 89th St., Milwaukee, WI 53228 • **WYOMING** - Holly Liappas (see address under Idaho) • **DISTRICT OF COLUMBIA** - Theresa Maas-Anger (see address under PA) • **Provinces of Manitoba & Saskatchewan** - Bob Debets (see address under ND) • **Provinces of Alberta & British Columbia** - Grant Tkachuk, 9955 114th St. Apt. A, Edmonton, AB T5K1P7 • **Atlantic Canada** - Bernard Gallant, RR # 7, 1081 Ryan Road, Moncton, N.B., E1C 8Z4

Vacancies exist for the following States or Provinces: Alaska, Arizona, Southern California, Hawaii, Iowa, New Mexico, Mississippi, Nebraska, Utah, Ontario and Quebec.

*Institutions wishing to advertise employment opportunities are asked to send pertinent data by the 15th of each month to: Opportunity Knocks/AKF, 635 S.W. Gage Blvd., Topeka, KS 66606-2066. Please include closing date for positions available and when setting these dates keep in mind that because of bulk-mail most readers do not receive the AKF until the middle of the month or later. There is no charge for this service and phone-in or fax listings of positions which become available close to deadline are accepted. Our phone is 1-800-242-4519 (U.S.; 1-8000-468-1966 (Canada). Our FAX is 913-273-1980.*

**ZOO KEEPER**...requires a minimum of one year paid zoo experience. Degree in zoology preferred. The candidate must be a team player who can work with a minimum of supervision. Duties include the care and feeding of over a hundred species of mammals, reptiles, and birds, as well as presenting educational programs. Send resumé and references to: Vince Hall, Claws 'N' Paws Wild Animal Park, RD 6, Lake Ariel, PA 18436.

**ANIMAL CARE SPECIALIST**...twelve-month, entry level position, incorporating all aspects of animal husbandry, record keeping, and daily observations of semi-free ranging hoofstock, rhinoceros, carnivores and birds. Requires Associate Degree and prior experience or an internship in an AZA-accredited zoological facility. Housing provided as part of salary compensation. Send resumé to: Fossil Rim Wildlife Center, P.O. Box 2189, Glen Rose, TX 76043 Attn: DeAnna Hansen. Position open until filled.

**SR. ZOO KEEPER/PACHYDERMS**...the Birmingham Zoo has an opening for a Sr. Keeper -Pachyderms. Applicant must have two years of zoo animal husbandry experience in pachyderm care. Salary \$22,193.00 - \$29,764.00, plus fringe benefits, etc. For more information call the Birmingham Zoo (205) 879-0409. Applicants are encouraged to apply as soon as possible.

**CHIMPANZEE CAREGIVER**...one full-time position open. Requires two years of college level course work, two years experience in the care of exotic animals; OR an equivalent combination of experience which provides the required knowledge, skills and ability. Primate experience a plus. Assist in the responsibility of caring for approximately 80 chimpanzees (*Pan troglodytes*) in a breeding colony. Must be willing to make a two-year commitment. Excellent benefits. EOE. Applicant must have a negative TB skin test, negative hepatitis B surface antigen test, and evidence of measles booster or natural disease prior to employment. Send letter of interest (with requested salary), resumé and three letters of reference to: Jo Fritz, Director, Primate Foundation of Arizona, P.O. Box 20027, Mesa, AZ 85277-0027. Position open until filled.

**ANIMAL CARE SPECIALIST**...requires excellent presentation/communication skills, hands-on experience with wild/exotic animals, and knowledge of animal husbandry/behavior, nutrition, and zoology. Responsibilities include, but are not limited to, presentation of wild/exotic animals in outreach settings, on-site educational show, daily animal care, exhibit maintenance, and record keeping. Salary \$7.00/hr., plus benefits. Send resumé to: Six Flags Magic Mountain, Animal Department, P.O. Box 5500, Valencia, CA 91385 (805) 266-4770.

**ZOOKEEPER I**...the North Carolina Zoological Park is accepting resúmes from keepers with hoofed stock experience to work in the African section of the zoo with giraffe, zebra, warthog, and ostrich. Incumbent will also work with chimps, lions,

and baboons. A degree in a biological science, as well as experience at an accredited zoo, are preferred. Starting salary is \$16,760.00, increasing to \$17,597.00 upon satisfactory completion of probation, plus benefits. Send resumé and cover letter **by 22 December 1995** to: Human Resources, Attn: Guy Lichty, North Carolina Zoological Park, 4401 Zoo Parkway, Asheboro, NC 27203. FAX (910) 879-2891.

**ZOOKEEPERS -Psittacines...**requires minimum of one year paid, hands-on experience with macaws and degree or equivalent zoo-related experience. **Mammals...**requires minimum of one year paid, hands-on experience with ungulates and felines and degree or equivalent zoo-related experience. Duties for both positions include daily care, feeding, habitat upkeep, breeding programs, record keeping, medical coordination, training, acquisitions, supervising part-time staff/volunteers, and presenting educational programs, etc. Must be willing to work weekends/holidays. Starting salary \$15,000 - \$20,000 with year-end bonus and benefits. Excellent growth potential. Salary commensurate with experience. Send resumé/ references to: Washington Zoological Park, 19525 SE 54th, Issaquah, WA 98027. FAX (206) 392-1076. Positions open until filled.

**BIRD CARE SPECIALIST...**requires a minimum of one year paid experience. Candidate must be a team player who can work with a minimum of supervision. Duties include care and feeding of many species of birds, incubation supervision, and hand-feeding. Salary and benefits commensurate with experience. Send or fax resumé and references to: Richard L. Miller, DVM, 5700 S.W. 130th Ave., Ft. Lauderdale, FL 33330. Ph.# (305) 434-8599, FAX# (305) 434-4889.



---

## DALLAS ZOO ANNOUNCES WORKSHOP ON DESIGN OF FUTURE LARGE CAT EXHIBITS

The Dallas Zoo will be conducting a brainstorming workshop to develop ideas and concepts for the design of future large cat exhibits. This is in concert with designing an exhibit with the National Fish and Wildlife Foundation's "Save the Tiger" Fund sponsored by Exxon. The free workshop will be held in Dallas from 12-13 January 1996, and is open to biologists, zoo professionals, and designers. Advanced reservations are required. For further information, contact Wanda Weaver at (214) 670-6833, FAX (214) 670-6717.

The "Save the Tiger" Fund (STF) will facilitate an international program to assist in the long-term survival of the remaining five subspecies of tigers. Exxon has pledged to donate \$5 million over five years towards this effort. The STF will be overseen by an independent council of leading zoologists, conservationists and tiger authorities. Through grants, the STF will support international tiger-related projects to help stabilize and improve tiger populations in the wild; to support protection; to enhance conservation breeding programs at zoos in the U.S., Europe, Asia and Australia; and to educate the public to the need for tiger conservation. For further information on STF contact: Save the Tiger Fund, National Fish and Wildlife Foundation, 1120 Connecticut Ave., NW, Suite 900, Washington, DC 20036 or call (202) 857-0166. --AZA *Communiqué* Nov. 1995



# AAZK Membership Application check here if renewal [ ]

Name \_\_\_\_\_  
Address \_\_\_\_\_  
City \_\_\_\_\_ State/Province \_\_\_\_\_ Zip \_\_\_\_\_

## U.S. Members

**\$30.00 Professional**  
*Full-time Keepers*

**\$25.00 Affiliate**  
*Other staff & volunteers*

**\$25.00 Associate**  
*Those not connected with  
an animal facility*

**\$50.00 or up - Individuals  
Contributing/U.S.**

**\$50.00 or up  
Institutional/U.S.**  
*Organizations / Institutions  
(requires Board approval)*

**International Members**  
**\$40.00 International**  
*All members outside U.S. &  
Canada regardless of category*

## Canadian Members

**\$35.00 Professional**  
*Full-time Keepers*

**\$30.00 Affiliate**  
*Other staff & volunteers*

**\$30.00 Associate**  
*Those not connected with  
an animal facility*

**\$55 or up - Individuals  
Contributing/Canada**

**\$55.00 or up  
Institutional/Canada**  
*Organizations / Institutions  
(requires Board approval)*

**Library Only**  
**20.00 Library**  
*Availible only to  
established libraries*

Zoo Affiliation (if any) \_\_\_\_\_

Zoo Address \_\_\_\_\_

Title \_\_\_\_\_

Work Area \_\_\_\_\_

My check is enclosed (AAZK, Inc.)

Please charge my credit card

MASTERCARD \_\_\_\_\_ VISA \_\_\_\_\_ Card # \_\_\_\_\_ - \_\_\_\_\_ - \_\_\_\_\_

Name on card \_\_\_\_\_ Expiration date \_\_\_\_\_

Signature \_\_\_\_\_

Mail this application to: AAZK Administrative Offices, Topeka Zoo, 635 S. W. Gage Blvd., Topeka, KS 66606-2066. Make checks/money orders payable to AAZK, Inc. Must be in U.S. FUNDS ONLY. Membership includes a subscription to *Animal Keepers' Forum*. The membership card is good for free admission to many zoos and aquariums in the U.S. and Canada.

**American Association  
of Zoo Keepers, Inc.  
635 S.W. Gage Blvd.  
Topeka, KS 66606-2066  
U.S.A.**

Address Correction Requested



*"Dedicated to  
Professional Animal Care"*

Non-Profit Organization  
U.S. POSTAGE PAID  
Permit # 646  
Topeka, KS 66603

National Zoological Park 3/76  
N/ZP Library  
Washington, DC 20008

558 PA 13  
04/18/96 198115 SELE









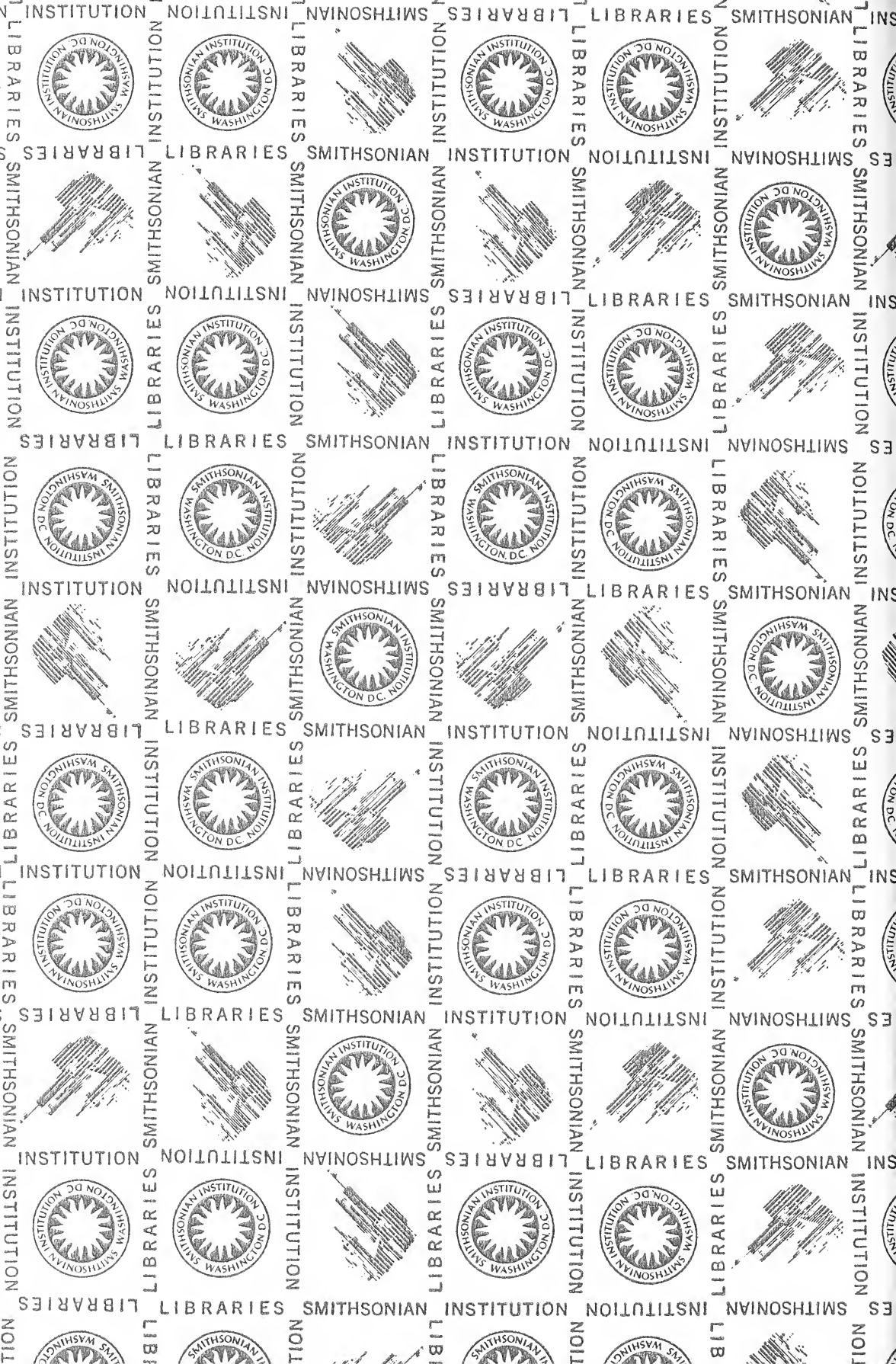

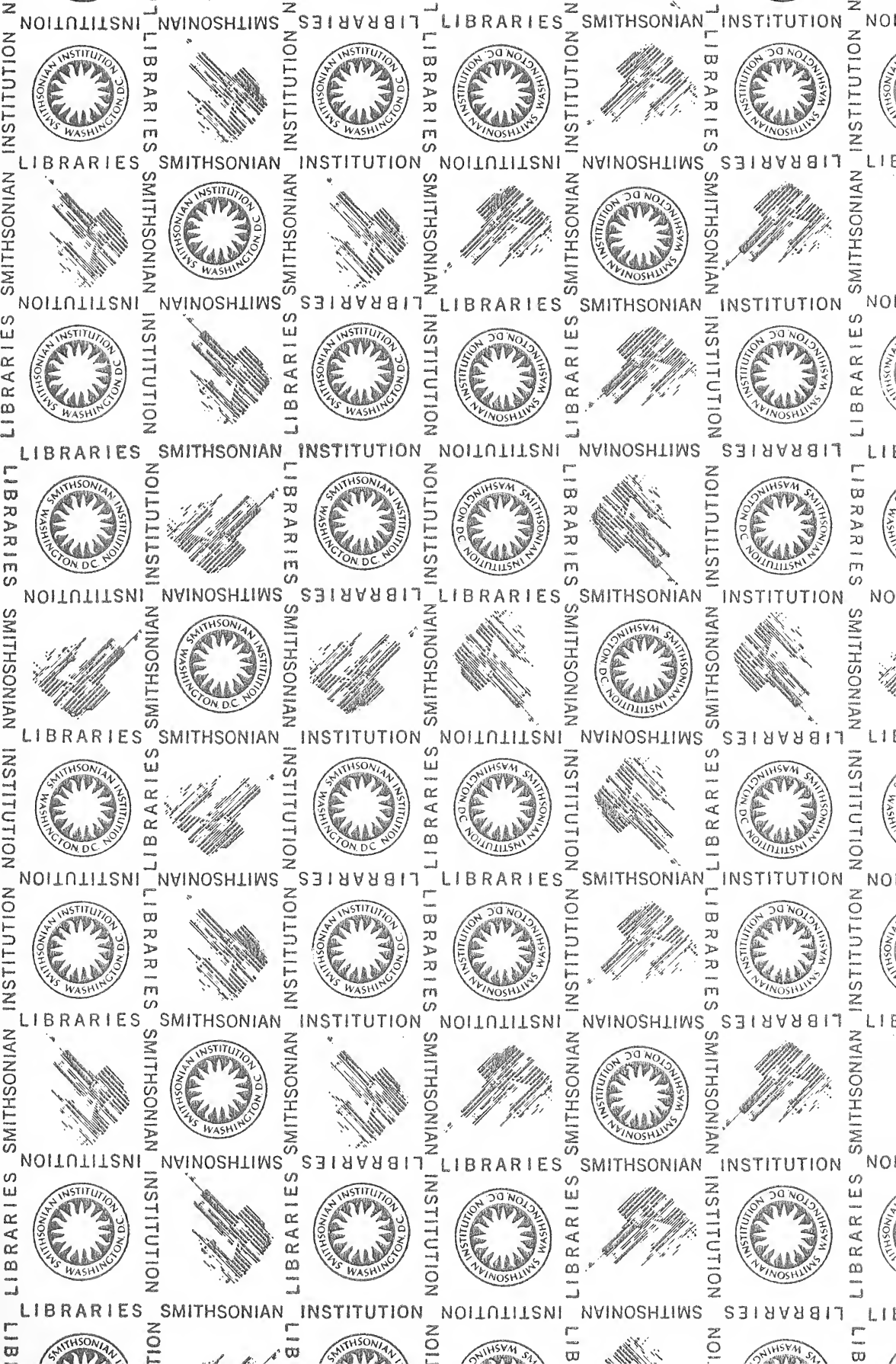

SMITHSONIAN INSTITUTION LIBRARIES



3 9088 01063 8591