







2  
58606  
sl.  
129

# ANNALS OF BOTANY

EDITED BY

DUKINFIELD HENRY SCOTT, M.A., LL.D., D.Sc., FOR. SEC. R.S.

LATELY HONORARY KEEPER OF THE JODRELL LABORATORY, ROYAL BOTANIC GARDENS, KEW

JOHN BRETLAND FARMER, D.Sc., M.A., F.R.S.

PROFESSOR OF BOTANY, ROYAL COLLEGE OF SCIENCE, LONDON

FRANCIS WALL OLIVER, M.A., D.Sc., F.R.S.

QUAIN PROFESSOR OF BOTANY, UNIVERSITY COLLEGE, LONDON

AND

ROLAND THAXTER, M.A., Ph.D.

PROFESSOR OF CRYPTOGAMIC BOTANY IN HARVARD UNIVERSITY, CAMBRIDGE, MASS., U.S.A.

*ASSISTED BY OTHER BOTANISTS*

VOLUME XXVII

With Fifty-nine Plates and Two Hundred and Eighty-one  
Figures in the Text

229392

LONDON

HUMHPREY MILFORD, OXFORD UNIVERSITY PRESS

AMEN CORNER, E.C.

EDINBURGH, GLASGOW, NEW YORK, TORONTO, MELBOURNE AND BOMBAY

1913

OXFORD : HORACE HART M.A.  
PRINTER TO THE UNIVERSITY



## CONTENTS.

### No. CV, January, 1913.

	PAGE
EAMES, ARTHUR J.—The Morphology of <i>Agathis australis</i> . With Plates I-IV and ninety-two Figures in the Text . . . . .	1
SINNOTT, EDMUND W.—The Morphology of the Reproductive Structures in the Podocarpaceae. With Plates V-IX and nine Diagrams in the Text . . . . .	39
WEST, G. S., and GRIFFITHS, B. M.—The Lime-Sulphur Bacteria of the Genus <i>Hillhousia</i> . With Plate X . . . . .	83
WOODBURN, WILLIAM L.—Spermatogenesis in <i>Blasia pusilla</i> , L. With Plate XI . . . . .	93
BALLS, W. LAWRENCE.—Apparent Fallacies of Electrical Response in Cotton Plants. With a Diagram in the Text . . . . .	103
BLACKMAN, V. H., and WELSFORD, E. J.—Fertilization in <i>Lilium</i> . With Plate XII . . . . .	111
WALKER, NORMAN.—On Abnormal Cell-fusion in the Archegonium; and on Spermatogenesis in <i>Polytrichum</i> . With Plates XIII and XIV . . . . .	115
ADKINSON, JUNE.—Some Features of the Anatomy of the Vitaceae. With Plate XV . . . . .	133
BRENCHLEY, WINIFRED E.—The Weeds of Arable Land. III . . . . .	141

NOTES.

COBURN, HILDA.—The Fruiting of <i>Catenella Opuntia</i> . . . . .	167
BROWNE, ISABEL.—Anatomy of the Cone and Fertile Stem of <i>Equisetum</i> . A Correction . . . . .	168
BLACKLEDGE, L. MARGARET.—Variations in the NaCl Content of Non-halophytes . . . . .	168
BAKER, SARAH M.—Note on a New Treatment for Silver-leaf Disease in Fruit Trees . . . . .	172

### No. CVI, April, 1913.

WAGER, HAROLD.—The Life-history and Cytology of <i>Polyphagus Euglenae</i> . With Plates XVI-XIX . . . . .	173
LANG, WILLIAM H.—Studies in the Morphology and Anatomy of the Ophioglossaceae. I. On the branching of <i>Botrychium Lunaria</i> , with notes on the anatomy of young and old rhizomes. With Plates XX and XXI and fourteen Figures in the Text . . . . .	203
HOLDEN, RUTH.—Some Fossil Plants from Eastern Canada. With Plates XXII and XXIII . . . . .	243
HILL, T. G., and DE FRAINE, E.—A Consideration of the Facts relating to the Structure of Seedlings. With a Curve, two Diagrams, and one Figure in the Text . . . . .	257
SALISBURY, E. J.—Methods of Palaeobotanical Reconstruction. With one Figure in the Text . . . . .	273
KISCH, MABEL H.—The Physiological Anatomy of the Periderm of Fossil Lycopodiales. With Plate XXIV and twenty-seven Figures in the Text . . . . .	281
SAXTON, W. T.—Contributions to the Life-history of <i>Actinostrobos pyramidalis</i> , Miq. With Plates XXV-XXVIII and three Figures in the Text . . . . .	321
TAKEDA, H.—Some points in the Anatomy of the Leaf of <i>Welwitschia mirabilis</i> . With Plate XXIX and five Figures in the Text . . . . .	347
TAKEDA, H.—A Theory of 'Transfusion-tissue' . . . . .	359

NOTES.

TAKEDA, H.—Development of the Stoma in <i>Gnetum Gneomon</i> . With ten Figures in the Text . . . . .	365
DELFT, E. M.—Note on an Attached Species of <i>Spirogyra</i> . With two Figures in the Text . . . . .	366
HOLDEN, H. S.—On the Occlusion of the Stomata in <i>Tradescantia pulchella</i> . With a Figure in the Text . . . . .	369

## No. CVII, July, 1913.

	PAGE
PRAIN, SIR DAVID.—The Mercurialineae and Adenoclineae of South Africa . . . . .	371
BAKER, SARAH M.—Quantitative Experiments on the Effect of Formaldehyde on Living Plants. With Plates XXX and XXXI and four Figures in the Text . . . . .	411
BOWER, F. O.—Studies in the Phylogeny of the Filicales. III. On Metaxya and certain other relatively primitive Ferns. With Plates XXXII-XXXIV and two Figures in the Text . . . . .	443
HILL, ARTHUR W.—The Floral Mechanism of the Genus <i>Sebaea</i> . With Plate XXXV and two Figures in the Text . . . . .	479
ARBER, AGNES.—On the Structure of the Androecium in <i>Parnassia</i> and its bearing on the Affinities of the Genus. With Plate XXXVI and four Figures in the Text . . . . .	491
BLACK, CAROLINE A.—The Morphology of <i>Riccia Frostii</i> , Aust. With Plates XXXVII and XXXVIII . . . . .	511
HOLDEN, RUTH.—Contributions to the Anatomy of Mesozoic Conifers. No. I. Jurassic Coniferous Woods from Yorkshire. With Plates XXXIX and XL . . . . .	533
TAKEDA, H.—Morphology of the Bracts in <i>Welwitschia mirabilis</i> . With Plate XLI and two Figures in the Text . . . . .	547
FRASER, H. C. I. (Mrs. D. T. GWYNNE-VAUGHAN).—The Development of the Ascocarp in <i>Lachnea cretea</i> . With Plates XLII and XLIII . . . . .	553
THODAY, D.—On the Capillary Euclimetric Apparatus of Bonnier and Mangin for the Analysis of Air in investigating the Gaseous Exchanges of Plants. With two Figures in the Text . . . . .	565
NOTE.	
BARTLETT, A. W.—Note on the Occurrence of an Abnormal Bisporangiate Strobilus of <i>Larix europaea</i> , DC. With two Figures in the Text . . . . .	575

## No. CVIII, October, 1913.

SAXTON, W. T.—Contributions to the Life-history of <i>Tetraclinis articulata</i> , Masters, with some Notes on the Phylogeny of the Cupressoidae and Callitroideae. With Plates XLIV-XLVI and nine Figures in the Text . . . . .	577
GLÜCK, H.—Contributions to our Knowledge of the Species of <i>Utricularia</i> of Great Britain with Special Regard to the Morphology and Geographical Distribution of <i>Utricularia ochroleuca</i> . With Plates XLVII and XLVIII and seven Figures in the Text . . . . .	607
HARPER, ALAN G.—Defoliation: its Effects upon the Growth and Structure of the Wood of <i>Larix</i> . With Plates XLIX and L and two Figures in the Text . . . . .	621
BEER, RUDOLF.—Studies in Spore Development. III. The Premeiotic and Meiotic Nuclear Divisions of <i>Equisetum arvense</i> . With Plates LI-LIII . . . . .	643
GRAHAM, MARGARET.—Studies in Nuclear Division of <i>Preissia commutata</i> . With Plates LIV and LV . . . . .	661
MCALLISTER, F.—Nuclear Division in <i>Tetraspora lubrica</i> . With Plate LVI . . . . .	681
THODAY, D.—On the Effect of Chloroform on the Respiratory Exchanges of Leaves. With fifteen Figures in the Text . . . . .	697
HILEY, W. E.—On the Value of Different Degrees of Centrifugal Force as Geotropic Stimuli. With Plates LVII and LVIII and three Figures in the Text . . . . .	719
BOSE, J. C.—On Diurnal Variation of Moto-excitability in <i>Mimosa</i> . With seventeen Figures in the Text . . . . .	759
THOMAS, N.—Notes on Cephaleuros. With Plate LIX . . . . .	781
COMPTON, R. H.—An Anatomical Study of Syncotyly and Schizocotyly. With forty-one Figures in the Text . . . . .	793

# INDEX.

## A. ORIGINAL PAPERS AND NOTES.

	PAGE
ADKINSON, JUNE.—Some Features of the Anatomy of the Vitaceae. With Plate XV . . .	133
ARBER, AGNES.—On the Structure of the Androecium in Parnassia and its bearing on the Affinities of the Genus. With Plate XXXVI and four Figures in the Text . . .	491
BAKER, SARAH M.—Note on a New Treatment for Silver-leaf Disease in Fruit Trees . . .	172
Quantitative Experiments on the Effect of Formaldehyde on Living Plants. With Plates XXX and XXXI and four Figures in the Text . . .	411
BALLS, W. LAWRENCE.—Apparent Fallacies of Electrical Response in Cotton Plants. With a Diagram in the Text . . .	103
BARTLETT, A. W.—Note on the Occurrence of an Abnormal Bisporangiate Strobilus of <i>Larix europaea</i> , DC. With two Figures in the Text . . .	575
BEER, RUDOLF.—Studies in Spore Development. III. The Premeiotic and Meiotic Nuclear Divisions of <i>Equisetum arvense</i> . With Plates LI-LIII . . .	643
BLACK, CAROLINE A.—The Morphology of <i>Riccia Frostii</i> , Aust. With Plates XXXVII and XXXVIII . . .	511
BLACKLEDGE, L. MARGARET.—Variations in the NaCl Content of Non-halophytes . . .	168
BLACKMAN, V. H., and WELSFORD, E. J.—Fertilization in <i>Lilium</i> . With Plate XII . . .	111
BOSE, J. C.—On Diurnal Variation of Moto-excitability in <i>Mimosa</i> . With seventeen Figures in the Text . . .	759
BOWER, F. O.—Studies in the Phylogeny of the Filicales. III. On <i>Metaxya</i> and certain other relatively primitive Ferns. With Plates XXXII-XXXIV and two Figures in the Text . . .	443
BRENCHLEY, WINIFRED E.—The Weeds of Arable Land. III . . .	141
BROWNE, ISABEL.—Anatomy of the Cone and Fertile Stem of <i>Equisetum</i> . A Correction . . .	168
COBURN, HILDA.—The Fruiting of <i>Catenella Opuntia</i> . . .	167
COMPTON, R. H.—An Anatomical Study of Syncotyly and Schizocotyly. With forty-one Figures in the Text . . .	793
DE FRAINE, E., see HILL, T. G.	
DELF, E. M.—Note on an Attached Species of <i>Spirogyra</i> . With two Figures in the Text . . .	366
EAMES, ARTHUR J.—The Morphology of <i>Agathis australis</i> . With Plates I-IV and ninety-two Figures in the Text . . .	I
FRASER, H. C. I. (Mrs. D. T. GWYNNE-VAUGHAN).—The Development of the Ascocarp in <i>Lachnea cretea</i> . With Plates XLII and XLIII . . .	553
GLÜCK, H.—Contributions to our Knowledge of the Species of <i>Utricularia</i> of Great Britain with Special Regard to the Morphology and Geographical Distribution of <i>Utricularia ochroleuca</i> . With Plates XLVII and XLVIII and seven Figures in the Text . . .	607
GRAHAM, MARGARET.—Studies in Nuclear Division of <i>Preissia commutata</i> . With Plates LIV and LV . . .	661
GRIFFITHS, B. M., see WEST, G. S.	
HARPER, ALAN G.—Defoliation: its Effects upon the Growth and Structure of the Wood of <i>Larix</i> . With Plates XLIX and L and two Figures in the Text . . .	621
HILEY, W. E.—On the Value of Different Degrees of Centrifugal Force as Geotropic Stimuli. With Plates LVII and LVIII and three Figures in the Text . . .	719
HILL, ARTHUR W.—The Floral Mechanism of the Genus <i>Sebaea</i> . With Plate XXXV and two Figures in the Text . . .	479
HILL, T. G., and DE FRAINE, E.—A Consideration of the Facts relating to the Structure of Seedlings. With a Curve, two Diagrams, and one Figure in the Text . . .	257
HOLDEN, H. S.—On the Occlusion of the Stomata in <i>Tradescantia pulchella</i> . With a Figure in the Text . . .	369
HOLDEN, RUTH.—Some Fossil Plants from Eastern Canada. With Plates XXII and XXIII . . .	243

	PAGE
HOLDEN, RUTH.—Contributions to the Anatomy of Mesozoic Conifers. No. I. Jurassic Coniferous Woods from Yorkshire. With Plates XXXIX and XL . . . . .	533
KISCH, MABEL H.—The Physiological Anatomy of the Periderm of Fossil Lycopodiales. With Plate XXIV and twenty-seven Figures in the Text . . . . .	281
LANG, WILLIAM H.—Studies in the Morphology and Anatomy of the Ophioglossaceae. I. On the branching of Botrychium Lunaria, with notes on the anatomy of young and old rhizomes. With Plates XX and XXI and fourteen Figures in the Text . . . . .	203
MCALISTER, F.—Nuclear Division in <i>Tetraspora lubrica</i> . With Plate LVI . . . . .	681
PRAIN, SIR DAVID.—The Mercurialineae and Adenoclineae of South Africa . . . . .	371
SALISBURY, E. J.—Methods of Palaeobotanical Reconstruction. With one Figure in the Text . . . . .	273
SAXTON, W. T.—Contributions to the Life-history of <i>Actinostrobis pyramidalis</i> , Miq. With Plates XXV–XXVIII and three Figures in the Text . . . . .	321
————— Contributions to the Life-history of <i>Tetraclinis articulata</i> , Masters, with some Notes on the Phylogeny of the Cupressoidae and Callitroideae. With Plates XLIV–XLVI and nine Figures in the Text . . . . .	577
SINNOTT, EDMUND W.—The Morphology of the Reproductive Structures in the Podocarpaceae. With Plates V–IX and nine Diagrams in the Text . . . . .	39
TAKEDA, H.—Some Points in the Anatomy of the Leaf of <i>Welwitschia mirabilis</i> . With Plate XXIX and Five Figures in the Text . . . . .	347
————— A Theory of 'Transfusion-tissue' . . . . .	359
————— Development of the Stoma in <i>Gnetum Gneumon</i> . With ten Figures in the Text . . . . .	365
————— Morphology of the Bracts in <i>Welwitschia mirabilis</i> . With Plate XLI and two Figures in the Text . . . . .	547
THODAY, D.—On the Capillary Eudiometric Apparatus of Bonnier and Mangin for the Analysis of Air in investigating the Gaseous Exchanges of Plants. With two Figures in the Text . . . . .	565
————— On the Effect of Chloroform on the Respiratory Exchanges of Leaves. With fifteen Figures in the Text . . . . .	697
THOMAS, N.—Notes on Cephaleuros. With Plate LIX . . . . .	781
WAGER, HAROLD.—The Life-history and Cytology of <i>Polyphagus Euglenae</i> . With Plates XVI–XIX . . . . .	173
WALKER, NORMAN.—On Abnormal Cell-fusion in the Archegonium; and on Spermatogenesis in <i>Polytrichum</i> . With Plates XIII and XIV . . . . .	115
WELSFORD, E. J., see BLACKMAN, V. H.	
WEST, G. S., and GRIFFITHS, B. M.—The Lime-Sulphur Bacteria of the Genus <i>Hillhousia</i> . With Plate X . . . . .	83
WOODBURN, WILLIAM L.—Spermatogenesis in <i>Blasia pusilla</i> , L. With Plate XI . . . . .	93

## B. LIST OF ILLUSTRATIONS.

- a.* PLATES. I–IV. Morphology of *Agathis* (EAMES).  
 V–IX. Podocarpaceae (SINNOTT).  
 X. *Hillhousia* (WEST and GRIFFITHS).  
 XI. Spermatogenesis in *Blasia* (WOODBURN).  
 XII. Fertilization in *Lilium* (BLACKMAN and WELSFORD).  
 XIII, XIV. *Polytrichum* (WALKER).  
 XV. Anatomy of the Vitaceae (ADKINSON).  
 XVI–XIX. *Polyphagus Euglenae* (WAGER).  
 XX, XXI. *Botrychium Lunaria* (LANG).  
 XXII, XXIII. *Tylo dendron* and *Voltzia* (RUTH HOLDEN).  
 XXIV. Periderm of Fossil Lycopodiales (KISCH).  
 XXV–XXVIII. *Actinostrobis* (SAXTON).  
 XXIX. Leaf Anatomy of *Welwitschia mirabilis* (TAKEDA).

PLATES. XXX, XXXI.	Effect o. Formaldehyde (BAKER).	
XXXII-XXXIV.	Metaxya and other Ferns (BOWER).	
XXXV.	Sebaea (HILL).	
XXXVI.	Parnassia (AGNES ARBER).	
XXXVII, XXXVIII.	Riccia Frostii (BLACK).	
XXXIX, XL.	Jurassic Coniferous Woods (RUTH HOLDEN).	
XLI.	Bracts in Welwitschia (TAKEDA).	
XLII, XLIII.	Lachnea cretea (FRASER).	
XLIV-XLVI.	Tetraclinis articulata (SAXTON).	
XLVII, XLVIII.	Utricularia (GLÜCK).	
XLIX, L.	Defoliation in Larix (HARPER).	
LI-LIII.	Equisetum arvense (BEER).	
LIV, LV.	Preissia commutata (GRAHAM).	
LVI.	Tetraspora lubrica (MCALLISTER).	
LVII, LVIII.	Centrifugal Force (HILEY).	
LIX.	Cephaleuros (N. THOMAS).	
		PAGE
6. FIGURES. 1-15.	Araucaria Bidwillii (EAMES)	25
16-23.	Araucaria Cunninghamii (EAMES)	27
24-31.	Araucaria Cookii (EAMES)	27
32-38.	Araucaria brasiliana (EAMES)	27
39-45.	Athrotaxis cupressoides (EAMES)	28
46-52.	Athrotaxis laxifolia (EAMES)	28
53-59.	Athrotaxis selaginoides (EAMES)	28
60-66.	Cunninghamia sinensis (EAMES)	30
67-74.	Agathis australis (EAMES)	30
75-78.	The abietinean type (EAMES)	30
79-81.	Sequoia sempervirens (EAMES)	30
82.	Athrotaxis cupressoides (EAMES)	32
83.	Athrotaxis laxifolia (EAMES)	32
84.	Athrotaxis selaginoides (EAMES)	32
85.	Cunninghamia sinensis (EAMES)	32
86.	Agathis australis (EAMES)	32
87-92.	Agathis vitiensis (EAMES)	32
	Diagram 1. Podocarpus Totara (SINNOTT)	43
	Diagram 2. Podocarpus spicatus (SINNOTT)	44
	Diagram 3. Podocarpus ferrugineus (SINNOTT)	46
	Diagram 4. Podocarpus dacrydioides (SINNOTT)	47
	Diagram 5. Dacrydium Bidwillii (SINNOTT)	48
	Diagram 6. Dacrydium cupressinum (SINNOTT)	49
	Diagram 7. Phyllocladus glaucus and Cephalotaxus (SINNOTT)	51
	Diagram 8. Vascular structure in certain Conifers (SINNOTT)	67
	Diagram 9. Illustrating the phylogeny of the Podocarpaceae (SINNOTT)	74
I.	Diagram of Apparatus for testing Electrical Response in Cotton Plants (BALLS)	104
1.	Botrychium Lunaria (LANG)	206
2.	" " " "	206
3.	" " " "	208
4.	" " " "	209
5.	" " " "	210
6.	" " " "	211
7.	" " " "	212
8.	" " " "	214
9.	" " " "	215
10.	" " " "	228
11.	" " " "	229
12.	" " " "	231

FIGURES.		PAGE
13.	Botrychium Lunaria (LANG)	232
14.	" " " "	233
	Curve illustrating facts relating to the structure of seedlings (HILL and DE FRAINE)	267
	Diagram 1. Coreopsis tinctoria (HILL and DE FRAINE)	270
	Diagram 2. Dahlia Merckii (HILL and DE FRAINE)	270
I.	The structure of seedlings (HILL and DE FRAINE)	270
I.	Apparatus for the cutting of models reconstructed from sections (SALISBURY)	277
I.	A, Lepidodendron selaginoides; B, Lepidodendron sp. (KISCH)	288
2.	A, Lepidodendron sp. (selaginoides?); B, Bothrodendron mundum (KISCH)	289
3.	Lepidodendron intermedium (KISCH)	290
4.	Lepidodendron selaginoides (KISCH)	290
5.	A, Lepidodendron sp.; B, Lepidodendron Hickii; C, Lepidodendron sp.; D, Bothrodendron mundum (KISCH)	291
6.	Lepidodendron selaginoides (KISCH)	292
7.	A, Lepidodendron selaginoides; B, Sigillaria sp. (KISCH)	292
8.	A, Lepidophloios sp.; B, Lepidodendron fuliginosum; C, Sigillaria elegans (KISCH)	294
9.	Stigmaria, types 1 and 2 (KISCH)	295
10.	A, Lepidodendron Hickii; B, Sigillaria scutellata; C, Lepidodendron selaginoides (KISCH)	298
11.	Stigmaria (KISCH)	299
12.	Lepidodendron selaginoides (KISCH)	300
13.	A, Lepidophloios sp.; B, Lepidodendron selaginoides (KISCH)	301
14.	Types of the contents of periderm cells (KISCH)	302
15.	Intercellular spaces in the periderm (KISCH)	303
16.	Lepidophloios sp. (KISCH)	304
17.	Sigillaria sp. (KISCH)	305
18.	Sigillaria spinulosa (KISCH)	305
19.	" " "	306
20.	Stigmaria sp. (KISCH)	307
21.	" " "	308
22.	Lepidodendron brevifolium (KISCH)	308
23.	Lepidodendron selaginoides (KISCH)	310
24.	Lepidodendron Wunschianum (KISCH)	311
25.	Stigmaria sp. (KISCH)	313
26, 27.	Lepidodendron fuliginosum (KISCH)	316
I.	Actinostrobus pyramidalis, Miq. (SAXTON)	323
2.	" " " "	325
3.	" " " "	338
I, 2.	Welwitschia mirabilis (TAKEDA)	350
3.	" " " "	351
4, 5.	" " " "	352
I-7.	Gnetum Gnemon (TAKEDA)	365
8-10.	" " " "	366
I.	Spirogyra adnata (?) (DELFT)	367
2.	" " " "	368
a-c.	Tradescantia pulchella (HOLDEN)	369
I.	Diagram of apparatus used to investigate the effects of organic vapours on plants (BAKER)	414
2.	Automatic Waterer (BAKER)	415
3.	Diffusion Bulb (BAKER)	418
4.	Diagram of apparatus used to estimate the quantitative effect of formaldehyde on plants in the dark (BAKER)	427

FIGURES.		PAGE
	A. <i>Thyrsopteris elegans</i> (BOWER) . . . . .	456
	B. <i>Neocheiropteris palmatopedata</i> , (Bak.) Christ (BOWER) . . . . .	474
	1. <i>Sebaea</i> (HILL) . . . . .	483
	2. <i>Sebaea aurea</i> (HILL) . . . . .	486
	1. <i>Parnassia palustris</i> , L. (AGNES ARBER) . . . . .	493
	2. A-C, <i>Parnassia fimbriata</i> , Banks; D-F, <i>Parnassia palustris</i> , L. (AGNES ARBER) . . . . .	496
	3. <i>Parnassia palustris</i> (AGNES ARBER) . . . . .	504
	4. A, <i>Hypericum</i> sp. (? <i>olympicum</i> ); B-F, <i>Hypericum elodes</i> , Huds. (AGNES ARBER) . . . . .	506
	1. <i>Welwitschia mirabilis</i> (TAKEDA) . . . . .	549
	2. " " " . . . . .	550
	1. Apparatus of Bonnier and Mangin for the Analysis of Air (THODAY) . . . . .	567
	2. Reagent tubes (THODAY) . . . . .	571
I, 2.	<i>Larix europaea</i> , DC. (BARTLETT) . . . . .	575
	1. <i>Tetraclinis</i> (SAXTON) . . . . .	586
2-4.	" " " . . . . .	591
5.	" " " . . . . .	596
6-8.	" " " . . . . .	597
9.	Part of a map of the world, showing the distribution and suggested phylogeny of the Callitroideae and of certain Cupressoideae (SAXTON) . . . . .	599
	1. <i>Utricularia ochroleuca</i> (GLÜCK) . . . . .	610
	2. <i>Utricularia intermedia</i> (GLÜCK) . . . . .	611
	3. <i>Utricularia minor</i> forma <i>platyloba</i> (GLÜCK) . . . . .	614
I, 2.	Diagrammatic representations of the last year's growth of the two uppermost sections of the same tree (HARPER) . . . . .	633
	1. Plan and sectional elevation of leaf chamber (THODAY) . . . . .	699
	2. Rates of absorption of oxygen and evolution of CO <sub>2</sub> per hour per leaf. Experiment I (THODAY) . . . . .	700
	3. Rates of absorption of oxygen and evolution of CO <sub>2</sub> per hour per leaf. Experiment II (THODAY) . . . . .	701
	4. Rates of absorption of oxygen and evolution of CO <sub>2</sub> per hour per leaf. Experiment III (THODAY) . . . . .	702
	5. Rates of absorption of oxygen and evolution of CO <sub>2</sub> per hour per leaf. Experiment IV (THODAY) . . . . .	703
	6. Rates of absorption of oxygen and evolution of CO <sub>2</sub> per hour per leaf. Experiment V (THODAY) . . . . .	704
	7. Rates of absorption of oxygen and evolution of CO <sub>2</sub> per hour per leaf. Experiment VI (THODAY) . . . . .	705
	8. Rates of absorption of oxygen and evolution of CO <sub>2</sub> per hour per leaf. Experiment VII (THODAY) . . . . .	706
	9. Rates of absorption of oxygen and evolution of CO <sub>2</sub> per hour per leaf. Experiment VIII (THODAY) . . . . .	707
	10. Rates of absorption of oxygen and evolution of CO <sub>2</sub> per hour per leaf. Experiment IX (THODAY) . . . . .	707
	11. Rates of absorption of oxygen and evolution of CO <sub>2</sub> per hour per leaf. Experiment X (THODAY) . . . . .	708
	12. Curves showing total O <sub>2</sub> absorbed and CO <sub>2</sub> produced after chloroform by leaves of <i>Helianthus tuberosus</i> in c.c. per gramme of fresh weight. Experiment XI (THODAY) . . . . .	710
	13. Rates of absorption of oxygen and evolution of CO <sub>2</sub> per hour per leaf. Experiment XII (THODAY) . . . . .	711
	14. Rates of absorption of oxygen and evolution of CO <sub>2</sub> per hour per leaf. Experiment XIII (THODAY) . . . . .	712
	15. Rates of absorption of oxygen and evolution of CO <sub>2</sub> per hour per leaf. Experiment XIV (THODAY) . . . . .	712

	PAGE
FIGURES. 1. The Intermittent Centrifuge (HILEY) . . . . .	725
2. " " " " . . . . .	727
3. " " " " . . . . .	728
1. Diagrammatic representation of the complete apparatus for determination of diurnal variation of excitability (BOSE) . . . . .	760
2. The Oscillating Recorder (BOSE) . . . . .	763
3. The Oscillator (BOSE) . . . . .	764
4. Effect of cloud (BOSE) . . . . .	766
5. Effect of sudden darkness (BOSE) . . . . .	766
6. Effect of change from darkness to light (BOSE) . . . . .	767
7. Effect of enhanced turgor, artificially induced (BOSE) . . . . .	767
8. Effect of moderate cooling (BOSE) . . . . .	768
9. Effect of application of more intense cold (BOSE) . . . . .	769
10. Effect of temperature above optimum (BOSE) . . . . .	770
11. Record for twenty-four hours exhibiting diurnal variation of excitability (BOSE) . . . . .	771
12. Midday record from noon to 3 p.m. exhibiting uniform excitability (BOSE) . . . . .	772
13. Evening record from 6 to 10 p.m., showing gradual depression of excitability (BOSE) . . . . .	773
14. Morning record from 8 to 12 noon, exhibiting gradual enhancement of excitability (BOSE) . . . . .	773
15. Record of diurnal variation of excitability (BOSE) . . . . .	774
16. Curves showing relations between the hour of the day and (1) temperature, (2) excitability (BOSE) . . . . .	776
17. Diurnal variation of excitability exhibited by summer specimen (BOSE) . . . . .	777
1, 2. Swainsona Cadelli (COMPTON) . . . . .	797
3-11. Helianthus annuus syncotyleus (COMPTON) . . . . .	797
12-19. " " " " . . . . .	807
20-24. Cannabis sativa (COMPTON) . . . . .	807
25-35. " " " " . . . . .	815
36. Lepidium sativum (COMPTON) . . . . .	815
37-39. Lotus corniculatus, hemitricotyl (COMPTON) . . . . .	815
40, 41. Helichrysum bracteatum (COMPTON) . . . . .	815



Vol. XXVII. No. CV. January, 1913. Price 14s.

# ANNALS OF BOTANY

EDITED BY

DUKINFIELD HENRY SCOTT, M.A., LL.D., D.Sc., F.R.S.

LATELY HONORARY KEEPER OF THE JODRELL LABORATORY, ROYAL BOTANIC GARDENS, KEW

JOHN BRETLAND FARMER, D.Sc., M.A., F.R.S.

PROFESSOR OF BOTANY, ROYAL COLLEGE OF SCIENCE, LONDON

FRANCIS WALL OLIVER, M.A., D.Sc., F.R.S.

QUAIN PROFESSOR OF BOTANY, UNIVERSITY COLLEGE, LONDON

AND

ROLAND THAXTER, M.A., Ph.D.

PROFESSOR OF CRYPTOGRAMIC BOTANY IN HARVARD UNIVERSITY, CAMBRIDGE, MASS., U.S.A.

*ASSISTED BY OTHER BOTANISTS*



LONDON

HENRY FROWDE, OXFORD UNIVERSITY PRESS  
AMEN CORNER, E.C.

EDINBURGH, GLASGOW, NEW YORK, TORONTO, MELBOURNE, AND BOMBAY

1913

## CONTENTS.

	PAGE
EAMES, ARTHUR J.—The Morphology of <i>Agathis australis</i> . With Plates I–IV and ninety-two Figures in the Text . . . . .	I
SINNOTT, EDMUND W.—The Morphology of the Reproductive Structures in the Podocarpaceae. With Plates V–IX and nine Diagrams in the Text . . . . .	39
WEST, G. S., and GRIFFITHS, B. M.—The Lime-Sulphur Bacteria of the Genus <i>Hillhousia</i> . With Plate X . . . . .	83
WOODBURN, WILLIAM L.—Spermatogenesis in <i>Blasia pusilla</i> , L. With Plate XI . . . . .	93
BALLS, W. LAWRENCE.—Apparent Fallacies of Electrical Response in Cotton Plants. With a Diagram in the Text . . . . .	103
BLACKMAN, V. H., and WELSFORD, E. J.—Fertilization in <i>Lilium</i> . With Plate XII . . . . .	111
WALKER, NORMAN.—On Abnormal Cell-fusion in the Archegonium; and on Spermatogenesis in <i>Polytrichum</i> . With Plates XIII and XIV . . . . .	115
ADKINSON, JUNE.—Some Features of the Anatomy of the Vitaceae. With Plate XV . . . . .	133
BRENCHLEY, WINIFRED E.—The Weeds of Arable Land. III . . . . .	141
NOTES.	
COBURN, HILDA.—The Fruiting of <i>Catenella Opuntia</i> . . . . .	167
BROWNE, ISABEL.—Anatomy of the Cone and Fertile Stem of <i>Equisetum</i> . A Correction . . . . .	168
BLACKLEDGE, L. MARGARET.—Variations in the NaCl Content of Non-halophytes . . . . .	168
BAKER, SARAH M.—Note on a New Treatment for Silver-leaf Disease in Fruit Trees . . . . .	172

---

### NOTICE TO SUBSCRIBERS.

The subscription-price of each volume is thirty shillings, payable in advance: the Parts, four in number, are supplied as they appear, post free to subscribers in the United Kingdom, and with a charge of 1s. 6d. per annum for postage to subscribers residing abroad. The price of individual Parts is fixed at a higher rate. Intending subscribers should send their names, with subscription, to HENRY FROWDE, Oxford University Press, Amen Corner, London, E.C.

As the earlier volumes of the *Annals of Botany* are becoming scarce, Vol. I will only be sold as part of a complete set; and Parts will not as a rule be sold separately, after the publication of the volume to which they belong. A few extra copies of particular Parts at present remain on hand, for which special application must be made to the Editors, Clarendon Press, Oxford.

---

### NOTICE TO CONTRIBUTORS.

Contributors in America should address their communications to PROFESSOR THAXTER, Harvard University; and all other contributors to the Editors, at the Clarendon Press, Oxford.

Papers sent in with a view to publication *must be type-written* and *must conclude with a summary of the contents*. The illustrative figures should be planned so as to fill properly a 4to or an 8vo plate. The maximum space available for figures in a 4to plate is  $8\frac{1}{4} \times 11\frac{1}{4}$  inches, in an 8vo plate  $8\frac{1}{4} \times 5\frac{1}{4}$  inches. Attention to this will conduce to the rapid publication of papers if accepted.

Each contributor to the *Annals of Botany* is entitled to receive gratis one hundred separate copies of his paper, and may purchase additional copies if he informs the Editors of his wishes in this respect when he returns corrected proofs. The price of these additional copies will depend upon the amount of text and the number of plates in the paper.

# The Morphology of *Agathis australis*.<sup>1</sup>

BY

ARTHUR J. EAMES,

*Sheldon Travelling Fellow of Harvard University.*

With Plates I-IV and 92 Figures in the Text.

BECAUSE of fame as a timber-tree, *Agathis australis*, (Lamb.) Steud., the Kauri-Pine, has probably become the best-known species of the genus. Endemic in New Zealand, it inhabits the region from the North Cape nearly to 30° South latitude, thus being distinctly sub-tropical as compared with the remaining species, which inhabit the East Indian region. Throughout most of its distribution the Kauri is abundant, forming forests of magnificent trees. In youth its habit is strongly spire-like, much resembling that of many other Conifers; but in full maturity a form is developed which is quite different. The central shaft is lost above. A huge columnar trunk, quite free of branch or knot—a condition secured through the function of a ramular absciss-layer—bears a crown of stout, broad-spreading branches. When still quite young the trees begin to bear ovuliferous cones, and when full-grown fruit freely. Opportunity for the collection of material for an investigation of the life-history of this araucarian genus was afforded the writer while collecting and studying in Australasia as a Sheldon Travelling Fellow of Harvard University.

The structure of the gametophytes and the embryo of the Araucarineae has been almost unknown thus far, chiefly because of the inaccessibility of the group; and a knowledge of the morphological and cytological details of the development of these structures is greatly to be desired, inasmuch as it is now clear that the Araucarians form a group somewhat apart from other Conifers. Their phylogenetic position, therefore, is one of unusual interest, and, further, is at present very much in discussion. Hence it is hoped that such details of structure and development of the sexual generation and of the early stages in sporophyte formation as are brought out by this investigation may aid in the solution of relationships among the Conifers.

Collections of the strobili of the Kauri were made at Puru Creek and at Puriri, near Thames, N.Z., and in the Waitakere Hills, near Auckland,

<sup>1</sup> Contributions from the Phanerogamic Laboratories of Harvard University, No. 52.

[Annals of Botany, Vol. XXVII. No. CV. January, 1913.]

N.Z., in late October and in November, 1910, and again, at the last station, in February, 1911.

The individuals from which material was taken were strictly monoecious, bearing freely cones of both sexes (Pl. I, Fig. 1), whereas the genus as a whole is dioecious. The male cones are cylindrical, three to six centimetres long, and about one centimetre in diameter. They are borne solitary, erect, and slightly peduncled in the axils of normal leaves. The microsporophylls, spirally arranged, bear eight to twelve sporangia attached to the lower side of the peltate tip, projecting adaxially. The pollen is shed from late September to the middle or last of October. The earliest date available for collection was October 28, and the pollen was then found to have been nearly all shed. The only material obtained was from an individual retarded in development. In this only ungerminated microspores were found. Hence a study of the early history of the male gametophyte could not be made. However, Jeffrey and Chrysler (4) have described its early development in this species, and Thomson (14 and 15) has published some notes on the germination of the pollen and the behaviour of the nuclei at this time. Two prothallial cells are cut off as in many Gymnosperms. These cells not only persist, but divide further to form a complex of several cells within the pollen-grain. Evidently a considerable proliferation of this tissue occurs, followed by the freeing of its many nuclei, since Thomson reports as many as forty nuclei within the young pollen-tube. Similarly, a large number of supernumerary nuclei form in the pollen of *Araucaria*, as Lopriore (8) has shown for *A. Bidwillii*. The method of pollination in these genera is unique among Gymnosperms. Germination occurs upon the ligule in *Araucaria*, and on the surface of the cone scale nearer the ovule in *Agathis*. Thence the pollen-tubes pass towards the micropyle. Thomson, who made this discovery, has designated such a method of fertilization as 'protosiphonogamic'. In the placing of the pollen the Araucarineae thus differ from all other Conifers where the grains are conveyed to the micropyle; and their proliferation of male prothallial tissue is paralleled only in the Podocarpaceae.

In the study of his material the writer has not seen pollen-grains germinating upon the scale. They are found chiefly deep in the axil of the scale. Often the grains have become embedded in the cortical tissue of the cone axis, or of the nucellus by the growth of the latter against the former. In this position the tubes are sent out as described below.

The female cones terminate short stout branches. In October three stages are found: very young cones, about 1 cm. in diameter, just breaking from bud-scales; small, obovoid cones, about 2 cm. in diameter, with loose scales,—the flowering stage; and large, almost spherical cones, from 4 to 6 cm. in diameter. Fertilization occurs in the last mentioned from the end of October to the middle of November, and the seeds are

mature and fall about the first of the following March. Thus here, as in many other Conifers, a long period intervenes between the appearance of the ovulate strobilus and the ripening of the seed. A year is required to develop the cone from its appearance to pollination; about thirteen months pass between pollination and fertilization; and four more are taken to complete the growth. The history of the male cone is, as with other Conifers, apparently much shorter, less than a year, since no evidence of young strobili is found at this time.

The female cone is made up of close spirals of scales, each bearing a single median ovule. These scales are broad, thin-winged proximally, with stout, short, up-turned tip. They have the simple appearance well known in the genus *Agathis*, and there is no external evidence of a double nature such as appears in most Conifers.

In strobili just appearing from the bud ovular growth has not yet begun. The ovule is first recognizable, according to Dickson (1), who investigated young cones from greenhouse plants as early as 1863, as a small swelling at the base of the scale. At pollination well-marked projections of the general form of ovules are developed. But at this time there is no differentiation either of integument or of archesporial tissue. This condition is in contrast to that commonly found in Gymnosperms where there is at least sufficient differentiation to form a micropyle to receive the pollen. And this suggests a cause for the germination of the pollen at other points. Progress in development must be rapid from this time on, since in February the integument is set off, and the embryo-sac has enlarged considerably. Fig. 5 presents this stage. The nucellus is well formed. Embedded in 'spongy tissue' in its centre lies the embryo-sac, still in the free nuclear stage, the nuclei arranged in the customary parietal layer. The nucellus is free from the integument, and each is bounded by an epidermis-like layer of cells.

Ovules just previous to fertilization were the next stage available. At this time they resemble somewhat in form and size the ripe seed. The character of the micropyle varies much, especially among ovules from different cones. The surface of the nucellus is exposed above and below by large V-shaped openings in the integument, the ventral being considerably the larger in most cases. Huge micropyles were found occasionally where the opening reached down half the extent of the embryo-sac. This condition is probably correlated in some way with the peculiar basal margins of the cone scale, where auricles leave small sinuses in the wing. One of these openings lies directly over the ovule of the scale below. This arrangement may be concerned with the peculiar germination of the pollen-grain.

The nucellus is clearly set off from the surrounding tissue. The separation extends far down, always to the base of the gametophyte, and

often so far below as to create a stipitate appearance (Figs. 2 and 3). It is bounded externally by the above-mentioned layer of larger cells with mucilaginous, deeply staining contents. Inwardly is found the megaspore membrane. Adjacent to the latter the innermost layers of cells show signs of disintegration, and bounding these inwardly are frequently the remains of cells absorbed in the development of the gametophyte. The tip of the nucellus is at times enlarged, though not greatly, the swelling, perhaps in many cases, being limited by the proximity of the micropyle to the cone axis, against which the nucellar tissue is frequently firmly pressed. In ovules of the age of the vacuolated embryo-sac the nucellar cells largely contain starch. This disappears irregularly, for at the time of fertilization the upper portions of some nucelli contain much starch, though many have none. The presence of this seems to have no effect upon the behaviour of the pollen-tube as it passes through.

Thomson (16), in a comparative study of the megaspore membrane in the Gymnosperms, has shown that the latter in the Araucarians is very poorly differentiated structurally. With this statement the writer agrees so far as *Agathis australis* is concerned. In most Conifers this coat becomes thin, or is quite lacking at the apex of the gametophyte. Thus the pollen-tube is given free access to the archegonia, which are in most cases apical. But in *A. australis* almost reverse conditions prevail: the membrane is not thin or lacking below the micropyle, but, on the contrary, its thickness is usually increased there to a considerable extent. The regions where the membrane is thin or absent lie lower down on the gametophyte. Thus a marked cap is formed over the apex of the archegoniate prothallium. Fig. 7 shows this thickened terminal portion of the megaspore membrane, and suggests also to some extent its function. The tip of the gametophyte is shown in longitudinal section with the nucellus, much eroded, surrounding it. Portions of the integument are seen on the sides. The very dark line externally bounding the nucellus is the epidermis-like layer above mentioned. The nucellar tissue is almost entirely destroyed by the pollen-tubes, some of the contents of which may be seen on the right. The dark irregular lines at the internal boundary of the nucellus are the remains of its destroyed cells and pollen-tube walls. Lying against these on the inside is a homogeneous layer, the megaspore membrane. It is thick above, and thins away rapidly in the lower part of the photograph. Its cap-like nature is evident. The pollen-tubes have been prevented by its presence from destroying the upper portion of the gametophyte. Contrast this condition with that in Fig. 9, where the pollen-tubes have broken through, as they do at times. Much of the upper section of the gametophyte has been eroded. This protective function will be seen below to have a definite relation to the position and order of development of the archegonia, as well as to the nature of the pollen-tube.

The formation and germination of the megaspore were not seen, nor was material available to determine the method of wall formation within the embryo-sac. The definite arrangement of the cells, especially at the micropylar end, points clearly to a centripetal growth not different from that of other Conifers. The mature gametophyte is distinctly club-shaped, the upper larger portion bearing the archegonia (Fig. 2). The cells of this latter portion are elongated radially and arranged rather symmetrically, strongly suggesting the huge elongated cells, the 'alveoli', of endosperm formation. In the basal portion there is much less regularity, and the cells are smaller. At this stage, just before the maturity of the egg, the cells of the gametophyte are not rich in cytoplasm, though they are multinucleate, especially those of the central portion.

The archegonia are numerous and arranged irregularly, many of them being deep-seated. They occur only upon the upper third or half of the gametophyte. The number is variable, from three to twenty-five in the ovules studied, eight to fifteen being the commonest numbers. Though in general the method of placing is indefinite, there is often a noticeable tendency to assemble them in three groups: a small terminal cluster, and two uneven encircling crowns at short intervals below. Within these groups no order is distinguishable; in fact, all transitions are found from the solitary archegonium to a sort of archegonial complex. Some difference in age is discernible, indicating an acropetal development. When fertilization is occurring in lower archegonia the ventral canal nucleus may not as yet have been cut off in the apical archegonia. The megaspore-membrane cap protects these young archegonia, which are not ready for fertilization at the time the first male cells come down, shunting the latter off and down to the thinner lower regions of the megaspore membrane, under which are situated the greater number of archegonia and the more mature eggs. Fig. 10 shows the course taken by pollen-tubes, how they have passed by one of the nearest upper archegonia and fertilized those below. The two lower archegonia contain proembryos distinguishable in the figure by their dark hue.

The archegonia vary much in position in the gametophyte; some are very deep-seated, others superficial. The majority are embedded beneath several to many cells. That some of the archegonia are derived from peripheral cells seems apparent, and it is doubtful if any are actually deep-seated in origin. In those of shallow position the neck-cells, as seen in vertical section, lie in the unbroken line of the outermost layer of cells; in the more deeply situated a narrow canal reaches to the surface from the neck, and evidence of overgrowth by the surrounding cells is suggested. Where the canal is completely closed, its former position may often be discerned, so that its existence at one time is probable in all cases. The complete burial of the archegonium is compensated for by the unusually strong erosive capacity of the pollen-tube. Fig. 11 presents a fairly

typical mature archegonium, deep-seated, with a canal from the neck to the surface of the gametophyte. The shape and size vary considerably, dependent upon position and relation to other archegonia. The usual form is that most common in the Coniferae, sub-ovoid, somewhat elongated and unsymmetrical (Pl. I, Figs. 11, 12, and Pl. II, Fig. 14).

The scattered distribution of the archegonia offers various resemblances to the archegonial complex of the Taxodineae and the Cupressineae. The arrangement of the archegonia is almost exactly that of *Sequoia*. Small groups of closely placed archegonia occur frequently; between these no endosperm cells are found, and at times the separating jacket cells are partly lacking also,—a close approach to the perfect complex. An abnormal compacting of egg-cells also occurs frequently. From two to four central cells develop within a normal jacket—the latter may be distorted a little in some cases by the extra cells. These additional egg-cells lie radially above each other; one or two are usually very small, and may resemble a ventral canal cell. In all cases eggs, normal except in size, are formed. The ventral canal nuclei were seen in some cases, but naturally development must occur without the cutting off of a neck-cell initial, except in the outermost. Fertilization was found in one case to have occurred in each of two cells enclosed in an archegonium, though the proembryo formed in the smaller was much distorted.

There are two points in which the archegonium of *Agathis* is in strong contrast with the common condition: a discontinuance of the jacket near the neck-cells, and the peculiar arrangement and permanency of the latter.

The jacket cells are sharply differentiated from those of the gametophyte surrounding them. They are irregular in size and shape, and in rare cases become two tiers deep. A bi- or multinucleate condition is common, particularly in the upper portion, the nuclei being large with often two or more nucleoli. The interruption at the neck is clearly visible in Pl. I, Figs. 11, 12, Pl. II, Fig. 14, and Pl. IV, Fig. 39.

The neck-cells form a rounded, somewhat pyramidal mass, the individuals radiating outward and downward from the top. In number they vary from twelve to twenty, the smaller numbers occurring most frequently. Pl. IV, Fig. 40 shows the group in transverse section. There is but a single tier—compare Figs. 11, 12, 14, 39—though an unsymmetrical arrangement places some cells partly above others. Displacement may thus form a falsely two- or three-tiered neck. This cap of cells becomes firmly bound together, and the walls considerably thickened (Figs. 12, 14, 40, and especially 39). In no case was a passage-way found through them to the egg. They do not, as in many Gymnosperms, serve to attract or nourish the pollen-tube; on the contrary, they resist its entry strongly, and are never destroyed or torn from one another. The pollen-tube is unable to disrupt them and must pass to one side to enter the archegonium. The result of such resis-



tance to the entrance of the pollen-tube is well shown in Fig. 38. This is a transverse section of a neck and the surrounding tissue. The tip of the pollen-tube has eroded the gametophytic cells around the neck completely, leaving the latter entirely unaffected. On this account the neck complex is frequently freed as a whole when the male cells break through, and is thrust aside, in some instances being even carried with the male cytoplasm into the centre of the archegonium.

The central cell in the youngest stage studied presents the condition shown in Fig. 12: cytoplasm thin and strongly vacuolate—as usual in the coniferous archegonium at this time; a small nucleus with little chromatin, and a brilliant nucleolus. The position of the nucleus is upper central, though it is not rarely found towards the base of the cell. An upward migration must occur before the cutting-off of the ventral canal nucleus.

The formation of the latter occurs in the uppermost portion of the cell, and nearly always well to one side, instead of below the neck-cells. Figs. 13 and 14 show the ventral canal nucleus and the young egg nucleus soon after formation. Fig. 13 is a somewhat tangential section of the archegonium and does not show the neck-cells. But there is no question as to the identity of the nuclei presented, as the series reveals the archegonium unruptured, and further, the male nucleus is very different in size and appearance. In two or three cases the mitosis was found to occur centrally, and Fig. 14 shows a rare case of median position of the ventral canal nucleus. In all the many cases where the latter was cut off to one side, that which may be called the abaxial side of the archegonium was chosen—referring of course to the oblique, lateral archegonia. One can see no significance in this fact, however.

Immediately after division the two nuclei are about equal in size—perhaps exactly so—and cannot at first be told apart except in position. The egg nucleus grows rapidly, retreating towards the centre of the cell; the ventral canal nucleus immediately begins to disorganize, disappearing completely in a short time. No evidence of wall formation, or of differentiation in the surrounding cytoplasm suggestive of cell limitation, was seen. So rapid is the disintegration of the canal nucleus that normally it is not to be found when the egg nucleus is half-grown, and no trace exists when maturation is complete. In Figs. 13 and 14 the nucleus is already beginning to disorganize.

Immediately after the central cell nucleus has divided the vacuoles largely disappear from the central portions of the cytoplasm (Figs. 13 and 14). Pl. II, Fig. 19 shows the young egg nucleus and the condition of the cytoplasm at this time, under considerable magnification. The nucleus develops rapidly. The mature egg nucleus is represented in Fig. 20; the nature of the surrounding cytoplasm is also indicated. (The sections of archegonia shown in Figs. 19 and 20 are nearly transverse.) Large vacuoles are found

occasionally in the mature egg, but their occurrence or position is not constant, as is the case in some Abietineae. The ripe egg nucleus may be found in any part of the cell, but its position is normally upper central.

The germination of the pollen was not observed, but the behaviour of the tubes is even more unusual than reported by Thomson (15) in this genus and in *Araucaria*. The latter has described them passing along the cone scale, penetrating its tissue and that of the integuments. In *Agathis australis* the pollen-grain from its position in or near the axil of the scale sends tube-branches in various directions—into the nucellus and also away from the ovule into the cortex of the cone axis and into the basal portions of adjacent scales. The courses of those leading away from the ovule are very peculiar. Their direction is often apparently purposeless: some wander just beneath the epidermis and may pass to the micropyle of adjacent ovules; others push directly inward, reaching the central cylinder of the cone. These in their course often follow the scale traces, running along or into the phloem, and even entering the xylem! All the tissues of the cone may be penetrated; only large resin canals prove obstacles. When a pollen-tube enters one of the latter it promptly retreats and takes a new direction. Penetration of the xylem of the scale trace by the pollen-tube is not constant in *Agathis australis*; some cones show many instances, others none at all. The tube branches which behave in this strange way are usually small, and follow an irregular course—in and out from cortex to fibro-vascular bundle, dying out as tapering tips in either tissue.

Among spiral and scalariform tracheides fragmentation occurs during the passage of the tube. Pitted xylem is probably only entered before lignification is complete. Pl. IV, Fig. 41 shows a cross-section of a scale trace (within the cortex of the cone), the xylem of which has been entered by a pollen-tube. The latter seems to have penetrated while the xylem was in a plastic state, since the tracheides have arranged themselves smoothly about it. The shrunken pollen-tube wall is visible. The tube entered the trace from the side near the base of the cone scale, passed some distance through the phloem, entered the xylem, which it traversed for a few millimetres, and returned to the cortex. Three other tubes are seen in the phloem on the lower side of the figure.

This odd feature was observed in other species of *Agathis* during the study of the anatomy of the cone scale. It was not found in *A. vitiensis*, (Seem.) Benth. and Hook. f., perhaps because the cones examined were almost sterile. But the scale traces and even the axial cone bundles of *A. alba*, Rumph., and of *A. Bidwillii* (specific name as placed on material sent from Botanic Gardens, Buitenzorg, Java) show pollen-tubes traversing them, even more frequently than does *A. australis*, and those of *A. borneensis*, Warb., are very much eroded by them. In the latter species so serious is the attack in some cases that wonder is caused as to how the

bundles continue to function. Fig. 37 is a photograph of a transverse section of an axial bundle from a part-grown cone. Tubes are seen throughout the bundle, the older ones full of a mucilaginous substance and the younger ones appearing white and empty. The tubes reach the central cylinder either through the cortex or along the scale traces. Within the axial bundles they seem to pass chiefly downward and depart only with the traces. They may accompany the branches of the latter well out into the scale.

These tubes of so strong haustorial nature appear in many cases to be the most rapidly growing branches. The time of approach of the male tubes to the embryo-sac is probably very variable. In *A. australis*, Thomson (14) has found tubes beside the very young embryo-sac; the writer's material of this stage did not show them. Many ovules ready for fertilization show tubes just entering, and in others the erosion of the embryo-sac—by a single unbranching tube—has clearly occurred only since the maturity of the latter. Thus apparently the fertile branches of the tubes reach the ovule at widely different times, a fact due either to varying times of departure from the pollen-grain or to greater or less amounts of meandering in sterile tissue. Perhaps at times the first branches enter the nucellus, at others the cone axis.

Tube branches pass from the cone axis and from the base of the adjacent scales to the nucellus, crossing the space that exists between them in those cases where nucellar enlargement is not great. Whether the space at this time is filled with fluid or with air is not known. Thus another Angiosperm-like feature is added to so-called 'protosiphonogamic' fertilization.

The great exposure of nucellus by the large micropyle, and the sinus in the wing of the cone scale directly over the ovule, are probably means of providing readier access to the ovule for the pollen-tubes. The openings in the scales suggest that the fertile tube branches may come from pollen deposited on other scales than that bearing the ovule.

Entering the nucellus a tube may continue to branch and cause much erosion, or its course may be straight down to the gametophyte. After that point is reached, the course is normally downward between the nucellus and the megaspore membrane. This is followed, often without erosion, until the thinner portions of the megaspore membrane are reached. Then these advance tube-tips—the fertile nuclei are not yet within the ovule—erode the tissue about the necks of the archegonia, forming depressions or cavities above them (Pl. I, Fig. 9—the archegonium on the left). Pl. IV, Fig. 38 shows a transverse section of this cavity. After one archegonium has been thus prepared for fertilization, the tube passes on to others.

The male elements follow down the pathway so well prepared beforehand. The latter were not found within the ovule in any case until just

before fertilization, and their downward progress seems to be rapid. The body-cell was found in a few cases. It is large, with much cytoplasm, a huge nucleus, and a thin wall (Pl. II, Fig. 16). It is accompanied by varying amounts of cytoplasm from the tube—being either almost naked or surrounded by several times its volume of dense, coarsely granular cytoplasm. A correspondingly variable number of small nuclei are found connected with it. These contain little chromatin and a prominent nucleolus, thus resembling the stalk and tube nuclei of other Conifers. (Two are seen in advance of a male cell in Fig. 18.) It seems probable from their appearance and behaviour that these represent the stalk and tube nuclei, but since as many as six and eight occur at times, some of them, at least, must be of the great number of supernumerary nuclei, unless the stalk and tube nuclei have shared in the tendency to proliferate.

The division of the body-cell was not seen. It clearly may occur before the descent through the nucellus is finished, perhaps even without the ovule, or so late as the arrival at the archegonium. The male elements thus formed are two large nuclei with close reticulum, surrounded by the dense cytoplasm of the body-cell and of the tube. At first no delimitation is visible within the mass. Later the cytoplasm belonging to each of the nuclei becomes clearly defined, and is finally bounded by a membrane which remains very delicate. The two nuclei are usually elongate and somewhat unequal in size. Fig. 17 shows rather typical nuclei at this stage, the difference in size being exaggerated somewhat by different planes of section. The extent of the cytoplasm connected with each can be faintly made out, though the membrane is not visible in the photograph. A slight amount of tube cytoplasm surrounds them. Ordinarily these two cells do not separate until the entrance to the archegonium is reached, but in Fig. 18 complete separation has occurred. One of the male cells with distinctly limited cytoplasm is seen, preceded by two of the usual accompanying nuclei. The large nucleus is cut tangentially. The other male cell is above and lies outside the plane of section.

Entrance to the archegonium is evidently not secured readily despite the preparation made therefor. This is shown by the heaping-up of the male cytoplasm in a mound of concentric layers over the male cells as they lie against the top of the archegonium; by the disturbance of the cytoplasm of the egg throughout its extent by the entrance; by the breaking away of the resistant neck-cells and their frequent transportation into the egg during the inrush. A considerable amount of male cytoplasm always passes in with the male cell as in all other Conifers, and with it sometimes the other male cell and the small nuclei. In such a case the sterile nuclei remain in the top of the archegonium and rapidly go to pieces there. Rarely the smaller male cell can be distinguished when proembryonic development is complete, and two cases were noted where the extra male nucleus persisted

unchanged until three or four divisions had taken place in the proembryo. More frequently the smaller nuclei are left outside, and the second male cell is entrapped at the entrance, disorganization occurring in these positions. No cases were found of division, mitotic or amitotic, among these nuclei.

That the second male nucleus has potential fertilizing capacity is possible. A remarkable instance of its activity was observed. Both male cells entered an archegonium, the larger effecting fusion with the egg nucleus. The second broke its way laterally through a single layer of jacket cells into an unfertilized archegonium situated just below and beside the first entered egg-cell. Whether fertilization would have occurred is doubtful in view of the somewhat disorganized appearance of the nucleus on its arrival. A possible case of fertilization by both male cells is the above-mentioned instance of the development of proembryos by two eggs enclosed in a single archegonium.

The male nucleus that is to accomplish fusion passes to the egg nucleus, which maintains its station. It takes position beside it, and the two while fusing are slowly and unevenly surrounded by the male cytoplasm. Thus a sort of loose kinoplasmic sheath is formed (Pl. III, Fig. 27). In the Conifers generally this investment of the fusion nucleus by male cytoplasm does not occur, although it is reported in the genera *Torreya*, *Taxodium*, and *Fumiparus*. No preparations were secured showing clearly the male and female nuclei in process of fusion, but Figs. 25 and 26 show the condition just previous to this. The nuclei lie side by side; the plane of section, however, is such that both cannot well be seen at once. Fig. 26 displays a median section of the male nucleus; the dense nature of its contents is noticeable. The egg nucleus lies just below and to the left, as Fig. 26, a photograph of a section just below, discloses. Here a portion of the egg nucleus appears, somewhat flattened by the approach of the male, a small tangential section of which is discernible to the right. Sections still farther on show the remainder of the egg nucleus.

The remarkably large size of the male nucleus is probably the most noteworthy feature of fertilization. Because of a frequently elliptical outline its actual size is difficult to judge, but it is approximately that of the egg nucleus, and possibly even surpasses it. Such a state is surely unusual. In the Conifers the male nucleus is in nearly all cases very much smaller than the female. But according to Lawson (5 and 6) in *Cryptomeria* the latter is nearly as large, and in *Sequoia sempervirens*, Endl., 'at the time of their fusion the male and female nuclei are of equal size.' Hence the unusual lack of contrast in size is not without parallel in the group. Further, Seward and Ford (10) show in *Araucaria imbricata* (Fig. 28, E and F) two large nuclei of approximately equal size in the archegonium, and these they consider to be the male and female nuclei.

A sort of pseudo-fertilization occurs to some extent in ovules which

escape pollination. The jacket cells break down in part. Their contents pass into the cytoplasm of the egg as angular, dense fragments. These fuse more or less and migrate towards the egg nucleus. In this condition they form densely granular, reticulate masses, often with narrow clear zones surrounding them. In some cases these bodies were seen deeply indenting the nuclear membrane, as in Pl. II, Fig. 15. It seems doubtful if actual fusion occurs, as in the cases where penetration is noticed the egg nucleus is beginning to disorganize. Probably no significance can be attached to this phenomenon, although a suggestion is perhaps given of parthenogenesis, or of double fertilization. This condition is found only in archegonia that have not been approached by male cells, and no evidence appeared of the migration of nuclei, or of large portions of the contents of the jacket cells under normal conditions.

As shown in Pl. III, Fig. 27 the fusion nucleus has a marked nuclear membrane, and is loosely invested by a prominent sheath of kinoplasm. It maintains its position near the centre of the archegonium, and there gives rise rapidly to a large proembryo. This behaviour in the early history of proembryonic development is in great contrast to the conditions in other groups of Conifers where the fusion nucleus or its division products, two, four, or eight nuclei, sink to the bottom of the archegonium, and there continue the growth of the proembryo.

The spindle of the first division is small and intranuclear, as Pl. II, Fig. 21 shows. The two daughter nuclei (Fig. 22) are of good size. They are still free from the kinoplasmic sheath. But with the division into four the kinoplasm is invaded, and the nuclei become distributed throughout a uniform mass of dense cytoplasm. Pl. III, Fig. 29 exhibits this spherical mass with its nuclei (two only of the four visible) suspended near the centre of the archegonium. Another rapid simultaneous division forms eight nuclei of good size. These are distributed uniformly throughout the proembryo—compare Fig. 30, four nuclei showing. In the continuation of the free nuclear division the mitoses resulting in the formation of sixteen and thirty-two nuclei do not occur so rapidly, and are not always simultaneous within the group—some divisions being quite complete when others are only beginning.

After the fifth consecutive division in the proembryo free nuclear mitosis frequently ceases, and wall-formation soon occurs; but a sixth complete division of this sort was found in a few cases, and an irregular increase in nuclei may take place at this time. Thus the proembryo in its final stage before wall-formation may possess anywhere from thirty-two to sixty-four nuclei, thirty-two being most common. Fig. 36 represents the sixteen-, and Fig. 23 the thirty-two-nuclear stage. The nuclei are large, rounded, and frequently binucleolate. At this time they are evenly distributed throughout the entire mass, those parietally situated often causing

tubercle-like swellings on the surface, and even projecting almost free from the cytoplasm. A period of rest from mitosis then intervenes, during which a rearrangement of the nuclei and cytoplasm ensues. Even while the last divisions are occurring some beginning of this is made. A thin layer of cytoplasm—definitely distinguishable from that of the globose mass—forms over the upper portion of the proembryo. Whether this is secured from the cytoplasm of the egg, which is being constantly absorbed by the growing sporophyte, or is withdrawn from among the nuclei of the proembryo, could not be ascertained. As the nuclei begin to take definite position this cap increases greatly in thickness, and extends down over the upper half or two-thirds of the rounded mass. A somewhat similar region is set off on the opposite side—but within the original sphere—by a nuclear retreat. These two features are well shown in Fig. 28. A median transverse section of the proembryo at just this stage is shown in Fig. 23. It is evident that the cap of dense cytoplasm extends completely around the upper portion of the proembryo. Meanwhile enlargement occurs; the spherical form is lost, and the mass becomes broadly top-shaped, the cap increasing this appearance. Orientation at this time is by no means constant. The proembryo points usually slightly obliquely or straight downward, but the apex may be turned at right angles to that. The nuclei group themselves in three tiers,—the first evidence of those into which the mature proembryo is so sharply differentiated. In their new position they become somewhat flattened and angular by mutual compression. The nucleoli become two to several. Fig. 24 shows all these features clearly. The three tiers are recognizable: the uppermost, a cap of a single layer of large, radially elongated nuclei; the median, a cluster of a few smaller rounded nuclei; and the apical, another cap of elongated nuclei, smaller than those on the opposite side. The size, shape, and position of the cells soon to be formed are foretold at this time by the nuclei. The upper peripheral nuclei, while maintaining their relative position, push slowly out into the cap of cytoplasm under which they lie, and the latter is finally entirely occupied by them, the line of separation from the section beneath being lost.

The purpose of the cap clearly is to nourish the uppermost layer during its formation of large nuclei. The lesser zone of cytoplasm free of nuclei at the opposite pole, though of different derivation, also serves to build up a tier of nuclei on that side in a very similar manner.

As soon as these processes are complete wall formation occurs. This first becomes evident by lines of demarcation in the cytoplasm, setting off portions about each nucleus (Fig. 24). Then delicate walls appear which become strong only at full maturity of the proembryo.

The median group consists of eight to twelve cubical cells, small but rich in protoplasm, arranged for the most part in two tiers. In these no

further change occurs until the descending embryo attains its final position. It is this rather insignificant portion of the proembryo which forms the embryo proper. The terminal groups are concerned only in the transfer of this central section to the centre of the endosperm. Growth in the embryo proper goes on rapidly after that.

The upper group, which is to form suspensors, elongates distally, reaching out in long tube-like processes through the upper section of the archegonium (Fig. 31), at times even out through the ruptured top.

The lower group becomes more specialized, forming a cap that fits over and protects in a remarkable way the initials of the true embryo above. This cap consists of a terminal, conical cluster of firm-walled, tightly fitted cells elongated backward from the apex, somewhat like the neck-cell complex. The cap form is secured by smoothly 'stepping' the cells one upon the other. A circular rim of cells is placed upon the edge of the cap, extending upward and sheathing the embryonic tier (which is partially sunken in the hollow of the cap) and the base of the suspensors. Fig. 31, a proembryo nearly mature, exhibits all these features. The cap and embryo proper may be better seen in Fig. 32, which illustrates a later stage.

Among Gymnosperms there are two other instances known where the terminal cells of the proembryo do not become embryo proper but form a cap—*Cephalotaxus* (7) and some species of *Podocarpus* (11). But in these genera the cap is very simple—a large terminal cell, and one to several smaller ones placed irregularly between it and the young embryo behind.

When the cap is perfected and distal elongation ceases in the suspensor tier, the proembryo has acquired a shuttlecock-like form (Fig. 31). It has now attained maturity.

There are three distinct tiers, as in the proembryos of other Conifers, but their functions are very different. In this case the central tier is fertile, whereas generally this becomes suspensors. The lower tier, which usually is fertile, becomes a sterile tip, and the suspensors in this case correspond to the rosette tier of many others. The tier of naked nuclei above the rosette layer finds no homologous portion in the araucarian proembryo.

The total number of cells at this stage is found to vary from thirty to seventy. The greatest variation is among the suspensors; a range of eleven to thirty-eight was found, fourteen and twenty-six being most common. From eight to fifteen cells compose the embryo proper. The cells of the protective cap number from ten to twenty.

In that region of the gametophyte into which the descending embryos are to penetrate a marked change takes place at an early stage. This is in the form of preparation to supply greater nourishment for their development, and also for the suspensors during the descent. The cells so situated as to be likely of absorption become richer in content. The change can



usually be detected even before the eggs are mature, and after fertilization it goes on rapidly. One large central area usually suffices for all the archegonia, but where two crowns of eggs are well separated such a region is formed for both. The changes are these: the cytoplasm becomes more dense; the nuclei, of which there may already be several, increase in number, often forming clusters of three to eight. Division is amitotic, the small nuclei becoming elongate and then fragmenting. Great increase in size follows. Then starch grains appear. In the cell contents of the rest of the endosperm no change has occurred at this time.

Elongation of the suspensors forces the embryo and its cap downward, as usual in the Conifers. The course taken is not direct. The path of least resistance—that along the radial rows of endosperm cells—is followed until the central line of the gametophyte is attained. Then the core of suspensors coils, forming a close spiral. This also is a common feature of coniferous embryonic development. It may be due to increased resistance to progress, or to the food-supply stored in this region, the coils of the suspensors becoming absorptive, and causing widespread cell destruction, since behind them in the archegonium they have no supply of nourishment for their growth. Beyond this point the suspensors extend straight down to the final position of the embryo. Fig. 6 shows the complete course followed by the suspensors; the remains of the archegonium—very dark—on the upper right side; the first section of the suspensors, the coils of the central spiral loose in a large eroded cavity, and the straight lower section tipped with the embryo.

The suspensors form a fascicle, cylindrical or somewhat angular, and are generally firmly compacted. Fig. 8 shows transverse sections of the bundle in the spiral region. The firm walls are noticeable. No evidence was seen of any splitting within the bundle such as results in polyembryony in *Cephalotaxus*, *Dacrydium*, *Cryptomeria*, and perhaps other genera. The cap would naturally hinder any budding of this sort from the embryo. Only a single embryo ever develops from the egg. But frequently several archegonia are fertilized, and as a result a number of embryos may start downward. Their suspensor coils snarl together, and that with the strongest bundle is alone able to pass directly down to the central situation. The others lose their courses and pass out laterally or even back upon their track, slowly going to pieces.

The embryonic cap remains wholly unchanged from the time of its maturity until the growth of the suspensors is complete. During its transportation the cells of the true embryo are also dormant, but immediately upon arrival at the end of the course rapid development ensues. The cap and the base of the suspensor core give up their contents, probably being absorbed as nutriment together with the surrounding cells. Fig. 32 shows the tip of the suspensors forcing the cap and the embryonic tier

down through the endosperm. In Figs. 33, 34, and 35 are seen progressive stages in the growth of the embryo and the disappearance of the cap. The latter is spread out and flattened by the enlarging embryo. In Fig. 35 all traces are lost. This figure also represents the latest stage in embryo development obtained. The embryo must be left as a small, somewhat spherical mass in the lower central section of the endosperm.

Soon after embryos begin to pass down into the endosperm the entire upper portion of the ovule inside the integument begins to shrivel, all of the archegonium-bearing section being concerned. This destruction of gametophytic tissue is very extensive, including as it does nearly or quite all of the larger upper section of the mature gametophyte. Fig. 3 shows the beginning of this: all that section above the centre of the suspensor coil gives evidence of disintegration. The lower portion has already increased in diameter, thus reversing the club-like shape of earlier stages, the basal portion being now the larger. The archegonial region in all gymnospermous ovules is destroyed during the development of the embryo, but the destruction is naturally not great owing to the limited distribution of the archegonia. The ripe endosperm of *Agathis* thus consists in large part of the *smaller* portion of the mature gametophyte. Fig. 4 shows a longitudinal section of a ripe seed. Embedded in the endosperm is a distinctly large embryo with two cotyledons. The embryo extends nearly throughout its length. A dry beak of collapsed tissue represents the fertile section of the gametophyte. The shrivelled nucellus is still conspicuous, free from the integument. The endosperm shows no signs of the 'ruminating' outline reported to occur in the Araucarineae. Neither was such a condition found in the large seeds of *Agathis vitiensis*, which were also examined. Erosion by the voracious pollen-tubes in regions which become permanent endosperm would doubtless cause a condition simulating that in the ruminated seeds of the Taxaceae, and it is possible that such is the condition in *Araucaria*.

#### AFFINITIES.

There have been presented above, in the history of the gametophyte and of the embryo of *Agathis*, a number of features sufficiently striking in their contrast to those known to obtain in other Conifers to justify from this standpoint—as well as from that of the anatomy and morphology of the mature sporophyte—the isolated position of the Araucarineae. The important question then arises—what is the phylogenetic relation of this group to the other Conifers? Are these features indicative of a primitive condition, as those already known have led some to believe, or is some other explanation more consistent with the facts? The writer believes that they are certainly not primitive—that though at first glance they may suggest the conditions prevailing in the more primitive Gymnosperms, the

resemblances are superficial, not underlying. These very features bespeak not primitive conditions, but strong specialization. Consider the supernumerary nuclei supplied for the long, branching pollen-tubes; a megaspore membrane cap to protect young archegonia; a pollen-tube tip that prepares access to *several* deep-seated archegonia; the lack of jacket cells at the top of the archegonium to give readier access to the male cells since the neck has become impenetrable; a ventral canal nucleus that is ephemeral, and about which no wall is formed; in proembryo formation five or six consecutive free nuclear divisions in a *restricted* central area,—not *throughout* the egg-cell as in Cycadales and Ginkgoales; a mature proembryo far more complex than any other known; an embryonic cap of remarkably elaborate nature for protection and penetration; and suspensors with a double elongation, the first to secure a holdfast from which to thrust in the opposite direction an embryo suspended freely in the archegonium.

As possibly primitive features in the history of the male gametophyte the large number of microsporangia and the many supernumerary nuclei of the pollen-tube have been cited. As concerns the sporangia, the Abietineae and the Podocarpaceae are the only tribes in which the number is strictly two. The Taxineae and the Araucarineae universally have more. Among the Taxodineae and the Cupressineae several genera, clearly among the more specialized within the groups, have three to several microsporangia; for example, *Sequoia*, *Taxodium*, *Widdringtonia*, *Juniperus*. The two last-mentioned tribes are now generally admitted to be recent and specialized. Mr. Sinnott (11), in a paper contemporaneous with this, shows the primitive character of the Podocarpaceae, emphasizing from a study of their gametophytes and strobilar morphology their abietinean affinities and their close relation to the Taxineae, which he considers a specialized branch from the group. This presents another instance of multiplication of sporangia,—the two of the Podocarps becoming several in their recent branch the Taxads. Further, the microsporangia of the primitive *Ginkgo* are two. Hence the occurrence of microsporangia in greater number than two among the Conifers seems to be a feature of recent specialization, and the Araucarians cannot on that account be considered primitive.

The excessive amount of prothallial tissue of the araucarian pollen-grain has been compared with that found in palaeozoic Gymnosperms. In the pollen of the Cycadofilicales and the Cordaitales a number of internal cells exist. Is this internal tissue vegetative or spermatogenous? We cannot say at present. Coulter and Chamberlain in their recent text-book (p. 178) believe it 'a safe inference' that these cells are in part, if not entirely, spermatogenous. The primitive living Gymnosperms, the Cycads and *Ginkgo*, form but one or two prothallial cells; in the Araucarians and the Podocarps the larger number is the result of proliferation of these. The cells within the palaeozoic pollen-grains are not situated at one pole, nor

does their arrangement suggest an origin from two primary cells—rather that each is itself an original cell of the prothallus. Thus, if the two prothallial cells of most of our Conifers are a reduction from an original complex, wherever a larger number occurs the mode of origin at least seems recent. There would seem to be in the extensive running and branching tubes of *Agathis* a demand for a considerable supply of nuclei. The derivation of these would be most naturally from pre-existing prothallial nuclei. Thus the evidence seems to favour the belief that the tissue in question is cenogenetic and not palingenetic.

Another feature of palaeozoic seeds which it has been suggested the Araucarians have retained is the great freedom of the nucellus from the integuments. This condition has been demonstrated above for *Agathis*. However, no systematic significance can be attached to this character, since Fujii (2) has recently shown it to be very variable even within a genus. Complete freedom of the nucellus exists in scattered genera among the Coniferae—*Callitris*, *Araucaria*, *Cunninghamia*, *Juniperus*.

The large number of archegonia and their scattered positions are suggestive of some lower forms. But the archegonia of the heterosporous Pteridophytes are few and terminal. In the Cycadofilicales and the Cordaitales very little is known of the archegonia, but they were apical (beneath the pollen chamber) and surely not numerous. *Ginkgo* has two or three terminal archegonia. The number in the Cycads, with the exception of *Microcycas*, is ten at the most. Among the Conifers the large numbers are found in the recent tribes—as many as 60 in the Taxodineae and 100 in the Cupressineae. To be sure many of these are found in complexes, but *Agathis* shows how many scattered archegonia may be brought together. And the parallelism with *Sequoia* must be emphasized again. This genus also has many irregularly placed archegonia, and some are deep-seated. Further, in both genera there are the same transitions between a single archegonium and a complex. Thus the few terminal archegonia of the Abietineae seem more likely to be primitive, and specialization to have taken the form of multiplication.

The haustorial nature of the pollen-tubes far exceeds that of any others known. That the cone axis and its bundles, even the xylem, should be invaded is remarkable indeed. A cause for such behaviour cannot now be suggested; far too little is known of the early history of the tubes. But there is the probable reason for the germination of the pollen on the cone scales, that no micropyle is ready to receive it. The seeds of the lower Gymnosperms have given no evidence of pollen-tubes. In the Cycads, though, the haustorial nature of the pollen-tubes is well known. But the section which is concerned with carrying the fertile elements is not at all extensive and can hardly be compared with like portions in *Araucaria* and *Agathis*. If comparisons are to be made of any feature of this so-called

'protosiphonogamic' type of fertilization, the penetration by the pollen-tube of tissues about the ovule and of the integument, with the passage of a space in the attainment of the nucellus, is suggestive of angiospermous conditions and not of primitiveness.

In the Gymnosperms generally the pollen-tube erodes a passage only to one archegonium—except in the case of the complex. In *Agathis* the tube goes from archegonium to archegonium. Is this a more simple condition than the common one?

The neck cells have lost their normal function, that of providing entrance to the egg-cell. They have become instead a serious obstacle to the advance of the male cells. Partial recompense is secured by eliminating the jacket cells contiguous to the neck, leaving normal, somewhat less resistant gametophytic cells. This is not a step in the reduction of the archegonium as a whole, that evolutionary tendency which results in the free egg of the higher Gnetales. Aside from the break at the top the jacket shows no signs of reduction. It is merely a little more complex than that of the Cycadales, *Ginkgo*, and the Abietineae.

In the history of the female gametophyte probably the most prominent evolutionary tendency apparent in the series from the Pteridophytes to the Angiosperms is the reduction of the complex archegonium of the lower forms. The final result is the complete freedom of the egg nucleus. In the lower Gymnosperms the neck canal cells no longer appear. The ventral canal cell is next in line for elimination. This is completely accomplished within the Conifers themselves. The Abietineae form a definite cell; in *Taxus* and *Torreya* even the nucleus has disappeared. In the Araucarineae the condition is that of most Conifers—a ventral canal nucleus is cut off, but no wall is formed. The nucleus itself disintegrates very rapidly. Certainly in this respect the Araucarineae are less primitive than the Abietineae, and on an equal footing with some of the higher Conifers.

The method of fertilization does not suggest resemblances to the lower Gymnosperms any more than to the Conifers as a whole, unless the very large male cell be compared with the sperms of the Cycads. But the ovule of *Agathis* gives no evidence of that ancient feature the pollen-chamber, nor do the male nuclei show signs of motility. A male nucleus of equal size with that of the egg occurs in *Sequoia*, another feature to add to the several in which parallelism has been emphasized.

In the Cycadales and the Ginkgoales the extensive proembryo stands out as a presumably primitive feature. Since the proembryo of the Araucarineae also sometimes fills the egg, Thomson (14) has noted a close resemblance. In all three groups free nuclear division proceeds to a stage well beyond that known in other Gymnosperms, at least eight consecutive divisions taking place in the first two and five or six in the third. But these are of an absolutely different character. In the Cycads and *Ginkgo* the

free nuclei are scattered *throughout the cytoplasm of the egg*, and when wall-formation occurs the entire egg is segmented. In *Agathis* the free nuclear division invades only *a small differentiated portion of the egg*. Further, the cytoplasm of that mass is largely male in origin and not chiefly that of the egg. The only period when the egg-cell is wholly occupied by the proembryo is at the maturity of the latter, and then the filling has been accomplished in a quite different manner—by the growth of cells that originally occupied only a small portion of the archegonium. That the proembryos are distinctly different in character is clear.

In development and structure the proembryo of *Agathis* is unique among Gymnosperms (excepting, of course, the sister genus *Araucaria*, which from the little already known is undoubtedly closely similar). In other Conifers the preliminary proembryonic tissue is few-celled and situated in the base of the egg, where it has been formed from the products of a fusion nucleus which settled to that point. The few cells of this simple proembryo are very likely the reduced form of the similarly situated, more extensive structure of the Cycads and *Ginkgo*. In that only a small portion of the egg is selected for proembryonic development, *Agathis* is different from the lower forms and like its fellow Conifers. But from the time this method of reduction was chosen, the Araucarians have apparently followed a different path from that taken by the others. Effectiveness has been secured in the latter by great simplicity, in the former by great specialization. A position in the bottom of the egg would not make readily available the supply of nourishment in the egg for the elaboration of the terminal cap. Hence possibly the fusion nucleus was retained in the centre of the archegonium. The embryonic cap need not be discussed further; the perfection of its structure speaks for itself.

The suspensor cells of the Cycadales and the Ginkgoales, since derived from entire sections of the egg, form broad massive cylinders; those of the Conifers, excepting the Araucarians, are more slender, but just as simple bundles. The suspensor group of *Agathis* differs from both these in having a double elongation, first in the direction opposite to that in which later expansion is to lead. Strasburger (12) has shown in *Araucaria* even greater specialization. The suspensor cells during their first elongation develop tubercle-like swellings or 'shoulders' which it is suggested aid in anchoring the base of the proembryo.

Can the foregoing facts be considered as indications of a 'non-specialized embryogeny', as Thomson (15) has suggested? All in all the morphology of the gametophyte and of the embryo proclaims for the Araucarineae a great amount of specialization, and strongly emphasizes the isolated position so generally conceded from the morphological and anatomical study of their mature sporophytes. Certainly on this evidence alone no close relation exists between them and the Cycadales and Gink-

goals. They stand off, likewise, sharply from the other Conifers. Yet in essential underlying features they clearly belong to the latter. Starting with some ancient coniferous stock specialization has followed rather different lines in the araucarian branch from that taken in others. Yet many of the same tendencies have prevailed in both, as an attempt has been made to show above by comparing some characters of the recent groups Taxodineae and Cupressineae, especially of the genus *Sequoia*.

If then this tribe, though somewhat apart from other Conifers, yet distinctly goes together with them on the ground of gametophytic morphology and of embryology, what additional evidence of this position does its mature sporophyte afford? In anatomy, perhaps the most critical features pointing to a distinctness of the Araucarians from other Conifers are the lack of xylar resin canals and of bars of Sanio; and in morphology the question of the underlying structure of the megasporophyll is of the greatest importance. Professor Jeffrey is about to announce the discovery of bars of Sanio and of resin canals, as well as of abietineous pitting in the xylem of araucarian cones. Thus the most conservative region of the sporophyte in this tribe proclaims its origin from a stock possessing characters which have been retained by the Abietineae.

The morphology of the ovulate strobilus of the Coniferales has been a much debated subject. It is apparently now clear, however, that the megasporophyll of the Abietineae represents a modified axillary branch, homologous with the 'short shoot', placed in the axil of a bract. The relations of the two structures are very nearly the same as those of their homologues upon vegetative branches. The vascular supply is similar. The bract, as in all Conifers, receives a bundle from the axis with xylem and phloem arranged as in any leaf. The vascular supply to the sporophyll has the position of the xylem and phloem inverted. It arises like that of an axillary structure,—that is, it is formed by the immediate fusion of two strands departing separately from the central cylinder of the cone above the origin of the bract bundle. Text-figs. 75 to 78 are diagrams to show the condition common to the Abietineae, 75 giving the method of origin of the two strands found in 76. Text-fig. 77, at the very base of the scale, shows the bract, slightly fused, and the bundle of the upper series dividing into three; 78 shows the small free bract, and the scale with its strong series, also the ovular supply bundles passing to the two ovules.

Within the Abietineae these two companion structures have undergone very little change, both retaining their identity. The bract is less prominent in some genera, and is slightly fused at its base to the scale (Text-fig. 77). The vascular supplies of the two are quite distinct throughout. Fusion of these two elements, which is only suggested in this tribe, becomes a prominent feature of the Taxodineae and Cupressineae. In their evolution from abietinean stock the double nature of the elements of the ovuliferous cone

has been somewhat obscured by simplification through fusion. Yet such a condition is evident in the presence of the two series of vascular strands—the lower normally oriented, the upper with reversed xylem and phloem—and by the two free apices on the fertile structure. Both ways in which coalescence and reduction can occur have been seized upon. The resulting strobilar element is in one case composed chiefly of the tissue of the fertile scale, the bract having nearly disappeared; and in the other of that of the bract, the scale being barely represented. The former is much more commonly found. *Sequoia* forms a good example. In this genus the scale has enlarged and folded down, enclosing and obscuring the small bract. This is evident externally by the position of the bract tip, which projects like an umbo centrally from the scale, internally by the vascular supply (Text-figs. 79–81). The entire supply arises together as a cylinder. Soon the two series are formed. That for the bract is a small median bundle. The strong inverted series almost surrounding it is that of the fertile scale. Lateral portions of a false lower series are formed by upfolding from the wings of the enlarged scale.

As examples of bracteal enlargement at the expense of the scale, *Cunninghamia* and two species of *Athrotaxis* may be cited. Externally the presence of the seminiferous scale is evinced in *Cunninghamia* only by a collar-like projection from the region of ovular attachment (Text-fig. 85). In *Athrotaxis laxifolia*, Hook., it is represented by a rounded cushion-like mass upon the prominent bract (Text-fig. 83), whereas in *A. selaginoides* all external evidence of a scale has disappeared. That these vestiges must represent the ovuliferous scale of the Abietineae is evident from the undoubted origin of the Taxodineae, from the occurrence within the tribe of all transitional stages, as well as from the evidence of vascular anatomy given below.

Only in the Araucarians and the Podocarps has the double nature of the female strobilar scale been questioned. Some investigators claim that the megasporophylls in these groups are simple in nature, being merely fertile bracts, strictly homologous with the microsporophylls—and therefore not at all of the same nature as those of the Abietineae. If such is the case, both simple and compound strobili occur in the Coniferales. This is a vital point and concerns deeply the unity of a group which otherwise seems to be clearly a natural one.

The writer will try to show that the strobili of the Abietineae and the Araucarineae are homologous—that those appearances suggesting a simpler origin of the fertile scale are due to nearly or quite complete coalescence and great reduction.

Even within themselves the Araucarineae show a complete series from a form with strobilar units of a distinctly double nature to one most simple through reduction. Further, exactly parallel evolution has taken place in the Taxodineae. The apparently simple sporophyll of the Podocarpineae



is also the result of similar fusion, as Mr. Sinnott is clearly demonstrating in the above-mentioned paper—a complete series existing from forms of *Podocarpus* with free bract and scale to the *Agathis*-like cone scales of *Saxegothaea* and of *Microcachrys*. Too little comparative work has been done on the cone scales of the many genera of the Conifers. On looking over the entire field, the conditions obtaining in the different tribes cannot be interpreted otherwise than as indicating the origin of the araucarian condition. Leaving the discussion of the Podocarpaceae to Mr. Sinnott, the Taxodineae give us *Cunninghamia*, with sporophylls closely similar to those of *Agathis*, and *Athrotaxis*, not only with the species *A. selaginoides*, D. Don., having cone scales internally as well as externally the counterpart of those of *Agathis*, but demonstrating in its other species the origin of such a very reduced scale. *A. cupressoides*, D. Don., has dominant scale and weak bract; *A. laxifolia*, Hook., scale and bract of nearly equal prominence.

The genus *Araucaria* itself must be considered in detail. Its cone scales possess a ventral structure, the ligule, in contrast with those of *Agathis*, which have no outgrowths on the apparently very simple scale. By those who consider the araucarian cone scale to be of double origin, the ligule is generally believed to be the remnant of the fertile scale; by others it is supposed to be merely a ventral outgrowth of the sporophyll. This ligule is found in all species of the genus, but in varying degrees of development—from the stout, prominent structure of *A. Bidwillii*, Hook., to the thin, almost indistinguishable projection in *A. brasiliana*, A. Rich. The vascular supply of the cone-scales varies in like proportion. The anatomy of these structures divides the genus into three distinct groups which show stages in reduction from the abietineous type of vascular supply to that of *Agathis*.

*Group I.* The vascular supply originates as two entirely separate strands which, though later brought close together and somewhat interlaced below the huge embedded ovule, maintain their independence. The upper forms an inverted series supplying the ovule and the ligule, and the lower a strong bracteal series.

*Group II.* The vascular supply arises as a single strand, which immediately divides to form two opposed bundles. The upper supplies the ovule and the ligule (whenever the latter has a supply); and the lower, the bract as usual.

*Group III.* The vascular supply arises as in Group II, but does not divide to form two opposed series, its behaviour being exactly that of the lower primary bundle of Groups I and II.

These three groups, as defined by differences of anatomical structure, correspond in part to the systematic subdivisions of the genus. The section Eutacta, so far as its members have been studied, forms Group II, and Groups I and III fall into the section Colymbea. The latter section thus contains the most primitive and the most specialized forms. The geo-

graphical distribution of the species corresponds to the grouping suggested above: Groups I and II are Australasian, Group III South American.

*A. Bidwillii* is the only species, so far as known, that falls within Group I. Text-figs. 1–15 demonstrate the course of the bundles supplying the cone-scale. (Note.—All references to figures below are to text-figures, unless otherwise stated.) Fig. 1, a tangential section of a portion of the xylem of the cone-axis, shows the mode of origin of the two strands. The lower, vertically elongated bundle is that of the bract; above, on either side of the gap in the cylinder caused by the exit of this trace, are the two bundles which by immediate union form the primary strand of the upper series. Worsdell (19) has noted this double origin of the vascular supply, and like the writer considers it strong evidence for the double nature of the araucarian sporophyll. However, he states that both the bundles are of compound origin. With this the writer cannot agree. The method of derivation of the bract and megasporophyll in *A. Bidwillii* is exactly that found in the Abietineae. Compare Figs. 75 and 76. Continuing with *A. Bidwillii*, Figs. 2, 3, and 4 follow these two primary strands in their early course. The upper is at first the stronger, but the lower rapidly surpasses it in size. Figs. 5, 6, 7, and 8 show the divisions that occur while still within the cortex of the cone. Each forms a strong series. After they pass into the free scale, the upper is forced downward in the centre by the embedded ovule (Figs. 9 and 10). A median group of small bundles is definitely set off as ovular supply. Figs. 11–15—on a much reduced scale—show the later course taken by the bundles. Those below the ovule disappear in the chalazal region. The rest of the upper series, portions of which have passed along the sides of the ovule as crowded twisted groups, come together behind the ovule in a horizontal series and pass on into the free ligule as strong bundles. The lower group continues its straight course to the end of the structure. Thus we have a vascular supply clearly abietinean—two series of bundles, arising separately from the axial strands of the cone, and completely free from each other throughout. The upper, of double origin, supplies the ovules and the upper section of the scale; the lower furnishes the stout lower section, differing from that of the ordinary bract only in its great development. Fusion has not affected the vascular tissues in any way, and the megasporophyll, though smaller than the huge bract, is free therefrom to a considerable extent, and its bundles have not been reduced.

To the second group belong *Araucaria excelsa*, R. Br.,<sup>1</sup> *A. Cunninghamii*, Sweet., *A. Rulei*, F. Muell., and *A. Cookii*, R. Br. Among these species the ligule is short and small, with a very weak vascular supply, or none at all. Though in the various species the details of the bundle-course are rather

<sup>1</sup> The anatomy of the cone scale in the cases of *A. excelsa* and *A. brasiliana* is as given by Radais (9), Strasburger (12), and Worsdell (19); in all other cases the writer has made his own studies.

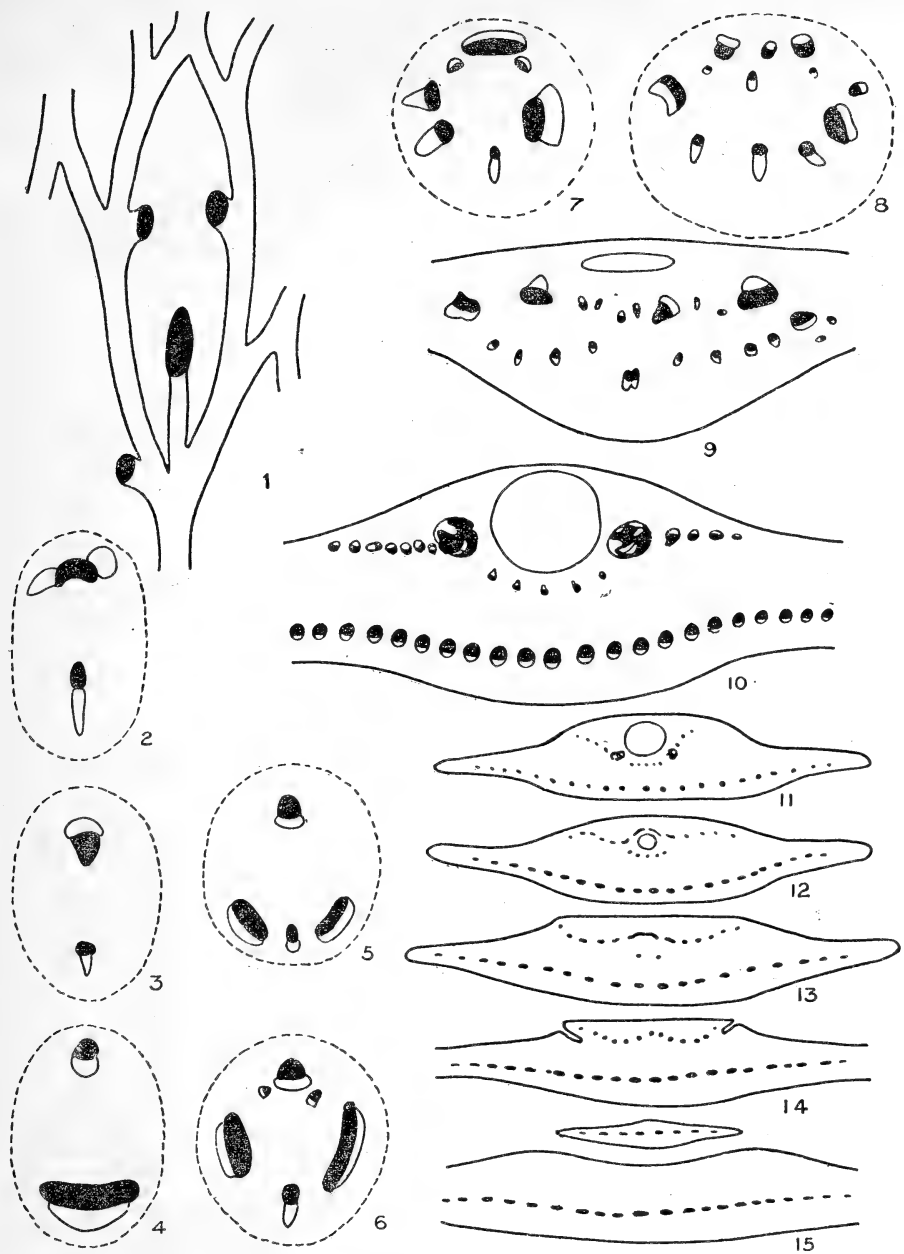

Diagrams illustrating the mode of origin, course, and orientation of vascular supply of the cone scale and ovule. Xylem black, phloem unshaded. (Transverse.) Figs. 1-15, *Araucaria Bidwillii*.

different, the essential features are the same. *A. Cunninghamii* has been chosen to represent the section in the diagrams. Fusion has gone on to such an extent that the vascular system is affected, the two series being brought together in their origin (Fig. 16). Immediately, in part while the

bundle is yet within the cortex of the cone, the two series are formed. The upper is entirely given over to supply the ovule. It consists of a series of four to six bundles, all of which pass beneath the ovule and enter its base. The lateral portions of the series, so prominent in *A. Bidwillii*, which pass on into the scale have entirely disappeared. Beyond the ovule no upper series is visible, and the ligule has no supply. The lower series is normal.

*A. Cookii* from this group is also figured to show features transitional to Group I. An upper series is formed from the single normally oriented bundle, as in *A. Cunninghamii* (Figs. 24–8). As in *A. Bidwillii*, only the central portion of this becomes ovular supply. The lateral portions continue *beyond the ovule* into the distal part of the scale (Fig. 30)—a more primitive state than in *A. Cunninghamii*—but do not reach the ligule as in *A. Bidwillii*. *A. Rulei* closely resembles the former species in this respect: a weak series of upper bundles is formed, some of which tend to be lateral, but all enter the ovule. The inverted series in *A. excelsa*, which consists of a few small bundles, dies out midway beneath the ovule, and the ovular supply is derived entirely from lateral bundles of the lower series.

The third group consists of *A. brasiliiana*, A. Rich., and *A. imbricata*, Pav. Here no upper series at all is formed, and the ovular supply is derived from the lower series very near the base of the ovule, passing directly in. See figures of *A. brasiliiana*, Nos. 32–8. This species represents the greatest reduction in the genus. *A. imbricata* is closely similar. Even external evidence of the ligule has almost disappeared.

Thus the genus *Araucaria* itself presents a type of cone scale—that of Group III—the vascular supply of which is very greatly simplified. And it displays the method and steps of this reduction from a type distinctly abietinean, at least in the origin of its supply.

Further comparisons emphasize the mode of origin of the cone scale of *Agathis*. It has been stated above that the genus *Athrotaxis* displays stages of fusion and reduction of importance in this respect. Figs. 39–59 illustrate this. The longitudinal sections (Figs. 82–4) show the external features and the general plan of the bundle system. *A. cupressoides* (Fig. 82) has a prominent fertile scale which in its expansion has nearly absorbed the bract, the latter projecting as a tiny tongue from the tissue of the former. In *A. laxifolia* (Fig. 83) the two members are about equally developed, the scale resting upon the well-developed bract as a large cushion with rounded end—a very blunt ligule. In the third species, *A. selaginoides* (Fig. 84), all external evidence of a scale has disappeared, the fertile structure having a ventral surface as free of outgrowths as that of *Agathis* or *Saxegothaea*. The change in the bundle systems takes place *pari passu* with that of the external structures. Transverse serial sections demonstrate this. The vascular supply in *A. cupressoides* leaves the stele of the cone as a cylinder (Fig. 39). The latter breaks up immediately on

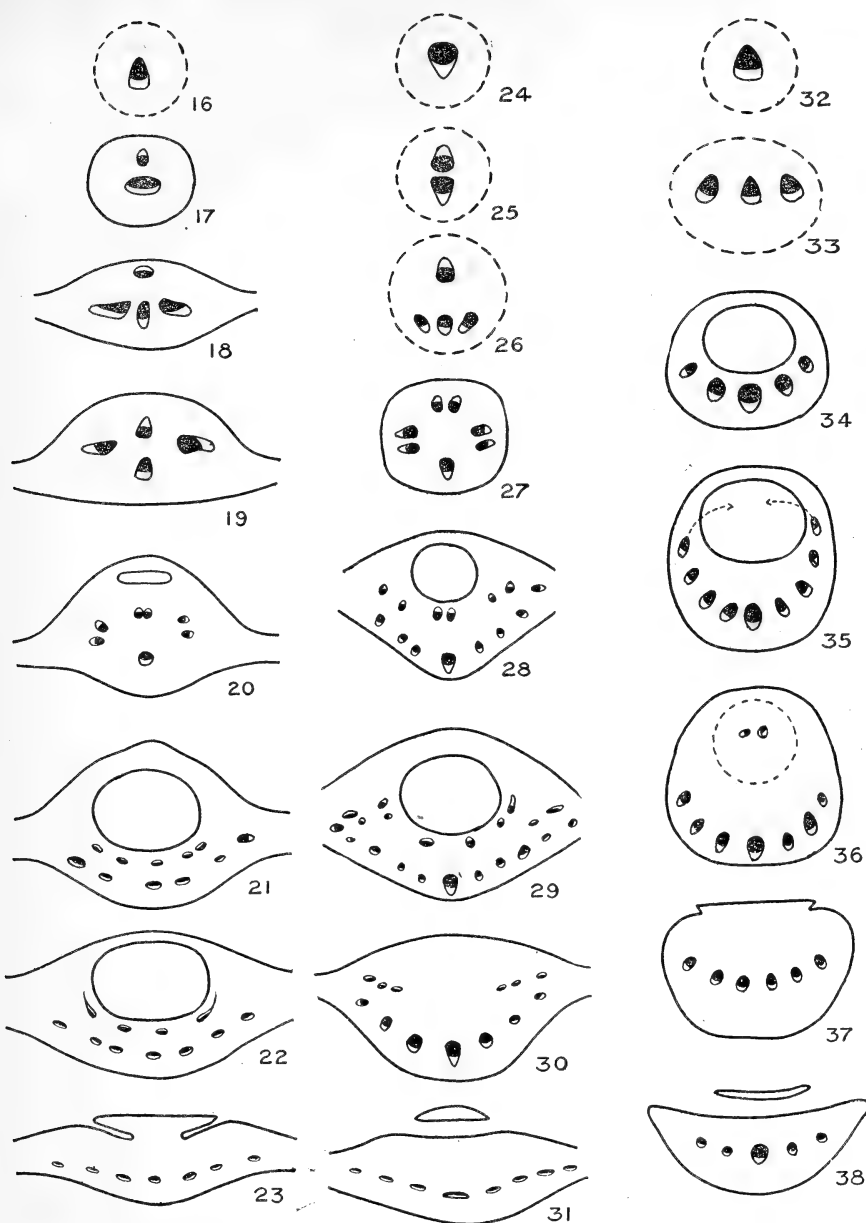

Diagrams illustrating the mode of origin, course, and orientation of the vascular supply of the cone scale and ovule. (Transverse.) Figs. 16-23, *Araucaria Cunninghamii*; Figs. 24-31, *A. Cookii*; Figs. 32-38, *A. brasiliana*.

entering the scale, and the normal opposed series are formed. The lower series is considerably weaker, and is almost surrounded by the upper (Figs. 43-5). This is a case of strong dominance of the scale series. It is to be compared with *Sequoia*, in which the scale is still more prominent, the

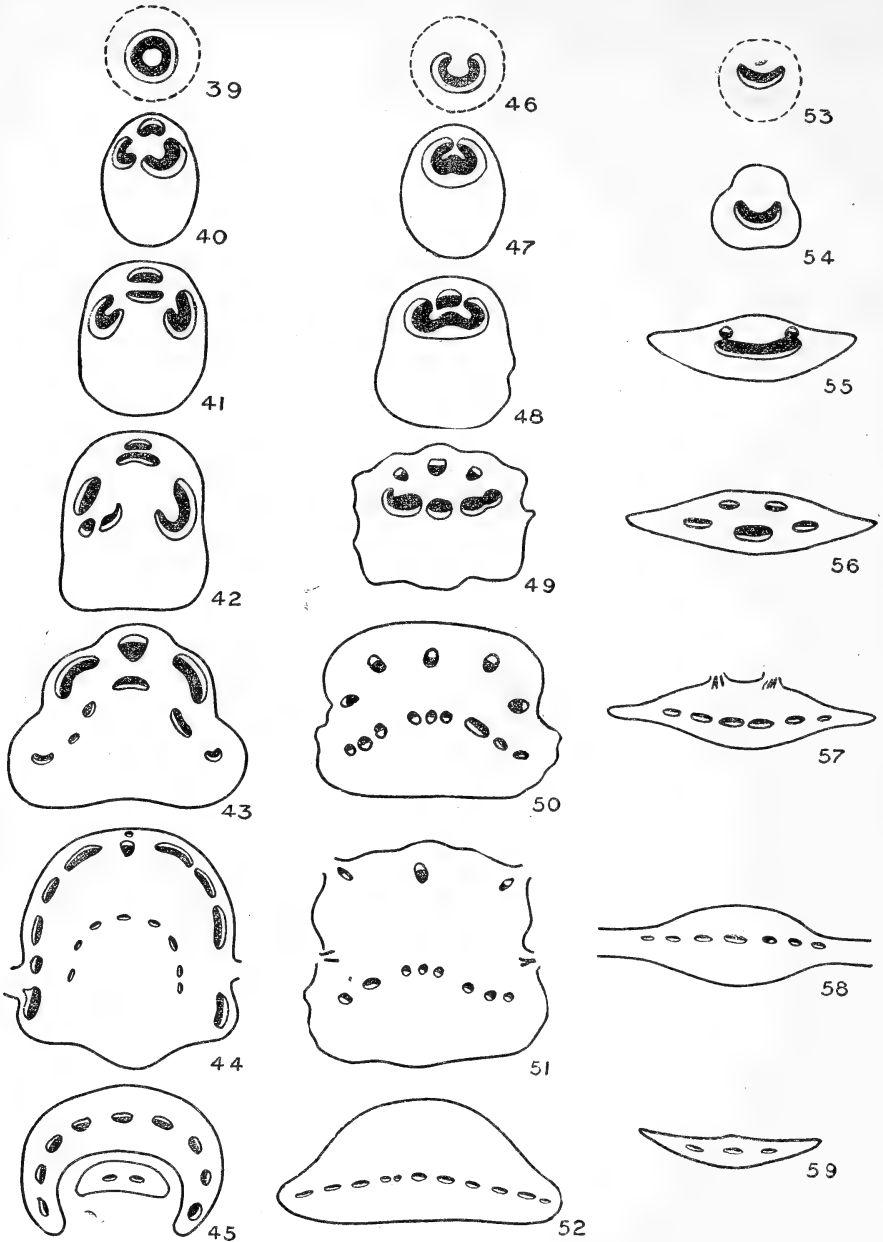

Diagrams illustrating the mode of origin, course, and orientation of the vascular supply of the cone scale and ovules. (Transverse.) Figs. 39-45, *Athrotaxis cupressoides*; Figs. 46-52, *A. laxifolia*; Figs. 53-9, *A. selaginoides*.

bract being represented only by the single median bundle of the lower series (Figs. 79-81).

Passing to the next species, *A. laxifolia*, two series of bundles of about

equal strength are found (Figs. 49 and 50). This means that reduction has occurred in the scale, which is normally far the larger member, and perhaps enlargement in the bract. The bundle originates as a broken cylinder (Fig. 46). The upper series arises from this a short distance out in the scale. Further, the upper series, though well developed, supplies *only the ovules*. Here fusion of the two series has progressed out into the scale, and the upper series has still further disappeared, in that its distal portion is lost—a condition like that found in Group II of *Araucaria*. Compare Figs. 17–23 with Figs. 48–52. Exactly parallel conditions obtain.

A long step towards simplification has been made in *A. selaginoides*. The sporophyll supply arises as a single normally oriented bundle—clearly a remnant of the stronger strand of the other two species. Compare Figs. 39, 46, 53. About one-third the distance out along the scale, a weak upper series of two bundles arises (Figs. 55 and 56). These are ovular supply, and represent the upper series. The lower series continues without change towards the tip.

Another genus of the Taxodineae shows great coalescence and reduction—*Cunninghamia*. Fig. 85, a longitudinal diagram, suggests the extent to which external changes have occurred. A small projection, ligule-like, without vascular supply, situated beyond the attachment of the ovules, is the only vestige of the fertile scale. The bract is much enlarged, with strong bundle system. The upper series, though fairly strong, is ovular supply only. These features are further exemplified in the transverse series diagrams. A single bundle arises from the axis (Fig. 60) as in *Agathis*, *Saxegothaea*, *Athrotaxis selaginoides*, &c. Near the base of the scale this throws off a weak bundle, which inverts itself (Figs. 61 and 62). It immediately divides into three, each of which supplies an ovule (Figs. 63–5). Thus another example is presented of the almost complete dominance of the bract.

The study of these three genera—*Araucaria*, *Athrotaxis*, and *Cunninghamia*, makes intelligible the condition found in *Agathis*. In this genus simplification has reached a very high degree—absolute coalescence of bract and ovuliferous scale, the latter being fused into the former and obliterated. The upper xylem is also extremely reduced, only Group III of the genus *Araucaria* having progressed further in this direction. The former presence of the scale can be detected only by comparisons. Figs. 67–74 and 86 demonstrate the anatomy of the cone scale of *Agathis australis*. A single bundle, normally oriented, leaves the central cylinder of the cone (Fig. 67, and also Pl. IV, Fig. 41), and divides into three (Fig. 68) just before entering the scale base. The median bundle remains undivided throughout its course, though diminishing in size; the lateral bundles divide repeatedly, forming a fan-shaped series of as many as twenty. About half-way out under the ovule the median bundle gives rise to a smaller

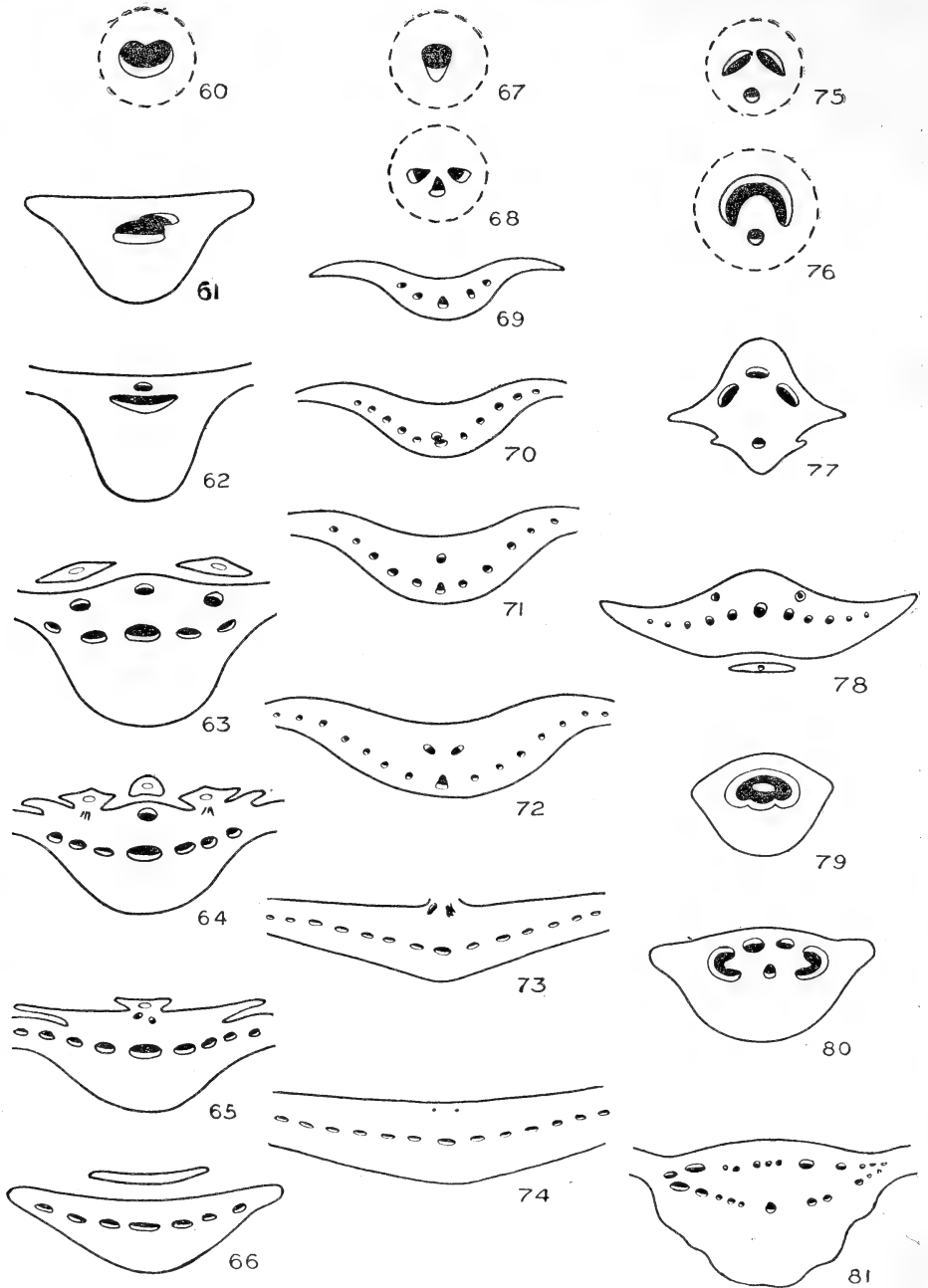

Diagrams illustrating the mode of origin, course, and orientation of the vascular supply of the cone scale and ovules. (Transverse.) Figs. 60-66, *Cunninghamia sinensis*; Figs. 67-74, *Agathis australis*; Figs. 75-8, the abietinean type; Figs. 79-81, *Sequoia sempervirens*.



bundle (Fig. 70), which immediately becomes inversely oriented (Fig. 71). This soon divides into two weak strands (Fig. 72) which pass out into the base of the ovule (Fig. 73). Beyond this point only the strong lower series is found (Fig. 74). This will be seen to be almost exactly the structure of *Cunninghamia*, and of *Athrotaxis selaginoides*. In these two plants, however, there is more than one ovule, a feature which causes a slightly less simple arrangement.

In the study of the cone scale of *Agathis*, several species besides *A. australis* were investigated. These in general display a closely similar anatomy. *A. vitiensis* only is divergent. Its upper series has not entirely disappeared. Figs. 87–92 are diagrams to show the origin and position of all bundles of this series. In its proximal portion the vascular series is essentially the same as that of *A. australis*, and has not been represented. The ovular supply consists of many more bundles than in the Kauri, and, further, is drawn from the five or seven median bundles (Figs. 87–9). (The vertical lines limit laterally the ovular supply bundles and those of the lower series from which these arise.) Each of these may divide once or twice, and ten or fifteen bundles enter the ovule. The latter is attached along the edge of a horseshoe-shaped swelling, the curve extending down between the wing-shoulders to the base of the ovule proper. Along this line the bundles pass out (Figs. 90 and 91). Very weak branches pass on from some of these bundles into the scale beyond for a short distance (Fig. 91). Not only do the seven median bundles give off an upper series, but all members of the lower series also divide in this manner. The division of these bundles begins soon after the ovular group has been formed (Fig. 89), and passes progressively outward laterally until each has formed opposite to it an inverted bundle. All of the latter persist to the end of the scale. The appearance given (Figs. 91 and 92) is that of an upper series formed by the folding over of the lower, in the manner in which in *Sequoia* a false lower is formed from the upper. This effect is given by the removal of the central portion by the ovule. The origin of the series is clear. The definite inverse orientation shows that the double series cannot be accounted for merely by the large size of the scale. Thus even in the genus *Agathis* remnants of the double series occur. In *A. Bidwillii* and *A. alba* ten to twelve traces supply the ovule, being derived from the three median traces; in *A. borneënsis* there are six to eight, and in *A. spinulosa* four to eight traces, also all derived from the three median bundles. Thus in the reduction of its ovular supply to two weak strands, and the derivation of those from the median bundle only, *A. australis* seems to be the least primitive.

The Araucarineae and the Podocarpaceae, having simple sporophylls, have been supposed by some to form one section of the Coniferales, and all others with compound strobili another. Thomson (17) has termed the first

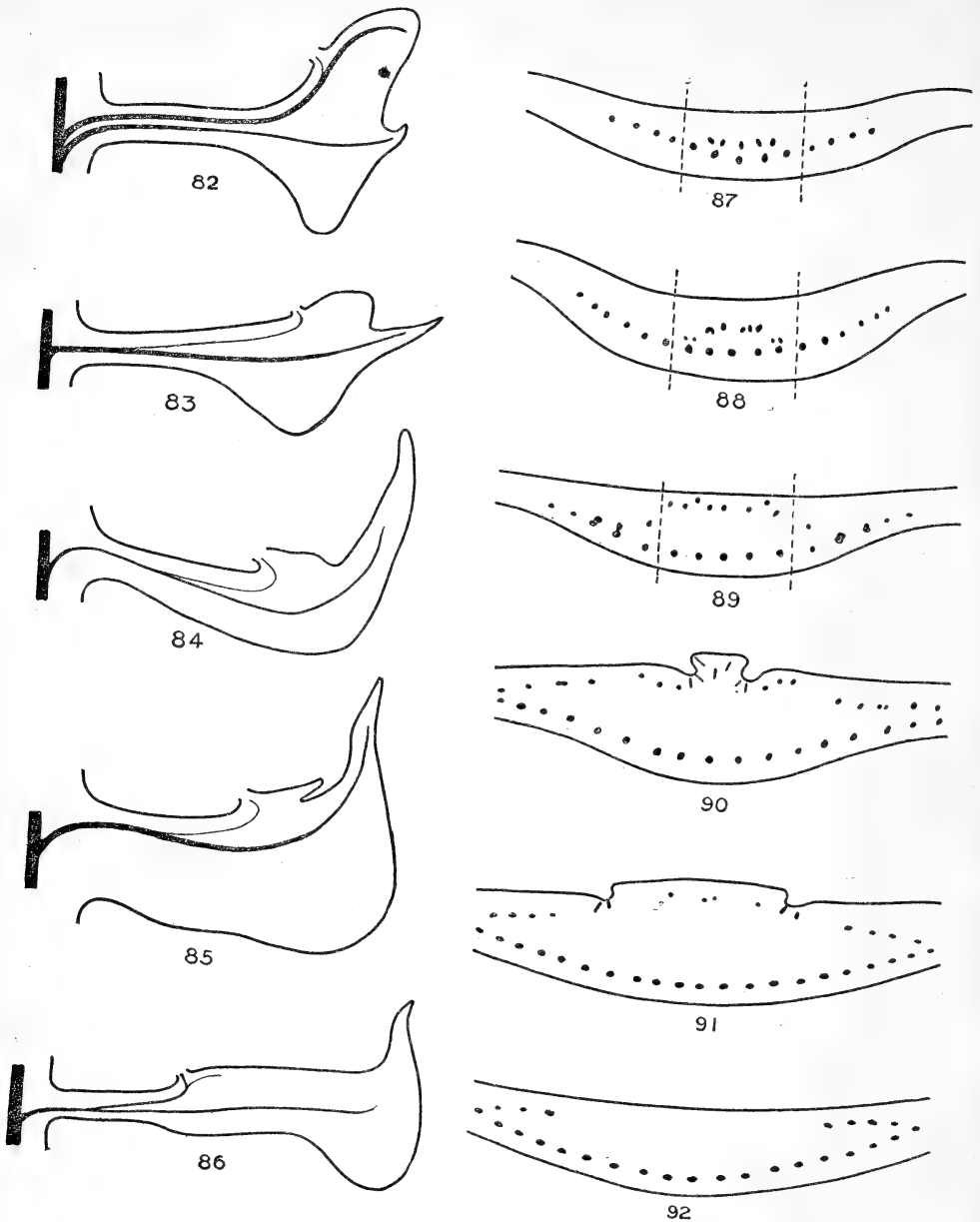

Diagrams illustrating the origin and course of the vascular supply of the cone scale. (Figs. 82-6, longitudinal; Figs. 87-92, transverse.) Fig. 82, *Athrotaxis cupressoides*; Fig. 83, *A. taxifolia*; Fig. 84, *A. selaginoides*; Fig. 85, *Cunninghamia sinensis*; Fig. 86, *Agathis australis*; Figs. 87-92, *A. vitiensis*.

forms 'aplosporophyllous' and the second 'diplosporophyllous'. It is evident from the above figures and descriptions that in a 'diplosporophyllous' group, the Taxodineae, we find an 'aplosporophyllous' genus,

*Cunninghamia*, and further, another genus, *Athrotaxis*, containing both an 'aplosporophyllous' and a 'diplosporophyllous' species. Such fundamental differences could hardly occur even within a natural family, much less within the limits of a genus. In the Araucarineae, a so-called 'aplosporophyllous' tribe, one species, *Araucaria Bidwillii*, is found, the 'diplosporophyllous' nature of which can hardly be questioned. Even in *Agathis* itself there remains a species possessing a cone scale with a double series of bundles. Further, Hollick and Jeffrey (3) have demonstrated a double series of bundles in the cone scales of Mesozoic Araucarians. Apparently the strobili of the Conifers are strictly homologous, and hence the terms 'aplo-' and 'diplosporophyllous' may appropriately be abandoned.

Much of the evidence on which the conclusion was drawn that the fertile structure in the Araucarians and the Podocarps is of simple nature, is related to the orientation of the ovular supply. Thomson (17) has announced that in some Abietineae the ovular supply is inversely oriented, thus a double inversion occurring in the ovuliferous scale. The conclusion is then drawn that, since in *Saxegothaea* and *Microcachrys* the inverted series is very weak, and supplies only the ovules, it is merely ovular supply. This must likewise apply to the Araucarineae. Hence the sporophyll in these forms must be simple. But under these conditions so would be those of *Cunninghamia*, *Athrotaxis laxifolia*, and *A. selaginoides*, which certainly are not of a simple nature. In such cases as *Saxegothaea*, *Agathis*, *Cunninghamia*, *Microcachrys*, and the two above-named species of *Athrotaxis*, the upper series is not merely ovular supply morphologically, though that may be chiefly its physiological function. Naturally the extreme distal portions are, however. These bundles are the last vestige of the upper series, retained to supply the ovules. There is clear evidence of this. These supposedly strictly ovular supply bundles in *Agathis australis* and *A. vitiensis* give off, as they turn into the ovule base, branches which continue the course of the original bundle—a scale supply branch. Further, strands departing to ovules in forms where the upper series is not reduced are not freed until the immediate vicinity of their destination is reached. Why, even if the sporophyll is simple, should an ovular supply be set off far back at the base of the cone scale as in *Saxegothaea* and *Cunninghamia*, or part way out in the scale as in *Agathis* and *Athrotaxis selaginoides*? *Athrotaxis cupressoides* (Fig. 82) suggests the normal point of origin and short course of ovular bundles in that genus. Compare with *A. selaginoides* (Fig. 84). In *Araucaria brasiliana*, where fusion has undoubtedly gone even farther than in *Agathis*, the ovular supply is derived almost directly beneath the base of the ovule (Figs. 35 and 36). Finally, the ovular supply bundle is not generally inverted. Compare the statements of Radais (9), Van Tieghem (18), and Strasburger (13). It may be oriented normally or laterally, but is most frequently concentric. The orientation may change during the

course. This variable condition might be expected in a minute bundle that follows the short twisting reversed course it usually follows. Hence it is believed that no sound argument can be based on the inversion of the ovular supply.

From comparative and structural evidence it seems, therefore, that the apparently simple cone scale of *Agathis* is really of compound nature, and represents the double structure of the abietinean cone. The Araucarians are thus *Conifers*, even though they have progressed far along a different line from that followed by the other groups. With Mr. Sinnott's (11) demonstration of the similar nature of the cone scale of the Podocarpaceae, it becomes evident that the female cones of all the Conifers are strictly homologous. And hence, since those forms in which the twofold nature is hidden are either—as the Taxodineae—admittedly recent, specialized derivatives of such a double-unit stock, or seem clearly to be such when all evidence is carefully considered, the primitive Conifers must have possessed this type of cone. And the Abietineae in retaining it are thus representatives of ancient, ancestral forms. The unity of the Coniferales as a natural group seems to be established, and the writer cannot too strongly dissent from the opinion expressed by Seward and Ford (10), that the living and extinct Araucarians should form a subdivision of the Gymnosperms, the 'Araucariales'.

From the evidence presented by the study of the morphology of the female cone, the Araucarians occupy the same phylogenetic position as is suggested by their gametophytes and embryos—a highly specialized branch of the Conifers derived far back from some stock possessing abietinean characters. Vestiges of features possessed by this primitive stock are still to be found—the bars of Sanio, opposite pitting, and xylar resin canals recently discovered by Dr. Jeffrey, as well as the double nature of the megasporophyll. All these features have not unnaturally been almost lost during the long period of separation and divergent development of the araucarian stock. Meanwhile, as is clear from the evidence of fossils, this group flourished, a great series of widely variable forms inhabiting much of the world during the Mesozoic. Under such circumstances the few surviving members might well be highly specialized forms. That the same general evolutionary tendencies have prevailed, however, as in all Conifers, is evident from the similar results brought about in forms admittedly at the extreme end of another branch from the primitive stock—in the genera *Cunninghamia*, *Athrotaxis*, *Sequoia*.

As between the two genera, *Agathis* and *Araucaria*, the latter, as regards the morphology of the ovulate strobilus, is the more primitive on the whole, though it contains species (*A. brasiliana* and *A. imbricata*) which have progressed further than any species of *Agathis*. Too little is yet known of the early life-history of *Araucaria* to determine from that stand-

point what relation it may bear to *Agathis*. It seems evident that within the latter genus the species selected for this investigation, *A. australis*, is the least primitive.

#### SUMMARY.

1. *Agathis australis* is monoecious. Ovulate strobili appear about October first; pollination occurs one year later, and fertilization thirteen months after pollination.

2. The mature gametophyte is club-shaped, the larger upper section bearing numerous scattered archegonia.

3. The archegonial jacket is incomplete near the neck, the cells of which are thick walled and form a complex which resists the entrance of the pollen-tube.

4. The pollen germinates in the axil of the cone scale, no micropyle being differentiated at that time. Long, branching haustorial pollen-tubes penetrate the cone axis, also the phloem and even the xylem of the scale traces. In other species of *Agathis* they also invade the axial bundles.

5. The two male elements are cells, somewhat unequal in size, limited by delicate walls. The nucleus equals in size that of the egg.

6. The fusion nucleus maintains a central position in the archegonium, and five or six consecutive free nuclear divisions ensue.

7. The mature proembryo is complex. Of its three tiers the median is the embryo proper, the upper forms suspensors, and the lower is an elaborate penetrative and protective cap.

8. The cone scale of *Agathis* is double in nature, homologous with the bract and megasporophyll of the Abietineae. Exactly parallel fusion and reduction have taken place in the Taxodineae.

9. The morphology of the gametophyte, of the embryo, and of the ovulate strobilus bespeaks strong specialization.

10. The Araucarineae represent a highly specialized divergent branch of the Coniferales. Those features which at first glance seem to relate them to more primitive Gymnosperms are the result of specialization and reduction.

11. The two genera, *Araucaria* and *Agathis*, are closely related; *Agathis* is probably the more recent, and within the genus *A. australis* the highest type.

#### METHODS.

In preparing the ovules both sides were cut off, the embryo-sac being freely exposed or sectioned. A chrom-acetic solution—1.0 per cent. chromic acid and 0.8 per cent. acetic acid—was used as a killing and fixing agent. This was allowed to act at least twenty-four hours, and even three to five days in some cases. The long immersions produced equally

good, if not better results, and the material was considerably bleached. The usual methods of dehydrating and embedding in paraffin were employed. Sections were cut five and ten micra thick, and stained with Haidenhain's haematoxylin and safranin.

The writer desires to express his gratitude to the committee on administration of the Frederick Sheldon Fund for Travelling Fellowships of Harvard University; to the many friends in New Zealand and Australia whose kind assistance made possible the securing of much of the material used in the present memoir; to Mr. E. W. Sinnott, co-worker in field and laboratory; and to Professor E. C. Jeffrey, whose advice and guidance have been invaluable. He likewise owes much information, valuable in the present connexion, to a collection of araucarian Conifers forwarded through the kindness of the late Dr. M. Treub, Director of the Botanic Gardens at Buitenzorg, Java. The investigation has been carried on in the Phanerogamic Laboratories of Harvard University.

---

#### SUMMARY OF LITERATURE CITED.

1. DICKSON, A.: On some Stages in the Development of the Female Flower of *Dammara australis*. Trans. Bot. Soc. Edinburgh., vol. vii, 1863, p. 47.
2. FUJII, K.: Some Remarks on the Cretaceous Fossil Flora and the Causes of Extinction. Bot. Mag., Tokio, vol. xxiv, 1910.
3. HOLLICK, A., and JEFFREY, E. C.: Studies of Cretaceous Coniferous Remains from Kreischerville, New York. Mem. N. Y. Bot. Gar., vol. iii, 1909.
4. JEFFREY, E. C., and CHRYSLER, M. A.: The Microgametophyte of the Podocarpaceae. Amer. Nat., vol. xli, 1907, p. 102.
5. LAWSON, A. A.: The Gametophytes, Archegonia, Fertilization, and Embryo of *Sequoia sempervirens*. Ann. Bot., vol. xiv, 1900, p. 281.
6. ———: The Gametophyte, Fertilization, and Embryo of *Cryptomeria japonica*. Ann. Bot., vol. xviii, 1904, p. 417.
7. ———: The Gametophyte, Fertilization, and Embryo of *Cephalotaxus drupacea*. Ann. Bot., vol. xxi, 1907, p. 1.
8. LOPRIORE, G.: Über die Vielkörnigkeit der Pollenkörner von *Araucaria Bidwillii*. Ber. Deutsch. Bot. Gesellsch., vol. xxiii, 1905, p. 335.
9. RADAI, M.: L'Anatomie comparée du fruit des Conifères. Ann. des Sci. Nat., Bot., sér. 7, t. xix, 1894, p. 165.
10. SEWARD, A. C., and FORD, S. O.: The Araucarieae, Recent and Extinct. Phil. Trans. Roy. Soc., vol. cxcviii, 1906, p. 305.
11. SINNOTT, E. W.: The Morphology of the Reproductive Structures in the Podocarpaceae. Ann. Bot., Jan., 1913.
12. STRASBURGER, E.: Die Coniferen und die Gnetaceen. 1872.
13. ———: Die Angiospermen und die Gymnospermen. 1879.
14. THOMSON, R. B.: Preliminary Note on the Araucarineae. Science, N. S., vol. xxii, 1905, p. 88.
15. ———: The Araucarieae—a 'Protosiphonogamic' Method of Fertilization. Science, N. S., vol. xxv, 1907, p. 271.
16. ———: The Megaspore Membrane of the Gymnosperms. Univ. Toronto Biol. Ser., No. 4, 1905.

17. THOMSON, R. B.: The Megasporophyll of *Saxegothaea* and *Microcachrys*. Bot. Gazette, vol. xlvii, 1909, p. 345.
18. VAN TIEGHEM, P.: Anatomie comparée de la fleur femelle et du fruit des Cycadées, des Conifères, et des Gnétacées. Ann. des Sci. Nat., Bot., sér. 7, t. x, 1869, p. 269.
19. WORSDELL, W. C.: The Structure of the Female 'Flower' in Coniferae. Ann. Bot., vol. xiv, 1900, p. 39.

## DESCRIPTION OF PLATES I TO IV.

Illustrating Mr. Eames's paper on *Agathis australis*.

Note: The figures are of *Agathis australis*, with the exception of Nos. 37 and 42.

### PLATE I.

- Fig. 1. Habit; showing mature male cones, and female cones at time of pollination and of fertilization.  $\times \frac{1}{3}$ .
- Fig. 2. Longitudinal section of ovule just before fertilization; showing distribution of archegonia and freedom of nucellus.  $\times 7$ .
- Fig. 3. The same; after fertilization. The suspensors have thrust the embryo down into the lower portion of the endosperm.  $\times 7$ .
- Fig. 4. Longitudinal section of the ripe seed; showing the large embryo and the dry beak.  $\times 6$ .
- Fig. 5. Longitudinal section of young ovule; showing developing embryo-sac and 'spongy tissue'.  $\times 500$ .
- Fig. 6. Portion of Fig. 3 enlarged to show course of suspensors.  $\times 25$ .
- Fig. 7. Longitudinal section of tip of mature gametophyte and surrounding tissue; showing the cap of the megaspore membrane.  $\times 80$ .
- Fig. 8. Longitudinal section of suspensor coil with embryo.  $\times 80$ .
- Fig. 9. Longitudinal section of upper portion of nucellus and gametophyte; showing erosion of the latter by pollen-tubes.  $\times 80$ .
- Fig. 10. The same; showing course of pollen-tubes.  $\times 80$ .
- Fig. 11. A typical mature archegonium.  $\times 125$ .
- Fig. 12. The archegonium with mature central cell.  $\times 250$ .

### PLATE II.

- Fig. 13. Archegonium (sectioned somewhat obliquely); showing young egg nucleus and ventral canal nucleus, the latter at the side and beginning to disorganize.  $\times 250$ .
- Fig. 14. Archegonium with young egg nucleus and ventral canal nucleus in median position.  $\times 200$ .
- Fig. 15. Archegonium showing 'pseudo-fertilization'.  $\times 500$ .
- Fig. 16. Body cell just before division, passing down between nucellus and embryo-sac.  $\times 500$ .
- Fig. 17. The male cells passing down between the nucellus and the gametophyte; the large nuclei are prominent, the limitation of the cytoplasm about each can faintly be seen.  $\times 500$ .
- Fig. 18. A male cell with tube cytoplasm and two accompanying nuclei.  $\times 500$ .
- Fig. 19. The young egg nucleus and surrounding cytoplasm, seen in transverse section of the archegonium.  $\times 1,000$ .
- Fig. 20. The mature egg nucleus with surrounding cytoplasm, seen in transverse section of the archegonium.  $\times 1,000$ .
- Fig. 21. The fusion nucleus and its kinoplasmic sheath with the intranuclear spindle of the first division.  $\times 1,350$ .
- Fig. 22. The proembryo: two-nuclear stage, the nuclei large and free from the kinoplasmic sheath.  $\times 1,200$ .

Fig. 23. The same; thirty-two-nuclear stage, transverse section; showing lower part of young suspensor cap.  $\times 800$ .

Fig. 24. The same; vertical section at time of first wall formation. Three tiers of cells are evident: the upper, suspensor initials; the median, the embryo proper; the lower, the undifferentiated embryonic cap.  $\times 800$ .

#### PLATE III.

Fig. 25. The archegonium at time of fertilization; showing the large male nucleus in the centre.  $\times 500$ .

Fig. 26. The same archegonium, a section just below Fig. 25; the egg nucleus is seen, and a small tangential section of the male nucleus.  $\times 500$ .

Fig. 27. The fusion nucleus surrounded by the kinoplasmic sheath.  $\times 700$ .

Fig. 28. The proembryo; thirty-two-nuclear stage with suspensor cap of cytoplasm.  $\times 600$ .

Fig. 29. The proembryo in the archegonium; four-nuclear stage.  $\times 300$ .

Fig. 30. The same; eight-nuclear stage.  $\times 300$ .

Fig. 31. The proembryo almost mature; showing the suspensors elongating distally, the embryo proper, and the penetrative cap.  $\times 350$ .

Fig. 32. The embryo proper with its penetrative cap and the base of its suspensors penetrating the endosperm.  $\times 700$ .

Fig. 33. The embryo enlarging, the cap disintegrating.  $\times 700$ .

Fig. 34. The same; a slightly later stage.  $\times 700$ .

Fig. 35. The same; a still later stage; the cap has disappeared.  $\times 700$ .

Fig. 36. The proembryo; thirty-two-nuclear stage, before suspensor-cap formation.  $\times 800$ .

#### PLATE IV.

Fig. 37. *Agathis borneënsis*; transverse section of axial bundle of the cone; showing invasion by pollen-tubes.  $\times 125$ .

Fig. 38. Transverse section of archegonium neck and surrounding tissue; showing erosion by pollen-tube around the resistant neck cells.  $\times 250$ .

Fig. 39. Top of archegonium with thick-walled neck cells.  $\times 800$ .

Fig. 40. Transverse section of archegonium neck.  $\times 500$ .

Fig. 41. The trace of the megasporophyll within the cortex of the cone; showing a pollen-tube in the xylem, also three in the phloem at the lower side of the figure.  $\times 250$ .

Fig. 42. *Araucaria Bidwillii*; transverse section of the vascular supply of the megasporophyll close to the cone axis; showing the two original bundles, the upper inverted.  $\times 40$ .





1.



2.

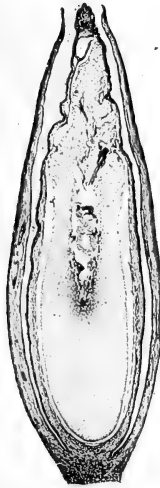

3.



4.

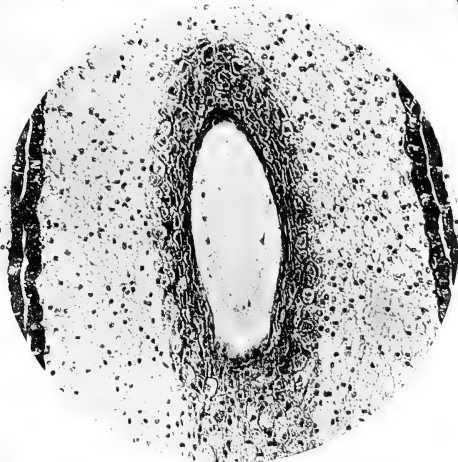

5.

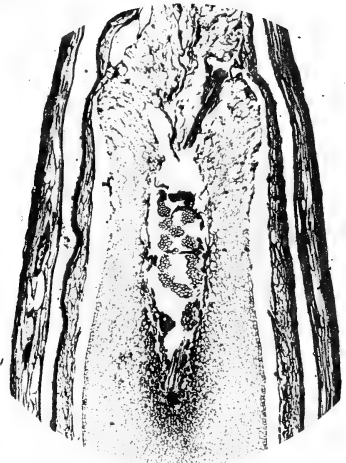

6.

EAMES — MORPHOLOGY OF AGATHIS.





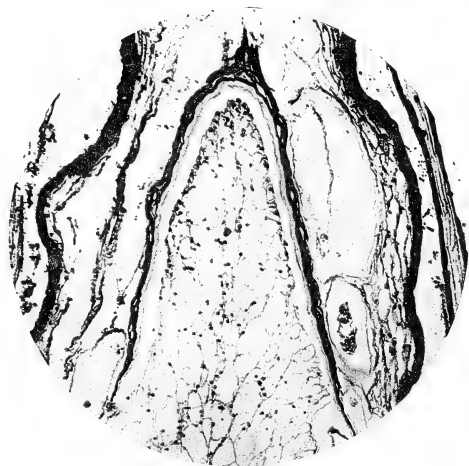

7.

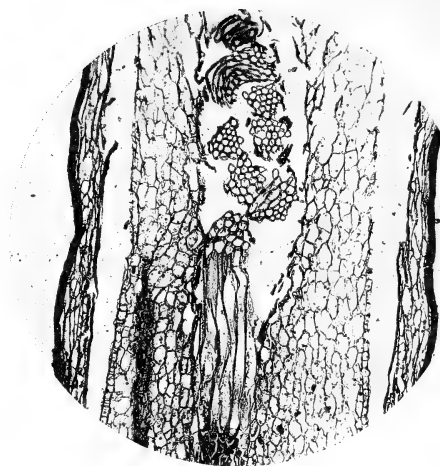

8.

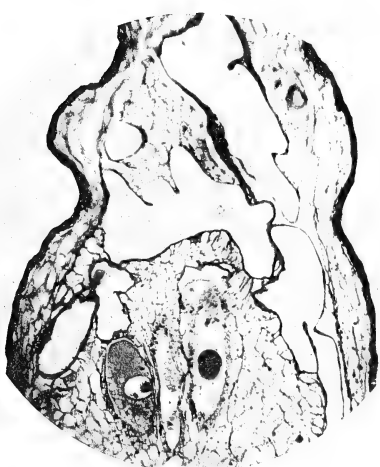

9.

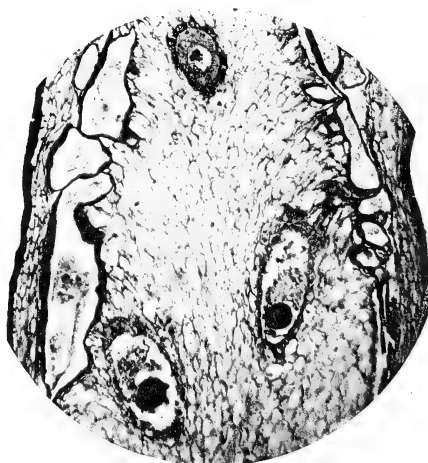

10.



11.



12.

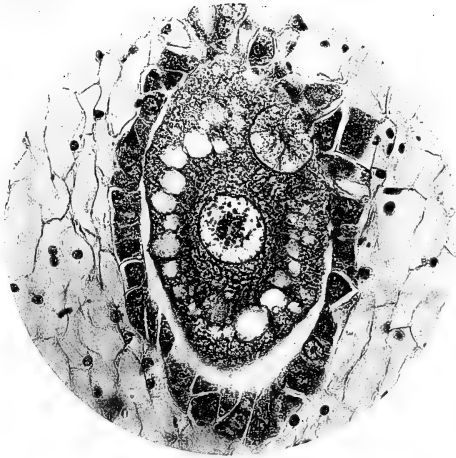

13.

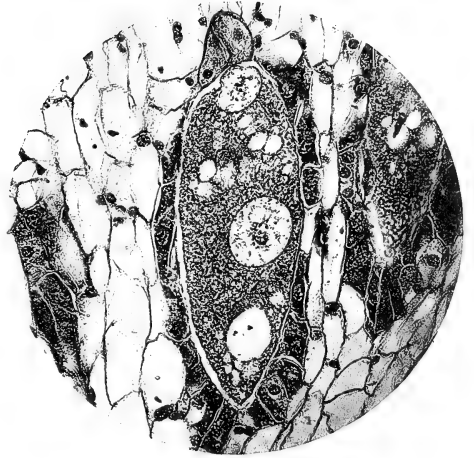

14.

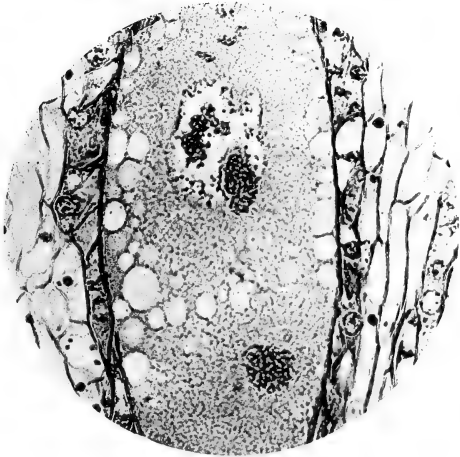

15.

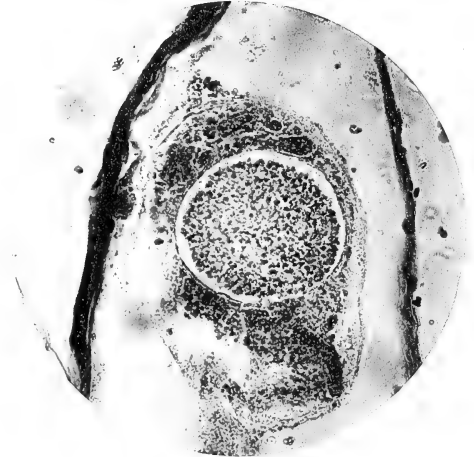

16.



17.

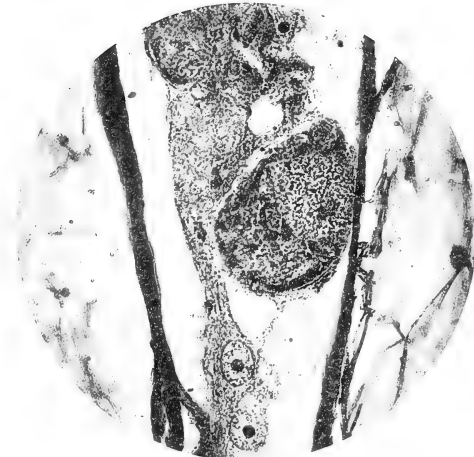

18.





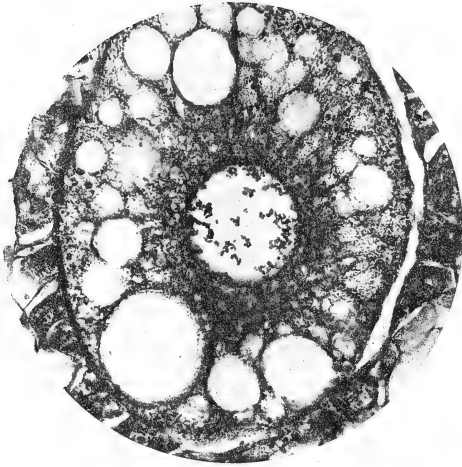

19.

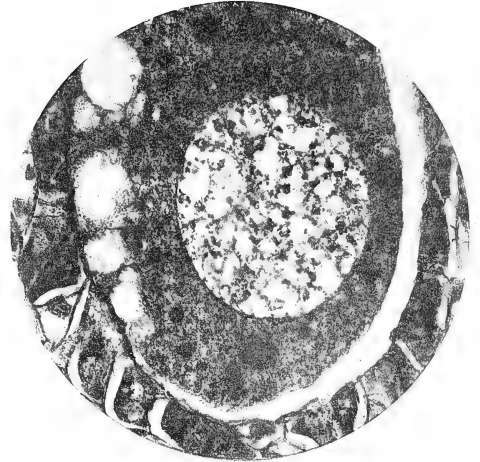

20.



21.

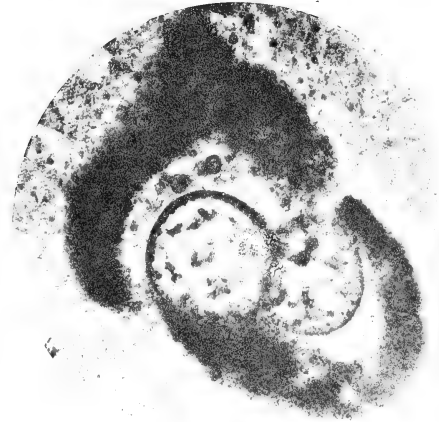

22.

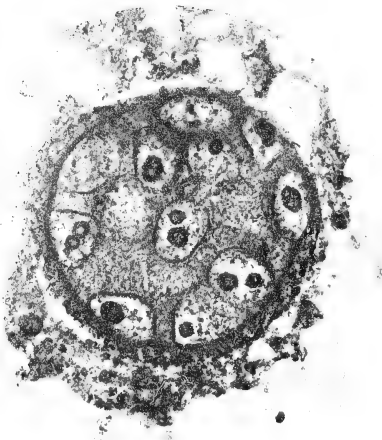

23.

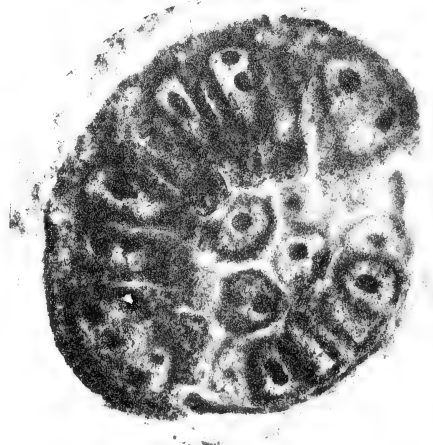

24.





25.



26.

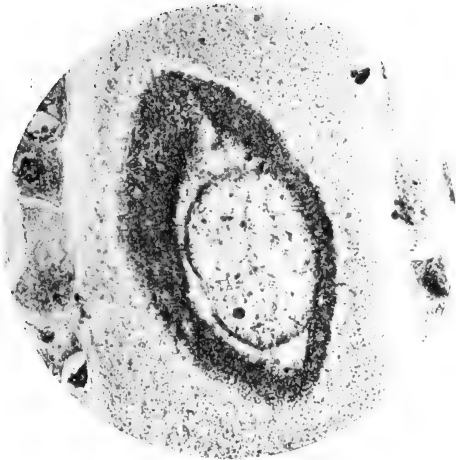

27.

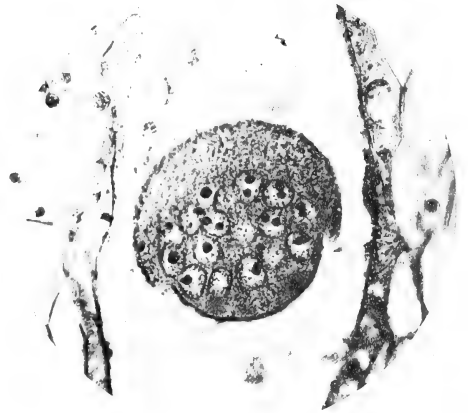

28.

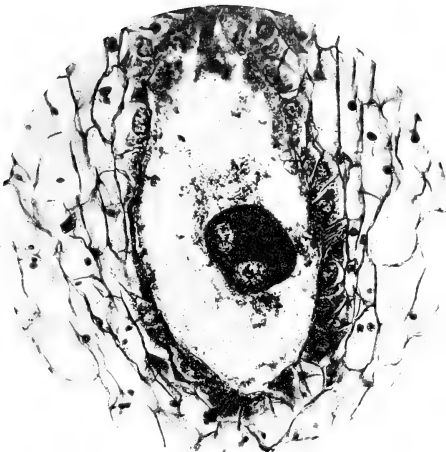

29.



30.

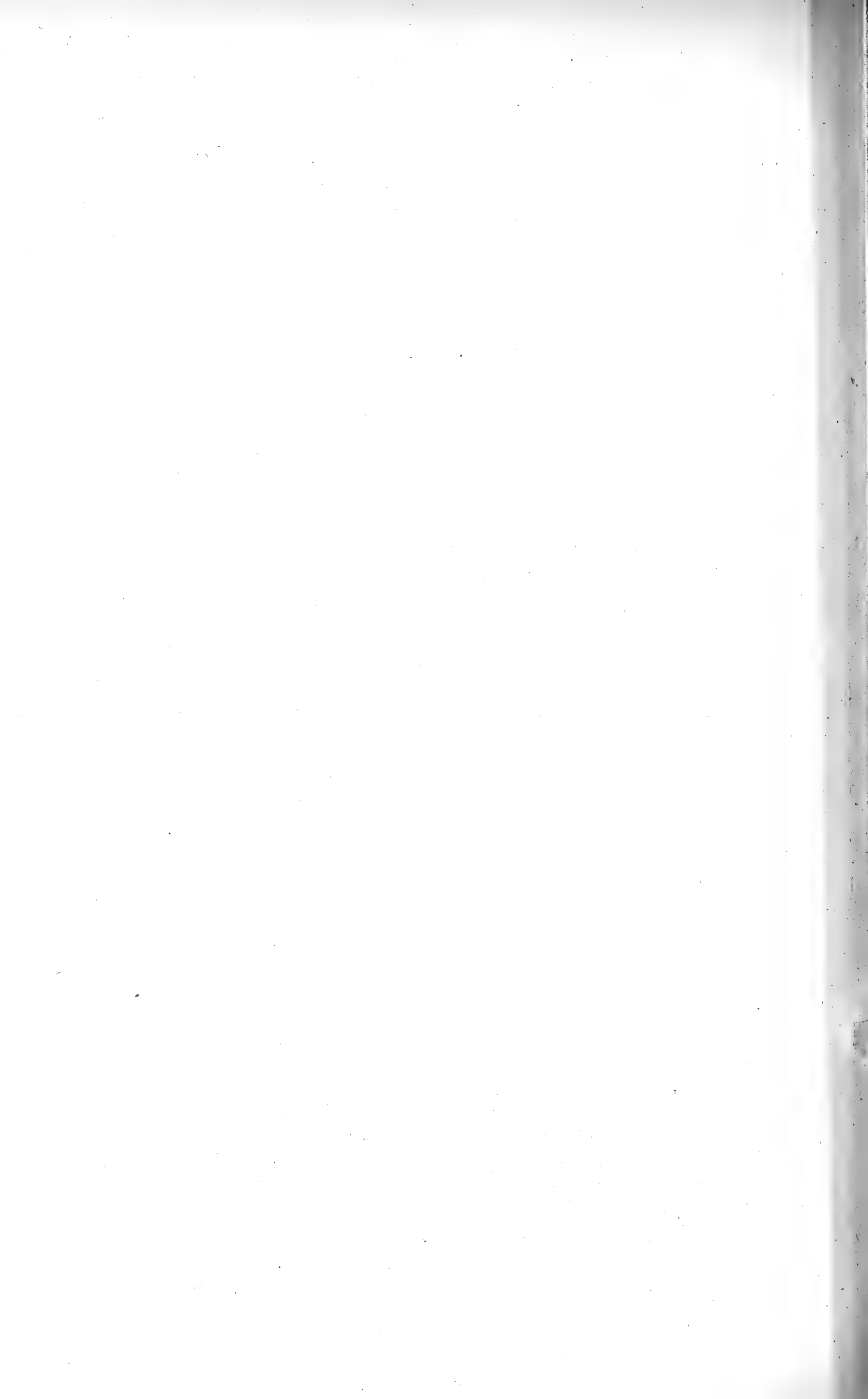



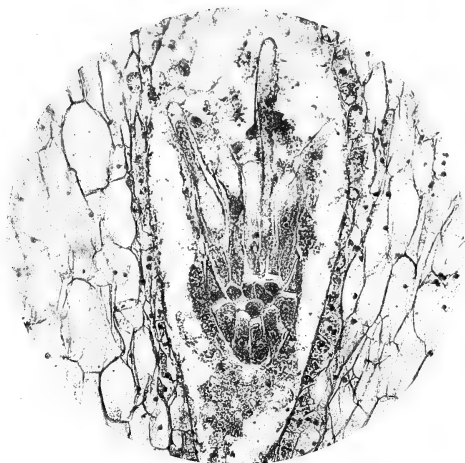

31.



32.



33.



34.



35.

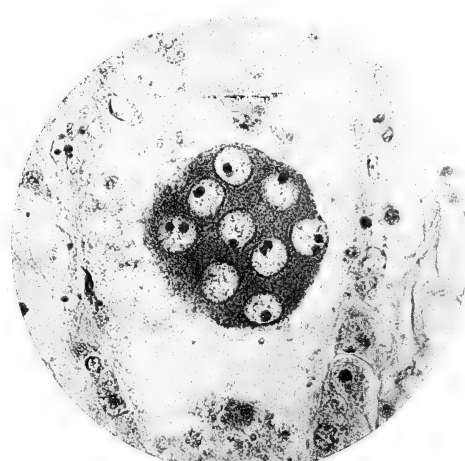

36.

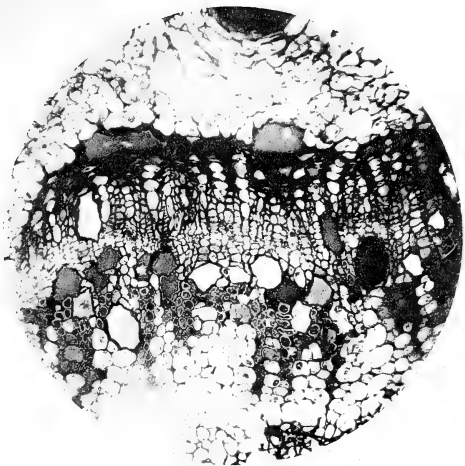

37.

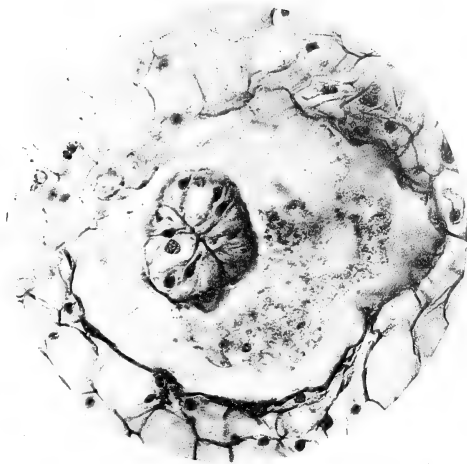

38.

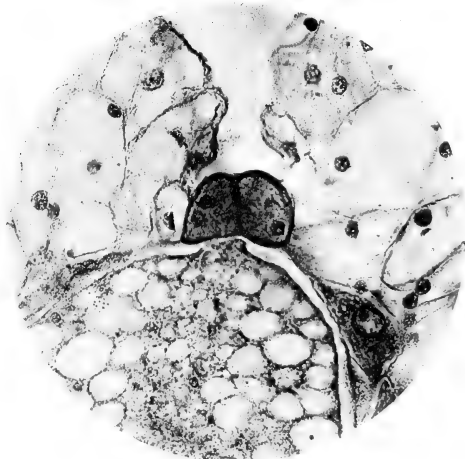

39.

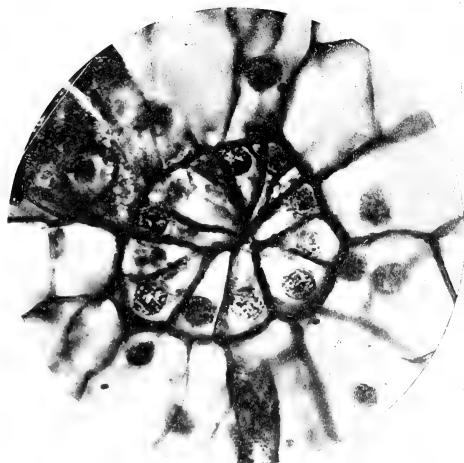

40.

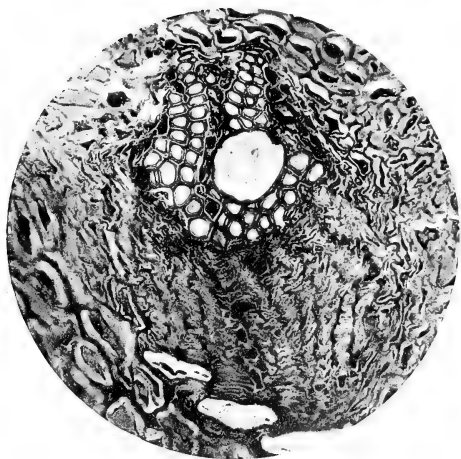

41.

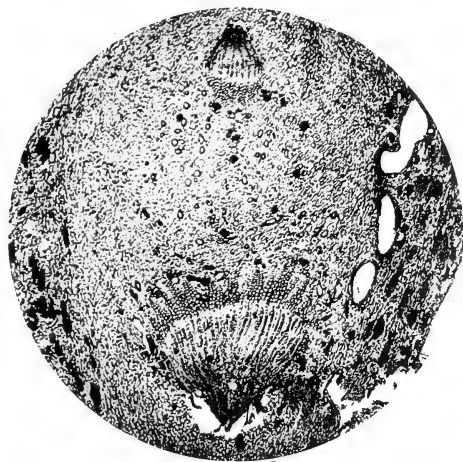

42.



# The Morphology of the Reproductive Structures in the Podocarpaceae.<sup>1</sup>

BY

EDMUND W. SINNOTT.

With Plates V-IX and nine Diagrams in the Text.

THE construction of a natural classification for the Coniferales, based upon comparative studies among its many living and fossil forms, has been the object of all recent morphological investigations which have dealt with members of the group. A wealth of new facts concerning this great plant order has consequently been added to our knowledge, and although in most of its families at least the main outlines of the anatomy of the sporophyte and of the structure and development of the gametophytes are now understood, yet among certain groups so little has been done that, with regard to almost everything but external features, comparative ignorance still prevails.

This is especially true in the case of the Podocarpaceae, an important and clearly defined family, the natural position and relationships of which have been the cause of much discussion and difference of opinion among botanists.

Its members belong predominantly to the Southern Hemisphere, and are represented north of the Equator by only a few species in southern and eastern Asia and the West Indies. The family includes six genera: *Podocarpus*, of sixty species, distributed throughout most of the Southern Hemisphere and in India, China, Japan, and the West Indies; *Dacrydium*, of sixteen species, from Australasia, the East Indies, and southern Asia; *Saxegothea*, monotypic, from the Andes; *Microcachrys*, also monotypic, from Tasmania; *Pherosphaera*, of two species, from Australia; and *Phyllocladus*, of five species, from New Zealand, Tasmania, and the Philippine Islands.

The almost entire restriction of the Podocarpaceae to the Southern Hemisphere doubtless explains the neglect accorded them at the hands of the morphologists, who up to the present have had little but fragmentary and poorly preserved material with which to work. Our knowledge of the

<sup>1</sup> Contributions from the Phanerogamic Laboratories of Harvard University, No. 53.

reproductive features of the family, and especially of the female gametophyte and formation of the embryo, are therefore very incomplete. Observations on the strobilar anatomy of the Podocarpaceae date back to 1869, when Van Tieghem (19) published a brief general account of the structure and vascular supply of the female cone. This was amplified by Strasburger (14, 15) in 1872 and 1879, and in more recent years Thomson (17), Tison (18), Stiles (11, 12, 13), Miss Gibbs (4), and Miss Robertson (10) have investigated the sporophyll in several genera. The structure of the mature pollen-grain is known for most of the genera from the work of Jeffrey and Chrysler (5), Burlingame (1), Coker (2), and Miss Young (20), and the development of the male gametophyte has been studied, but in only a comparatively few cases. Our knowledge of the female gametophyte and of the development of the embryo is confined to the observations of Miss Kildahl (6) and Miss Young (21) on *Phyllocladus alpinus*, of Coker (2) on *Podocarpus coriaceus*, and of Stiles (13) and Miss Gibbs (4) on several other species of *Podocarpus*. The last two writers have recently published long papers which contain considerable information as to the reproductive morphology of the family. The results of Mr. Stiles, though accurate and well stated as far as they go, are based on first-hand material of only *Microcachrys*, two of the four sub-genera of *Podocarpus*, and one of the two main divisions of *Dacrydium*. Even in these, few new data are brought forward as to the structure of the female gametophyte and the development of the embryo. Miss Gibbs's paper on the female strobilus of *Podocarpus*, though embracing observations on a large number of forms in all the sub-genera, is mainly concerned with histological details, and lays little emphasis on broad anatomical comparisons between members of the various groups. Considerable information is set forth as to the female gametophyte and embryo, but this is fragmentary, and is concerned almost entirely with the very early stages of the gametophyte and with the structure of the mature embryo. The author draws no conclusions whatever as to relationships.

During the year 1910-11 the present writer was fortunate in being able to visit Australia and New Zealand as Frederick Sheldon Travelling Fellow of Harvard University, and while there collected abundant material for a study of the vegetative and reproductive structures in several of the genera and a large number of the species of the Podocarpaceae.<sup>1</sup> Such

<sup>1</sup> These include *Podocarpus Totara*, *P. Hallii*, *P. nivalis*, *P. spinulosus*, *P. elatus*, *P. macrophyllus*, *P. ferrugineus*, *P. spicatus*, *P. vitiensis*, and *P. dacrydioides*; *Dacrydium Bidwillii*, *D. intermedium*, *D. Colensoi*, and *D. cupressinum*; and *Phyllocladus glaucus*, *P. trichomanoides*, and *P. alpinus*.

Anatomical material was preserved in 70% alcohol or 4% formalin, but that destined for embryological investigation was first killed in chrom-acetic acid (usually about 1% chromic acid and 1% acetic acid in water) or in a mixture of three parts of a saturated solution of corrosive sublimate in 50% alcohol and one part of a 2% solution of potassium bichromate; after which it was carefully



of the results as deal with the morphology of the reproductive organs are embodied in the present paper, which has for its object a description of the anatomical features of the staminate and ovulate strobili and a history of the development of the male and female gametophytes and of the embryo, together with a discussion, in the light of the facts set forth, of the relationships between the various genera and of the affinities of the family as a whole to the other great groups of the Coniferales.

#### THE STAMINATE STROBILUS.

The male cone of the Podocarpaceae exhibits no great diversity of structure and conforms to the general coniferous type. The axis contains a cylinder of small vascular bundles, outside which is a ring of cortical canals. The single bundle departing to each microsporophyll leaves behind it a gap in the cylinder. The sporophylls are always bisporangiate, thus agreeing precisely with those found among the Abietineae, and differing strongly from the peltate multisporangiate sporophylls of the Araucarineae.

#### THE OVULATE STROBILUS.

The female strobilus of the Podocarpaceae is distinguished from that of all other Conifers save the Taxineae by the exhibition of two well-marked tendencies—towards a reduction in the number of sporophylls, and towards a fleshy condition of a part or the whole of the cone at maturity. In *Podocarpus* and *Dacrydium*, reduction has resulted in most cases in an abbreviation of the axis to a short, thickened stalk, bearing a few sterile, scale-like bracts at its base and one or two ovuliferous appendages above; but in *Saxegothea*, *Microcachrys*, *Pherosphaera*, and *Phyllocladus* the fertile scales are usually more numerous, and are arranged in more typical cones. In all the family, the bract or scale subtends but a single ovule, which is inverted in *Podocarpus* and certain species of *Dacrydium*, but is nearly or quite erect at maturity in the other genera. Outside the ovule, in addition to the usual single integument, there is an 'outer integument', 'arillus' or 'epimatium', which may entirely envelop the seed or be reduced to a small basal sheath. The origin and significance of this epimatium, and the morphological nature of the strobilar appendage on which it is borne, are disputed questions and have an important bearing on our theories as to the relationships of the family.

The genus *Podocarpus*, by far the largest and most widely distributed of the Podocarpaceae, shows much diversity of structure in its various species, and is separated into four main sub-genera on the character of the

washed in water or 50% alcohol, respectively, and run up slowly into 70% alcohol for preservation. The ordinary precautions used where careful fixation is desired were observed, such as killing the material directly in the field and slicing off the sides of the ovules with a razor, or stout knife in the case of species with a stony integument, to ensure rapid penetration.

female strobilus. *Eupodocarpus*, comprising the great majority of species, possesses a cone reduced to one or two ovules on a short axis which ripens into a bright fleshy 'receptaculum.' In *Stachycarpus* the axis is sometimes very short, bearing a single ovule, and is sometimes elongated, with several, but it is never thickened into a receptaculum. The fleshy character is here present in the epimatium, which becomes pulpy and edible, the seed being protected from injury by an exceedingly hard integument. *Nageia* is somewhat intermediate between these two sub-genera, for its axis is shortened and bears several fleshy bracts. The broad, parallel-veined leaves are the best distinguishing feature. In *Dacrycarpus* the cone is reduced to a single ovule, and the subtending bract, instead of being entirely free from the ovule as in all the rest of the genus, is fused for almost or quite its full length to the dorsal face of the epimatium. The short axis ripens into a fleshy receptaculum. Species of all these sub-genera were investigated.

Five members of *Eupodocarpus* were available for study: *P. Totara*, *P. nivalis*, *P. Hallii*, *P. spinulosus*, and *P. elatus*. The short cone axis in these species bears at its apex a single pair of opposite bracts, and in the axil of one or both is an inverted ovule (Pl. VI, Figs. 7 and 10; Diagram 1, A). A pair of sterile bracts at right angles to the fertile ones are often present, and there are sometimes signs of still a third pair. The slender cone-stalk is provided with a ring of vascular bundles and of cortical canals. This ring expands as it enters the enlarged receptaculum, and on approaching the apex becomes flattened into an ellipse (Diagram 1, B). From each end of the ellipse departs a bundle to one of the two fertile bracts, and each of these bract bundles is closely followed in turn by two large strands which carry away from the sides of the gap all the vascular tissue of the cylinder save the small traces to the sterile scales (Fig. 9; Diagram 1, C). Each pair of large bundles supplies an ovule, and its two component strands, as they pass upward through the cortex, gradually approach each other by their adaxial ends, xylem outward, and form a broadly V-shaped bundle with orientation inverse to that of the bract supply. After the early separation of the bract, this large strand enters the base of the ovule, where its subsequent behaviour varies somewhat according to the species.

In *P. Totara* and *P. nivalis* it divides again into two strands (Diagram 1, D and E), which remain close together and pass upward along the dorsal side of the epimatium (Fig. 8; Diagram 1, F). Upon reaching the chalaza, into which each sends a small concentric bundle (Diagram 1, G), they enter the apical 'knob' and soon die out. One or two weak branches sometimes depart towards the ventral side of the epimatium.

Conditions are similar in *P. Hallii* and *P. spinulosus*, save that the single basal bundle either remains undivided or breaks up into three parallel strands.

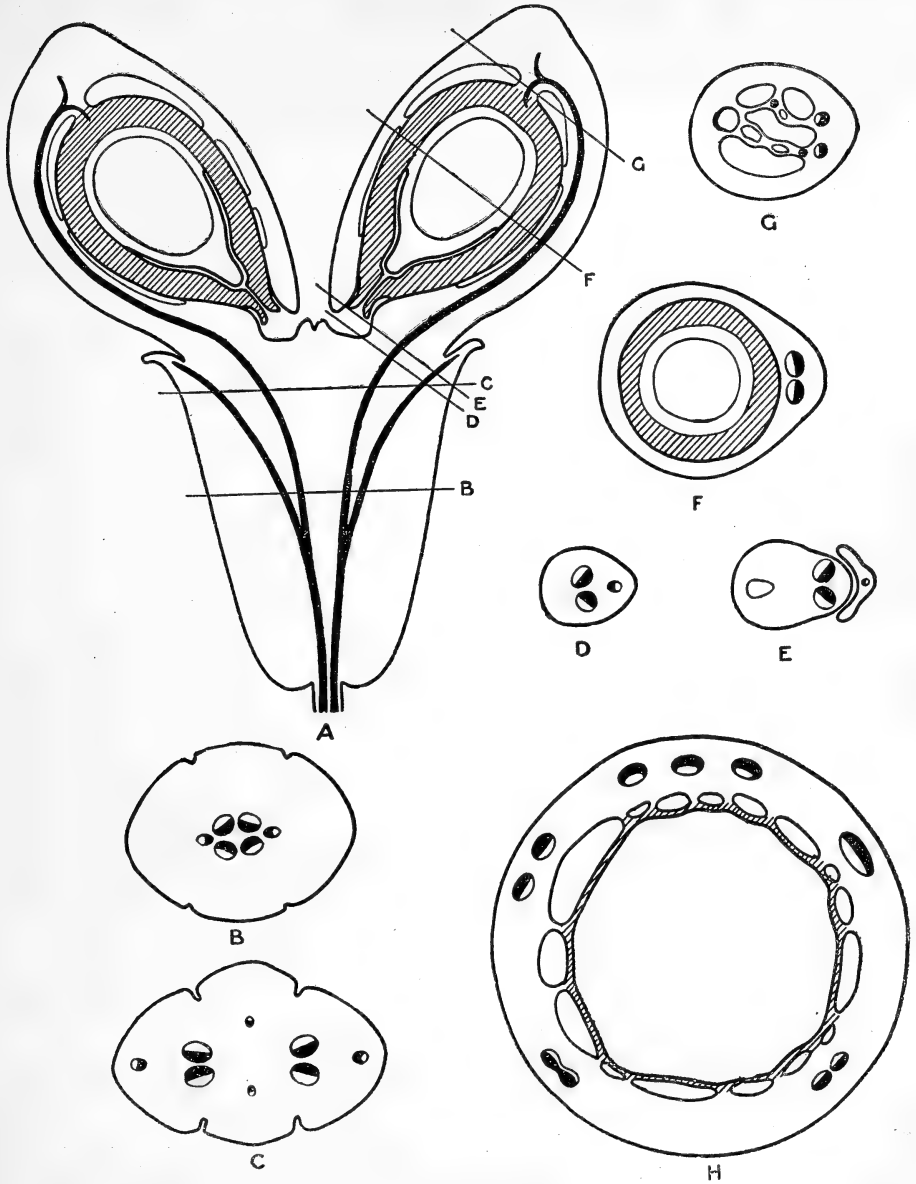

DIAGRAM I. *Podocarpus Totara*. A, vertical section through strobilus; B-G, successive transverse sections from receptaculum to chalaza. *P. elatus*. H, transverse section through middle of epimatium and ovule. Integument shaded, xylem black.

In all these species the nucellus for about half its length is free from the integument, which at maturity is divided into a narrow stony layer outside and a wider soft one within. It is fused throughout with the epimatium, which ripens into a leathery coat and is well provided with mucilage canals or sacs.

*P. elatus* has a much larger ovule and its thick epimatium is supplied by a more complex vascular system. The single basal strand, formed by the fusion of two, divides into three which separate considerably as they ascend. At the chalazal end these strands enter an anastomosing complex of seven main bundles, formed by the three we have just traced, which supply the dorsal portion of the epimatium, and by four others which pass down its ventral side and end blindly near the micropyle (Diagram 1, H). These ventral bundles probably represent continuations of the two lateral

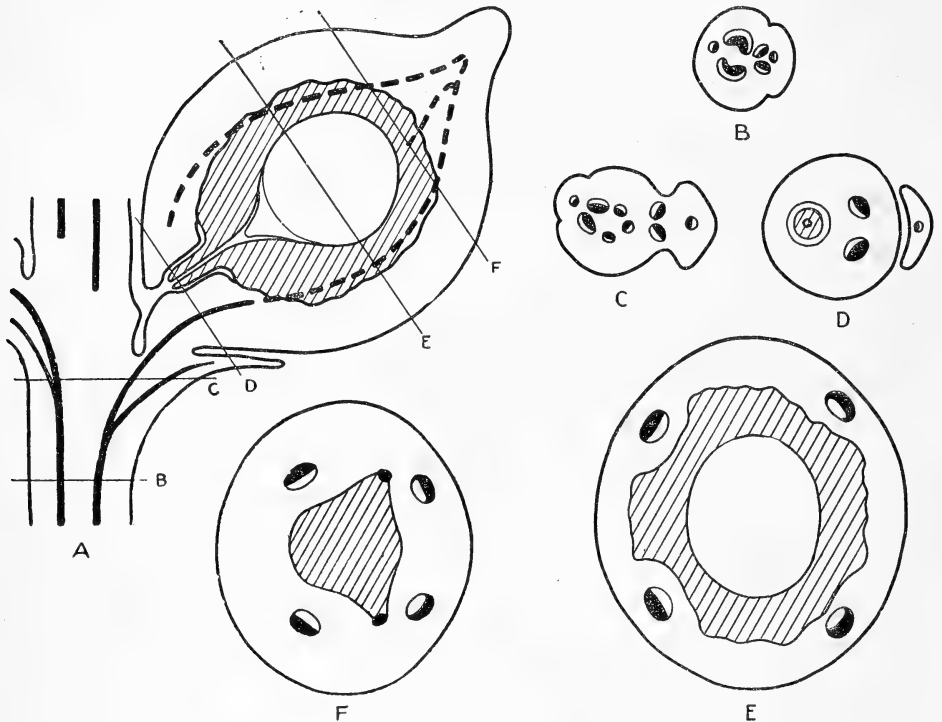

DIAGRAM 2. *Podocarpus spicatus*. A, vertical section through portion of strobilus; B-F, successive transverse sections from axis to chalaza.

members of the dorsal series. They usually fork somewhat and are often connected by small strands. The integument is thin and is fused throughout its entire length to the stout epimatium, but the inner margin of the latter is so fully occupied by distended resin sacs or spaces that the ovule proper is virtually suspended from it by thin strands of tissue (Diagram 1, H). The epimatium ripens into a thick firm coat.

Two members of the sub-genus *Stachycarpus* were investigated—*P. spicatus* and *P. ferrugineus*.

*P. spicatus*, unlike any other member of the genus, with a very few exceptions, possesses a long loose cone of many ovules somewhat distant

from one another, and each in the axil of a small bract (Fig. 16; Diagram 2, A). The vascular cylinder of the axis is a ring of small bundles, each with its cortical canal (Fig. 19; Diagram 2, B). Immediately after the departure of the strand which supplies the bract two larger ones are given off, one from each side of the gap (which soon closes), and as these pass outward through the cortex they approach each other by their adaxial ends, as in *Eupodocarpus*, and thus display an orientation inverse to that of the bract bundle (Diagram 2, C). The bract immediately becomes free and these two strands, which lie next each other but do not fuse, pass upward into the dorsal side of the epimatium (Diagram 2, D), and on ascending diverge until they lie about 90 degrees apart on the circumference of the ovule. They converge again considerably as they approach the chalazal end, where each sends a small bundle into the base of the ovule (Diagram 2, F) and then enters the apical knob, turns at a sharp angle, and descends into the ventral side of the epimatium without further branching. A cross-section through the median region of the ovule will thus show four bundles in the epimatium, nearly equidistant from one another (Diagram 2, E), the xylem of each facing outward and often tending to surround the phloem entirely. The nucellus is free for nearly half its length from the integument, which is intimately fused, save at its very tip, with the epimatium. The latter is plentifully supplied with large canals and becomes fleshy at maturity, but the integument ripens into an exceedingly hard and stony protective shell.

*P. ferrugineus* is closely related to *P. spicatus*, and the anatomy of the female strobilus in the two species is similar. The cone axis of *P. ferrugineus*, however, has been reduced to a very short branch bearing a few small scales and terminated by one, or occasionally two, inverted ovules (Figs. 15 and 17; Diagram 3, A). This short axis contains a ring of bundles and of canals, as do the other species, and a small strand is given off to each of the spirally arranged sterile bracts (Diagram 3, B). At the insertion of the ovule, however, one small bundle and its canal enter the fertile bract, and the remainder of the vascular ring divides into two large strands which orient themselves inversely to the bract bundle, and side by side enter the epimatium of the ovule (Pl. VII, Fig. 20; Diagram 3, C and D). In the rare cases where two ovules are present they are each supplied by a pair of bundles. The two strands now pass upward close together to the chalaza, where each sends a small bundle into the base of the ovule (Diagram 3, F) and then turns at an abrupt angle and passes downward, dying out near the micropyle. These two basipetal extensions go down on either side, directly opposite each other, and each lies just outside the lateral ridge of the integument. A median transverse section therefore shows two large dorsal bundles, close together, and two smaller lateral ones (Pl. VI, Fig. 18; Diagram 3, E). The xylem in all faces outward, and in the dorsal bundles, at least, often surrounds the phloem entirely. Many small strands, apparently of phloem,

enter the integument from the lateral bundles, and in some cases completely encircle the nucellus. The lower portion of the nucellus is attached laterally to the integument (Fig. 18; Diagram 3, E), but is otherwise free throughout. The integument, which becomes stony at maturity, is fused with the fleshy epimatium everywhere except along a rather narrow strip on its dorsal and ventral faces.

Only very young ovules of *P. vitiensis*, of the sub-genus *Nageia*, were available for study, but the general arrangement of the vascular tissues could be made out and agrees with that described by Miss Gibbs for the species.

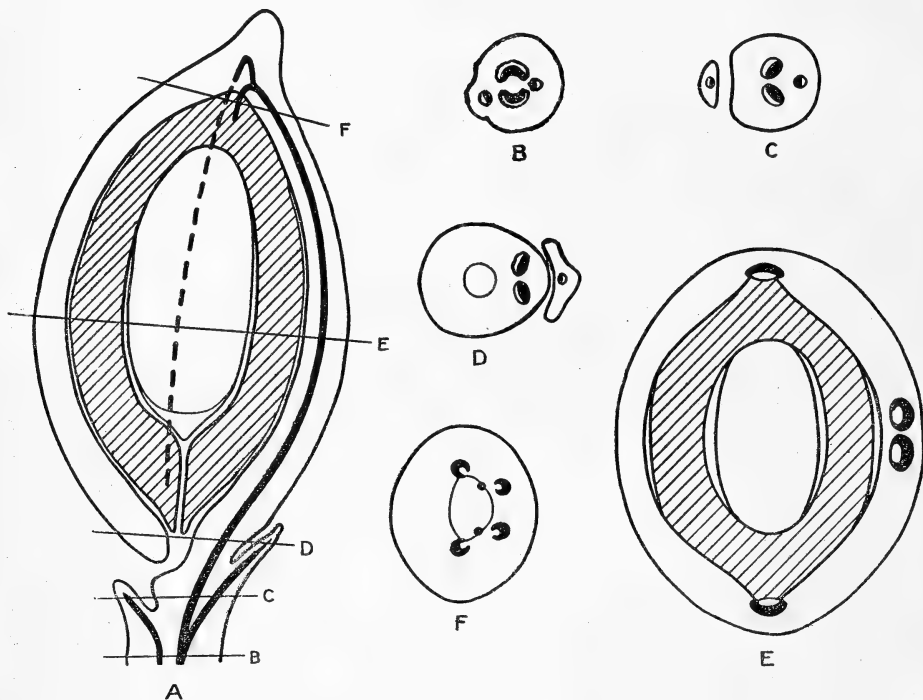

DIAGRAM 3. *Podocarpus ferrugineus*. A, vertical section through strobilus; B-F, successive transverse sections from axis to chalaza.

The reduced cone is similar to that of *P. ferrugineus* and bears a few sterile basal bracts and a single terminal ovule (Fig. 11). At the apex of the cone axis a bundle leaves the cylinder to supply the large fertile bract, in the lamina of which it branches into several parallel veins. The remainder of the vascular ring enters the base of the ovule, where it immediately divides into four bundles. These four—the two median ones close together, the two lateral somewhat divergent—pass up the dorsal face of the epimatium, and at the chalazal end of the ovule enter an anastomosing vascular complex. From this they emerge in the downward direction as two small ventral strands and two larger ones, exactly lateral. Several small bundles enter

the base of the ovule from the chalazal complex. In the general disposition of the vascular supply to its ovule, *P. vitiensis* is intermediate between *P. elatus* and *P. ferrugineus*.

The only other species of *Podocarpus* under investigation, *P. dacrydioides*, is a member of the section *Dacrycarpus*, which is distinguished from the rest of its genus by the fact that the bract is fused to the dorsal face of the ovule. The cone is very much reduced and its short thick axis, becoming fleshy at maturity, bears two opposite bracts, in the axil of one of which and adnate to it is the inverted ovule (Figs. 12, 13, and 14; Diagram 4, A). The vascular cylinder of the axis gives off a strand to each of the two bracts

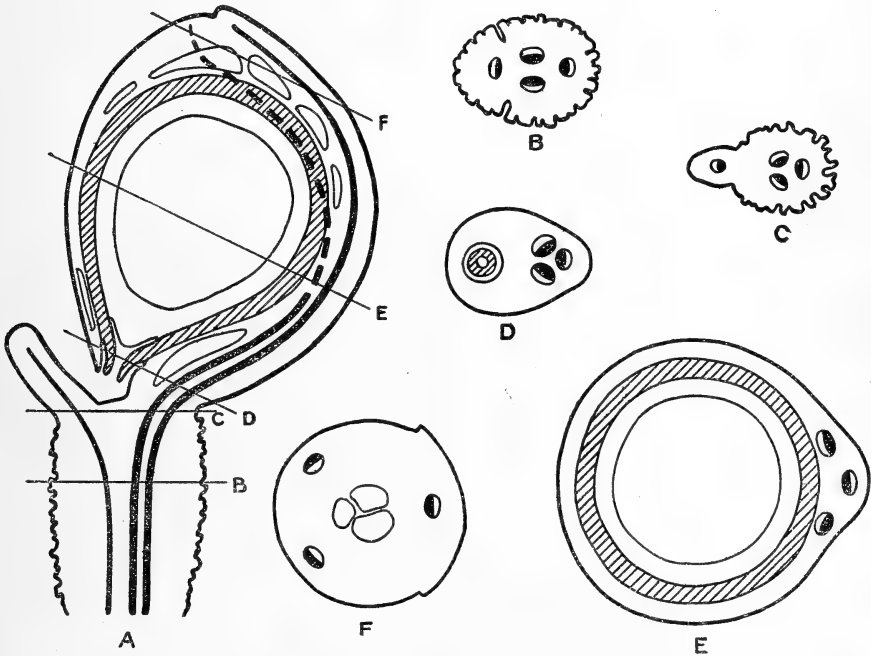

DIAGRAM 4. *Podocarpus dacrydioides*. A, vertical section through strobilus; B-F, successive transverse sections from receptaculum to chalaza.

(Diagram 4, B and C), and the two large bundles which remain approach each other, xylem outward, and enter the base of the epimatium (Diagram 4, D). At first these two lie near the bract bundle (Diagram 4, E), but they gradually diverge, and on approaching the chalaza separate rapidly, passing across the ovule, one on either side, to its ventral face (Diagram 4, F). Here they again converge, send downward a few weak bundles, and then pass upward a little way before dying out. The bract bundle disappears near the end of the bract, which in the young cone projects some distance beyond the ovule (Figs. 13 and 14) and is readily distinguishable from it, but which at maturity is so intimately fused with the leathery epimatium as to be almost

indiscernible. The nucellus is free only at its very apex from the integument, which is fused with the epimatium throughout.

Although the four sub-genera of *Podocarpus* differ from one another considerably in the structure of the female strobilus, they agree in possessing an inverted ovule with integument and epimatium closely united. The genus *Dacrydium*, however, includes one group of species in which the ovule is inverted and another in which at maturity it is almost erect, but in all cases the integument is entirely free from the epimatium and the nucellus from the integument. The ovulate cones of four species of *Dacrydium* were

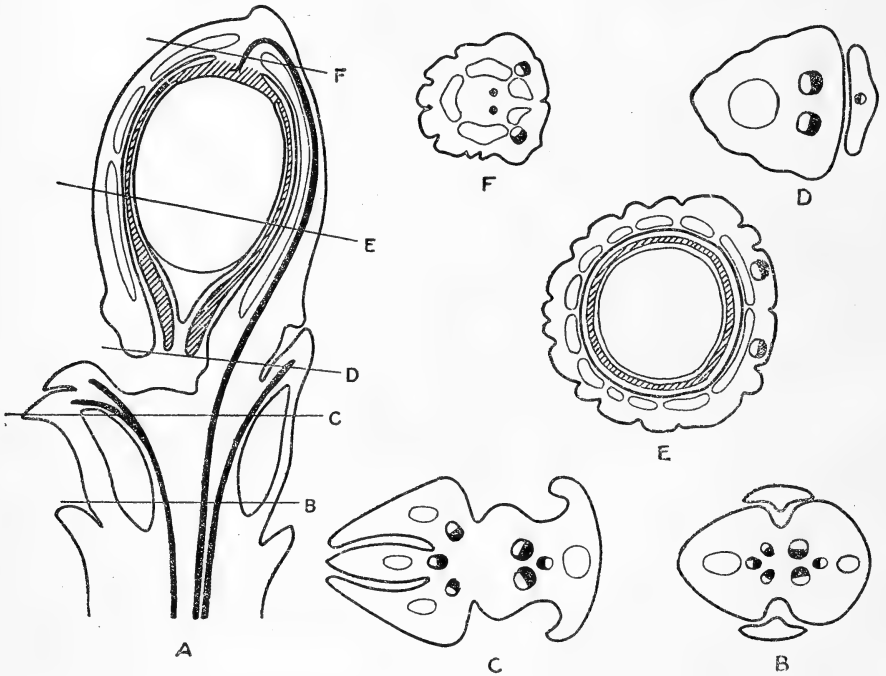

DIAGRAM 5. *Dacrydium Bidwillii*. A, vertical section through strobilus; B-F, successive transverse sections from axis to chalaza.

investigated—*D. Bidwillii*, *D. cupressinum*, *D. Colensoi*, and *D. intermedium*. Only in the first two were mature ovules obtainable.

*D. Bidwillii*, with two other New Zealand species, agrees with *Podocarpus* in the possession of an inverted ovule. The much reduced cone consists of a very short branch with a number of bracts at its base much resembling the scale-like vegetative leaves and one or two axillary inverted ovules at its apex (Pl. VII, Fig. 21; Diagram 5, A). The vascular supply of the cone, as in *Podocarpus*, is a ring of bundles and canals from which a small strand departs to each bract (Diagram 5, B). This is followed, in the case of the fertile bracts, by two bundles which fuse by their adaxial ends and



thus inversely oriented, depart into the base of the epimatium (Diagram 5, C and D). The two component parts of this strand soon separate and diverge considerably as they proceed up the dorsal face of the ovule (Diagram 5, E). At the chalaza each sends down a small concentric bundle into the base of the ovule (Fig. 22; and Diagram 5, F) and then dies out. The nucellus is entirely free from the integument, as is the integument from the epimatium (Diagram 5, A). The latter is strongly ribbed and well provided with large sac-like canals. It ripens dry and hard, save for a thickened corky ring at the micropylar end, which acts as an absciss layer.

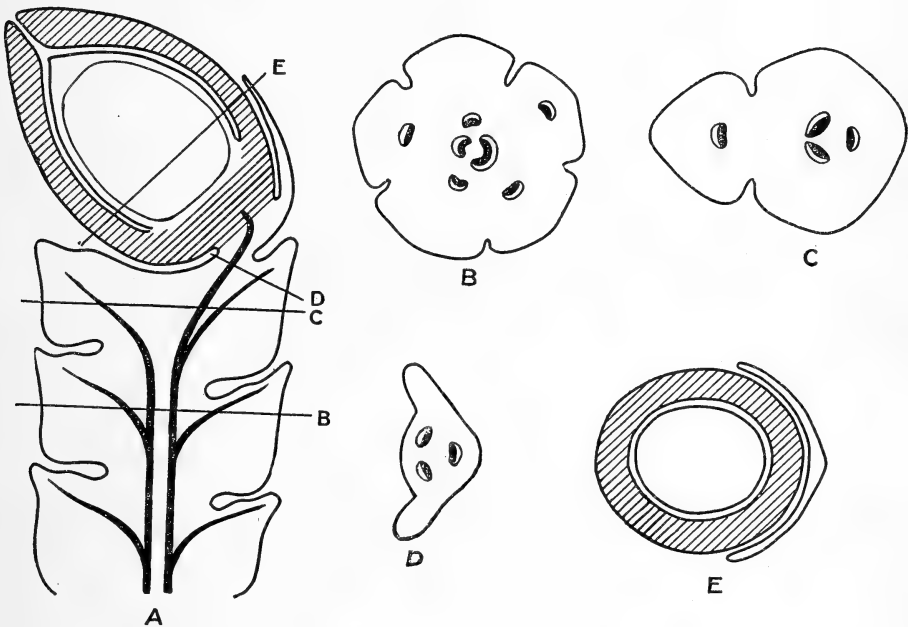

DIAGRAM 6. *Dacrydium cupressinum*. A, vertical section through strobilus; B-E, successive transverse sections from axis to ovule.

*Dacrydium Bidwillii*, from its close resemblance in strobilar anatomy to *Podocarpus*, may therefore well be considered an intermediate form between the latter genus and the other members of *Dacrydium*.

The rest of the genus *Dacrydium* show a similarly reduced condition of the cone, with a few sterile bracts at the base and a few fertile ones above. The young ovules, which were examined only in *D. Colensoi* and *D. intermedium*, are distinctly inverted, and the epimatium, with a knob or knee at its chalazal end just as in most species of *Podocarpus*, is entirely free from the integument, but at an early stage encloses it completely (Fig. 23). In subsequent growth, however, the outer coat is outstripped by the rest of the

ovule, which is eventually forced up into a partially erect position (Diagram 5, A). At maturity the bract is difficult to make out, and the epimatium appears as merely a thin sheath around the lower third of the ovule. The vascular system of the mature cone, investigated only in *D. cupressinum*, is at its base very similar to that of *D. Bidwillii* (Diagram 6, B). The base of the ovule has been left very near the apex of the cone, and the two bundles to the ovule, which fuse and become inversely oriented as in other cases, pass directly into the chalaza after a very short course in the base of the epimatium (Diagram 6, C and D). The integument is entirely free from the nucellus (Diagram 6, E), and since it is now the only protective coat of the ovule, it is much firmer than in the other members of the Podocarpaceae which we have examined, and has become differentiated into two layers, a narrow but very firm outer one of heavy-walled stone cells, and a less rigid, thinner-walled one within. These seem to correspond with the hard and soft layers in the ripe integument of *Eupodocarpus*.

The resemblance in structure and orientation to the seed of *Podocarpus* which is displayed by the young ovules of this section of *Dacrydium* suggests that we have here to do with an instance of recapitulation, and that the erect and naked condition of the ovule at maturity is not primitive, but has been recently acquired.

This description of the anatomical features of the female strobilus of *Podocarpus* and *Dacrydium* agrees in most particulars with the observations of Van Tieghem, Strasburger, Stiles, Miss Gibbs, and others. The marked structural resemblance between the cone of these genera and that of the Abietineae is noteworthy and will be discussed more fully under our consideration of the relationships of the Podocarpaceae.

*Saxegothea* and *Microcachrys* were not investigated by the writer, but good accounts of the strobilar anatomy of the two genera have been published by Thomson (17), Tison (18), and Stiles (11).

The female cone in *Saxegothea* consists of a considerable number of spirally arranged fertile bracts above and of numerous sterile ones below, which pass gradually into the vegetative leaves. The whole structure is thus more cone-like in appearance than anything we have yet described in the family. Each fertile scale bears near its base a single ovule which is semi-erect from the first and is provided with a thin epimatium entirely separate from the integument. Tison calls attention to the dissimilarity in structure between the tissue just below the insertion of the ovule (and of which the epimatium is obviously a continuation) and that of the rest of the bract. From the vascular supply of the cone axis, which is formed by a ring of bundles and is surrounded by a row of cortical canals, a single vascular strand passes off to each bract whether sterile or fertile (Diagram 8, E). In the case of the latter, however, two bundles, one from each end of the foliar

strand, are soon cut off, and rotating through an angle of  $180^\circ$ , assume an orientation inverse to that of the parent bundle. In the simplest cases, these two bundles, without further division, pass into the base of the ovule. According to Tison, a third median bundle is usually formed, and in several cases this 'upper series' was found to be composed of five bundles, only two of which entered the ovule. The bract supply also often divides into a series of strands, of which only one persists to the end.

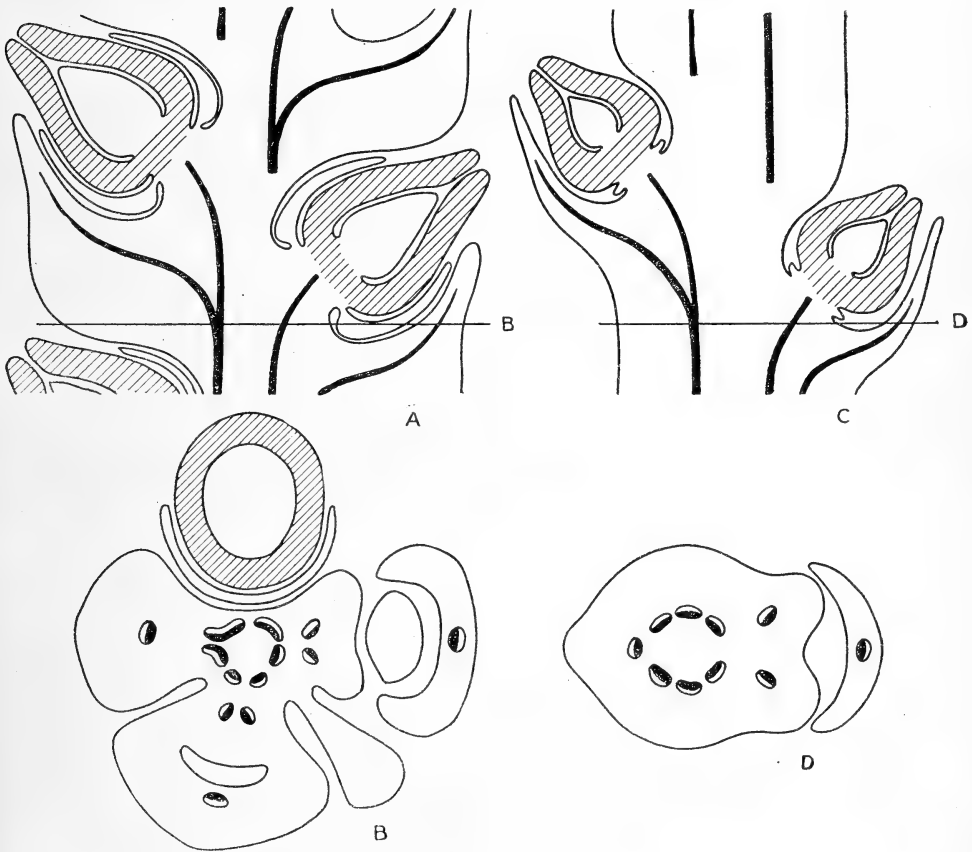

DIAGRAM 7. *Phyllocladus glaucus*. A, vertical section through portion of strobilus; B, transverse section. *Cephalotaxus*. C, vertical section through portion of strobilus; D, transverse section.

Attention will be directed later to the resemblance between the megasporophyll of *Saxegothea* and those of other Conifers, such as *Athrotaxis*, in which reduction has undoubtedly taken place.

Conditions in *Microcachrys* are very similar to those in *Saxegothea*, but are more simple. The cone-like female strobilus bears numerous fertile scales which somewhat resemble the small appressed vegetative leaves and

are continuous with them. A poorly developed epimatium surrounds the partially erect ovule. A single bundle departs from the axis to the fertile bract, and from its ventral side is given off a solitary strand with inverse orientation, which soon divides into two and enters the base of the ovule (Diagram 8, D).

Three species of *Phyllocladus* were investigated by the writer: *P. glaucus*, *P. trichomanoides*, and *P. alpinus*. In the last two, the female cone consists usually of one or two fertile bracts in a rather spherical head, but in *P. glaucus* there are from ten to twenty bracts, and they are arranged spirally. In all three species the short stout bract bears at its base a single erect ovule, the lower half of which is surrounded by a symmetrical papery epimatium, late in developing (Diagram 7, A). The vascular system of the cone axis consists of a cylinder of bundles which sends forth a single strand to supply each bract (Diagram 7, B). From the sides of the gap, as in *Podocarpus*, arise two bundles which orient themselves inversely and pass directly into the base of the ovule. The integument is entirely free from the nucellus and from the epimatium, and is differentiated into two layers, an outer sclerotic one and an inner one less firm in texture.

Discussion of the morphological significance of the strobilar anatomy in the Podocarpaceae will be reserved until after an account of the development of the male and female gametophytes and of the embryo.

#### MALE GAMETOPHYTE.

The important facts in the history of the male gametophyte of the Podocarpaceae are now comparatively well known, and the main result of the present investigation has therefore been to confirm previous observations and to extend them to a few more species. Material for study was available of the early stages of the male gametophyte in *Podocarpus japonicus* and *P. macrophyllus*; of mature or nearly mature pollen, and usually of tube formation, in *P. Totara*, *P. spinulosus*, *P. spicatus*, *P. ferrugineus*, *P. dacrydioides*, *Dacrydium intermedium*, and *D. cupressinum*, and of almost everything from archesporium to the formation of male cells in *P. Hallii* and *P. elatus*.

The sporogenous cells are thin walled and have large nuclei. They are first differentiated when the sporophyll is very small and increase rapidly in number as the sporangium grows larger. Around the sporogenous tissue is eventually developed a narrow tapetum, and the sporangium wall outside this consists of a few rows of thin-walled cells and of a very stout, much thickened epidermis. The microspore mother-cells are eventually rounded off, and each divides into a tetrad of spores.

The development and structure of wings on the microspore was carefully observed, for their presence is one of the most important features of the pollen of the Podocarpaceae, and serves to distinguish the family from

all other Conifers save the Abietineae. Two large wings on each spore were found throughout the sub-genera *Eupodocarpus* and *Stachycarpus*. The occurrence of three wings in *Podocarpus dacrydioides*, which had previously been reported, was found to be the normal condition for this species, though four were occasionally present. The wings here are somewhat smaller in proportion to the grain than in the other sub-genera. The mature pollen of *Dacrydium intermedium* shows two well-developed wings, but in *D. cupressinum* they are very much reduced in proportional size, and have a wrinkled and shrunken appearance (Pl. V, Fig. 6 and Pl. VII, Fig. 24). In this species, however, young pollen-grains with but a single nucleus were occasionally found in the nearly ripe sporangia, and these were distinguishable by the possession of two wings large in proportion to the size of the spore and of the normal *Podocarpus* type (Fig. 5). The more rapid growth of the spore finally results in their partial obliteration. The pollen of *Microcachrys* as described by Thomson has normally three wings, but occasionally four, five, or six. In *Saxegothea* they are altogether lacking. The microspore of *Phyllocladus* shows two wings, irregular in shape and much reduced. It seems entirely probable, as we shall endeavour to show, that the wings in the Podocarpaceae are the exact homologues of similar structures in the Abietineae, and that their absence or poor development in certain genera and species is due to reduction.

The details of gametophytic development agree with those reported in previous accounts. Two prothallial cells are cut off and persist, giving rise to a varying amount of vegetative tissue. In the mature grain of *Podocarpus* this usually consists of from six to eight cells, and there are in addition a stalk and a body-cell and a tube nucleus. All of these except the body-cell are eventually represented by free nuclei, among which the tube and stalk nuclei are usually indistinguishable. In *Dacrydium cupressinum* there are from four to six, but in *D. intermedium* never more than four, prothallial cells and vegetative nuclei.

The germination of the pollen-grain was observed in *P. Totara*, *P. Hallii*, *P. elatus*, *P. ferrugineus*, *P. spicatus*, *P. dacrydioides*, and *Dacrydium cupressinum*. Into the tube as it penetrates the nucellus passes the procession of free nuclei, which here lose their spherical shape and become considerably elongated. The body-cell, conspicuous by its size, is the last to leave the pollen-grain and migrates slowly down through the nucellar tissue (Pl. V, Fig. 4). Just before fertilization its nucleus divides into two, of which one is naked, and the other, destined to unite with the egg, is surrounded by a dense body of cytoplasm (Pl. IX, Fig. 50). In *Stachycarpus* these male cells are buried close to the neck of the archegonium by the growing endosperm (Pl. V, Fig. 2).

## THE FEMALE GAMETOPHYTE AND EMBRYO.

Our knowledge of the female gametophyte and embryo of the Podocarpaceae has up to the present been practically confined to the results of investigations by Miss Young (21) on *Phyllocladus alpinus*, by Coker (2) on *Podocarpus coriaceus*, and by Stiles (13) on *P. latifolius* and *P. macrophyllus*, and to the fragmentary observations of Miss Gibbs (4) on several other species of the genus. It is now possible to add to this an almost complete account of the history of the macrogametophyte and embryo of *Podocarpus Totara*, *P. nivalis*, *P. ferrugineus*, *P. spicatus*, *P. dacrydioides*, and *Dacrydium cupressinum*, together with considerable information concerning *P. elatus*, *P. spinulosus*, *P. vitiensis*, and *D. Bidwillii*.

In *Eupodocarpus* only a few months elapse between the appearance of the young female cones and the ripening of the seed, but the length of the period, besides being subject to a considerable amount of specific and individual variation, depends also on climatic influences. It is very much shorter in the case of *P. nivalis* from the Southern Alps of New Zealand than in *P. elatus* from sub-tropical Queensland. The development of *P. Totara* in the North Island of New Zealand may be taken as fairly typical. Here the female cones are noticeable early in October, and pollination occurs about the middle of the month. The ovules reach nearly two-thirds of their mature size by the latter part of November, when fertilization takes place, and the seeds ripen in February.

While the ovule is very small the megaspore mother-cell becomes differentiated from the rest of the nucellus by its greater size (Pl. VII, Fig. 25). Its very large nucleus soon divides, as do the nuclei of the two resulting cells, and a linear tetrad of megaspores is thus formed, although there are sometimes but three owing to the failure of one of the daughter cells to divide. Three of the four spores, usually those towards the micropyle, become abortive, and the single remaining one germinates to form the gametophyte. The occurrence in the mature ovule of two embryo-sacs, from the germination of two spores, was observed rather frequently in most of the species.

In all members of this sub-genus a group of uninucleate, densely protoplasmic cells makes its appearance around the megaspore mother-cell, and later becomes a conspicuous layer of 'spongy tissue' surrounding the spores and the developing embryo-sac (Fig. 26). Whether or not this corresponds strictly to a true tapetum, its function is surely to nourish the growing spore. The absence of spongy tissue has been reported by Coker in *P. coriaceus*, but its presence has been noted in all other members of the sub-genus investigated by other writers.

The details of spore germination are very much as in other Conifers. The nucleus soon divides and the resultant nuclei, which in their turn

multiply rapidly, come to lie against the wall, the centre of the gametophyte being filled by a large vacuole. For the immediately succeeding stages, information is available only in the cases of *P. Totara* and *P. Hallii*. In these species the vacuolated sac becomes lined with hundreds of free nuclei before wall-formation begins. The first walls isolate each nucleus from its neighbours and leave it in a distinct compartment, but in free communication with the vacuole. The nucleus lies at the inner end of this compartment, and is connected by protoplasmic fibrils with the edges of the inwardly growing walls, which eventually meet at the axis of the gametophyte. The sac is thus filled with radiating tubular 'alveoli' which are rarely interrupted by transverse walls. The division of each alveolus into a row of cells, however, takes place rapidly after the cessation of centripetal growth, and the gametophyte thus becomes a body of thin-walled uninucleate cells arranged in rows radiating from its centre. The spongy tissue disintegrates as the embryo-sac reaches its full size, but a very well-developed megaspore membrane, thick basally but becoming thinner over the apex, is laid down around the gametophyte (Pl. VI, Fig. 7).

The history of the female gametophyte and embryo of *Eupodocarpus* from this point onward was studied in *P. Totara*, *P. Hallii*, and *P. nivalis*, and is practically identical in the three species.

The archegonia appear soon after the sac is filled with tissue, and occur in an apical group of three to six (Fig. 7). As many as fourteen have been noted by Stiles in *P. latifolius*. They are arranged roughly in a circle, but are rarely or never grouped, always being separated from one another by one or more rows of cells.

Each archegonium arises from a superficial cell, which soon divides periclinally into a primary neck-cell and a primary central cell. The neck-cell is unchanged for some time, but the central cell, growing rapidly, becomes much elongated, and is filled with thin, vacuolate contents. The nucleus remains at the upper end, just below the neck. No further changes take place until the archegonium reaches its full size, when three deeply staining centres of radiating protoplasmic strands appear in the central cell, one at the base, one near the middle, and one just below the nucleus at the apex (Pl. VII, Fig. 27). Between the lowest two of these 'asteroids' arises a large vacuole. The primary neck-cell has meanwhile divided anticlinally or obliquely into an irregular group of cells. One row of jacket cells, distinguishable from the surrounding gametophyte tissue by their more dense contents and large nuclei, one or two in number, becomes differentiated around the central cell.

The nucleus of the central cell now undergoes division into egg nucleus and ventral canal nucleus, and although the actual mitosis was not observed, the two small resulting nuclei were several times seen in the upper portion of the cell. The egg nucleus remains for only a very brief time in this

position, but almost immediately drops to the centre of the archegonium just above the large basal vacuole (Fig. 28). The three asteroids now disappear. The ventral canal nucleus may immediately go to pieces, may persist unchanged for a time (Fig. 29), or may more rarely increase to nearly or quite the size of the egg nucleus itself. A definite ventral canal cell was never observed, nor were there indications of the subsequent activity of the ventral canal nucleus reported by Coker.

While the archegonia are thus reaching their mature development the other cells of the gametophyte are also dividing, and the embryo-sac at the time of fertilization has attained two-thirds or more of its final size. The nuclei of the endosperm cells are at first large, but after repeated cell-divisions decrease considerably in size. A narrow cone-shaped patch of tissue extending from the archegonial region to a little below the centre of the embryo-sac is composed of smaller and squarer cells with more protoplasmic contents than the others, and with several large nuclei. The multinucleate condition extends also to a few of the other endosperm cells, but at this stage most of them possess only a single nucleus.

The archegonia are now ready for fertilization and the pollen-tubes, which for over a month have been coming down through the nucellus, expand over the top of the embryo-sac and often burrow into it to some extent. A branch of the tube, entering and breaking through the neck of an archegonium, is closely followed by the two male nuclei. The functional one, surrounded by a layer of dense cytoplasm, is about half the size of the egg nucleus itself, which it immediately approaches, and to which it becomes closely pressed. At this time the second male nucleus and several of the accompanying prothallial nuclei may be observed in the upper portion of the archegonium (Pl. V, Fig. 1). The contents of both sexual nuclei are granular, and the two are very similar in other details. The male, which is much flattened against the female, is for some time separated from it by a limiting membrane, but this eventually breaks down and the resulting fusion nucleus soon prepares to divide.

The first mitosis takes place in the position of the egg nucleus, and the two small daughter nuclei, accompanied by most of the dense cytoplasm of the egg, migrate to the base of the archegonium and increase greatly in size. Each soon divides again (Pl. VII, Fig. 30), as do the four which result, so that eight rather large free nuclei, irregularly arranged, fill the lower portion of the archegonium. Each of these again divides, and the resulting sixteen become separated from one another by the first-formed walls of the pro-embryo (Fig. 31). The cells are arranged in three tiers: a single binucleate cell at the very base, which will form the embryo, a suspensor tier of from seven to nine cells above this, and a rosette tier at the very top of a few cells which soon go to pieces. The suspensors now begin to elongate (Pl. VIII, Fig. 32) and to push the embryo cell, protected by a thick cellulose



cap (Pl. VII, Fig. 31), down into the endosperm. The details of proembryo formation are thus somewhat different from those reported by Coker for *P. coriaceus*, where there are fourteen suspensors and fourteen rosette nuclei.

The cells of the 'cone' into which the embryo is now pushed are packed with starch. Most of the remaining tissue of the embryo-sac becomes multinucleate at this time. The endosperm soon reaches its full size, and often grows up over the archegonia to some extent. Several of the archegonia usually remain unfertilized, and their nuclei may either go to pieces directly or first become broken up amitotically into many unequal fragments.

The embryo cell, which is pushed far into the endosperm before it shows signs of multiplication, divides first by a longitudinal wall and then by transverse ones. Instances of budding or of single suspensors giving rise to embryos were only rarely observed. One embryo eventually outstrips the others and is the only one to reach maturity. All the cells of the endosperm now become filled with starch, and in their midst lies the developing dicotyledonous embryo (Pl. VIII, Fig. 33).

The marked resemblance between *Eupodocarpus* and the Abietineae in the development of the female gametophyte and embryo, and the equally strong dissimilarity between this sub-genus and the Araucarineae, deserve emphasis, and are of much importance in determining the affinities of the Podocarpineae.

*Podocarpus dacrydioides*, the only member of the sub-genus *Dacrycarpus* under investigation, resembles *Eupodocarpus* in the completion of its entire reproductive cycle in a single season. The young female cones, in the North Island of New Zealand, first become noticeable early in October and are pollinated about the middle of the month. Fertilization probably occurs at this latitude in late November or early December, but all subsequent stages of this species were obtained in the extreme south of the South Island, where the season is undoubtedly much later, and here fertilization was found to take place in the latter part of January and the fruit to mature in February and March.

The megaspore mother-cell appears while the ovule is still very small, and is surrounded by a zone of spongy tissue which is not so well developed as in *Eupodocarpus*. The mother-cell gives rise to a linear tetrad of which usually only one spore germinates, although the frequent occurrence of two embryo-sacs in the ovule indicates that this is not always the case. The early stages of the gametophyte resemble those of *Eupodocarpus*, and consist of an enlarging vacuolate sac lined with nuclei. The subsequent centripetal growth of endosperm could not be traced, for this had already taken place in the next later material examined. Most of the young endosperm cells have but one nucleus, except in the cone-shaped region below the archegonia, where they are multinucleate. A megaspore membrane is present around the embryo-sac, but is much less well developed than in *Eupodocarpus*.

The archegonia are from five to twelve in number, and occur in a circle around the apex of the gametophyte, but are never directly adjacent to one another (Pl. VI, Fig. 12). Each arises from a superficial cell which divides periclinally into primary neck-cell and primary central cells. The latter, which rapidly becomes elongated, has at first a very thin and foam-like contents filled with many small vacuoles, but no structures comparable to the 'asteroids' of the young central cell of *Eupodocarpus* were observable. One row of uninucleate, or binucleate, densely protoplasmic jacket cells becomes differentiated around the archegonium.

The small nucleus remains in the upper portion of the central cell until it has divided into egg and ventral canal nuclei, after which the egg nucleus drops to about the middle of the archegonium and becomes surrounded by a conspicuous layer of dense cytoplasm (Pl. VIII, Fig. 34). The ventral canal nucleus, even if it is always formed, must usually go to pieces immediately. In the comparatively few cases where its presence could be determined, it was almost always as large as the egg nucleus itself, and the two were lying close together (Fig. 35). The many small vacuoles now coalesce into a single large basal one, and the cytoplasm of the egg becomes of uniform density throughout. Meanwhile the primary neck-cell has divided first anticlinally and then periclinally into a neck two or three tiers of cells in height. The endosperm grows up over the archegonia to such an extent as to leave the neck at the bottom of a small pit, or even sometimes to close it over entirely and prevent the access of a pollen-tube.

In the details of fertilization, formation of the embryo, and history of the endosperm this species agrees almost entirely with *Eupodocarpus* (Figs. 36, 37, and 38), but the embryo-sac is much wider and more nearly spherical, and its cells, beginning with a few towards the outside at the time of fertilization and increasing rapidly in number until they include almost all the endosperm, become completely filled with a mucilaginous contents (Fig. 38).

The female gametophyte of *Podocarpus dacrydioides* differs chiefly from that of *Eupodocarpus* in the poorer development of spongy tissue and megaspore membrane, in the absence of asteroids in the central cell, in the presence of a dense cytoplasmic sheath around the egg nucleus, and in the occurrence of mucilaginous contents in the endosperm cells.

The sub-genus *Stachycarpus*, however, is distinct from the two preceding groups in the structure and development of its female gametophyte and embryo. *Podocarpus spicatus* and *P. ferrugineus*, the only species examined, were found to be very similar.

The reproductive cycle covers a period of nearly eighteen months. Young female strobili appear early in October, and are pollinated two or three weeks later, but the embryo-sac, which attains considerable size, is not ready for fertilization until a year from the next January. Ripe fruit is produced in March.

The megaspore mother-cell is distinguished early by its rapid increase in size and by its large nucleus. It gives rise to a linear tetrad of spores, of which the one nearest the base germinates (Pl. VIII, Fig. 39). Two spores occasionally develop into gametophytes. Spongy tissue seems to be entirely absent (Pl. VI, Fig. 17 and Pl. VIII, Fig. 39), for the cells immediately surrounding the spores and the young sac possess no dense protoplasmic contents and are not distinguishable in any way from the other tissue of the nucellus. Except for this absence of spongy tissue the young gametophyte conforms to the usual coniferous type.

The next stages obtainable, shortly after the endosperm had completed its centripetal growth, showed it to be composed of uninucleate cells and surrounded by a strongly developed megaspore membrane. The embryo-sac of *P. spicatus* is approximately spherical in shape and about half as large as that of *P. ferrugineus*, which is slightly obovate and nearly twice as long as broad.

The archegonia appear early, while the sac is less than half its final size, and are usually two in number, though three sometimes occur. Each archegonium arises from a superficial cell, which divides into neck-cell and central cell. The latter becomes greatly elongated and the mature archegonia are often 2 mm. in length, perhaps the largest among vascular plants. The nucleus remains near the neck and the contents of the central cell are thin, vacuolate and without asteroids. A single layer of jacket cells becomes sharply differentiated, and its members, uninucleate at first, soon contain several nuclei. The primary neck-cell divides anticlinally into a rosette of from eight to twelve cells, and this single tier is the final condition of the neck.

Meanwhile the endosperm has increased greatly in size and at the apex has grown up around the necks of the archegonia and enclosed the ends of the waiting pollen-tubes and the male cells which are destined to effect fertilization (Pl. V, Fig. 2 and Pl. VIII, Fig. 40). Any archegonium towards the neck of which no pollen-tube has by this time approached is now entirely sealed over by the sterile gametophytic tissue and prevented from being fertilized. A cone-shaped region below the archegonia, especially long and narrow in *P. ferrugineus*, is early differentiated as in the other species by its smaller and more rectangular cells and by the many nuclei which they contain. The remaining cells of the embryo-sac become multinucleate before fertilization, and the number of nuclei in each cell seems to be considerably greater than in the other two sub-genera.

As the central cell approaches maturity its nucleus divides into egg and ventral canal nuclei (Figs. 2 and 41). The latter may immediately go to pieces or may persist for some time, and in rare cases increase considerably in size. The egg nucleus sinks but slightly below the neck, always remaining in the upper quarter of the archegonium, and now grows very large (Figs. 2 and 40). It has loosely granular contents and is usually surrounded

by a cytoplasmic sheath. The contents of the egg itself become much more dense and contain a few rather small vacuoles, but nothing corresponding to the large basal one of the other species. Dense angular bodies, probably protein in nature, are scattered through the cytoplasm. The wall of the egg is much thicker than in other members of the genus and is full of large sieve-like pits opposite the jacket cells. There are now two or three rows of the latter instead of only one.

The act of fertilization was not observed, but the larger of the two male nuclei, which is surrounded by a cytoplasmic body and is doubtless functional, is about half the size of the egg nucleus. The figure of the first mitosis is very small, and occurs within the nucleus (Fig. 42), which now loses its membrane and becomes irregular in shape but remains in its original position until after the second mitosis. The four nuclei which result from this lie close together and surrounded by a sheath of dense cytoplasm drop slowly towards the bottom (Fig. 43), followed by much of the contents of the egg. Above them develops a large vacuole (Fig. 44), separating the basal, proembryonic region of the archegonium from its upper sterile portion. Nuclei often are present in this upper part, and though some of them may perhaps be derived from the ventral canal or second male nuclei, it seems much more likely that they are all jacket-cell nuclei, for these are often seen breaking through into the archegonium as it begins to go to pieces.

The four nuclei of the proembryo now divide and eventually give rise to about sixteen, which are crowded irregularly into the very narrow base of the archegonium (Pl. IX, Fig. 45). At this time walls are first formed. Some of the cells immediately undergo division, and the regular number and arrangement found in the proembryos of other species is not observable here. The rosette tier is very poorly developed, and almost immediately goes to pieces. The suspensors are usually nine in number and often cut off cells from their upper ends. The embryogenous tier consists not only of a large binucleate terminal cell, as in the other members of the genus, but of a group of cells between it and the suspensors. This group is small at first, but its members immediately begin to divide, and in *P. spicatus* may number from twenty to forty before the suspensors elongate to any extent (Fig. 46). In *P. ferrugineus* there are rarely more than eight or twelve cells in this tier (Fig. 47) until it has been pushed far into the endosperm. In the former species, the terminal cell, long, pointed, and often serving for a time as a protecting cap, is usually sloughed off. In *P. ferrugineus* the apical cell is blunter, but is provided with a thickened tip and almost always persists. The embryos show no signs of budding and are forced far down into the sac, where they begin a rapid growth. The later development of the embryo could not be followed, but it doubtless becomes dicotyledonous, as in the rest of the family. Starch is laid down in the axial region immediately after fertilization and is soon deposited throughout the whole endosperm.

The female gametophyte and embryo of *Stachycarpus* thus differ in several important particulars from those of the other sub-genera of *Podocarpus*. The reproductive cycle is extended through two seasons; there is a very slight development of spongy tissue; the number of archegonia is much reduced, but their size is greatly increased; the neck is composed of but a single tier of cells; the first two embryonic mitoses take place in the upper portion of the archegonium, and the embryo almost from the first is composed of a body of cells instead of one. Several of these features are shared by the genus *Dacrydium*, but a still more striking resemblance is presented by the female gametophyte and embryo of *Cephalotaxus*.

The only material at hand for a study of the female gametophyte in the sub-genus *Nageia* was some very young ovules of *P. vitiensis*. The embryo-sac in these was still very small, but was surrounded by a layer of spongy tissue, distinct but not as strongly developed as in *Eupodocarpus*.

In the genus *Dacrydium* material was available for the study of the early stages of the female gametophyte in *D. Colensoi* and *D. intermedium*, two closely related species. The later history was investigated in *D. cupressinum*, and some information was also obtained as to the structure of the mature archegonium and the development of the embryo in *D. Bidwillii*.

In that portion of the genus represented by this last species the reproductive cycle is apparently completed in a single season, for in the Southern Alps in February there seemed to be but one generation of ovules, and these contained young or mature embryos. In *D. cupressinum* and its related species, however, tiny ovules which are just being pollinated are visible on the same branches with those of the previous year, which have reached their full size and in which fertilization and the development of the embryo is taking place. The life-history of this species therefore extends through two seasons, as in *Stachycarpus*.

The growth of the megaspore and its germination into a linear tetrad occur in very much the same manner in *Dacrydium* as in *Podocarpus*, but in the former genus there is a less conspicuous development of spongy tissue. The vacuole, lined with free nuclei, increases in size and is very early filled by the centripetal growth of endosperm tissue, which occurs before the embryo-sac has reached half its final size. The endosperm cells at first contain but a single nucleus. A cone of multinucleate and more densely protoplasmic cells soon appears below the archegonial region, and by the time of fertilization there are several nuclei in every cell of the embryo-sac. The prothallial tissue often grows up over the archegonia.

The latter appear while the sac is still very small, and in *D. cupressinum* are three in number at the apex of the gametophyte, each arising from a superficial cell and separated from the others by sterile tissue. The initial cell soon divides into primary neck and central cells. The former

divides anticlinally, but the mature neck is never more than one tier in thickness. The central cell, which elongates greatly and becomes filled with thin, vacuolate contents, is surrounded by a single row of uninucleate jacket cells. Its cytoplasm gradually grows more dense and displays at least one 'asteroid', which is associated with the nucleus in the upper portion of the archegonium (Fig. 48). A large basal vacuole also develops. The nucleus of the central cell, while still just below the neck, divides into ventral canal and egg nuclei. The former eventually goes to pieces, but the latter drops a little way into the cytoplasm and increases greatly in size, until it almost fills the top of the archegonium.

The male nuclei resemble those of *Podocarpus*, one being naked and the other surrounded by a mass of cytoplasm. Fertilization was not observed, but the development of the proembryo was followed and agrees with that described for *Eupodocarpus*. The young embryo, however, as it is carried down by the suspensors invariably buds or divides, and single suspensors often develop embryos (Fig. 49).

There are two archegonia in the embryo-sac of *D. Bidwillii*, and they are somewhat sunken in the endosperm (Pl. V, Fig. 3). Each is surrounded by one layer of jacket cells and has a neck but a single tier of cells in thickness. The egg nucleus is very large. Fertilization and the development of the proembryo were not observed, but the young embryos present in almost all the ovules examined much resemble those of *D. cupressinum*, and show a similar tendency to become subdivided.

*Dacrydium* resembles *Eupodocarpus* and *Dacrycarpus* in the development of the proembryo, and *Stachycarpus* in the small number of archegonia, the single tier of neck-cells, the large egg nucleus, and, in most species, the length of the reproductive cycle.

Our knowledge of the female gametophyte and embryo of *Phyllocladus* is due to the investigations of Miss Kildahl (6) and Miss Young (21) on *P. alpinus*.<sup>1</sup> The reproductive cycle in the genus extends through only a few months. Spongy tissue is conspicuous and there is a strong megaspore membrane. The archegonia are usually two in number, and are sunken in the endosperm. The neck is a rosette only one tier of cells in thickness. A ventral canal nucleus is present. There are at least eight nuclei in the proembryo before wall formation and the mature embryo is dicotyledonous. The endosperm cells are all multinucleate.

The structure of the female gametophyte and embryo of *Phyllocladus*, as far as it is known, agrees more closely with that of *Dacrydium*, especially in the reduced number of archegonia and the structure of the neck, than with that of any other member of the family.

<sup>1</sup> The writer was able to collect material in New Zealand illustrating the female gametophyte of *P. glaucus*, *P. trichomanoides*, and *P. alpinus*. The results of an investigation of these three species will be published in the near future.

## AFFINITIES OF THE PODOCARPINEAE.

## (a) Relationship to Abietineae and Araucarineae.

We must now discuss briefly the theories which have been proposed as to the affinities of the Podocarpineae, and consider what light is thrown on the phylogeny of the family by the present study of its reproductive structures.

The view of Celakovsky and his school that the Taxaceae, including the Podocarpineae, are closely related to *Ginkgo*, and are among the most primitive of the living Coniferales, has become entirely discredited since our knowledge of the female gametophyte in the Gymnosperms has grown more complete.

A much more reasonable theory, however, and one which apparently has a very wide acceptance at the present time, has been put forward by Thomson, Tison, Stiles, and others. These writers consider the Podocarpineae to have arisen from the araucarian Conifers through forms closely resembling *Saxegothea* and *Microcachrys*, and base their conclusions on the resemblance between these genera and the Araucarineae in the external features of the female cone, the development of the male gametophyte, the structure of the ovule, and the vascular anatomy of the ovuliferous appendage. They regard *Dacrydium*, and more especially *Podocarpus*, as advanced and specialized members of the family.

From this hypothesis the writer entirely dissents. After considering certain objections to the arguments on which it is based, he will endeavour to construct a line of evidence in support of the view that the genus *Podocarpus* is the most primitive member of the family; that it is nearly related to the Abietineae; that from ancient forms close to it the other genera of the Podocarpineae, and probably the Taxineae as well, have arisen through divergent lines of ascent, and therefore that instead of being derived from the typical araucarian Conifers the Podocarpineae may much more readily be traced back to the ancestral abietineous stock from which both families, Araucarians and Podocarps, along a somewhat parallel line of development, have been evolved.

The fact that the female strobilus of *Saxegothea*, *Microcachrys*, and *Pherosphaera* is well developed and composed of a considerable number of fertile bracts, in comparison to its reduced condition in most other members of the family, has been one of the main arguments brought forward to show the very primitive constitution of these three genera. The sub-genus *Stachycarpus* of *Podocarpus*, however, includes some species in which there are many fertile bracts, and others, closely related, where the female cone is reduced to a single ovule. *Phyllocladus glaucus* has a well-developed strobilus with from ten to twenty ovules, but there are only one or two in

the other New Zealand species of the genus. The degree of strobilar development may be extremely variable and is an unreliable criterion in determining affinities.

The gradual transition between fertile bracts and vegetative leaves in *Saxegothea* and *Microcachrys* has been compared with similar conditions in *Araucaria*, but since the same phenomenon occurs in *Cunninghamia*, *Cryptomeria*, and to a certain extent in other Conifers, it loses its significance.

The fact that the three genera in question which have well-developed cones consist of very few species and are limited in distribution has been emphasized by Stiles as an instance of the general principle that such restricted types are primitive. Dominance and widespread distribution in a group of plants are considered *prima facie* evidence for its recent origin, since the possession of more perfect adaptations gives it superiority over less favoured and therefore moribund ancestors. This argument is open to considerable criticism, for there is good reason to believe that many groups dominant to-day, such as the genus *Pinus*, are comparatively primitive. Unspecialized and plastic organisms, 'generalized types,' are more easily adapted to changing conditions, and therefore are often more widely distributed than those which are more 'advanced' and which through their higher degree of specialization and complexity are confined to a limited environment.

The occurrence in the pollen-grains of both Araucarineae and Podocarpineae of two primary prothallial cells which later undergo repeated division has also been cited as evidence of the affinity of these two families. This resemblance in the male gametophyte appears indeed most easily traceable to a common ancestry but to one which must have been abietineous in affinity, for the occurrence in *Ginkgo* and the Abietineae of pollen with but two prothallial cells makes it extremely probable that this is the primitive condition for all the Coniferales, and that the subsequent increase in prothallial tissue which takes place in the Podocarpineae and Araucarineae is a comparatively recent development and not the persistence of a primitive structure.

The entire absence of wings in the pollen of *Saxegothea* (8) and their somewhat irregular development in *Microcachrys* have led Professor Thomson (16) and others to believe that the winged condition in the Podocarpineae has arisen entirely independently from that in the Abietineae, and that the early stages in its development are represented in *Microcachrys*, where three, four, five, or six wings may be formed. The occurrence of both winged and wingless pollen in *Tsuga*, and the entire absence of wings in *Larix* and *Pseudotsuga* alone among the Abietineae, however, are almost certainly the results of reduction and loss, for these genera are surely not the most primitive members of their family. A similar explanation



in the case of the Podocarpineae seems much better than the one Professor Thomson proposes, and must clearly be correct if we consider *Podocarpus* as primitive and *Saxegothea* as specialized. The evidence from *Dacrydium cupressinum* bears out the reduction theory, for in this species there are two or three well-developed wings on the young spore, but these become withered and almost obliterated in the mature pollen, which thus approaches the condition found in *Saxegothea*. *Phyllocladus* is obviously a reduced and specialized genus, and its pollen wings show a correspondingly great reduction. *Podocarpus dacrydioides* with its three or four wings is intermediate between typical *Podocarpus* of two wings and *Microcachrys*, where the irregular development of these structures resembles more the behaviour of a vanishing character than of one just making its appearance. It seems therefore much more in accord with all the facts to consider the pollen of *Saxegothea* and *Microcachrys* as reduced rather than primitive in structure, and to regard the whole male gametophyte of *Podocarpus* as what it so obviously seems to be, a structure closely related to that of the Abietineae.

Certain features of the ovule common to Podocarps and Araucarians have been brought forward as indications of relationship between the two groups. The fact that cone scales bearing but a single ovule are almost entirely confined to these families is perhaps significant, but certain species of *Juniperus* show a similar condition, and it is well known that several ovules to each scale were commonly possessed by the ancient Araucarineae.

The stigma-like nucellar outgrowth described by Tison for *Saxegothea* has been compared to the slight protrusion of this portion of the ovule in *Araucaria*, but among other Podocarps anything comparable to it is entirely absent, and it seems a generic peculiarity with little significance.

*Dacrydium*, *Saxegothea*, and *Microcachrys*, in common with the Araucarineae, possess a nucellus entirely separate from the integument, and this has sometimes been considered a primitive feature and evidence for the relationship of the two groups. But the degree of fusion between integument and nucellus is a very variable character, as is shown, for example, by the sub-genus *Stachycarpus*, which has one species (*P. spicatus*) with the nucellus free only at the very tip, and another (*P. ferrugineus*) where it is almost entirely distinct from the integument. Freedom of the nucellus has also been attained in such widely separated forms as *Cunninghamia*, *Cryptomeria*, *Sciadopitys*, *Callitris*, and *Juniperus*, and its occurrence in the two families under consideration may therefore be best explained as the result of somewhat parallel but quite independent development.

The anatomy of the cone scale, however, has been most emphasized by supporters of the araucarian origin of the Podocarpineae, and since evidence derived from this source furnishes some of the strongest arguments for the writer's contentions as well, the subject is worthy of careful consideration.

The earliest accounts of vascular anatomy in the female cone of Conifers are in general more clear and comprehensive than those published more recently. Van Tieghem (19), in 1869, investigated the 'female flower' in everything from Cycadales to Gnetales, and was the first to apply anatomical criteria to the question of the morphology of the ovuliferous scale. Strasburger, in a number of his works, notably 'Angiospermen und Gymnospermen' and 'Coniferen und Gnetaceen', extended and amplified Van Tieghem's observations. A notable paper by Radais (9), and one which for some unaccountable reason seems to have escaped entirely the attention of subsequent writers on the subject, gives a clear account of some very careful and extensive investigations on the anatomy of the female cone, both young and mature, among the Abietineae, Taxodineae, and certain Araucarineae. The results obtained by these writers agree in emphasizing the fundamental similarity of the vascular supply to the strobilar appendage among all living Gymnosperms above the Cycadales. In every case the sterile leaf or bract subtends an axillary structure which is sometimes fused entirely with the bract, and is often much reduced, and which bears the ovule or ovules. This double appendage (leaf and scale) is supplied by a double vascular system from the central cylinder of the axis.

In *Ginkgo* a normal double foliar strand departs from the stele and passes into the subtending leaf. From each side of the gap thus caused springs a bundle, and these two, each of which soon bifurcates, enter the megasporophyll or axillary ovuliferous stalk, which is thus obviously a branch provided with a vascular cylinder of four bundles.

In the Abietineae (Diagram 8, A) conditions are very similar save that the subtending structure is a bract, not a foliage leaf, and that the axillary ovuliferous scale is not so evidently a branch. A strand precisely resembling the foliar bundle supplies the sterile bract. After its departure two bundles arise from the cylinder, one from each side of the gap, and approach each other by their adaxial ends, xylem outside and phloem inside, thus assuming an orientation which is inverse to that of the bract supply. The latter passes without division into the free bract, but the two scale bundles during their course through the cortex fuse into an arc or partial cylinder, which divides later into three parts. The small median bundle undergoes no further branching, but the two large lateral ones each give off a strand to an ovule and then by repeated division form the wide vascular arc which enters the lamina of the scale. The cone scale is thus precisely like an axillary branch in the origin of its vascular supply. A striking similarity is evident between the strobilar anatomy of the Abietineae and that of *Podocarpus* (Diagram 8, A and B).

In the Taxodineae and Cupressineae the bract and scale are more or less completely fused with one another, but where the latter is dominant, as in *Sequoia*, the vascular supply is double at its origin, and consists

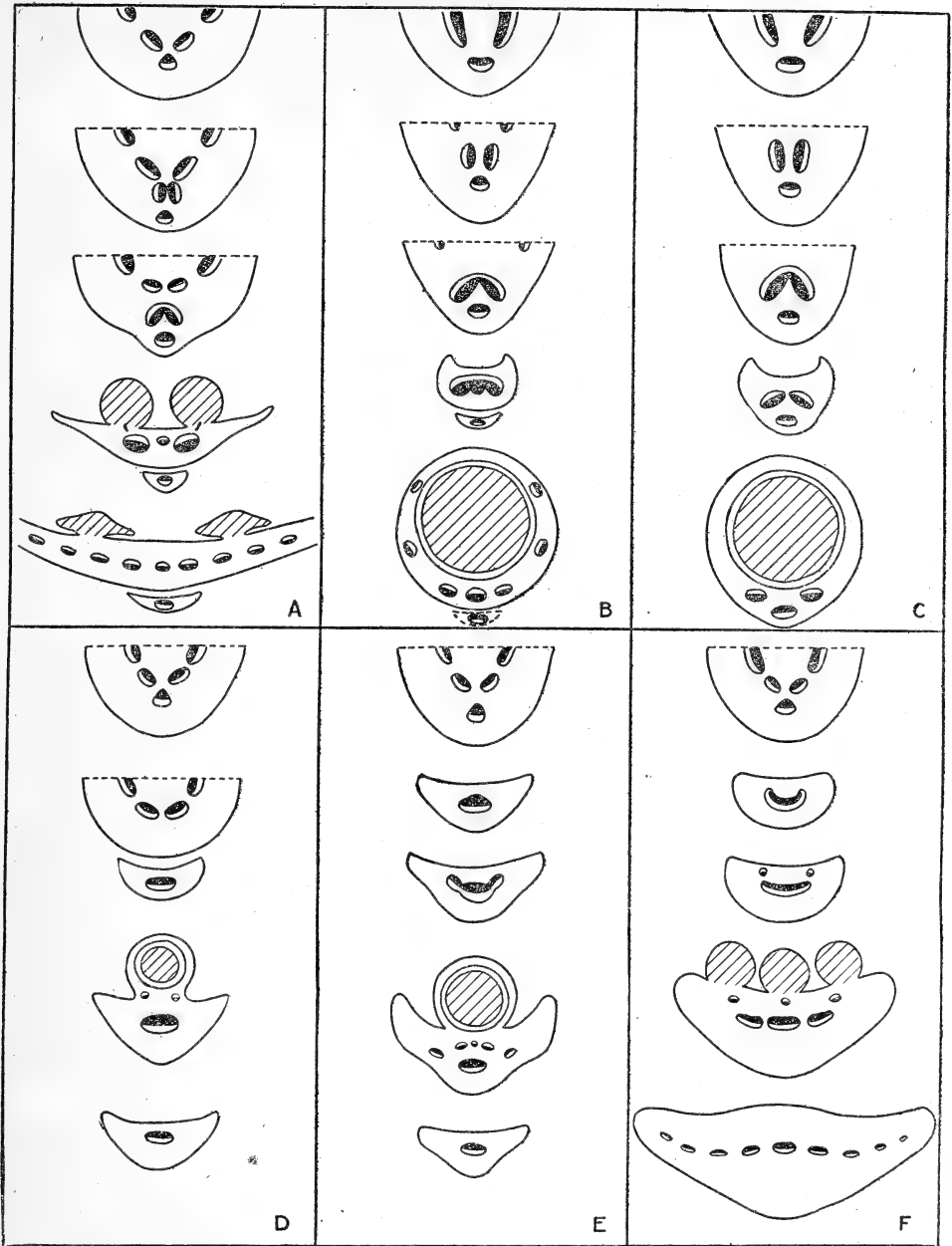

DIAGRAM 8. Series illustrating the vascular structure of the strobilar appendages, from con-  
 axis to ovule or beyond, in certain Conifers. A, Abietineae; B, *Podocarpus elatus*; C, *Podocarpus*  
*dactyloides*; D, *Microcachrys*; E, *Saxegothea*; F, *Athrotaxis*.

of a single bundle for the bract, followed by two others, derived from the  
 sides of the gap and inversely oriented, which usually fuse, divide again into  
 three, and then form a wide arc in the scale.

In *Cryptomeria*, *Athrotaxis*, and *Cunninghamia*, however, only a single bundle leaves the axis to supply the double appendage, but this single bundle, normally oriented, consists of the bract and scale systems fused. Its two ends soon bend upward, adaxially, and in *Cryptomeria* a ring of separate bundles is eventually formed. Only the median lower one enters the free end of the bract, and all the rest, forming a wide arc precisely as in *Sequoia*, represent the scale series. In *Athrotaxis* (Diagram 8, F) and *Cunninghamia* only a few small bundles, sometimes only one, are cut off from the adaxially curving ends of the original single strand and become oriented inversely. These bundles, which are obviously all there is left of the scale or axillary system, merely supply the ovules. The lamina of the appendage, now almost entirely bract, is provided with a long row of normally oriented bundles derived from the main part of the original single strand.

Early writers considered that a condition very similar to that of *Cunninghamia* was present in *Araucaria* and *Agathis*, and that the scale system was here reduced merely to the ovular bundles, the bulk of the 'scale' being supplied by a wide arc of strands, normally oriented, which were derived from the main part of the original bract bundle. Certain recent investigators, notably Professor Thomson, have maintained that the scale in the Araucarineae is a single (aplosporophyllous) structure and not a double one, and that it is entirely homologous with the microsporophyll and the vegetative leaf. He calls attention to the fact that in this family there are only two series of bundles, one to the 'scale', and the other, with inverse orientation, to the ovule, but that in the Abietineae, Taxodineae, and Cupressineae, which he considers double-scaled or diplosporophyllous, there are three series: one to the bract; one, inverse to this, to the scale; and a third, with another inversion of orientation, to the ovule. The Podocarpaceae, according to this theory, have been derived from the Araucarineae through forms similar to *Saxegothea*, for conditions in this genus resemble those in *Agathis*, the bulk of the appendage being supplied by a row of normally oriented bundles derived from a single strand, and the upper series consisting of little or nothing beside the ovular supply. *Dacrydium* and *Podocarpus* are derived from this by the increase in comparative size of the ovule and by the 'basipetal development' of its vascular system, which eventually attains the dignity of an independent insertion on the axis quite distinct from that of the supply to the 'scale'. The Podocarps and Taxads are therefore regarded as simple-scaled forms which have developed their female strobilus by an amplification of that of the male, and which are sharply separated from those Conifers where the female cone is an axis bearing axillary ovuliferous short shoots. The Coniferales are on this supposition divided into two great groups which must have been separate almost since the assumption of the strobilar habit.

A monophyletic conception of the order, however, seems much more in accord with what we know of the history of the Coniferales, and they have been considered by almost all investigators to be a natural group descended from a single source. If this is true, their ancestors must either have been single-scaled forms, from which the double-scaled families of to-day have arisen, or else the cone with double scales is primitive, and has given rise to that with a single scale by reduction.

The former view has been adopted by several writers, notably by Stiles in a recent paper, and is apparently shared by Miss Gibbs as well. The primitive cone among the Podocarpineae, and apparently among the Araucarineae also, is believed to have consisted of many spirally arranged sporophylls, in the axil of each of which was a single erect ovule. *Pherosphaera*, among living Conifers, seems most closely to approach this hypothetically primitive condition. The first sign of the ovuliferous scale was the appearance of an epimatium, inconspicuous and poorly developed at first, as in *Microcachrys*, *Saxegothea*, and some species of *Dacrydium*, but becoming larger until in *Podocarpus*, the most recent genus of all, the ovule is borne on the epimatium, which has been carried up on a stalk and is almost free from the 'scale'. In some such way as this the free ovuliferous scale of the Abietineae is supposed to have arisen, and the family is derived from a podocarpean-araucarian plexus. The living Araucarineae have departed from their *Pherosphaera*-like prototype only in possessing an inverted instead of an erect ovule.

This view of coniferous phylogeny will doubtless appeal strongly to those who believe that the Araucarineae are the most primitive members of the order, but the adoption of it necessitates an entire overthrow of the brachyblast theory of the ovuliferous scale of the Abietineae, which has until recently met with almost unanimous acceptance. This theory is well supported by facts, for, in addition to the mass of evidence derived from abnormalities, the vascular structure of the upper scale resembles precisely in its origin an axillary shoot. Much more cogent evidence than has yet been presented will be necessary to convince many persons that the ovuliferous scale of the Abietineae is only a glorified epimatium, and that its independent vascular supply represents merely a basipetal development of the ovular bundles. The homology between ovuliferous scale and epimatium is now pretty generally admitted, but the presence of the epimatium is logically accounted for only if it is derived from an axillary ovuliferous scale. To consider it a fortuitous outgrowth from the ventral face of the bract is not to explain it satisfactorily.

The other alternative, which regards as most primitive a cone with distinct double scales, resembling that of the living Abietineae, appears to the writer much more in agreement with all the facts. According to such a conception the epimatium is a vestige of the ovuliferous scale, not its

primordium, and the single-scaled series have arisen through either the fusion of the two appendages or the abortion of one of them. In the ascending series from the Abietineae to the Taxodineae and Cupressineae we may observe the gradual fusion of bract and scale, which usually results in the complete dominance of the scale and the almost entire disappearance of the bract and its vascular supply. In a few cases, however, notably *Athrotaxis* and *Cunninghamia*, where it is the bract which becomes dominant, the scale is so much reduced that its vascular system is represented by only a few small strands, sometimes only one, given off from the ventral face of the bract bundle, and serving merely to supply the ovules (Diagram 8, F). This condition of affairs is so precisely similar to that which we find in *Saxegothea* on the one hand, and in certain of the Araucarineae on the other, that it provides an illuminating suggestion, noted by earlier investigators, as to how the features of strobilar anatomy in these two groups have arisen. The hypothesis that in *Saxegothea* and the Araucarineae, as well as in *Cunninghamia*, the simple scale has been evolved by reduction from a more complex double one seems to the writer to be the most plausible yet suggested. Eames (3) in a contemporaneous paper brings forward strong evidence for the derivation of the araucarian cone-scale from a primitively double structure, and the results of anatomical investigations on the cones of *Saxegothea*, *Microcachrys*, and *Phyllocladus* seem to indicate that the simple scale in these forms has been evolved from the double strobilar appendage of *Podocarpus*, and that this genus is the most primitive of the family and stands close to the Abietineae.

This hypothesis, which instead of deriving the Podocarpineae from the Araucarineae considers them to have descended from the primitive Abietineae through forms somewhat resembling those found in the living genus *Podocarpus*, is supported by abundant evidence from our comparative study of the reproductive structures of the families in question.

In both *Podocarpus* and the Abietineae the female cone is composed of subtending sterile bracts, each provided with a single strand, and almost or quite free from the axillary ovuliferous structure. In both, the vascular supply of the latter arises as two separate bundles, each derived from a side of the bracteal gap, which approach each other by their adaxial ends, become oriented inversely to the bract bundle, and fuse. In both, this single fused bundle tends strongly to divide into three when it enters the base of the ovuliferous scale or epimatium. In most species of *Podocarpus* two distinct ovular bundles are given off from the main supply just as in the Abietineae, and instead of displaying inverse orientation these are usually concentric, a condition which Radais also observed in the ovular bundles of the Abietineae. In fact, it seems doubtful if the inversion in orientation of the ovular supply, 'the second inversion,' is at all common.

The main cone of *Podocarpus* and of its family is almost identical with

that of the *Abietineae*, for in both groups the microsporophyll bears but two sporangia, a very different condition from that obtaining in the *Araucarineae*, where the pollen-sacs are often very numerous. In fact, the *Abietineae* and *Podocarpaceae* are the only *Coniferae* which never have more than two microsporangia to a sporophyll.

These two families are also distinguished from all others of the *Coniferales* by the possession of winged pollen-grains, and attention has already been called to the strong resemblance between the whole male gametophyte of *Podocarpus* and that of the *Abietineae*.

Now that the investigations of Eames (3) in *Agathis australis* have given us a much fuller knowledge of the araucarian female gametophyte and embryo, we are able to compare the reproductive histories of the *Araucarineae* and *Podocarpaceae*, and to observe their many points of difference. In the *Araucarineae* the megaspore membrane is poorly developed, the archegonia are very numerous and distributed over the whole upper portion of the embryo sac, and the fertilized egg develops *in situ* and gives rise to a proembryo furnished with an elaborate protective cap, such as is found nowhere else. Among the *Podocarpaceae*, on the other hand, the megaspore membrane is conspicuous, the archegonia are fewer in number and gathered in an apical group, and the products of the fertilized egg sink directly to the bottom of the archegonium, where they produce a proembryo very similar to that found among the *Abietineae* and their allies. Indeed it is to the type occurring among these dominant Northern Hemisphere *Coniferae* that the whole female gametophyte of *Podocarpus* and its family conforms, and it shows little similarity to that of the *Araucarineae*.

It is highly improbable that so many strikingly similar reproductive structures, both sporophytic and gametophytic, should have arisen in two independent groups and along two quite distinct lines of evolution. We are, therefore, forced to adopt the hypothesis that the *Podocarpaceae*, and especially the genus *Podocarpus*, are more nearly related to the *Abietineae* than to any other family of the *Coniferales*, and since a great body of evidence is accumulating in support of the view that the *Abietineae* are the most ancient members of the *Coniferous Order*, *Podocarpus* must be considered as a relatively primitive type and the oldest genus of its family. The resemblances between the *Podocarpaceae* and the *Araucarineae* are best explained as an inheritance of structures and tendencies from a very ancient group, ancestral to both and closely *abietineous* in affinities, from which the modern *Araucarians* have widely departed. In fact, it is perhaps more logical to consider the *Araucarineae* as derived from, rather than having given rise to, the *Podocarpaceae*.

This hypothesis as to the phylogeny of the *Podocarpaceae* has the advantage of explaining more facts than does any other which has been put forward.

It is in precise harmony with the view, now supported by an abundant evidence from many sources, that the Abietineae are the most primitive of all Conifers.

It assigns a logical position to the Podocarpineae among the Coniferales, and does away with the necessity of dividing this otherwise homogeneous order into two sharply distinct series.

It explains the wide diversity in structure found among the members of the genus *Podocarpus* as the natural state of affairs in a primitive and generalized genus which has not yet become fixed or stereotyped.

It offers a reasonable explanation for the presence of the epimatium, as a structure homologous with the ovuliferous scale of the Abietineae, well developed and displaying its true nature in *Podocarpus*, but much reduced in the other genera. To consider the epimatium as a normal second integument which later expands into the ovuliferous scale, or to regard it as merely a ventral outgrowth of the sterile bract, are both theories which fail to explain it adequately in the presence of all the facts.

Finally, instead of so often appealing to parallel development to solve the riddle, it offers a reasonable explanation for the striking similarity between *Podocarpus*, which is considered primitive, and the Abietineae, and on this basis makes possible the construction of a clear and consistent natural classification for the various genera and species of the Podocarpineae.

Numerous intermediate forms connect the widely differing sub-genera of *Podocarpus* with one another, but on a study of their reproductive structures alone it is impossible to determine definitely which group of species is the most primitive. *Eupodocarpus*, on the whole, may be so considered, for in the structure of its male and female gametophytes it resembles the Abietineae more closely than do any of the others. The poor development of spongy tissue and the small number of archegonia in *Stachycarpus*, with the almost complete freedom of the nucellus in one of its species, shows that this sub-genus has progressed considerably from the primitive abietineous condition. *Dacrycarpus*, with its fused bract and three-winged pollen, is obviously the most specialized member of the sub-genera.

A rather close series unites the parent genus with *Dacrydium* through *D. Bidwillii*, for this species, although it possesses the typical subulate leaves of its genus, has nearly the strobilar structure of *Eupodocarpus*, save that its nucellus, integument, and epimatium have all attained complete freedom from one another. *Dacrydium* proper has progressed much further, and only during a very young condition of the cone, when the epimatium, bearing an apical knob, completely surrounds the ovule, is the resemblance to *Podocarpus* at all marked. The female gametophyte of *Dacrydium* by the decrease in number and increase in size of its archegonia shows clearly a more advanced condition than does that of *Eupodocarpus*.

In *Podocarpus dacrydioides* the three-winged pollen-grain and the com-



plete fusion of ovule and epimatium to the sterile bract indicate a definite step in the direction of *Microcachrys* and *Saxegothea*. This species is also set off from the rest of the genus by its subulate leaves, numerous mucilage cells in the endosperm, and poor development of spongy tissue and megaspore membrane.

*Microcachrys* is close to *P. dacrydioides* in the possession of subulate leaves, three-winged pollen, and a single bundle in the bract (Diagram 8, C and D), but it has advanced, like *Dacrydium*, in the freedom of epimatium from integument. The upper vascular system has likewise grown very weak.

*Pherosphaera* is the last step in reduction, and here all traces of the epimatium have been lost, and the ovule has become axillary and erect, both of which features seem undoubtedly modern and not primitive.

In *Phyllocladus* the wings of the pollen-grain are disappearing, and the ovule has also attained a perfectly erect position and is surrounded symmetrically at its base by an epimatium obviously homologous with that in *Dacrydium* proper. The integument of the ovule in these two genera is divided in precisely the same way into a stout outer layer and a more soft inner one, and is free entirely from the nucellus. The female gametophyte, especially in the reduced number of archegonia and the structure of the neck, is very similar in both genera. All the evidence seems to indicate that *Phyllocladus*, though radically modified in vegetative structures, has undergone the same reproductive development as the other recent members of the family, especially *Dacrydium*, and that it is closely related to them.

*Podocarpus dacrydioides*, *Dacrydium*, *Microcachrys*, *Pherosphaera*, and *Phyllocladus* are with a very few exceptions Australasian, and seem to represent two or three main lines of evolution from the genus *Podocarpus*. They show a tendency towards extreme leaf-reduction, a modification or loss of the pollen wings, an erect position of the ovule, freedom of the nucellus, freedom and reduction of the epimatium, and fusion of the epimatium with the bract.

Very close to these forms stands the Chilean *Saxegothea*, which differs from them in having much larger leaves and a more complex vascular system in the bract, where the single strand has divided into three or five (Diagram 8, E). This dominance of the bract is precisely comparable to a similar state of affairs in *Cunninghamia*, *Athrotaxis* (Diagram 8, F), and the Araucarineae. A small free epimatium and the absence of winged pollen also show the advanced position of the genus.

The classification of the Podocarpaceae here proposed (Diagram 9) is radically different from that recently put forward by Stiles, which is based on the hypothesis we have already discussed, that *Saxegothea* and *Pherosphaera* are the most primitive members of the family. The complete separation by this author of § *Dacrycarpus*, *Microcachrys*, and *Pherosphaera*

from one another is not in agreement with the many similarities between these three groups, and *Podocarpus* and *Dacrydium*, though placed wide apart in the scheme, seem in reality closely related to one another through such species as *Dacrydium Bidwillii*. The derivation of *Phyllocladus* from *Pherosphaera* is surely a novel solution to the vexed question of the relationship of this interesting genus.

The Podocarpineae, therefore, on the hypothesis set forth in the present paper, form a well-marked natural alliance. A fairly close series connects

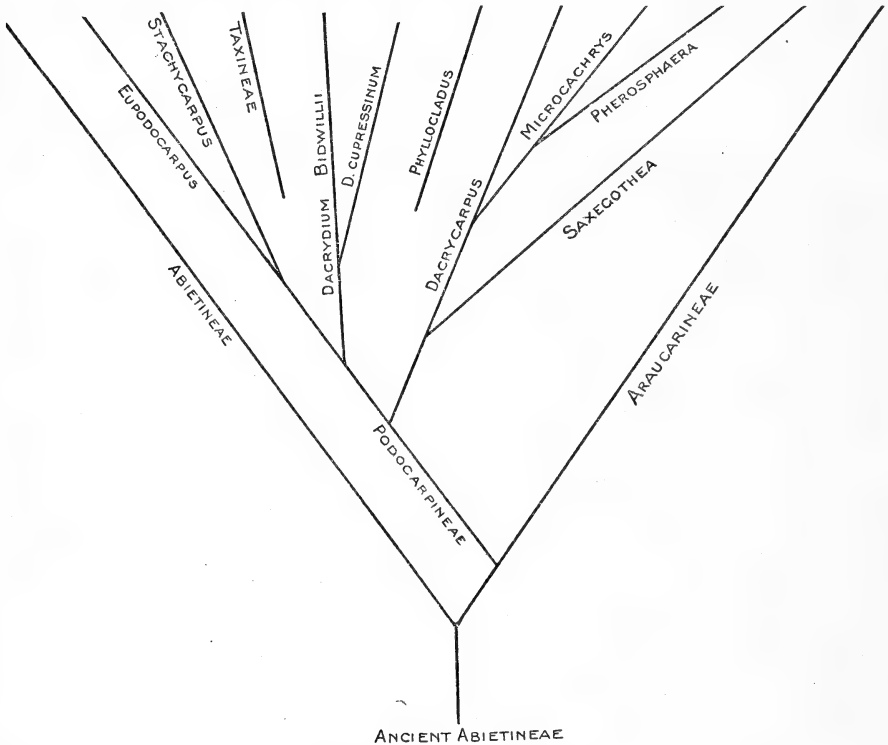

DIAGRAM 9. Illustrating the phylogeny of the Podocarpineae.

the various members with one another and their interrelationships are clearly explicable if we consider the genus *Podocarpus*, standing at one end of the line, as the most primitive type. If the series is reversed, however, and the whole family is derived from the Araucarineae through forms like *Saxegothia*, the close resemblance between *Podocarpus* and the *Abietineae* must either be regarded as a most amazing case of parallel development, or else the affinity of these two groups must be recognized, and all other Conifers as well be derived from the Araucarineae. This view denies the brachyblast character of the ovuliferous scale by considering the double-scaled forms to have arisen from single-scaled ones, and also disregards all the

evidence which points to the fact that the Abietineae and not the Araucarineae are the most ancient Conifers.

The close series of forms from *Podocarpus* to *Saxegothea* is very suggestive as offering a key to the evolutionary development of the modern Araucarineae. If the epimatium suffered progressive reduction and final elimination and the bract were thus strongly dominant, as has happened in the line culminating in *Pherosphaera*, the resulting cone scale, with a somewhat amplified vascular system as in *Saxegothea*, would much resemble that of a miniature *Agathis*. Should the adnate sterile bract of such a form as *Podocarpus dacrydioides* become much more strongly developed in proportion to the size of the ovule, as in *Cunninghamia* and *Saxegothea*, and if the apical knob of the epimatium were drawn out into a ligule-like structure, a state of affairs would result precisely comparable to that in *Araucaria*. Steps are therefore easy to imagine by which the living Araucarineae have arisen from an ancient 'double-scaled' group, close to the primitive Podocarpaceae, and thus ancestral to both families, but which had only recently sprung from the ancient Abietineae.

#### (b) Relationship to Taxineae.

The relationship between the Podocarpaceae and the Taxineae has also been a subject of controversy, but from the prevailing reduction of the female cone to a single ovule in both families and the common possession of a 'second integument' and a fleshy fruit, they have usually been placed near each other and included together as the Taxineae.

*Cephalotaxus*, by the strong development of its ovulate strobilus, the typically coniferous structure of its female gametophyte, and the simple condition of its microsporophyll, which, instead of bearing numerous sporangia, has but two or three, is clearly shown to be more primitive than *Torreya* or *Taxus*, the other members of the Taxineae. It also displays a notable similarity in strobilar anatomy, gametophytic history, and embryonic development, to certain species of the Podocarpaceae.

The female cone is a short axis with a number of bracts, in the axil of each of which are borne two erect ovules (Diagram 7, c). The vascular system precisely resembles that of the Podocarpaceae and Abietineae, for the cylinder of bundles gives off one strand to each bract and two more, from the sides of the gap, and becoming inversely oriented, to the ovuliferous structures, one to each ovule (Diagram 7, D). The gross anatomy of the cone closely resembles that of *Phyllocladus*.

In the structure of the ovule, also, *Cephalotaxus* shows a strong resemblance to *Podocarpus*, and especially to its sub-genus *Stachycarpus*. The epimatium in both instances is full of canals, ripens into a fleshy coat, and is entirely fused with the integument, which becomes stony at maturity. Attention was called to the fact that in *Podocarpus spicatus* two bundles,

wide apart, run down through the epimatium on its adaxial face. In *P. ferrugineus* these two bundles, after leaving the chalazal end, pass down exactly opposite one another, one on either side of the ovule and each just at the inner margin of the epimatium. This latter condition, obviously less primitive than that in *P. spicatus*, is precisely what we find in the ovule of *Cephalotaxus* (and of *Torreya* as well), where two opposite and lateral bundles pass upward from the chalaza towards the micropyle just at the limit of the two integuments. In *Podocarpus*, of course, there are the two dorsal strands which represent the vascular system of the ovuliferous scale between the axis and the attachment of the ovule, but if we imagine that this part of the scale, after being greatly shortened, as in *Dacrydium*, has disappeared entirely, as in *Phyllocladus*, and that the ovule has become erect while at the same time retaining its integumentary and vascular structures, we obtain a close approximation to conditions in *Cephalotaxus*. A study of the little known New Caledonian genus *Acropyle* should prove very interesting in this connexion, for here the cone has been reduced to a fleshy receptaculum bearing a single erect ovule which has an inner stony and, apparently, an outer leathery integument. This seems to provide an intermediate condition between *Podocarpus* and the Taxineae.

The resemblance between *Cephalotaxus* and the sub-genus *Stachycarpus* of *Podocarpus* is further emphasized by the structure of the female gametophyte and embryo, for in both the reproductive cycle extends through two seasons; spongy tissue is almost completely absent; the archegonia are only two or three in number and are very long and narrow; they are eventually deeply sunken in the endosperm; the neck is composed of but one tier of cells; the first two sporophytic mitoses occur in the upper portion of the archegonium, and wall formation occurs at the sixteen-nuclear stage, and is followed by rapid and irregular cell-division which gives rise to a proembryo different from that of almost all other Conifers. It is composed of four tiers: a single terminal cell, more or less protective in function; a group of cells immediately behind this, which is to give rise to the embryo; a suspensor tier, and a poorly developed rosette.

In opposition to this evidence from sporophytic anatomy and the female gametophyte, it may be urged that the occurrence in *Cephalotaxus* of two ovules to a bract instead of one is a strong objection to the derivation of this genus from forms close to *Podocarpus*. The other two members of the Taxineae have but one ovule to a bract, and although the occurrence of a single ovule is constant throughout the Podocarpaceae (two nucelli were found in one epimatium of *P. spicatus*), the number varies greatly in other coniferous families. It seems very probable that the multiplication of sporangia which is so evident in the male cone of the Taxineae may have affected the female strobilus as well. The occurrence of two megasporangia to each megasporophyll in *Ginkgo* and the Abietineae makes it also very

probable that this is the primitive state of affairs. To this the biovulate condition of *Cephalotaxus* may conceivably be a reversion.

*Stachyotaxus*, as described by Nathorst (7) from the Rhaetic, is worth mentioning here, though it probably shows nothing more than an interesting analogy. Its foliage is distinctly taxineous in habit, and the cones, long and lax like those of *P. spicatus*, are composed of small bracts each of which bears near the end of its lamina two erect ovules, both apparently invested by a basal cup-like 'epimatium'. This fossil, apparently a combination of *Podocarpus*, *Dacrydium*, and *Cephalotaxus*, might easily be regarded as an ancestral form for the Taxineae, but its ancient geological horizon, the absence of all information save that from impressions, and our slight acquaintance even with these, make quite uncertain any conclusions as to its affinities. *Stachyotaxus* at least demonstrates the antiquity of tendencies exhibited by the living Taxineae.

The resemblance in reproductive structures between *Cephalotaxus* and the Podocarpaceae are sufficiently numerous and important to warrant our assuming a rather close relationship between them, and since *Cephalotaxus* is the most primitive member of its family, we are justified in considering the Taxineae as a whole to have arisen from somewhere among the ancient members of the Podocarpaceae.

Further investigations, both anatomical and embryological, upon many other species of the Podocarpaceae are necessary before there will be at hand a body of facts sufficiently comprehensive to enable us to construct with certainty a true natural classification for the whole family. Information obtained by the writer from a general study of the anatomy of the vegetative organs of the Podocarpaceae emphatically confirms the conclusions based on the present investigation of their reproductive structures and furnishes further evidence for the affinity of *Podocarpus* with the Abietineae on the one hand and with the Taxineae on the other.

We must recognize that in the families under consideration, as in so many other groups of plants, very similar structures have been developed along quite distinct lines of evolution, and we must guard against accepting this similarity as indubitable evidence of identical origin. The whole body of facts derived from all possible sources, rather than a few arbitrarily set up as unfailing criteria, must be considered if we are to arrive at sound phylogenetic conclusions.

#### SUMMARY.

1. The male strobilus of the Podocarpaceae is essentially uniform in structure throughout the family, and consists, as in the Abietineae, of spirally arranged bisporangiate sporophylls.

2. The female strobilus shows a tendency to become fleshy in whole or part at maturity. Reduction in number of sporophylls has occurred

throughout, though this reduction has not been uniformly progressive, but subject to great variation in degree within the same group.

3. In typical *Podocarpus* the free bract is provided with a single bundle from the vascular cylinder of the cone and subtends the epimatium, an axillary structure exactly homologous with the ovuliferous scale, and which is supplied by two bundles with inverse orientation, each arising from one side of the bract gap. These eventually send two small strands into the chalaza. The ovule is inverted and is completely enveloped by the epimatium. The integument is adnate to the epimatium without and to the nucellus within.

4. From this condition, closely resembling that of the Abietineae, there is an almost complete series through *Podocarpus dacrydioides* and *Dacrydium* to *Microcachrys*, *Pherosphaera*, *Saxegothea*, and *Phyllocladus*, in which are exhibited the following tendencies: the bract becomes fused to the epimatium and its single bundle may divide into a series of strands; the vascular system of the scale is reduced to little but the ovular supply, and its two bundles become fused for some distance to that of the bract, from the sides of which they eventually depart and bend upward adaxially, assuming an inverse orientation; the ovule swings from an inverted to an almost erect position; the epimatium becomes much reduced in proportion to the bract, and, instead of enclosing the ovule entirely, degenerates into a mere basal sheath or quite disappears; the nucellus, integument, and epimatium become entirely free from one another.

5. The male gametophyte is characterized by the presence of two primitive prothallial cells, which give rise subsequently to more or less vegetative tissue. At germination all the cells are represented by free nuclei save the body cell, the nucleus of which divides into the two male nuclei, one naked and the other surrounded by a protoplasmic body.

6. In typical *Podocarpus* there are two well-developed wings on the pollen-grain, but in its sub-genus *Dacrycarpus* there are three or four, a condition which also obtains in *Microcachrys*. In *Dacrydium* the young spore has always two large wings, but in certain species these are almost obliterated at maturity. The pollen of *Phyllocladus* has two much-reduced wings, but in that of *Saxegothea* there are none at all.

7. The length of the reproductive cycle is limited to a single season in § *Eupodocarpus*, § *Nageia*, § *Dacrycarpus*, *Dacrydium Bidwillii*, *Phyllocladus*, and apparently in *Saxegothea* and *Microcachrys*. It extends over two seasons in § *Stachycarpus* and in most of *Dacrydium*.

8. Spongy tissue is best developed in § *Eupodocarpus*, and is somewhat reduced or entirely absent in the other members of *Podocarpus* and *Dacrydium*. The germination of the spore and development of the embryo-sac occur as in most Conifers. A megaspore membrane is well developed everywhere save in § *Dacrycarpus*, where it is somewhat reduced. The

archegonia are apical. They vary in number from two or three in § *Stachycarpus* and *Dacrydium* to ten or more in certain species of *Podocarpus*, and are with rare exceptions quite distinct from one another and not grouped. The neck may be either a single-tiered rosette or an irregular group of cells. In § *Eupodocarpus*, and to some extent in *Dacrydium*, asteroids, or centres of radiating fibrils, occur in the young archegonium. A large basal vacuole is everywhere present, save in § *Stachycarpus*.

9. At fertilization the male nucleus is about half the size of the female, to which it becomes closely appressed and is finally fused. In all forms but § *Stachycarpus* only the first sporophytic mitosis takes place in the position of the fertilized egg, and the two resultant nuclei drop to the bottom and divide into sixteen. Walls are now laid down and a proembryo results of three tiers: a terminal binucleate embryogenous cell, a suspensor tier, and a poorly developed rosette. In § *Stachycarpus* the first two sporophytic mitoses occur in the upper portion of the archegonium, and the four nuclei, dropping to the base, give rise to a proembryo of four tiers: a single terminal cell more or less protective in function and often sloughed off; a group of from eight to forty cells which will form the embryo; a suspensor tier, and a rosette.

10. The endosperm cells in all species become multinucleate about the time of fertilization. The embryo remains intact except in *Dacrydium*, where it usually buds or divides. At maturity the embryo is dicotyledonous.

11. The close resemblance of *Podocarpus* to the Abietineae in the development of the male and female gametophytes and the embryo, as well as in the anatomy of the staminate and ovulate strobili, warrants the hypothesis that the Podocarpaceae have been derived from the Abietineae through forms somewhat resembling *Podocarpus*. Certain points of similarity between Podocarpaceae and Araucarineae suggest that these two families may have both arisen from an ancient group, closely abietineous in affinity. The advantages of this hypothesis are that it is in harmony with the view that the Abietineae are the most ancient Conifers; that it assigns a logical position to the Podocarpaceae; that it accounts for the wide variation in the genus *Podocarpus*; that it offers a reasonable explanation of the origin of the epimatium, and that it makes possible the construction of a natural classification for the Podocarpaceae on the assumption that the family represents three or four main lines of ascent from its most primitive genus, *Podocarpus*.

12. The striking resemblance in strobilar anatomy, in the structure of the female gametophyte, and in the development of the embryo, between *Stachycarpus*, a sub-genus of *Podocarpus*, and *Cephalotaxus*, the most primitive genus of the Taxineae, suggests that the latter family has arisen from some ancient member of the Podocarpaceae. The structure of the

living *Phyllocladus* and that of the fossil *Stachyotaxus* indicate possible steps by which the taxinean evolution may have taken place.

The writer wishes to thank most heartily his many friends in the several Botanic Gardens, in various other departments of the public service, and elsewhere throughout Australia and New Zealand for their active assistance in securing material, and he is especially indebted to Mr. T. F. Cheeseman, F.L.S., F.Z.S., of the Auckland Museum, for invaluable aid as to localities and identifications. This investigation was carried on in the Phanerogamic Laboratories of Harvard University.

---

#### BIBLIOGRAPHY.

1. BURLINGAME, L. L.: The Staminate Cone and Male Gametophyte of *Podocarpus*. Bot. Gazette, vol. xlvi, 1908, pp. 161-78.
2. COKER, W. C.: Notes on the Gametophytes and Embryo of *Podocarpus*. Bot. Gazette, vol. xxxiii, 1902, pp. 89-107.
3. EAMES, A. J.: The Morphology of *Agathis australis*. Ann. Bot., vol. xxvii, 1913.
4. GIBBS, L. S.: On the Development of the Female Strobilus in *Podocarpus*. Ann. Bot., vol. xxvi, 1912, pp. 515-73.
5. JEFFREY, E. C., and CHRYSLER, M. A.: The Microgametophyte of the Podocarpaceae. Amer. Nat., vol. xli, 1907, pp. 102-7.
6. KILDAHL, N. JOHANNA: The Morphology of *Phyllocladus alpinus*. Bot. Gazette, vol. xlvi, 1908, pp. 339-48.
7. NATHORST, A. S.: Über *Pallissya*, *Stachyotaxus* und *Palaetotaxus*. Kungl. Svenska Vetenskap. Handl., Band xliii, 1908, No. 8.
8. NORÉN, C. O.: Zur Kenntnis der Entwicklung von *Saxegothea conspicua*. Svensk. Bot. Tidsskr., vol. ii, 1908, pp. 101-22.
9. RADAIS, M.: L'Anatomie comparée du fruit des Conifères. Ann. Sci. Nat., Bot., sér. 7, t. xix, 1894, pp. 165-368.
10. ROBERTSON, AGNES: Some Points in the Morphology of *Phyllocladus alpinus*. Ann. Bot., vol. xx, 1906, pp. 259-65.
11. STILES, W.: The Anatomy of *Saxegothea conspicua*. New Phytologist, vol. vii, 1908, p. 209.
12. ——— (With BROOKS, F. T.): The Structure of *Podocarpus spinulosa*. Ann. Bot., vol. xxiv, 1910, pp. 305-18.
13. ———: The Podocarpeae. Ann. Bot., vol. xxvi, 1912, pp. 443-515.
14. STRASBURGER, E.: Die Coniferen und die Gnetaceen. 1872.
15. ———: Die Angiospermen und die Gymnospermen. 1879.
16. THOMSON, R. B.: On the Pollen of *Microcachrys tetragona*. Bot. Gazette, vol. xlvii, 1909, pp. 26-9.
17. ———: The Megasporophyll of *Saxegothea* and *Microcachrys*. Bot. Gazette, vol. xlvii, 1909, pp. 345-54.
18. TISON, A.: Sur le *Saxegothea*. Mém. Soc. Linn. Normandie, t. xxiii, 1909, pp. 139-60.
19. VAN TIEGHEM, P.: Anatomie comparée de la fleur femelle et du fruit des Cycadées, des Conifères, et des Gnétacées. Ann. Sci. Nat., Bot., sér. 5, t. x, 1869, pp. 269-304.
20. YOUNG, MARY S.: The Male Gametophyte of *Dacrydium*. Bot. Gazette, vol. xlv, 1907, pp. 189-96.
21. ———: The Morphology of the Podocarpaceae. Bot. Gazette, vol. I, 1910, pp. 81-100.



## DESCRIPTION OF FIGURES IN PLATES V-IX.

Illustrating Mr. Sinnott's paper on the Podocarpaceae.

## PLATE V.

- Fig. 1. *Podocarpus Totara*. Archegonium at time of fertilization, showing fusion nucleus, second male nucleus, and prothallial nuclei.  
 Fig. 2. *P. ferrugineus*. Mature archegonium and male cells, just before fertilization.  
 Fig. 3. *Dacrydium Bidwillii*. Mature archegonium sealed over by endosperm.  
 Fig. 4. *Podocarpus spicatus*. Germinating pollen.  
 Fig. 5. *Dacrydium cupressinum*. Microspore.  
 Fig. 6. *D. cupressinum*. Mature pollen-grain with reduced wings.

## PLATE VI.

- Fig. 7. *Podocarpus Totara*. Longitudinal section of mature ovule.  $\times 12$ .  
 Fig. 8. *P. nivalis*. Transverse section of mature ovule.  $\times 15$ .  
 Fig. 9. *P. Totara*. Transverse section of receptaculum, with bract traces departing.  $\times 15$ .  
 Fig. 10. *P. spinulosa*. Longitudinal section of young strobilus.  $\times 15$ .  
 Fig. 11. *P. vitiensis*. Longitudinal section of young ovule.  $\times 10$ .  
 Fig. 12. *P. dacrydioides*. Longitudinal section of mature ovule.  $\times 12$ .  
 Fig. 13. *P. dacrydioides*. Longitudinal section of very young ovule, megaspore stage.  $\times 20$ .  
 Fig. 14. *P. dacrydioides*. Longitudinal section of young ovule, free nuclear stage.  $\times 15$ .  
 Fig. 15. *P. ferrugineus*. Longitudinal section of young ovule.  $\times 8$ .  
 Fig. 16. *P. spicatus*. Longitudinal section of young ovule and part of cone axis.  $\times 9$ .  
 Fig. 17. *P. ferrugineus*. Longitudinal section of very young ovule, just after spore germination.  $\times 15$ .  
 Fig. 18. *P. ferrugineus*. Transverse section of ovule, showing vascular girdles around nucellus from lateral bundles.  $\times 10$ .

## PLATE VII.

- Fig. 19. *P. spicatus*. Transverse section of cone axis, supply to bract and ovule departing at left.  $\times 30$ .  
 Fig. 20. *P. ferrugineus*. Transverse section through very base of ovule, showing single trace to bract and two inverted bundles to epimatium.  $\times 60$ .  
 Fig. 21. *Dacrydium Bidwillii*. Longitudinal section of ovule.  $\times 15$ .  
 Fig. 22. *D. Bidwillii*. Transverse section through chalazal region, showing two bundles in epimatium and two departing from these into base of ovule.  $\times 30$ .  
 Fig. 23. *D. intermedium*. Longitudinal section of young ovule, entirely surrounded by epimatium.  $\times 35$ .  
 Fig. 24. *D. cupressinum*. Mature pollen-grain with reduced wings.  $\times 700$ .  
 Fig. 25. *P. elatus*. Megaspore mother-cell.  $\times 160$ .  
 Fig. 26. *P. Totara*. Small embryo-sac at free nuclear stage, surrounded by spongy tissue.  $\times 60$ .  
 Fig. 27. *P. Totara*. Young archegonium with 'asteroids' in central cell.  $\times 60$ .  
 Fig. 28. *P. Totara*. Mature archegonium.  $\times 60$ .  
 Fig. 29. *P. Totara*. Mature archegonium with persistent ventral canal nucleus.  $\times 140$ .  
 Fig. 30. *P. Totara*. Proembryo of four nuclei.  $\times 160$ .  
 Fig. 31. *P. nivalis*. Sixteen-celled proembryo with protective cellulose cap, just after wall formation.  $\times 160$ .

## PLATE VIII.

- Fig. 32. *P. Totara*. Embryos from two archegonia, with suspensors just beginning to lengthen.  $\times 120$ .

- Fig. 33. *P. Hallii*. Nearly mature embryo.  $\times 30$ .  
 Fig. 34. *P. dactydioides*. Mature archegonium.  $\times 60$ .  
 Fig. 35. *P. dactydioides*. Mature archegonium with persistent ventral canal nucleus.  $\times 125$ .  
 Fig. 36. *P. dactydioides*. First sporophytic mitosis.  $\times 60$ .  
 Fig. 37. *P. dactydioides*. Fusion nucleus.  $\times 160$ .  
 Fig. 38. *P. dactydioides*. Portion of endosperm, showing mucilage cells and young embryo.  $\times 20$ .  
 Fig. 39. *P. ferrugineus*. Functional megaspore with two abortive ones at end.  $\times 160$ .  
 Fig. 40. *P. ferrugineus*. Two archegonia, one with proembryo at base, the other unfertilized.  $\times 30$ .  
 Fig. 41. *P. spicatus*. Apex of archegonium, with egg nucleus and ventral canal nucleus.  $\times 160$ .  
 Fig. 42. *P. spicatus*. First sporophytic mitosis.  $\times 160$ .  
 Fig. 43. *P. ferrugineus*. First four nuclei of proembryo in upper part of archegonium, surrounded by cytoplasmic sheath.  $\times 160$ .  
 Fig. 44. *P. spicatus*. Archegonium with first four nuclei of proembryo dropping towards the base, and vacuole forming above.  $\times 30$ .

PLATE IX.

- Fig. 45. *P. spicatus*. Proembryo of sixteen nuclei at base of archegonium.  $\times 160$ .  
 Fig. 46. *P. spicatus*. Proembryo soon after wall formation, with suspensors, embryo, and apical cell.  $\times 125$ .  
 Fig. 47. *P. ferrugineus*. Two young embryos.  $\times 160$ .  
 Fig. 48. *Dacrydium cupressinum*. Two young archegonia.  $\times 60$ .  
 Fig. 49. *D. cupressinum*. Young embryo beginning to divide.  $\times 160$ .  
 Fig. 50. *Podocarpus dactydioides*. Male cells and prothallial nuclei in pollen-tube.  $\times 160$ .



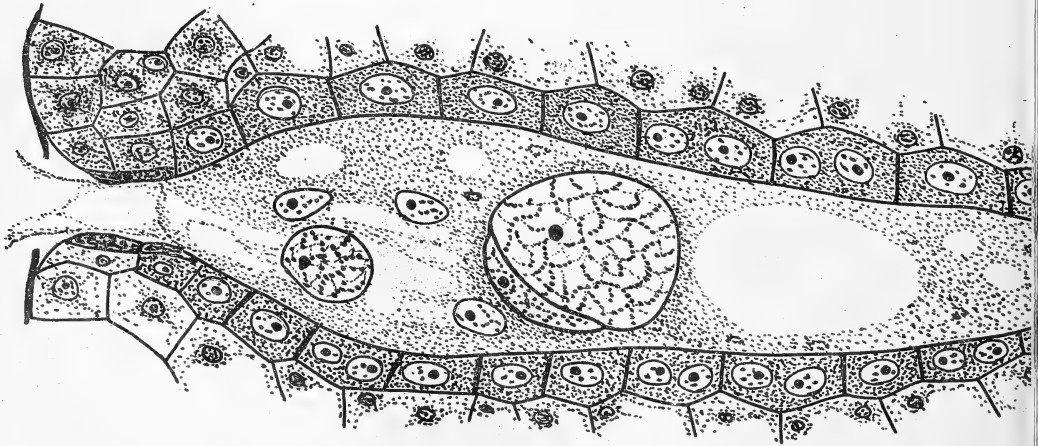
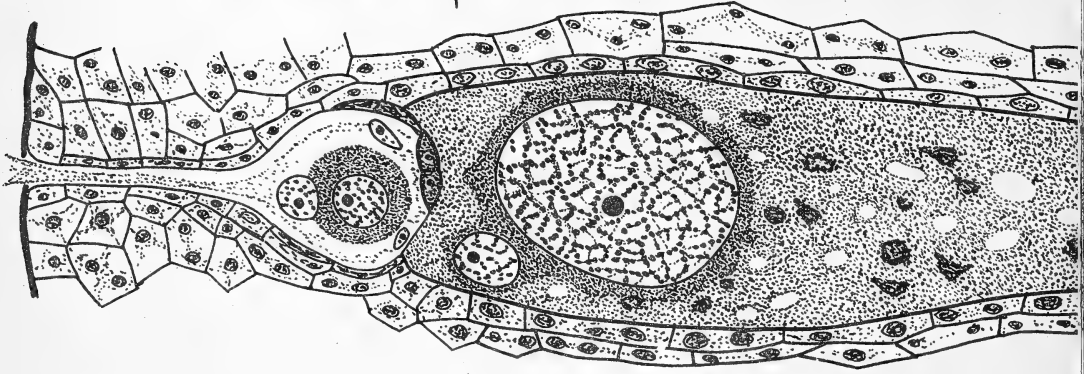
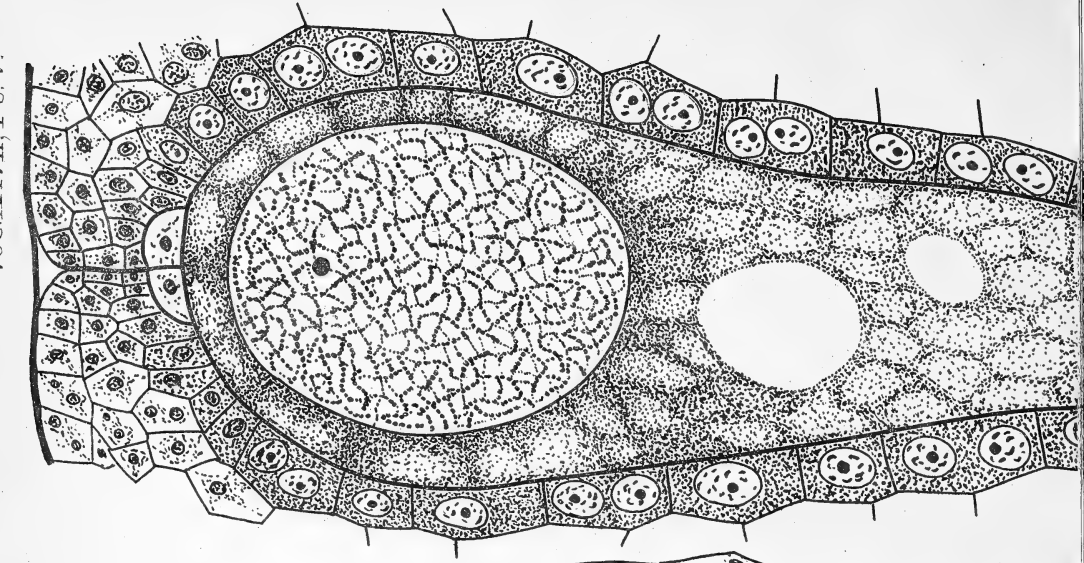

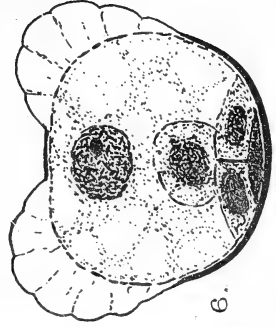
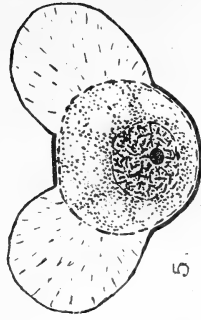
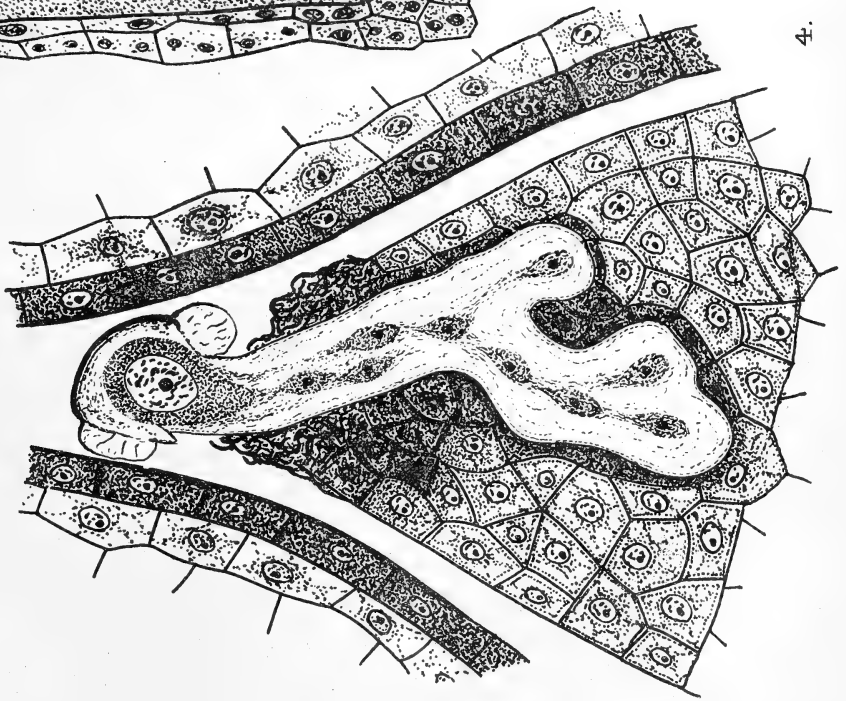
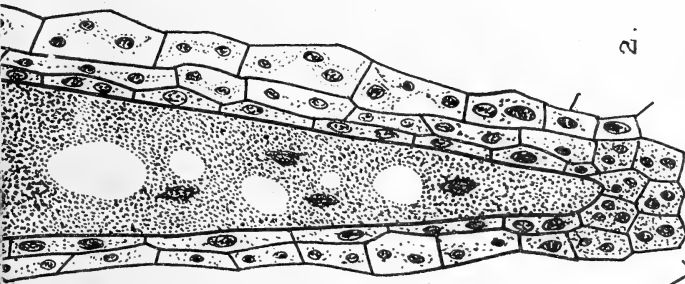
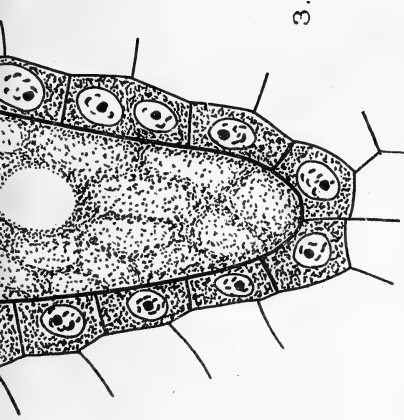



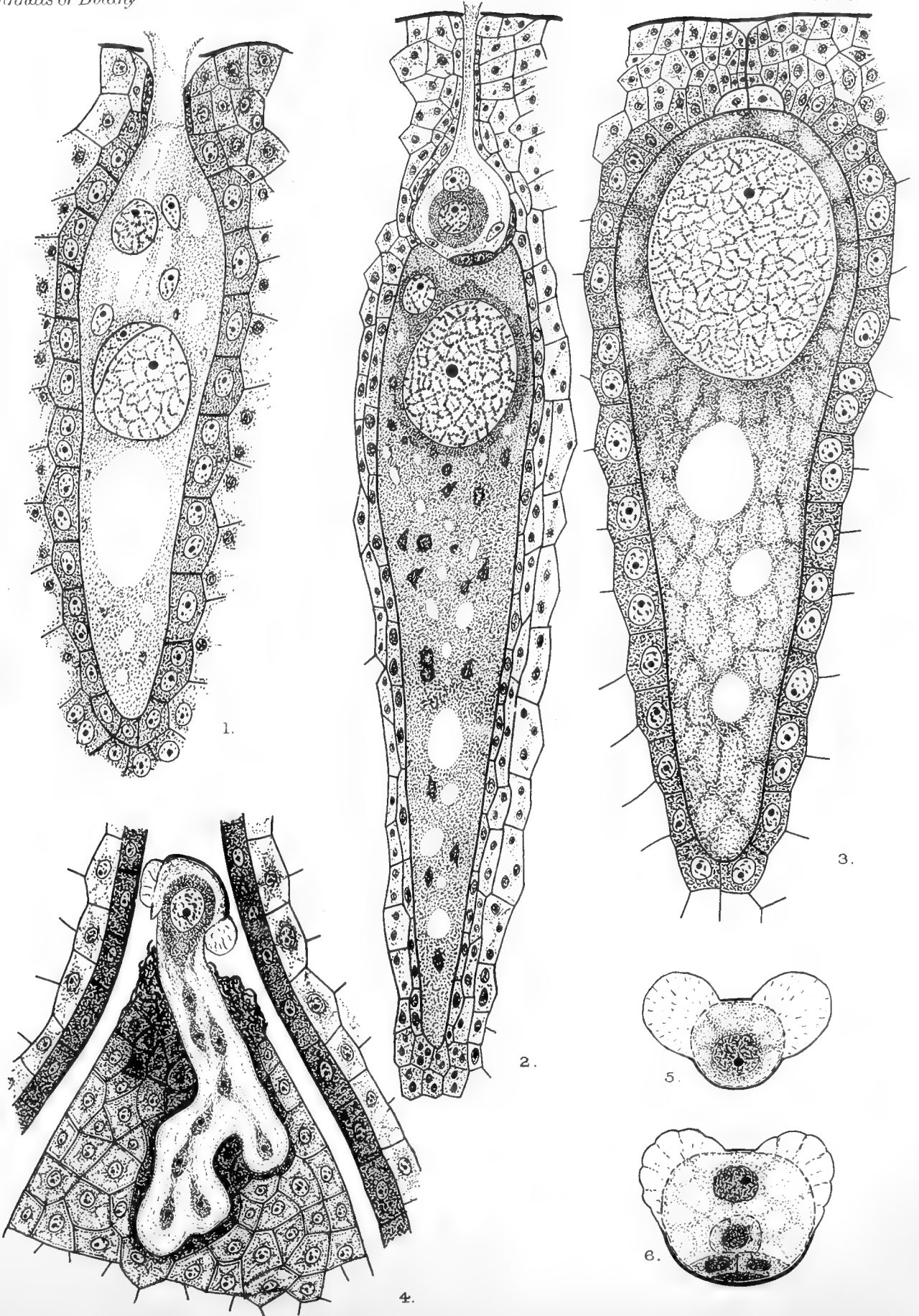

E. W. S. del.

Hugh Lamb.







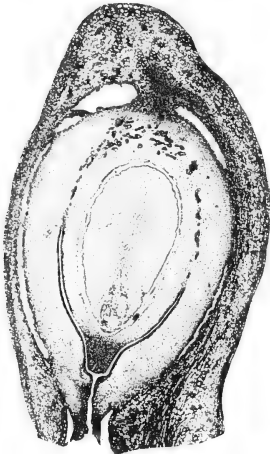

7.



8.

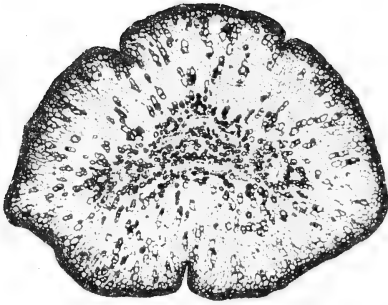

9.



10



11.

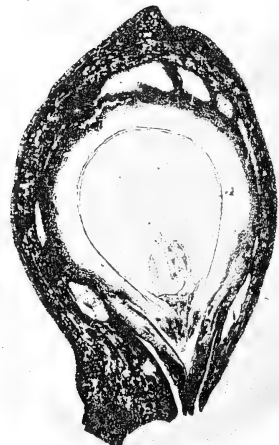

12.



13.



14.



15.

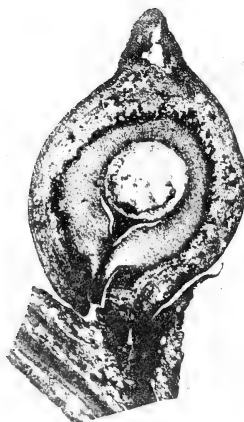

16.



17.

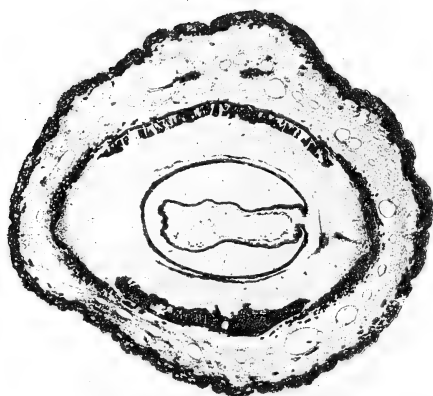

18.

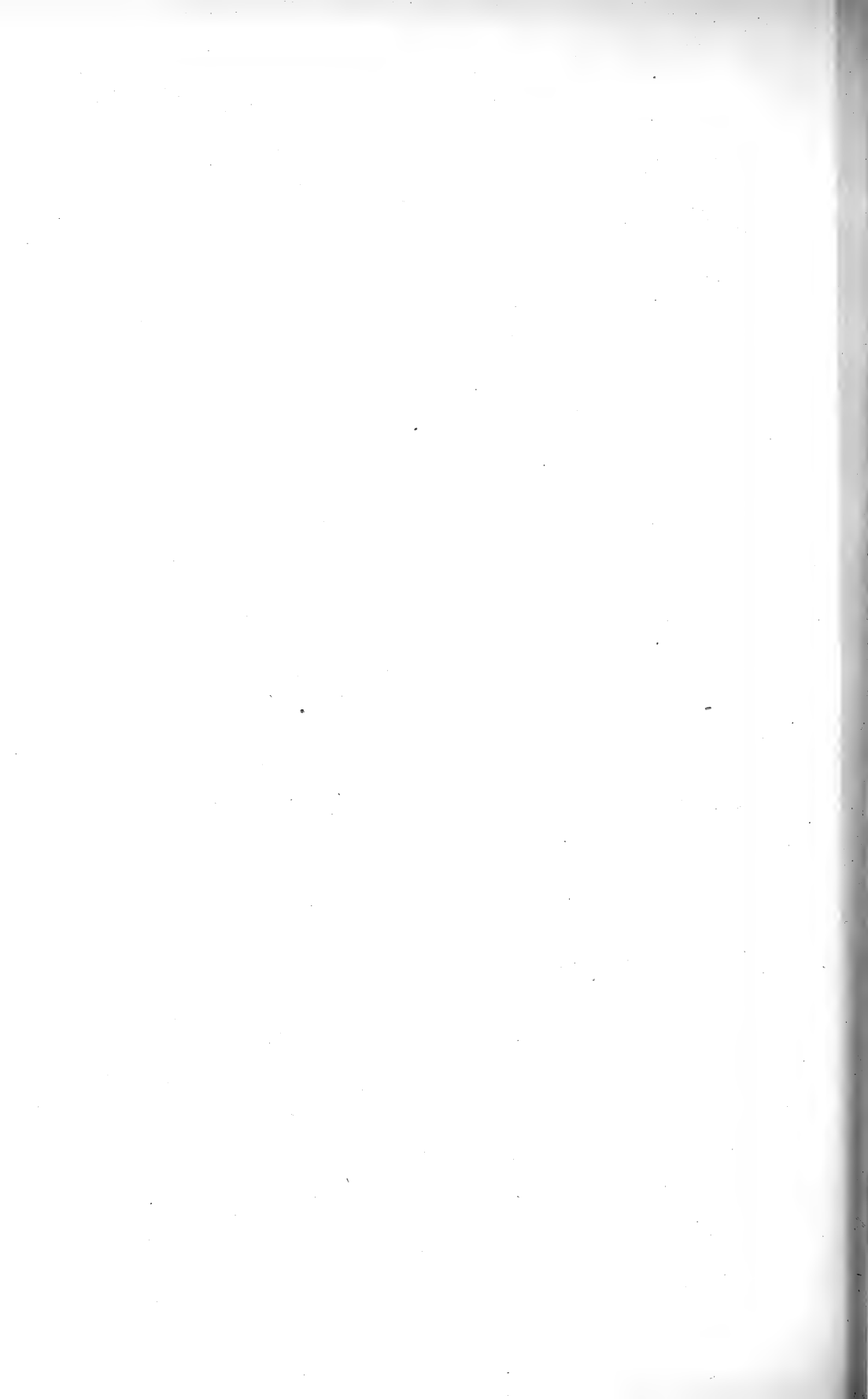





19.

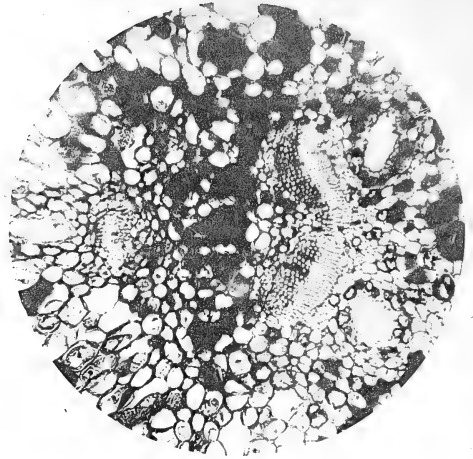

20.



21.

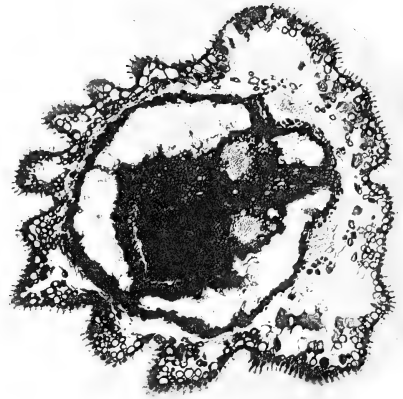

22.



23.



24.

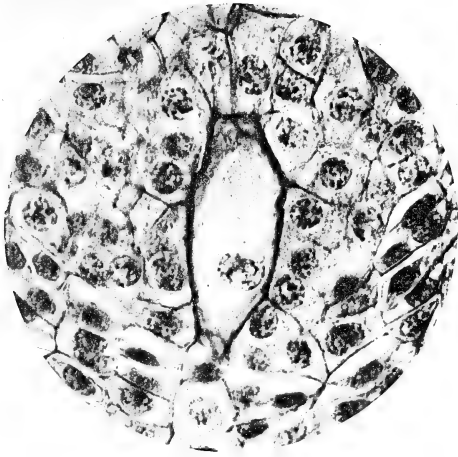

25.

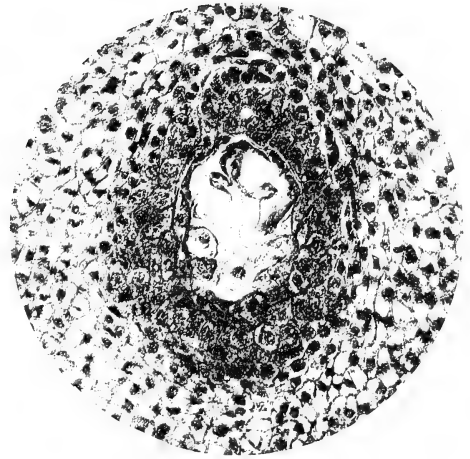

26.



27.

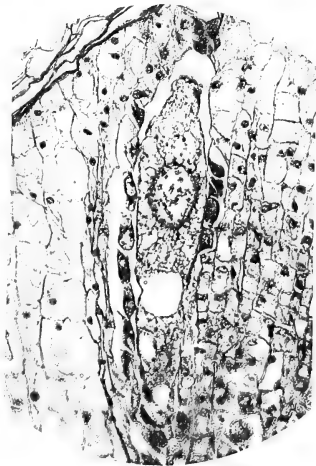

28.

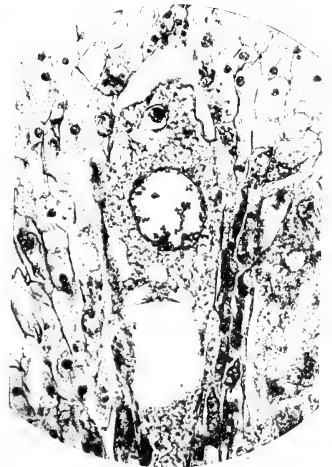

29.



30.



31.

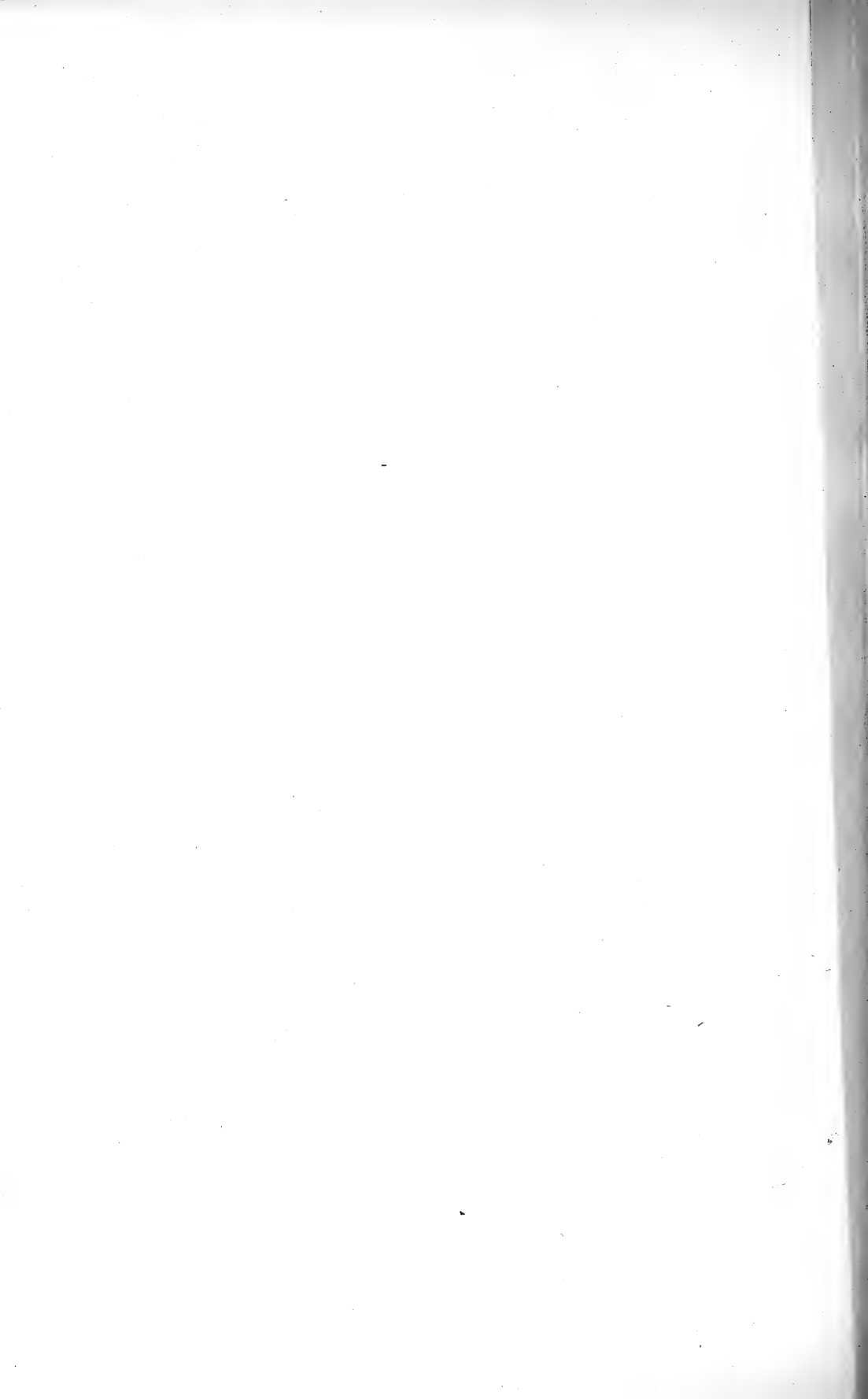





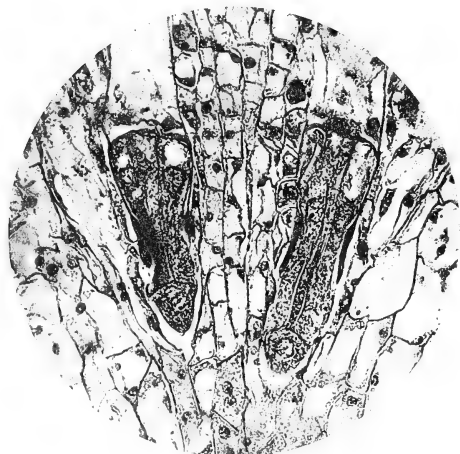

32

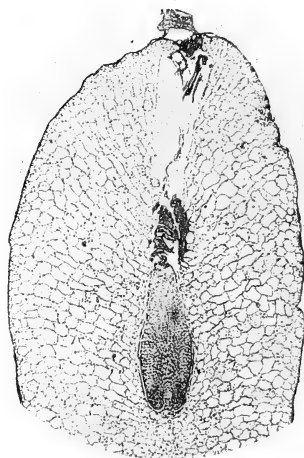

33.

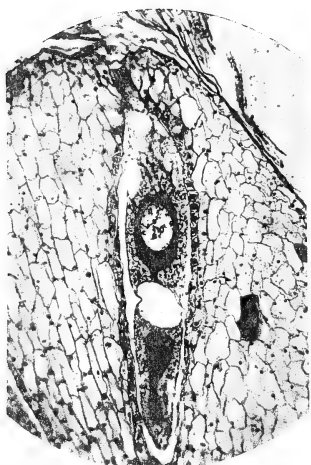

34



35.

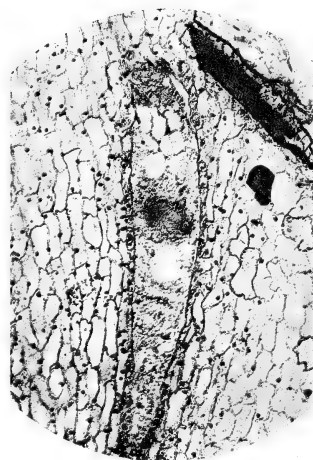

36.



37.

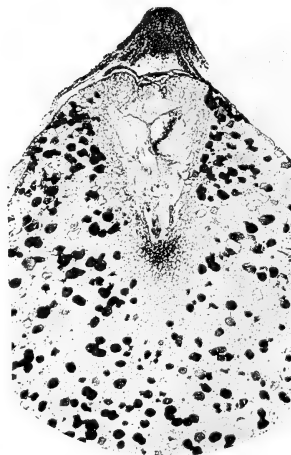

38.

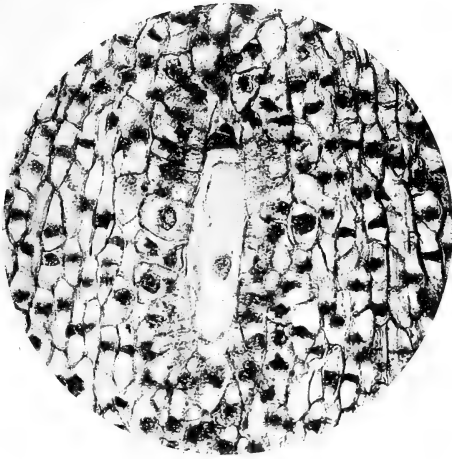

39.

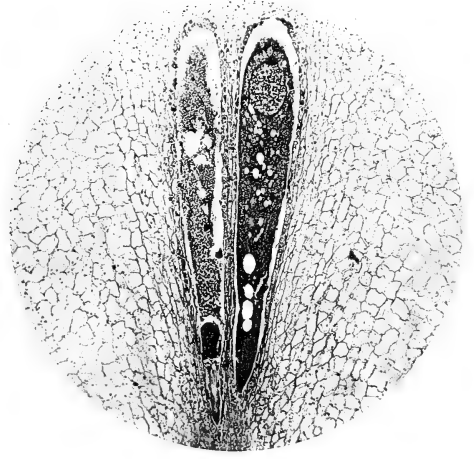

40.



41.

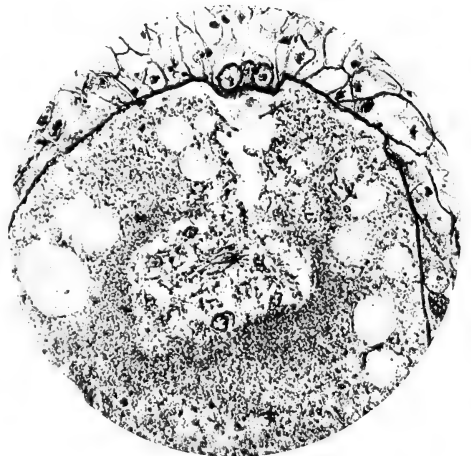

42.

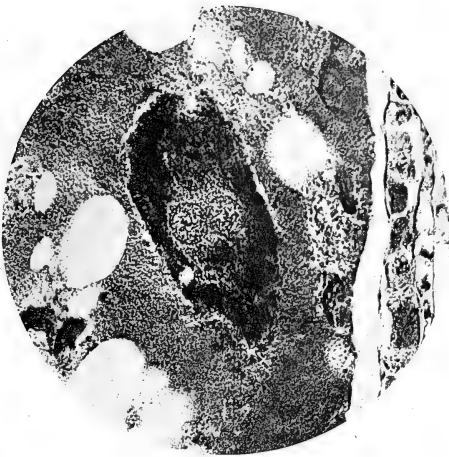

43.

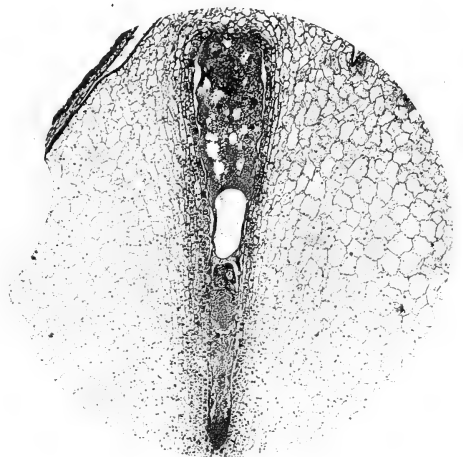

44.



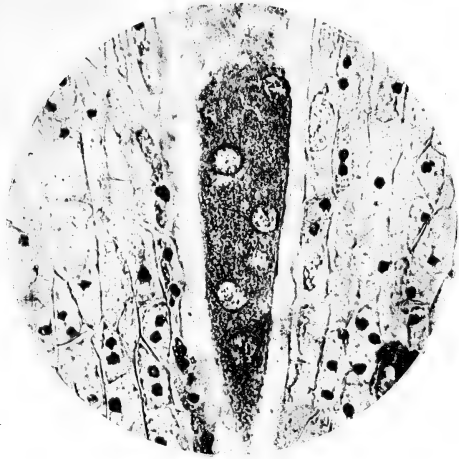

45.

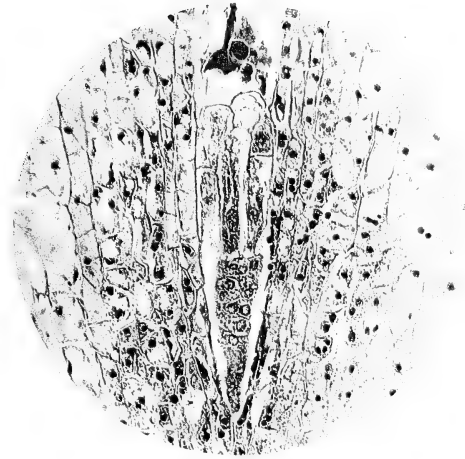

46.

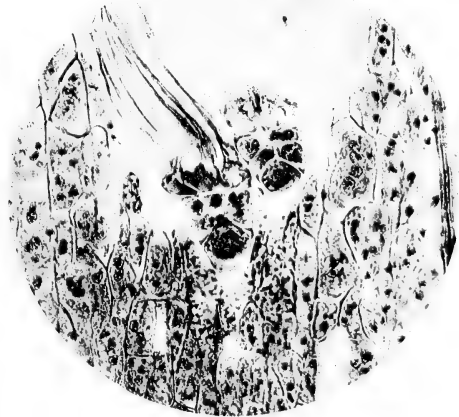

47.

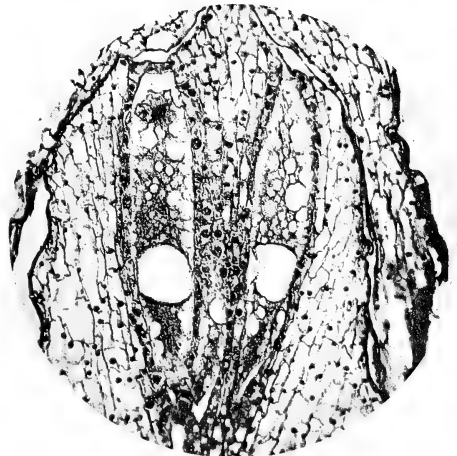

48.

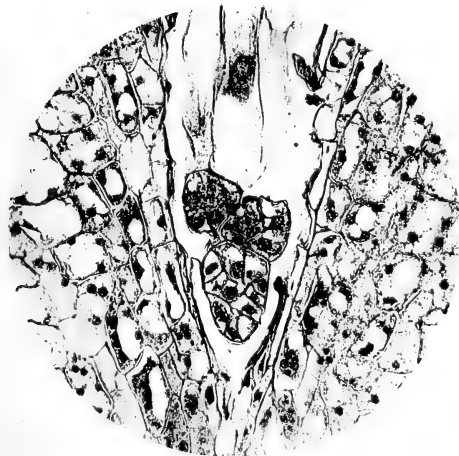

49.

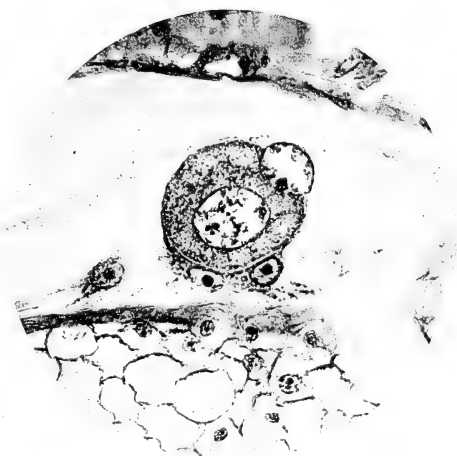

50.



# The Lime-Sulphur Bacteria of the Genus *Hillhousia*.

BY

G. S. WEST, M.A., D.Sc., F.L.S.

AND

B. M. GRIFFITHS, M.Sc.

With Plate X.

IN 1909 the authors published a preliminary account<sup>1</sup> of a new organism which they named *Hillhousia mirabilis*, and which they regarded as a giant sulphur bacterium. Since that date further investigations have shown that the organism is without doubt a huge sulphur bacterium, but one that contains in addition a large amount of calcium carbonate.

Each individual organism is cylindrical with hemispherical extremities, and contains such a large amount of mineral matter that it has a specific gravity about equal to that of the small sand grains frequently associated with it.

It is a peritrichous bacterium with relatively short cilia, and it exhibits slow rolling movements of a rather irregular and often of a spasmodic character.

The cell-wall is very resistant to the passage of reagents, and has been shown to be lamellose.

The organisms are gregarious but not colonial. They have a tendency to adhere to the bottom of a glass vessel, probably by means of the small amount of mucus secreted by each individual.

They occur in the mud of freshwater pools, sometimes in very large numbers. Owing to their high specific gravity they can be obtained partially pure by gradually pipetting off the flocculent organic matter, when the organisms, mixed with a few small sand grains, remain. If the glass dish is carefully tilted the sand grains can be made to roll down, leaving the organisms as a greyish-white mass.

Although it is thus possible to obtain a pure 'collection' all attempts at pure cultures have failed. Such cultures would necessarily be of slow

<sup>1</sup> G. S. West and B. M. Griffiths: *Hillhousia mirabilis*, a Giant Sulphur Bacterium. Proc. Roy. Soc., B, vol. lxxxI, 1909.

growth owing to the length of time (twenty-four to forty-eight hours) occupied by each cell-fission.

It has been found that a good fixative is 40 per cent. commercial formalin, which not only fixes the protoplast moderately well, but also removes the large globules of calcium carbonate, leaving only the protoplasmic reticulum with the numerous smaller grains of sulphur embedded in the threads. Formalin of this strength has, however, a tendency to affect adversely the protoplasmic reticulum, since it has to act for some hours in order to remove the larger globules. On the other hand, dilute acetic acid removes the larger globules at once with slight effervescence, leaving the sulphur grains unaffected, but again there is a slight injury to the protoplasmic reticulum.

The best fixative was one recommended by Professor J. B. Farmer, and consisted of a mixture of three parts of absolute alcohol and one part of glacial acetic acid. This not only removed the globules very rapidly, but also the reddish sulphur grains, and at the same time fixed the protoplasmic reticulum exceedingly well. By this method there was no appreciable shrinkage.

Since the original note, two distinct species of *Hillhousia* have been recognized. In addition to the large one—*H. mirabilis*—there is a smaller species not more than half the size. This small species, which we propose to call *H. palustris*, is distinguished not merely by its size, but also by the more rounded segments during the process of cell-division. Its protoplasmic reticulum is very little smaller than that of *H. mirabilis*, and therefore the cell contains comparatively few meshes.

Both species are widely distributed and appear to have rather different habitats. Doubtless they will be found to exist in many parts of the world.

**THE PROTOPLAST.** After the removal of the globules of calcium carbonate by means of formalin, the protoplast is seen to consist of a more or less uniform and rather coarse reticulum. There is no trace of a nucleus, and the reticulum is evenly distributed throughout the cell, as originally figured.<sup>1</sup> The whole reticulum is very finely granular and appears to contain rather larger granules in the corners of the meshes.

The sulphur grains are rather small (1–2  $\mu$  in diameter), of a reddish colour, and are situated within the threads of the protoplasmic reticulum between the much larger globules of calcium carbonate.

*Dry-staining* is carried out with difficulty owing to the highly resistant cell-wall. Specimens were fixed on cover-slips with 40 per cent. commercial formalin and allowed to dry in the air, the small amount of mucus on the outside of the organisms causing them to adhere. Fairly good stained preparations were obtained with safranin, iodine green, Ziehl's carbol-fuchsin,

<sup>1</sup> West and Griffiths, l. c., Fig. 19.



Giemsa's stain, and iron-haematoxylin (ferric alum and Heidenhain's haematoxylin).

In no case could any large deeply staining granules be detected, although very minute granules which stained rather more than the rest of the protoplasm were distributed throughout the reticulum. In dry-staining there was always an apparent concentration of the reticulum in the central part of the cell (Figs. 4 and 5), this being due to the flattening of the organism upon drying, and the consequent superposition of different parts of the reticulum.

*Wet-staining.* The water containing the living organisms was placed in small tubes and centrifuged, after which the organisms were fixed in three parts absolute alcohol and one part glacial acetic acid. This removed both the calcium carbonate and the sulphur. The collection was then washed thoroughly in alcohol to remove the acetic acid, and afterwards stained with the same stains as used in the dry-staining method. In no case could any true chromatin be detected, but, as before, minute granules staining rather deeper than the rest of the protoplasm were distributed throughout the reticulum. Those granules at the angles of the meshes were a little more conspicuous than the others.

No contraction of the reticulum was visible in any single instance (Fig. 6). We therefore regard the apparent concentration of stainable substance, which is observed after staining subsequent to fixation by drying, as an artifact.

The organism appears to be of a simple type in which as yet there is practically no differentiation of the protoplast.

The granules in the network consist, as previously stated,<sup>1</sup> of a nucleoprotein, and if they are of the nature of a chromatin substance, it is one which differs considerably from the chromatin of more highly organized cells. It has little, if any, affinity for the usual nuclear stains.

In the small species, *Hillhousia palustris*, the structure of the protoplast is precisely similar, but the meshes are fewer in number. (Compare Figs. 6 and 10.)

**THE INCLUSIONS.** The inclusions within the protoplast vary according to the amount of sulphuretted hydrogen and lime-salts present in the water. In a normal individual the cell is filled with refractive granules of variable size, which are of two distinct kinds.

1. *Globules of calcium carbonate.* These are large globules varying from  $6\ \mu$  to  $10\ \mu$  in diameter. They are of a steel-grey colour, highly refringent, and lie in the meshes of the protoplasmic reticulum, one only in each mesh (Fig. 1). They are plastic, being able to pass through the cell-wall without rupturing it. When the organism has been killed by reagents, such as a concentrated aqueous solution of sulphuretted hydrogen, iodine in

<sup>1</sup> West and Griffiths, l. c., p. 403.

potassium iodide, alcohol, or by drying and subsequently re-irrigating with water, the globules pass through the cell-wall and crystallize either on its exterior or in the water in the immediate vicinity. The exudation of the globules and their subsequent crystallization take about fifteen minutes. After prolonged drying this exudation does not occur. The crystals are of two forms, flat rhombohedra with angles  $74^{\circ} 55'$  and  $105^{\circ} 5'$ , or rhombic prisms (*vide* Fig. 3).

The globules are readily soluble in sulphuric acid, hydrochloric acid, nitric acid, and dilute acetic acid. They are also dissolved by formalin in about an hour.

The crystals are readily soluble in all the above acids except sulphuric, when, after partial solution, dense tufts of small crystals (presumably of calcium sulphate) are formed and stop further action.

If the organisms are heated to redness on platinum foil, the globules remain apparently unaffected, and are soluble in the same reagents that dissolve the crystals.

In the Bunsen flame the organisms give the red calcium coloration.

If sulphuric acid is added to a collection of living organisms, gas is given off freely, and when passed into lime-water the gas causes a white precipitate. Therefore it consists of, or contains, carbon dioxide.

If to a collection of living organisms a solution of potassium permanganate is added, and then sulphuric acid, the permanganate is unaffected by the gas given off. There is no carbon monoxide given off, therefore, as in the case where calcium oxalate is similarly treated.

These tests indicate that the globules consist of calcium carbonate. This is confirmed by examination of the crystals with the polarizing microscope. It is found that their optical properties and crystalline form show them to be calcite. Such crystals may be produced chemically by adding a hot solution of ammonium carbonate to a hot solution of calcium chloride, when a mixture of flat rhombohedra and rhombic prisms is produced, identical with those formed from the crystallization of the plastic globules in the organism.

While within the organism the globules do not polarize.

The facts that sulphuric acid will completely remove the globules from the living organism, that gas is not given off very freely with dilute acetic acid, and that the globules will pass through the cell-wall without rupturing it, all appear to indicate that the calcium carbonate is possibly held in a colloidal form while within the organism. That there is a difference between the properties of the calcium salt in the living organism and in the dead organism is also shown by the very brisk effervescence when dilute acetic acid is added to specimens that have been subjected to prolonged drying, or to specimens incinerated on platinum foil.

2. *Sulphur grains.* Small granules varying in diameter from about  $2 \mu$

to mere specks are found lying in the threads of the protoplasmic reticulum. They are of a dull red colour and rather refractive in appearance. They remain in the protoplasm when the organisms are dried and re-irrigated with water, but if left for some days freely exposed to the air they slowly disappear.

They are soluble in hot potassium hydrate, in potassium cyanide, in carbon bisulphide, in chloroform, in strong nitric acid, and in glacial acetic acid. They are unaffected by the reagents that dissolve the globules of calcium carbonate.

If strong picric acid is added to organisms previously cleared of calcium carbonate, and subsequently washed thoroughly in water, the sulphur grains tend to run together and to become crystalline.

If the organisms are mounted on a slide in 40 per cent. formalin, the sulphur grains slowly crystallize in the course of a few weeks. If mounted in dilute acetic acid crystallization takes place in a few hours. The crystals are typical double pyramidal crystals of sulphur of a yellow colour (Fig. 7).

If individuals containing sulphur grains are treated with warm potassium cyanide and ferric chloride, a deep red coloration is produced. Organisms without sulphur grains do not produce this coloration.

When a quantity of organisms containing sulphur grains are burned on platinum foil, a very distinct odour of sulphur dioxide is noticed.

These experiments show that the reddish grains are of sulphur. The sulphur grains of *Beggiatoa* are precisely similar, in appearance and in their behaviour to reagents, to those of *Hillhousia*.

#### CONDITIONS NECESSARY FOR HEALTHY EXISTENCE.

These lime-sulphur Bacteria are easily affected by slight changes in their environment. In order to remain in a healthy condition they require a sufficiency of lime-salts, sulphuretted hydrogen, and oxygen.

*Hillhousia* has been kept in a healthy condition for more than nine months in a glass dish six inches in diameter and two inches deep. The mud in which the organisms normally live was placed in tap-water in the dish, and water was added to replace that lost by evaporation. It was found necessary to stir up the mud frequently in order to get rid of the excess of sulphuretted hydrogen and to aerate the water.

If fresh water is allowed to run through a collection the organisms lose their sulphur within forty-eight hours. If the mud is then left undisturbed so that sulphuretted hydrogen can accumulate, the sulphur grains reappear. The addition of chemically prepared sulphuretted hydrogen to organisms removed from the mud and placed in fresh water also causes the sulphur grains to reappear, provided that the water has been

aerated. If there is not sufficient oxygen, the organisms exude their globules of calcium carbonate, leaving a long double line of crystals of calcite as they move slowly about; and subsequently death ensues.

COMPARISON WITH *ACHROMATIUM OXALIFERUM*, SCHEWIAKOFF.

The large bacterium *Hillhousia* resembles in some respects the organism described by Schewiakoff<sup>1</sup> as *Achromatium oxaliferum*, but differs in many particulars, which may be summarized as follows:

*Achromatium.*

Differentiation of protoplast into a peripheral zone with a small reticulum, and a larger central portion ('central body') with a much larger reticulum.

Conspicuous reddish grains of chromatin (according to Schewiakoff) at the intersection of threads of central reticulum.

Globules of calcium oxalate in the meshes of the reticulum.

No sulphur grains.

Average size:  $29 \mu \times 15 \mu$ .

*Hillhousia.*

No differentiation in the protoplasmic reticulum.

No definite chromatin recognizable by stains, but small granules, possibly of chromatin, in the threads of protoplasmic reticulum.

Globules of calcium carbonate in meshes of reticulum.

Refringent reddish grains of sulphur in threads of reticulum.

Average size:

*Hillhousia mirabilis*,  $60 \mu \times 26 \mu$ .

*Hillhousia palustris*,  $25 \mu \times 14 \mu$ .

Eight years after the publication of Schewiakoff's paper, Massart<sup>2</sup> described and figured an organism as *Achromatium oxaliferum*. He asserted that 'en réalité la couche périphérique de petits alvéoles n'existe pas. . . . Je pense donc que même pour cette immense cellule il faut renoncer à l'espoir de trouver un corps central.' He also found that 'les petits grains très réfringents qui sont engagés dans le réseau protoplasmique sont du soufre', and that '(la cellule) contient une substance qui, contrairement à ce que dit M. Schewiakoff, n'est certainement pas de l'acide oxalique ni un sel de calcium'. The size of the cell as figured is  $30 \mu \times 20 \mu$ .

There is little doubt that the organism described by Massart was not *Achromatium* but *Hillhousia palustris*. The remarks on the structure of the protoplast and the inclusions are in agreement with our observations on

<sup>1</sup> W. Schewiakoff: Ueber einen neuen bakterienähnlichen Organismus des Süßwassers, Heidelberg, 1893.

<sup>2</sup> Jean Massart: Recherches sur les organismes inférieurs. Sur le protoplasme des Schizophytes. Section C. Schizomycètes, b. Thiobactéries, pp. 259-60, Plate I, fig. 7. Recueil de l'Inst. Botanique, Univ. de Bruxelles, tome v, 1901.

that organism, except that the large globules consist of a salt of calcium, viz. calcium carbonate.

An organism has also been described and figured by Virieux<sup>1</sup> under the name of *Achromatium oxaliferum*. He states that 'Schewiakoff y décrit un corps central à mailles plus larges que dans la couche périphérique : pas plus que West, je n'ai pu faire cette distinction'. He does not find that the large globules in the spaces of the reticulum are of calcium oxalate. He expresses doubt as to the composition of the refringent granules in the threads of the reticulum, but is inclined to think that 'ils sont très probablement constitués par du soufre'.

There is not the least doubt that the organism described by Virieux is *Hillhousia mirabilis*, and not *Achromatium oxaliferum*. His Fig. 1 shows the refringent granules of sulphur in the threads of the reticulum as seen after the removal of the large globules of calcium carbonate (consult Fig. 2 on Pl. IX). His Fig. 2 shows the minute granules in the threads of the reticulum after removal of both sulphur and calcium carbonate.

It appears, therefore, that neither Massart's nor Virieux's observations relate to *Achromatium*. That organism has several features in common with *Hillhousia*, the chief of which are the large inclusions of a salt of calcium and the smaller reddish grains in the threads of the reticulum. In *Achromatium*, however, the globules are asserted to be calcium oxalate and the reddish grains of the nature of chromatin. In *Hillhousia* the globules are certainly calcium carbonate (and not calcium oxalate), and the reddish grains consist of sulphur, similar to the sulphur grains in other sulphur Bacteria. The most profound difference is to be observed in the structure of the protoplast, which in *Hillhousia* consists of a uniform reticulum, whereas in *Achromatium* there is a differentiated peripheral zone with a much smaller reticulum.

A copy of one of Schewiakoff's figures of *Achromatium* is given (Fig. 15) for comparison with *Hillhousia mirabilis*.

#### SUMMARY.

The following is a summary of the genus and its two known species :

*Hillhousia*, West and Griffiths, 1909. A genus of Bacteria of relatively large size, with shortly cylindrical cells from two to three times as long as their diameter, extremities hemispherical. Protoplast consisting of a slender network with meshes of fairly regular size. Within each mesh is included a large amorphous globule of calcium carbonate, and numerous smaller grains of sulphur are located in the threads of the network in such a manner that they occupy the interstices between the globules of calcium carbonate. There is no differentiation of any nuclear body from the

<sup>1</sup> Virieux, J. : Sur l'*Achromatium oxaliferum*, Schewiakoff. Comptes Rendus, t. cliv, 1912.

remainder of the protoplasm. The protoplast contains phosphorus, and the nucleo-protein is diffused throughout the reticulum in small granules. These granules are probably a form of chromatin which has but small affinity for nuclear stains.

		Known localities in British Isles. <sup>1</sup>	Habitat.
<i>H. mirabilis</i> , West and Griffiths, 1909.	Length 42–86 $\mu$ . Breadth 20–33 $\mu$ .	Stanklin Pool, Worcs. Gt. Barr Park, Staffs. Studley, Warwickshire. King's Norton, Warwickshire. Near Belfast, Ireland. Near Edinburgh, Scotland.	In all cases in the mud of a freshwater pool.
<i>H. palustris</i> , sp. n.	From $\frac{1}{4}$ to $\frac{1}{2}$ the size of <i>H. mirabilis</i> . Length 14–36 $\mu$ . Breadth 11.5–18 $\mu$ . During division the halves of the cell are much more rounded and the constriction more open.	Near Dewsbury, W. Yorks. Near Bowness, Westmorland. Cannock Chase, Staffs. Fair Head, Antrim, Ireland. Clare Island and near Westport, Mayo, Ireland.	In <i>Sphagnum</i> bogs.

A point of considerable interest is the comparison of the results obtained by the wet-staining and the dry-staining methods. It is possible to obtain a correct idea of the cytological structure only by never allowing the organisms to become dry. Dry-stained specimens all show some kind of concentration of the protoplast, of very variable form, which is purely an artifact. Drawings of such specimens reduced by photography to a size approximately the same as those usually published of much smaller Bacteria show apparent nuclear masses very similar to those asserted to be found in the smaller species. In the case of *Hillhousia* these 'nuclear' masses are certainly artifacts due to the superposition of the protoplasmic threads on drying.

It is possible that similar effects may be produced when smaller Bacteria are prepared by the dry-staining method, and consequently some doubt must be thrown on any conclusions regarding the cytology of specimens prepared in that way.

## DESCRIPTION OF PLATE IX.

Illustrating the paper by Professor West and Mr. Griffiths on the genus *Hillhousia*.

Fig. 1. Normal aspect of living specimen of *Hillhousia mirabilis*.  $\times 500$ . The dark globules consist of calcium carbonate.

Fig. 2. Individual from which the calcium carbonate has been removed by dilute acetic acid.  $\times 850$ . The protoplasmic reticulum is somewhat swollen and distorted, and the conspicuous granules are minute grains of sulphur.

<sup>1</sup> We have also observed *H. palustris* in material collected by Professor H. H. W. Pearson from the sides of a spring at Henkriesfontein, in Little Namaqualand, S. Africa.

Fig. 3. Rhombic crystals of calcite obtained by allowing the organisms to dry and then re-irrigating with distilled water.  $\times 850$ . The apparent triangular face on the side of the crystal away from the observer is an illusion due to refraction.

Figs. 4 and 5. Two specimens stained with safranin after fixation by drying (the usual dry-staining method for Bacteria).  $\times 850$ . The central concentration of the protoplast is in each case an artifact.

Fig. 6. An individual stained with safranin by the wet-staining method after fixation in absolute alcohol and acetic acid.  $\times 850$ .

Fig. 7. Two sulphur crystals obtained from solution in dilute acetic acid.  $\times 1,200$ .

Figs. 8-15. *Hillhousia palustris*.  $\times 850$ . 11-14, different examples showing stages of division; 15, cell immediately after division. The protoplasmic reticulum is only shown in Figs. 8-10 and 15, and both the calcium carbonate and sulphur have been removed.

Fig. 16. *Achromatium oxaliferum*.  $\times 2,200$ . This figure is copied from one given by Schewiakoff (t. ii, f. 3 in his work) and shows the nature of the protoplasmic reticulum.





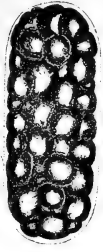

1.

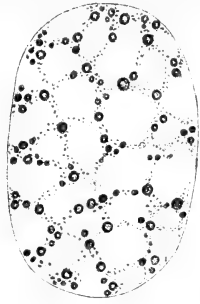

2.

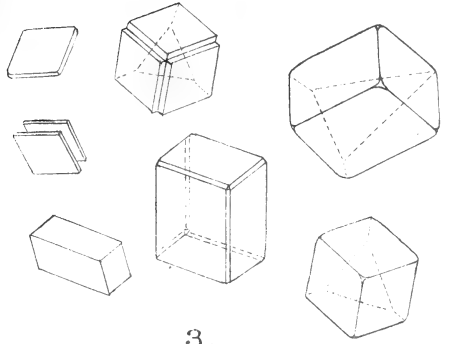

3.

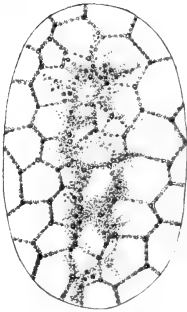

4.

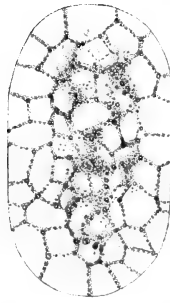

5.

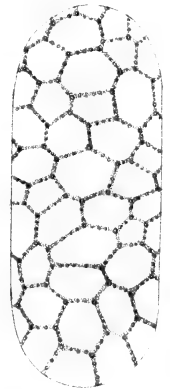

6.



7.



8.



9.



10.



15.



11.



13.



12.



14.

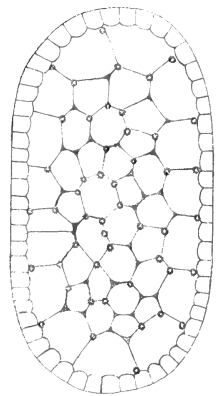

16.

G.S. West del.

Huth lith. et imp.



# Spermatogenesis in *Blasia pusilla*, L.

BY

WILLIAM L. WOODBURN.

With Plate XI.

IN a recent paper I discussed spermatogenesis in *Porella*, *Marchantia*, and *Fegatella*. The essential features in the development of the sperm were found to be quite similar in these three Liverworts. I came to the conclusion that 'we may consider the mature sperm to represent the two constant cell elements, nucleus and cytoplasm; the main body or nuclear portion representing the nucleus, the blepharoplast and cilia representing specialized parts of the cytoplasm, and the remainder of the latter being found in the cytoplasmic vesicle'. In *Marchantia* and *Fegatella* the last division of the spermogenous tissue results in a pair of triangular-shaped spermatids in each cubical cell. No cellulose wall separates the members of the pair, but each is surrounded by a plasma membrane, and becomes directly transformed into the mature sperm. In *Porella* the last division is not constantly in a diagonal plane, but the fundamental features seem to be the same. The phenomena which have caused the greatest amount of discussion are the origin and nature of the blepharoplast, and the origin and nature of the polar body occurring in certain mitotic stages of *Marchantia*, *Fegatella*, *Riccia*, and certain of the Musci. The various views of the more recent writers were discussed in my former paper. Evidence obtained in my previous studies indicated the origin of the polar or centrosome-like body as a differentiation of cytoplasmic or kinoplasmic materials. It apparently does not possess morphological rank, as its genetic continuity could not be established from an examination of closely consecutive mitotic stages. If such a body does exist from one cell generation to the next its chemical nature evidently changes greatly, so as to cause it, at times, to lose entirely its staining capacity. During metakinesis in spermogenous tissue of *Marchantia*, *Fegatella*, and *Porella*, no centrosome-like bodies were found. During the diagonal division those which occur do not show evidence of a centrosome nature, and do not persist, at least with staining capacity, during telophase. The blepharoplast begins its development in the spermatid as a dark, deeply stained granule in a dense area of cytoplasm. It would seem that

this granule is the result of a concentration or differentiation of cytoplasmic material. No evidence is at hand to show its identity with a previously formed body, or that it is of nuclear origin.

Quite recently Wilson ('11) has published the results of a study of *Mnium* and *Atrichum*, two members of the Musci, and *Pellia*, one of the Hepaticae. The latter is of special interest in this connexion, because of its close relation systematically to *Blasia*. Both belong to the anacrogenous group of the Jungermanniales, thus occupying an intermediate position between *Porella* of the acrogenous division and *Marchantia* and *Fegatella* of the Marchantiales. In *Mnium* and *Atrichum* he describes the nuclear origin of the blepharoplast in the spermatid, the nuclear origin of an accessory body, and the same origin for a very unique structure which he terms a 'limosphere'. The latter is a mass of chromatic material built up from rod-shaped bodies, which have passed out into the cytoplasm from the nucleolus. The 'limosphere' is also present in the spermatid of *Pellia*. No such structure has been discovered in the closely related *Blasia* and *Porella*, or in *Marchantia* and *Fegatella* of the Marchantiales. In other respects a number of Wilson's figures show a striking similarity to corresponding ones of the writer's figures of *Blasia*. In the two Mosses investigated, Wilson finds that the blepharoplast may originate from a probable centrosome, a conspicuous centrosphere being present during certain stages of the ultimate division of the spermogenous tissue. He finds also in all three plants a thread distinct in structure from the blepharoplast connecting the latter with the nucleus. The author has observed in *Polytrichum* appearances somewhat similar to stages of the 'limosphere' described by Wilson for *Mnium* and *Atrichum*, but is compelled to interpret them quite differently. Escaped sperms of *Funaria* killed and stained on the slide show practically the same form and structure as do those of the Hepaticae described by the writer. Figures and discussion of *Funaria* and other Musci will be presented in a later paper.

Allen ('12) has made a careful investigation of the spermogenous tissue of *Polytrichum juniperinum*, including the last division and the resulting pairs of spermatids. These he prefers to term 'androcytes', and the earlier cells of the spermogenous tissue 'androgones'; hence the ultimate androgones function as androcyte mother-cells. The androgones are characterized by the presence of polar plates of kinoplasmic material, or in later cell generations by groups of 'kinetosomes' instead of plates. In either case, previous to cell-division, a single plate or group of kinetosomes divides, forming two, each taking up its position respectively at the pole of the succeeding spindle. In the androcyte mother-cell, instead of a plate or a group of kinetosomes, a single 'central body' of quite similar behaviour occurs. Surrounding the central body are radiating fibres, some of which extend away from the nucleus towards the periphery of the cell. Connected

with similar polar bodies in the corresponding cell generation of *Marchantia* the writer found no radiations extending peripherally. Allen had difficulty in tracing this central body through the succeeding phases of karyokinesis, but found evidence which he considered sufficient to establish its persistence beyond a reasonable doubt. After division is complete a body, the blepharoplast, is apparent in the region formerly occupied by the pole of the spindle and the central body. So far as the writer has observed in the Hepaticae, the first appearance of the blepharoplast occurs in a different part of the cell, as will be shown in the following paper.

It may be of interest to compare these results with those obtained from observations on the *Blasia pusilla*. Antheridial plants were fixed in chromic-osmic-acetic acid at intervals during the month of July. The material, after fixing ordinarily for about twenty-four hours, was washed, brought up through the various grades of alcohol, embedded, and sectioned from 2 to 4 microns thick. Anilin safranin and gentian violet were used as stains, and also Heidenhain's iron alum-haematoxylin counterstained with Bismarck brown. The latter combination seemed to give slightly better results.

#### CONDITIONS OF GROWTH.

In southern Indiana *Blasia* frequents the banks of muddy streams, often growing on quite high elevations, where it is exposed in the summer months to considerable desiccation. Its habitat is one of fairly constant, though frequently, in times of drought, of rather scant moisture. Mitotic figures were not found to be plentiful, but practically all stages in the development of the spermogenous tissue with the exception of the spindle of the last division were observed. There seems to have been acquired here, as also suggested in the case of *Porella*, a correlation between the conditions of growth and cytological phenomena in the plant's ability to dry up to a certain extent for a period of time, and then revive with rapid cell-division. *Blasia*, however, requires a much more constant supply of moisture than do the leafy Liverworts, but not so much as do the Marchantiales. In the latter, cell-divisions follow each other rapidly, and the spermogenous tissues are, as a rule, brought to maturity without long periods of delay. There is a noticeable difference between the cells of actively dividing spermogenous tissue and those which apparently have been some time in a resting condition. Fig. 1, Pl. XI, represents a stage in which many antheridia are found. The nucleus shows a very faint membrane, enclosing the nucleolus surrounded by a substance very fine and evenly granular. The cytoplasm surrounding the nucleus has very much the same appearance, except that it is somewhat more coarsely granular. In some cells the structures appear to be more or less disorganized and stain very poorly, while others show definite organization. It is important to consider this

fact in connexion with the study of such plants as are so noticeably affected by the pressure or lack of moisture. In order to draw conclusions which are not the result of observation of artifacts, the material should show some signs, at least, of decided activity.

#### CYTOLOGY OF SPERMOGENOUS TISSUE.

A resting condition of the antheridial cells frequently found is represented in Fig. 1. The cytoplasm is finely and evenly granular. The nuclear cavity surrounding the nucleolus is filled with an extremely fine granular substance, almost homogeneous in appearance. A somewhat lighter space immediately surrounds the nucleolus. The latter is quite sharply defined, and stains very dark and homogeneously. This condition seems to be typical of the tissues after remaining a considerable length of time in a resting condition. As the active conditions arise, and the nucleus passes through the pro phases of division, a fine network appears around the nucleolus, with lumps of chromatin of very irregular size, which form at the intersections of the threads. A definite distinction could not always be made between chromatin and linin, the former being drawn out gradually into finely granular threads, forming a network in which the chromatin seems embedded (Figs. 2 and 3). The nucleolus stains more lightly as the chromatin lumps increase in size and finally disappears, as is the general rule during metakinesis (Figs. 2, 3, and 5). The nucleolus is normally present, except immediately preceding metakinesis and during early telophases. It may reappear in the spermatid soon after the last division (Fig. 10), where it remains differentiated only for a short time if the spermatids are in active development. The finely granular substance of the nucleus passes first into a delicate network, and then the threads of the network seem to be absorbed by the chromatin lumps as the latter increase in size and irregularity (Figs. 2, 3, and 5). A definite spireme has not been observed, but very clearly defined chromosomes result, either from such a formation or from the coalescence of the chromatin lumps. Because of the small number of dividing nuclei observed, an exact chromosome count was not obtained, but Fig. 4 suggests five or six as the probable number. In this and similar mitotic figures no evidence of centrosome-like bodies could be found.

#### FORMATION OF SPERMS.

The last division, like the previous ones, evidently occurs very quickly, judging from the number of stages found immediately preceding and following metakinesis and anaphase. Although not yet observed, the position and form of the resulting spermatids show that the spindle of the last division frequently has an oblique position. Fig. 7 follows very closely the last division. The cytoplasm has not yet divided, as is the case in

Figs. 6 and 9. No wall has been observed between the spermatids as figured by Wilson for *Pellia* and Allen for *Polytrichum*, but the cytoplasm separates into equal masses, each of which with its respective nucleus becomes surrounded by a plasma membrane. No definite centrosome-like body or blepharoplast could be found in those stages represented by Figs. 6, 7, and 8. About this time, however, a small area of cytoplasm denser than the rest appears in one end of each spermatid. The nuclei have in the meantime moved somewhat in opposite directions, leaving the cytoplasm massed on one side of each nucleus, or in opposite ends respectively of each of the pairs of spermatids (cf. Fig. 6, 7, and 8). Fig. 8 represents one of a pair of spermatids drawn from the same section as Fig. 6, but viewed from the back or flattened side, if we speak of the view in Fig. 6 as from the edge. The evidence obtained from a careful examination of the stages similar to Figs. 6, 7, and 9, leaves little doubt that the blepharoplast arises as a differentiation of cytoplasmic material, and agrees with facts observed and described for *Porella* and *Fegatella*. A little later, in each spermatid in the region where the dense area of cytoplasm appeared (Fig. 6) there is found a definite granule or body (Fig. 9). The different writers are quite agreed upon the appearance of this body in the early stages of the spermatid, but not upon its origin and nature. While Wilson does not trace it through the various stages of the last division, yet he thinks it probably arises from a centrosome-like body.

Allen concludes that this is the same morphological entity as the 'central body' which often appears so prominent during the earlier phases of karyokinesis in the 'androcyte' mother-cell.

The results of the writer's observations in regard to the persistence of this body throughout the various phases of the last division of the spermatogenous tissue in the Hepaticae have so far been only negative.

The granule, or blepharoplast, as we may call it, since the latter term indicates its function, grows gradually into a cord along or near the periphery of the cell (Figs. 9, 10, and 11). Fig. 11 shows with remarkable clearness the course and appearance of the blepharoplasts in each pair of spermatids. The one on the right shows the blepharoplast as a cord passing from end to end of the spermatid over the nucleus next to the observer, while the one to the left shows merely the two ends of the cord as the middle portion is hid behind the nucleus and cytoplasm. There is good evidence here that the blepharoplast is formed within the plasma membrane embedded in cytoplasm, and is not a differentiation of the former. The blepharoplast, moreover, appears as a homogeneous cord throughout. The author has taken especial pains to observe its development from its beginning as a small round body until a considerable length has been reached (as in Fig. 11), and no secondary cord has been observed joining the blepharoplast to the nucleus, as one or two writers have recently

described in the Bryophytes, Wilson in *Mnium*, *Atrichum*, and *Pellia*, and Ikeno in *Marchantia*.

In order to understand fully the development of the sperm it is well at this point to compare the views we have in the various figures. Figs. 6, 7, 9, and 11 are corresponding views, all being drawn in a plane at right angles to the plane of the last division, while Figs. 8, 10, 12, and 13 each represent a plane parallel to that of the last division.

The blepharoplast following near the plasma membrane develops into the shape of a comma and approaches a circle. The nucleus in the meantime grows more homogeneous in appearance (Figs. 10, 11, and 12), and becomes crescent-shaped and more closely applied to the blepharoplast. After the stage represented by Fig. 12, it becomes quite difficult to distinguish between blepharoplast and nucleus. The latter seems to increase slightly in size as it becomes more drawn out, and extends from a crescent to a circular form. In Fig. 13 the sperm has lengthened out until it makes somewhat more than one complete turn within the mother membrane. The cytoplasm, which was at first collected within the concavity of the nucleus, eventually disappears, much of it evidently going towards the increase in size of the body of the sperm.

In the stage represented by Fig. 13, the ends of the sperm overlap so closely that it is often difficult to distinguish the two, so that from an observance of this stage only, one might be led into the error of thinking the sperm a complete and closed ring. It is only by following it through its developmental stages that its true nature can be ascertained. M. Leclerc du Sablon ('88) describes a similar picture for *Metzeria furcata*. In speaking of the developing sperm, he says: 'Around the periphery of the cell a thin thread of cytoplasm differentiates, forming a complete circle. The nucleus comes into contact with this thread, . . . becomes smaller and the cytoplasm less dense. The thread or filament seems to be made up from nucleus and cytoplasm. Finally, the nucleus seems to disappear entirely, its substance having been used up to form the sperm. One can see only a colourless vacuole in the centre of the ring formed by the sperm. . . . Soon the ring breaks, the filament thins and lengthens, and gradually acquires the form of the mature sperm.' No figures accompanied M. Leclerc du Sablon's paper, but his descriptions lead one to believe that the figures, if drawn, might have compared quite closely with those of *Blasia pusilla*, as shown by Figs. 12 and 13.

No mature sperms from the antheridium were obtained, but Fig. 14 shows the form frequently found in sections. It is very difficult to obtain them in this way with the cilia intact. These are so long (Fig. 14 shows one approximately 58 microns in length, although they vary much in size), and coiled together in such a manner that the knife usually cuts them at some point or other. In antheridia, however, which are full of mature



sperms, sections or fragments of the cilia are found in abundance, indicating form, position, and number similar to those for other described Hepaticae.

#### SUMMARY.

The mitotic stages in the spermatogenous tissue show no indications of centrosomes, the divisions occurring in the usual manner.

The spindle of the last division may be placed obliquely, but this does not seem to be always the case. A pair of spermatids, however, results from each cubical cell. An individual membrane surrounds each spermatid, but no wall separates the two, as is the case in *Polytrichum* (Allen, '12).

The blepharoplast makes its appearance first as a dense area of cytoplasm in opposite ends, respectively, of each of the pair of spermatids. Gradually a definite granule or body is differentiated, which develops as a thread or cord around the cell near to the plasma membrane. This cord, the blepharoplast, stains homogeneously throughout. Following its course the nucleus lengthens in close contact with the blepharoplast, the two become indistinguishable by the time one complete turn is made, and the body of the sperm which stains like chromatin continues to increase in length until the mature form is reached (Fig. 14). Two cilia are developed, probably, from the forward end of the blepharoplast.

No accessory bodies of any sort corresponding either to the 'Nebenkörper' of Ikeno or the 'limosphere' of Wilson are differentiated.

#### DISCUSSION.

It is of some interest to note how similar the phenomena are which occur in the spermatogenesis of various Liverworts. However, we would expect to find this similarity in the reproductive cells of plants so closely related. Possibly the main point of difference between certain ones—*Blasia* and *Porella*, for instance—is found in the larger size of the sperm body of the former. A larger amount of chromatin, however, seems to exist in the spermatid, and in those stages which lead up to the mature form. The mere matter of size does not seem to be a fundamental difference. A phenomenon of more importance is the appearance of a polar body during the diagonal division in *Marchantia*. But if this body does not have morphological continuity, as my observations led me to believe, there is some question as to how much importance should be attached to it, unless an interpretation be placed upon it different from that given by former writers. It is of interest to recall the fact that of the thallose Hepaticae, *Marchantia* possesses the most highly differentiated gametophyte as regards its general morphology, histology, and the occurrence of centrosomes in the vegetative tissue (Van Hook). The last-named cytological phenomenon, together with the appearance of polar bodies in the metakinesis of the last division of the spermatogenous tissue, may be a concomitant of the morphological and histological differentiation.

Certain developments in *Pellia*, *Mnium*, and *Atrichum*, described by Wilson, form a very striking contrast to those which take place in forms very closely related, at least to *Pellia*, such as *Blasia* and *Porella*. One might expect to find somewhat varying developments on passing over into the Musci. Wilson did not figure the mature sperm in any of the three plants discussed, but the writer finds little difference between the mature sperms of *Funaria* and those of the Liverworts previously described and figured (Fig. 15).

The sperm of the Bryophyta is a model of simplicity and adaptation, and the mature form, which is so admirably suited to the conditions to be met and functions to be exercised, is reached by a very direct and yet gradual transformation. The blepharoplast apparently arises *de novo* as the result of the differentiation of active cytoplasm in the cell in which it is to function. It seems quite probable that the blepharoplast represents not only a cilia bearer, but also a formative portion or region of the protoplasm, which in some manner directs the growth of the spermatid as regards form. It seems quite probable also that, in some cases at least, the actual bulk of the chromatin may be increased at the expense of the cytoplasm. The evident results, of vital relation to the plant's economy, reached by the transformation of the spermatid into the mature form of the sperm, seem to be the preparation of as large an amount of chromatin as possible to be passed into the egg-cell, in a form best adapted to the movements necessarily executed in reaching the latter as quickly as possible. The contour of this form is mapped out by the developing blepharoplast; the form of the nucleus becomes moulded accordingly, and the larger part, if not all, of the cytoplasm is used up in the production of energy for the processes going on, or else become differentiated, adding to the nuclear material of the blepharoplast. There is good evidence that quite a large portion goes to the development of the latter. There seems to be no evidence, in the material I have examined, of chromatin passing out into the cytoplasm. We would hardly expect such to be the case as the nucleus seems to increase rather than decrease in size and staining capacity.

NORTH-WESTERN UNIVERSITY,  
EVANSTON, ILL.

---

#### BIBLIOGRAPHY.

- ALLEN, CHARLES E. ('12): Cell Structure, Growth, and Division in the Antheridia of *Polytrichum juniperinum*, Willd. *Archiv für Zellforschung*, Band viii, Heft I, pp. 121-88.
- IKENO, S. ('03): Die Spermatogenesis von *Marchantia polymorpha*. Beihefte zum Botanischen Centralblatt, vol. xv, 1903, pp. 65-88.

- LECLERC DU SABLON ('88): Sur la formation des anthérozoïdes des Hépatiques. Comptes rendus des séances de l'Académie des Sciences, sér. I, vol. cv, Mar., 1888, pp. 876-8.
- VAN HOOK, J. M. ('00): Notes on the Division of the Cell in Liverworts. Bot. Gaz., vol. xxx, No. 6, Dec., 1900, pp. 394-9.
- WILSON, MALCOLM ('11): Spermatogenesis in the Bryophyta. Ann. of Bot., vol. xxv, No. xcvi, Apr., 1911.
- WOODBURN, WM. L. ('11): Spermatogenesis in certain Hepaticae. Ann. of Bot., vol. xxv, No. xcvi, Apr., 1911, pp. 299-331.

## EXPLANATION OF FIGURES IN PLATE XI.

Illustrating Mr. Woodburn's paper on Spermatogenesis in *Blasia*.

Figs. 3, 4, 7, 8, 9, 11, 12, 13, and 14 were drawn with the aid of the camera lucida and with a Leitz apochromatic 2 mm. objective, 1.30 apert. with compensating ocular 18.  $\times$  3,000.

Figs. 1, 2, 5, and 10 were drawn with the aid of the camera lucida and a Spencer achromatic 1.5 mm. objective and Bausch and Lomb  $\frac{1}{2}$ " ocular.  $\times$  2,000 at table level.

### *Blasia pusilla*.

- Fig. 1. A cell of spermogenous tissue in a resting condition.
- Fig. 2. Nucleus of a spermogenous cell in early prophase of division.
- Fig. 3. A slightly more advanced stage than Fig. 2, showing the condition of the cytoplasm.
- Fig. 4. Anaphase.
- Fig. 5. Spermogenous cell just previous to last division. The membrane has drawn away from the cell-wall.
- Figs. 6 and 7. Pairs of spermatids immediately following the last division, showing different conditions of the chromatin, and the dense areas of cytoplasm where the blepharoplast will appear.
- Fig. 8. Spermatid in the same stage of development as in Figs. 6 and 7, but viewed from a different angle. The section lies in the same plane as that of the last division.
- Fig. 9. Pair of spermatids, showing the blepharoplast organized as a definite granule. The cytoplasm represented in Fig. 5 has divided.
- Fig. 10. Single spermatid. Blepharoplast beginning to lengthen; viewed from the same angle as Fig. 8.
- Fig. 11. Pair of spermatids, showing the course of the blepharoplast.
- Fig. 12. Sickle-shaped spermatid in about the same stage of development as in Fig. 11, viewed from the same angle as in Fig. 10, showing nucleus and blepharoplast in close contact.
- Fig. 13. Sperm becoming coiled within the spermatid membrane.
- Fig. 14. Mature sperm as found in antheridium. The cilia have become detached.
- Fig. 15. Mature escaped sperm of *Funaria*, showing blepharoplast and cilia.



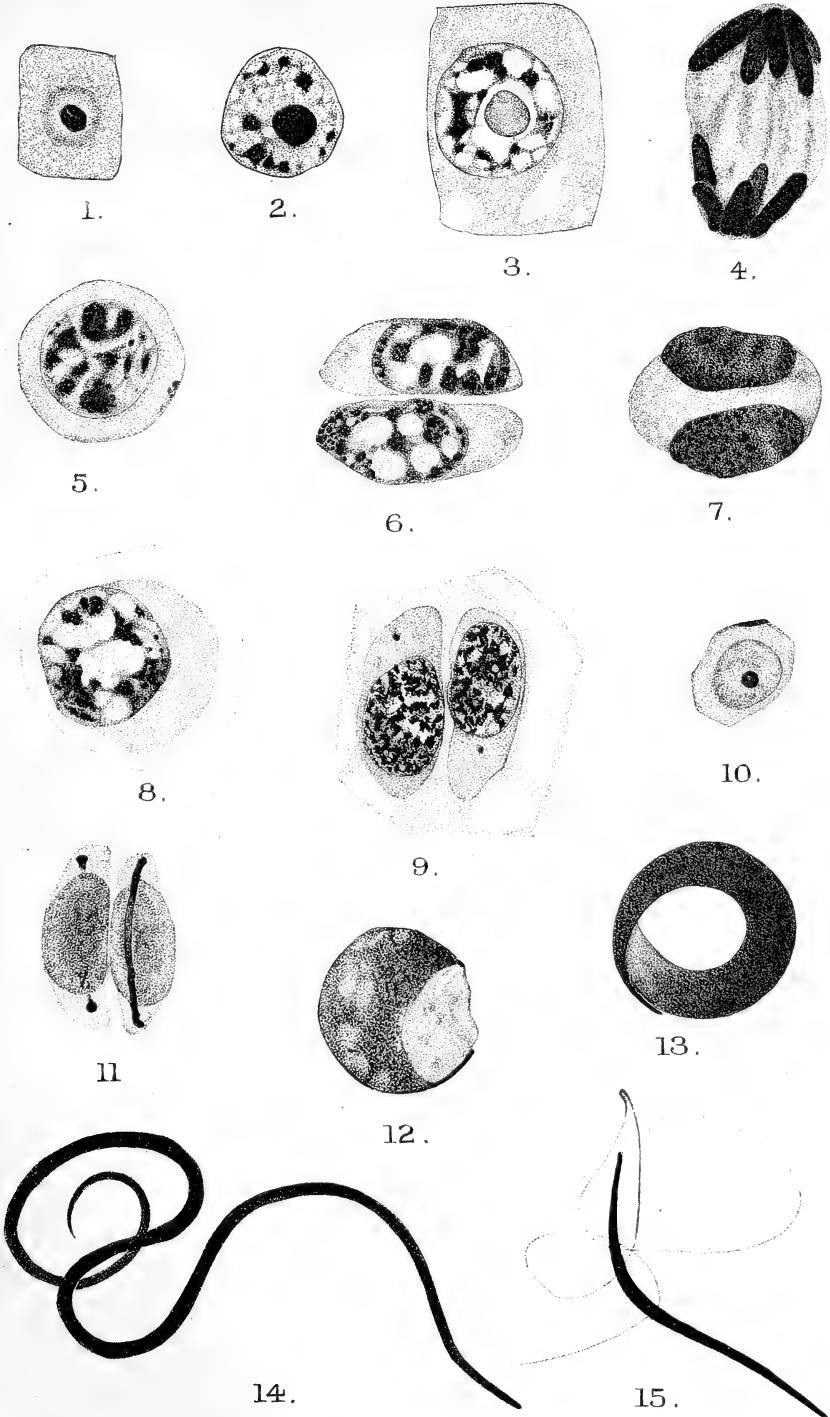

Woodburn del.

Huth lith, et imp.



# Apparent Fallacies of Electrical Response in Cotton Plants.

BY

W. LAWRENCE BALLS, M.A.,

*Fellow of St. John's College, Cambridge; Botanist to the Egyptian Department of Agriculture.*

With a Diagram in the Text.

THE present note describes briefly some results, negative in themselves, but none the less interesting, obtained in an abortive attempt to use the electric reactions of plant tissue, described by Waller,<sup>1</sup> as a general test for healthiness in Egyptian cotton plants.

The significance of these electrical responses or 'blaze currents' is obscure, but they at least differentiate between dead and living tissue, and their intensity might be expected to decline along a gradient as the tissue became less healthy. It seemed, therefore, that they should provide a simple and rapid means of obtaining a rough expression of the progress of the injury done to cotton plants by the root-asphyxiation which takes place when the Nile rises, through the direct and indirect rise of the water-table. Study of the injury to the root itself at least should be facilitated, as samples of roots could be taken up with a soil-borer and tested, whereas it is practically impossible to duplicate the field conditions of a root-system and at the same time to conduct observations upon it.

These expectations have been quite falsified, and though the method holds good as a 'death-test', it does not seem to be a 'vitality-test' in a quantitative sense. Moreover, it failed of its object with regard to the testing of root-samples, because the small roots give most insignificant responses.

<sup>1</sup> A. D. Waller: *Signs of Life*, and references. London, 1903.

J. Chunder Bose: *Electrical Response in Plants*. London, 1910.

The writer only made acquaintance with this later work of Mr. J. C. Bose after these notes had been put together in their present form, when he found that most of the matter had been anticipated by Bose on a much wider scale; notably, the reversal of polarity in fatigue, and the dependence of response upon anisotropic structure. These two phenomena seem to the writer to be of supreme importance in the elucidation of electrical responses, and as Mr. Bose's book contains much other matter, the present writer may perhaps be excused for maintaining the restricted scope of this article, without the amplification which should have been made in the light of Bose's researches.

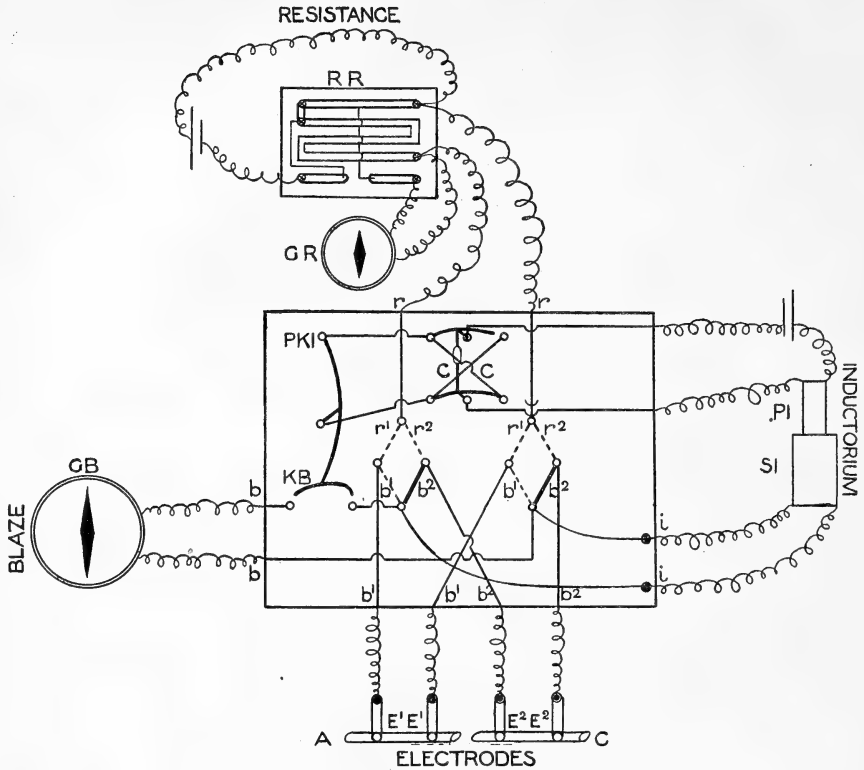

Switchboard with appendages in diagrammatic plan.  $\circ$  = Mercury cups  $\diamond$  = Bridge switch

- Resistance RR Post Office box and cell
- GR Unipivot galvanometer
- r Leads to switch
- $r^1 r^2$  Bridges ( $r^1 r^1$  to  $E^1 E^1$ , or  $r^2 r^2$  to  $E^2 E^2$ )

After testing resistance, the bridges are swung round to positions  $b^1 b^1$  or  $b^2 b^2$

- Inductorium PI Primary coil and cell
- SI Secondary coil
- CC Commutator in primary circuit
- PKI Key breaking primary circuit (and in its fall closing blaze circuit at KB)
- KB Key closing blaze circuit at a regular interval after break at PKI

- Electrodes E Paired U-tubes
- A Tested object
- C Control
- $b^1 b^2$  Leads from electrodes to switch. Also acting as leads for secondary from switch to electrodes

- Blaze GB Ayrton-Mather galvanometer
- bb Leads from switch to galvanometer
- KB Key closing blaze circuit at a regular interval after break at PKI

Note. After testing  $E^1 E^1$ , lift bridges from  $b^1 b^1$  and close PKI before inserting bridges in  $b^2 b^2$  for the testing of  $E^2 E^2$ . The make-shock is thus evaded



Bearing in mind that the experiments were undertaken simply in order to develop a Testing Method rather than as a real investigation of these phenomena in themselves, the following data may possibly be of use for the reference of other plant physiologists who also have been sceptical as to these apparently lawless outbreaks of energy.

*Apparatus.*—The home-made apparatus employed was based on that described by Waller, with modifications. Its only notable feature was a mercury switchboard, arranged in such a way that two pairs of electrodes—the tested object and a control—were *always handled alternately* (Fig.). By bridging over from cup to cup, it was possible to obtain in a very few minutes the resistance of the tissues and a series of antidrome and homodrome responses from both alternately, with occasional observations of the circuit zeros, of the galvanometer zero, and of the deflexion of either circuit by a standard voltage.

Another set of bridges on the same board enabled a Method of Balance to be employed whereby the control and the test-object were connected in series and then in parallel, and stimulated with a single shock from the inductorium; if the two were identical, no response resulted from stimulation in parallel, and any fatigue effects were equally shared by both, while an increased fatigue on the part of one over the other led to an increase in the compound response with each successive stimulation. Since there are numerous risks of manipulation in this method—which I believe is original—it was used as a supplement to the simple alternate testing.

A few trials were made on plants *in situ* in the field along a telegraph wire, but the difficulty of avoiding electrode fallacies makes this method impracticable, and it was only tried in order to make sure that the response of an organ was much the same before and after its removal from the plant.

Resistances were measured by a Post Office box with a Paul Unipivot galvanometer. Induction shocks—always breaks—were given by a small Ruhmkorff coil, purchased locally, whose description I am unable to give; with one Leclanche cell it gave a spark about one-fiftieth of a millimetre long, which was the usual stimulus, as being strong enough to induce marked fatigue after four or five repetitions; tetanization with this stimulus was bearable by wetted fingers on the electrode zincs.

The galvanometer employed was the Ayrton-Mather, made by the Cambridge Scientific Instrument Co., with a resistance of 22 ohms at 15° C., giving a deflexion of 155 mm. for one microvolt at a distance of one metre. This instrument is by no means an ideal one for the purpose, being somewhat insensitive, but this fact does not vitiate the particular results obtained, since the method employed was a comparative one throughout, as described above.

The maximum 'response' deflexion obtained in some 2,000 stimulations

was slightly over 200 mm. The inertia of the moving coil in this instrument is fairly high, so that it is not easy to decide what the real momentary values of the response might be. Since the experiments were all strictly comparative this is unimportant. An ordinary 'good response' gave about 40–50 mm. deflexion.

Three methods of stimulation were used in the preliminary work, namely, mechanical injury, induction shocks through independent electrodes applied over one or the other non-polarizing electrodes, and induction shocks through the latter themselves with the galvanometer out of circuit. In the latter method, which was the only one employed regularly, a falling key broke the primary and then closed the galvanometer circuit in rapid succession.

The non-polarizable electrodes were of the U-tube pattern, mounted in pairs with an interval of 15 mm. between the centres of their contacts with the tissues. It was found that all trouble from their polarization was best avoided by dismounting them after an hour's work and cleaning them; the zincs were dipped in weak sulphuric acid and washed in running water, the glass plugs removed, cleaned and washed, and stuffed afresh with filter paper and a cap of clay, all wetted with 0.6 per cent. saline. After the electrodes had been used for four or five hours, fresh saturated zinc sulphate was placed in the U-tubes.

#### EXPERIMENTAL RESULTS.

*Feebleness of response from the root.*—The first disappointment of these trials was the weak response obtained from young roots of about a millimetre in diameter, however the electrodes were placed. Old woody roots responded freely.

Since it seemed likely that the effect of a break shock through the electrodes might be less effective than a local stimulation over one electrode, such stimulation was tried, but with no better results. A notable blow from a falling lever was required to produce a slight response, and in no case—either with roots or other tissues—was it found possible to obtain a larger response by any other method than the simple one of a break shock through the electrodes.

*Response dependent on structure.*—It seemed then that the magnitude of the response was in part due to the *non-homogeneity or anisotropy* of the length of tissue tested. Thus, with one electrode on the hypocotyl and the other on the root, large responses were usually obtained, and next in magnitude to these were the responses from the last two internodes of the main axis, where one electrode was on semi-meristematic tissue and the other on partly differentiated tissue (Table I). The direction of the initial response with moderate shocks was a function of the structure; thus, with

one electrode on the stem near the seed-leaf stalks and the other nearer the ground, the former point was always 'zincative' in the beginning.

*Currents of injury.*—With ordinary care in handling the material the current of injury was insignificant, and all the experiments were, in fact, conducted without the use of a compensating current. The exception to this was provided by the tender tissues of the apical bud and youngest internodes of the stem. In these the injury current was frequently of fair magnitude and of some hours' duration.

*Fatigue.*—Using the moderate induction shock already mentioned, it was found that a very definite fatigue, or progressive numbing of the response, was exhibited, ending in a *reversal of polarity* in the tissue (Table IV). Some attempts were made to ascertain whether the form of this fatigue-curve could be in any way utilized, but without result. Attention was also directed to a possibility that the weakness of root-responses might be due to the employment of too powerful a stimulus, but no indication of such an effect was obtained; the absence of a sledge-coil hampered this inquiry.

*Similarity of plants at various times of the day.*—The physiological condition of cotton plants in Egypt at dawn, at noon, and at midnight are so extraordinarily different, especially in May and June,<sup>1</sup> that they might be expected to show some difference in electrical response. Comparable plants removed from the field at these times, and immediately tested in various parts, showed no clear differentiation (Table I), excepting that the terminal bud (which at noon is not growing) gave feebler responses in the middle of the day. Even this result was not constant.

*Immersion of the root-system in water.*—Comparable pots of seedlings of the same age were tested, whereof one pot had been immersed in water over the soil surface for varying periods, while the other was watered as usual. The first pair of pots tested over a period of four days gave definite results (Table III), showing deterioration of the blaze-current from the water-logged pot, beginning at the root-hypocotyl junction and moving upward to the first and second internodes. The result was, however, fallacious; for instance, the second pair tested reversed this behaviour by giving markedly stronger blazes at all times from the water-logged pot. These water-logged plants showed that they were not in normal health, in spite of their free responses, by subsequently shedding their lower leaves.

*Desiccation.*—Pots of seedlings were allowed to dry up and tested against controls. Two days before their death the blaze from them was scarcely inferior to that from the controls (Table IV), when they were unable to stand erect and when some were only just able to recover on watering.

<sup>1</sup> The author: *The Cotton Plant in Egypt*. London, 1912.

## CONCLUSIONS.

This last failure made it abundantly clear that if the electrical test could not conveniently differentiate between such very sickly plants and their normal brethren, the primary object of the experiments—namely, a test for *partial* damage by root-asphyxiation—was doomed to failure, and the work has been for the time abandoned.

The subject is evidently more important than it is commonly believed to be, and the writer hopes to re-examine it in the future with the desire of finding some clue to the apparent contradictions of the present data. The appliances will remain in use as a routine test for life and death.

A possible hypothetical explanation of these negative results seems to lie in the form of the curve which may be plotted to represent the diminution of the response with loss of vitality. Thus the writer at first imagined that this curve would be fairly uniform, or even straight. If, however, it were logarithmic in form, the loss of vitality might progress steadily for some time without becoming noticeable by these comparatively rough experimental methods, while at a stage somewhat beyond that to which these tests have usually been carried, the slope would become rapid and noticeable, finally diving down to the death-point.

On the other hand, the curve of fatigue (Table II) does not seem to admit of such an explanation, and fatigue from repeated shocks ends ultimately in death. Here the diminution in response is very marked between the first and second stimuli, then tolerably uniform until well beyond the reversing point—which might well be due to differential fatigue—and finally dying out until the response is merged in polarization errors.

Lastly, the critical point at issue is the nature of 'vitality' itself, and it would seem to the writer that the present apparent contradictions offer a fair ground for physico-chemical inquiry.

## SUMMARY.

1. This note describes an unsuccessful attempt to utilize electrical response as a test for health in Egyptian cotton plants.

2. During the tests it was discovered (*a*) that the initial magnitude and sign of the response obtained was dependent on the degree and direction of the asymmetry, anisotropy, or non-homogeneity of the two points of electrode contact; (*b*) that fatigue by repetition of stimulation usually led to a gradual reversal of the direction of response before complete insensitivity was reached.

3. The currents recorded as responses were the result of genuine differences provoked between the two portions of a tissue on which the electrodes rested. They were not pre-existent in the electrodes or tissues, and were not due to polarization.

That they were, moreover, contingent on the 'livingness' of the tissue is shown by the fact that boiling, fatigue, or tetanization abolished the response entirely.

4. Two improvements in method were devised and used:

(a) Method of Control, consisting in duplication of electrodes and leads, with examination of test-subject and a control alternately throughout.

(b) Method of Balance, being an alternating connexion of text-subject and control in series or in parallel, with consequent augmentation or neutralization of the response.

My thanks are due to Dr. Wilson, of the Cairo School of Medicine, for advice and interest, to my colleague, Mr. F. Hughes, for the loan of the Post Office box, and to Professor A. D. Waller for kindly and stringent criticisms on the manuscript of this note.

TABLES SHOWING TYPICAL RESULTS.

Two components are given for each tissue tested, namely, the resistance in ohms, and the value of the response as millimetres deflexion of the galvanometer.

The testing was in all cases done in duplicate, with a control on the same switchboard. The value of the response is given in pairs; thus in Table II the readings run :

A. 134, 62 : 41, 34 : 34, 24 : 13, 6 : -16, -23.  
 C. 88, 54 : 39, 42 : 35, 28 : 30, 15 : - 9, -21.

These imply that an antidrome shock on A gave 134; during the recovery of A an antidrome shock on C gave 88; the primary circuit was then reversed and A was tested again with a homodrome shock, giving 62 mm. deflexion, and then B gave 54 with the same treatment. This succession continues to the end of the row of figures.

In all cases the interval between stimuli was only so long as was required for the previous response to die down. Correction is made for slight displacements of the circuit zero through injury currents.

Four response readings or more were usually taken when the initial one amounted to more than 10 mm. deflexion.

TABLE I.

Response from various parts of similar field plants at different hours of the day :

Portion tested.	Upper line = response.		Lower line = resistance.	
	Noon.		Time.	
			10 p.m.	7 a.m.
Root 10 cm. below soil-surface	8, 10 :	190,000		67, 50 : 35, 48 : 115,000
Hypocotyl-root junction	45, 40 : 55, 65 :	300,000	50, 53 : 45, 50 :	55, 50 : 40, 38 :
First leaf	1, 4 :		2, 5 :	20, 17 :
midrib	370,000		300,000	320,000
Fifth leaf	9, 10 :		3, 6 :	10, 3 :
midrib	200,000		—	300,000
Fifth leaf	9, 8 :		12, 18 :	5, 3 :
petiole	250,000		300,000	600,000
Youngest leaf, i. e. 10th leaf	8, 9 :		9, 23 : 25, 11 :	8, 20 : 12 :
	170,000		180,000	—
Youngest internodes of stem.	20, 15 : 12, 18 :		56, 25 : 27, 55 :	85, 110 : 99, 98 :
	120,000		110,000	75,000

TABLE II.

*Fatigue.*

Hypocotyls of two similar seedlings :

*Resistance* : A. 130,000; C. 160,000.

*Response* : A. 134, 62 : 41, 34 : 34, 24 : 13, 6 : -16, -23 : &c.

C. 88, 54 : 39, 42 : 35, 28 : 30, 15 : -9, -21 : &c.

(Mean response : A. 37.7; C. 36.1.)

Direction of deflexion reversed as fatigue increased, up to about -40, and then died down to zero after about fifty more shocks.

TABLE III.

Damage by root-asphyxiation :

A. Seedlings from pot immersed in water.

C. Control.

Values of resistance and mean response (*b*) from A expressed as percentage of values from C.

Root.		After 24 hours.	After 54 hours.	After 100 hours.
<i>Hypocotyl junction</i>	<i>b</i>	20	38	50
	R	200	76	90
<i>Hypocotyl</i>	<i>b</i>	100	37	43
	R	90	22	180
<i>First internode</i>	<i>b</i>	—	70	50
	R	—	100	210
<i>Cotyledons</i> <sup>1</sup>	<i>b</i>	—	5	?
	R	—	150	100

The first repetition of this experiment gave, e.g. for first internode after 100 hours, the following result :

R = 350,000 in both A and C.

*Response* : A. 74, 58 : 45, 32.

C. 79, 54 : 54, 38.

TABLE IV.

*Desiccation.*

A. Plants had wilted, and died two days later.

C. Control.

*Resistance* : 400,000 in both.

*Response* : First internode. A. 47, 36 : 35, 31.

C. 69, 62 : 51, 45.

Hypocotyl.

A. 21, 30.

C. 47, 75.

<sup>1</sup> Cotyledons shed in following week.

# Fertilization in *Lilium*.

BY

V. H. BLACKMAN, Sc.D., F.L.S.,

AND

E. J. WELSFORD, F.L.S.

With Plate XII.

ALTHOUGH the process of fertilization in the higher plants has received much attention we are still surprisingly ignorant of many of its important physiological and anatomical details. The behaviour and function of the synergids, the nature of the mechanism by which the two male nuclei reach their respective goals, the exact relation of the pollen-tube to the embryo-sac and the manner of the tube's opening, the stage at which vermiform nuclei first take on their peculiar shape, are all problems which require further investigation. What important results are to be obtained by a careful study of a few forms is shown by Nawaschin's<sup>1</sup> investigation of *Fritillaria tenella*, *Fuglans nigra*, and *Helianthus annuus*. He shows how different are the details of fertilization in these three forms, and brings forward very convincing evidence for the view that, in these cases at least, the male nuclei are motile, making their way through the embryo-sac by their own activity.

The observations here briefly described are the result of the investigation of some material originally intended for class-work. Portions of ovaries of *Lilium Martagon* were fixed in the summer of 1907 and put on one side. When examined later it was found that the fixation was extremely good, and that some of the material had been caught at a very fortunate stage. The quality of the material is shown by the fact that on *one* slide no less than twenty-two *triple* fusions were to be observed, and in many of the same ovules the fusion of the male and female nuclei could also be seen.

<sup>1</sup> Ueber das selbständige Bewegungsvermögen der Spermkerne bei einigen Angiospermen. Österreich. botan. Zeitschr., lix, 1909, p. 457.

This led to a close examination of the material, and later similar material was obtained of *Lilium auratum*; and material of *Petunia violaceae* was also collected for comparative observations of a Dicotyledon. As this work has been interrupted before completion it seemed worth while to publish figures and a brief description of the results obtained in *Lilium*; for it is a surprising fact that while *L. Martagon* was one of the first forms in which triple fusion was observed, yet there exist no really satisfactory figures even of the more obvious details of fertilization of that form. Guignard's well-known illustrations, though sufficient for demonstration, are only text-figures and leave much to be desired.

One of the points which our figures bring out clearly is the complete absence of male *cells* even at the stage in which the nuclei have only just left the pollen-tube (Pl. XII, Fig. 5). In fact Nawaschin<sup>1</sup> has recently shown that the *cytoplasm* of the generative cell is lost in the general cytoplasm of the pollen-tube at the time that its nucleus gives origin to the male nuclei.

In all cases the male nucleus fusing with the polar nuclei is somewhat larger and more contorted than that which fuses with the female nucleus. The figures here published show more clearly than earlier ones the form and structure of the male nuclei of *Lilium*. When the male nuclei have just entered the embryo-sac, but are still surrounded by the contents of the pollen-tube (Fig. 5), the vermiform character is very apparent, and the chromatin, though not of an ordinary resting type, yet shows a network.<sup>2</sup> At a later stage (Figs. 1 and 6) the chromatin stains more deeply and begins to be arranged in threads. Later on (Figs. 2 *a*, 2 *b*, 2 *c*) the chromatin threads are very thick and distinct. Nawaschin associates these signs of activity in the chromatin with the self-motility of the male nuclei, but it is possible that it is a mere preliminary to fusion or to the subsequent division of the fusion-nucleus, for, as Fig. 4 shows, the chromatin of the female nucleus sometimes becomes thread-like immediately before fusion.

Our studies of these two species of *Lilium* have led us to the view, held by Nawaschin for the forms he has studied, that the male nuclei have the power of movement, and by their own activity make their way to the nuclei with which they fuse. The shape of the nuclei, understandable if the nuclei have to push or writhe their way through cytoplasm, would seem quite unsuitable to their carriage by strands of cytoplasm. We have further been able to make out that in many cases the polar male nucleus is distinctly more pointed at one end, and sometimes this difference between the ends is very marked (Figs. 2 *a*, 2 *b*, 2 *c*), though it has not been possible

<sup>1</sup> Nawaschin, S. : Näheres über die Bildung der Spermakerne bei *Lilium Martagon*. *Annales du Jard. Botan. de Buitenzorg*, 2<sup>e</sup> sér., Suppl. iii, 1910, 871-904.

<sup>2</sup> In this our observations do not agree with those of Nawaschin (1910, loc. cit.), who states that in *L. Martagon* the male nuclei do not pass into the resting state, but the chromatin retains the arrangement characteristic of the telophase of the last division. His observations appear, however, to be based on studies of the pollen-tube outside the embryo-sac.



to show that the pointed end moves first. Figs. 2 *a* and 2 *c* do certainly suggest very strongly a capacity for progression by creeping or some undulatory movement. Nawaschin has already pointed out the difficulty of accepting the view that two separate currents of cytoplasm take the nuclei as they lie close together and carry them in opposite directions. Some chemotactic relation between the approaching nuclei would seem to be a necessary assumption, for, as Nawaschin points out, it is only the male nuclei which are so carried—other granular bodies which accompany them into the embryo-sac remain behind. In *Fritillaria*, and perhaps in *Lilium* though we were unable to elucidate this point, the contents of the pollen-tube pass, not into the cytoplasm of the embryo-sac, but into a space between the cells of the egg-apparatus, above, and the cytoplasm of the polar nuclei, below.

It is to be noted that even at the earliest stage in which the male nuclei have been observed in the embryo-sac there is a distinct difference in their size (Fig. 5), the forward ones being narrower and smaller. As the nucleus in contact with the female cell is generally smaller than the one in contact with the polar nuclei it is probably the one which lies towards the apex of the pollen-tube which fertilizes the egg-cell (compare Figs. 1 and 5).

In the contents of the pollen-tube after their entry into the embryo-sac two very deeply staining bodies are to be seen (Figs. 5 and 6); these are of doubtful nature and correspond to the X-Körper of Nawaschin. Also in Fig. 1 there is a band-like structure which stains deeply with safranin and lies just below the female cell and almost in contact with the lower male nucleus. There are also three other fragments of a similar nature lying close by. Are these possibly the remains of an abortive blepharoplast or cilia-bearing band?

The material was fixed in Flemming's strong fluid, and as the sections were mostly thick for convenience of examination, they were stained deeply in safranin, washed out with alcohol, and then treated with Lichtgrün dissolved in clove oil. By this means a very transparent stain is obtained, enabling one to examine with ease sections so thick (20  $\mu$  or more) that they would be completely obscured by the use of gentian-violet.

---

## EXPLANATION OF PLATE XII.

Illustrating Professor Blackman's and Miss Welsford's paper on Fertilization in *Lilium*.

Fig. 1. Section of the ovule of *Lilium Martagon* at time of fertilization. The two male vermiform nuclei are well seen, also the egg and the synergid. A deeply staining band and other bodies are to be seen below the female nucleus.  $\times 680$ .

Fig. 2. *a* and *b*. *L. Martagon*; *c*, *L. auratum*. Male nuclei of various shapes in contact with polar nuclei. The contrast between the 'active' chromatin of the male nuclei and the 'passive' chromatin of the polar nuclei is very striking.  $\times 1,260$ .

Fig. 3. *L. Martagon*. Later stage of union of male and polar nuclei; the male nucleus has shortened and thickened and has lost its vermiform appearance.  $\times 1,260$ .

Fig. 4. *L. Martagon*. Male nucleus in contact with egg at a later stage than that shown in Fig. 1. The chromatin of the female nucleus now shows a spireme like that of the male.  $\times 1,720$ .

Fig. 5. *L. auratum*. Very early stage of entry of male nuclei into the embryo-sac. The main mass of the material round the nuclei apparently represents the contents of the pollen-tube which has only very recently destroyed the synergid. Even at this early stage there is a distinct difference in size between the two nuclei. The two deeply staining bodies represent the X-bodies of Nawaschin.  $\times 1,100$ .

Fig. 6. *L. auratum*. A slightly later stage than that of Fig. 5. It shows the remains of the contents of the pollen-tube, with the X-bodies, the two male nuclei, and the egg-cell with the nucleus of the undestroyed synergid above it.  $\times 1,100$ .

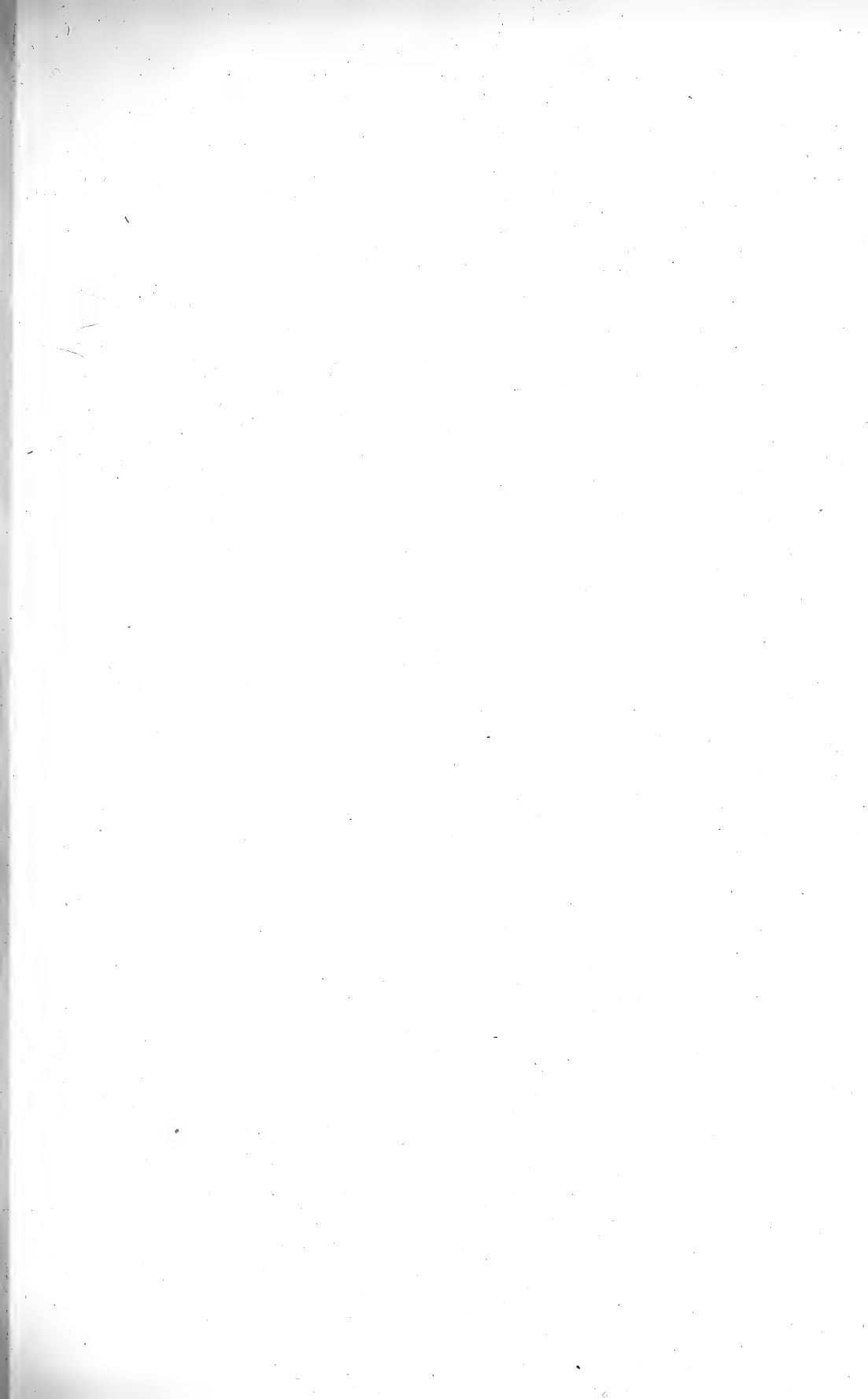



Blackman & Welsford del.

BLACKMAN AND WELSFORD—LILIUM.

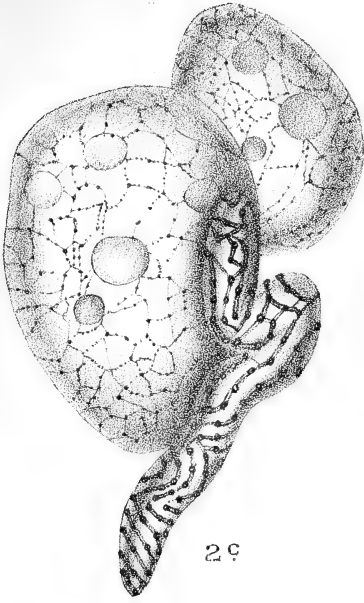

2c

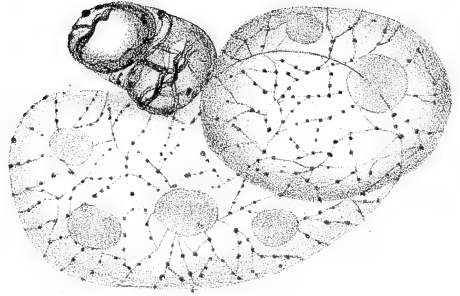

3.

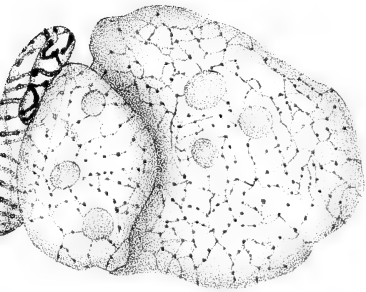

2b

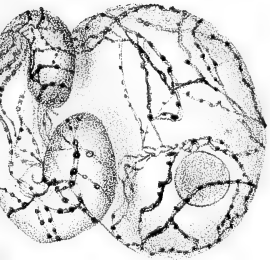

4.

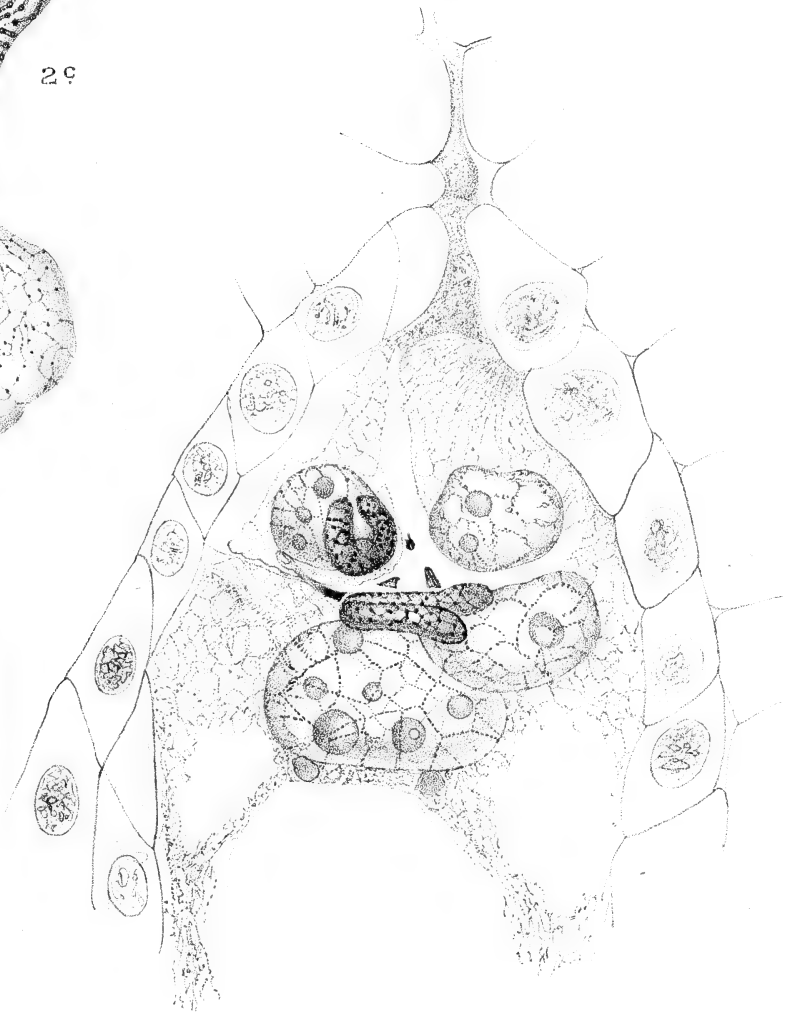

1.



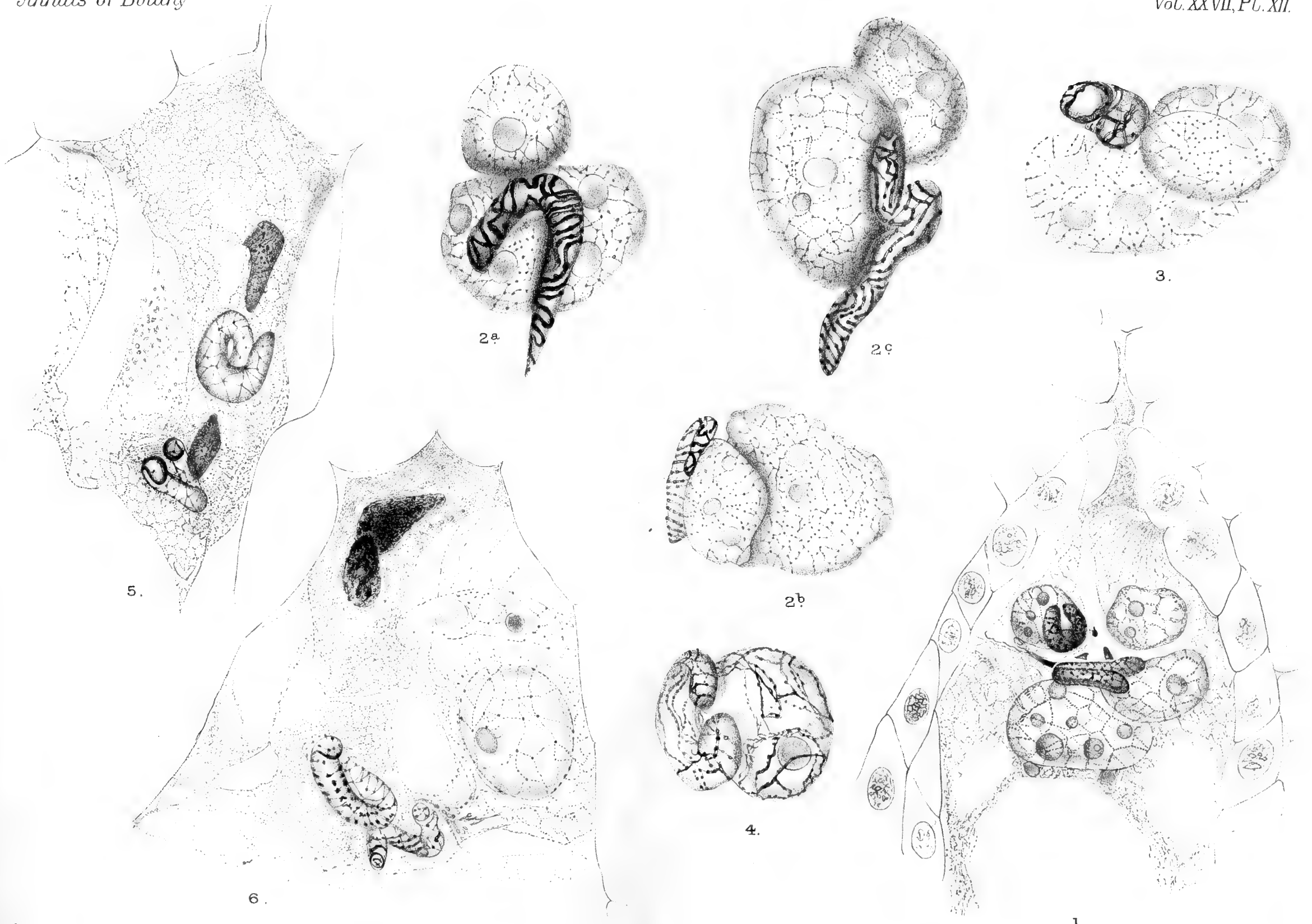

Blackman & Welsford del.

BLACKMAN AND WELSFORD—LILIUM.

Huth lith. et imp.





# On Abnormal Cell-fusion in the Archegonium; and on Spermatogenesis in *Polytrichum*.

BY

NORMAN WALKER,

*Assistant-Lecturer in Botany, University of Leeds.*

With Plates XIII and XIV.

IN the year 1908 J. and W. van Leeuwen-Reijnvaan (12) published an account of the sexual process and spermatogenesis in several species of *Polytrichum* in which the conclusions appeared so remarkable, that it was suggested by Professor V. H. Blackman that a re-investigation of this subject might give interesting results. Strasburger (16) also, in 1909, in commenting upon the statements of these observers, indicated that further work was necessary to set these questions beyond doubt.

J. and W. van Leeuwen-Reijnvaan state that the number of chromosomes present in the cells of the sporogonium is twelve, and in the sexual plant six. During the last division of the spermatogenic cells a reduction is said to take place in the number of chromosomes, and consequently each spermatid receives three, and this number will be carried by the spermatozoid. On the division of the egg mother-cell or central cell of the archegonium two cells of equal size are produced, the upper corresponding to a ventral canal cell, the lower to an egg-cell. During this division a reduction in the number of chromosomes is stated to take place, so that three is also the number received by each of these cells. While the neck of the archegonium is still closed the nuclei of the two cells are said to fuse, and the large cell resulting from this fusion is fertilized by two spermatozooids. In this way four sets of three chromosomes are brought together, and the sporophytic number is thus established.

The present investigation, which was commenced in 1909, was first directed towards the archegonium of *Polytrichum* and later to the last divisions in the antheridium. This led to further observations upon the division of the nucleus and upon spermatogenesis in *Polytrichum formosum*, Hedw., and an account of the results obtained, which differs in many respects from that of J. and W. van Leeuwen-Reijnvaan, forms the chief part of the

present paper. In a recent contribution upon spermatogenesis in the Bryophyta by Malcolm Wilson (22) an adequate historical outline of the subject was given, and this will not be repeated here. Reference to recent work will be made in the descriptive part of the paper.

#### METHODS.

The material was fixed in the field during June, when all stages in the development of the antheridia are present as well as both young and old archegonia. The air was removed from the tissues by means of an air-pump. Zenker's mixture, acetic alcohol, and various strengths of Flemming's solution were tried as fixing reagents, but the best results were obtained by the use of Flemming's strong solution diluted with an equal volume of water. The objects were dehydrated by the glycerine method and brought gradually into cedar oil, through several mixtures of this oil and absolute alcohol. The introduction to paraffin was also gradual by means of successive baths in mixtures of the cedar oil and wax. The material cleared in this way was found to be less brittle than when chloroform was used. The stay in paraffin was made as short as possible; five or six hours usually sufficed. Sections were made of  $3\mu$ – $6\mu$  in thickness. In staining, the best results were obtained by Heidenhain's iron-haematoxylin method preceded by a 12–24 hours' treatment with a solution of Bordeaux R. Flemming's triple stain (safranin, gentian violet, and orange G) gave useful results as a nuclear stain, but was found disappointing for the developing spermatozoids.

#### THE BEHAVIOUR OF THE EGG AND VENTRAL CANAL CELL.

To determine this, more than a hundred archegonial rosettes of *Polytrichum formosum* and *P. commune* were sectionized, and in no case was a fusion between these cells observed. On the other hand, many stages in the disorganization of the large ventral canal cell were seen, and the rounding off of the lower cell only, to form the ovum. *Ultimately the egg-cell is left in the lower region of the venter, and above it is sometimes seen the delicate transverse wall which originally separated the two cells.* It seems probable that the appearance of fusion of the egg-cell and ventral canal cell observed by J. and W. van Leeuwen-Reijnvaan is due to their method of fixation, which they describe in detail. Before passing the archegonial rosettes into the fixative, they removed the involucre leaves and examined the rosettes with a pocket lens to determine the presence of archegonia, which were recognized by their necks. Under this treatment the delicate archegonial necks probably contract through drying a little, and squeeze the neck canal cells into the venter, in which situation they are described and figured by these observers. When the rosettes are fixed without exposure of the archegonia the canal-cells do not descend into the venter, and the

ventral canal cell therefore is not driven towards the egg-cell, and no simulation of fusion occurs. *In several hundred archegonia fixed in this way, none showed the occurrence of the neck canal cells in the venter.* It seems scarcely open to doubt that the abnormal conditions referred to have induced the fusion appearances described by J. and W. van Leeuwen-Reijnvaan. It will be shown later that the reduction in the number of chromosomes at the last division of the spermatogenic cells does not occur in *Polytrichum formosum*, the species from which the above observers' figures were taken.

#### THE NUCLEUS IN THE SPERMATOGENIC CELLS.

In young antheridia, shortly after the differentiation of the spermatogenic from the wall cells, the former cells are larger than at any subsequent stage. The cytoplasm is finely granular and contains numerous vacuoles which vary in size in different cells (Pl. XIII, Figs. 1 and 3). Chloroplasts which seem to be in a state of disorganization also occur (Figs. 1 and 4); these persist for a few cell generations, but ultimately disappear, as they are not found in the cells at the time of the last division. In a single case the presence of well-developed chloroplasts was observed in the spermatogenic cells at the apex of an older antheridium, where the better illumination would favour their occurrence. It seems probable that they owe their origin to the persistence of plastids through the intervening cell generations. Deeply stained granules of various sizes are often found scattered through the cell, and each granule is usually surrounded by a clear space (Figs. 3 and 8). The disposition of these particles is sometimes such as to suggest centrosomes (Fig. 3), and J. and W. van Leeuwen-Reijnvaan have figured similar bodies in young antheridial cells of *Polytrichum formosum*, and have placed this interpretation upon them. These observers state that they were able to distinguish between centrosomes and the other particles occurring in the cytoplasm by the presence of a clear halo which characterized the centrosomes. The preparations upon which the present account is based fail to show any distinction of this kind, and a careful search through many young antheridia leads to the conclusion that centrosomes are not present in the young spermatogenic cells, although, as will be shown later, centrosome-like bodies are associated with the final division of the spermatogenic nuclei.

In the spermatogenic cells the nucleus is relatively large and centrally placed. Near the centre of each nucleus is a large, deeply stained body which sometimes has a diameter of about half that of the nucleus (Fig. 3) and is designated a nucleolus by most writers upon this subject. This body resembles the nucleolus in the root-apex of *Phaseolus*, as described by Wager (19), both in appearance and in some degree in its behaviour during the prophase of division. In sections stained by the triple stain the nucleolus is seen to consist of a central red body, probably corresponding to the

nucleolus in the higher plants, embedded in a violet staining substance, the chromatin. The peripheral region of the nucleus is occupied by an exceedingly delicate reticulum, and this is connected with the centrally placed nucleolus by fine threads. At the points of insertion of these threads the chromatin of the nucleolus is drawn out into minute prominences. Fig. 1 shows a surface view of the reticulum with droplets of chromatin at the intersections of the threads and the nucleolus lying beneath. In Fig. 2 are seen the radiating threads (the 'suspending threads' of Wager). J. and W. van Leeuwen-Reijnvaan in their account of the spermatogenic cells of *Polytrichum* do not describe the region of the nucleus between the nucleolus and the nuclear membrane, and in their figures leave it empty. Woodburn (23) describes a nucleus similar to that of *Polytrichum* in the young spermatogenic cells of *Porella* but makes no mention of suspending threads. In *Marchantia*, according to Woodburn (23), the nucleus in the resting condition 'shows an evident linin network containing relatively large lumps of chromatin in a clear nuclear sap without any nucleolus'. It seems probable that the single large nucleolus described in *Porella* by Woodburn, in *Pellia* and *Mnium* by Wilson, and in *Polytrichum*, simply represents a closer aggregation of the chromatin material than occurs in *Marchantia* according to Woodburn (23), and in *Fegatella* according to Bolleter (5), where several large lumps are found. In *Polytrichum*, as will be shown later, the nucleus shortly after division exhibits scattered lumps of chromatin, but this phase is soon passed over and the lumps collect to form a single central body.

Wilson's account of the nuclear reticulum in the archesporial (21) and spermatogenic cells (22) of *Mnium hornum* differs somewhat from the foregoing. He states that 'the nuclear network is fine and closely resembles the cytoplasm in structure, no chromatin being present in it during the resting condition'. Wilson's drawing of a spermatogenic cell (Fig. 1 in his paper) fails, however, to show the nuclear reticulum which he describes. This drawing agrees with certain appearances sometimes seen in the resting nuclei in young spermatogenic cells of *Polytrichum* (Fig. 3), where the ground substance of the nucleus presents a finely granular appearance, suggesting the possibility that the network has been masked by a fine granular substance, perhaps precipitated by the fixative. A more or less distinct reticulum, however, may generally be seen even in young cells of the antheridium, and is a constant feature of nuclei of the later cells and of the nuclei of the vegetative parts. Wilson further adds that a nucleus of this type (Fig. 1 in his paper and resembling Fig. 3 in the present account) can be considered characteristic of the Muscineae. With regard to its general structure the Bryophyte nucleus as described by Beer (3) in *Riccia*, by Van Hook (18) in *Marchantia*, by Woodburn (23) in *Porella*, and according to the present description in *Polytrichum*, does not appear to differ very greatly from that of the higher plants. Both in regard to the large size

and prominence of the nucleolus-like body and in the extreme fineness of the nuclear reticulum, and in *Polytrichum* the presence of 'suspending threads', a close agreement is found with the nucleus in the root-tip of *Phaseolus*.

#### THE FORMATION OF THE CHROMOSOMES.

On the approach of division the nucleolus loses its compact rounded appearance, and the threads connected with it become thicker and stain very deeply (Figs. 13 and 14). This appearance strongly suggests the direct transference of the chromatin of the nucleolus to the nuclear reticulum by way of the radiating threads. Finally the whole of the chromatin is passed to the reticulum, certain parts of which are consequently heavily loaded with this substance. Fig. 15 shows a surface view of the reticulum in this condition. Meanwhile the chromatin appears to have increased considerably in amount. In favourable cases, after the distribution of the chromatin to the reticulum, a feebly staining matrix is seen to remain in the centre of the nuclear cavity, and still connected with the peripheral network by radiating threads (Fig. 17). This remaining part of the nucleolus becomes lost to view when the spireme is established.

The gradual advance of the chromatin from the nucleolus, along the radiating fibres to certain threads of the peripheral network, differs sharply from the simultaneous appearance of this substance in all those parts of the thread system which form the chromosomes, as described by Martins Mano (13) in *Phaseolus* and *Solanum*. Some agreement is found, however, in *Polytrichum* with Wager's (19) account of the behaviour of the nucleolus in *Phaseolus* during the prophase, where this author saw appearances which led to the conclusion that a considerable amount of the substance of the nucleolus is transferred to the chromosomes. The remaining portion of the nucleolus in the same plant was observed to divide into two lumps which travel to the poles of the spindle and ultimately disappear. Martins Mano (13) states that these polar masses are expelled into the surrounding cytoplasm. In *Polytrichum* a definite extrusion of chromatin was seen to take place only during the last division of the spermatogenic cells and from the resultant spermatids. These extrusions will be dealt with later.

Certain peripheral threads are now seen to be considerably thickened; between these occur fine anastomosing connexions, and already an appearance of continuity in the stout thread system can be distinguished (Fig. 16). As this thread becomes transformed into a spireme, the connecting fibres break down, and the whole structure appears to contract towards the centre of the nuclear cavity (Figs. 4 and 5). Meanwhile the nuclear membrane has become very indistinct. A marked elongation of the nuclear region is observed at this stage, and the clear part external to the spireme is crossed

by delicate threads, which pass from the spireme to the cytoplasm. In some cases the spindle fibres are seen to be connected with elongate structures, probably the remains of the chloroplasts, which often partly invest the nucleus at this stage (Fig. 5). Later, when the spindle is clearly present, it is seen in most cases to possess blunt poles about which are often seen aggregations of irregular particles (Fig. 9).<sup>1</sup> In the last division, however, the spindle fibres converge upon a single centrosome-like particle. The segmentation of the spireme to form the chromosomes is rarely found in the preparations, but it was observed in the nucleus of an early spermatogenic cell from which the stain had been removed from all parts except the spireme (Fig. 6). This mode of treatment was generally followed, owing to the greater clearness which it imparts to the chromosomes. According to J. and W. van Leeuwen-Reijnvaan, the chromosomes in *Polytrichum* are derived by the breaking up of the nucleolus into fragments, each fragment becoming a chromosome.

The number of chromosomes is six, and they are approximately of the same size and of a broad V shape (Fig. 7). No indications were observed of the three pairs of chromosomes of different sizes, described by J. and W. van Leeuwen-Reijnvaan in this species of *Polytrichum*. The chromosomes become arranged upon the spindle and lie flat in the equatorial plane with their ends outwards. A careful search discovered one case only where indications of longitudinal fission of the chromosomes could be observed (Fig. 8). The appearance of some of the chromosomes in Fig. 9 suggests that the separation takes place first at one end. One of the inner pairs of daughter chromosomes seen in the above figure and also those in Fig. 18 seem to have separated first in the middle region. The sliding apart of the daughter chromosomes and their passage to the poles are probably rapidly effected, as these phases are of unusual occurrence in preparations showing very numerous nuclei in a state of division.

During the last division, while the daughter chromosomes are travelling to the poles, a relatively large deeply stained particle becomes detached from one or both of the chromosome groups; occasional dividing nuclei also occur which have reached the telophase without detaching these bodies. Fig. 19 shows this chromatin particle as it appears in a side view of the spindle, and Fig. 20 as seen in two polar views. As Fig. 19 indicates, this body appears to separate as a viscid drop of matter from a chromosome which lags a little behind the rest. J. and W. van Leeuwen-Reijnvaan

<sup>1</sup> Since writing the present account of the division of the nucleus in *Polytrichum*, a recent contribution upon this subject by C. E. Allen (1) has come into my hands. This observer deals in detail with the organization of the spindle, and describes certain polar plates and polar particles, named by him 'kinetosomes', upon which the spindle fibres are inserted. The observations made during the present investigation upon *Polytrichum formosum* lead to the conclusion that Allen's 'kinetosomes' are derived from the chloroplasts which are received by the early spermatogenic cells when these become differentiated from the wall-cells.

figured these extruded particles but misinterpreted them as centrosomes, which, after occupying the poles of the spindle, have come round to the inner side of each chromosome group, and ultimately pass in amongst them and become included within the daughter nuclei.

In view of J. and W. van Leeuwen-Reijnvaan's statement that a reduction in the number of chromosomes takes place during the last division in the antheridium of *Polytrichum formosum*, countings were made of the chromosomes in this species during the anaphase, and the full number, six, was repeatedly found to be present (Fig. 20).

#### THE RECONSTITUTION OF THE DAUGHTER NUCLEI.

During the telophase the chromosomes become united in such a manner as to constitute a figure resembling the spireme of the prophase (Fig. 22). Many nuclei exhibit an end-to-end union of the daughter chromosomes. Fig. 21 shows an example of this where five chromosomes have become united; while in the cell on the left in Fig. 20 is a sixth chromosome which shows indications of becoming laterally united with adjoining chromosomes. Connecting threads next appear between some of the chromosomes, probably as a result of contact at certain places, followed by a pulling apart and the drawing out of viscid threads, the whole presenting the appearance of a simple reticulum (Fig. 20, cell on the right). There is no definite approximation of the chromosomes such as that observed by Fraser and Snell (7) in *Vicia Faba*, nor could any alveolization of the chromosomes be made out at any stage in the division of the nucleus as described by Grégoire and Wygaerts (8) and others in various plants.

The establishment of the reticulum is accompanied by a change in the distribution of the chromatin, which is now seen to leave the network and collect into small drops of various sizes (Figs. 10 and 11). These deeply staining drops gradually run together and form the large rounded nucleolus. Sometimes a single chromatin droplet remains for a time distinct from the main mass (Fig. 12), but ultimately this is usually taken in, thus leaving the reticulum with very little chromatin distributed upon its threads. It is probable that the last outstanding particle of chromatin is identical with the body which J. and W. van Leeuwen-Reijnvaan state is cut off from the nucleolus and extruded from the nucleus to form, by division, the centrosomes.

#### THE OCCURRENCE OF CENTROSOMES.

During the early prophase of the last division of the spermatogenic cells, the centrosome-like bodies, stated by J. and W. van Leeuwen-Reijnvaan to be present at all divisions, are observed for the first time in the development of the antheridium. The determination of the last division gave considerable difficulty. Except in a few cases, this is not

diagonal as in *Marchantia* described by Ikeno (9), and *Fegatella* by Bolleter (5), consequently this easy method of distinguishing it is not available. At this time the cell-walls are thick and swollen, and stain somewhat deeply with orange G (Figs. 18–20). The contents appear more or less rounded, and the spermatogenic tissue no longer presents the well-known tessellated appearance which characterizes it in sections of younger antheridia. Countings were also made of the cells after this division, and these were found to approximate those of antheridia containing spermatids with developing spermatozooids. As a result of the final division, two spermatids are formed within each thick-walled chamber (Fig. 23).

The centrosome-like bodies, when first perceived, are situated upon opposite sides of the nucleus and appear as minute deeply stained particles of equal size, with a few delicate radiations extending from each (Figs. 13–15). According to Ikeno, these organs are present in the antheridium of *Marchantia polymorpha* during all the cell-divisions, and he therefore regards them as morphologically equivalent to centrosomes. During the following account this term will be used to designate these bodies. Their presence in the antheridium of *Polytrichum* at this stage is unmistakable, as they can be easily determined in all the cells. It was not found possible to discover their origin. No appearances were observed suggesting the extrusion of a parent particle from the nucleus. To determine this point, a differential stain is required to distinguish these structures, before they take up their position at the poles of the nucleus, from other deeply staining particles which are often observed both within the nucleus and in the cytoplasm.

When the spindle is formed, the centrosomes occupy its poles and are now much less conspicuous than during the prophase. After the completion of the division these bodies persist in the daughter-cells, one lying close to each nucleus (Fig. 23). As the time of the development of the spermatozoid approaches, the persistent centrosome increases in size (Fig. 27) and becomes highly refractive, appearing as a very conspicuous object in the spermatid. This refractive body, or blepharoplast as it may now be called, agrees with the 'stark lichtbrechender Plasmahöcker' of Strasburger (17).

In two antheridia belonging to the same rosette a nuclear division was observed, which, considering its rarity and the unusually large number of cells counted across the longitudinal section, was regarded as an extra division. In these cells the centrosome, which has already become refractive, has probably in some degree lost its normal function. This is also suggested by the fact that its division does not precede the onset of mitosis, but was found to take place in one case at the time of the formation of the chromosomes (Fig. 24); in another, not until after the formation of the spindle. In some dividing nuclei of these special antheridia the two resultant refractive bodies are seen to occupy the poles of the spindle (Fig. 25);



in others they lie away from the spindle in other parts of the cell (Fig. 26). It seems very improbable, for the reasons already stated, that this division is of normal occurrence. If such were the case, the centrosomes would then be regarded as making their first appearance at the time of the penultimate division; and between that and the final division become refractive and lose their centrosome function. Six is again the number of chromosomes which pass to each of the daughter nuclei during this division.

The presence of centrosomes during the last cell-division in the antheridium in *Polytrichum*, and their persistence as blepharoplasts, is of interest in regard to Wilson's statement (22) that in *Mnium hornum* and *Atrichum undulatum* centrosomes do not occur, and that the blepharoplast in each case is derived directly from the nucleolus of the spermatid. This body, which is passed out from the nucleus, Wilson believes to have been phylogenetically derived from a centrosome. Ikeno regards *Marchantia*, in which he states that centrosomes are present during all cell-divisions in the antheridium, as representing in this respect a relatively primitive condition, while in other Bryophytes they are being gradually eliminated and occur only in the later cell-divisions. Miyake (14), on the other hand, fails to find centrosomes during the early divisions of *Marchantia*, and believes that the bodies which are found at the poles of the spindle during the last division are blepharoplasts and are not related in any way to centrosomes. Escocoyez (6) in his researches on *Marchantia* and other Liverworts supports the views of Miyake. Woodburn, in a recent paper (23), states that he can find no evidence of the existence of centrosomes in the Liverworts which he investigated (*Porella*, *Asterella*, *Marchantia*, and *Fegatella*), or of the persistence of the body which occupies the poles of the spindle in the last division as an individual organ in the resulting sperm-cell. This observer believes that the blepharoplast originates through a condensation or aggregation of cytoplasmic material in the sperm-cell.

#### THE FORMATION OF THE SPERMATOZOID.

Fig. 27 shows a spermatid before the onset of the series of changes which transform it into a spermatozoid. This cell is at first somewhat polygonal, but as spermatozoid formation progresses it becomes more and more rounded. The relatively large nucleus is usually situated somewhat to one side of the cell, and the prominent blepharoplast is embedded in the cytoplasm towards the other side. At this stage the chromatin is held in rather large masses upon the reticulum, but most of this substance soon collects to form a central nucleolus-like body (Fig. 28). The greater portion of this deeply staining substance is next seen to be passed out into the surrounding cytoplasm (Figs. 29-31), where it collects, usually in the form of two drops, in the vicinity of the blepharoplast. This body may still be easily perceived, although it commonly becomes immersed in the

extruded chromatin and consequently does not appear in the three figures representing these changes. The nucleus now stains very feebly, and its limits are often very difficult to distinguish (Figs. 29–31). In an occasional spermatid the extruded substance is collected into one drop, and there can be little doubt that this single mass of chromatin, and consequently the two masses normally present, corresponds to the ‘chromatoiden Nebenkörper’ observed in *Marchantia* by Ikeno (9), the origin of which he was unable to determine. It agrees also with the ‘limosphere’ described by Wilson (22) in *Mnium hornum* and in *Atrichum undulatum*.

In *Mnium* Wilson states that the ‘limosphere’ originates through the coalescence of rod-like structures derived from the nucleolus, and in *Atrichum* it is derived directly from the nucleolus. This observer believes that J. and W. van Leeuwen-Reijnvaan misinterpreted these rod-like bodies as three chromosomes, and upon this founded their statement regarding reduction. As these rod-like structures do not occur in *Polytrichum*, it therefore follows that Wilson’s explanation regarding the observations of J. and W. van Leeuwen-Reijnvaan does not apply.

In those spermatids where the blepharoplast is embedded in the extruded chromatin, it soon becomes free and is next seen to lie at varying distances from this substance (Figs. 32 and 33). In Fig. 32 the blepharoplast is the larger particle underlying one end of the nucleus. Meanwhile, a prominent organ, which when mature takes the form of a curved band, has now commenced its development at the periphery of the spermatid. This structure is first organized in the vicinity of the rounded masses of extruded chromatin, which at this stage appear hollow, the substance in the interior of each mass staining very faintly. The resemblance between these deeply staining bodies and the single ‘limosphere’ described by Wilson is now apparent, while the difference in number may probably be accounted for by the much larger amount of chromatin which is passed out of the nucleus in *Polytrichum*. With regard to the function of these bodies, their intimate association with the band-like structure and the similarity in their capacity for stain suggest that they contribute some of their substance to its formation. At a later stage, when this band is completely formed, only one deeply stained vesicle remains (Figs. 34–6); the other probably owes its disappearance in some degree to the transference of its substance to the developing band. This interpretation of its disappearance is supported by the spermatid shown in Fig. 32, where that part of the band in close proximity to the diminishing vesicle is seen to develop first.

The spermatid, hitherto a compact protoplasmic body, now develops numerous large vacuoles and increases considerably in size. The nucleus stains more deeply and contains a central nucleolus-like structure (Fig. 34). At the same time the developing band has become extended towards, and finally reaches, the blepharoplast. This strongly arched band now connects

the blepharoplast with the remaining deeply staining vesicle, and in all cases the nucleus is enclosed within the arch (Figs. 34-6). Fig. 34 shows a side view, and Fig. 35 a dorsal view, of a spermatid at this stage. The term dorsal is used in Belajeff's (4) sense and refers to the side of the spermatid near which the nucleus lies.

The arched band of the *Polytrichum* spermatid is probably homologous with the 'cytoplasmatischer Fortsatz' described by Ikeno in *Marchantia* (9). In the latter plant this structure appears as a short arched band which connects the blepharoplast with the nucleus, and it is significant that, at the time of its formation, the 'chromatoide Nebenkörper', which has been situated in this region, disappears. It seems probable that the 'Nebenkörper' has been concerned in some way in the formation of the 'cytoplasmatischer Fortsatz'. There is, however, a marked difference between *Marchantia* and *Polytrichum* in the situation of the 'Nebenkörper'. In the Liverwort this body occurs between the blepharoplast and the nucleus, and the curved band, which is correspondingly short, is developed between the two in such a manner as to connect them. In *Polytrichum*, the 'Nebenkörper' is situated on the posterior side of the nucleus (Fig. 36), and the arched band is consequently much longer and extends from the 'Nebenkörper' to the blepharoplast in front, including the nucleus in its arch. In this respect *Fossombronia* agrees with *Marchantia*. In the former plant, Humphrey (11) uses the term 'middle piece' for the connecting band, or the 'cytoplasmatischer Fortsatz' of Ikeno.

The difficulty experienced in tracing the changes which take place in the spermatid in the Bryophyta is indicated by the various conflicting statements which have been made with regard to the 'Nebenkörper'. Woodburn (23) asserts that in *Marchantia* 'no body corresponding in size and appearance to the "Nebenkörper" of Ikeno was found'. Arens (2) similarly asserts that no body of this kind occurs in *Polytrichum juniperinum*; while J. and W. van Leeuwen-Reijnvaan state that a body corresponding to Ikeno's 'Nebenkörper' is present, but disappears before the spermatozoid is ripe. According to the present investigation, in *Polytrichum* the 'Nebenkörper' does not disappear, but persists in the ripe spermatozoid. Some explanation of these opposing statements is probably found in the difficulty encountered in staining the spermatids at the time when the most important changes are taking place.

The 'Nebenkörper' of Ikeno, which is conspicuous in the spermatids of *Marchantia*, *Pellia*, *Fegatella*, *Fossombronia*, *Atrichum*, *Mnium*, and *Polytrichum*, is probably functional in these plants and is concerned in the formation of the band-like body along which the nucleus extends itself. This conclusion is strongly suggested by the constant and definite connexion between these structures ('Nebenkörper' and arched band) in *Polytrichum* (Figs. 32-6).

The 'Nebenkern' of Yamanouchi (24) in *Nephrodium* and the nucleolus-like body described by Webber (20) in *Ginkgo* are possibly homologous with the 'Nebenkörper' (Ikeno) or 'limosphere' (Wilson), and in the higher plants may have lost its original function, as the former authors agree that it takes no part in the formation of the spermatozoid.

The final changes which take place within the spermatid of *Polytrichum* will now be described. When the arched band is fully developed, the nucleus undergoes a marked change in form. Fig. 36 shows an early phase of this change where the nucleus is drawn out into a pointed process which is directed backwards. This elongation continues and the nucleus becomes extended upon the arched band until its anterior rounded extremity reaches the blepharoplast (Figs. 37 and 38). This band-like organ, hitherto so prominent, now appears less marked (Figs. 37-9), especially that portion adjoining the thicker part of the nucleus (Fig. 38), and in some spermatids is seen to have completely disappeared from this region (Fig. 37). It seems probable that the substance of the curved band has been reabsorbed by the nucleus, which from this point onwards stains more and more deeply (Figs. 38 and 39). The process of elongation of the nucleus continues until it takes the form of a thick curved rod (Fig. 39).

In *Chara* a structure somewhat resembling the arched band of *Polytrichum* in form and in its relation to the nucleus is described by Mottier (15), and is regarded by him as a blepharoplast. This interpretation seems impossible in *Polytrichum*, where the band disappears before the cilia are developed. A superficial resemblance is also seen between the curved band of the *Polytrichum* spermatid and the coiled band formed by the elongation of the blepharoplast, described by Yamanouchi in *Nephrodium*.

The body of the developing spermatozoid continues to lengthen and its anterior end is carried into the region of the vesicle or persistent 'Nebenkörper' attached to the opposite extremity of the spermatozoid. The blepharoplast, which has now lost its refractive character, is thus obscured, and its further fate is difficult to follow. At a later stage, when many of the spermatozoids which now bear cilia appear less closely coiled, each is seen to terminate in front in a minute slightly elongate particle, probably the remains of the blepharoplast, behind which is a narrow feebly stained region (Fig. 40). Occasionally the cilia could be traced to this terminal particle, but very few spermatozoids in the sections displayed this region sufficiently clearly to make a determination of the exact place of insertion possible. The body of the spermatozoid is now extremely slender and stains uniformly throughout.

The spermatozoid has now completed its development and consists of a spirally coiled band derived from the nucleus, carrying a pair of cilia at its anterior extremity, and at the posterior end the remains of the deeply stained sphere or 'Nebenkörper' which was originally extruded from the nucleus.

THE ESCAPE OF THE RIPE SPERMATOZOIDS.

Free spermatozooids have been found unexpectedly difficult to obtain. In from seven to ten minutes after a drop of distilled water has been placed upon the open cup-like antheridial rosette, one or more rope-like masses are seen to arise from the bottom of the cup. These emerge from between the numerous imbricating involucreal leaves whose tips form the sides and floor of the cup. On transference of the drop of water to a slide by means of a pipette, the cylindrical masses break up into fragments of various sizes. Fig. 41 was drawn from a single small fragment. Each fragment consists of a mucilaginous matrix in which occur numerous spherical cavities. In each cavity is a spermatozoid in active movement. The mucilage is the result of the swelling of the outer layers of the thick walls of the spermatids, while the innermost region of the wall remains firm and tenacious and forms a delicate vesicle within which the spermatozoid is imprisoned. These vesicles are easily demonstrated by covering the drop with a cover-glass, when many of them are separated from the mucilage and are dispersed in the surrounding fluid. The spermatozoid is coiled within this bladder-like sac with its body pressed against the wall, and occupies about one and a half turns of a spiral. Fig. 41 shows a spermatozoid at this stage. The cilia whose rapid vibration renders them invisible are not shown in the drawing. Shortly after the escape of the mucilage from the antheridia, the spermatozooids, lying within their vesicles, commence a rapid movement, the narrow or ciliated end advancing foremost. When this movement is sufficiently rapid, the outward pressure exerted upon the wall of the vesicle would bring about its rupture and free the spermatozoid. This, however, does not seem to be a common occurrence. In experiments performed in the laboratory, only an occasional spermatozoid succeeds in liberating itself. Many antheridial cups were treated in the manner described without the escape of a single spermatozoid from its vesicle. Antheridial cups were filled with tap-water and with distilled water, treated in various ways, such as filtration through animal charcoal, thorough shaking with air and with oxygen, and the addition of cane sugar; but by none of these methods were the spermatozooids stimulated to make their escape. The best result was obtained by the use of rain-water collected in a vessel placed upon the roof of the University of Leeds during a Sunday morning after forty-eight hours of continuous rain. Under these conditions, the rain-water of Leeds would most nearly resemble that of the districts where *Polytrichum* flourishes and succeeds in forming sporogonia. The spermatozoid sketched (Fig. 42) resulted from this experiment. During several visits to Sedbergh in north-west Yorkshire made with the intention of determining the effect of local rain upon the escape of the spermatozooids, the weather unfortunately remained fine, and rain did not fall during any of

the visits. Through the kindness and hospitality of Mr. Wager, experiments were performed upon *Polytrichum commune* at Hawkswick, near Grassington, during the rainy Whitsuntide of 1912. The withdrawal and microscopic examination of the rain-water which had fallen upon ten antheridial rosettes resulted in the discovery of one free spermatozoid. It is probable, however, that the ripe spermatozoids of these rosettes had already been nearly exhausted during the preceding wet weather, as the extruded mucilage with imprisoned spermatozoids was not so abundant as when obtained in the laboratory from material kept for a few days under a bell-jar. Observations will be made when opportunity offers, to determine the effect of the local rain-water upon rosettes after fair weather, when many of the antheridia will be ready to discharge. Under favourable conditions an enormous number of spermatozoids is extruded from the antheridia of each rosette and a great wastage must result through the difficulty of their escape from the vesicles. It is possible that only the most vigorous specimens are thus selected for the operation of fertilization.

The body of the escaped spermatozoid occupies somewhat less than a complete turn of a spiral and moves sluggishly corkscrew-wise through the water, ciliated end foremost. The vesicle of substance attached to the tail of the spermatozoid seems to effect a drag upon its movement and may afford nourishment during the long journey of the spermatozoid to an archegonial plant. The greater part of the distance is probably covered by means of the splashing of the rain, which would transfer spermatozoid-containing water from the very numerous antheridial rosettes to the drops of water which lodge upon the summits of the adjoining archegonial plants.

I desire to thank Professor V. H. Blackman for many kindnesses and for his helpful advice given during the course of the investigation. My obligations are also due to Mr. G. H. Elam of Sedbergh, for his assistance in connexion with the collection of material.

#### SUMMARY.

1. In *Polytrichum formosum* no fusion was observed to take place between the egg-cell and the large ventral canal cell. The fusion appearances described by J. and W. van Leeuwen-Reijnvaan are probably due to their special method of preparation of the material before fixation.

2. In the spermatogenic cells the nucleus contains a large nucleolus-like body in which almost the whole of the chromatin is stored. This is connected with a peripheral reticulum by delicate radiating threads.

3. During the prophase of division the chromatin is passed along the radiating threads to certain threads of the reticulum, which consequently thicken, and from these the spireme is organized.

4. The number of chromosomes is six, and there is no reduction of their number during the last division of the spermatogenic cells.

5. During the reconstitution of the daughter nuclei the chromosomes show an end-to-end union, and by the development of anastomosing threads a simple reticulum is formed. The chromatin gradually leaves this reticulum and collects to form the central nucleolus-like mass.

6. During the anaphase of the last division of the spermatogenic cells a relatively large particle of chromatin is generally detached from each of the daughter chromosome groups, and is passed out into the cytoplasm.

7. Centrosome-like bodies occupy the poles of the spindle during the last division, but are not present during the earlier divisions.

8. The centrosome-like particle persists in the spermatid and becomes the blepharoplast.

9. An extra division was observed in two antheridia, and this is preceded by the division of the blepharoplast. The daughter particles did not in all cases occupy the poles of the spindle during this division.

10. The young spermatid contains, in addition to the nucleus, a conspicuous blepharoplast. The greater part of the chromatin is now passed from the nucleus into the cytoplasm and collects in the form of two spherical masses, which correspond to the single 'Nebenkörper' of Ikeno.

11. An arched band-like organ is next developed, probably at the expense of the extruded chromatin bodies, one of which is consumed in the process. This band passes round the periphery of the spermatid and joins the blepharoplast, thus connecting this body with the remaining mass of extruded chromatin. The nucleus is enclosed within the arch.

12. The nucleus of the spermatid becomes drawn out along the arched band and the greater part of the latter is reabsorbed by the nucleus.

13. The nucleus undergoes further elongation to form the body of the spermatozoid, which ultimately occupies about one and a half turns of a spiral. At the anterior extremity occurs a minute particle which is probably the remains of the blepharoplast, and in the region of this particle the two long cilia are inserted. At the posterior extremity of the spermatozoid is a conspicuous vesicle which consists mainly of the remaining spherical mass of extruded chromatin.

14. In the presence of water, the ripe antheridium extrudes a mucilaginous mass, in which the spermatozoids are imprisoned. Each spermatozoid rapidly revolves within a spherical vesicle, possessing a somewhat tenacious wall, and in laboratory experiments the spermatozoids rarely succeeded in making their escape from their vesicles.

## REFERENCES.

1. ALLEN, C. E. : Cell Structure, Growth, and Division in the Antheridia of *Polytrichum juniperinum*, Willd. Archiv f. Zellforsch., Bd. viii, 1912, p. 121.
2. ARENS, P. : Zur Spermatogenese der Laubmoose. Ref., Bot. Centralbl., Bd. cvii, 1908, p. 611.
3. BEER, R. : On the Development of the Spores of *Riccia glauca*. Ann. of Bot., xx, 1906, p. 275.
4. BELAJEFF, W. : Ueber Bau und Entwicklung der Spermatozoiden der Pflanzen. Flora, Bd. lxxix, 1894, p. 1.
5. BOLLETER, E. : *Fegatella conica*, (L.) Corda. Eine morphologisch-physiologische Monographie. Beih. z. Bot. Centralbl., Bd. xvii, 1905, p. 348.
6. ESCOYEZ, E. : Eléphantoplaste et centrosome dans le *Marchantia polymorpha*. La Cellule, t. xxiv, fasc. 2, p. 247. Ref., Bot. Centralbl., Bd. cv, 1907, p. 594.
7. FRASER, H. C. I., and SNELL, J. : The Vegetative Divisions in *Vicia Faba*. Ann. of Bot., vol. xxv, 1911, p. 845.
8. GRÉGOIRE, V., and WYGAERTS, A. : La reconstruction du noyau et la formation des chromosomes dans les cinèses somatiques. La Cellule, t. xxi, fasc. 1, 1903, p. 7.
9. IKENO, S. : Die Spermatogenese von *Marchantia polymorpha*. Beih. z. Bot. Centralbl., xv, 1903, p. 65.
10. ——— : Are the Centrosomes in the Antheridial Cells of *Marchantia polymorpha* imaginary? Bot. Mag., Tokyo, vol. xix, 1905, p. 111. Ref., Bot. Centralbl., Bd. ci, 1906, p. 194.
11. HUMPHREY, E. B. : The Development of *Fossombronina longiseta*, Aust. Ann. of Bot., vol. xx, 1906, p. 83.
12. LEEUWEN-REIJNVAAN, J. and W. VAN : Ueber eine zweifache Reduktion bei der Bildung der Geschlechtszellen und darauf folgende Befruchtung mittels zwei Spermatozoiden und über die Individualität der Chromosomen bei einigen *Polytrichum*-Arten. Recueil des trav. bot. néerl., t. iv, 1908, p. 177.
13. MARTINS MANO, T. : Nucléole et chromosomes dans le méristème radicaire de *Solanum tuberosum* et *Phaseolus vulgaris*. La Cellule, t. xxii, fasc. 1, 1904, p. 57.
14. MIYAKE, K. : On the Centrosome of the Hepaticae. Bot. Mag., Tokyo, vol. xix, 1905, p. 98. Ref., Bot. Centralbl., Bd. ci, 1906, p. 194.
15. MOTTIER, D. M. : Development of the Spermatozoid in *Chara*. Ann. of Bot., vol. xviii, 1904, p. 245.
16. STRASBURGER, E. : Zeitpunkt der Bestimmung des Geschlechts, Apogamie, Parthenogenesis und Reduktionsteilung. Jena, 1909.
17. ——— : Schwärmosporen, Gameten, pflanzliche Spermatozoiden und das Wesen der Befruchtung. Jena, 1892.
18. VAN HOOK, J. M. : Notes on the Cell and Nucleus in Liverworts. Bot. Gaz., vol. xxx, 1900, p. 394.
19. WAGER, H. : The Nucleus and Nuclear Division in the Root-apex of *Phaseolus*. Ann. of Bot., vol. xviii, 1904, p. 29.
20. WEBBER, H. J. : Notes on the Fecundation of *Zamia* and the Pollen-tube Apparatus of *Ginkgo*. Bot. Gaz., vol. xxiv, 1897, p. 225.
21. WILSON, M. : Spore Formation and Nuclear Division in *Mnium hornum*. Ann. of Bot., vol. xxiii, 1909, p. 147.
22. ——— : Spermatogenesis in the Bryophyta. Ann. of Bot., vol. xxv, 1911, p. 415.
23. WOODBURN, W. L. : Spermatogenesis in certain Hepaticae. Ann. of Bot., vol. xxv, 1911, p. 299.
24. YAMANOCHI, S. : Spermatogenesis, Oogenesis, and Fertilization in *Nephrodium*. Bot. Gaz., vol. xlv, 1908, p. 289.



EXPLANATION OF FIGURES IN PLATES XIII AND XIV.

Illustrating Mr. Walker's paper on *Polytrichum*.

The figures were drawn with the help of a camera lucida under a Leitz  $\frac{1}{2}$  a objective, N. A. 1.32 with Zeiss comp. oc. 12,  $\times$  3,000, except Fig. 40, which was drawn under a Zeiss apo. 2 mm. N. A. 1.40,  $\times$  2,500.

Figs. 1-12 were drawn from spermatogenic cells of antheridia in various stages of development, anterior to the last division. Figs. 13-23 refer to the last division. Figs. 24-6 show the extra division; Figs. 27-42 the development of the spermatozoid. All refer to *Polytrichum formosum*, Hedw.

PLATE XIII.

- Fig. 1. Cell from a very young antheridium, showing nucleus and remains of chloroplasts.
- Fig. 2. Nucleus; central nucleolus, radiating threads and peripheral reticulum.
- Fig. 3. Cell containing nucleus with large nucleolus and obscured reticulum.
- Fig. 4. Cell with nucleus in the spireme stage.
- Fig. 5. Cell with nucleus in the spireme stage; early spindle fibres.
- Fig. 6. Segmentation of spireme.
- Fig. 7. Polar view of dividing nucleus, showing six chromosomes.
- Fig. 8. Metaphase in side view.
- Fig. 9. Early anaphase in side view.
- Figs. 10 and 11. Telophases; chromatin leaving reticulum.
- Fig. 12. Daughter nucleus with outstanding particle of chromatin.
- Fig. 13. Early prophase of last division of spermatogenic nucleus; centrosomes; chromatin leaving nucleolus.
- Figs. 14 and 15. Early prophases; distribution of chromatin to peripheral reticulum.
- Fig. 16. Early spireme; anastomosing threads still present.
- Fig. 17. Nucleus with nucleolus after distribution of the chromatin to the reticulum.
- Fig. 18. Anaphase of last division; centrosomes at poles of spindle.
- Fig. 19. Telophase of last division; side view of spindle, showing detachment of chromatin particle from one of the chromosome groups.
- Fig. 20. Polar view of nuclei in telophase; detached particles lying in the cytoplasm; end-to-end union of chromosomes, and development of anastomosing threads.
- Fig. 21. Daughter chromosomes in telophase of last division, showing end-to-end union of five chromosomes.
- Fig. 22. Telophase; side view of spindle; union of chromosomes to form a simple spireme-like structure; detached chromatin particles.
- Fig. 23. Two cells after last division, lying in a common chamber with mucilaginous walls; persistent centrosomes.
- Fig. 24. Prophase of abnormal extra division; blepharoplast dividing.
- Fig. 25. Metaphase of same, showing blepharoplasts at poles of spindle.
- Fig. 26. Metaphase of same division, showing one of the blepharoplasts lying away from the spindle pole.
- Fig. 27. Early spermatid with blepharoplast.
- Fig. 28. Later spermatid with chromatin aggregated towards the centre of the nucleus.
- Fig. 29. Spermatid showing extrusion of chromatin from the nucleus.

PLATE XIV.

- Fig. 30. Spermatid showing later stage of extrusion of chromatin.
- Fig. 31. Extruded chromatin in two spherical masses lying in the cytoplasm.
- Figs. 32-4. Stages in the development of the arched band.

Fig. 35. Dorsal view of spermatid; arched band passing from the chromatin vesicle to the blepharoplast, and enclosing the nucleus.

Figs. 36-9. Stages in the elongation of the nucleus along the arched band, with the absorption of the latter body by the nucleus.

Fig. 40. Spermatozoid, drawn from a stained section of a ripe antheridium; blepharoplast with cilia at the fore end, and chromatin vesicle at the hinder end.

Fig. 41. Fragment of the mucilage extruded from an antheridium, showing the spherical vesicles and a spermatozoid drawn in one only.

Fig. 42. Mature spermatozoid; drawn from a living example.



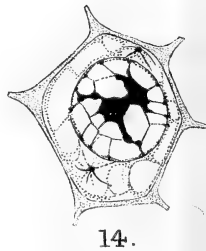
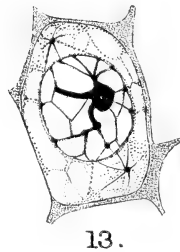
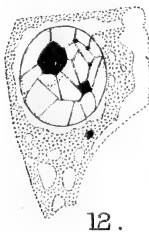
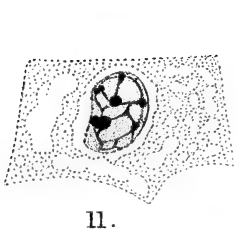
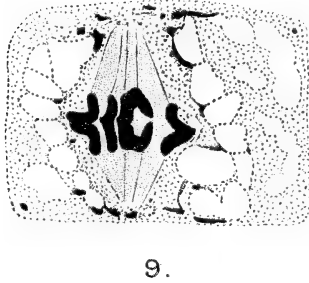
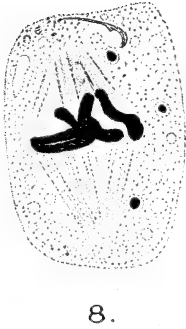
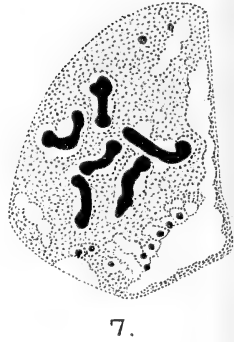
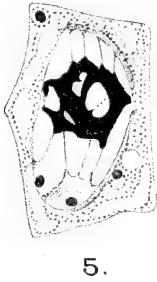
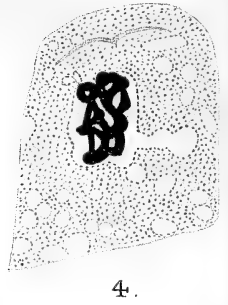
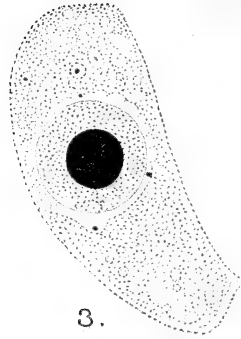
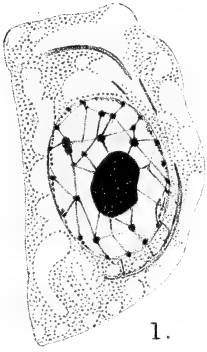

N.W.del.

WALKER. — POLYTRICHUM.

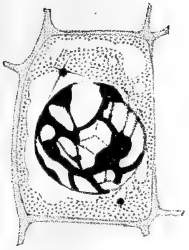

15.



16.



17.

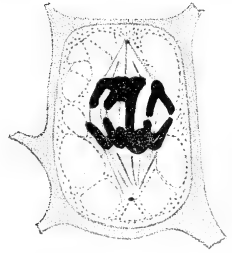

18.

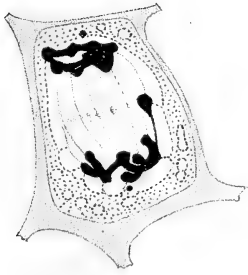

19.

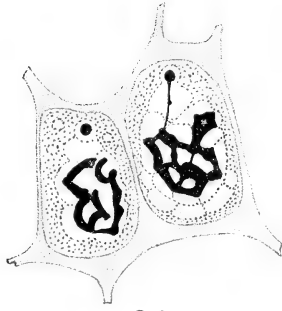

20.



21.



22.

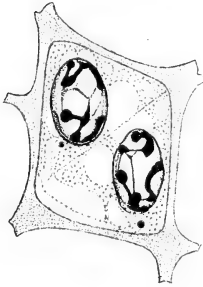

23.

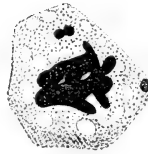

24.



25.



26.



27.

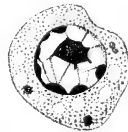

28.



29.





30.



31.

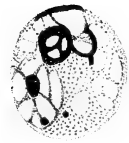

32.



33.



34.

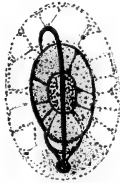

35.

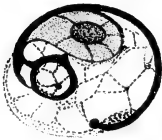

36.



37.

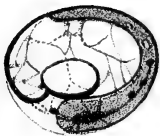

38.



39.



40.

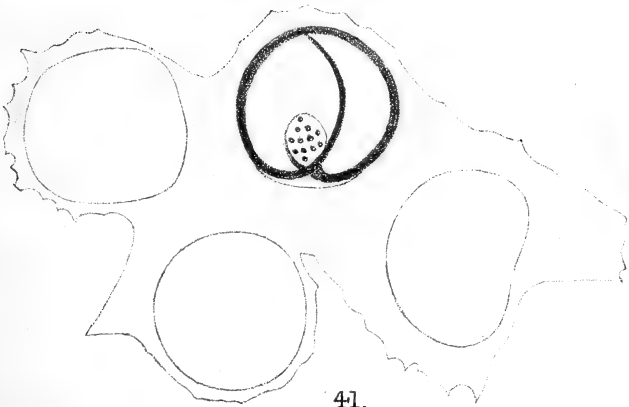

41.



42.

N.W. del.

Huth, lith. et imp.





# Some Features of the Anatomy of the Vitaceae.<sup>1</sup>

BY

JUNE ADKINSON, A.M.

*Radcliffe College.*

With Plate XV.

THE wood structure of *Vitis*, distinguished by large vessels, broad rays, and septate tracheides, has been cited, together with that of *Aristolochia* and *Clematis*, in support of the theory that the woody cylinder of plants is derived by the coalescence of a ring of originally separate fibro-vascular bundles. The broad rays were called the 'primary' rays because they were supposed to be formed from fundamental tissue between the primary bundles. Later other rays, frequently linear, appeared in the segments of the wood, while at the same time the fascicular cambium extended across the broad rays and began to lay down secondary tissues between the primary bundles. In this manner secondary growth of the stem proceeded. According to this view, the herbaceous stem, characteristic of primitive plants, has given rise to the woody cylinder increasing by secondary growth in perennial forms. If this be the true order of development, *Vitis* is intermediate in structure between the herb and the tree.

By evidence gathered in recent investigation, this hypothesis of the origin of the woody cylinder and of the herbaceous stem has been replaced by another which seems more accurately to explain the facts. In both Lycopsida and Pteropsida, in both vascular cryptogams and seed plants, the herbaceous type of stem has proved itself to be more persistent and better adapted to modern conditions of climate.<sup>2</sup> By the work of Bailey<sup>3</sup> and Eames,<sup>4</sup> on both anatomical and palaeontological evidence, the broad ray of *Quercus* is known to have developed by aggregation and final compound-

<sup>1</sup> Contributions from the Phanerogamic Laboratories of Harvard University, No. 54.

<sup>2</sup> Eames, A. J.: On the Origin of the Herbaceous Type in the Angiospermae. *Annals of Botany*, vol. xxv, No. xcvi, p. 215.

<sup>3</sup> Bailey, I. W.: Reversionary Characters of Traumatic Oak Woods. *Botanical Gazette*, 1, pp. 374-80, No. 5.

<sup>4</sup> Eames, A. J.: On the Origin of the Broad Ray in *Quercus*. *Botanical Gazette*, xlix, No. 3.

ing of enlarged rays originally connected with the leaf-trace. Hence, for *Quercus* at least, broad rays are secondary and uniseriate rays are primitive. Finally, Eames has explained the development of the herbaceous stem in the Dicotyledons by the localization of protoxylem and ray parenchyma with the reduction of lignified tissue and the more or less complete disappearance of the interfascicular cambium. Within the bundles, the uniseriate ray either disappears completely or is changed into a radial sheet of wood parenchyma, still appearing like a ray in cross-section, but elongate in the direction of the vertical axis of the stem.

In view of this latter explanation of the origin of the herbaceous stem, the wood structure of *Vitis* and other Vitaceae was re-examined for evidence upon the primitive condition, the mode of development, and the relation of the vine habit to the herbaceous type of Dicotyledon.

As described in detail by Strasburger,<sup>1</sup> the wood of *Vitis Labrusca*, L., consists of wood fibres, septate fibres, tracheides, vessels, and wood parenchyma cells. The wood parenchyma is distributed mainly about the vessels adjacent to the radial rows of tracheal elements, and beside the rays. It is sometimes scattered in radial rows through the wood.

Of chief interest in this study are the multiseriate rays, the so-called 'primary rays' of older text-books, which extend as plates of parenchyma seven to ten cells wide, continuously for a long distance vertically through the stem, although they are interrupted at intervals by the crossing over of tracheides, and less frequently of vessels. The ray cells elongate radially, are rectangular in cross and radial section, and in tangential section five or six angled. The peripheral cells along the sides vary in shape according to their location, and often are elongate in the vertical direction. Thus a sharp distinction between the ray cells and adjacent wood parenchyma cannot always be established. The rays extend from pith to cortex. Between the primary wood bundles, the ray cells are continuous with the round, narrow-lumened, thick-walled, vertically elongate, amyloiferous cells which form a sheath between the protoxylem and the broad, thin-walled cells of the pith. By gradual transition these elongate cells give place to the rectangular ray cells which become more and more elongate radially. The rays grow wider towards the cortex by the addition of adjacent fibres which gradually in the same row assume the characteristics of typical ray cells.

These multiseriate rays occur in the stem of the eleven species of *Vitis* examined. Specific differences exist in the width of the ray, the frequency of the tracheid bridges, and the number of fibres transformed into ray cells. The question now arises as to the origin of the multiseriate ray. Is it a primitive condition in *Vitis*, or has it developed secondarily, as in *Quercus*?

<sup>1</sup> Strasburger, E.: Histologische Beiträge, III. Ueber den Bau und die Verrichtungen der Leitungsbahnen in den Pflanzen, Jena, 1891, p. 239.

The division of the Vitaceae into two sub-families, the Vitoideae and the Leeoideae, according to Engler and Prantl, is justified on anatomical as well as systematic grounds. *Leea* differs from the other members of the family, nearly all of which are vines climbing by tendrils, in the woody stem and the shrub or tree-like habit. In the wood of *Leea* (of which a transverse section is shown in Pl. XV, Fig. 1), numerous broad rays separate narrow fibro-vascular bundles. The vessels are smaller relatively than in *V. Labrusca*, L., and are intercalated in the radial rows of woody elements. The parenchyma is vasicentric. Dividing the bundles are conspicuous linear rays (shown in detail in Fig. 2), the cells of which are smaller and less regularly rectangular than the multiseriate ray cells. Inasmuch as they are radially elongate and continue through the annual ring, they form a true uniseriate ray.

The uniseriate ray does not normally occur in the adult stem of the species of *Vitis* examined, except in *Vitis californica*, Benth. (the wood of which is shown in cross-section in Fig. 3). The vessels have reached an enormous development, often occupying nearly the entire width of the fibro-vascular bundle; the spring wood consists almost entirely of vessels, with a marked segregation of the woody elements at the end of the annual ring, and the large rays, ten cells wide, are sinuous from compression by the large vessels. Most plainly to be seen in the autumn wood (Fig. 4) are uniseriate rays which continue from ring to ring, bending about the huge vessels of the spring wood, sometimes compressed by vessels on both sides, as in the centre of Fig. 4. As in *Leea*, the cells of the uniseriate rays are small and rounded, but radially elongate. In tangential section the xylem bridges through the multiseriate rays appear sometimes two or three tracheides high. By the more frequent occurrence of these xylem bridges, the rays become elongate-fusiform, a condition somewhat like the marked compound fusiform rays of *Quercus*. In all respects, the wood structure of *V. californica*, Benth., corresponds to the conditions found in *Leea*, except for the large vessels and broader rays, which are special adaptations to the climbing habit.

The mature wood of *V. californica*, Benth. differs from *V. Labrusca*, L. and ten other species examined, in the presence of two sorts of rays, a condition strikingly similar to the ray structure of *Quercus*. The presence of the linear rays may be interpreted as the persistence of a primitive character which has disappeared in the other species, or as the result of reversion and reduction from a primitively multiseriate ray. The application of Haeckel's Law of Recapitulation to the study of plant seedlings is found to explain accurately many difficult problems of anatomy. An examination of the seedling of *Vitis* indicates the primitive structure of the wood. Seedlings of *V. Labrusca*, L., and *V. cordifolia*, Michx. (Fig. 5), exhibit in stem and root

<sup>1</sup> Holden, R.: Reduction and Reversion in the North American Salicales: Annals of Botany, vol. xxvi, No. ci, p. 170.

a ring of bundles separated by multiseriate rays and without intrafascicular linear rays. But below the node where the leaf-traces begin to pass out at five regions conspicuous for reduction in number and size of vessels (a cross-section of the seedling of *V. cordifolia*, Michx., is shown in Fig. 5), a departure from the adult condition is found. Within the leaf-trace segment (Fig. 7) only linear rays occur. The leaf-trace, with the reproductive axis and the root, is known to be one of the most conservative regions of the plant, where primitive structures persist long after they have disappeared in both stem and root. The fibro-vascular bundles of the petiole of *V. Labrusca*, L., cut a short distance from the branch where it is most woody, showed no vestige of uniseriate rays. The presence of the linear rays in the leaf-trace of the seedling in *Vitis* species, where all trace of them has vanished in the adult, indicates that linear rays are a primitive feature of the Vitaceae.

This interpretation of the facts is made stronger by the occurrence, even in the adult stem, of vestiges of linear rays. In *V. Coignitia*, Pulliat, only multiseriate rays are present in the mature wood (illustrated in Fig. 8), but in the leaf-trace segments of the first year's growth (shown in detail in Fig. 9) the primitive linear rays persist. The primitive rays appear also in the leaf-trace of *V. Doaniana*, Munson (Fig. 10), the bundles of which show more abundant wood parenchyma than does *V. Labrusca*, L.; the leaf-trace segment of the first annual ring exhibits radial rows of parenchyma which appear in cross-section like linear rays. Such rows of parenchyma are to be interpreted as a transformation of ray parenchyma. In *V. arizonica* and *V. cinerea*, Noronha, the multiseriate rays within the departing leaf-trace are formed by the union of very short linear rays. In *V. cinerea*, Noronha, moreover, tannin-filled cells in the xylem of the central cylinder indicate the persistence of wood parenchyma as scattered cells. In the leaf-trace, these tannin-filled cells, arranged in uniseriate radial rows, are a last vestige of linear rays which penetrate the wood and are present in the multiseriate compound ray. In the tendril of *V. Labrusca*, L., linear rays are found in the trace of the tiny bract which subtends the longer branch of the tendril. In these forms where vestiges of linear rays still persist, there can be no doubt that primitively the structure of the wood resembled *V. californica* in the presence normally of linear rays within the fibro-vascular bundles of the central cylinder.

This conclusion is confirmed by evidence from the condition found in wounded wood of *V. Labrusca*, L. One general principle of morphology is that primitive structures which have disappeared in the normal wood are apt to reappear after a wound. The more severe the wound, the more complete is the reversion to primitive conditions. Through the wounded wood of *V. Labrusca*, L., the multiseriate rays were found to persist unchanged except by the strong development of tannin. But at a little distance from the injury, linear rays make their appearance between the multiseriate rays,

extend for some distance as linear rays, and finally become bi- or tri-seriate.

From the persistence of linear rays in the seedling and the leaf-trace, and the reversion to the uniseriate condition after wounds, *V. Labrusca*, L. and the other species studied may be considered as forms which have lost the linear rays by a process of reduction of ray tissue within the so-called bundle. If this be the correct interpretation of the presence of the linear ray, *V. californica*, Benth., retains the earlier condition and is the most primitive member of the genus.

In a less thorough examination of two other genera of the Vitoideae some interesting conditions were found. The wood of *Ampelopsis Veitchii*, Hort. (shown in transverse section in Fig. 11), resembles closely the structure of *Vitis* in the large vessels, the broad rays, and the absence of linear rays. The wood is reduced to a few scattered libriform fibres, and to segments terminating the annual rings. In this species, as in *V. cordifolia*, Michx., the leaf-trace segment reveals the primitive condition by the persistence of linear rays (Fig. 12). The genus *Cissus* is indigenous in tropical forests, and, according to Schenck,<sup>1</sup> differs from the other Vitaceae in the extreme reduction of the lignified tissues of the stem. Peculiar forms are described in which the stem is transformed by the excessive development of parenchyma and ray tissues into soft, stout 'water reservoirs'. In *Cissus nummifolia*, the most woody of the species examined, the rays are only four or five cells broad, the wood is segregated as in *Ampelopsis*, and the vessels are large. In the leaf-trace segment of this species, vestiges of linear rays were found in the first annual ring. But in *Cissus cordata*, Roxb., and *Cissus discolor*, Blume, the reduction had progressed further. In the latter, the rays are wider than the bundles, which are reduced to a single row of large vessels surrounded by libriform fibres. Some of the fibres, particularly near the pith, are transformed into parenchyma. Here no trace of the linear rays was found. The stem might almost be taken for a woody herb.

From the study of these four genera, it seems probable that the ancestors of the Vitaceae were originally woody perennials without the climbing habit. The xylem cylinder of the stem was interrupted by both multiseriate and linear rays. For a time the two types of ray existed side by side, the broad ray serving for storage in connexion with the leaf-trace. The uniseriate rays lay within the bundles of the wood. In this condition, *Leea* still remains a tropical shrub, and is on anatomical grounds the most primitive genus in the Vitaceae.

From forms like *Leea* the other genera are probably derived. With the taking on of the twining habit came a need for mechanical strength combined with flexibility. The formation of parenchyma by the fibre ele-

<sup>1</sup> Schenck, Heinrich: Beiträge zur Biologie und Anatomie der Lianen, Jena, 1892-3, Part II, p. 137.

ments of the xylem is the means by which the herbaceous stem has developed as a result of the influence of the leaf-trace. In *Vitis* the development of broad rays has progressed synchronously with the reduction of radial parenchyma tissue within the bundle. So the intrafascicular rays of all the *Vitis* species investigated, with the exception of *V. californica*, Benth., have been transformed into radial wood parenchyma, or they have entirely disappeared except as vestiges in the leaf-trace segment of the first annual ring and particularly in that of the seedling. *V. californica*, Benth., is therefore the most primitive American species of *Vitis* examined, and those species which retain vestiges of the primitive rays in the adult or the seedling are more conservative of ancestral characters than those forms in which all trace of the rays has been lost.

The tendency of the bundle to a reduction of lignified tissue is shown in the increase of the broad rays at the expense of the wood fibres, and in the abundance of septate tracheides which are a stage in the transformation of xylem tissue into parenchyma. With the reduction of lignified tissue advances the elimination of radial parenchyma within the xylem. By this process the condition of *Ampelopsis* and *Cissus* is achieved. The development of the vine habit in the Vitaceae is an approach to the herbaceous type of stem. Like the herbaceous habit, it is brought about by localization of ray parenchyma and restriction of protoxylem and lignified tissue to definite xylem segments in the stem. By the loss of intrafascicular and finally of fascicular cambium, the transformation of the woody cylinder to the herbaceous stem would be complete. This mode of development is caused by the increased activity of the leaves and the need for greater storage capacity. The broad rays, the pith sheath, the elements of the phloem, all serve this purpose. The libriform fibres segregated in bundles supply the necessary tensile strength for the vine, while the broad parenchyma plates afford great flexibility.

Thus the wood structure of the Vitaceae is intermediate between that of the arboreal and fruticose types and the herbaceous stem. The course of evolution in the family constitutes another link in the chain of facts which supports the new theory of the origin of the herbaceous habit in plants.

#### CONCLUSIONS.

1. The ancestors of Vitaceae were shrubby or arboreal forms, in the central cylinder of which occurred interfascicular broad rays and intrafascicular linear rays. The genus *Leea* is the most primitive living representative of the family.
2. The linear rays of the mature normal wood of all species of *Vitis* examined have disappeared, except in *V. californica*, Benth., which is on these grounds the most primitive member of the genus.

3. Vestiges of the linear ray persist in other members of the Vitoideae, in the seedling, and in the leaf segments of the first annual ring. It reappears likewise after an injury.

4. From the more complete loss of the linear ray and the reduction of the xylem cylinder to separate woody bundles, *Ampelopsis* and *Cissus* appear to be less primitive than *Vitis*.

5. The vine, derived from woody ancestors, shows an approach to the herbaceous type of stem.

In conclusion, I wish to express to Dr. E. C. Jeffrey my sincere appreciation of the use of materials, and of advice and aid given in the course of this investigation. Thanks are due also to Mr. Arthur J. Eames for the use of seedling material. I am likewise indebted to the Director of the Harvard Botanical Garden for material of *Leea*, and to the Director of the Arnold Arboretum of Harvard University for numerous species of Vitaceous plants.

---

#### EXPLANATION OF PLATE XV.

Accompanying Miss Adkinson's article on Some Features of the Anatomy of the Vitaceae.

Fig. 1. Wood of *Leea* sp. in transverse section, showing both linear and large rays.  $\times 40$ .

Fig. 2. The same.  $\times 100$ .

Fig. 3. Wood of *Vitis californica*.  $\times 40$ .

Fig. 4. The same.  $\times 100$ .

Fig. 5. Seedling stem of *V. cordifolia*.  $\times 10$ .

Fig. 6. Segment of the woody cylinder of the same.  $\times 100$ .

Fig. 7. Foliar segment of the woody cylinder of the same.  $\times 100$ .

Fig. 8. Section showing both foliar and non-foliar segments of the stem of *Vitis* sp.  $\times 10$ .

Fig. 9. Part of the same.  $\times 40$ .

Fig. 10. Foliar segment of the stem of *V. Coigniliae*.  $\times 30$ .

Fig. 11. Wood of *Ampelopsis Veitchii*.  $\times 40$ .

Fig. 12. Foliar segment of the stem of the same.  $\times 40$ .







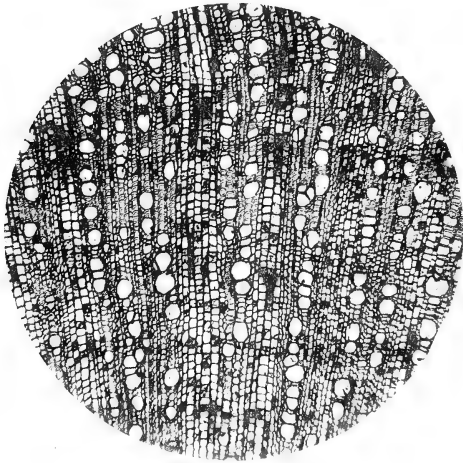

1.

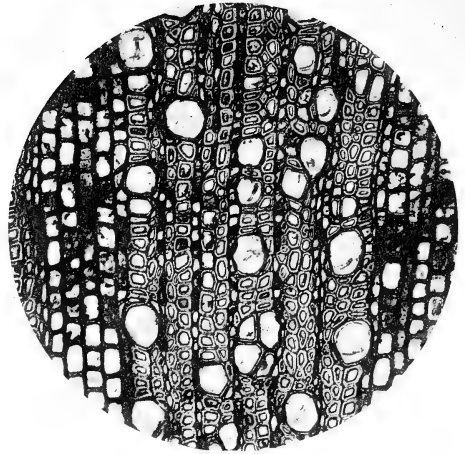

2.

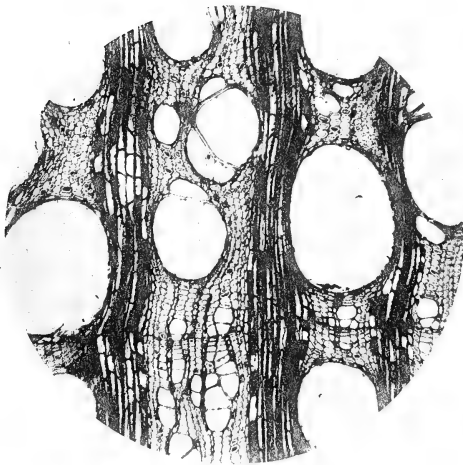

3.



4.

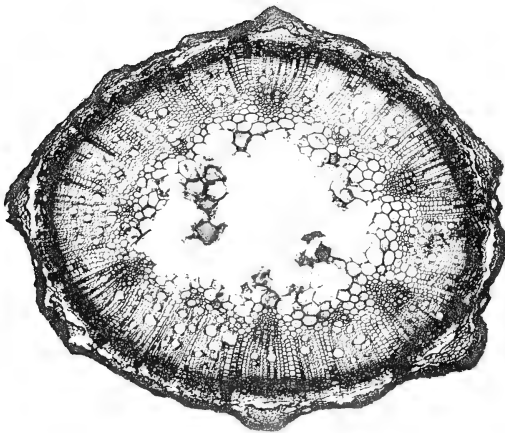

5.

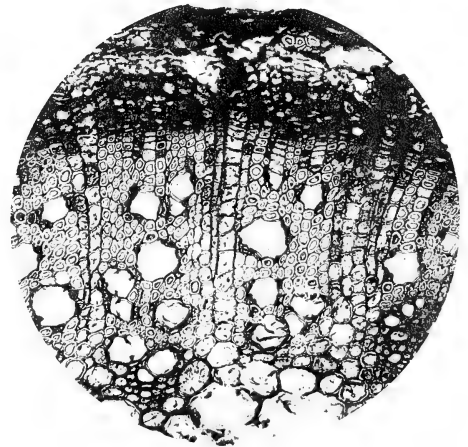

6.

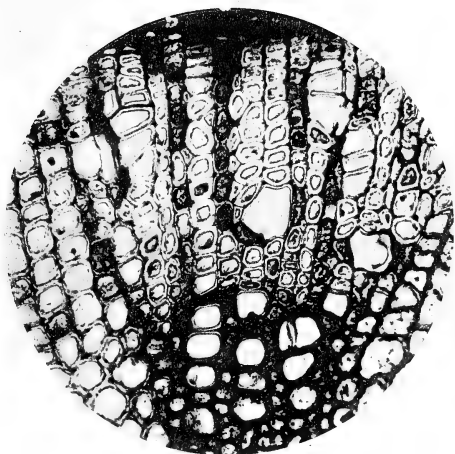

7.

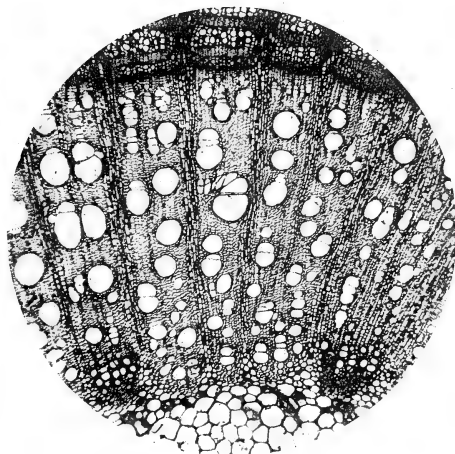

8.

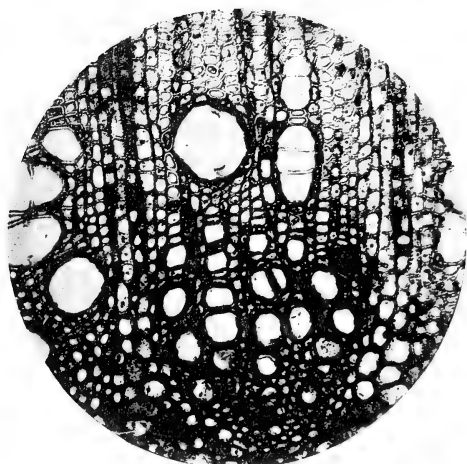

9.

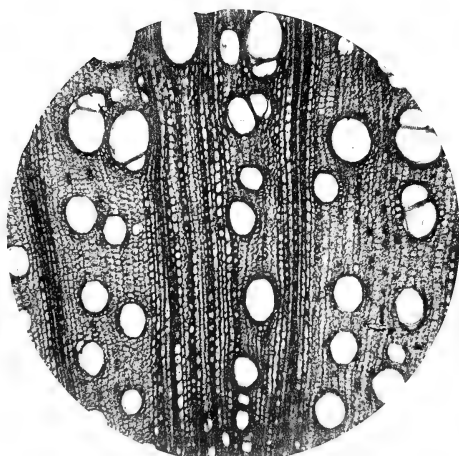

10.

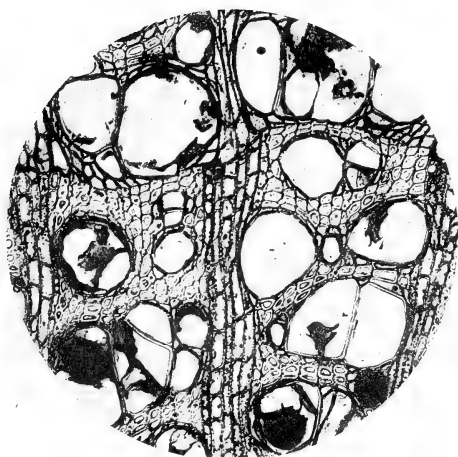

11.

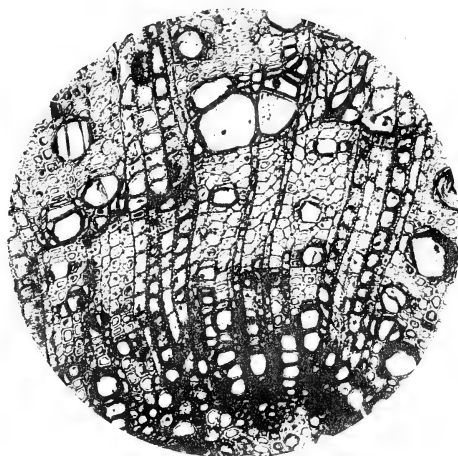

12.



## The Weeds of Arable Land. III.

BY

WINIFRED E. BRENCHLEY, D.Sc., F.L.S.

*Rothamsted Experimental Station (Lawes Agricultural Trust).*

INITIAL investigations carried on in parts of Bedfordshire and the West Country<sup>1</sup> have shown that while definite relations exist between the weeds and soils of arable lands, these relations are partly local and partly general in extent. It is evident that in some cases a weed that is symptomatic of a certain soil in one district is not so exclusively associated with it in another, but there are also indications that certain species are symptomatic or characteristic of the same type of soil in different districts. Naturally, the 'general' relations will need more exhaustive proof than the 'local', and a true estimate will only emerge gradually as the field of investigation is enlarged, since each fresh observation ratifies or discounts the previous deductions.

In the earlier work special care was taken to select districts in which drift deposits were conspicuous by their absence, so that the soils dealt with might be regarded in the main as derived from the geological formations immediately underlying them. In Bedfordshire, Wiltshire, and the Bath district large tracts of land exist overlying one particular formation, such as Greensand, Chalk, or Gault, so that one can feel some confidence as to the origin of the soil. It was found, however, that the geological derivation apparently has little to do with determining the weed flora, the texture being a far more potent factor. Chalk forms the great exception to this rule on account of its very peculiar nature. To verify this still further, in 1912 the scene of operations was transferred to Norfolk, where drift soils are dominant. Geologists aver that the soils in Norfolk are derived from glacial deposits, the supposition being that at two distinct glacial periods the country was invested by ice sheets, which on melting left the drift deposits known as 'North Sea Drift' and 'Boulder Clay'.<sup>2</sup> These drift deposits are

<sup>1</sup> Brenchley, W. E.: Weeds of Arable Land. I. *Ann. Bot.*, xxv, No. xcvi, Jan. 1911, pp. 155-65. *Ibid.*, II. *Ann. Bot.*, xxvi, No. ci, Jan. 1912, pp. 95-109.

<sup>2</sup> See Harmer, F. W.: The Glacial Deposits of Norfolk and Suffolk. *Trans. Norfolk and Norwich Naturalists' Soc.*, vol. ix, pp. 108-33.

very variable in nature and texture even within very circumscribed areas, gravel, sand, loam, and clay occurring in close proximity in many places. In some districts the Boulder Clay is very chalky in nature owing to the grinding up and mixing of the underlying chalk strata with the glacial deposits. In some parts of West Norfolk these underlying strata themselves crop out, so that it was possible to get some insight into the weed flora of the Chalk, Gault, and Lower Greensand in addition to that of the heterogeneous glacial soils.

In the course of the season's work the following places were taken as centres, and the weed flora was investigated for some miles round: North Walsham, Aylsham, Hargham, Bressingham, Harleston, Field Dalling, Swaffham, Marham, Snettisham, and Sandringham. The plan of campaign was the same as in the two previous years, and the relative prevalence of the weeds was again notified as—

- (1) Dominant.
- (2) Sub-dominant.
- (3) Distributed.
- (4) Occasional.
- (5) Scarce.

During the season's survey about 480 fields were visited, yielding a harvest of 162 species of weeds, belonging to 104 genera. Of these 36 species, representative of 32 genera, were each seen once or twice only. The total number of species and genera occurring was far in advance of those from Bedfordshire and the West Country, though the number seen once or twice only was practically the same in each of the three districts.

The strictness with which the various plants keep to their several habitats of field and hedgerow is most remarkable. A very few species, such as *Scabiosa arvensis* and *Centaurea nigra*, are denizens of both habitats, but otherwise it is very rare to find any incursion from one to another, even at the extreme edges of the fields. As heretofore, only the plants growing in among the crops were considered as weeds.

The chief species of weeds, with their habitats and relative dominance, were as follows:

**Ranunculaceae.** *Ranunculus arvensis*. Confined to the heavier loams and clay. Seldom seen, never dominant.

*Ranunculus repens*. Distributed over all soils, but seldom seen on chalk. Once dominant on heavy loam, usually distributed.

**Papaveraceae.** *Papaver Argemone*. Only occasionally seen, on light loams. Never in any quantity.

*Papaver Rhoeas*. One of the commonest weeds. Chiefly on sand, very frequent on light loams and chalk. Often dominant.

**Fumariaceae.** *Fumaria officinalis*.<sup>1</sup> Characteristic of light and chalky soils, never seen on clay. Occasionally dominant.

**Cruciferae.** *Brassica alba*. Very rarely seen, and then on light and sandy loam; once dominant on sandy loam.

*Brassica arvensis* (*B. Sinapis*). Found on all types of soil. Specially frequent on clay and heavy loam, rare on sand. Sometimes dominant on chalk, clay, and loam.

*Capsella Bursa-pastoris*. Universally distributed on all soils; very common. Occasionally dominant on loam.

*Raphanus Raphanistrum*. Characteristic of chalk and sand. Occasionally dominant on chalk.

*Sisymbrium Thalianum* (*Arabis Thaliana*). Associated exclusively with light loams and sandy soils. Occasionally dominant, usually distributed.

**Resedaceae** *Reseda lutea*. Confined to chalk and sand. Infrequent in occurrence, never dominant.

**Violaceae.** *Viola tricolor*. Characteristic of light soils, sand, and chalk. Never dominant.

**Caryophyllaceae.** *Arenaria serpyllifolia*. Confined to light sandy and calcareous soils. Occasionally dominant on light sandy loam. Far more frequently seen than in the previous years' work.

*Cerastium vulgatum*. Occurs on all types of soil, though rarely on clay. Generally distributed, never dominant.

*Lychnis alba*. Chiefly associated with the lighter soils and sandy loam, though it is found on all types of land. The plant is very widely spread, but only occurs in small quantities.

*Lychnis Githago*. Usually occurs on loam. Generally scarce in distribution.

*Silene anglica*. Confined to sandy soils. Never very prevalent.

*Silene inflata* (*S. Cucubalus*). Chiefly on chalky and light soils. Twice dominant on sand, but usually distributed or occasional.

*Silene noctiflora*. Practically confined to the light soils and chalk. Usually distributed, never dominant.

*Spergula arvensis*. Confined to sand and light soils of a non-calcareous character. Frequently dominant on sand.

*Stellaria media*. Distributed over all types of soil; occasionally dominant on the lighter lands.

**Geraniaceae.** *Erodium cicutarium*. Distributed on sand and very light soils.

<sup>1</sup> The nomenclature throughout is now taken from Hayward's Botanist's Pocket Book, 13th edition, 1909. In the earlier papers that of Bentham and Hooker's British Flora was used, and the old collective name 'Fumaria officinalis' is retained, as this genus is exceedingly difficult to subdivide in the field under the conditions of the investigation. Where any change has been necessary the name previously used is added in brackets.

*Geranium dissectum*. Associated with heavy soils. Never dominant.

*Geranium molle* (including var. *aequale*). Confined to light and chalky soils. Once dominant on sand, but usually distributed.

*Geranium pusillum*. Only seen on light and chalky soils. Never dominant.

**Rosaceae.** *Alchemilla arvensis*. Characteristic of light and of sandy soils, very rare on chalk. Occasionally dominant, usually distributed.

*Potentilla Anserina*. Chiefly associated with medium soils, less frequent on sand and rare on clay. Occasionally dominant.

*Potentilla reptans*. Occurred on the heavier soils, especially clay, but never seen in any quantity.

**Umbelliferae.** *Daucus Carota*. Associated with all types of soil and occasionally dominant.

*Scandix Pecten-veneris*. Found on all soils except chalk, though seen occasionally on chalky loam. Once dominant on light loam.

**Rubiaceae.** *Galium Aparine*. Chiefly on heavy loam and clay. Never dominant, and only seen frequently at Bressingham and Harleston.

*Galium sp.* Distributed on all types of soils. (This was a species which defied identification. The plant grew flat against the ground, in a kind of mimic rosette, the leaves usually being in whorls of four. In many ways it resembled a squat form of *G. Aparine*, but it was never seen in flower or fruit. This form was only seen in West Norfolk, in the districts round Swaffham and Snettisham; *G. Aparine* occurred alongside it in some cases.)

*Sherardia arvensis*. Found on all types of soil, but more usually on the lighter loams and chalk. Usually occasional or scarce, but generally distributed on chalk.

**Dipsaceae.** *Scabiosa arvensis*. Chiefly on light and sandy soils, absent from clay. Distributed or scarce.

**Compositae.** *Anthemis arvensis*. Chiefly on sandy soils and chalk. Very rare on clay. Occasionally dominant.

*Anthemis Cotula*. Usually occurred on loam, but not often seen.

*Artemisia vulgaris*. Distributed on light calcareous soils.

*Carduus nutans*. Occurred on light and calcareous soils. Once dominant on sand.

*Centaurea Scabiosa*. Associated with light and chalky soils. Never seen on clay. Once dominant on sand.

*Chrysanthemum segetum*. Confined to non-calcareous sand. Not very frequent, but usually dominant when present.

*Cichorium Intybus*. Associated with chalky soils, though twice seen on sand. Usually scarce.

*Cirsium arvense* (*Carduus arvensis*). By far the most common of all weeds. Ubiquitous among all crops and on all soils. Frequently dominant.



*Filago germanica.* Distributed on sandy and chalky soils.

*Gnaphalium uliginosum.* Characteristic of sandy soils. (The records for this plant obtained in 1910 and 1912 agree as to its habitat, and so do not fall into line with the usually accepted idea that it is a denizen of moist places.)

*Matricaria Chamomilla.* Occurred either on sand or heavy loam. Usually infrequent, but once dominant on sand.

*Matricaria inodora.* Distributed over all types of soil and occasionally dominant on light and sandy loams.

*Senecio vulgaris.* Found on all soils. Once dominant on sand.

*Sonchus arvensis.* Associated with all soils, but more especially with heavy loam and clay. Occasionally dominant.

*Tussilago Farfara.* Practically confined to clay and the heavier loams. Never dominant.

**Campanulaceae.** *Legousia hybrida* (*Campanula hybrida*). Occurred on the lighter soils, though infrequent on sand. Absent from clay. Never dominant, often scarce.

**Primulaceae.** *Anagallis arvensis.* Associated with all types of soil, but when it occurred on chalk it was scarce in distribution. Never dominant.

**Boraginaceae.** *Echium vulgare.* Characteristic of sand. Once dominant.

*Lycopsis arvensis.* Confined to light sandy land—apparently soils may be calcareous or not. Usually occasional or scarce.

*Myosotis scorpioides* (*M. arvensis*). Chiefly on sand and loam; rare on chalk. Never dominant.

**Convolvulaceae.** *Convolvulus arvensis.* Universally distributed as to soil, and frequently dominant. One of the commonest weeds, and often seen on root land before the seeds come up, in company with *Cirsium arvense*.

**Scrophulariaceae.** *Bartsia Odontites.* Chiefly associated with loam; never seen on chalk. Twice dominant on heavy loam.

*Linaria Elatine.* Characteristic of heavy soils. Scarce.

*Linaria minor.* Associated with sandy soils. Infrequent.

*Linaria vulgaris.* Characteristic of chalky soils. Usually distributed.

*Veronica agrestis*.<sup>1</sup> Practically confined to light and sandy soils; from chalk. Rarely dominant.

*Veronica arvensis.* Chiefly on the lighter soils; scarce on chalk. Never dominant.

*Veronica hederaefolia.* Associated with sand and light sandy loams. Absent from clay and chalk. Once dominant on loam.

<sup>1</sup> The exact distinction between *V. agrestis* and *V. Tournefortii* was not recognized at the beginning of the season's work, so possibly a few records of *V. Tournefortii* have been classed as *V. agrestis*, but not vice versa. However, it is evident that the error has not in any way affected the final results except as to the exact number of records of each of the two species.

*Veronica Tournefortii*<sup>1</sup> (*V. Buxbaumii*). Found on all types of soil, including chalk. Occasionally dominant.

**Lamiaceae.** *Galeopsis Tetrahit*. Characteristic of the lighter soils. Rare on chalk.

*Mentha arvensis*. Occurred on all types of soils, but especially on heavy loam. Twice dominant on loam.

*Satureia Acinos*. Chiefly associated with chalky soils. Never dominant.

**Plantaginaceae.** *Plantago lanceolata*. Distributed over all types of soil and occasionally dominant.

*Plantago major* (probably including var. *intermedia*). Universally distributed as to soil. Never dominant.

**Illecebraceae.** *Scleranthus annuus*. Confined to sandy soils; never on chalk. Frequently dominant on sand.

**Chenopodiaceae.** *Chenopodium album*. Distributed over all soils and occasionally dominant.

**Polygonaceae.** *Polygonum aviculare*. Very common on all soils and often dominant.

*Polygonum Convolvulus*. As common as *P. aviculare*, but generally associated with loam and sand. Seen on chalky loam, but never on chalk. Frequently dominant.

*Polygonum Persicaria*. Practically confined to light sandy soils, though one instance of dominance was on clay. (This species often came in if any part of the field happened to be rather damp.)

*Rumex Acetosella*. Only found on sand and light loam; never associated with chalky soils. Sometimes dominant on sand.

*Rumex crispus*. Distributed over all soils and occasionally dominant. (Most Norfolk farmers say that this is the worst weed they have to deal with, but such constant war is waged against it that it is by no means conspicuous in the fields.)

*Rumex obtusifolius*. Only seen on sandy soils. Once dominant.

**Euphorbiaceae.** *Euphorbia exigua*. Chiefly found on clay and the heavier loams. Never dominant, often scarce.

*Euphorbia Helioscopia*. Usually on chalk and calcareous soils. Occasional or scarce in distribution.

**Graminaceae.** *Agropyron repens* (*Triticum repens*). Chiefly on heavy land, but also found on all soils except chalk. Frequently dominant.

*Agrostis alba* (including var. *stolonifera*). Associated with all soils. Frequently dominant.

*Alopecurus myosuroides* (*A. agrestis*). Characteristic of heavy loams and clay; never seen elsewhere. Once dominant on clay.

*Poa annua*. Chiefly on loam and sandy loam; rare on chalk. Once

<sup>1</sup> See note on p. 145.

dominant. (This species is said to be particularly common among fruit trees in plantations.)

*Poa trivialis.* Found on loam and clay. Never dominant.

**Equisetaceae.** *Equisetum arvense.* Associated with most types of soil, but less common on sand and absent from chalk. Occasionally dominant.

The classification of the weeds with regard to the soils they colonize is more difficult when dealing with the drift soils than when the directly derived soils are concerned. Well-marked soils as clay, chalk, and sand are relatively scarce, while loams of all categories are in the ascendant. Generally speaking, the soils are more intermediate in type than in any of the districts investigated previously. Still, an analysis of the lists shows that the weeds do fall into well-defined classes, loam taking its place for the first time as a special subdivision.

**A. Clay and Heavy Loam.**

Fields in this section were comparatively seldom seen, only about 11 per cent. of the total number being really heavy in nature. The heavy soils were chiefly located round Harleston and Bressingham, where they are derived from the Boulder Clay (so being of drift origin), and again in the neighbourhood of Snettisham and Marham. At Snettisham the heavy clay land is down near the sea and is apparently also derived from Boulder Clay, but at Marham an outcrop of the Gault occurs, exceedingly heavy clay being met with cheek by jowl with the sharply defined Chalk outcrop. The dividing line between the two formations is remarkably distinct in this district.

As is so usually the case, while plenty of varieties of weeds occur on clay soils as well as in other habitats, only a few species have a decided preference for the heavy lands, and practically none can be designated as absolutely symptomatic of clay, though a few are certainly characteristic.

The following were found in association with these soils :

- |                        |   |   |
|------------------------|---|---|
| Alopecurus myosuroides | } | characteristic.   |
| Geranium dissectum     |   |   |
| Heracleum Sphondylium  |   |   |
| Linaria Elatine        |   |   |
| Potentilla reptans     |   |   |
| Ranunculus arvensis    |   |   |
| Stachys palustris      | } | relatively frequent on these soils,<br>but found on other types as<br>well. |
| Equisetum arvense      |   |   |
| Euphorbia exigua       |   |   |
| Galium Aparine         |   |   |
| Tussilago Farfara      |   |   |

*Matricaria Chamomilla*—only seen on heavy loam and sand.  
Never on clay.

**B. Loams.**

By far the greater part of the soils investigated in Norfolk are loams, locally known as 'mixed soils', varying in texture from light sandy land to that of a very heavy nature. A local distinction is drawn between a 'sand' and a 'light mixed soil' and between a 'heavy mixed soil' and a 'clay', but this distinction does not hold good when the weed flora is considered. Between the lightest and the heaviest loams there is an intermediate range of loams with which certain weeds are more particularly associated. It seems as though some species of plants do not care for extremes of any kind, but flourish best in the less distinctive habitats. Among such species are :

Anthemis Cotula	}	generally associated with loams.
Bellis perennis		
Brassica alba		
Chrysanthemum leucanthemum		
Euphorbia Peplus		
Lolium perenne		
Lychnis dioica		
Papaver Argemone		

Achillea Millefolium	}	also on sand and sandy loam.
Galeopsis Tetrahit		
Legousia hybrida		
Scabiosa arvensis		
Sisymbrium officinale		
Veronica agrestis		

*Centaurea nigra*—also on chalk.

*Poa trivialis*—perhaps characteristic of the heavier soils.

Equisetum arvense	}	more usual on loams, but also associated with other types of soil.
Lychnis Githago		
Potentilla Anserina		
Prunella vulgaris		

**C. Sand and Sandy Loams.**

These soils are met with all over the county, and in most cases represent the sand and gravel deposits, in others the lightest types of Boulder Clay. In some places the sands are deficient in calcium carbonate; in others, where the chalk rock comes near the surface, they are decidedly calcareous, containing chalk stones, as is well seen at Hargham and East Snettisham. In the north-west of the county the Lower Greensand crops out in the form of 'carstone', which yields a peculiar type of sandy soil deficient in chalk,

giving no effervescence when treated with dilute hydrochloric acid. These carstone soils are well seen at Dersingham, West Snettisham, and Heacham, and are usually of a decided red or yellow colour. The relative quantities of calcium carbonate in the sands are reflected in the flora, such so-called 'acid' or 'sour' plants as *Rumex Acetosella* and *Spergula arvensis* never being found on the calcareous sands. It is hardly correct to say that such plants as *Rumex Acetosella* are definitely symptomatic of 'acid' soils. An acid soil is what is known to the agriculturist as a sour soil, the use of the technical word acid in this connexion being rather unfortunate. A sour soil implies one containing no chalk at all, so that an acid reaction is obtained with litmus paper. *Rumex Acetosella* will grow on soils which do contain a very small percentage of calcium carbonate, as can be seen at Blakeney Point, so that it is better to say that the so-called acid plants are really indicators of soils deficient in chalk, though total absence of calcium carbonate is not necessarily entailed. Warming<sup>1</sup> suggests that nearly all lime soils are rich in soluble mineral substances and that this wealth excludes plants belonging to poorer soils, owing to the competition of plants which flourish best on the richer soils. Cultures made by C. A. Weber and Grübner have clearly demonstrated that none of the calciphobous plants, of which *Rumex Acetosella* is an example, suffer from lime when this is unaccompanied by a large amount of soluble salts, and that they are expelled from calcareous soils by competition. Nevertheless, from a practical agricultural point of view, the presence of calciphobous plants on any land is undoubtedly a sure indication of a deficiency of the chalk which is so essential to the well-being of most plants.

In the present investigation sour soils other than sands have not often come into notice, so that it is not yet possible to say whether there is a flora that is characteristic of sour land of heavier texture.

The lighter soils are characterized by the great diversity of plants composing their flora, a good proportion of the species being definitely characteristic of sand and sandy loams. The classification is as follows :

<i>Chrysanthemum segetum</i>	}	symptomatic of light sandy soils which are very deficient in chalk.
<i>Rumex Acetosella</i>		
<i>Scleranthus annuus</i>		
<i>Spergula arvensis</i>		
<i>Bromus mollis</i>	}	characteristic of sand.
<i>Echium vulgare</i>		
<i>Erophila verna</i>		
<i>Lycopsis arvensis</i>		
<i>Myosotis collina</i>		

<sup>1</sup> Warming, Eug.: *Ecology of Plants*, 1909, p. 67.

Erodium cicutarium	}	characteristic of sand and sandy loam.
Gnaphalium uliginosum		
Holcus lanatus		
Linaria minor		
Rumex obtusifolius		
Sagina nodosa		
Silene gallica		
Urtica dioica		

Alchemilla arvensis	}	also on loam.
Juncus bufonius		
Lamium amplexicaule		
Polygonum Persicaria		
Scabiosa arvensis		
Sisymbrium Thalianum		
Veronica agrestis		
Veronica hederifolia		

Matricaria Chamomilla—also on heavy loam.

Arenaria serpyllifolia	}	also on chalk.
Anthemis arvensis		
Carduus nutans		
Centaurea Scabiosa		
Filago germanica		
Geranium molle		
"    pusillum		
Raphanus Raphanistrum		
Reseda lutea		
Satureia Acinos		
Silene noctiflora		

Papaver Rhoëas—also on chalk and light loam.

#### D. Chalk and Calcareous Soils.

Chalk is found underlying the drift soils over the greater part of Norfolk, but in the eastern and central parts of the county it is usually so deeply situated that it does not affect the surface soils. In West Norfolk, however, an outcrop occurs, so that in some places real chalky land is found, derived directly from the chalk rock, while in others the drift overlying the chalk is decidedly calcareous in nature, due to admixture with the chalky subsoil. Comparatively little of this chalk soil was met with in the season's work, so that it was not possible to definitely associate many species with such land.

Artemisia vulgaris	}	probably characteristic.
Cichorium Intybus		
Crepis virens		
Euphorbia Helioscopia		
Linaria vulgaris		

Aethusa Cynapium	}	also on loam.
Centaurea nigra		

Anthemis arvensis	}	also on sandy soils.
Arenaria serpyllifolia		
Atriplex patula		
Carduus nutans		
Centaurea Scabiosa		
Filago germanica		
Geranium molle		
„ pusillum		
Raphanus Raphanistrum		
Reseda lutea		
Satureia Acinos		
Silene noctiflora		

Papaver Rhoëas—also on sand and loam.

**Weeds of General Occurrence.**

Besides the species which are definitely associated with particular soils, there are a good many plants which occur indiscriminately on any and every kind of land, while others, though absent from one type of soil, are otherwise universally distributed. Into this category come the following :

Agrostis stolonifera	}	universally distributed.
Brassica Sinapsis		
Capsella Bursa-pastoris		
Caucalis nodosa		
Cerastium vulgatum		
Chenopodium album		
Cirsium arvense		
Convolvulus arvensis		
Daucus Carota		
Galium sp.		
Lamium purpureum		
Lychnis alba		
Matricaria inodora		
Mentha arvensis		
Plantago lanceolata		
„ major		

Polygonum aviculare	}	universally distributed.
Ranunculus repens		
Rumex crispus		
Senebiera Coronopus		
Senecio vulgaris		
Sherardia arvensis		
Stellaria media		
Veronica Tournefortii		

Sonchus arvensis—especially on clay.

Chaerophyllum Anthriscus	}	rare or absent from clay.
Fumaria officinalis		
Glechoma hederacea		
Silene inflata		
Veronica arvensis		
Viola tricolor		

Anagallis arvensis	}	scarce on chalk.
Myosotis arvensis		
Poa annua		

Bartsia Odontites	}	absent from chalk.
Erysimum cheiranthoides		
Polygonum Convolvulus		
Scandix Pecten-veneris		
Taraxacum vulgare		
Triticum repens		

Some of the above species are both universally distributed and abundant in occurrence. Some plants (e. g. *Polygonum aviculare*, *Chenopodium album*, *Viola tricolor*, *Cerastium vulgatum*, *Capsella Bursa-pastoris*, &c.) show considerable morphological differences in different places, exhibiting variations in habit, in the size and shape of the leaves, in the size and colour of the flowers. It is quite possible that 'splits' or varieties of these cosmopolitan species may ultimately prove to be as significant as species themselves, and that a certain split may be as definitely associated with a particular type of soil as homogeneous species of other genera. Massart<sup>1</sup> suggests that when a species is found colonizing very diverse habitats, some essential difference really exists between the plants, and that under the combined influences of variability and natural selection a species undergoes a transformation or 'adaptation' which is hereditary, in contradistinction to the 'accommodation' of an individual to place itself in accord with its habitat.

<sup>1</sup> Massart, I.: Le rôle de l'expérimentation en géographie botanique. Rec. Inst. bot. Léo Errera, ix, 1912, pp. 68-80. Abst. in Bot. Centralbl., Band cxx, No. 14, pp. 353-4.



Besides the weeds mentioned in the foregoing lists the following were seen very occasionally, some only appearing once in the season's work :

Ranunculaceae	<i>Myosurus minimus</i>	sand
"	<i>Ranunculus acris</i>	loam
"	" <i>bulbosus</i>	sand and heavy loam
Papaveraceae	<i>Papaver dubium</i>	heavy loam
"	" <i>hybridum</i>	chalk
Cruciferae	<i>Lepidium campestre</i>	loam
"	<i>Sisymbrium Sophia</i>	sand
"	<i>Thlaspi arvense</i>	"
Resedaceae	<i>Reseda luteola</i>	light loam
Caryophyllaceae	<i>Sagina procumbens</i>	sandy loam
Malvaceae	<i>Malva sylvestris</i>	chalky soils
Geraniaceae	<i>Geranium pyrenaicum</i>	light loam
Leguminosae	<i>Anthyllis Vulneraria</i>	sand and chalk
"	<i>Melilotus alba</i>	sandy loam
"	" <i>arvensis</i>	sand
"	<i>Ornithopus perpusillus</i>	"
Rosaceae	<i>Potentilla sterilis</i>	sandy loam
Saxifragaceae	<i>Saxifraga tridactylites</i>	sand
Umbelliferae	<i>Anthriscus sylvestris</i>	loam
"	<i>Pimpinella Saxifraga</i>	chalk
Valerianaceae	<i>Valerianella olitoria</i>	sandy loam
"	" <i>rimosa</i>	" "
Compositae	<i>Cirsium lanceolatum</i>	distributed
"	<i>Erigeron canadensis</i>	sandy soils
"	<i>Filago minima</i>	sand
"	<i>Hypochaeris radicata</i>	heavy loam
"	<i>Lapsana communis</i>	distributed
"	<i>Picris Hieracioides</i>	loam
"	<i>Onopordon Acanthium</i>	chalky sand
"	<i>Senecio Jacobaea</i>	sand and gravel
Boraginaceae	<i>Lithospermum arvense</i>	distributed
Scrophulariaceae	<i>Linaria spuria</i>	loam
"	<i>Verbascum Thapsus</i>	"
"	<i>Veronica serpyllifolia</i>	sandy soil
Orobanchaceae	<i>Orobanche minor</i>	loam and sand
Lamiaceae	<i>Stachys arvensis</i>	chalky loam
Chenopodiaceae	<i>Chenopodium urbicum</i>	light soil
Polygonaceae	<i>Polygonum lapathifolium</i>	sand
"	<i>Rumex Acetosa</i>	"
Euphorbiaceae	<i>Euphorbia platyphyllos</i>	loam

Urticaceae	<i>Urtica urens</i>	sand
Graminaceae	<i>Aira caryophyllaea</i>	„
„	<i>Alopecurus pratensis</i>	light loam
„	<i>Bromus sterilis</i>	heavy loam
„	<i>Poa pratensis</i>	loam
Polypodiaceae	<i>Pteris aquilina</i>	sand

COMPARISON OF THE WEED FLORA OF NORFOLK WITH THAT OF  
BEDFORDSHIRE AND THE WEST COUNTRY.

The general aspects of the weed floras are more or less comparable as regards the distribution of the plants, but the number of the species occurring is considerably greater in Norfolk, partly because of the greater diversity in the soil and partly on account of the larger area covered by the investigation. Some few of the weeds are proving to have a real association with definite types of soil, while yet others show decided local differences in their distribution, being absent in one place from the very soil on which they are frequent or even characteristic in another locality. The question as to calcifuges can hardly be reopened at present, as so little chalk land was examined in Norfolk that the data is too meagre. Just one plant, *Poa annua*, stands out conspicuously in that it is the only plant that has proved to be consistently absent or very rare on chalk in each of the three districts.

On the whole there is a closer correspondence between the weed floras of Norfolk and Bedfordshire than between that of the West Country and the Eastern Counties, both as regards distribution and the actual species found, a fact which may be due to the geographical proximity and to a closer approximation in the nature of the soils in the east.

The most outstanding features of distinction and similarity are :

I. Certain species are definitely associated with sand, always choosing that as a habitat in every locality :

<i>Chrysanthemum segetum</i>	<i>Sisymbrium Thalianum</i>
<i>Rumex Acetosella</i>	<i>Spergula arvensis</i>
<i>Scleranthus annuus</i>	

*Brassica arvensis*, on the other hand, shows a consistent dislike of sandy soils. This is borne out by the work of Verhulst,<sup>1</sup> who states that his researches show that no affinity exists between *Sinapsis arvensis* (*Brassica arvensis*) and light soils. He finds *Brassica arvensis* to be characteristic of chalky soils and calcareous clays, while *Raphanus Raphanistrum* is confined to sand, clays, and non-calcareous muds, though where the nature of the soil

<sup>1</sup> Verhulst, A.: Quel est le vrai caractère biologique du *Raphanus Raphanistrum*, L., et du *Sinapsis arvensis*, L.? Bull. Soc. Roy. Bot. Belgique, 48. 4. 1911, pp. 248-56. Abst. in Bot. Centralb. Band cxx, No. 12, p. 317.

is variable the two species occur pell-mell in various proportions. He also concludes that *Raphanus* is calcifuge and *Brassica arvensis* calcicolous, but this statement is not borne out in its entirety by the present investigations, though broadly it meets the case.

2. While *Poa annua* and *Anagallis arvensis* have a dislike for chalk, other plants are always to be found on calcareous land, though they are frequently seen on light soils as well. The chief of these are :

Centaurea Scabiosa	Silene inflata
Papaver Rhoeas	Viola tricolor
Reseda lutea	

3. *Euphorbia exigua* and *Ranunculus arvensis* have always proved to be characteristic of heavy land, i. e. heavy loam and clay.

4. The following species show very striking distinctions in their distribution in different districts :

*Bartsia Odontites.* Never recorded from chalk in Norfolk or Bedfordshire and usually seen on the heavier soils. Characteristic of chalk in the West Country and seldom seen on the heavy land.

*Chenopodium album.* Bedfordshire. Never recorded from chalk, most frequent on sand and light loam.

West Country. Frequently seen on chalk and clay, but absent from sand.

Norfolk. Usually distributed over all types of soil.

*Myosotis arvensis.* Bedfordshire. Found on all soils.

West Country. Characteristic of chalk land.

Norfolk. Rare on chalk.

*Ranunculus repens.* Rare on chalk in the east, but frequent on calcareous land in the West Country.

*Scandix Pecten-veneris.* Bedfordshire. Practically distributed.

West Country. Characteristic of and practically confined to chalk.

Norfolk. Absent from chalk, and characteristic of clay and loam.

#### RELATIONS EXISTING BETWEEN THE WEEDS AND THE CROPS.

After three seasons' work in the fields it is gradually becoming possible to interpret the earlier results in the light of the current year's work. The first impression obtained was that the crop played very little part in determining the weed flora, while the nature of the soil practically settled everything. Leguminous plants proved to be an exception to this rule, presumably because they tend to smother out certain weeds owing to their peculiarly leafy habit of growth, and also because certain other weeds seem to be habitually introduced with the seeds.

In a recent study on the purity of agricultural seeds Borlase <sup>1</sup> gives the following weed seeds as commonly occurring as impurities in samples of clover and other leguminous seeds :

Bromus mollis	Plantago lanceolata
Caucalis Anthriscus	Poa annua
Festuca bromoides	Prunella vulgaris
Geranium dissectum	Rumex Acetosella
„ molle	„ crispus
Lychnis alba	Sherardia arvensis

*Chrysanthemum leucanthemum*, *Rumex Acetosa*, and *Lychnis diurna* are also occasionally found. It appears that *Geranium dissectum* is the species of *Geranium* commonly associated with Red Clover seeds, while *Geranium molle* is found among Alsike and White Clover seeds. With regard to cereals and roots Borlase states that 'in the former there are *very* few weed seeds, as their presence would be easily detected owing to differences in size and colour, and with the latter difference of shape and colour would reveal most to the naked eye'. He also quotes two samples of weeds introduced with imported seeds which have established themselves as serious pests in parts of Cornwall. *Bromus secalinus* is a bad pest in the Winter Oat crop, but in no other, and may have been introduced from Canada, where it is common and is known as 'Cheat'. *Matricaria suaveolens* was introduced into Cornwall about fifteen years ago from North Asia or Western North America, and is now so prevalent in some places that it absolutely destroys the corn crops.

It is now evident that while the soil is the primary determining factor, still the nature of the crop plays a larger part than was originally supposed. While this influence is partly due to the different habits of the crops, it is probably more the result of the varying methods of cultivation applied to the crops. Broadly speaking, a four-course rotation is usually followed in the district studied :

- (1) Wheat.
- (2) Roots.
- (3) Barley or oats.
- (4) Seeds and leguminous crops.

With the seed crops nothing can be done to keep the land clean, so the weed flora among the ensuing wheat tends to be specially fruitful in the varieties occurring in the young corn, though if the crop is very heavy it tends to strangle many of the weeds later on, a fact that is usually attributed to the exclusion of light and air. With the root crops comes the

<sup>1</sup> Borlase, W. : The Study of Agricultural Seeds. Journ. Board. Agric., xix, No. 7, pp. 529-41. I am also indebted to Mr. Borlase for a private communication in which he gave me much of the information in this paragraph.

opportunity for a thorough cleaning of the land with cultivator and hoe, so many species which cannot withstand such drastic treatment tend to be conspicuous by their absence among roots. The barley and oats make a fair start on clean ground, and if the seed crop of clover, &c., is put down with the grain and makes fair growth, the weeds are very few in number and variety, as they have no chance to get a fair start in life before they are smothered out of existence. The seed crops offer quite different conditions. No cultivation is possible among such crops as clover and lucerne, so any weed seeds in the soil or introduced with the 'seeds' have the opportunity to germinate and flourish undisturbed if only they can compete successfully with the overshadowing of the crop; but many species fail utterly in doing this, and so are generally absent from seed crops, while others seem to make a speciality of growing under such conditions.

For working purposes it has proved necessary to divide up the seed crops into two classes, as the weed floras are frequently distinctive:

'Seeds'—clover, temporary pasture, grasses.

'Legumes'—peas, beans, lucerne, sainfoin, lupins.

In the 1912 season some plants were found to be absent from seed and from root crops, while a few others were nearly always associated with cereals alone or with cereals and roots.

*Weeds absent or very rare in seed crops.*

Agropyron repens	Polygonum Convolvulus
Agrostis stolonifera	„ Persicaria
Alopecurus myosuroides	Rumex obtusifolius
Chenopodium album	Scandix Pecten-veneris
Erysimum cheiranthoides	Silene inflata
Galium Aparine	Spergula arvensis
Gnaphalium uliginosum	Stellaria media
Legousia hybrida	Taraxacum vulgare
Poa annua	Veronica hederaefolia
Polygonum aviculare	

*Weeds absent or very rare in root crops.*

Aethusa Cynapium	Daucus Carota
Alchemilla arvensis	Echium vulgare
Alopecurus myosuroides	Erophila verna
Anthemis arvensis	Euphorbia exigua
Bartsia Odontites	Holcus lanatus
Bellis perennis	Lychnis Githago
Cerastium vulgatum	Lycopsis arvensis
Cichorium Intybus	Matricaria Chamomilla
Crepis virens	„ inodora

Nepeta hederacea  
Reseda lutea  
Rumex obtusifolius

Taraxacum vulgare  
Veronica arvensis

*Weeds only associated with cereal crops.*

Anthemis Cotula  
Galeopsis Tetrahit  
Heracleum Sphondylium  
Juncus bufonius  
Lapsana communis

Lolium perenne  
Poa trivialis  
Ranunculus arvensis  
Sagina nodosa  
Sisymbrium officinale

*Weeds only associated with cereals and roots.*

Brassica arvensis  
Centaurea nigra  
Chrysanthemum segetum  
Fumaria officinalis  
Lamium amplexicaule

Lamium purpureum  
Linaria minor  
Raphanus Raphanistrum  
Senebiera Coronopus  
Silene noctiflora

*Weeds only associated with seeds and legumes.*

Cirsium lanceolatus  
Filago germanica

Geranium dissectum

Comparison with the Bedfordshire results (1910) show that many species are consistently absent from or very rare in seed crops in both districts.

Nearly all the weeds are to be found to some extent among the cereal crops, and generally the kind of cereal makes no difference. A few plants, however, seem to exercise some selection as to which cereal crop in the rotation they associate with. Most of these species are generally or exclusively found with wheat, while yet a few more are never seen with the corn, but only with barley or oats.

Anthemis Cotula  
Erophila verna  
Juncus bufonius  
Poa trivialis  
Sagina nodosa

} always found with wheat.

Alchemilla arvensis  
Alopecurus myosuroides  
Cerastium vulgatum  
Chrysanthemum segetum  
Heracleum Sphondylium  
Ranunculus arvensis  
Rumex obtusifolius  
Triticum repens

} usually found with wheat.

Artemisia vulgaris	}	never with wheat ; always with barley or oats.
Carduus nutans		
Linaria minor		
Raphanus Raphanistrum		
Silene gallica		

In all probability this selectivity is the result of some peculiar adaptation to the particular cultural conditions of the associated crop. This association with particular cereal crops is, however, not yet proved universally. So far as the species correspond, there is a fairly close agreement between the Bedfordshire and Norfolk results, but in the West Country some species, as *Alopecurus myosuroides*, *Heracleum Sphondylium*, *Chrysanthemum segetum*, are associated with wheat, barley, and oats instead of being chiefly found with wheat as they are in the Eastern Counties. This may prove to be due to differing local customs with regard to the growing of Spring or Winter Oats, but information on this point is not immediately available.

When the tabulated results for the three years are placed side by side and compared, it is seen that certain of the weeds are always to be found in association with all types of crop in the different districts. Other species are apparently more variable—perhaps they are rather more sensitive to differences of local conditions—and so while they may be associated with every type of crop in one place, they may be absent from one or other of the crops in another district. A few plants are much more rigid in their adherence or aversion to some particular crop. For instance, the following plants have been frequently observed in each of the three seasons, and consistently they have been found to be either absent or very rare among root crops :

Anthemis Cotula	Ranunculus acris
Bartsia Odontites	„ arvensis
Cerastium vulgatum	Taraxacum vulgare
Plantago lanceolata	

This probably indicates that these plants are particularly impatient of interference, and so they find a position among the root crops untenable on account of the repeated cultivation carried on.

Again, some other species seem to be quite unable to cope with the keen competition for light, and possibly for air, that occurs among the seed crops, as is indicated by the rarity with which the following are found in such surroundings :

Agropyron repens	Poa annua
Gnaphalium uliginosum	Veronica hederaefolia
Legousia hybrida	

This hypothesis is upheld by the behaviour of two species of *Polygonum*, *P. aviculare* and *P. convolvulus*. These plants were exceedingly rare among seeds in Norfolk and Bedfordshire during two seasons in which plenty of rain had fallen, so that the crop had made good growth, rendering competition keen. In the West Country both these *Polygonum*s were found with seeds, but this was in a very dry season in which a long period of drought immediately succeeded the sowing of the crop. As a result little growth was made, thus enabling these sensitive weeds to get their footing in an unusual habitat.

A very few plants seem to be even more exclusive in their association, the following species being found only with cereals :

Lapsana communis	Plantago media
Lolium perenne	Poa trivialis

The indications are that many of the weeds will ultimately prove to have a very decided preference for or abhorrence of some particular class of crop, but that these individual peculiarities are liable to be modified by local conditions, although some plants may prove strong enough to master the local variations, so remaining consistent in their crop association.

The question arises as to the effect of impurities in the seeds sown upon the weed flora. Broadly speaking, the effect is not well marked. Of all the impurities indicated by Borlase<sup>1</sup> as occurring in Leguminous seeds, *Geranium dissectum* is the only one which is confined to such crops during growth. *Poa annua*, which is introduced with the crop seed, is conspicuous by its absence in the grown crop. At present it does not seem possible to draw any conclusion with regard to this point. In the cereals so few weed seeds are sown that their effect is practically negligible.

#### *Points of Special Interest.*

1. The different orders of flowering plants vary very much in the contribution they make to the weed flora of the arable lands. Many of them provide just one or two species, but when the large orders are considered the differences in representation are very striking. Leguminosae, Rosaceae, Umbelliferae, and Chenopodiaceae are very poorly represented, both *relatively* in proportion to the size of the orders, and *actually* in the number of species occurring as weeds, Lamiaceae being very little better. Ranunculaceae, Papaveraceae, Geraniaceae, and Euphorbiaceae each provide one main genus, but in each case several members of that genus are commonly found.

<sup>1</sup> See p. 156.



Scrophulariaceae is very much to the fore with the genera *Veronica* and *Linaria*, both of which yield several species, the Veronicas being among the most common of weeds. Cruciferae and Caryophyllaceae are each represented by several genera with about one species from each as a rule, though the genera *Brassica* (Cruciferae) and *Lychnis* and *Silene* (Caryophyllaceae) are very rich in their contribution of species. Polygonaceae, again, is particularly well marked with several species of *Polygonum* and *Rumex*, which have the doubtful distinction of being among the commonest and worst weeds from the farmer's point of view. Gramineae yields a fair number of species from different genera, but *the* weed order is undoubtedly Compositae so far as the number of representatives is concerned, for at least half the British genera of this large order contribute one or more of their species to the weed flora. The distribution of the Compositae, too, is very wide, both as regards the soils and crops with which they are associated.

The analyses indicate that the cultivated fields provide a definite ecological habitat, which is differently adapted to the support of the various great families of plants.

2. Different species of the same genus are often distinctive in the type of soil they characteristically inhabit, as the following well-marked instances show :

<i>Anthemis arvensis</i>	sandy soils and chalk
„ <i>Cotula</i>	loam
<i>Carduus nutans</i>	calcareous soils
„ <i>arvensis</i>	distributed
<i>Chrysanthemum Leucanthemum</i>	loam
„ <i>segetum</i>	sand
<i>Euphorbia exigua</i>	heavy loam and clay
„ <i>Helioscopia</i>	calcareous soils
„ <i>Peplus</i>	loam
<i>Geranium dissectum</i>	heavy loam and clay
„ <i>molle</i>	light and chalky soil
„ <i>pusillum</i>	„ „ „ „
<i>Linaria Elatine</i>	heavy soils
„ <i>minor</i>	sandy soils
„ <i>vulgaris</i>	calcareous soils
<i>Polygonum aviculare</i>	distributed
„ <i>Convolvulus</i>	loam and sand
„ <i>Lapathifolium</i>	sand
„ <i>Persicaria</i>	light sandy soils
<i>Ranunculus acris</i>	loam
„ <i>arvensis</i>	heavy loam and clay
„ <i>repens</i>	distributed

Rumex Acetosella	'acid' sandy soil
„ crispus	distributed
„ obtusifolius	sandy soil

These records agree in most respects with those obtained in the West Country in 1911, except in that certain plants seem rather more varied in their distribution in Norfolk.

In contradistinction to the above, the genus *Veronica* with all its different species is typically characteristic of the sandy and light soils, *V. Tournefortii* being the only one that is found to any extent on heavy land.

3. In one district, round Swaffham and Narborough, certain fields were observed to carry a flora composed of the most curious mixture of plants. Species usually associated with chalky land were found growing side by side with others characteristic of sandy soils, and even of 'acid' soils. In one case a field that used to be cultivated had been left for several years untouched, and in it were found, among other plants, *Poterium Sanguisorba*, *Anthyllis Vulneraria*, and *Reseda lutea*, all calcicolous plants, together with *Rumex Acetosella*, a decided calcifuge.

In another instance, *Reseda lutea*, *Linaria vulgaris*, *Centaurea Scabiosa*, with other less distinctive chalk plants, were found plentifully in a very sandy field in which *Scleranthus annuus* occurred and in which *Spergula arvensis* was dominant.

These sandy soils were evidently very shallow, overlying a chalk subsoil, and the possible explanation presents itself that the differences in the root systems of the plants may account for the apparent anomaly. From a cursory examination it appears as if most of the acid species found are relatively shallow rooted, and so are able to flourish in the sandy surface layers of soil, while the chalk plants are provided with larger roots and so find it possible to strike right through the unfavourable strata and to draw on the underlying stores of chalk for their nutriment. This supposition with regard to the relative lengths of the roots needs far more confirmation before it can be accepted as proved.

4. At least four varieties of the Mayweeds occurred in the Norfolk fields. Of these, *Matricaria inodora* was the only species that was found distributed on all kinds of soils, heavy as well as light, the others being practically confined to the lighter lands. *Anthemis Cotula* was generally a denizen of loams, *Anthemis arvensis* of sandy soils and chalk, while *Matricaria Chamomilla* reserved itself for either sand or heavy loam. Once again the Mayweeds proved to be very impatient of competition, as not only were they rarely to be found in among the crops, but only at the edges and in open spaces, but also they were universally absent from root crops, where the additional factor of cultivation has to be competed with.

5. A very striking feature of the sandy soils in Norfolk is the presence

of *Lycopsis arvensis* and *Echium vulgare*, both showy plants with conspicuous blue flowers. It is impossible to give a definite opinion on the one season's records, but it seems probable that both are usually characteristic of calcareous sands as opposed to acid soils.

**Common and Local Names.**

For the purposes of reference an alphabetical list of the more important weeds is appended, giving the common and, where possible, the local names :

<i>Achillea Millefolium</i>	Yarrow
<i>Aethusa Cynapium</i>	Fool's Parsley
<i>Agropyron repens</i>	Couch, Twitch
<i>Agrostis stolonifera</i>	Twitch, Couch, Bent-grass
<i>Alchemilla arvensis</i>	Lady's Mantle
<i>Alopecurus myosuroides</i>	Field Foxtail, Black Bent
<i>Anagallis arvensis</i>	Scarlet Pimpernel, Poor Man's Weather Glass
<i>Anthemis arvensis</i>	Corn Chamomile, Mayweed
„ <i>Cotula</i>	Stinking Chamomile, Mayweed
<i>Anthriscus Scandix</i>	Beaked Parsley
<i>Arenaria serpyllifolia</i>	Thyme-leaved Sandwort
<i>Artemisia vulgaris</i>	Mugwort, French Tobacco
<i>Atriplex patula</i>	Common Orache
<i>Bartsia Odontites</i>	Red Bartsia
<i>Bellis perennis</i>	Daisy
<i>Brassica alba</i>	Charlock, White Mustard
„ <i>arvensis</i>	Charlock
<i>Capsella Bursa-pastoris</i>	Shepherd's Purse
<i>Carduus nutans</i>	Musk Thistle, Dog Thistle
<i>Caucalis nodosa</i>	Knotted Hedge-parsley
<i>Centaurea nigra</i>	Hardhead, Bunk, Knapweed
„ <i>Scabiosa</i>	Greater Knapweed, Bunk.
<i>Cerastium vulgatum</i>	Mouse-ear Chickweed
<i>Chenopodium album</i>	Fat Hen, Mutton Tops, Lamb's Quarters
<i>Chrysanthemum segetum</i>	Corn Marigold, Yellow Daisy.
<i>Cichorium Intybus</i>	Chicory
<i>Cirsium arvensis</i>	Creeping Thistle
<i>Convolvulus arvensis</i>	Bindweed, Wild Convolvulus
<i>Daucus Carota</i>	Carrot
<i>Echium vulgare</i>	Viper's Bugloss
<i>Equisetum arvense</i>	Horsetail, Mare's-tail, Cat's-tail
<i>Erodium cicutarium</i>	Common Stork's-bill
<i>Erysimum cheiranthoides</i>	Treacle Mustard
<i>Euphorbia exigua</i>	Dwarf Spurge

Euphorbia Helioscopia	Sun Spurge
„ Peplus	Petty Spurge, Wee Gweedie
Filago germanica	Upright Cudweed
Fumaria officinalis	Fumitory
Galeopsis Tetrahit	Hemp-nettle
Galium Aparine	Cleavers, Goosegrass, Robin-run-the-hedge, Clider
Geranium dissectum	Cut-leaved Crane's-bill
„ molle	Dove's-foot „ „
„ pusillum	Small „ „
Gnaphalium uliginosum	Marsh Cudweed
Heracleum Sphondylium	Hogweed, Haletrot, Rabbit-food
Holcus lanatus	Yorkshire Fog
Juncus bufonius	Toadrush
Lamium amplexicaule	Hen-bit
„ purpureum	Red Dead-nettle
Lapsana communis	Nipplewort
Legousia hybrida	Corn Campanula, Venus's Looking-glass
Linaria Elatine	Pointed Fluellen
„ minor	Small Toadflax
„ vulgaris	Yellow Toadflax
Lolium perenne	Rye-grass
Lychnis alba	White Campion, Cockle
„ Githago	Corn Cockle
Lycopsis arvensis	Field Alkanet
Malva sylvestris	Mallow, Pig-cheese
Matricaria Chamomilla	Wild Chamomile, Mayweed
„ inodora	Scentless Mayweed
Mentha arvensis	Field Mint
Myosotis scorpioides	Field Scorpion-grass, Forget-me-not
Nepeta hederacea	Ground Ivy
Papaver Argemone	Rough-headed Poppy, Pale Poppy
„ Rhoëas	Red Poppy, Redweed
Plantago lanceolata	Ribwort Plantain, Rib-grass
„ major	Great „
Poa annua	Annual Meadow-grass
„ trivialis	Rough „ „
Polygonum aviculare	Crab-grass, Stoneweed, Pigweed, Iron-grass, Iron- weed, Wire-grass, Wireweed, Knotgrass
„ Convolvulus	Black Bindweed
„ Persicaria	Spotted Persicaria
Potentilla Anserina	Silverweed
Ranunculus acris	Buttercup, Ram's-glass

Ranunculus arvensis	Corn Crowfoot, Bur Buttercup
„ repens	Creeping Buttercup
Raphanus Raphanistrum	Radish, Charlock, Charlick
Reseda lutea	Wild Mignonette
Rumex Acetosella	Sheep Sorrel
„ crispus	Common or Curled Dock
„ obtusifolius	Broad-leaved Dock
Satureia Acinos	Calamint
Scabiosa arvensis	Field Scabious, Corn Flower
Scandix Pecten-veneris	Shepherd's Needle, Venus's Comb
Scleranthus annuus	Knawel
Senebiera Coronopus	Swine-cress
Senecio Jacobaea	Ragwort, Cankerweed
„ vulgaris	Groundsel
Sherardia arvensis	Field Madder
Silene anglica	English Catchfly
„ inflata	Bladder Campion
„ noctiflora	Night-flowering Catchfly
Sisymbrium Thalianum	Thale-cress
Sonchus arvensis	Sow Thistle, Milk Thistle
Spergula arvensis	Spurrey, Sand-grass, Makebeg
Stellaria media	Chickweed
Taraxacum vulgare	Dandelion
Tussilago Farfara	Coltsfoot, Floatweed
Urtica dioica	Stinging Nettle
Veronica agrestis	Field Speedwell
„ arvensis	Wall „
„ hederæfolia	Ivy-leaved Speedwell
„ Tournefortii	Buxbaum's Speedwell, Cuckoo's Leader
Viola tricolor	Wild Pansy, Kiss-me-over-the-garden-gate, Love-in-idleness.

#### SUMMARY.

1. The close association existing between the weeds of arable land and the soils on which they grow holds good for 'drift' soils as well as for those derived from the underlying rocks. As before, the texture of the soil was more important than its derivation in determining the weed flora.

2. It was again found that this association may be either—

(a) *General*. When a weed is always associated with one type of soil in every district.

(b) *Local*. When a weed associated with a soil in one district is absent from or rare on similar land in other places.

3. On the whole the Norfolk and Bedfordshire weed floras compare more closely with one another than with that of the West Country, a fact attributed partly to geographical proximity and partly to closer approximation in the nature of the soil in the Eastern Counties.

4. A closer relationship evidently exists between the weeds and the crop than has hitherto been recognized. This is probably largely due to the particular conditions of cultivation of the various crops and to their place in the rotations practised.

5. It is possible that a very few species will prove to have a preference for growing with wheat, while yet a few others are very rare with that crop. This suggestion, however, is very tentative as yet.

6. The different orders of flowering plants contribute to the weed flora in varying proportions, some of the larger orders being represented by very few species, while others are most generous in the contribution they make.

7. When several members of a genus occur as weeds, it frequently happens that each is a denizen of one particular type of soil characteristic to itself.

8. In one district a curious mingling of 'acid' and 'chalk' plants was found, possibly owing to the superposition of a thin layer of a non-calcareous sand on a chalk subsoil, the difference in the root systems of the plants enabling each to tap the particular soil most suited to its needs.

In conclusion, I wish to express my indebtedness to Professor T. B. Wood and to Sir Eustace Gurney for the many introductions which alone made the work possible in Norfolk, and also to Mr. W. A. Nicholson, who identified many of the doubtful specimens which came to hand. It is not possible to acknowledge by name all those who have aided me by hospitality and advice during the progress of the research, but to all such I desire to tender my grateful thanks.

*October 25, 1912.*

## NOTES.

**THE FRUITING OF CATENELLA OPUNTIA.**—Algologists, and more especially those who have devoted themselves to a study of the reproductive organs of the Rhodophyceae, are well acquainted with the fact that many types produce cystocarpia and antheridia only at rare intervals. This is especially true of *Catenella Opuntia*.

The first record of the discovery of sexual fructifications in the genus *Catenella* occurs in a paper published in the Transactions of the Linnean Society by Goodenough and Woodward in 1797 (Observations on the British Fuci, with particular descriptions of each species, vol. iii, p. 219). They noticed that certain specimens of the plant had the articulations modified in a peculiar manner, but from their description it is difficult to tell whether these were cystocarpia or tetragonidangia.

According to Greville (*Algae Britannicae*, p. 167), Lightfoot (*Fl. Scot.*, vol. ii, p. 961) believed that fructifications of *Catenella Opuntia* occurred at the articulations of the frond; Sir J. E. Smith attributed a reproductive function to the smaller joints of the internal filaments, and Dawson Turner (*Synop. Brit. Fuci*, 1802, p. 388) noticed certain bodies on the frond which he held to be of the nature of fructifications. Greville himself doubted the accuracy of these observations.

Harvey (*Phycologia Britannica*, pl. 88, vol. iii) gave an imperfect description of the cystocarps of *Catenella Opuntia* obtained from material found by Mrs. Griffiths at Torquay. They have also been imperfectly figured by Crouan (*Florule Finist.*, tab. xvi, Fig. 108), while J. G. Agardh (*Epicrisis System. Florid.*, p. 586) described these structures from a single small specimen, the only one in his possession. Material bearing cystocarps has also been collected by Buffham (*Quekett Micr. Club Journal*, Ser. 2, iii, p. 257), but he gives no description of them. Harvey-Gibson (*Journ. Linn. Soc. Bot.*, vol. xxix) states that unpublished observations on the cystocarps of *Catenella Opuntia* had been made by Schmitz from specimens obtained from the Berlin Herbarium in 1885, gathered on the coast of Normandy and also at Ostend in 1832. No further finds of cystocarp-bearing plants are recorded until Harvey-Gibson collected fruiting material at the end of October, 1890, and again in June, 1891, on Puffin Island, North Wales. He described the fructifications in the *Journal of the Linnean Society (Bot.)*, vol. xxix, p. 68. His material was collected from the protected faces of rocks near high-water mark.

At the beginning of August in the present year (1912) I collected plants of *Catenella Opuntia* bearing abundant cystocarpic fruit, in a similar situation on Hilbre Island, Cheshire. Although the plant occurs plentifully on the less exposed faces of the rocks near high-water mark, towards the southern end of the main part of the island, the only specimens I found in the fruiting condition grew in a small crevice in the rocks which from its shape and position afforded special protection to the plants.

I will gladly communicate fruiting specimens to any algologist who may desire to add such to his collection.

HILDA COBURN.

HARTLEY BOTANICAL LABORATORY,  
UNIVERSITY OF LIVERPOOL.

**A CORRECTION.**—I am extremely sorry that in my paper on the Anatomy of the Cone and Fertile Stem of *Equisetum* in the Annals of Botany for July, 1912, I should, by a regrettable oversight, have misquoted Professor Jeffrey. On page 699 of my paper Professor Jeffrey should be quoted as saying: 'It appears to have been shown above and beyond any doubt that the equisetaceous strobilus perpetuates both the non-alternating strands and the complete absence of foliar gaps of the oldest Calamitean forms.' In reproducing this passage, I, by a slip of the pen, wrote 'alternating' instead of 'non-alternating'; but, as will be obvious from the subsequent sentences in which I oppose Professor Jeffrey's conclusion, I had fully realized that it was the occasional superposition of the strands of succeeding internodes of the cone that he regarded as a survival from the older Calamariae.

ISABEL BROWNE.

UNIVERSITY COLLEGE,  
LONDON.

**VARIATIONS IN THE NaCl CONTENT OF NON-HALOPHYTES.**—When non-halophytic plants are grown at different distances from the sea-coast their leaves on analysis exhibit variations in the amount of sodium chloride present in them.

These variations may be due to one or other of two causes, viz.:

- (1) Variations in the amount of sodium chloride present in the soil-water in which the plants are grown and carried to the leaves by the transpiration-current; or
- (2) Variations in the amount of sodium chloride present in the atmosphere and absorbed by the leaves directly.

Czapek (1) refers to such variations as occurring in certain plants cultivated both on the sea-coast and at some distance from it. For example, the pure ash of the leaves of *Beta vulgaris* grown on the seashore was found to contain 21.39 per cent. of chlorine, while the ash of the leaves of the same species grown about  $12\frac{1}{2}$  miles from the shore contained 16.61 per cent. of chlorine.

With the object of determining to what extent direct absorption by the leaf of the sodium chloride in the atmosphere was responsible for the sodium chloride content, estimates were made of the amounts present in the leaves of certain non-halophytes grown on the sea-coast and also at varying distances from it.

The plants analysed were *Acer Pseudo-platanus*, *Ulmus campestris*, and *Ilex Aquifolium*. All leaves experimented with were first of all thoroughly and repeatedly washed until the water used showed no trace of NaCl when tested with silver nitrate.

A solution from the leaves was obtained by slowly incinerating a weighed amount of leaf substance until a white ash only was left. This ash was washed in 100 c.c. of water and the NaCl dissolved out. The amount of NaCl in this solution was discovered by titrating it with a  $\frac{N}{20}$  solution of silver nitrate, potassium

chromate being used as an indicator. This solution was acid and so unsuitable for titration. Neutralization was effected by the addition of caustic soda, phenolphthalein being used as a test for alkalinity.



A solution from the soil was obtained by repeatedly washing a weighed amount of dry soil with 100 c.c. of water. The amount of NaCl in this solution was estimated in the same manner as that from the leaves.

*The amount of sodium chloride in the soil-water* has no influence upon the proportion found in the plant tissues. This is what one would expect from the plant's power of selective absorption. Kerner (2) demonstrated this fact in the case of *Stratiotes aloides*, *Nymphaea alba*, *Chara foetida*, and *Phragmites communis*.

The soil may contain varying quantities of NaCl. Warming (3) states that when a soil dries slowly it may contain as much as 2-3 per cent. NaCl before all but halophytic plants will be expelled from it; if a soil dries quickly only 1 per cent. is needed to act in the same manner.

The data recorded in the subjoined table show that a large amount of NaCl in the soil does not necessarily mean a large amount in the leaves nor vice versa. In analysis I 5 gr. of perfectly dry soil contain 0.01 per cent. NaCl. The soil was obtained from under a plant of *Ulmus campestris* growing six miles from high tide mark. The ash of the leaves contained 0.37 per cent. NaCl. In analysis II the amount of NaCl present in the soil was the same as in I, the sample being taken from beneath a plant of the same species growing about one mile from the sea. The leaf-ash in this case, however, contained 0.71 per cent. NaCl, i. e. almost twice as much as in case I. In analysis III the plant grew 440 yards from high-water mark and was sheltered by buildings from the sea winds, and the soil contained three times as much NaCl as in the two previous cases, whereas the leaf-ash did not contain as much as that taken from plants growing in a more exposed position further inland.

Similar results were obtained on analysis of the soil and leaf-ash, the experimental plant being *Acer Pseudo-platanus*, as may be seen from the data Nos. VI, VII, VIII. The variations, it will be noted, are not so great as in the case of *Ulmus campestris*.

#### *The NaCl in the atmosphere.*

The facts recorded in the table prove that it is the amount of NaCl in the atmosphere and absorbed by the leaves which is responsible for the amount of the salt found in them.

The NaCl from the sea may (i), according to Ackroyd (6), be carried considerable distances inland either as salt spray from the sea which is carried to the land to distances varying with the force of the wind; or (ii) the salt may be dried by evaporation and then carried further inland with the dust; or (iii) the salt may be dissolved in the rain. Ackroyd (7) also mentions that during the great storm of 1839 which 'visited Liverpool and various parts of the kingdom, on January 6th and 7th, the trees and hedges in many places—e. g. Huddersfield and Longton—appeared to be covered with a white frost which, on analysis, proved to be a briny deposit which the wind had brought from the Irish Sea'.

Lesage (4) found that sodium chloride penetrates the plant tissues of *Lepidium sativum* and *Raphanus sativus* in large quantities.

Lewis (5) showed that if the leaves of *Camellia japonica*, *Ilex Aquifolium*, *Syringa vulgaris*, *Cavendishia acuminata*, and *Arum maculatum* are immersed in 3.0420 per cent. NaCl solution and in sea-water they absorb NaCl. In the case of

*Syringa vulgaris* after twelve hours' immersion the weight increased 4.4 per cent., whilst the NaCl content increased 3.6 per cent. In *Arum maculatum* the weight decreased 2.09 per cent., while the NaCl content increased 5.75 per cent. The cells were not killed by this treatment.

*Acer Pseudo-platanus*. When grown six miles from the sea, on land which sloped very gradually seawards, the leaf-ash contained 0.32 per cent. NaCl. The plant in this situation was exposed to all the winds from the west, i. e. from the sea. In analysis VIII the leaf-ash contained 0.37 per cent. NaCl, i. e. only 0.05 per cent. more than in the former case, and this ash was obtained from a plant grown 440 yards from the sea but sheltered by buildings from all sea winds. In analysis VII, the leaf-ash contained 0.43 per cent. NaCl, and in this instance the leaves were procured from a tree growing one mile from the sea, the land between being level. Analyses IX and X show that the ash of the leaves obtained from two plants of the same species, both grown 400 yards from high-water mark, contain respectively 0.57 per cent. and 0.66 per cent. NaCl, the former having been got from a plant slightly sheltered by sandhills from the sea winds, while in the latter case the plant was fully exposed. The leaves in all these cases were gathered during the end of the month of June, 1912, and the durations of the different winds during that month were as follows:

North	= 49 hours	South	= 97 hours
North-east	= 33 "	South-west	= 98 "
East	= 73 "	West	= 197 "
South-east	= 90 "	North-west	= 83 "

(From the Records of the Southport Observatory.)

*Ulmus campestris* demonstrates even better the fact that the leaves obtain their supply of sodium chloride from the atmosphere. The table shows that the amount of NaCl found in the leaf-ash varies from 0.37 per cent. to 1.74 per cent. when procured from trees grown six miles inland and 400 yards from the high-water mark. In analysis II the ash was obtained from a plant growing one mile from the sea, the land between being level; it contained 0.71 per cent. NaCl—twice as much as in analysis I; but in analysis IV the ash was obtained from a plant growing two miles inland, and in this case it contained 1.02 per cent. NaCl. This excess is explained by the fact that the plant grew on the west side of Bidston Hill, Cheshire, and was exposed to much wind. The ash from the leaves of the same species grown 440 yards from the sea but sheltered from sea winds contained only 0.50 per cent. NaCl. The leaves in all these cases were gathered during the end of June, 1912, and the total durations of the different winds were the same as described under *Acer Pseudo-platanus* except in the case of the Bidston Hill plants, which were examined in May—analysis IV. In the last case the number of hours that the wind blew from each compass point was:

North	30	South	91
North-east	18	South-west	133
East	39	West	217
South-east	125	North-west	67

(From the Records of the Bidston Observatory.)

*Ilex Aquifolium*. Owing to the small quantity of NaCl present in the leaf-ash this plant is not so suitable for experimentation; the variations are, however, recorded in analyses XI, XII, and XIII. When the leaf-ash was obtained from a plant growing six miles from the sea it contained 0.02 per cent. NaCl. The ash was procured from other plants growing one mile from the sea, in one case (XII) slightly sheltered from the sea winds, in the other (XIII) exposed. The ash of the former contained 0.05 per cent. NaCl and of the latter 0.07 per cent. NaCl.

These facts are evidence in support of the view that it is from the sodium chloride in the atmosphere that the leaves of such plants receive their supply of sodium chloride.

TABLE.

Plant.	Distance from the sea.	Aspect.	% of NaCl in dry wt.	
			Soil.	Leaf.
I. <i>Ulmus campestris</i>	6 miles	Land sloping towards the sea	0.01	0.37
II. " "	1 mile	Slightly sheltered from the sea	0.01	0.71
III. " "	440 yds.	Sheltered from the sea	0.03	0.50
IV. " "	2 miles	Much exposed	—	1.02
V. " "	400 yds.	Exposed	—	1.74
VI. <i>Acer Pseudo-platanus</i>	6 miles	Land sloping towards the sea	0.01	0.32
VII. " "	1 mile	Slightly sheltered	0.03	0.43
VIII. " "	440 yds.	Sheltered from the sea	0.03	0.37
IX. " "	400 yds.	Slightly sheltered	—	0.57
X. " "	400 yds.	Exposed	—	0.66
XI. <i>Ilex Aquifolium</i>	1 mile	Slightly sheltered	—	0.05
XII. " "	1 mile	Exposed	—	0.07
XIII. " "	6 miles	Land sloping towards the sea	—	0.02

## LITERATURE.

1. CZAPEK: Biochemie der Pflanzen, vol. ii, 1905, p. 810.
2. KERNER VON MARILAUN, A. ('87-'91): The Natural History of Plants. Engl. Ed.
3. WARMING, E. ('09): Oecology of Plants. Engl. Ed.
4. LESAGE, P.: Le Chlorure de sodium dans les plantes. Comptes rendus, tome cxiv, p. 143.
5. LEWIS, F. J.: On Induced Variations in the Osmotic Pressure and Sodium Chloride Content of the Leaves of Non-halophytes. New Phytologist, vol. xi, p. 256.
6. ACKROYD, W.: On the Circulation of Salt and its Bearing on Chemico-geological Problems, more particularly that of the Geological Age of the Earth. Chem. News, vol. lxxxiii, 1901, p. 265.
7. ———: On the Circulation of Salt and its Bearing on Chemico-geological Problems. Chem. News, vol. lxxxiv, 1901, p. 56.

L. MARGARET BLACKLEDGE.

HARTLEY BOTANICAL LABORATORIES,  
UNIVERSITY OF LIVERPOOL.  
November, 1912.

**NOTE ON A NEW TREATMENT FOR SILVER-LEAF DISEASE IN FRUIT TREES.**—The well-known phenomenon of ‘auto-digestion’ shown by the fruit bodies of most species of *Coprinus* forms the theoretical basis for the treatment to be described. From the specific nature of enzyme action it is to be expected that a parasitic fungus has evolved tissues which are not destroyed by the enzymes used to dissolve the tissues of its host, and conversely that an enzyme which destroys the fungal mycelium will leave the host untouched. It seems probable, from the researches of Buller<sup>1</sup> and others, that a very powerful enzyme, capable of destroying the fungal mycelium, exists in the fruit bodies of *Coprinus*. The work which has been begun on Silver-leaf Disease is an attempt to use this enzyme as a curative agent. The disease is particularly well adapted to test the treatment because of the marked silvered appearance of the leaves of affected parts; and also because the symptoms appear in the living branches before their invasion by the fungal mycelium, and so they can be fortified from attack before the tissues have become disorganized. This disease is supposed by most observers<sup>2</sup> to be due to *Stereum purpureum*, the mycelium of which is found in the dead branches of diseased trees, and which will reproduce the disease in healthy trees. The actual silvering of the leaves has been shown by Percival to be due to air cavities in certain of the walls of the epidermal cells, and may be due to the action of an enzyme secreted by the fungus; but the fungal mycelium does not appear in the living tissues until a short time before death takes place.

The treatment consists in hypodermic injections of a concentrated water extract from the ‘diliquescing’ fruit bodies of various species of *Coprinus*. Besides the injections, there is external application of the same extract, after the manner of a poultice, at the points of the dead wood where fruit bodies of *Stereum* make their appearance. The effect of the treatment is fairly well marked. A ‘poultice’ causes the fungal fruit body to become greyish in colour and to peel off by degrees on to the soaked fabric of the ‘poultice’. One Victoria Plum tree, which has been treated with injections for two years, showed no silvering on the leaves of the upper parts of the branch in the autumn of 1912. When treatment was commenced, this branch, the last survivor of the five main branches of the tree, was badly affected throughout: it has now borne fruit in the two successive seasons, after a sterility of three years’ standing, and has produced remarkably vigorous new growth. The lower parts of the branch, near the infected dead wood, still showed slight silvering on the leaves last autumn.

As the results so far seem encouraging, it is proposed to continue the experiments on a larger scale, to extend the treatment to other fungal diseases of plants and animals, and to investigate in the laboratory the precise nature of the enzyme in *Coprinus* and its effects.

SARAH M. BAKER.

UNIVERSITY COLLEGE, LONDON.

<sup>1</sup> Buller: Researches on Fungi, London, 1909, chap. xix.

<sup>2</sup> Percival: Journ. Linn. Soc., Bot., 1902, vol. xxxv. Spencer Pickering: Report of the Woburn Experimental Fruit Farm. F. T. Brookes: Brit. Assoc. Reports, 1910, p. 776.

# FLORAL MECHANISM

By A. H. CHURCH, M.A., D.Sc.

LECTURER IN BOTANY IN THE UNIVERSITY OF OXFORD

The following statement has been drawn up by  
Professor Sydney H. Vines

THE object of this work is to provide the botanical student with a complete description of the development, morphology and mechanism of the principal types of flowers. Whilst giving the kind of information that is to be found in Payer's *Organogénie de la Fleur*, and in the late Professor Eichler's well-known *Blüthendiagramme*, it supplements this with an account of the ecology of the flower, including pollination and the formation of fruit and seed. Hence, when complete, it will be the most comprehensive treatise on the flower that has yet been published.

The general plan of the work may be gathered from Part I, which was published in 1908 as a royal 4to volume of 211 pages. In it are described the following twelve types of floral structure, selected from familiar garden flowers that bloom in the early part of the year (January–April):—

<i>Helleborus niger</i> . . .	Christmas Rose.	<i>Viola odorata</i> . . . . .	Sweet Violet.
<i>Galanthus nivalis</i> . . .	Snowdrop.	<i>Narcissus Pseudo-Narcissus</i>	Daffodil.
<i>Jasminum nudiflorum</i>	White Jasmine.	<i>Erica carnea</i> . . . . .	Heath.
<i>Crocus vernus</i> . . .	Blue Crocus.	<i>Ribes sanguineum</i> . . . . .	Flowering Currant
<i>Richardia africana</i> . .	White Arum Lily.	<i>Cydonia japonica</i> . . . . .	Scarlet Cydonia.
<i>Daphne Mezereum</i> . .	Mezereon.	<i>Vinca major</i> . . . . .	Greater Periwinkle.

In connexion with each type, two or three allied species are described for purposes of comparison.

The description of each type is illustrated by a full-page coloured plate, giving an accurate longitudinal section of the flower, and by a black-and-white plate giving the inflorescence, the floral diagram, and other structural details. As each subsidiary species has also a coloured plate allotted to it, the volume contains no less than forty coloured and fourteen uncoloured plates, in addition to a large number of figures, chiefly developmental, included in the text. It can be obtained at the original price of £1 1s. net by subscribers to Part II.

It was hoped that the reception of so striking a volume as Part I would have been such as to justify the Delegates of the Press in proceeding forthwith to publish Part II, the material for which is in readiness. Inasmuch as this anticipation has unfortunately not been realized so far, the Delegates are not disposed to undertake the publication of Part II without some assurance that the necessarily large expenditure involved will meet with the general support of those who, in one way or another, are interested in flowers. But the University Press has received such warm commendations of the work from Botanists who desire to push on the study of Botany in the English-speaking countries that they desire, if possible, to continue publication. They propose, therefore, to ask for subscriptions for copies of Part II at One Guinea each, on the understanding that Part II will, like Part I, consist of descriptions of twelve types of flowers, with allied forms, and be similarly illustrated, though it may be found necessary to reduce somewhat the number of coloured plates. Any copies not subscribed for will not be sold at less than thirty shillings each.

*Science Progress*:—‘Without doubt one of the most interesting botanical books of recent years, and one which in its turn should become a classic.’

*Journal of Botany*:—‘In noticing this very beautiful and elaborate work, one remark seems obvious—there is nothing else like it.’

*Nature*:—‘A valuable contribution to botanical literature, excellent alike in the text and in the illustrations, and the execution is worthy of the Clarendon Press. . . . No botanical school can afford to neglect so valuable and suggestive a storehouse of information.’

Order Forms may be had on application.

# Oxford University Press.

## Knuth's Handbook of Floral Pollination.

Based upon Hermann Müller's work, 'The Fertilization of Flowers by Insects,' translated by J. R. AINSWORTH DAVIS. Vol. I, morocco back, 21s. net; cloth, 18s. net. Vol. II, morocco back, £1 15s. net; cloth, £1 11s. 6d. net. Vol. III, morocco back, £1 11s. 6d. net; cloth, £1 8s. net.

## A History of Botany, 1860-1900.

Being a continuation of Sachs' History of Botany, 1530-1860. By J. REYNOLDS GREEN. Cr. 8vo, 9s. 6d. net.

## Warming's Oecology of Plants.

An Introduction to the study of Plant-Communities. Prepared for publication in English by PERCY GROOM and I. BAYLEY BALFOUR. Morocco back, 12s. net; cloth, 10s. 6d. net.

## Schimper's Geography of Plants.

Authorized English translation by W. R. FISHER, revised by P. GROOM and I. BAYLEY BALFOUR. With maps, collotypes, portrait, and 407 other illustrations. Morocco back, £2 2s. net.

## Jost's Lectures on Plant Physiology.

Authorized English translation by R. J. HARVEY GIBSON. Morocco back, £1 4s. net; cloth, £1 1s. net.

## Pfeffer's Physiology of Plants.

A treatise upon the Metabolism and Sources of Energy in Plants. Second fully revised Edition, translated and edited by A. J. EWART. Vol. I, morocco back, £1 6s. net; cloth, £1 3s. net. Vol. II, morocco back, 16s. net; cloth, 14s. net. Vol. III, completing the work, morocco back, £1 1s. net; cloth, 18s. net.

## Goebel's Organography of Plants.

Authorized English Edition by I. BAYLEY BALFOUR. PART I, General. Morocco back, 12s. net; cloth, 10s. net. PART II, Special. Morocco back, £1 4s. net; cloth, £1 1s. net.

## Solereider's Anatomy of the Dicotyledons.

Translated by L. A. BOODLE and F. E. FRITSCH. Revised by D. H. SCOTT. Two volumes, morocco back, £1 7s. 6d. net each; cloth, £1 4s. net each.

## On the Physics and Physiology of Protoplasmic Streaming in Plants.

By A. J. EWART. With 17 illustrations. 8s. 6d. net.

## List of British Plants.

By G. C. DRUCE. Crown 8vo, paper covers, 2s. 6d. net; cloth interleaved, 3s. 6d. net.

## Floral Mechanism.

Diagrams and Descriptions of Common Flowers, arranged as an introduction to the systematic study of Angiosperms. By A. H. CHURCH. Royal 4to. Part I, Types I-XII (Jan. to April). With coloured plates and numerous other figures. 21s. net.

## Forestry for Woodmen.

By C. O. HANSON. Crown 8vo, with 15 illustrations and 12 plates. 5s. net.

## Vocabulaire Forestier. Français-Allemand-Anglais.

Par J. GERSCHEL. Revu par W. R. FISHER. Fcap. 8vo. 5s. net.

LONDON: HENRY FROWDE

OXFORD UNIVERSITY PRESS, AMEN CORNER, E.C.

Vol. XXVII. No. CVI. April, 1913. Price 14s.

# ANNALS OF BOTANY

EDITED BY

DUKINFIELD HENRY SCOTT, M.A., LL.D., D.Sc., FOR. SEC. R.S.

LATELY HONORARY KEEPER OF THE JODRELL LABORATORY, ROYAL BOTANIC GARDENS, KEW

JOHN BRET LAND FARMER, D.Sc., M.A., F.R.S.

PROFESSOR OF BOTANY, ROYAL COLLEGE OF SCIENCE, LONDON

FRANCIS WALL OLIVER, M.A., D.Sc., F.R.S.

QUAIN PROFESSOR OF BOTANY, UNIVERSITY COLLEGE, LONDON

AND

ROLAND THAXTER, M.A., Ph.D.

PROFESSOR OF CRYPTO GAMIC BOTANY IN HARVARD UNIVERSITY, CAMBRIDGE, MASS., U.S.A.

*ASSISTED BY OTHER BOTANISTS*



LONDON

HUMPHREY MILFORD, OXFORD UNIVERSITY PRESS

AMEN CORNER, E.C.

EDINBURGH, GLASGOW, NEW YORK, TORONTO, MELBOURNE, AND BOMBAY

1913

# CONTENTS.

	PAGE
WAGER, HAROLD.—The Life-history and Cytology of Polyphagus Euglenae. With Plates XVI–XIX . . . . .	173
LANG, WILLIAM H.—Studies in the Morphology and Anatomy of the Ophioglossaceae. I. On the branching of Botrychium Lunaria, with notes on the anatomy of young and old rhizomes. With Plates XX and XXI and fourteen Figures in the Text . . . . .	203
HOLDEN, RUTH.—Some Fossil Plants from Eastern Canada. With Plates XXII and XXIII . . . . .	243
HILL, T. G., and DE FRAINE, E.—A Consideration of the Facts relating to the Structure of Seedlings. With a Curve, two Diagrams, and one Figure in the Text . . . . .	257
SALISBURY, E. J.—Methods of Palaeobotanical Reconstruction. With one Figure in the Text . . . . .	273
KISCH, MABEL H.—The Physiological Anatomy of the Periderm of Fossil Lycopodiales. With Plate XXIV and twenty-seven Figures in the Text . . . . .	281
SAXTON, W. T.—Contributions to the Life-history of Actinostrobilus pyramidalis, Miq. With Plates XXV–XXVIII and three Figures in the Text . . . . .	321
TAKEDA, H.—Some Points in the Anatomy of the Leaf of Welwitschia mirabilis. With Plate XXIX and five Figures in the Text . . . . .	347
TAKEDA, H.—A Theory of 'Transfusion-tissue' . . . . .	359
 NOTES.	
TAKEDA, H.—Development of the Stoma in Gnetum Gneumon. With ten Figures in the Text . . . . .	365
DELFT, E. M.—Note on an Attached Species of Spirogyra. With two Figures in the Text . . . . .	366
HOLDEN, H. S.—On the Occlusion of the Stomata in Tradescantia pulchella. With a Figure in the Text . . . . .	369

## NOTICE TO SUBSCRIBERS.

The subscription-price of each volume is thirty shillings, payable in advance: the Parts, four in number, are supplied as they appear, post free to subscribers in the United Kingdom, and with a charge of 1s. 6d. per annum for postage to subscribers residing abroad. The price of individual Parts is fixed at a higher rate. Intending subscribers should send their names, with subscription, to HUMPHREY MILFORD, Oxford University Press, Amen Corner, London, E.C.

As the earlier volumes of the Annals of Botany are becoming scarce, Vol. I will only be sold as part of a complete set; and Parts will not as a rule be sold separately, after the publication of the volume to which they belong. A few extra copies of particular Parts at present remain on hand, for which special application must be made to the Editors, Clarendon Press, Oxford.

## NOTICE TO CONTRIBUTORS.

Contributors in America should address their communications to Professor THAXTER, Harvard University; and all other contributors to the Editors, at the Clarendon Press, Oxford.

Papers sent in with a view to publication *must be type-written* and *must conclude with a summary of the contents*. The illustrative figures should be planned so as to fill properly a 4to or an 8vo plate. The maximum space available for figures in a 4to plate is  $8\frac{1}{4} \times 11\frac{1}{4}$  inches, in an 8vo plate  $8\frac{1}{4} \times 5\frac{1}{4}$  inches. Attention to this will conduce to the rapid publication of papers if accepted.

Each contributor to the Annals of Botany is entitled to receive gratis one hundred separate copies of his paper, and may purchase additional copies if he informs the Editors of his wishes in this respect when he returns corrected proofs. The price of these additional copies will depend upon the amount of text and the number of plates in the paper.



# The Life-history and Cytology of Polyphagus Euglenae.

BY

HAROLD WAGER, F.R.S.

With Plates XVI-XIX.

## INTRODUCTION.

OUR knowledge of this very interesting member of the Chytridiaceae is due to the investigations of Gros ('51), Siebold and Meissner ('55), Bail ('55), A. Braun ('55, '56), A. Schenk ('57), and especially Nowakowski ('76), who has given the most complete account of its general structure and life-history as observed in living specimens.

Nowakowski mentions ('76) that it was first of all described by A. Braun and Bail as *Chytridium Euglenae*. Subsequently Schenk, regarding the organism as two-celled, separated it from *Chytridium* and placed it in *Rhizidium*, but Nowakowski found that it differed in so many particulars from the genera *Chytridium* and *Rhizidium* that he felt himself justified in placing it in a new genus under the name *Polyphagus*.

The cytology of *Polyphagus* has received little attention. In 1898 I gave a brief account of the structure of the nuclei and of their behaviour during the formation of the zygote, and made further references to it in papers subsequently published ('99 and '05). Dangeard ('00) in a longer memoir confirmed in general my results, and gave some additional details concerning the structure of the zygote and of the asexual sporangium and spores. During the last few years the cytology of various other members of the group has received attention, and the results obtained indicate that a careful study of the Chytridiaceae may give some clue to many interesting problems connected with sexuality and the function of the nuclei in fertilization, and may also throw some light upon the phylogeny of the Fungi.

According to Schroeter ('92, '93), the Chytridiaceae are divided into two very distinctly marked groups. In one, the resting spores are produced asexually, seldom by copulation of swarm spores; in the other, the resting spores are produced by the union of two vegetative cells.

The majority of the genera and species of the Chytridiaceae belong to the first group. In the second group there are only four genera, three of them, *Diplophysa*, *Polyphagus*, and *Urophlyctis* being placed in the sub-family Oochytriae, and a single genus, *Zygochytrium*, in the sub-family Zygochytriae.

The three genera of the Oochytriae resemble in their vegetative characteristics certain members of the first group, and are in fact only distinguished from them by their sexual reproduction. There seems to be no good reason, therefore, why the Oochytriae should be maintained as a separate sub-family, as the genera included in it might very properly be included in the other sub-families. Thus *Diplophysa* (*Olpidiopsis*) would be placed in the Olpidiae, and *Urophlyctis* in the Cladochytriae. *Polyphagus* may perhaps be regarded as intermediate between *Chytridium* and *Rhizidium*, the two genera of the Rhizidiae. *Zygorhizidium Willei*, described by Loewenthal, would be included in the Rhizideae. This rearrangement of the genera would simplify the classification of the Chytridiaceae, and the following key, showing how the various sub-families would then be differentiated, may be useful.

#### KEY TO THE SUB-FAMILIES OF THE CHYTRIDIACEAE.

- |  |                |
|--|----------------|
| 1. Resting spores produced asexually, rarely by the copulation of swarm spores . . . . .         | 2              |
| 1. Sexual spores formed by conjugation, as in Mucorineae . . . . .                               | Zygochytriae.  |
| 2. Mycelium absent . . . . .   | 3              |
| 2. Mycelium present . . . . .  | 4              |
| 3. Sporangia always single and formed out of the whole mass of the thallus . . . . .             | Olpidiae.      |
| 3. Sporangia in groups or sori . . . . .   | Synchytriae.   |
| 4. Mycelium in the form of delicate transient strands . . . . .                                  | 5              |
| 4. Mycelium hypha-like, permanent . . . . .  | Hypochytriae.  |
| 5. Mycelium giving rise to one terminal sporangium only, never intercalary . . . . .             | Rhizidiae.     |
| 5. Mycelium spreading, often through several cells; sporangia terminal and intercalary . . . . . | Cladochytriae. |

#### OCCURRENCE AND HABIT.

*Polyphagus Euglenae* appeared in abundance in the spring of 1898 on cultures of *Euglenae* obtained from the Sewage Farm at Keighley in Yorkshire. The *Euglenae* from which the cultures were made formed a bright green scum on the surface of the drying-up mud or sediment left on the filter beds. The cells were found to be in a resting and slightly

encysted condition, but on placing them in a saucer of tap-water they soon became motile, and remained in this condition for several days. They then passed into a resting stage again, becoming rounded off and surrounded by a thin membrane, and formed a scum at the surface of the water. The Fungus then appeared and developed very rapidly.

Massee ('91) says that it is rare, but it has frequently appeared in my cultures of *Euglena* from various sources, and I suspect that it is to be found very commonly in cultures of *Euglena* from sewage filter beds. It does not appear so readily on cultures of *Euglena* obtained from farm-yards, but if, as suggested by Kwakine ('86), the cultures are started in a dilute solution of albumen in water, the parasite usually makes its appearance. Its presence is indicated by a greyish appearance of the green scum, and, when it occurs in quantity, by a peculiar roughness on its surface which is very characteristic, and quite different from that brought about by other parasites, of which a considerable number, including many of the Chytridiaceae, occur frequently on *Euglena*.

The parasite spreads very rapidly. A single cell, with its numerous branching pseudopodia or haustoria, may attack a very large number of individual *Euglenae*, frequently from thirty to fifty, or possibly even more, and in the early stages of development large sporangia with enormous numbers of zoospores are produced, by means of which the infected area is rapidly extended in all directions. In the course of about six days the colour of the culture changes from greyish green to yellow, and finally, when the *Euglenae* have been completely or almost completely destroyed by it, the culture becomes dark brown. At this stage the formation of zoosporangia has ceased and large numbers of zygotes in various stages of development will be found.

#### EFFECT ON EUGLENA.

The *Euglenae* are only attacked by the parasite when they are in a rounded-off and encysted state. So long as they are motile, the haustoria are unable to obtain an entry.

The haustorium quickly penetrates the *Euglena* cell by perforating the cell-wall. It then branches in all directions and soon brings about a complete disintegration of the cell contents. The first effect visible in the cell is that the chlorophyll bodies turn yellow or yellowish green. They then gradually disappear and in their place are found rusty red granules or masses of granules. The protoplasm at the same time becomes absorbed. Then the paramylum grains become broken up and the granules of the eyespot separate from one another. The nucleus and the cell membrane at this stage are still to be seen, but the nucleus is gradually absorbed, and after a long time (several days) the cell-wall also disappears, and the rusty red granules become disseminated in the surrounding liquid.

## STRUCTURE OF THE THALLUS.

The thallus is unicellular and uninucleate. The cells vary much in form and size, sometimes smaller, but frequently larger than the cells of *Euglena*. In form they vary from a nearly spherical to an elongate shape and are commonly very irregular in outline (Pl. XVI, Figs. 1-5 and Pl. XVIII, Figs. 49-55).

The pseudopodia or haustoria which radiate from the cell in all directions are prolongations of the cell-body and continuous with it. The delicate membrane around them is difficult to observe, but in the later stages of development it becomes impregnated by some substance which takes up stain, and is then easily seen on staining with fuchsin. Both Bail ('55) and Nowakowski ('76) call attention to the resemblance of these haustoria to the pseudopodia of certain Rhizopoda. This is certainly very striking, especially in the earlier stages of development; the young spherical cells, with their delicate haustoria radiating on all sides, look exactly like some forms of the Heliozoa (Figs. 50-55).

The protoplasm of the cell is dense and granular, and contains numerous oil-drops. The pseudopodia show finely granular contents with minute oil-drops. The oil is coloured light brown in osmic acid.

The nucleus stains very easily in any of the ordinary nuclear stains. Cover-glass preparations can be made by lowering a cover-glass gently upon the scum at the surface of the water. The scum sticks to the cover-glass sufficiently firmly to allow the operation of fixing, staining, and mounting to be carried out without any danger of its being washed off. Or, a small piece of the surface scum of *Euglenae* is cut off and floated on to a microscopic slide. This is allowed to dry round the edges to attach it firmly to the slide, and is then fixed, stained, and mounted. For the details of cytological structure, microtome sections from material embedded in paraffin in the usual way are desirable.

The structure of the resting nucleus differs somewhat from the normal structure in the higher plants. We find a slightly stainable substance in the form of a more or less spherical mass in the centre of the nucleus, but connected to the nuclear membrane by delicate radiating threads (Figs. 57-62). On one side of this is an arc-shaped cap of chromatin which sometimes appears homogeneous, sometimes vacuolar, and sometimes granular (Figs. 1-5 and 57-62). The slightly stainable mass in the centre looks as if it were a much condensed fine network. All the chromatin of the nucleus is contained in the arc-shaped mass. Somewhat similar nuclei have been described by Percival ('09) in *Synchytrium endobioticum*. Sometimes this arc-shaped mass is found in close contact with the periphery of the nucleus as shown in Fig. 3, and on passing into the sporangium it becomes flattened against it (Fig. 28). In the course of the nuclear divisions which take

place in the zoosporangium, a large part of this chromatin mass becomes extruded into the cytoplasm (Fig. 30), a small portion only being retained for the formation of the chromosomes.

The nucleus is surrounded by a dense granular mass which stains deeply in nuclear stains (Figs. 1-5, 54-58). The structure of this mass is interesting. It consists of a cytoplasmic network, the meshes of which enclose spherical globules of oil (Figs. 55, 57), the knots of the network consisting of deeply stainable irregular granules, which give the characteristic reaction of chromatin, in that they are deeply stainable in nuclear stains, and give a distinct reaction for organically combined phosphorus. It is possible that this chromatin-like substance is concerned in the production of the oil. It appears first in the young zoospore at a late stage in its formation in the zoosporangium, as a dense stainable mass around the nucleus (Figs. 46, 47). It seems to be due to an aggregation of minute stainable granules from the cytoplasm, but may also be partly derived from the nucleus. Chromatin-like substance is constantly extruded from the nuclei at various stages in their development, and notably in the sporangia and zygotes. As soon as the zoospore comes to rest and begins to germinate, this dense mass becomes gradually filled with globules of oil or fatty substance, and is thus transformed into a deeply stainable sponge-like granular mass (Figs. 54, 55). During the formation of the zoosporangium this deeply stainable mass, together with the oil, passes into it and becomes broken up and dissipated in the cytoplasm in the form of minute granules.

#### ZOOSPORES.

The structure of the zoospore is very simple. At the anterior end, immediately below the single cilium, is a yellow or orange-coloured oil-drop, and below this the colourless protoplasm with a nucleus (Figs. 21, 48). The protoplasm at the posterior end of the spore is granular, and forms a slightly flattened mass which is very conspicuous (Fig. 21). Nowakowski regards the oil-drop as a nucleus; Zopf takes a similar view, but states that the nucleus owes its strong refractive power to the fact that it contains oil. From observations which I have made on stained specimens at various stages in their development, the oil-drop is found to be in close contact with the nucleus but not inside it (Fig. 48). The zoospores vary very much in size. Nowakowski gives their measurements as  $6 \times 3 \mu$  to  $13 \times 5 \mu$ , and I have found them varying from  $5 \times 3 \mu$  to  $12 \times 6 \mu$ . Even in the same sporangium considerable variation may be found, especially in the sexual sporangia.

The zoospores of *Polyphagus* are phototactic, and they are thus enabled to make their way to those regions where the host-cells, which are also phototactic, may have accumulated. The mechanism by which the direction of locomotion is effected by the light is not apparent, but it is significant, as I have previously pointed out ('99), that the orange-coloured oil-drop is

always placed at the end of the zoospore immediately beneath the point of attachment of the cilium and in close contact with the nucleus. It is possible that the light rays absorbed by the oil-drop may be capable of setting up changes in its immediate neighbourhood, possibly through the nucleus, which are capable of reacting upon the cilium in such a way as to exercise a directive influence on its movements.

Immediately the zoospores come to rest they round themselves off and begin to germinate. They increase slightly in size, and pseudopodia appear about  $1\frac{1}{2}$  to 2 hours after they come to rest. The pseudopodia increase in length so rapidly that 3 hours after they begin to form many of them are five or six times the diameter of the cell. The germination follows the same course whether the zoospores are derived from asexual or from sexual sporangia. Figs. 49–53 show the early germination stages of a zoospore.

Stained specimens show that the nucleus and oil globule are in close contact with one another and are surrounded by a deeply stainable chromidial mass (Fig. 48), the peripheral layer of cytoplasm being stained only very slightly. This chromidial mass thins out as it reaches the anterior end of the oil globule, and appears to be continuous with the cilium just at the point where it is given off from the zoospore. In the early stages of the growth of the young thallus, the chromidial mass persists around the nucleus and appears to be directly connected with the pseudopodia (Fig. 54). As development proceeds, the thallus assumes an irregular outline and the chromidial mass becomes alveolate owing to the appearance of globules of oil (Fig. 55).

#### REPRODUCTION.

The organism reproduces itself sexually and asexually. So long as there is a fair amount of nutriment in the shape of unattached *Euglena* asexual reproduction prevails, but as soon as the nutriment fails, and this happens very soon in an ordinary culture, the sexual organs begin to form. In both methods of reproduction sporangia are formed. In the asexual method the sporangia are produced directly, as outgrowths of the vegetative cells. In the sexual method of reproduction two vegetative cells unite to form a zygote, which subsequently on germination produces a zoosporangium similar in appearance but usually smaller than that formed asexually.

The asexual sporangium first appears as a small spherical outgrowth on the vegetative cell. This gradually increases in size, and the protoplasm and oil-drops pass into it until nothing is left in the parent cell but a few delicate strands of protoplasm and one or two small oil-drops. From a series of observations made on two different sporangia, the rate of growth in length during the earlier stages appears to be about  $.005$  mm. per hour, but in the later stages it varies very considerably, being often very much

more. When all the protoplasm and oil-drops have passed into the sporangium it is cut off from the parent cell by a transverse partition which begins to form at the periphery and gradually extends all across between the cells.

In the germination of the zygote, the outer spiny wall bursts and a spherical protrusion of the inner membrane projects through it and develops in the same way as just described for the asexual sporangia. The protoplasmic contents of the zygote pass into this completely, and the sporangium is then cut off by a transverse wall. During all the subsequent stages of its development it remains attached to the empty zygote, just as the asexual sporangium remains attached to the empty vegetative cell.

The changes which take place in the contents of a sporangium leading to the formation of the zoospores were followed out in several instances by continuous observation under the microscope, both in the asexual and in the sexual sporangia. These are the same in all essential details in both cases, and as Nowakowski has given an account, although not a very complete one, of the formation of zoospores in the asexual sporangia, I will confine myself mainly to a description of the changes which take place in the sexual sporangium (see p. 186).

#### CYSTS.

These are spherical cells, resembling the smooth-walled zygotes in appearance, containing each a single nucleus. They differ from the zygotes, however, in the presence of well-developed absorbing filaments and in the simpler structure of their membrane. In agreement with Dangeard ('00), I find that the cysts are simply ordinary vegetative cells which become surrounded by a thick membrane and enter on a resting stage.

The formation of cysts takes place very readily when the parasite is abundant and the supply of *Euglenae* limited. The cysts are then developed in large numbers and often crowded together. Each cyst contains a single nucleus surrounded by chromidia. The cysts germinate easily when placed in fresh cultures of *Euglenae*, and produce zoosporangia similar to those produced by the ordinary vegetative cells, but usually much smaller.

#### FORMATION OF ZYGOTES.

The zygote is formed by the fusion of two ordinary vegetative cells, which, instead of producing zoosporangia, become transformed into gametes. The gametes are usually different in size, the smaller one functioning as the male, the larger one as the female (Figs. 1-5). Nowakowski observed ('76) two different methods of zygote formation, resulting in the one case in the production of a smooth-walled zygote, and in the other of a zygote with

a spiny wall. Both may be found in the same culture, but the spiny form seems to be the normal one, and is produced under the more favourable conditions of food supply in the early stages of a culture, the smooth form being produced, sometimes in great abundance, during the later, less favourable conditions. In both cases the gametes are placed in contact with one another by a delicate pseudopodium-like process, which is put out from the male gamete. These copulating pseudopodia are of varying length, sometimes very short (Fig. 4), at other times extending to a considerable distance before they can reach the female gamete (Fig. 1). Whether there is any definite attraction between the two gametes, or whether it is merely a chance encounter, I have not been able to determine. The copulating pseudopodia do not differ in any respect, except possibly that of extreme length in some cases and absence of branching, from the ordinary haustoria which penetrate the Euglenae.

In the case of the spiny form the zygote is produced by the swelling of the apex of the pseudopodium near its point of contact with the female cell (Figs. 1-5). The smooth-walled zygote is formed, on the other hand, according to Nowakowski ('76), as a globular outgrowth from the female cell just where it comes into contact with the male pseudopodium. I have not been able to observe this second method of zygote formation, although I have seen the production of both spiny and smooth-walled zygotes. So far as my observations go, the zygotes are formed in both cases by a swelling of the apical portion of the male pseudopodium in contact with the female cell. Dangeard also ('00), who has made observations on the formation of the smooth-walled zygotes, describes them as swellings on the pseudopodium of the male cell, and he further remarks: 'We have seen nothing which allows us to postulate with Nowakowski a different manner of formation for these two kinds of zygotes.'

The following observations on the formation and maturation of the zygote refer to the spiny form. Immediately following the appearance of the zygote, the protoplasmic contents of the male cell pass through the delicate pseudopodium into the zygote (Fig. 5). A perforation appears in the wall between the young zygote and the female cell (Figs. 3, 5), and the contents of the latter pass through it into the zygote (Figs. 59, 60).<sup>1</sup>

The zygote is then cut off by partition walls from the remains of the two original gametes. The whole process, from the time of the first appearance of the swelling on the pseudopodium to the complete separation of the zygote, takes about twelve hours or less. The contents of both gametes include a large number of oil-drops, and in some cases the nuclei of the living cells can be clearly made out.

<sup>1</sup> In all the cases which I have observed, the male nucleus first of all passes into the zygote, then the female nucleus, but Dangeard ('00), in describing the formation of the smooth-walled zygotes, states that the female nucleus ordinarily passes in first, then the male.



The examination of stained specimens shows that the nuclei of the fusing gametes have exactly the same structure as those of the ordinary vegetative cells. The male nucleus is, however, usually smaller than the female, and contains less chromatin.

The passage of the male nucleus through the pseudopodium is of considerable interest, but the mechanism by which it is brought about is obscure. The delicate pseudopodium is much smaller in the diameter of its lumen than the nucleus, and must therefore offer a certain resistance to its passage. The force which drives the nucleus along may possibly be derived from a combination of the turgescence of the male cell with the vacuum caused by the increasing expansion of the young zygote at the end of the pseudopodium, or it may be that some attraction is exerted by the female cell upon the protoplasm of the male cell. The delicate wall of the pseudopodium is probably very elastic, and although I have never seen a nucleus during its passage through the pseudopodium, it is clear that the wall expands sufficiently to allow the nucleus to pass through it readily. There is no evidence that the nucleus has any motive power of its own to enable it to force its way along the pseudopodium, and it does not seem likely that the delicate wall of the pseudopodium is capable of a rhythmical expansion and contraction sufficient to bring it about.

In the zygote the two sexual nuclei come into contact with each other (Fig. 61). Then the smaller male nucleus begins to increase in size, probably at the expense of food material in the zygote, and this continues until it is almost exactly similar in size to the female nucleus. The two nuclei then move apart to opposite sides of the cell (Fig. 62).

When the zygote is first formed it frequently contains, scattered through the cytoplasm, a number of deeply stainable granules, which are probably the remains of the dense granular masses derived from the gametes at the time of fusion (Figs. 61, 62). Dangeard ('00) has noticed these and called them coenospheres. As the zygote develops they gradually disappear, and at the same time the oily contents of the cytoplasm increase in quantity to form a supply of reserve food material for use at a later stage.

The two nuclei then undergo considerable changes. Chromatin material in the form of amorphous masses or granules is extruded from them into the cytoplasm, and they become smaller and lose to some extent their capacity for stains (Figs. 63-66). The extruded granules stain very deeply in nuclear stains and give a strong reaction for organically combined phosphorus. They are obviously of the nature of chromidia, similar to those described by Hertwig ('07) and others in the Protozoa. They form conspicuous elements in the zygote at this stage, and become massed together into two more or less distinct groups (Fig. 67), one being produced by each nucleus. Shortly after their appearance they fuse together into a single dense mass in the centre of the zygote (Figs. 68-73). The two

nuclei remain visible through all the subsequent stages of development either at the periphery of the chromidial mass or slightly embedded in it.

The presence of these well-marked chromidia in *Polyphagus* recall so strongly the appearances presented by the cells of many Protozoa that I propose to discuss very briefly the present state of our knowledge of chromidia.

#### CHROMIDIA.

Hertwig ('02) designated as chromidia the discrete chromatin, derived from the nucleus, which is found in the form of granules or more or less branched strands or networks in many Protozoa. They were first recognized in *Actinospherium*, in which they occur abundantly during particular states of metabolism, as in over-feeding or starvation.

The occurrence of diffused chromatin in the cell, and the occasional disappearance of all other traces of nuclei, suggested to Hertwig that in certain organisms the diffused chromatin might entirely replace the true nucleus. This is probably the case in the Bacteria and Cyanophyceae. In these forms the nucleus as a histologically defined organ is wanting, but chromatin in the form of chromidia is diffused through the cytoplasm.

At the present time a good deal of confusion exists as to the precise nature and significance of chromidia. Many authors regard all deeply stainable granules in the cytoplasm, whether derived from nuclei or not, as chromidia, in which case the term has no real significance, and certainly not the significance which, if I understand him correctly, Hertwig meant to convey when he first made use of the term 'chromidien'. The term chromidia should, in my opinion, be strictly reserved for those granules that can be shown to have been derived from nuclei or which take the place of the nucleus. The singular of chromidia is chromidium, which obviously means a single granule, and not the mass of granules to which it has been applied by some observers, in a manner which strikes me as very confusing (cf. Minchin, 1912, p. 65). Minchin suggests the term chromidiosomes for the separate particles which Hertwig called chromidia, but it seems to me that this is unnecessary if we use the original term properly in Hertwig's sense.

So far, it appears that four distinct categories of chromidia can be recognized:

1. Those which definitely represent the nucleus of the cell and are the only nuclear structure present. Such occur in some Bacteria and possibly Cyanophyceae.
2. Those which are formed at certain stages in the life of a cell by the breaking up of a nucleus into granules, which are distributed in the cytoplasm, but which are capable of being re-formed into nuclei. These may be found in some Protozoa.
3. Those which are extruded from the nucleus for the purpose of

metabolism and are finally used up and not reabsorbed into the nucleus or reconstructed into nuclei. They are found in egg-cells of various kinds and probably to some extent in all cells in active growth and division. The chondriosomes and chromatin structures of similar nature derived from nuclei would also be included here.

4. Those which are extruded from the nucleus, or cut off by division for purposes of metabolism and vegetative growth, but which are at once constituted into nucleus-like structures more or less clearly defined in the cytoplasm. The macro-nuclei of Protozoa, the granular structure of *Polyphagus*, and possibly the so-called coenocentra and perhaps pyrenoids are instances.

So far as their functions are concerned, we thus see that we have two main types of chromidia, one possessing a purely vegetative function, and the other a generative or reproductive function. The following table shows the general relationship of the four categories given above :

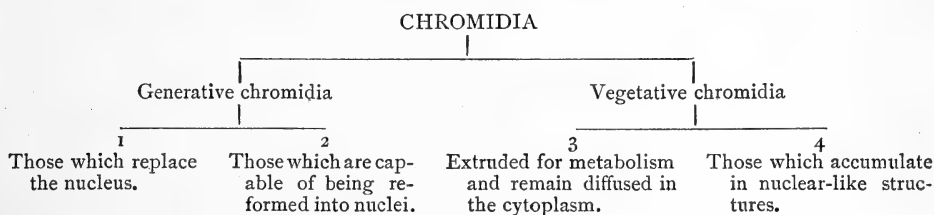

Goldschmidt ('04) proposes the terms chromidia and sporetia for the vegetative and generative chromidia respectively, and Mesnil ('05) suggests trophochromidia and idiochromidia. Minchin (p. 150), however, considers that the term chromidia should be retained 'to denote simply extranuclear particles of chromatin, and to qualify the term by the adjectives vegetative and generative when required'. These terms are sufficiently distinctive, but it must not be forgotten that those chromidia which definitely replace the nucleus, as in Cyanophyceae and Bacteria, have both generative and vegetative functions.

In *Polyphagus*, the granular mass which we regard as chromidial arises from the nucleus, and is definitely extruded for purposes of metabolism. In the zoospores and in the early stages of the development of the thallus this chromidial mass is homogeneous or finely granular (Figs. 48, 54). Later, it exhibits a vacuolated structure, owing to the formation of globules of oily substance in the alveoli (Fig. 55). This fatty substance, which is formed as a reserve food material for use during subsequent growth and development, appears to be produced largely at the expense of the chromidia.

Chromidia are present at all stages in the life-cycle of *Polyphagus*, and are constantly being reinforced, as they are used up, by fresh extrusions from the nuclei at various stages in the nuclear cycle. The granules found

scattered in the cytoplasm of the zygote during the early stages of development, which Dangeard ('00) calls coenospheres, must also be regarded as chromidia, and it is interesting to find that Dangeard considers that they are of a fatty nature. The chromidia of *Polyphagus* are strictly comparable to the granular mass which occurs in the oospores of *Cystopus* and *Peronospora*, the so-called coenocentrum.

The function of the coenocentrum is not clearly understood. When first discovered, I thought its purpose was to act as a kind of attractive centre to bring the two sexual nuclei together in the middle of the zygote. This view has generally been accepted, but from recent investigations I am not satisfied that it is the correct one. It appears to be much more nearly concerned with the vegetative activities of the oospore than with the fusion of the nuclei, and although it may not actually possess the characteristics of a fatty body, as Dangeard suggests ('00), it certainly seems to be the centre of formation of the oily reserves which accumulate in the oospore. The granules of which it is composed are probably extruded from the oogonial nuclei and should therefore, in the present state of our knowledge, be classed as chromidia.

When the chromidia are grouped together into a well-defined mass in the cell, as above described, the term chromidiosphere (or chromidiocentrum) may perhaps be used instead of coenocentrum.

#### CHROMIDIAL FUSION.

Chromidia as definite structural organs in the cell are of frequent occurrence in the Protozoa, and it is interesting to find them so well marked in *Polyphagus* and presenting such close resemblances to the chromidial masses of the Protozoa. Some of the figures of chromidia in *Pelomyxa* given by Bott ('07), for example, resemble to an extraordinary degree those which I have given of *Polyphagus*. The fusion of chromidia in the zygote of *Polyphagus* also resembles in many respects that which takes place in many Protozoa, but it is of a much simpler type. In the Protozoa the fusion of the chromidia, or chromidiogamy, as it is sometimes called, is one of the stages in a complex nuclear cycle during which the original nuclei degenerate and new ones are reconstructed out of the chromidia. In *Diffugia urceolata*, for example, the two sexual cells each with nucleus and chromidia come into contact and the contents of one pass into the other. The chromidia then fuse and the nuclei ultimately degenerate, new nuclei being formed from the chromidial mass. Again, in *Arcella* (see Minchin, p. 148) each of the fusing cells contains a nucleus and chromidia. The contents of one cell pass into the other and the primary nuclei degenerate, then 'break up into a fine dust of chromatin particles and become intimately commingled'. 'When this process is complete, the protoplasm with the chromidia becomes again distributed between the two

cells and the two conjugants separate. Then in each individual secondary nuclei are formed from the chromidia.' Somewhat similar phenomena occur in *Centropyxis aculeata*, according to Schaudinn ('03), where the nuclei degenerate and the sexual nuclei are derived from the chromidia.

In *Pelomyxa*, according to Bott ('07), chromidia are extruded by the nuclei into the cytoplasm. From these chromidia secondary nuclei arise, out of which, by a complex process of extrusion of chromatin and subsequent division, the nuclei of the gametes are formed.

In *Polyphagus* the nuclear cycle is not so complex, and the primary nuclei do not degenerate but remain in close contact with the chromidial mass. The chromidia appear to be formed for the purposes of metabolism only and gradually disappear, or lose their stainable characteristics, as the zygote matures. The two small generative nuclei remain separate until the sporangium is formed, when they pass into it along with the other contents of the zygote and fuse together to form the primary nucleus of the sporangium.

The cycle of changes in the chromidia during the development of *Polyphagus* may be summarized as follows:

The chromidia, as they pass from the zygote into the sexual sporangium, become broken up into invisibly small granules which cause the cytoplasm to stain deeply. They are used up in the growth of the sporangium and are reinforced by fresh masses of chromatin extruded from the nuclei as they divide. When the zoospores begin to segregate, the diffused chromatin gathers round each nucleus and ultimately forms the deeply stainable granular network found around the nucleus in the germinating zoospore and the fully developed vegetative cell. When the asexual sporangium is formed, the granular network again breaks up and is disseminated through the cytoplasm, to concentrate again round the forming zoospores. This process is repeated during successive asexual generations till a zygote is formed again. The two nuclei in the zygote are very large and contain a great deal of chromatin, which is extruded from them to form two masses of granules (chromidia) that subsequently fuse together into a large central mass which is visible for some time in the mature zygotes. Just at the time the zygotes are about to germinate, this granular mass loses very largely its capacity for stains, and on passing into the sporangium, becomes diffused in the cytoplasm, and the cycle of changes then repeats itself.

#### GERMINATION OF THE ZYGOTE.

The two kinds of zygote, the spiny and the smooth-walled forms, may be found, as Nowakowski states, in the same culture. The germination of the smooth-walled form has been observed by Nowakowski, but not the spiny form. He found that germination takes place about a month after the formation of the zygote. The large oil-drops become reduced in size, or may break up into smaller drops; the outer wall bursts

and the protoplasmic body grows out into a sporangium in which zoospores are formed similar to those formed in the asexual sporangia.

I have made many attempts to obtain the germination of the spiny form, but have only once succeeded. A culture containing a large number of mature zygotes had been kept under continuous observation for five months, May to November, without any change taking place. Suddenly, however, at the beginning of November, on a dull foggy morning, I noticed that very active germination was in progress, and I was fortunate enough to be able to follow out the whole process under the microscope. I have tried many times since to induce the germination of zygotes in my cultures, but, notwithstanding that I have tried all sorts of methods and placed the mature zygotes under varying conditions, I have never been able to repeat my observations.

The process of germination takes place exactly as described by Nowakowski for the smooth-walled form, and, except for the necessary rupturing of the outer spiny wall of the zygote, the growth of the sporangium and the changes which take place in it leading to segregation of the zoospores are, as already mentioned, similar in all essential details to those which occur in the formation of the asexual sporangia.

The observations about to be described began at 8.15 a.m. and were continued for more than twelve hours until the zoospores escaped. The first indication of germination is the rupture of the outer wall of the zygote and the protrusion of a delicate hyaline sphere, consisting of a quantity of hyaline or slightly granular protoplasm, surrounded by a very delicate membrane (Fig. 6). This slowly increases in size; fatty granules of irregular shape pass into it, together with the granular protoplasm (Figs. 7, 8, 9). The fatty masses begin to break up at once into smaller granules, and finally into minute particles which show a tendency to aggregate into short irregular rows (Figs. 10, 11), giving the protoplasm a filamentous appearance, as described by Nowakowski. At this stage the protoplasm becomes vacuolar, and a delicate cell-wall appears separating the sporangium from the nearly empty zygote. Very few oil-drops are now to be seen, and the filamentous structure becomes more apparent, especially in surface view. A little later the larger oil-drops completely disappear and the protoplasm now shows the filamentous arrangement of the minute oil-drops all through (Fig. 12). The oil granules then become rearranged to form a more regular network surrounding vacuolar spaces which gradually become more numerous (Figs. 13, 14). The minute oil granules at the same time become more distinct and tend to separate from one another. At 2.30 p.m. the vacuolar spaces had become still more numerous, with the oil granules arranged regularly around them, presenting the appearance in optical section of rings of granules. At 2.45 these rings of granules began to assume an irregular appearance and then began to fuse together

again into larger drops. This went on rapidly, so that by 3 o'clock the contents of the sporangium had quite a different appearance (Fig. 15). These larger drops then run together in twos and threes (Fig. 16), and at 4 p.m. these groups had fused together to form a number of oil-drops nearly equal in size and fairly equally spaced (Fig. 17).

At this stage the segregation of the zoospores begins. The granular protoplasm containing yellowish oil-drops of different sizes becomes aggregated into masses separated by delicate lines of cleavage (Fig. 18).<sup>1</sup> These spore-origins may be as shown in Fig. 18, or they may be more irregular in size and shape, as shown in Fig. 22, and the lines of demarcation may disappear and reappear again. Very soon, however, the spore-origins contract slightly and become clearly marked off from one another. At about this stage a movement of rotation becomes visible in the sporangium and the spore-origins appear to move slowly over one another. This is probably due to the gradual rotation of the whole protoplasmic contents of the sporangium, as described by Hartog ('87, '88) in species of *Saprolegnia*. In a few minutes the lines of demarcation become invisible and the spore-origins seem to fuse. The explanation to be offered of this apparent fusion is probably that the cleavage of the protoplasm begins in the centre of the sporangium and gradually extends towards the periphery. At the moment when the lines of cleavage reach the periphery and the outer layer of the cytoplasm is ruptured, thus completely separating the spores, there is a loss of turgescence and consequent contraction in the sporangium, and it is this, and possibly a swelling of the young spores also, which brings about the apparent fusion of the spores (cf. Hartog, '87, '88, and Rothert, '87). For a short time the lines of cleavage remained invisible; the oil-drops underwent further fusion, and at 5 p.m. were observed to be moving slowly backwards and forwards. At 5.45 p.m. fine lines again appeared dividing the protoplasm into smaller polygonal masses, each of which contained one oil-drop, and at 6 p.m. these protoplasmic masses had become completely separated from one another although still compressed into a polygonal shape (Fig. 19), but they at once commenced to move slowly, and at 6.5 p.m. were observed to elongate (Fig. 20) and take on the form of ripe spores. The oil-drop was now at one end of the spore. At 6.8 p.m. the apical portion of the sporangium wall gradually became thinner, and finally an opening was formed and the zoospores came out (Fig. 21). As they come out they swim away, but some of them have their cilia entangled among those still in the sporangium and are seen at the opening of the sporangium for some time making short jerky movements, apparently trying to tug their cilia away. After a little time they

<sup>1</sup> This stage and those which follow are very interesting, and show slight variations in different sporangia. Thus Figs. 22 to 25 are from an asexual sporangium, in which 64 spores were produced, and may be compared with the same stages of the smaller sexual sporangium in which there were only 32. As a rule, the apparent fusion of the spore-origins is more pronounced in the larger sporangia.

succeed, and swim rapidly away. The last two or three zoospores left in the sporangium sometimes find some difficulty in getting out, especially if the sporangium is a large one; they swim about inside it, with apparently no sense of direction, for several minutes sometimes (Fig. 21), but ultimately they find the opening and escape. In one case it took about five minutes for a sporangium with about 128 spores to empty itself, except for the three last spores, which were apparently unable to find their way out, and the last one of the three only succeeded in getting out at the end of  $12\frac{1}{2}$  minutes from the time the sporangium opened. In some cases the zoospores remain for a few seconds near the opening of the sporangium in a quiescent condition; then with a slight jerking movement, as if to disentangle their cilia, they swim away. After moving about rapidly for about twenty minutes the spores come to rest for a few seconds now and then. They then begin to move about in a very jerky fashion, often resting for a few seconds. By 7.10 p.m. only three could be observed in the neighbourhood of the empty sporangium: all the others had moved away completely from the field of view. At 7.15 I observed these three settle down, but they retained their cilia and remained in an intermittent quivering state for some time. At 8.10 they had lost their cilia and were quite still and beginning to round themselves off into a spherical form (Fig. 49).

The sporangia vary very considerably in size, and the variation in the number of zoospores produced is equally great. Nowakowski found in one case, in an asexual sporangium, that only two zoospores were formed, and I have constantly found sporangia in which from eight to sixteen zoospores only were formed. This variation in the number of zoospores appears to depend upon the amount of nutriment which can be stored up in the zygote, or upon the number of Euglenae attacked by a single individual. For, as I have constantly observed, the asexual sporangia are larger at the beginning, when the nutriment is more abundant, than at the end of an attack when the nutriment has been exhausted. The number of zoospores produced in the asexual zoosporangia is as a rule much larger than those produced in the sexual zoosporangia.

In stained specimens it is found that preparatory to germination the chromidial mass in the zygote loses to some extent its capacity for stains and is much less conspicuous (Fig. 74), allowing the two nuclei to come more clearly into view (Fig. 75). On germination, whatever is left of it passes with the two nuclei (Figs. 76-81) into the sporangium and there becomes disseminated throughout the cytoplasm. The two nuclei, which now stain more deeply but are still very small and quite unlike the primary nucleus of the asexual sporangium, come into close contact with one another (Figs. 79-81) and apparently fuse (Fig. 82). The exact process of fusion has not been observed, and it is quite impossible to say whether the chromosomes fuse together or become merely intermingled, to separate later



into two groups. The structure of the nuclei at the fusion stage has not been clearly ascertained, but there are indications that previous to fusion the chromatin mass breaks up into granules, probably chromosomes (Figs. 80, 81). The subsequent stages of nuclear division in the sexual sporangium seem to follow the same order as in the asexual sporangium, and similar changes can be observed in the final segregation of the zoospores, but the details have not been followed out in stained specimens. Fig. 83 shows a nucleus in what appears to be an early division stage; Fig. 84 shows the division of the primary nucleus of the sporangium into two, and Fig. 85 a late stage in the division of two nuclei. The number of chromosomes in each daughter nucleus could not be counted, but they appeared to be not greater than ten.

#### NUCLEAR DIVISION.

Nuclear division takes place only in the sporangia, never in the vegetative cells, gametes, or zygotes. The single large nucleus (Figs. 26-28) which enters the asexual sporangium from the vegetative cell at once divides into two, then four, eight, sixteen, thirty-two, sixty-four, &c., until a very large number are formed, sometimes several hundred. The number produced varies within very wide limits from two or four in very small sporangia to several hundred in the larger ones.

I have not been able to observe the process of division of the primary nucleus of the sporangium, but in all the later stages it is mitotic, and is probably the same, therefore, in the primary nucleus. The spindle appears inside the nucleus before the wall is broken down (Figs. 30, 33, 38-40), and is apparently formed out of the lightly stained chromatin mass which is found in the middle of the nucleus in contact with the chromatin cap. The chromosomes are about ten or twelve in number and very minute (Figs. 30, 33, 38). Only a very small portion of the large and dense chromatin mass is used up in their formation; the rest forms a thick peripheral layer on the wall of the nucleus (Figs. 30-39), which is visible during all the stages in the prophases of division, and is finally set free in the cytoplasm to be used up in the further growth of the sporangium.

Soon after the appearance of the spindle the nuclear wall at the poles of the nucleus disappears (Figs. 33, 40), and the rest of the nuclear wall contracts and becomes flattened (Fig. 39). The two poles of the spindle protrude slightly through the polar openings into the cytoplasm. At this stage centrosome-like structures become visible at the two poles (Fig. 39). The daughter groups of chromosomes then separate to the opposite poles of the spindle (Figs. 41, 42), the nuclear wall disappears entirely, and the peripheral mass of chromatin which was in contact with it contracts into a more or less globular mass, which is left lying in the cytoplasm (Figs. 31, 34, 35, 42). The chromosomes become aggregated at the periphery of the

newly constructed daughter nuclei in close contact with a lightly stained substance (Figs. 31, 44), consisting of a very fine network which almost completely fills up the rest of the nuclei. A few delicate strands remain for a short time between the daughter nuclei (Figs. 35, 43), but these soon disappear and the nuclei are left free in the cytoplasm (Fig. 44).

When the nuclear divisions are completed the segregation of the cytoplasm around the separate nuclei to form the zoospores begins. Irregular splits appear throughout the whole of the sporangium, which soon separate off distinct masses each with its own nucleus (Fig. 45). Then the oil-drops begin to fuse together to form the large oil-drops shown in Fig. 46. These come into close contact with the nuclei, one being found in each spore origin. Then a condensation of fine granular deeply stainable substance begins to aggregate around the nucleus, and partly enclosing the oil-drop and the cytoplasm immediately around, becomes vacuolar and no longer stains deeply (Fig. 46). It is just at this stage that the sporangium becomes homogeneous again by an apparent fusion of the spore origins. Soon after this fusion delicate lines of demarcation again appear, separating the spores, and delicate cell-walls make their appearance around each spore, which now rounds itself off and then become slightly elongated (Fig. 47) preparatory to escaping from the sporangium.

#### CYTOLOGY OF OTHER FORMS.

The only other members of the Chytridiaceae in which serious attention has been given to the cytology are various species of *Synchytrium*, *Olpidiopsis*, and *Olpidium*. In *Synchytrium* numerous curious and abnormal phenomena of nuclear division have been observed. Thus Dangeard ('89, '90) and Rosen ('92) both describe a form of direct nuclear division in the primary nucleus of *Synchytrium Taraxaci*, but they also found true mitosis at later stages. On the other hand, F. L. and A. C. Stevens ('03) found that in *S. decipiens*, *S. fulgens*, and *S. papillatum* the division of the primary nucleus is mitotic, whilst it would appear from the observations of Stevens ('07), Griggs ('09, &c.), Kusano ('09), and Bally ('11) that the later divisions are very variable, being sometimes mitotic, sometimes amitotic. Griggs mentions ('09) that amitotic spiremes are frequently indistinguishable from mitotic spiremes, and that amitosis by constriction and also by gemmation may occur in the same cyst. Stevens ('07) describes some remarkable nuclear phenomena in the later stages of *Synchytrium* which appear to be without parallel in the cytology of any plant or animal yet known, and the significance of which is inexplicable. F. Griggs ('09) describes some peculiar changes leading to the separation of portions of the karyosome (nucleolus) of the primary nucleus either by migration or dissolution of nuclear membrane. Each fragment becomes surrounded by a vacuole and a new nucleus is formed which later undergoes mitosis, and its descendants form

spores. Percival ('09) also gives an account of a remarkable nuclear cycle in the production of the thin-walled cells of *Synchytrium (Chrysophlyctis) endobioticum*. 'With the beginning of the reproductive stage, the chromatin of the nucleus (primary nucleus) often becomes associated with the linin threads. The nucleolus becomes vacuolated and loses its staining power; at the same time the nucleus shrinks and soon disappears entirely, the chromatin contained within it being found in the form of very distinct "chromidia" scattered through the cytoplasm of the parasite; round the chromidia small vacuoles appear, and nuclei arise at these points.' No primary nucleus was found to undergo recognizable mitotic division, but undoubted mitosis occurs in the minute secondary nuclei (p. 443). Kusano ('12) states that in *Olpidium Viciae* 'the nuclei of the sporangium multiply during the vegetative or growing phase by an amitotic-like division and during the reproductive phase by mitosis.'

The very small portion of chromatin which is required for nuclear division, the minuteness of the chromosomes, and the prominence of the extruded nuclear material render the observation of the various stages of nuclear division extremely difficult, and it may well be, especially in *Synchytrium*, where the resting nucleus is so large and the dividing stages so small (Stevens, '07), that mitotic nuclear divisions have been overlooked. In any case, seeing the numerous discrepancies in the descriptions given by various observers, and that both in *Olpidiopsis*, as Barrett ('12) has recently shown, and in *Polyphagus* the nuclear divisions are normally mitotic throughout, with well-marked spindles and chromosomes, it is very desirable that all these abnormal nuclear divisions should be further investigated.

Kusano's account of the cytology of the zygote of *Olpidium Viciae* is extremely interesting and presents many points of comparison with my own observations on *Polyphagus*. The two nuclei of the zygote occupy a peripheral position, usually opposite each other. After it has attained its maximum growth chromatin is extruded into the cytoplasm, partly by a process of budding of each nucleus and partly by the extrusion of nucleoli. This chromatin accumulates in the central region of the zygote in the form of a chromidial network, and is deeply stainable. At a later stage the stainable substance occupies the central portion of the zygote as large globules which look like oil-drops. At a still later stage a dissolution of the stainable substance takes place and the cytoplasm appears homogeneously granular, being hardly stainable. Fusion of the nuclei does not take place until shortly before germination. Kusano mentions that cytologically the Fungus shows a certain resemblance to the Protozoa or the Plasmidiophoraceae.

## THE RELATIONSHIP OF POLYPHAGUS TO OTHER FORMS.

The Chytridiaceae have not been very exhaustively investigated, and very few complete life-histories of them are known. But we have sufficient information concerning various members of the group to show that sexual reproduction may vary from the simple direct fusion of motile gametes—zoospores—to the copulation of non-motile gametes which may be either uninucleate or multinucleate and which show clear transitions to the methods of sexual reproduction in the higher groups of the Fungi.

The copulation of motile zoospores has been described by Fisch ('84) in *Reesia* and by Sorokin ('89) in *Tetrachytrium*. The cytology of these forms is unknown. Kusano ('12) has, however, shown that in the new species, *Olpidium Viciae*, which he has discovered, binucleate cells are formed by the copulation of motile uninucleate zoospores. Griggs ('10) had previously described a new genus, *Monochytrium*, which in some respects resembles *Reesia* (Atkinson, Bot. Gaz., xlix, 1910) and bears some resemblance to the species described by Kusano, the zoospores of which penetrate the cells of the host (*Ambrosia artemisiaefolia*) and there become amoeboid; some of the amoebulae then unite in pairs to form binucleate zygotes.

In *Zygorhizidium Willei*, according to Loewenthal ('05), the gametes are uninuclear and are equivalent to sporangia. They are placed in contact with each other by a copulating tube put out from the smaller, male gamete, the contents of the latter then passing over into the female, which thus becomes the zygote.

In *Olpidiopsis* also it is probable, according to Barrett ('12), that the gametes are equivalent to sporangia. Unlike *Zygorhizidium*, however, the gametes are multinucleate and the sexual nuclei probably fuse in pairs, presenting thus an analogy with *Cystopus (Albugo) Bliti*.

In its general structure and life-history *Polyphagus* is obviously associated with *Zygorhizidium*, and the cytological structure of these two forms, together with that of *Olpidiopsis*, clearly indicates the connexion of the Chytridiaceae with the Oomycetes. But *Polyphagus* also has some relationship with *Zygochytrium*, a form which possesses a well-marked Chytridiaceous sporangium, but is connected with the Mucorineae through its Mucor-like formation of zoospores.

This brief summary shows, therefore, that *Polyphagus* forms a very obvious link between *Zygochytrium* and *Zygorhizidium*, and that there is clearly a progressive sexual series from *Olpidium* and *Monochytrium* leading on the one hand to the Mucoraceae through *Polyphagus* and *Zygochytrium*, and on the other to the Oomycetes through *Zygorhizidium*, *Polyphagus*, and *Olpidiopsis*.

But *Polyphagus*, and possibly other members of the Chytridiaceae also, shows some relationships with the Protozoa. Thus, in its general structure,

*Polyphagus* is not unlike the common sun animalcule, *Actinophrys sol*. Many characteristics are common to both: the uninucleate thallus, the radiating pseudopodia connected with, or arising close to, the nucleus, and the vacuolate condition of the peripheral cytoplasm.

In other respects also, as in the peculiar structure of the nucleus and the extrusion of chromidia, *Polyphagus* shows affinity with the Protozoa.

It is not my purpose here to discuss these relationships, but I cannot help feeling that, the more we learn of the general structure and life-histories of the Rhizopoda (Sarcodina) and the Chytridiaceae, the more apparent it becomes that the attempt to derive the Chytridiaceae 'from the higher Phycomycetes by degeneration through parasitism' (see Atkinson, '09) is an unsatisfactory solution of a difficult problem, and that in discussing their phylogeny we must take into account the evidence for their possible origin from Protozoan-like ancestors, as Dangeard has maintained ('01), and their development along a progressive line of evolution.

#### THEORETICAL CONSIDERATIONS.

The study of the nuclear cycle of *Polyphagus* affords clear evidence of the dual nature of the nucleus, and perhaps throws some light upon the delayed nuclear fusions and the double nuclear fusions observed in the sexual reproduction of some of the higher groups of the Fungi.

That nuclei have both somatic and generative functions is well known, and Schaudinn ('03) suggested that these two functions reside in two distinct parts of the nucleus and that each cell is therefore in a sense binucleate. Goldschmidt ('04, '05) put this in an extreme form when he brought forward the definite hypothesis that every cell is essentially binucleate and possesses a somatic nucleus with metabolic functions and a propagative nucleus with generative functions. In the Infusoria it has long been known that these two elements are differentiated in the cell as a macro-nucleus and a micro-nucleus, but in other organisms they are united in a single structure which he calls 'amphinucleus'. In *Polyphagus* it seems quite clear that the nucleus has this dual structure to the extent that the chromidia represent the vegetative or somatic element and the small nuclei, left after the extrusion of the chromidia, the generative element. This is not, however, sufficient to warrant the conclusion that the chromidia owe their existence to the activities of a somatic nucleus which has an individuality of its own apart from a generative nucleus.

The double fusion which takes place in the life-cycle of *Polyphagus* is clearly bound up with this dual function of the nucleus, the chromidial fusion in the zygote promoting vegetative growth, whilst the nuclear fusion in the sporangium precedes the formation of the spores. The importation of two nuclei into the zygote appears therefore to be

primarily for the purpose of increasing its vegetative activity, and the fusion of the generative nuclei is apparently not essential to the maturation of the zygote, but seems to be required for the production of the zoospores.

The obvious explanation that may be given of this is that the zygote is essentially a resting cell in which large quantities of food in the shape of fatty substances and glycogen are stored up in order to tide over a period of rest and to afford food material for the growth of the sporangium which will ultimately be produced, and that for this purely vegetative development the vegetative portions only of the nucleus are required.

This is also very clearly shown in the Uredineae; but here, instead of a resting stage, a long series of vegetative cell divisions is interposed between the cell fusion and the nuclear fusion. The cell fusion, or, as Blackman calls it, 'vegetative fertilization', takes place here by a sexual process in the aecidium, the contents of one cell passing over into the other. The two nuclei come together, but do not fuse. During the long series of vegetative divisions which intervene between the germination of the zygote, or what represents the zygote, and the germination of the teleutospore, they remain separate and divide continually by conjugate division. In the teleutospore the direct descendants of these two nuclei fuse.

The binucleate phase of the Uredineae is commonly regarded as a sporophyte in which the cells contain  $2n$  chromosomes. But inasmuch as the nuclei remain separate all through, it is plain, as Harper points out ('10), that the nuclear fusion is unnecessary so far as the sporophyte is concerned, and that its vigour and adaptability are not dependent upon the union of the parental chromosomes into a single nucleus. But as soon as the time arrives for the actual reproductive organs to be formed, the fusion takes place. The process of conjugate division in the Uredineae is accompanied by the extrusion of nucleolar chromatin which is probably homologous with the chromidia of *Polyphagus*.

The Hymenomycetes may be brought into line with the Uredineae, for although there appears to be no true sexual fusion, the cells of the hymenium become binucleate, probably by a process of autogamy, similar to that which probably takes in the simpler forms of the Uredineae, and the binucleate condition persists until the formation of the binucleate basidia, in which the two nuclei fuse.

The general conclusion at which we arrive, therefore, is that when the sexual cell fusion is followed by a period of rest, as in *Polyphagus*, or by a series of vegetative cell divisions, as in the Uredineae, there is no necessity for any nuclear fusion, but that as soon as the reproductive spores are to be formed, the fusion takes place and completes the sexual fusion.

Here we are met with the anomaly in the life-history of the Ascomycetes, that in their case there appear to be two complete nuclear fusions, one in the ascogonium and one, later on, in the ascus. Claussen, in his

observations on *Pyronema*, considers that the fusion in the ascus should be regarded as the completion of the sexual fusion, for he maintains that, although there is a normal cell fusion of antheridium and ascogonium, there is no nuclear fusion in the ascogonium. He suggests that the male and female nuclei simply become paired in the ascogonium and subsequently divide by conjugate division in the ascogenous hyphae and fuse ultimately in the ascus. This would bring the Ascomycetes into line with *Polyphagus* and the Uredineae, but the very definite observations of Harper, followed by Blackman, Frazer, and others, that in some forms there is a nuclear fusion in the ascogonium as well as a subsequent fusion in the ascus, preclude our acceptance of the easy solution of the problem offered by Claussen, and we must look for it in another direction.

If we consider that in the nuclei of the Ascomycetes, as in other forms, we have the two elements, the generative and the vegetative, is it not possible to conceive the first fusion of the nuclei in the ascogonium as a purely vegetative fusion, and the second fusion in the ascus as the generative fusion? In other words, may not the nuclear fusion in the sexual apparatus and the nuclear fusion in the ascus be simply regarded as the vegetative and generative phases of a single sexual act which have become separated owing to the interpolation of a series of vegetative divisions between the formation of the ascogonium and the production of the ascospores?

This conjecture seems the more reasonable when we remember that in so pronounced a sexuality as that of *Polyphagus* the nuclei do not fuse in the zygote, but only those portions of the chromatin extruded from them which are obviously bound up with vegetative development. And it is further supported by the trend in the direction of non-sexual fusion shown by the Ascomycetes in general, as indicated by the total disappearance of cell fusion in many forms and its reduction to mere pairing in others, but leaving in all cases the generative fusion of nuclei in the ascus.

#### SUMMARY.

1. *Polyphagus Euglenae* is one of the few Chytridiaceae in which there is pronounced sexuality. Reproduction takes place by the production of zoospores in sporangia, which may be formed on the ordinary vegetative cells, or on cysts, or on the sexually produced zygotes.

2. The organism is parasitic on *Euglena viridis*. The thallus is unicellular and uninucleate, and is provided with delicate pseudopodia which penetrate the cells of the *Euglenae* and bring about complete disintegration of their contents. A single thallus may be in contact with as many as fifty *Euglenae*.

3. The zoospore possesses a single flagellum, at the base of which is a yellow oil-drop in close contact with the nucleus. The nucleus is

surrounded by a deeply stained chromidial mass, which extends also around the oil-drop to the point of attachment of the flagellum. It is suggested that the yellow-coloured oil-drop may be functional in connexion with the phototaxis of the zoospores.

4. The nucleus of the vegetative cell contains a large chromatin nucleolus, which is frequently arc-shaped and is in close contact with a lightly stainable nucleoplasm. The nucleus is surrounded on all sides by a deeply stained mass of chromidia.

5. The zygotes are formed by the fusion of uninucleate gametes, which are equivalent to vegetative cells. They are placed in contact with each other by means of a copulating tube which is put out from the smaller or male cell and comes into contact with the larger, female cell. The apex of the copulating tube swells up and becomes the zygote. The contents of the male tube first pass into it, then the contents of the female cell.

6. The two sexual nuclei in the young zygote are at first unequal in size, but the smaller male nucleus grows, probably at the expense of nourishment brought in from the female cell, until it becomes equal in size to the female nucleus. Large quantities of chromatin are then extruded from the two nuclei to form two masses of chromidia which fuse and form a large granular mass for which the term 'chromidiosphere' (or 'chromidio-centrum') is suggested. The significance of the chromidia and the chromidial fusion is briefly discussed.

7. The germination of the zygote has been followed in detail both in living and stained specimens. It was observed to take place in November, five months after the formation of the zygotes. The outer spiny coat is ruptured, and a delicate protuberance appears which develops into a zoosporangium similar to the ordinary asexual sporangium, except that it is usually much smaller. The two sexual nuclei do not fuse until after their entry into the sporangium.

8. Nuclear division takes place only in the sporangia, never in the vegetative cells, cysts, or zygotes. The process has been followed in the asexual sporangia. The spindle is internal; the nuclear wall breaks down first at the poles, where kinoplasmic substance with radiating striae appear. The prophases and anaphases of division appear to be those of normal mitosis, but, compared with the large amount of chromatin in the resting nucleus, the chromosomes are small.

9. With the exception of *Olpidiopsis* and *Olpidium*, the cytology of the Chytridiaceae is not very completely known, and there are many accounts of curious abnormal nuclear phenomena, especially in *Synchytrium*, which require elucidation in view of the perfectly normal mitosis in *Polyphagus* and *Olpidiopsis*.

10. *Polyphagus* shows relationships with various other genera of the Chytridiaceae, leading on the one hand to the Oomycetes and on the other



to the Mucoriaceae. In its general structure and in the formation of chromidia it also shows some connexion with the Protozoa.

11. In *Polyphagus* we can clearly see the dual nature of the nucleus in that the larger part of the chromatin contained in it is definitely extruded for purposes of metabolism, only a small part being left for nuclear division and reproduction.

12. The double fusion in *Polyphagus*, consisting of a chromidial fusion in the zygote followed by nuclear fusion in the sporangium, may afford some clue to the explanation of the delayed nuclear fusions and double nuclear fusions observed in the higher Fungi. This is briefly discussed.

---

LIST OF PAPERS.

- ATKINSON, G. F. : Some Problems in the Evolution of the Lower Fungi. *Annales Mycologici*, vol. vii, 1909.
- BAIL, TH. : Mycologische Berichte. III: *Chytridium Euglenae*. *Bot. Zeit.*, vol. xiii, 1855, p. 678.
- BALLY, W. : Cytologische Studien an Chytridieen. *Jahrb. f. wiss. Botanik*, vol. I, 1911.
- BARRETT, J. T. : Development and Sexuality of some Species of *Olpidiopsis*, (Cornu) Fischer. *Ann. Bot.*, vol. xxvi, 1912.
- DE BARY, A. : Comp. Morph. and Biology of the Fungi, &c. Eng. Edit., 1887, p. 162.
- BERTHOLD, G. : Studien über Protoplasmamechanik. Leipzig, 1886.
- BOTT, K. : Ueber die Fortpflanzung von *Pelomyxa palustris*. *Archiv f. Protistenkunde*, vol. viii, 1907.
- BRAUN, A. : Ueber *Chytridium*. *Monatsberichte der Berliner Akademie*, 1855.
- : Ueber *Chytridium*, eine Gattung einzelliger Schmarotzergewächse. *Abhandlungen der Berliner Akad.*, 1856.
- : Ueber einige neue Arten von *Chytridium* mit der damit verwandten Gattung *Rhizidium*. *Monatsb. d. Berl. Akad.*, 1856.
- BÜSGEN, M. : Die Entwicklung der Phycomycetensporangien. *Pringsheim's Jahrb. f. wiss. Botanik*, vol. xiii, 1882.
- DANGEARD, P. A. : Recherches sur la structure du *Polyphagus Euglenae*, Nowak. *Le Botaniste*, vol. vii, 1900.
- : Recherches histologiques sur les Champignons. *Le Botaniste*, vol. ii, 1890.
- : Structure et communications protoplasmiques dans le *Bactridium flavum*. *Le Botaniste*, vol. vii, 1900.
- GOLDSCHMIDT, R. : Die Chromidien der Protozoen. *Archiv f. Protistenkunde*, vol. v, 1904.
- GRIGGS, R. F. : Mitosis in *Synchytrium*. *Bot. Gazette*, vol. xlviii, 1909.
- : Some Aspects of Amitosis in *Synchytrium*. *Bot. Gaz.*, vol. xlvii, 1909.
- : *Monochytrium* : a New Genus of the Chytridiales, its Life History and Cytology. *Ohio Nat.*, vol. x, 1910.
- GROS, G. : De l'embryogénie ascendante des espèces on génération primitive, équivoque et spontanée et métamorphoses de certains animaux et végétaux inférieurs. *Bull. de la Soc. Imp. des Sciences Nat. de Moscou*, 1851.
- HARPER, R. A. : Cell Division in Sporangia and Asci. *Ann. Bot.*, vol. xiii, 1899.
- : Sexual Reproduction in *Pyronema confluens*, &c. *Ann. Bot.*, vol. xiv, 1900.

- HARTOG, M.: On the Formation and Liberation of the Zoospores of the Saprolegniae. Q. J. M. S., N. S., 1887.
- : Recent Researches on the Saprolegniae; a Critical Abstract of Rothert's Results. Ann. Bot., vol. ii, 1888.
- : On the Cytology of the Vegetative and Reproductive Organs of the Saprolegniae. Trans. R. Irish Academy, vol. xxx, 1895.
- HERTWIG, R.: Die Protozoen und die Zelltheorie. Archiv f. Protistenkunde, vol. i, 1907.
- KUSANO, S.: On the Cytology of *Synchytrium*. Centralbl. f. Bakt. &c., 2. Abt., vol. xix, 1909.
- KWAKINE, W.: Recherches biologiques sur *Astasia ocellata* n.s. et *Euclena viridis*, Ehr. Ann. d. Sci. Nat., Zool., 7th series, vol. i, 1886.
- LOEWENTHAL, W.: Weitere Untersuchungen an Chytridiaceen. Archiv f. Protistenkunde, vol. v, 1905.
- MESNIL, F.: Chromidies et questions connexes. Bull. de l'Institut Pasteur, vol. iii, 1905.
- MINCHIN, E. A.: An Introduction to the Study of the Protozoa. London, 1912.
- NOWAKOWSKI, L.: Beitrag zur Kenntniss der Chytridiaceen. II: *Polyphagus Euglenae*, eine Chytridiacee mit geschlechtlicher Fortpflanzung. Cohn's Beitr. z. Biol. d. Pflanzen, vol. ii, 1876-77.
- : Ueber *Polyphagus* (in Polish). Abh. d. Krakauer Akad., 1878.
- PAVILLARD, J.: État actuel de la protistologie végétale. Progressus rei Botanicae, vol. iii, 1910.
- PERCIVAL, J.: Potato 'Wart' Disease; the Life History and Cytology of *Synchytrium endobioticum* (Schilb.). Centralbl. f. Bakt., &c., vol. xxv, 1909.
- PROWAZEK, S. v.: Die Erreger der Kohlhernie, *Plasmidiophora brassicae*. Arbeiten aus dem kaiserlichen Gesundheitsamte (Berlin), vol. xxii, 1905.
- ROSEN, F.: Studien über die Kerne und die Membranbildung bei Myxomyceten und Pilzen. Cohn's Beiträge zur Biologie der Pflanzen, vol. vi, 1892-3, p. 237.
- ROTHERT, W.: 'Rozwój Zarodni u Grzbów z Rodziny Saprolegnieae' (Formation of Sporangia and Spores in the Saprolegniae). Proceedings of the Cracow Acad., vol. xvii, 1887. See also Cohn's Beiträge, 1888.
- SCHAUDINN, F.: Die Fortpflanzung einiger Rhizopoden. Arbeiten aus dem kaiserlichen Gesundheitsamte, vol. xix, 1903.
- SCHENK, A.: Algologische Mittheilungen. Verhandlungen der phys.-med. Gesellschaft zu Würzburg, viii, 1857.
- SCHROETER, J.: Chytridineae, in Engler und Prantl, 'Die natürlichen Pflanzenfamilien.' Teil I, Abt. I, 1889-97 (Parts 76, 1892, and 93, 1893).
- SIEBOLD, C. TH. VON, and MEISSNER: (Ref. in Nowakowski, 1876-7, p. 201), 1855.
- STEVENS, F. L.: Some Remarkable Nuclear Structures in *Synchytrium*. Annales Mycologici, vol. v, 1907.
- STEVENS, F. L. and A. C.: Mitosis in the Primary Nucleus in *Synchytrium decipiens*. Bot. Gaz., vol. xxxv, 1903.
- WAGER, HAROLD: The Formation of the Zygospore in *Polyphagus Euglenae*. Report of the Brit. Ass., Bristol, 1898, p. 1064.
- : The Sexuality of the Fungi. Ann. Bot., vol. xiii, 1899.
- : On some Problems of Cell Structure and Physiology. Presidential Address to the Botanical Section, Brit. Ass. Report, S. Africa, 1905.
- : On the Structure and Reproduction of *Cystopus candidus*. Ann. Bot., vol. x, 1896.
- : On the Eye-spot and Flagellum in *Euclena viridis*. Jour. Linn. Soc., vol. xxvii, 1899.
- WARD, H. MARSHALL: Observations on Saprolegniae. Q. J. M. S., N. S., vol. xxiii, 1883.
- ZUELZER, M.: *Diffugia urceolata*. Archiv f. Protistenkunde, vol. iv, 1904.

## DESCRIPTION OF FIGURES IN PLATES XVI-XIX.

Illustrating Mr. Harold Wager's paper on *Polyphagus*.

(Except where otherwise stated the figures have been drawn with the aid of a camera lucida, using the apoc. obj. 2 mm. of Zeiss and compensating oc. 8.)

## PLATE XVI.

Fig. 1. Copulation of male and female cells. Copulating tube very long. The young zygote is just beginning to form as a swelling at the apex of the copulating tube in contact with the female cell. (Obj. Zeiss D, oc. 8, Cam. lucida sketch.)

Fig. 2. Male nucleus just ready to pass along the copulating tube into the young zygote. The copulating tube shows three slight swellings along it.

Fig. 3. Zygote at a slightly later stage than in Fig. 1. Copulating tube larger in diameter and shorter. (Obj. Zeiss D, oc. 8, Cam. luc. sketch.)

Fig. 4. Young zygote, showing male and female nuclei just about to pass into it. Copulating tube short. (Obj. 2 mm. apoc., oc. 8, freehand sketch.)

Fig. 5. Young zygote, showing male nucleus inside and female nucleus ready to pass in. (Obj. Zeiss D, oc. 8, freehand sketch.)

Figs. 6-21. Germination of zygote. (Obj. Zeiss D, oc. 4, freehand sketches.)

Fig. 6. Zygote just beginning to germinate in November.

Fig. 7. Shows contents of zygote with fatty granules.

Fig. 8. Ditto, later stage.

Fig. 9. Oily masses beginning to break up.

Fig. 10. Oily masses breaking up into minute granules which appear black under microscope.

Fig. 11. Vacuoles appear; further breaking up of fat granules.

Fig. 12. Fat completely broken up into minute granules arranged in strings.

Fig. 13. Minute fat granules surrounding vacuoles.

Fig. 14. Ditto, more regular arrangement of vacuoles.

Fig. 15. Fat globules fusing together.

Fig. 16. Later stage of fusion.

Fig. 17. Granules, much fewer, nearly all same size, one for each zoospore.

Fig. 18. Contents divided into polygonal masses, the young spores.

Fig. 19. The spores completely separated.

Fig. 20. The spores, just before they escape, become slightly elongated.

Fig. 21. Spores escaping; the three shown were unable to get out for some time.

Figs. 22-25. Successive stages in the segregation of spores in a portion of an asexual sporangium. (Obj. Zeiss D, oc. 4, freehand sketches.)

## PLATE XVII.

Fig. 26. Sporangium just beginning to form on the vegetative cell.

Fig. 27. Young sporangium just formed on the vegetative cell with nucleus just passing into it, surrounded by a deeply stainable chromidial mass with oil globules. The large nucleolar mass of chromatin has become constricted, in its passage through the opening, into a large anterior and a small posterior portion, with a drawing-out thread between them.

Fig. 28. Sporangium just being formed. The membrane around it is visible and is seen to be continuous with that of the male cell. The nucleus has just passed into the sporangium, and in the passage a small portion of it has been left behind. A number of chromidial granules are scattered in the protoplasm which is passing into the sporangium. The rest of the chromatin mass (nucleolus)

has become arc-shaped, and appears of a peculiar spongy texture. The nucleoplasm is in contact with it.

Fig. 29. Young sporangium with two nuclei, each with a sickle-shaped mass of chromatin and a smaller granule or group of minute granules.

Fig. 30. Young sporangium with two nuclei in process of division. Near each nucleus is a quantity of chromatin, probably extruded from the nuclei for purposes of metabolism. This is probably derived from the large sickle-shaped chromatin mass or nucleolus which is found in the resting stage.

Fig. 31. Sporangia with four nuclei, three of which are shown. They appear to have just finished dividing. A few fine fibrils are seen extending between the pair of nuclei shown, and the groups of chromosomes in the newly constituted daughter nuclei are visible. There are two deeply stained chromatin masses in the cytoplasm.

Fig. 32. Sporangium with four nuclei, each with peripheral chromatin mass and nucleoplasm.

Fig. 33. Sporangium with four nuclei, all in process of division. Equatorial plate just forming. The lateral walls of each nucleus prominent and deeply stained. At the poles of the nuclei are well-marked radiating striae.

Fig. 34. Upper two-thirds of a sporangium with four nuclei, all of which are shown in the part drawn. Two large, deeply stained granules and two smaller ones, probably extruded from the nuclei during division.

Fig. 35. Sporangium showing the reconstruction of the daughter nuclei. A few delicate strands, the remnants of the spindle, are still visible, extending between the young nuclei, and near these are large stained granules, probably the remains of the nucleoli.

Fig. 36. Sporangium with eight nuclei. The nucleolar body forms a sickle-shaped mass at the periphery of each nucleus.

Fig. 37. Portion of sporangium with 32 nuclei. A deeply stained arc of substance is applied against the nuclear membrane of each. The granular or thread-like substance in the centre is probably just about to break up into chromosomes.

Fig. 38. One half of a sporangium with 32 nuclei, all in process of division. The spindle is clearly shown, and at the poles of some of the nuclei kinoplasmic masses (centrosomes?) with radiating striae are to be seen. The nuclear membrane is thickened laterally. One of the nuclei shows clearly ten chromosomes.

Fig. 39. Sporangium with 32 nuclei, all dividing. Apparently a later stage than Fig. 38. The nuclei are flattened slightly at the poles, where the kinoplasm is prominent with radiating striae. No granules which could be distinctly called centrosomes were visible in the kinoplasmic masses, although these sometimes appeared to be granular.

Fig. 40. Young sporangium with eight nuclei, all in division stage, showing equatorial plate, spindle, and appearance of radiating striae at the poles of the nuclei. The spindle seems to be formed out of the lightly stained fine network in the nucleus, and appears before the wall breaks down at the poles.

Fig. 41. Portion of sporangium containing about 32 nuclei in state of division. The drawing shows an optical section of a portion with eight nuclei. Four of the nuclei, being at a different level, are not shown. Between the groups of daughter chromosomes in each case is an oval or spherical mass slightly less deeply stained than the chromosomes, probably the remains of the nucleolus.

#### PLATE XVIII.

Fig. 42. Portion of a sporangium in which there were probably 64 nuclei, all in a late stage of division. The spindle fibres connecting the groups of daughter chromosomes are visible, and near each is a deeply stained granule, probably extruded from the nucleus during division.

Fig. 43. Portion of sporangium with 16 nuclei just divided. Eleven of these are shown in the drawing. Between the pairs of nuclei delicate fibres are still visible, and the cytoplasm contains some deeply stained granules.

Fig. 44. Portion of sporangium just before the segregation of the zoospores. There were 32 nuclei present, 16 of which are shown.

Fig. 45. Portion of sporangium in which there were 64 spores just separated, 16 of which are shown in the drawing. Each spore contains a well-marked nucleus and granular cytoplasm.

Fig. 46. Part of sporangium showing segregation of spores. Each spore-origin contains a nucleus and oil-drop, around which are to be seen deeply stained chromidial masses. The delicate lines of demarcation between the zoospores are visible.

Fig. 47. Portion of sporangium showing fully formed spores.

Fig. 48. Zoospore, showing oil-drop at base of cilium and near it the nucleus; both oil-drop and nucleus are surrounded on all sides by the deeply stained chromidial mass. (Obj. 2 mm., oc. 8, freehand sketch.)

Figs. 49-53. Five stages in the germination of a zoospore after it had come to rest. Fig. 49 was drawn at 9.30 a.m., Fig. 50 at 10.30 a.m., Fig. 51 at 11.40 a.m., and Fig. 53 at 12.25 p.m. (Obj. Zeiss D, oc. 4, freehand sketches.)

Fig. 54. Young vegetative cell, showing pseudopodia which appear to be continuous with the cell body and with the deeply stained chromidial mass surrounding the nucleus. (Obj. 2 mm., oc. 8, freehand sketch.)

Fig. 55. Vegetative cell showing the granular chromidial network with included oil globules surrounding the nucleus.

Fig. 56. Freehand sketch, showing how the haustoria of *Polyphagus* penetrate the cell of *Euglena* and branch in all directions. The cell is full of paramylum grains. The preparation was made by staining alcoholic specimens in iodine solution.

Fig. 57. Young zygote. Male nucleus just passing into it; female nucleus ready to enter; copulating tube very short.

Fig. 58. Zygote and female cell. The male nucleus is already in the zygote. The large nucleus of female cell is surrounded by a deeply stained chromidial mass.

Fig. 59. Female nucleus just in the act of passing into the zygote. The nucleolus is elongate and constricted, showing how plastic it is.

Fig. 60. The female nucleus has just arrived in the zygote, and is in close contact with the male nucleus, which is much the smaller of the two.

Fig. 61. The zygote with the two sexual nuclei in close contact. The male nucleus gradually increases in size, probably at the expense of material brought in from the female cell. Deeply stained chromidia are scattered here and there in the cytoplasm.

Fig. 62. Sexual nuclei equal in size, and separated to opposite sides of the zygote.

Figs. 63-66. Four stages, showing the extrusion of chromidia from the zygote nuclei. The nuclei become smaller as the chromatin is extruded.

Fig. 67. Zygote showing the two small generative nuclei and the two chromidial masses.

#### PLATE XIX.

Fig. 68. The chromidial masses are fusing together.

Fig. 69. Fusion of the chromidia complete. This large central mass, which is so conspicuous in mature zygotes, may be distinguished as the chromidiocentrum or the chromidiosphere.

Fig. 70. Shows the two nuclei embedded in the chromidiosphere. The chromatin mass in each nucleus shows about ten granules (chromosomes?).

Fig. 71. The two nuclei at the periphery of the chromidiosphere.

Fig. 72. The two nuclei slightly embedded in the chromidiosphere.

Fig. 73. Chromidiosphere irregular in shape, nuclei embedded in it. Stage probably just after fusion.

Fig. 74. The chromidia begin to lose their staining capacity just previous to germination.

Fig. 75. Germination of zygote; the two sexual nuclei just about to pass into the sporangium.

Fig. 76. The two sexual nuclei just in the act of passing into the sporangium. One nucleus already in the sporangium, the other elongate and constricted, just passing through the narrow aperture.

Fig. 77. The two sexual nuclei in the young sporangium.

Fig. 78. Slightly later stage.

Fig. 79. Still later stage; the nuclei are very close together, probably fusing.

Fig. 80. Similar stage to Fig. 79, but each nucleus shows granules estimated at about 10-12 each.

Fig. 81. Two nuclei in the fusing stage, chromosomes clear. There appeared to be about ten in each nucleus, but this was not certain.

Fig. 82. Single nucleus of sporangium, due to fusion of the two sexual nuclei.

Fig. 83. Sporangium showing a nucleus in what seems to be a division stage.

Fig. 84. Division of primary nucleus of sporangium into two.

Fig. 85. Sporangium showing late stage of two dividing nuclei. The number of chromosomes in each daughter nucleus could not be counted, but appeared to be not greater than ten.



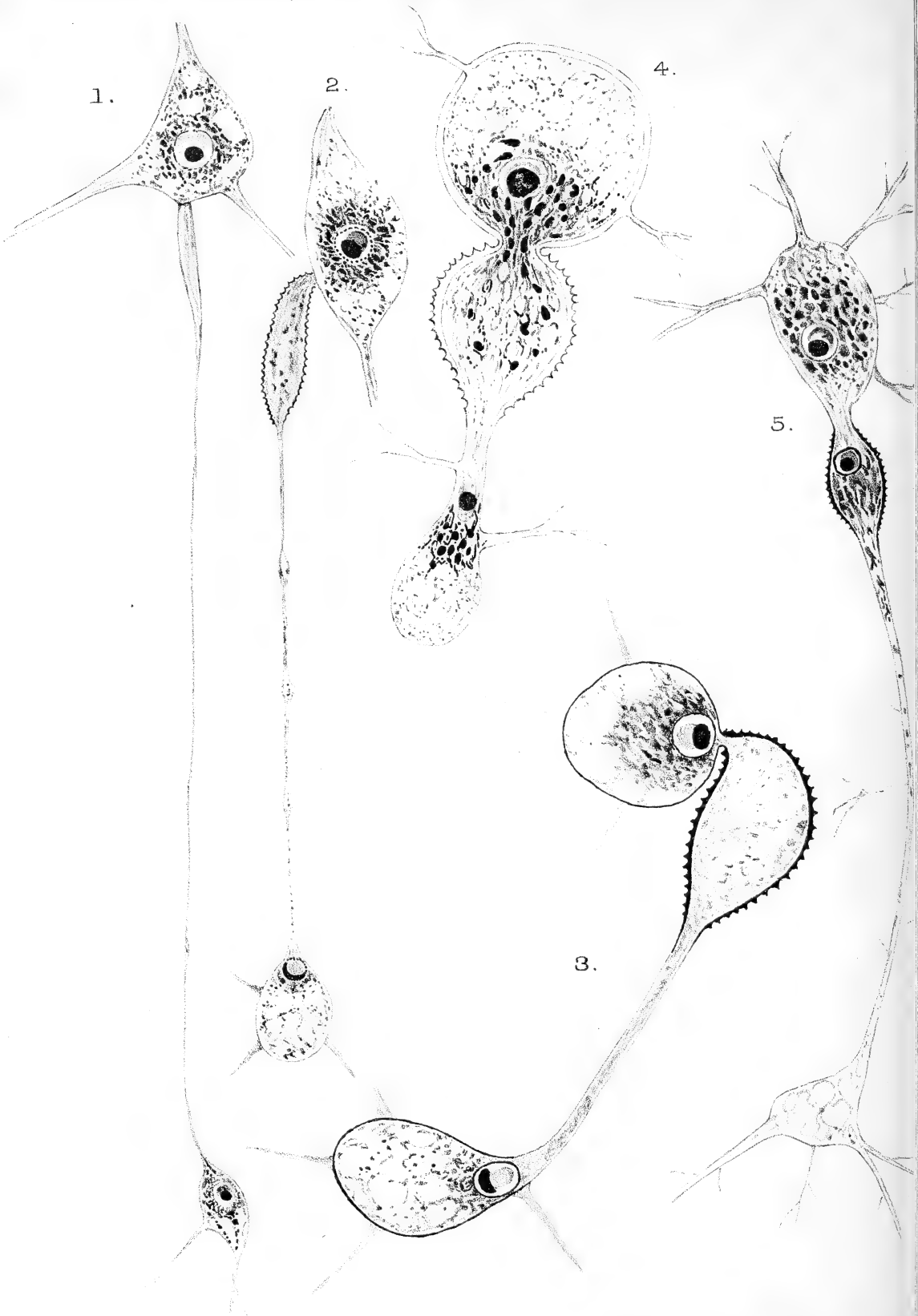

WAGER — POLYPHAGUS EUGLENÆ.



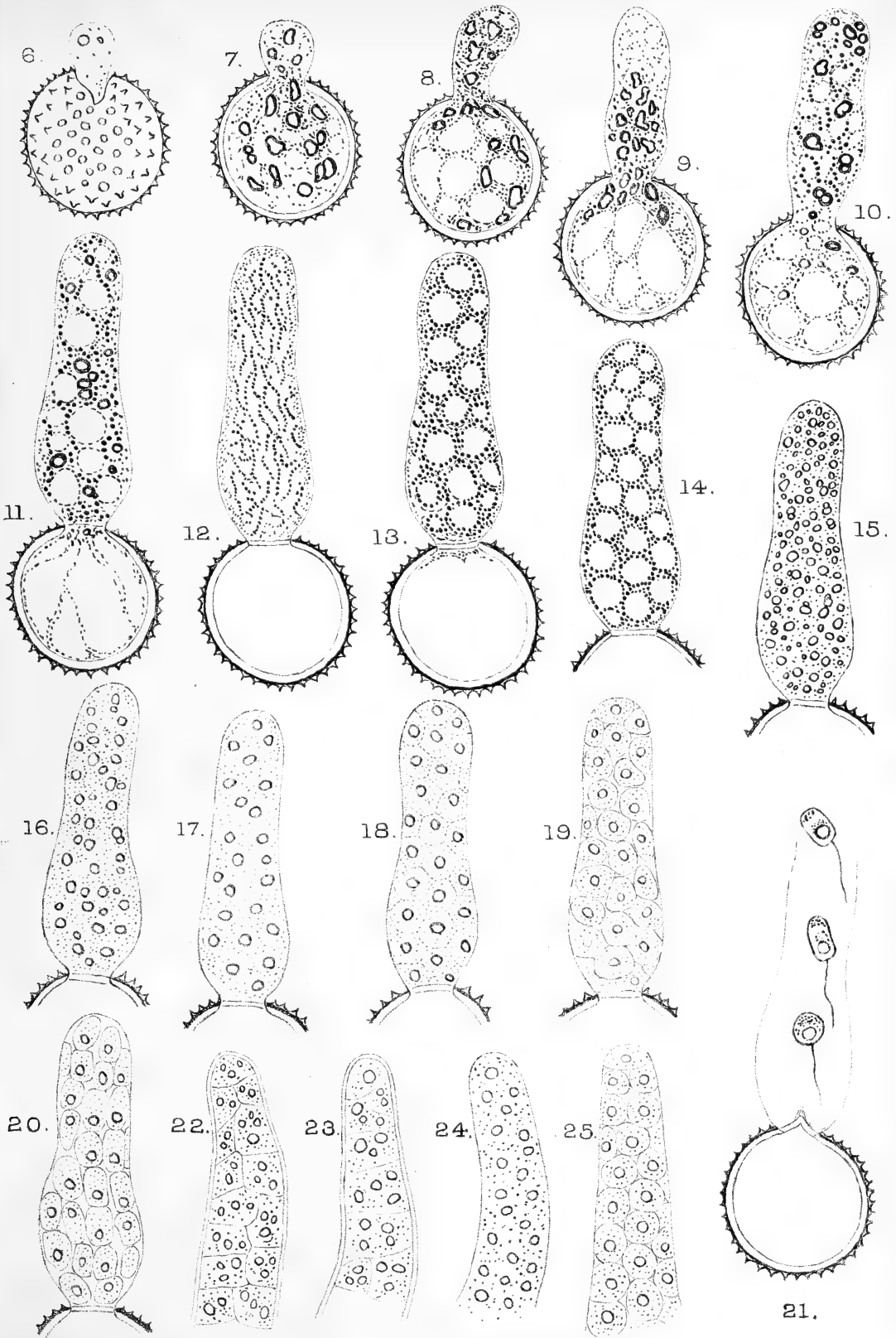



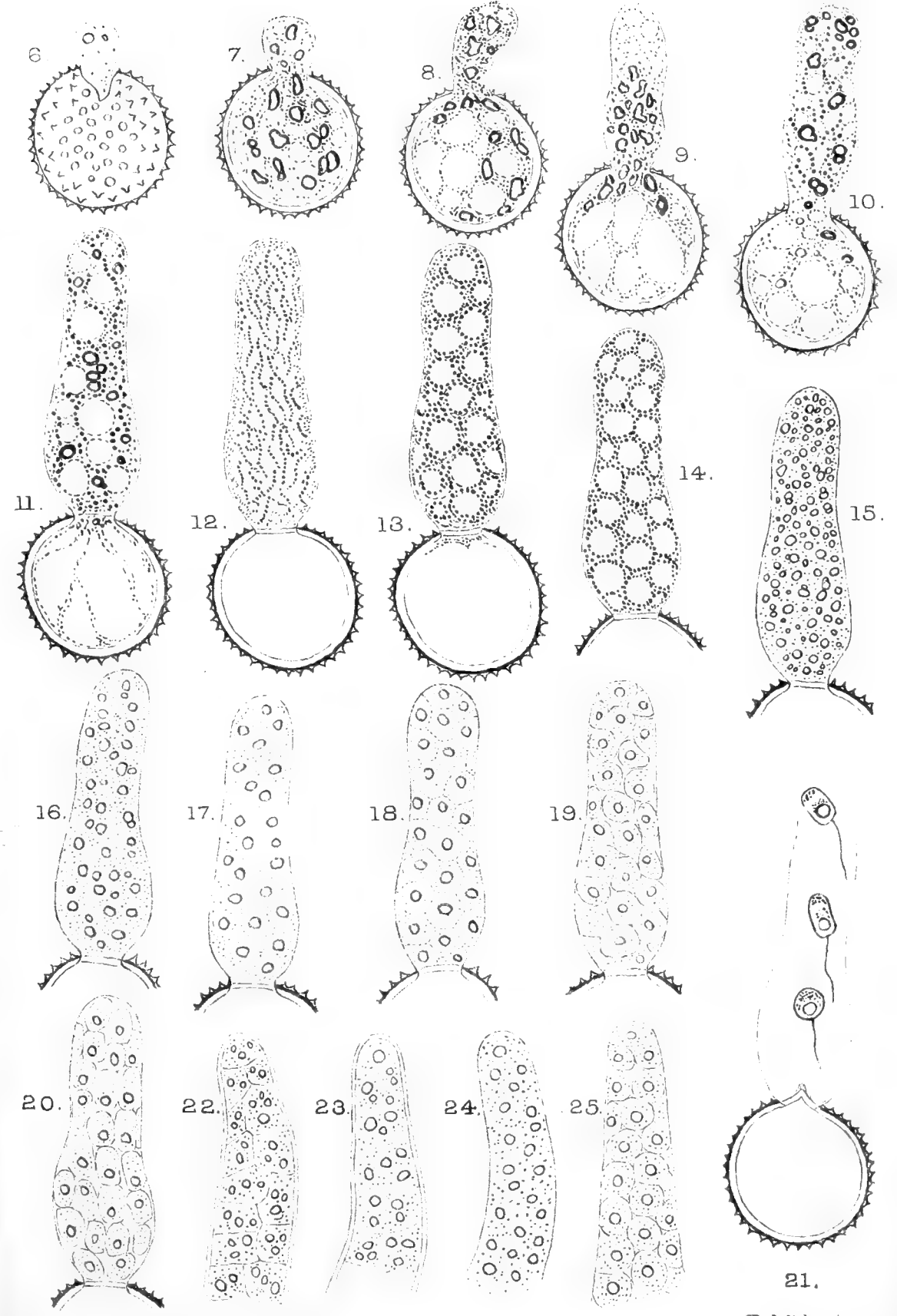

WAGER — POLYPHAGUS EUGLENÆ.

Huth lith et imp.





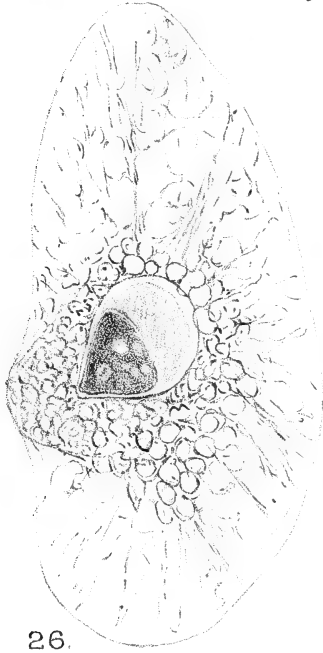

26.

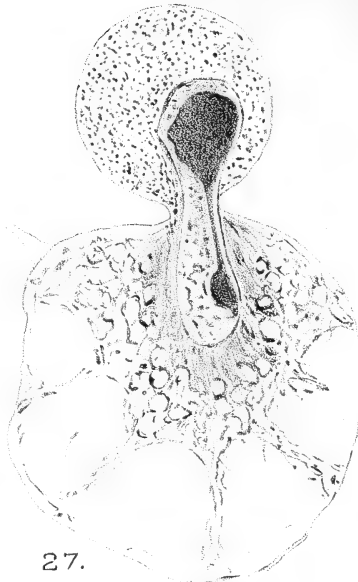

27.

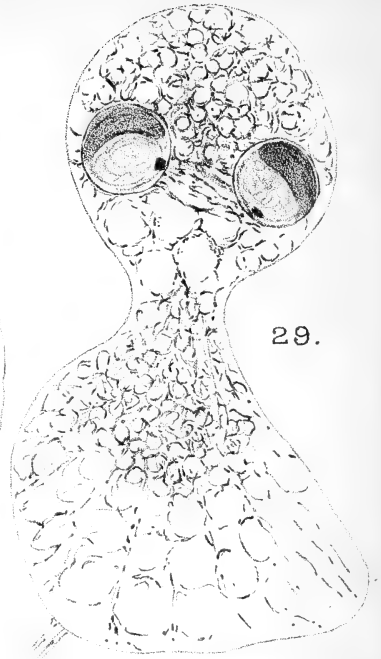

29.



30.

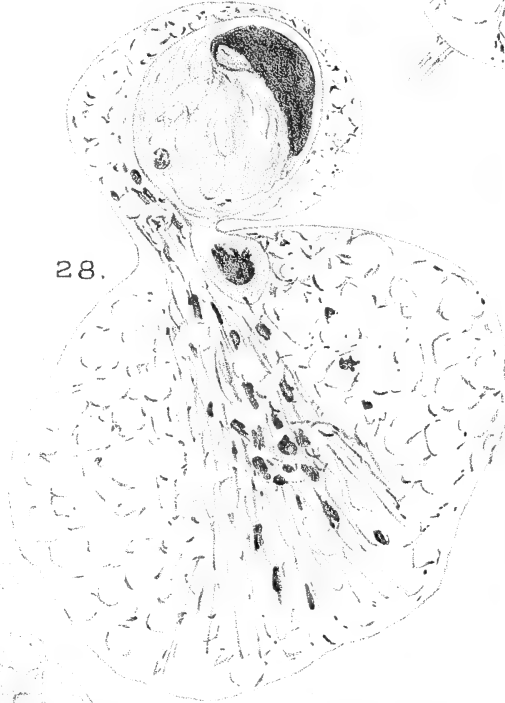

28.

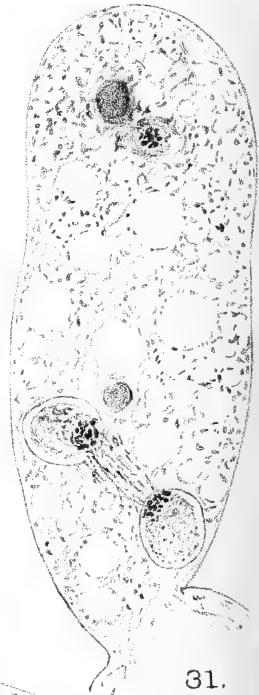

31.

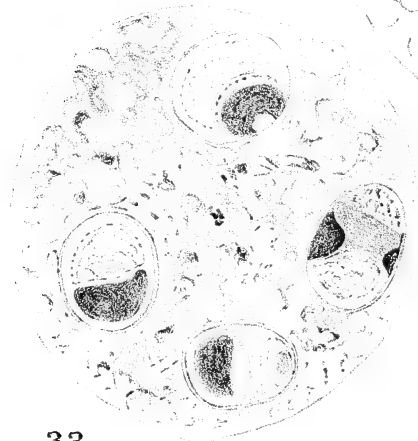

32.

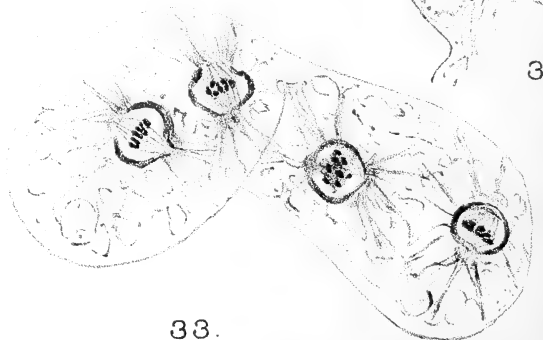

33.



34.

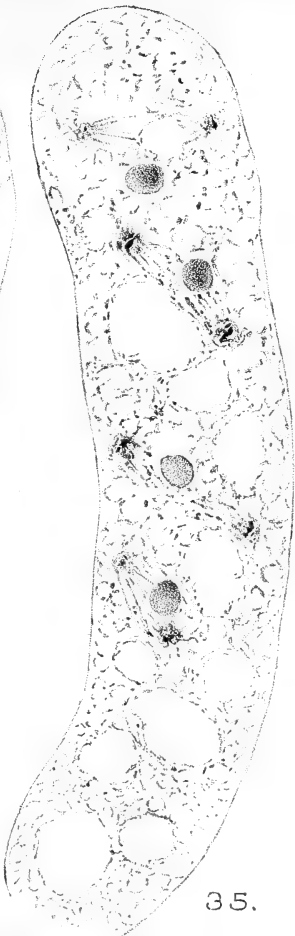

35.

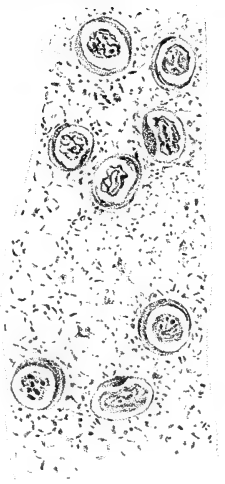

37.

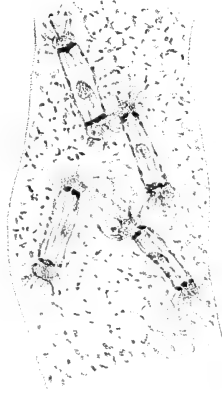

41.

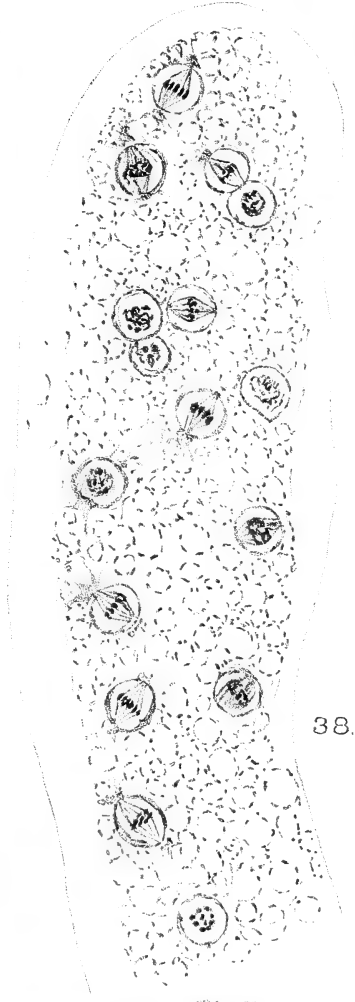

38.

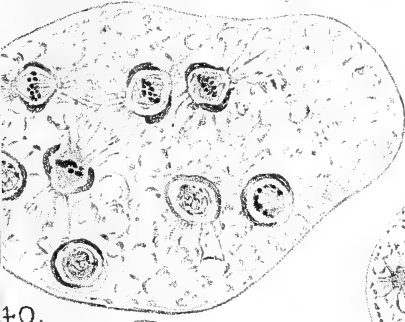

40.

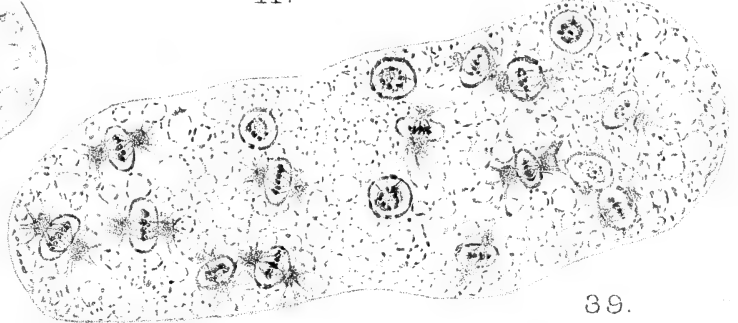

39.

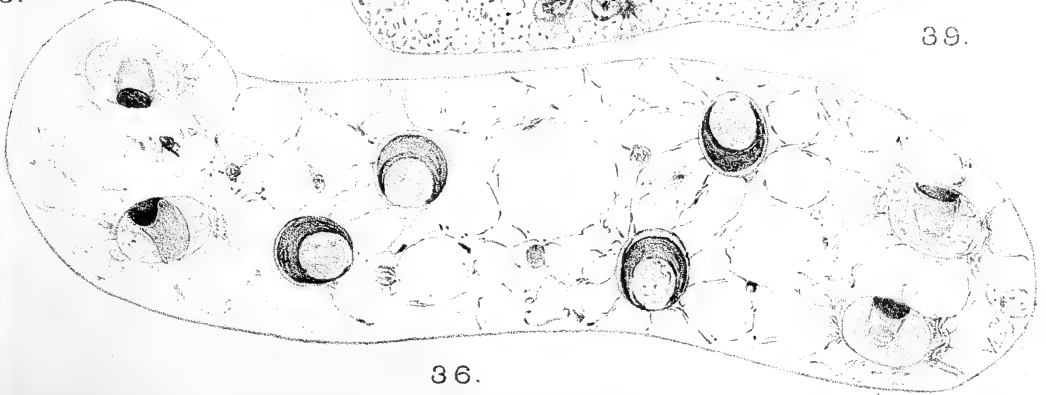

36.





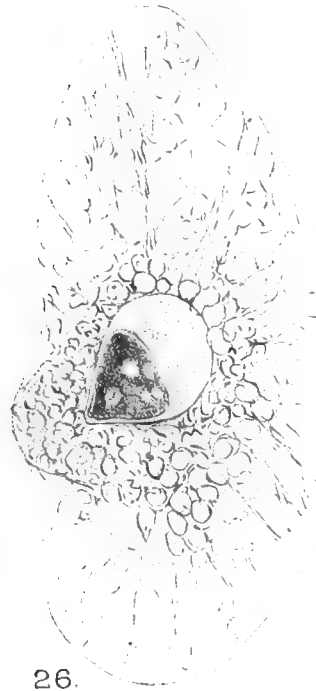

26.



27.

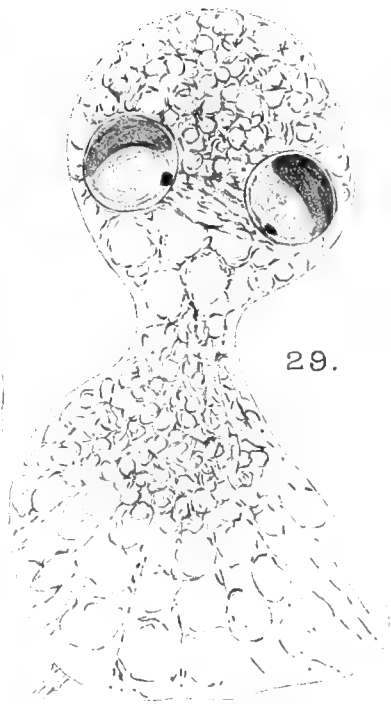

29.



34.

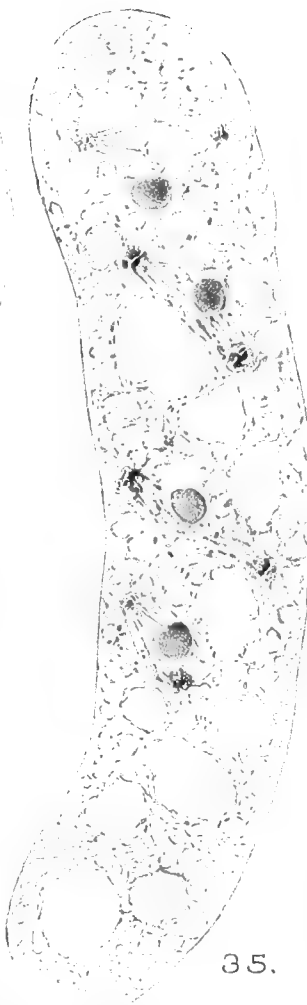

35.



37.

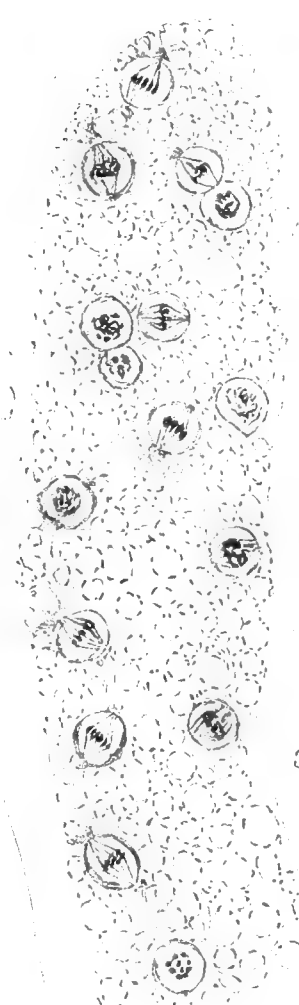

38.



30.



28.

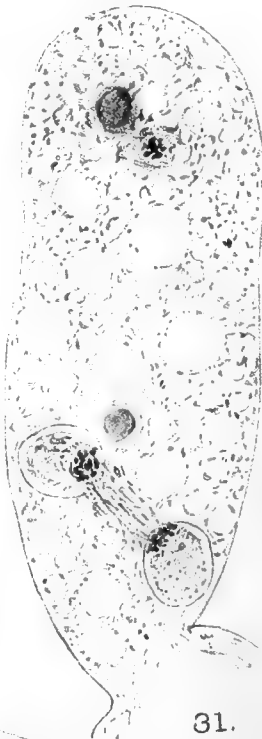

31.

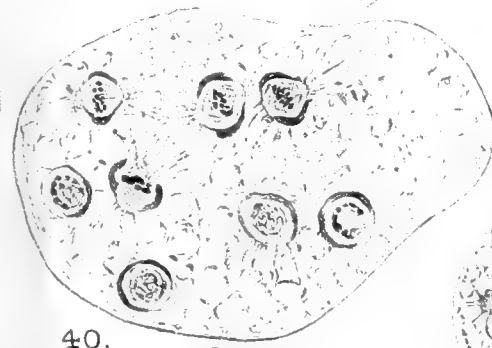

40.

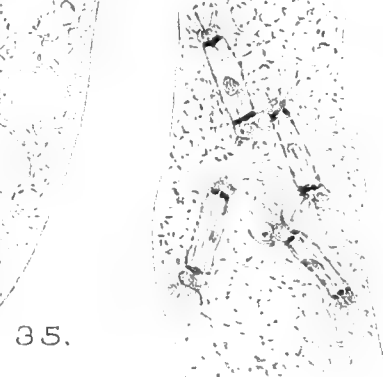

41.

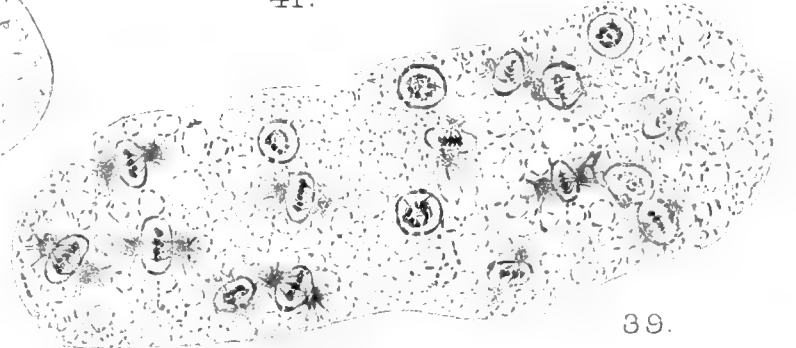

39.

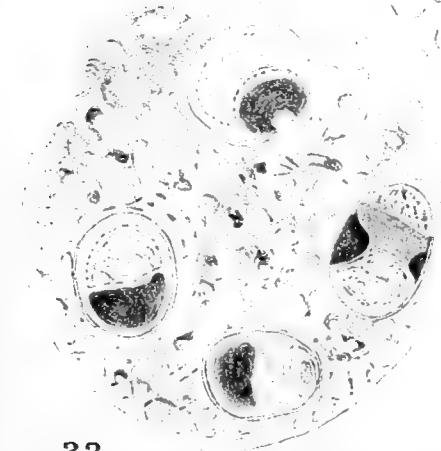

32.



33.

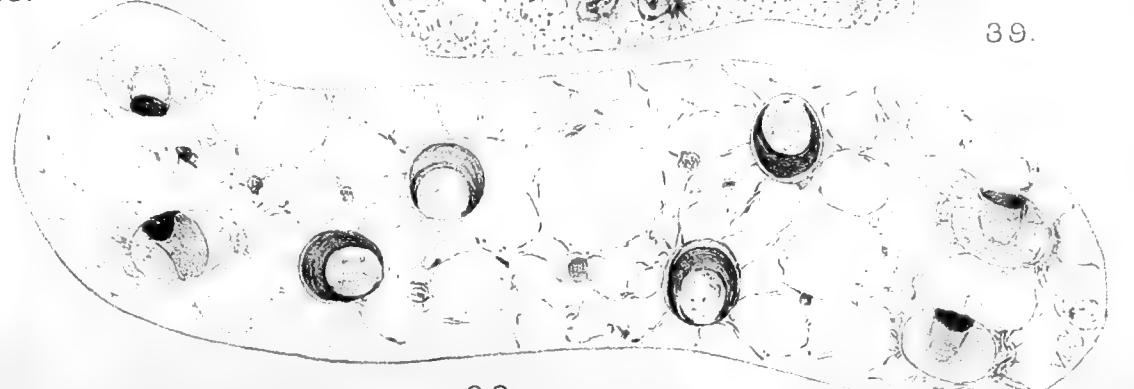

36.

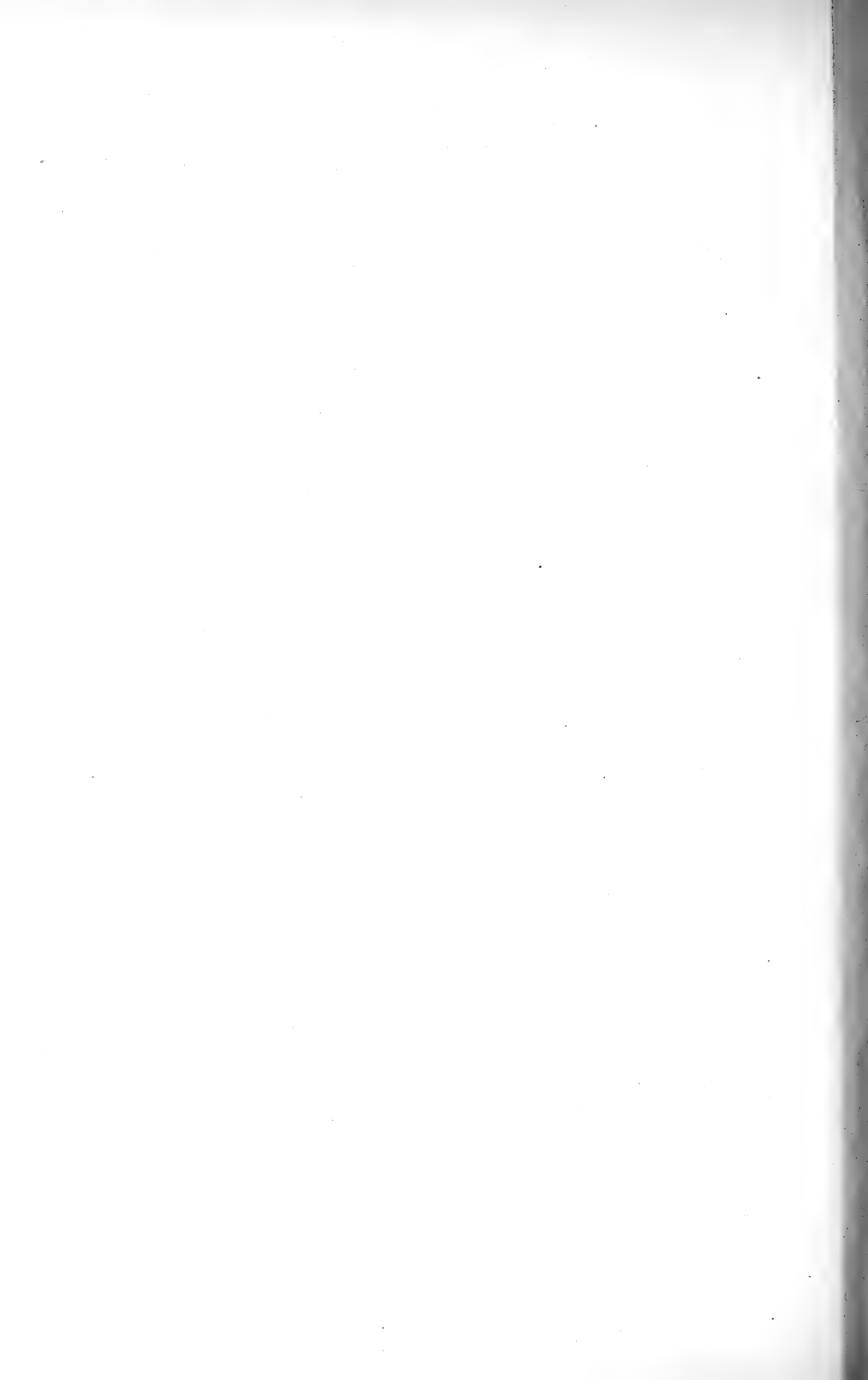



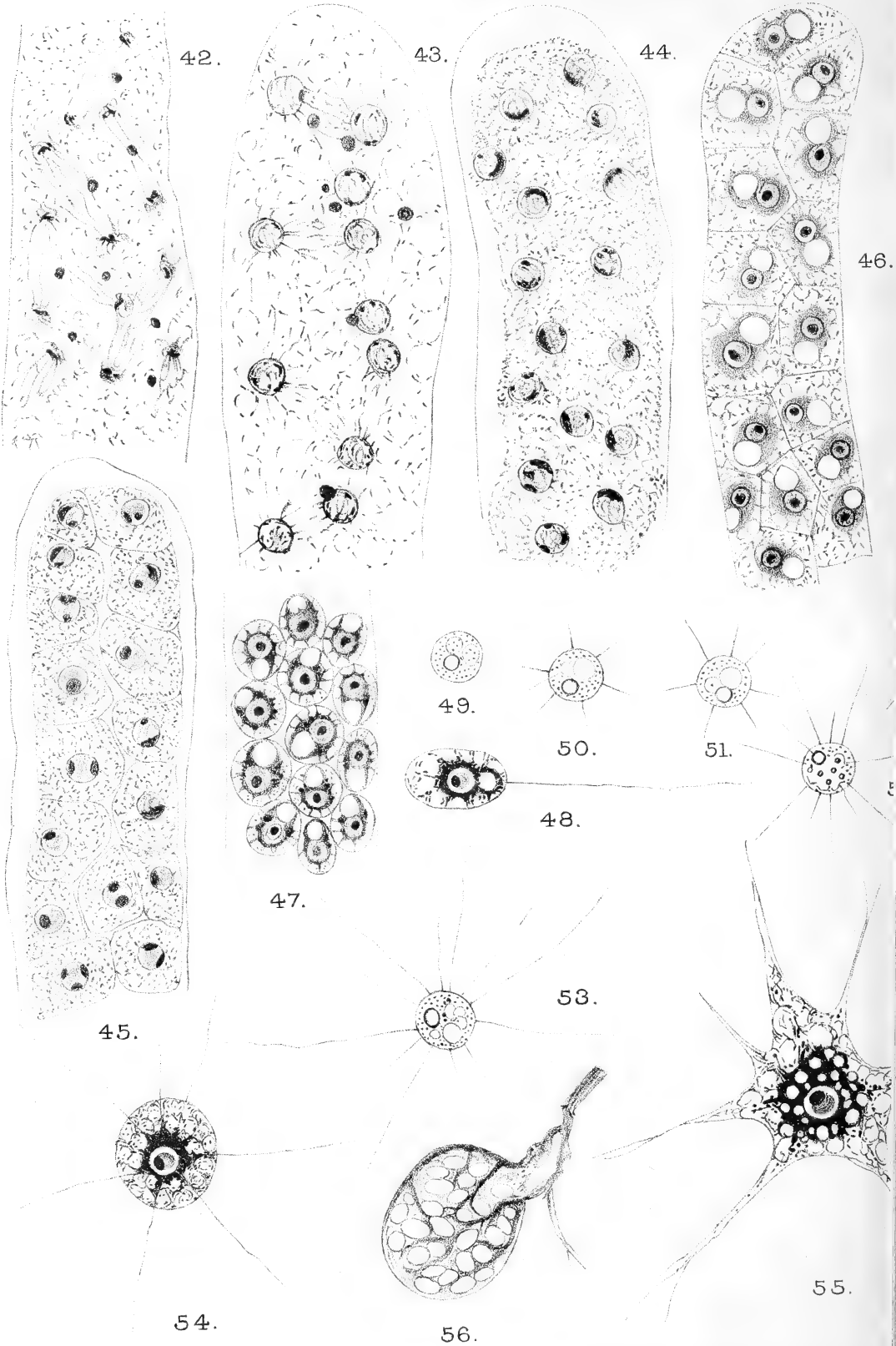

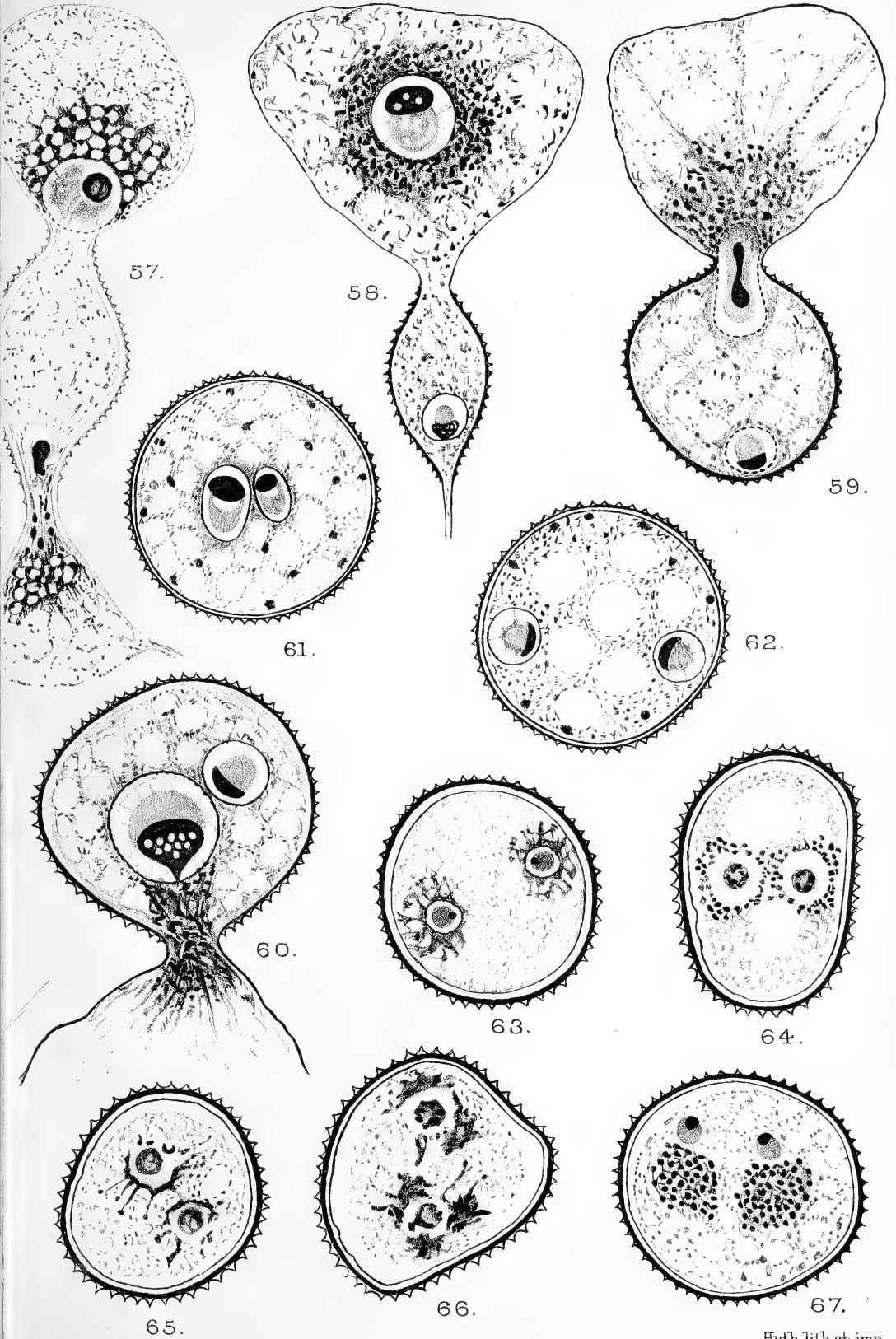



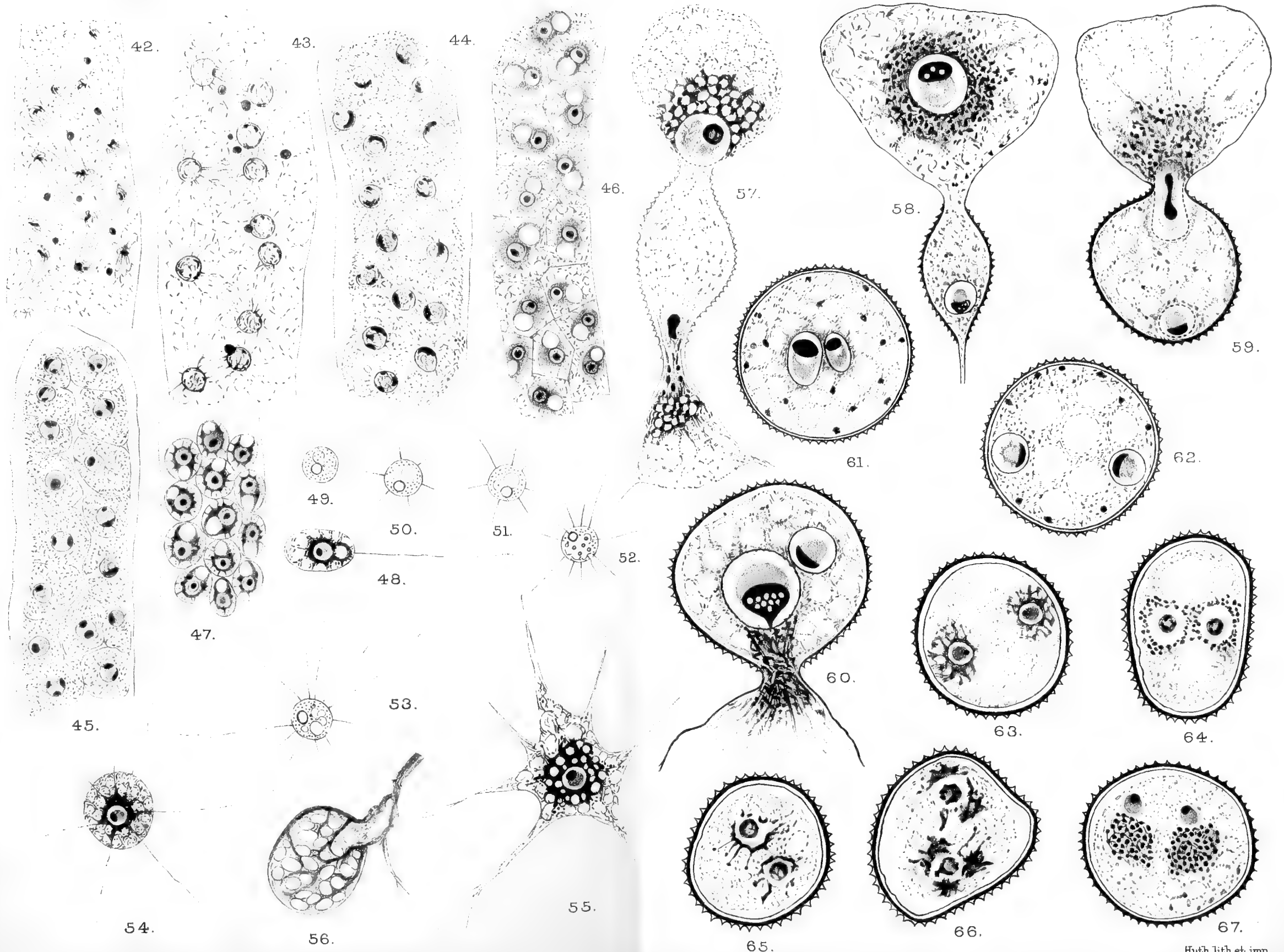

WAGER - POLYPHAGUS EUGLENAE





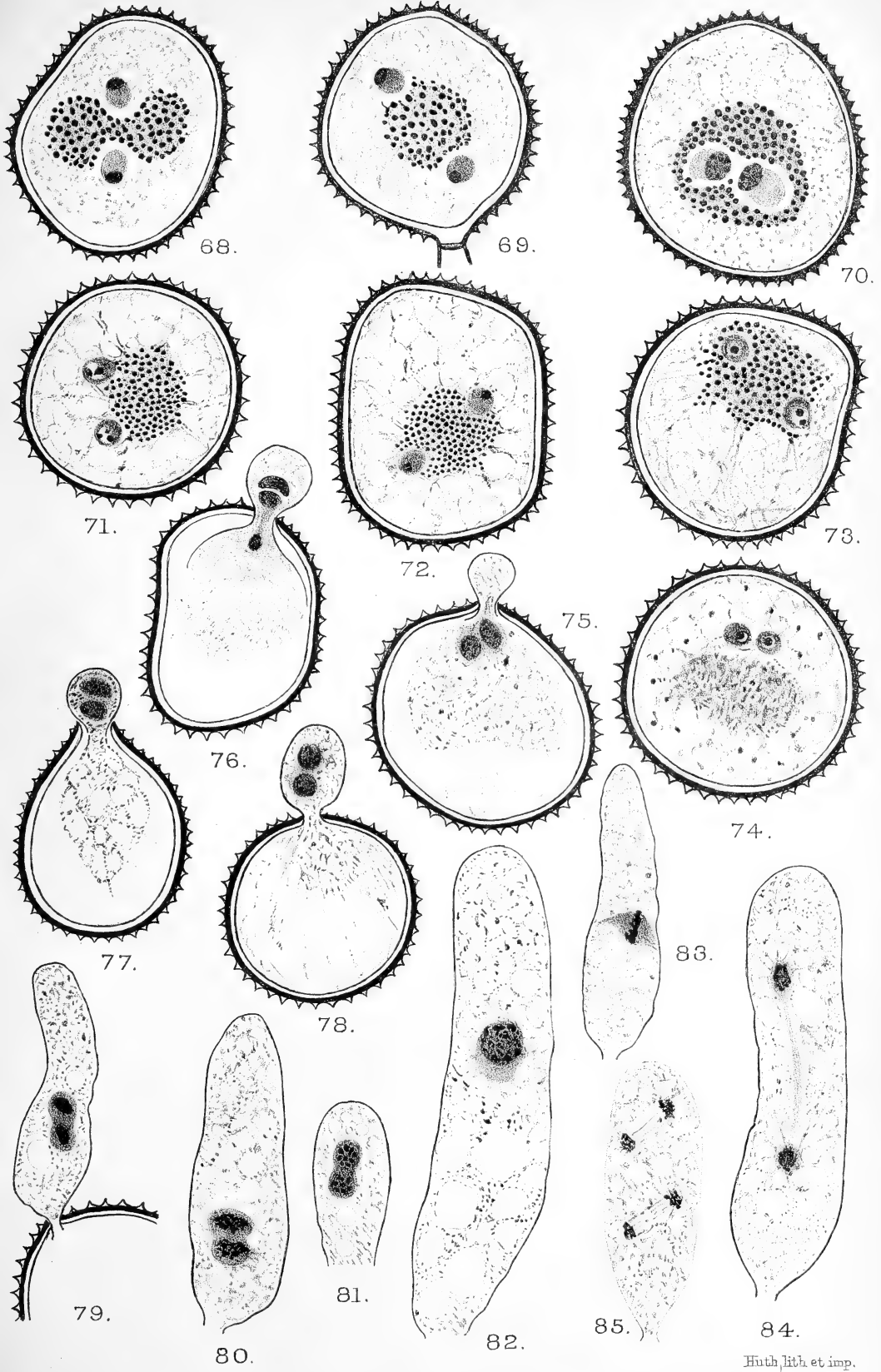

Huth lith. et imp.



# Studies in the Morphology and Anatomy of the Ophioglossaceae.

## I. On the branching of *Botrychium Lunaria*, with notes on the anatomy of young and old rhizomes.

BY

WILLIAM H. LANG, M.B., D.Sc., F.R.S.

*Barker Professor of Cryptogamic Botany in the University of Manchester.*

With Plates XX and XXI and fourteen Figures in the Text.

IN these studies some results obtained by the re-investigation of examples of all three genera of the Ophioglossaceae will be described. The affinities of this group of plants have long been a matter of doubt and dispute, but of recent years the evidence for the early view that the Ophioglossaceae are a primitive group of Ferns has been greatly strengthened. This has resulted less from their further study than from the increase of our knowledge regarding other primitive Ferns, both extinct and recent. While my study of the Ophioglossaceae has led me to hold this view as a highly probable working hypothesis, the object of these papers is not to expound it, but to examine in detail some facts which must be taken into consideration, whatever conclusion as to the phylogeny of the group is ultimately arrived at. It is hoped that this will be of assistance to investigators who are engaged in the study of extinct Ferns. The full discussion of results will be deferred until the last of these studies, but the bearing of particular points of interest will be briefly considered in each paper.

### EXTERNAL FEATURES.

The general morphology, anatomy, and life-history of *Botrychium Lunaria* are well known from the earlier researches of Braun, Roeper, Hofmeister, Russow, Holle, and others, supplemented by the study of various points of detail by later investigators. Familiar as our native species of *Botrychium* is in laboratory work, it is difficult to collect a complete account of the anatomy of its rhizome from the literature. More

attention has been paid to such larger species as *B. ternatum* and *B. virginianum*. Russow<sup>1</sup> studied *B. rutaefolium* (A. B. and Koch.), a form of *B. ternatum*, while the structure of *B. virginianum* is well known from the work of Jeffrey<sup>2</sup> and Campbell.<sup>3</sup> A knowledge of these species of the section *Phyllotrichium* does not, however, explain the structure of *B. (Eubotrychium) Lunaria*; this appears to be of special importance for the interpretation of the stelar anatomy in the genus.

The starting-point of my re-examination of *B. Lunaria* was the need of fuller information regarding the internal endodermis of this plant for comparison with *Helminthostachys*. The internal endodermis was described for young plants of *B. Lunaria* by Poirault<sup>4</sup> and Van Tieghem,<sup>5</sup> and while my work has been in hand Bower<sup>6</sup> has given a more detailed description than we previously possessed of this feature in the anatomy. Part of the present paper traverses some of the ground covered by Bower. The study of the progression in structure from the embryonic to the adult regions of the rhizome has led to the recognition of some new points in the structure of the stele and leaf-trace and to the investigation of the branching of the rhizome.

The description given by Hofmeister,<sup>7</sup> supplemented by the investigations of Bruchmann,<sup>8</sup> shows that the young sporophyte is attached to the subterranean prothallus by a fairly large foot. The first leaves have the form of small scales, and the first roots, corresponding to these, develop on a region of the stem, which remains very short. According to Bruchmann, elongation of the axis does not become marked until five or six roots have developed, and it is not until the eighth or tenth leaf that the plant appears above the surface of the soil. The detailed study of the anatomy and growth relations of very young sporophytes of successive ages would be of great interest, but lack of sufficient suitable material prevented me from attacking the problem in this way. Uninjured plants, however, even when of large size, retain at the base the first-formed region of the rhizome. The structure of this region can thus be easily studied and the transition to the adult structure followed.

When a number of plants are compared they are found to present considerable variety in external form. A number of roots are always attached close together at the lower end of the rhizome, and this *basal region* evidently bears the crowded roots that are such a conspicuous feature of the young sporophytes figured by Hofmeister and Bruchmann. Sometimes the transition to the thicker region of the rhizome with adult structure is a direct one; the diameter of the rhizome increases until the full size

<sup>1</sup> Vergleichende Untersuchungen, p. 119.

<sup>2</sup> Trans. Canad. Inst., vol. v, p. 265.

<sup>3</sup> Most recently in The Eusporangiatae, to which work reference may also be made for the general bibliography of the subject.

<sup>4</sup> Ann. Sci. Nat., Sér. 7, t. 18, 1893, pp. 169, 170.

<sup>5</sup> Journ. de Botanique, 1890, p. 405.

<sup>6</sup> Annals of Botany, 1911, p. 537.

<sup>7</sup> Higher Cryptogamia. Ray Soc., 1862, p. 307.

<sup>8</sup> Flora, 1906, p. 203.

is attained, but the leaf-scars and roots are closely crowded, and there is no appearance of specially elongated internodes. Often, however, an *intermediate region* is present between the basal and the adult regions; in this intermediate region the rhizome is slender and the leaf-scars and roots are distant. It is of variable length, being sometimes represented by one or a few internodes, while in other cases it attains a length of several inches and bears a considerable number of leaves. Possibly the occurrence of this slender elongated region, and its greater or less development, may be related to the depth of the parent prothallus beneath the surface of the ground. Above the intermediate region, when present, the rhizome increases in diameter rather suddenly and then maintains the greater diameter. In this *adult region* the leaves and roots are again crowded, and there is no appearance of internodes.

The distinction here made on the ground of external form between basal, intermediate, and adult regions of the rhizome has to be borne in mind in considering the anatomy. When the stelar structure is followed from below upwards the basal region is found to exhibit the transition from a solid protostele to a medullated stele. In the region above this a medullated stele with a distinct ring of primary xylem, but little or no secondary thickening, is met with. When the intermediate region is marked the leaf-gaps are frequently very long, and it is in this region that the internal endodermis discovered by Poirault, and recently re-described by Bower, may occur. A transitional region with increasing development of secondary wood around the primary xylem leads to the adult region; in this the much larger stele has a marked development of secondary xylem, the leaf-gaps are short and often overlap, and an internal endodermis is always wanting.

The nature of the secondary thickening in *Botrychium Lunaria* will be discussed with some other points of detailed anatomy below. It will be convenient first to consider the general progression in stelar structure from the basal to the adult regions of complete plants, the relations of the external endodermis to the internal endodermis when the latter is present, and the bearing of these facts on the nature of the pith.

#### PROGRESSION IN STELAR ANATOMY FROM THE BASAL TO THE ADULT REGIONS OF THE RHIZOME.

For the study of the vascular skeleton of *B. Lunaria* six small plants were cut into complete series of transverse sections. The results obtained by detailed examination of these plants are recorded in the accompanying reconstructions of the vascular system (Text-figs. 3-8). The results have been checked by less complete study of larger plants and by comparison with longitudinal sections. In this way it has been possible to analyse the facts in greater detail than was done by Bower in the paper in which he

directed attention to the problem of the medullation of the Ophioglossaceae. The facts to be described are in substantial agreement with his results, but they go beyond them and have led to somewhat different conclusions.

Before describing the six plants in order the relations of the endodermis to a departing leaf-trace as seen in transverse sections may be referred to. The ordinary type in the adult region is represented in Text-fig. 1, *a-d*. The earlier preparations for the departure of this trace are seen in Text-fig. 9, 20, 21; this shows how the xylem separates first on one side, and that

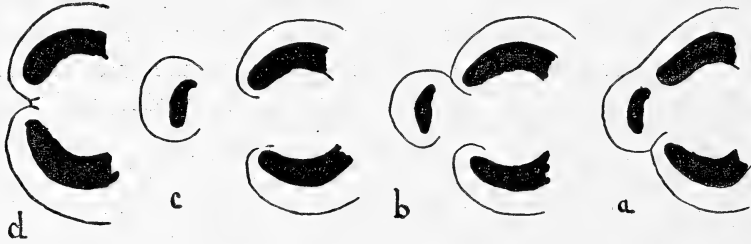

TEXT-FIG. 1. Endodermal relations in the departure of a leaf-trace from the adult region of the stele. Description in text.

a bulge in the endodermis indicates the commencing departure of the trace. This arc of endodermis accompanies the trace on its abaxial side (Text-fig. 1, *a b, c*). On the separation of the trace an open gap is left in the endodermis of the stele (Text-fig. 1, *c*), but the endodermis continues inwards on either side for a short distance round the margins of the gap in

the xylem. The interest of this particular node is that it shows clearly that the inward extension of the endodermis is evident before the external endodermis is interrupted (Text-fig. 1, *a, b*). In other cases this may not be obvious. The most natural way of regarding the extension of the endodermis seems to be as an assumption of endodermal characters by certain intrastelar cells and not as indicating an intrusion of cortex. This is more clearly shown in Text-fig. 2, which represents the departure of one of the earlier traces of plant A (cf. Text-fig. 3). In this case the new formation of endodermis appears as a reparatory band, completely bridging across the gap before the trace has actually separated. There is thus never an open gap in the endodermis. The adult type

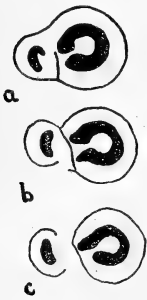

TEXT-FIG. 2. Endodermal relations in the departure of a leaf-trace with no gap in the external endodermis. Description in text.

may be placed in relation to this by regarding the new formation of endodermis to either side as corresponding to an incomplete reparatory band. These two types of leaf-trace departure do not exhaust the variety of endodermal relations found at the leaf-gap in *B. Lunaria*. Other examples where the process is complicated by the presence of an internal

endodermis are seen in Text-fig. 9, 5 and 12-14, and will be referred to later. This account will, however, suffice to make clear the longitudinal reconstructions, to the consideration of which we may now turn.

The conventions upon which the diagrams (Text-figs. 3-8) have been constructed must be borne in mind in making deductions from them. The diagrams represent the stele of the stem and the leaf-traces departing from it. Only the xylem and the endodermis are indicated, but it will be understood that conjunctive parenchyma, phloem, and pericycle come in order between the xylem and the external endodermis; phloem is wanting opposite the leaf-gaps and there is no internal phloem. The leaf-traces, which are really spirally arranged, are represented as if they formed two orthostichies and arose alternately. The level of origin of root-traces is indicated, but it must not be inferred that they arise vertically below the leaves as shown; for this reason the endodermis is not represented as disturbed by the root-traces. The position of the apex of the stem is indicated by a star, and the crosses in the leaf axils mark the position of vestigial lateral buds. The xylem of the stele and leaf-traces is represented as if seen in longitudinal section. So also is the external endodermis, which is represented by a line. The internal endodermis is supposed to be seen in surface view also, as if the stele were split in half; the extent of an incomplete internal endodermis can thus be represented. The surface view of the internal endodermis is dotted, and the slight inward extension of the endodermis round the margin of the leaf-gap is similarly shaded. When the internal endodermis was complete its section is represented by a line. The convention by which the endodermis is represented will be readily understood by comparing the reconstruction in Text-fig. 8 with the transverse sections of the same stele in Text-fig. 9. The diagrams were all constructed to the same scales, but the longitudinal and transverse scales are different, so that the stele is represented as broader in proportion to its length than is actually the case. Owing to its length, Text-fig. 7 has had to be reduced as compared with the other reconstructions.

All the six plants showed at the base a small stele with solid xylem. This basal region was complete in all except plant E, and with this exception all the plants showed the crowded first-formed roots. A number of roots were attached before any leaf-trace or leaf-gap was evident. From Bruchmann's account of the development of the sporophyte we may perhaps infer the existence of as many earlier scale-leaves as there are basal roots. If this is so, the lowest evident leaf-trace in these plants would not mark the first leaf; presumably the vascular tissue in the first developed scale-leaves was either absent or so small in amount that it did not affect the stele. In some cases it may have been displaced by the cortical growth and become unrecognizable; an example of this is seen in plant F, where, however, a corresponding leaf-gap is present in the stele.

In all six plants the solid xylem of the basal region becomes medullated a little below the first evident leaf-trace, but the plants present considerable variety in the transition from the basal region to the adult structure, and the differences are very marked in relation to the degree of development of an internal endodermis. While doubtless not exhausting the possible range of variation, these plants appear to afford sufficient data for a critical study of the nature of the internal endodermis in *B. Lunaria*. Plants A and B have no internal endodermis in their gradual passage to the adult



TEXT-FIG. 3. Reconstruction of the stele of plant A. Description in text.

structure. In plant C there is a deeper inward extension than usual of the endodermis at one long leaf-gap, but the internal endodermis is never complete. Plant D is similar to the preceding one, but the internal endodermis is completed for a short distance. In plants E and F there is a still more marked intermediate region in the rhizome, and the internal endodermis is complete for a considerable distance, not only at the leaf-gap, but above and below this.

In plant A (Text-fig. 3) the stele begins below with a slender solid strand of tracheides. In this, as it widens out, a small parenchymatous pith appears, and the medullated condition persists throughout the further growth of the plant. Before the preparation for the departure of the first recognizable leaf-trace is evident, five roots have been given off close together from the solid stele and lower portion of the medullated stele. No trace of any vascular supply to the scale-leaves, which were presumably related to these roots, was found. The first evident leaf-trace is very small, and dies out in the cortex a short distance from the stele; the second is only a small strand, but reaches the base of what was evidently a large scale-leaf. The third passes out from the stele as a considerable trace, while the fourth and succeeding traces are larger and probably supplied the first green leaves. The departure of the first three leaf-traces involves no breach in the external endodermis, a complete reparatory band of endodermis being formed internal to the departing trace (cf. Text-fig. 2). The fourth and following leaf-traces depart from the stele, which shows a marked increase in diameter, according to the adult type (cf. Text-fig. 1).

This is the plant described by Bower on p. 540 of his paper, and a section at the level of departure of the fourth leaf-trace is figured by



him to show the presence of tracheides mixed with the pith-cells.<sup>1</sup> It need only be added regarding this feature that tracheides occurred in the middle of the pith of the adult region of this plant close to the apex. Their position and that of the tracheides figured by Bower are indicated in the reconstruction. This plant is of interest as showing a direct and gradual transition to the adult type of stele without the intervention of any marked intermediate region. The leaf-gaps are all short, and below the adult region they are at once closed by endodermis. There is nothing in the structure of the plant or in the endodermal relations to suggest that its pith is in any way due to intrusion of cortex, while the position of the tracheides in the pith seems direct evidence against this.

Plant B, the stele of which is reconstructed in Text-fig. 4, shows a direct and even more rapid transition to the adult type of stelar construction; in it also there is no internal endodermis and nothing suggestive of cortical intrusion throughout the whole plant. The slender solid strand of xylem at the base of the plant increases in diameter on passing upwards; scattered parenchyma cells appear in it and then a definite pith is established. Four roots are attached close together in the region below the first leaf-gap. The small leaf-trace in relation to this dies out in the cortex, and the leaf-gap closes at once; unfortunately the endodermal markings were not very clear, but the relations appeared to be similar to those at the lower leaf-gaps of the preceding plant. On the closure of the leaf-gap a root-

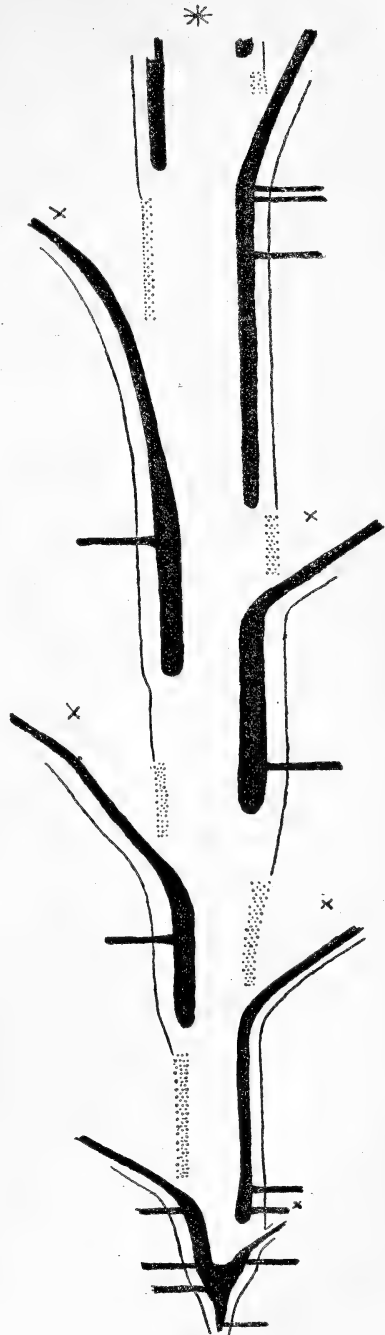

TEXT-FIG. 4. Reconstruction of the stele of plant B. Description in text.

<sup>1</sup> Bower, loc. cit., Pl. XLV, Fig. 10.

trace arises from the stele to one side of the position of the gap, followed by a second from the other side of the stele. The next leaf-gap opens in the xylem ring and a small trace departs. The endodermal relations at this and the succeeding leaf-gaps are of the adult type, in that a gap remains for some

distance in the endodermis, the edges of the latter being continued round for a short distance. After the trace has separated from the stele a root arises from the latter to one side of the gap. It is unnecessary to follow this plant node by node, as the relations are evident from the reconstruction. The stele is relatively bulky and the primary xylem thick, the same type of leaf-trace departure is maintained, and shortly after the separation of each trace one or two root-traces arise from the stele. There is thus evident a certain segmental regularity in the relations of roots and leaves, which is also shown more or less distinctly in the other plants.

In plant C (Text-fig. 5) the solid xylem strand increases in diameter and bears several root-traces. About the level of the fourth root parenchyma appears in the centre of the stele and is continuous with the outer conjunctive parenchyma of the stele at what must probably be regarded as the first leaf-gap, although no leaf-trace passes off. Above this the xylem of the medullated stele is again completed, and two root-traces pass off. The leaf-trace which passes off from the second leaf-gap dies out in the cortex, while the third trace reaches a leaf. The endodermis is completed preparatory to the departure of both these traces. The third gap in the xylem remains open for some distance, and when it closes preparations for the fourth leaf-trace are evident. The departure of this trace is very gradual and the leaf-gap is correspondingly elongated.

TEXT-FIG. 5. Reconstruction of the stele of plant C. Description in text.



Before any interruption of the external endodermis an incomplete internal endodermis appears. This forms two strips extending from either side of the incipient trace; on the separation of the latter the internal endodermis becomes continuous on either side with the margins of the gap in the

external endodermis left by the departure of the leaf-trace. The condition is thus much as in the adult region, except that the endodermis is continued much more deeply into the pith. At no level, however, is the internal endodermis complete. When the external endodermis forms a complete ring, and before the gap in the xylem closes, the endodermal markings within the stele cease. The next leaf-trace is much larger, its departure follows the adult type, and the leaf-gap is short. The stele has now become wider and the zone of xylem thicker, with indications of secondary growth. This plant thus shows an imperfect internal endodermis associated with one extended leaf-trace departure.

Plant D may be described very briefly, since, as Text-fig. 6 will show, it only differs in one essential point from the preceding plant. Here also the first leaf-traces are small and the endodermal relations at the leaf-gap conform to the adult type. The interest of this plant lies in the slow departure and the long leaf-gap left by the third leaf-trace. This constitutes the specialized intermediate region. After the xylem of the third leaf-trace has separated from the rest of the xylem, but before any interruption of the external endodermis, endodermal markings appear on the radial walls of cells within the arms of the horseshoe-shaped xylem of the stem. This internal endodermis is at first quite unconnected with the external endodermis. As the leaf-trace separates and the external endodermis is interrupted, these bands of internal endodermis become continuous with the free ends of the gap in the outer endodermis. This then appears to extend deeply into the pith, lining the tube of xylem, but not forming a complete internal endodermis. The condition is thus the same as in the long leaf-gap of the preceding plant. On passing further up the gap in plant D, however, the internal endodermis does become complete for some distance.

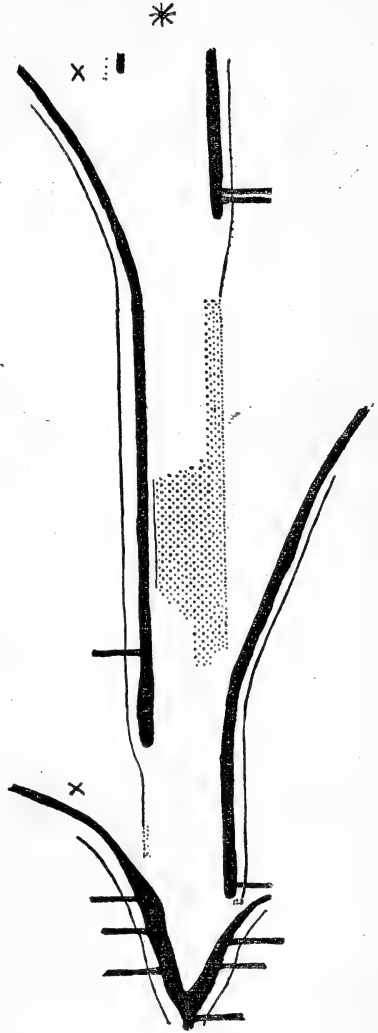

TEXT-FIG. 6. Reconstruction of the stele of plant D. Description in text.

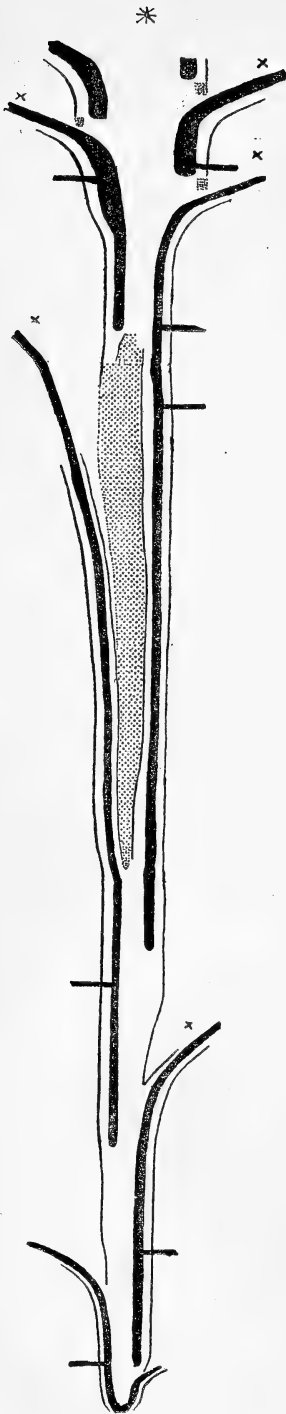

TEXT-FIG. 7. Reconstruction of the stele of plant E. Description in text.

Still further up, the endodermal markings disappear from the cells lining the inner portion of the concavity, and only the slight inward curves of endodermis usual in the adult type of leaf-gap are found. The endodermal gap then closes, and shortly afterwards the xylem ring. Thus the plant resembles plant C, except in that the internal endodermis becomes complete for a short distance in the elongated leaf-gap.

Plant E is the longest plant that was studied in complete series, and a glance at the reconstruction of the stele (Text-fig. 7) will show that a fairly extended intermediate region is formed by the very gradual departure of one leaf-trace, while above this came a rapid transition to the adult region. Owing to its length, this reconstruction has had to be reproduced on a somewhat lower scale than the others of the series. The base of this plant was imperfect, and, although the transition from a stele with solid xylem to one with a pith could just be followed, it is clear that at least one and probably a number of roots are missing from the base. The first recognizable leaf-trace dies out as soon as it leaves the stele. The next two are larger and the leaf-gap in the xylem more extended, but in all these three leaf-trace departures the endodermis is completed before the departure of the trace, and there is no gap in the endodermis. Owing to the place of development of the reparatory band of endodermis, there is an appearance of dipping-in opposite the leaf-gap; this dip is soon lost, the endodermis becoming convex outwards, and its explanation does not involve the need of 'pocketing'. In the third leaf-trace the endodermis is also completed around the trace itself. Shortly after the departure of this trace and before the gap in the xylem has closed the usual root is attached, and a little higher up the origin of the fourth leaf-trace, which is the interesting feature of this plant, commences. The departure of this trace is extremely gradual, and as soon as its position is evident in the

xylem ring the internal endodermis appears. This soon forms a complete ring, as seen in transverse sections, but the first appearance of the endodermal markings is irregular and the internal endodermis does not form a closed pocket at the lower end. As the distance widens between the leaf-trace and the xylem of the stele, both being still enclosed by the external endodermis, endodermal markings appear on the walls of cells connecting the outer and inner endodermal layers. Thus on the separation of the leaf-trace, first on one side and then on the other, both the trace and the vascular tissue of the stem have complete endodermal sheaths. That of the stem consists of the external endodermis connected round the margins of the leaf-gap with the internal endodermis. Above the departure of the leaf-trace first one and then another root-trace arises from the stele. At the upper end of the leaf-gap the incurved ends of the external endodermis approximate, and this again becomes a complete and independent tube. The internal endodermis persists for a short distance as an imperfect tube, but all endodermal markings have disappeared from the pith before the gap in the xylem closes. Above this remarkable leaf-insertion the stele increases in diameter, and the xylem ring is thicker and shows secondary thickening. A number of leaf-traces are given off with comparatively short intervals between them, the endodermal relations at their departure, like the general features of the stele, being of the adult type.

The last of the six plants (Plant F) shows much in common with the preceding specimen. Its structure is illustrated by the reconstruction of the stele (Text-fig. 8) and by the series of selected transverse sections in Text-fig. 9. The numbers 1-21 refer to the slides of this series, on each of which an equal number of sections was mounted; where the changes were rapid and several sections from one slide are figured they are distinguished by letters, e.g. 2 *a*, 2 *b*, 2 *c*, 2 *d*. Comparison of this series of sections with the reconstruction will make the relations of this rather complicated plant clearer, and will also show the general nature of all the reconstructions.

The first root was in line with the base of the stem, and the stele of the root when followed up passed into the solid core of xylem of the stem stele (Text-fig. 9. 1). This increased in diameter and showed a zone of tracheides radiating from a central group; a root is attached in this region (2 *a*). Parenchyma appears mingled with the central tracheides (2 *b*) and soon forms a distinct pith (2 *c*, 2 *d*). After two roots have been attached a small leaf-gap with no evident departing trace forms in the xylem ring, but a trace is recognizable close to the periphery of the cortex, having apparently been separated by the cortical growth (Text-fig. 9. 3. Compare the reconstruction, Text-fig. 8). When this gap has closed, two roots, one of which is shown in Text-fig. 9. 3, arise from the stele. Then another root-trace arises (4 *b*), and immediately above this the second leaf-trace separates (5, 6).

While the first leaf-gap is closing and the second is forming, an internal endodermis appears in the pith. It is at first incomplete (4a), but soon becomes a complete tube (4b). The external and internal endodermis become

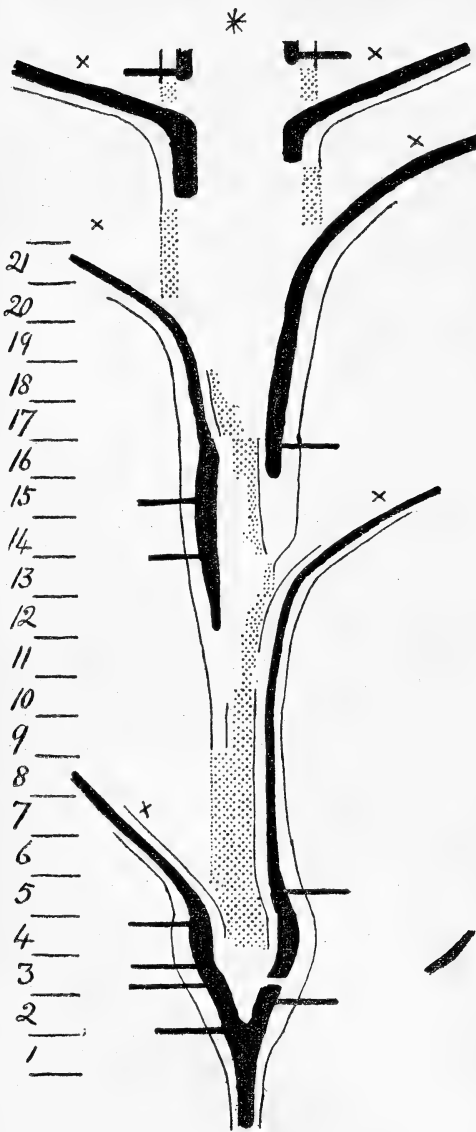

TEXT-FIG. 8. Reconstruction of the stele of plant F. Description in text. The divisions on the left correspond to the numbers in Fig. 9.

continuous as the second leaf-trace separates (5, 6). As the trace departs a root is given off from the stele to one side in the usual fashion (5). The second leaf-gap is a long one. The gap in the external endodermis remains open for some distance (6, 7) and then closes, the external endodermis again becoming a complete tube (8, 9). The internal endodermis is for some distance a complete tube (9), but then becomes incomplete (10-18). Before the second leaf-gap in the xylem closes the third gap opens (11, 12), the internal endodermis being present as an incomplete arc opposite to the new gap. As the preparations for the departure of this leaf-trace advance, endodermal markings appear on the cells bridging across from the internal to the external endodermis. Then the trace separates (13a, 13b) with a complete sheath of endodermis, the adaxial portion of which is continuous below with the internal endodermis; the external endodermis at the leaf-gap is continued inwards for a short distance by the side portions of the arc of internal endodermis (13b). The outer endodermis almost at once becomes continuous across the gap (13c),

and at this level a root-trace is attached, followed by another on the other side of the gap (15). The third gap then closes in the xylem ring, and the fourth leaf-trace prepares to separate (14-16). The next root-trace is attached

to one side of the incipient fourth leaf-gap (16, 17). The internal endodermis, which has persisted as a more or less incomplete layer (13 c-16), now becomes localized as an arc internal to the departing fourth leaf-trace (17, 18). It then dies out and plays no part in the actual departure of

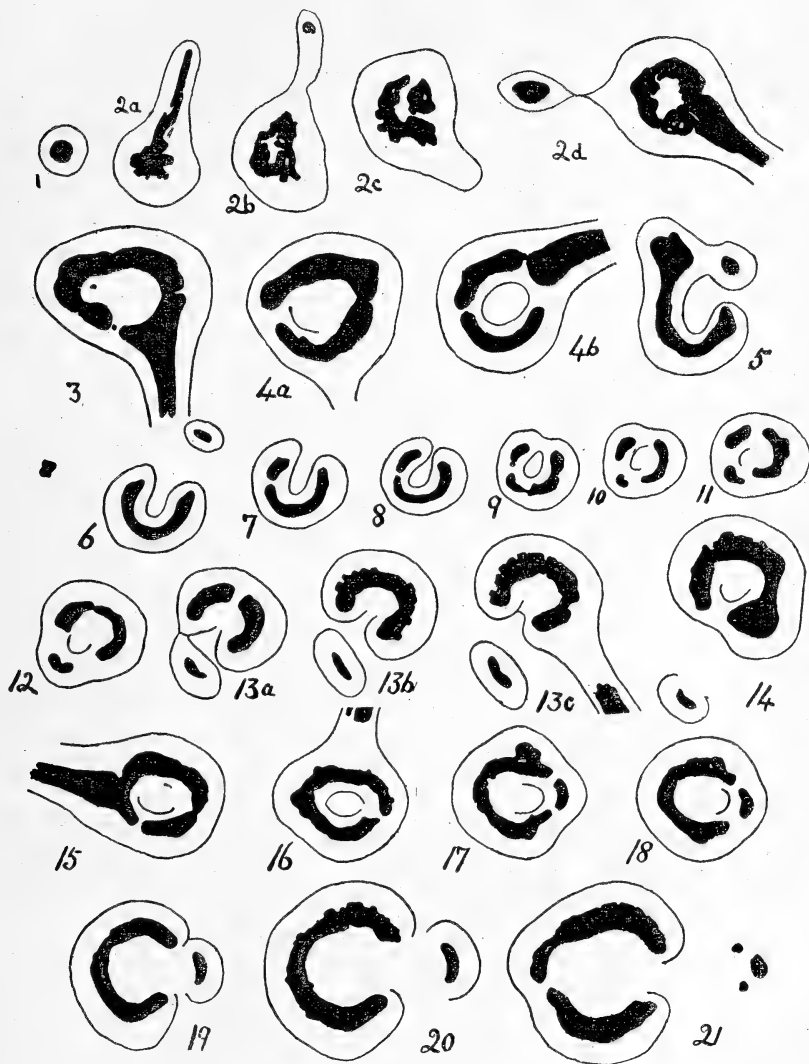

TEXT-FIG. 9. Selected transverse sections of plant F, showing the progressive changes in the stele and the endodermal relations from the basal to the adult regions. Description in text.

this trace (19, 20), which follows the adult type, as do all the succeeding leaf-traces. Three traces depart in rapid succession, and then two roots are borne just below the meristematic region of the plant.

This plant has thus a marked intermediate region between the basal

and adult regions. In the intermediate region a more or less complete internal endodermis is present, extending over the origin of three leaf-traces. The distribution of the internal endodermis, which can be followed from the series of cross-sections and the reconstruction (Text-fig. 8), does not lend support to the idea of pocketing at the leaf-gaps. It is limited to the slender intermediate region, while in other respects the medullation of the stele does not differ from what is found in the regions below and above. Both the transverse sections and the reconstruction show how, after the stele has widened from the base of the plant (1-4), its diameter decreases greatly in the intermediate region (6-12) and then increases again till the uniform diameter of the adult region is attained (19-21).

Comparison of the vascular systems of these six small plants of *B. Lunaria* allows of a number of conclusions being drawn with tolerable certainty. On the whole, the distribution of the leaves and roots suggests a repetition of corresponding segments of the plant body whatever the ultimate explanation of the segmentation may be. Usually one or two roots are inserted on the stele close to the sides of the leaf-gap just after a leaf-trace has separated. There is not, however, a rigid relation of roots to leaves, for a number of leaf-traces may be given off without any corresponding roots. It may further be noted that it is difficult to distinguish nodes and internodes in *B. Lunaria*. When a long internode appears to be present this is found to be due to the extension both of the region in which the trace is gradually separating from the stele and of the leaf-gap left on the separation of the trace. Both these regions may be regarded as belonging to the leaf-base. The result attained is, however, the same as if definite nodes and internodes were present; the longitudinal extension of the shoot is increased, and the individual leaves are more widely separated. In this way the distance between a departing leaf-trace and the nearest roots below may be greatly increased, as is seen most clearly in the fourth leaf-trace of plant E.

All the plants showed a similar transition from a stele with a solid xylem to one with a pith. The appearance of a pith in the stele was never associated with the presence of an internal endodermis, and the transition from the basal region to the typical adult structure may be a direct and gradual one without the development of an internal endodermis in any region. The transition to the adult type of relation of leaf-trace to stele may take place close to the base of the plant (Plant B), or a number of the lower leaf-traces may depart without leaving endodermal gaps (Plant A). In both these cases, while there is a gradual increase in the size and complexity of the stem and its stele, there is no specialized intermediate region to be distinguished.

The development of an internal endodermis appears to be associated with the presence of a definite intermediate region, in which there has been



greater growth in length with extension of the leaf-trace departures and leaf-gaps. There may be an absolute decrease in diameter of the stem and stele as compared with the region below (Plant F), and in any case there is delay in assuming the full diameter of the adult region. In the plants selected for detailed examination the intermediate region only involved one or a few leaf-bases, but in other specimens it had a length of some inches. It appears as if intercalated between the basal and adult regions, possibly to bring the apex of the plant more rapidly to the proper depth below the surface of the soil.

The degree of development of an internal endodermis in the intermediate region varies, as comparison of plants C, D, E, and F shows. The endodermal markings appear before the leaf-trace has separated and (like the reparatory band of endodermis formed in the departure of the early leaf-traces) the internal endodermis seems to be a new formation. While transverse sections in which the external and internal endodermis are continuous show the appearance of an endodermal pocket described by Poirault and Bower, the reconstructions make clear that this appearance does not establish the existence of intrusive pocketing. In no case was a completely closed pocket found. Comparison of the mature structure of these plants thus leads to the conclusion that the internal endodermis, when present, is a new differentiation in the pith, and is of no morphological significance as indicating a limit between stele and cortex.

The development of the stele from the apical meristem will not be dealt with in this paper. It may be said, however, that this has been carefully examined and no direct evidence in favour of an actual intrusion of tissue into the stele at the leaf-gap has been obtained. Since the distribution of the endodermis when critically considered does not support the view of pocketing of the cortex into the stele, and direct evidence from the developing region is against any such readjustment of the tissues, it seems justifiable to conclude that the internal endodermis of *Botrychium Lunaria* is a new differentiation within an intrastelar pith. The association of the internal endodermis with the long leaf-insertions of the intermediate region suggests a physiological advantage in its presence, for it is found in regions in which there are long intervals between the roots and leaves.

#### SOME DETAILS OF THE VASCULAR ANATOMY OF THE RHIZOME.

The general construction of the vascular skeleton of the rhizome of *Botrychium Lunaria* has been considered in the preceding section. In this portion of the paper the structure of the stele in different regions of the stem will be described, especially as regards the xylem, and an account given of the structure of the leaf-trace until it enters the petiole. Further, the occasional development of xylem as a result of cambial activity

occurring in the pericycle will be recorded, and the resulting pericyclic wood described for both the stem and leaf-trace.

The stelar structure in the various regions of the rhizome is most readily appreciated from transverse sections. The chief features of interest concern the xylem, and it will be sufficient to state at the outset that conjunctive parenchyma, sieve-tubes, pericycle, and endodermis are found in the order named outside this. The staining and photographic processes have been directed to demonstrating the xylem as clearly as possible, but the other tissues of the stele are well seen in Pl. XX, Phots. 16, 17, as they occur in a stele of fair size without marked secondary thickening. It will be convenient to commence with the structure of the xylem in the definitely medullated stele, deferring the consideration of the transition from a solid to a medullated xylem till afterwards.

The stele represented in cross-section in Pl. XX, Phot. 1, is typical of a more or less extensive region of the rhizome after medullation has taken place. The wide pith is surrounded by a continuous tube of xylem two or three tracheides in depth. This I regard as primary xylem. No protoxylem is present, except when a leaf-trace begins to be recognizable, and then the endarch xylem of the trace corresponds to an arc of the primary xylem. Judging by the relative position of the protoxylem of the leaf-trace the primary xylem of the stem can be described as centrifugal; the question whether centripetal primary xylem can be recognized will be considered below. There is typically no cambium or secondary xylem, and the occasional radial arrangement of the tracheides can be accounted for by the direction of the divisions in the procambium. The stele shown in Phot. 1 has no internal endodermis, but it is quite characteristic of the intermediate region of the rhizome, where an internal endodermis may occur. The more bulky steles in Phots. 16 and 17 are similar in that the xylem is practically all primary, but the zone of primary xylem is thicker.

The transition to the thicker adult region of the rhizome may be gradual, but often takes place rather suddenly, especially when a marked intermediate region has been present. It is then associated with the beginning of secondary thickening of the xylem, though not due to this. Phot. 2 shows the structure in the transition region. The ring of primary xylem, which was alone present in the stele represented in Phot. 1, is seen around the pith, but active divisions have evidently gone on in the region immediately outside the primary xylem and an irregular zone of secondary wood has been developed. The incompleteness of the secondary xylem brings out the distinction between it and the primary wood.

In the light of these sections the structure of the stele in the fully adult region will readily be understood. This is represented in Phot. 3, and small portions of the vascular ring from two distinct plants are shown in Phots. 4 and 5; the latter figures are to the same scale of magnification

as Phots. 1, 2, 16, 17, while Phot. 3 is less highly magnified. It will be evident that the diameter of the stele has greatly increased, and also that the zone of xylem is much thicker. Next the pith comes a continuous zone of primary xylem, which is best seen in Phot. 4, and outside this the secondary xylem. The two facts that the secondary tracheides are in regular radial rows, and that the medullary rays are confined to the secondary wood, and therefore do not extend to the pith, enable the distinction between primary and secondary xylem to be readily made in *B. Lunaria*. The secondary tracheides are wider and rather shorter than those of the primary xylem. This is seen in Pl. XXI, Phot. 22, which is, however, selected to show another feature of the stele.

While primary and secondary xylem can thus be distinguished in *B. Lunaria* some qualification is necessary as to the sense in which the term secondary xylem is used. The succession indicated by the steles in Phots. 1, 2, and 3 is that found in the extended ontogeny of the plant. At the level of each section the stele was complete, and under normal conditions of growth no additions would be made to the xylem. Even in the case of the large stele of the adult region, with its well-marked zone of secondary xylem, the secondary thickening is not progressive. The tracheides of the primary xylem are the first to be lignified behind the apex, but the tangential divisions in the procambial cells outside the primary xylem are in main part completed close to the apex. What happens in the region somewhat further back is the maturing and lignification of the elements thus arranged in radial rows and forming the secondary xylem. The secondary thickening in this case thus appears to be an arrangement to increase the amount of xylem in the primary construction of the stem, and does not proceed indefinitely. The justification of the comparison of the secondary thickening in *B. Lunaria* with that of the higher plants is, however, clearly shown by the power of the meristem to resume the active addition of new elements to the xylem under special circumstances. A good example of this will be described below in one of the branching plants (Text-fig. 14).

The fact that in a considerable region of the rhizome all the xylem actually formed may be primary explains the divergent statements found in the literature regarding *Botrychium Lunaria*, since, according to the region of the rhizome examined, there may appear to be marked secondary thickening or none. On account of the importance of the memoir in which it appears, it seems advisable to specifically correct the recent statement by Campbell<sup>1</sup>, that 'in *Eubotrychium* the cambium is absent, and apparently there is no secondary increase in diameter'.

The further question as to whether, in addition to the centrifugal primary xylem distinguished above, any representative of the well-marked centrifugal xylem found in *Helminthostachys* can be recognized in *B. Lunaria*,

<sup>1</sup> The Eusporangiatae, p. 102.

will be best dealt with by returning to the structure of the stele in the basal region. The strand of xylem at the extreme base of the plant is very slender, but soon becomes a thicker though still solid strand as it is traced upwards (Phots. 6, 7). It is composed of a small central group of irregularly arranged tracheides surrounded by a zone of tracheides that show a tendency to radial arrangement. I was at first inclined to interpret this as a centrarch structure, regarding the central tracheides as representing the protoxylem. Further study has not supported this interpretation, nor does it seem necessary to regard the radial arrangement of the peripheral tracheides as evidence of their being secondary xylem. It is sufficient and more useful for comparative purposes to distinguish the central and peripheral xylem in this region of the stele. At a slightly higher level (Phot. 8) parenchymatous cells appear among the tracheides, and, as described and figured by Bower, soon form a small pith in a central position. The pith forms in the central xylem (Phot. 9), and elements of this can usually be detected at the inner edge of the tube of xylem just after the pith has been initiated. The appearance of the pith is related to the first leaf-gap in the sense that, when this forms, the pith and the parenchyma outside the xylem become continuous, but there seems no evidence for the pith being derived by intrusion either of the outer conjunctive parenchyma or of the cortex.

The difficulty of arriving at a definite conclusion as to whether the central as well as the peripheral primary xylem is present in the expanded medullated stele higher up the rhizome is owing to the fact that protoxylem is only present in the leaf-traces entering the stele. Thus in the rest of the stele the protoxylem is wanting as a guide to the possible distinction of centripetal primary xylem from centrifugal primary xylem. It has been shown above that practically all the xylem of such a medullated stele as that represented in Phot. 1 is to be regarded as primary centrifugal xylem. But indirect evidence from several sources points to the existence of central or centripetal primary xylem also; as the question is of some importance the evidence will be stated fully.

While the inner surface of the tube of primary xylem abutting on the pith is often quite regular and only occasional tracheides could be suspected of belonging to the central xylem, this is not always the case. Thus in the stele represented in Phots. 16 and 17 the inner surface of the xylem is very irregular, and the groups of tracheides projecting into the pith are open to the suspicion of representing the central xylem. This is even more the case when, as often happens, a tracheide is met with separated from the xylem tube by one or several parenchymatous cells. A case of this kind is figured by Bower from one of the small plants reconstructed above, and, as stated previously, isolated tracheides developed in the centre of the pith of the adult region of this plant. The reconstruction in Text-

fig. 3 will show the position of these, and should be compared with the figure in Bower's paper.<sup>1</sup> The distinction of such irregular tracheides near the periphery of the pith from the outer primary xylem is strengthened when the departure of the leaf-trace is taken into account. The trace, at its departure, is always endarch, and the central tracheides disappear internal to it. But the position of the protoxylem of the nascent trace agrees with the distinction here drawn between outer and inner primary xylem in the rest of the xylem ring (cf. Phot. 16).

The distinction of the outer and inner xylem is also brought out in the mode of departure of some of the earlier leaf-traces from the small medullated stele. The endarch leaf-trace departs from the outer xylem only, so that where the inner xylem is fairly represented it bridges across the gap left by the departing trace. This is shown in Phot. 10, where a tracheide separates the pith of the stele (on the left) from the parenchyma adaxial to the small trace, the xylem of which is just about to separate. In Phot. 11 the same stele is shown a few sections higher up. The xylem of the trace has separated, but the pith is completely shut off from the leaf-gap in the outer xylem by a bridge of tracheides of the central xylem.<sup>2</sup> A similar case to Phot. 10 is represented in Fig. 12, Pl. XLV of Professor Bower's paper, though not interpreted in the same way. Such a case as shown in Photos. 10, 11 at once suggests comparison with those Osmundaceae in which the leaf-trace 'pocket' is shut off from the pith by the inner tracheides of the xylem, and it is possible to interpret the appearances described and discussed by Gwynne-Vaughan<sup>3</sup> in the seedlings of *Osmunda* on these lines. How close the comparison is will be clear from the four sections of another plant of *B. Lunaria* at successively higher levels in Photos. 12-15. In Phot. 12 the xylem of a small leaf-trace is about to depart from the stem stele. The prominent group of parenchyma immediately within the trace is not the pith of the stele. This is represented by the small group of parenchyma more to the right. A little higher up the pith of the stem stele has disappeared, and the solid xylem now consists of a group of central xylem surrounded by peripheral xylem. The xylem of the leaf-trace, now separated from that of the stele, has departed in a protostelic fashion at the expense of the peripheral xylem only. That this interpretation is correct is shown by the higher section (Phot. 14), in which the pith of the stele has

<sup>1</sup> Annals of Botany, xxv, Pl. XLV, Fig. 10.

<sup>2</sup> While there was nothing abnormal about this plant, which was studied in a complete series, the lower region of the stele, as shown in Photos. 10 and 11, presented one remarkable feature. An external endodermis was present in the usual position, separated by one layer of cells (the pericycle) from the phloem. In addition to this another cylinder of cells, with the usual endodermal markings on the radial walls, was present some three layers of cells further out in the cortex. Such an anomalous development of endodermis has a bearing on the possibility of new formation of endodermis in *Botrychium*.

<sup>3</sup> Loc. cit., Pl. XLIV, Figs. 3, 4.

commenced to reappear and from now on persists and enlarges. Not till the level reached in Phot. 15, where the small leaf-trace is dying out in the cortex, does the pith communicate with the leaf-gap parenchyma. The relations in this case are essentially similar to those described by Gwynne-Vaughan in *Osmunda*. The plant from which Photos. 12-15 were taken was further of interest in that after the stele had expanded to a medullated stele like that shown in Phot. 16, it again contracted and had scattered tracheides in the small pith.

It was pointed out above that occasionally tracheides may be developed in the pith of normal plants. A more extreme case of the same kind was met with in a small injured stem, which bore a branch. This will be described later on, and it is sufficient to refer to the reconstruction of this specimen (Text-fig. 11), to the series of transverse sections (Text-fig. 10), and to Phot. 31. These show that the development of tracheides internal to the position of the protoxylem had led to this region of the stem possessing a veritable mixed pith of tracheides and parenchyma.

The analysis of the xylem of *Botrychium Lunaria* in different regions of the rhizome thus leads to the recognition of secondary xylem, centrifugal (peripheral or outer) primary xylem, which is constantly present, and centripetal (central or inner) primary xylem, which is more or less clearly indicated. This brings the construction of the primary xylem of *Botrychium* into line with that of *Helminthostachys*, where centrifugal and centripetal primary xylem are well marked. That the centripetal xylem of *B. Lunaria* when present usually disappears opposite a departing leaf-trace and takes no part in its formation only strengthens the comparison with the centripetal primary xylem of *Helminthostachys*.

The leaf-trace of *Botrychium Lunaria* is usually and correctly described as departing from the stele of the stem as a single endarch strand of xylem, accompanied on its abaxial side by conjunctive parenchyma, phloem, pericycle, and endodermis in the same succession as these tissues are found in the stele of the stem (Photos. 3, 16, 17). On passing from the stem into the leaf-base the single trace divides into two strands (Phot. 21), which become inclined so as to face one another. The leaf-trace, however, exhibits considerable variety in its construction, and some of the main features observed will now be referred to.

When the stele of the stem has marked secondary thickening, the leaf-trace on its separation shows, outside the arc of primary xylem, secondary tracheides arranged in radial rows and separated by medullary rays. This secondary xylem diminishes in amount and disappears as the leaf-trace nears its departure from the stem (cf. Photos. 3, 20). From this point onwards the xylem of the leaf-trace is altogether primary, and is continuous, when traced downwards, with the primary xylem of the stem stele. When the trace departs from a stele without secondary

thickening its xylem is of course wholly primary from the beginning (Phots. 16, 17).

No trace of centripetal xylem has been seen to the inside of the leaf-trace when it separates from the stele of the stem,<sup>1</sup> even when the latter shows remains of the central xylem (Phots. 16, 17). The protoxylem of the departing trace abuts directly on the medullary parenchyma. The layer of cells to the inside of the xylem-ring can often be distinguished as of different appearance from the other cells of the pith, and this layer of cells is always clearly recognizable on the adaxial face of the xylem of the departing leaf-trace. As the trace separates the next layer of cells may assume endodermal characters, and so complete the endodermis of the leaf-trace adaxially (Phot. 18). Whether a complete endodermis is present or not the adaxial parenchyma can be recognized as a part of the leaf-trace; it usually increases by cell-division as the trace departs, so that the outline of the latter becomes oval. As the trace widens out on its passage through the cortex it assumes a rather flattened C-shape, the concavity being filled up or lined by the adaxial parenchyma. No phloem has been observed on the adaxial face of the leaf-trace.

The most interesting variant of the usual structure of the leaf-trace as described above is the development of tracheides on the adaxial side of the protoxylem; indications of these are found in most cases, and sometimes the adaxial xylem is well marked. The metaxylem of the trace then appears to curve round at the two ends, while more scattered tracheides are developed across the adaxial face of the trace joining the two ends (Phots. 18, 19). The adaxial tracheides are seen in longitudinal section in Phot. 20. The adaxial xylem is most marked when the trace is passing through the cortex of the stem, but occasional tracheides have been met with after the trace has entered the petiole and divided. A common state of affairs is for only a slight adaxial extension of xylem to take place at the two ends of the trace. This may probably be related to the tendency of the xylem of the trace to form a hook, as is shown in Phots. 21 and 27.

Such leaf-traces might be described as mesarch, but it is questionable whether this is a sufficient or right interpretation. It has been pointed out that the trace is never truly mesarch at its departure, the central xylem, if present, disappearing before the trace departs. It is, of course, possible to regard the adaxial xylem in the trace as a reappearance of the central or centripetal xylem, in which case the trace would be truly mesarch. But it seems to be better regarded as due to a more or less complete adaxial extension or completion of the centrifugal xylem of the trace; this produces a trace the xylem of which has the form of a ring enclosing more or less parenchyma. It should be mentioned that, even when the endodermis and xylem are thus completed, no corresponding completion of the phloem has

<sup>1</sup> Except in the case of one branching plant described below (Text-fig. 14).

been observed. The interpretation of these leaf-traces suggested here is supported by the fact that when truly mesarch leaf-traces are met with in *Helminthostachys*, the adaxial completion of the centrifugal xylem may also take place and the two processes be clearly distinguished.<sup>1</sup>

The interpretation of the leaf-traces of *Botrychium Lunaria*, as derived from the outer xylem of the stele only, is supported by the distribution of the xylem in small steles, which are giving off leaf-traces (cf. Phots. 10-11, 12-15). It need only be added to what was said above regarding these figures that the xylem of such small leaf-traces may show a solid and apparently mesarch structure due to the completion of the metaxylem adaxially.

It is not uncommon to find that the adaxial xylem becomes separated from the rest of the leaf-trace on nearing the periphery of the stem, as is shown in Text-fig. 9. 21. The main portion of the leaf-trace then passes out into the base of the petiole, while the adaxial xylem appears to die out in the cortex. The separation appears to be due to the active divisions at the periphery of the rhizome, associated with the development of periderm, affecting the old leaf-trace as it traverses this region. I was at first inclined to regard this disposition of the adaxial xylem as indicating a vestigial vascular supply to the vestigial axillary buds to be described below. While, however, the adaxial xylem of the trace would naturally be concerned in the supply of these buds, and may in a sense be related to their presence, the separation of the adaxial xylem from the main body of the trace is brought about secondarily, and it seems impossible to attach significance to it.

There remains for description the occasional development of xylem elements as a result of cambial activity starting in the pericycle. This was found both in specimens that had branched and in a normal unbranched rhizome. In Pl. XXI, Phot. 23 a portion of the stem stele of the rhizome bearing the branch represented in Phots. 32-34 is more highly magnified. The xylem is primary and only about four tracheides deep; outside it and separated by conjunctive parenchyma comes the phloem, the small sieve-tubes of which are clearly seen. Outside the sieve-tubes radial divisions, which had resulted in the development of a number of short lignified tracheides, are seen to have taken place in the pericyclic cells. The same thing had happened in the adult rhizome, a portion of which in radial section is represented in Phot. 22. From right to left this shows the pith, the primary xylem, secondary xylem, and cambium; outside this lies a crushed and darkly stained sieve-tube, and just outside this a zone of tissue derived from active periclinal divisions in the pericycle. From the inner segments thus cut off groups of short tracheides have developed. In this case there appears to be no disturbing reason for the development of pericyclic xylem, as there

<sup>1</sup> Cf. Lang, Proc. Manch. Lit. and Phil. Soc., vol. lvi, Pt. II, p. 5, Figs. 3, 4.



may be in the case of a developing branch making special demands on the water-supply from the main axis. In Fig. 24 the lower region of the leaf-trace, which subtended the branch in the branching specimen, is shown in transverse section. In it a complete arc of pericyclic xylem has been formed on the abaxial side. This, as will be shown, was not continuous with the pericyclic xylem of the stem, and did not directly contribute to the supply of the branch. This description, along with the figures, will serve to put on record an anomalous development for which I know no parallel in the Filicales.

#### VESTIGIAL AXILLARY BUDS AND BRANCHING OF THE RHIZOME.

The plants of *Botrychium Lunaria* that come under observation are usually unbranched. In 1859, however, Roeser<sup>1</sup> described and figured rhizomes bearing numerous lateral branches, and in 1875 Holle<sup>2</sup> gave a brief account with a diagrammatic figure of the only branch he had met with. Bruchmann<sup>3</sup> states that he had found a dozen examples of branching, and that young plants appeared to be more liable to branch than older ones. He does not enter into the anatomy of the branched plants, but describes and figures the origin of lateral growing points. While regarding these as the initial stages of the development of branches, he makes no remarks on their frequency or their constant relations to the leaves. Bower<sup>4</sup> placed Bruchmann's observations on *B. Lunaria* in relation to the axillary structures previously described in *Helminthostachys* by Gwynne-Vaughan,<sup>5</sup> and interpreted by him as vestigial lateral buds. It may be added that Velenovsky figures a branched specimen of *B. matricariaefolium*, and that Campbell records a case of branching in *B. lanuginosum* due to the apex having been destroyed and two lateral shoots developed as adventitious buds. I have communicated a note on the branching of the Ophioglossaceae to the Proceedings of the Manchester Literary and Philosophical Society,<sup>6</sup> and examples in all three genera will be described in these studies.

The study of complete series of sections through small plants, and of transverse and longitudinal sections of older and larger rhizomes, has shown that a structure comparable to the vestigial bud of *Helminthostachys* is of practically constant occurrence in every leaf-axil of *Botrychium Lunaria*. The position of these vestigial buds, wherever recognized, is indicated by the crosses in the stelar reconstructions (Text-figs. 3-8). In *Botrychium*, as in *Helminthostachys*, the structure is not obviously bud-like, but in both plants its nature is established by the occasional development of actual branches in the corresponding position.

<sup>1</sup> Bot. Zeit., xvii, 1859, p. 257, Taf. XII.

<sup>2</sup> Loc. cit., p. 226, Taf. II, Figs. 60-62.

<sup>3</sup> Ann. of Bot., xvi, p. 170.

<sup>4</sup> Bot. Zeit., xxxiii, 1874, p. 301, Taf. III, Fig. 4.

<sup>5</sup> Land Flora, p. 443, footnote.

<sup>6</sup> Feb. 20, 1912.

In the examples most clearly comparable to *Helminthostachys*, a canal or slit extends downwards and inwards from the axil of the leaf. Usually the outer portion of the slit is completely occluded, and no trace of it is evident passing through the periderm. The inner portion of the slit is always recognizable, and though it does not extend so far towards the stele as in *Helminthostachys*, it exhibits a similar slight curvature forwards at the inner end. The cells bounding the side of the slit away from the apex of the stem have the same glandular appearance as was noted by Gwynne-Vaughan in *Helminthostachys*; these cells, which often break down in preparations, extend round to the inner end of the canal. There is a more or less marked projection of the tissue of the inner wall of the slit, i. e. of the surface belonging to the stem, into the concavity of the canal. The cells forming this projection are small and have a healthy appearance. The general relations of the whole structure to the leaf-trace and the regions as described above are shown in the two longitudinal sections (Phots. 25, 26). Phot. 28 shows the position of the vestigial bud in relation to the leaf-gap and the subtending leaf-trace, the section passing through the base of the vestigial bud below the level of the canal. Phot. 27 is a similar section of a larger stem less highly magnified; it passes through the slit leading down from the leaf-axil.

While this description and these figures serve to show the appearance and structure of these vestigial buds, the position of the actual apex is still a matter of doubt, and the detailed consideration of this question must be postponed. I incline to regard the apex as being situated either at the inner end of the slit or towards the leaf-base, and not to be represented by the more marked projection of tissue from the stem side of the slit. Comparison with other species or the study of buds in a more active state will be necessary to clear up this point. It is clear, however, that the slit represents a shut-in portion of the external surface of the shoot, and the whole structure may be appropriately compared, as was done by Bower, to the sunken, shut-in, and often dormant buds of *Equisetum*.

Four plants of *Botrychium Lunaria*, which bore developed branches, have been studied by means of successive transverse sections, and in another example the base of a lateral branch was seen in longitudinal section. In every case the apex of the main axis had been destroyed, and at a greater or less distance behind it a vestigial bud had developed to produce a branch, by means of which the growth of the plant was carried on; in one specimen two vestigial buds had thus been developed. In the example of a lateral branch described and figured by Holle, the vascular supply was derived from the adaxial side of the leaf-trace and not from the stele of the main stem. The general position of all the branches I have studied agrees with this, but their vascular connexions exhibit differences of detail which make it necessary to describe all the examples. The variations found are of

interest for comparison with other Ferns, and especially with *Helminthostachys*.

The structure and vascular relations of the first branched specimen will be readily understood from the transverse sections at different levels (Text-fig. 10), together with the reconstruction of the stele (Text-fig. 11). Three transverse sections at different levels are shown in Photos. 29-31. The reconstruction of the vascular skeleton is to the same scale as those of the unbranched plants above. The outline cross-sections are, however, drawn to a slightly smaller scale, and show the cortex as well as the stele. The branch was evidently borne on a small plant the apex of which had been destroyed. The stele of the main axis is small, and at the level where the series begins shows the leaf-gap left by the departing trace, to which the branch is related. This leaf-gap has a deeply extending, but incomplete, internal endodermis (Text-fig. 10, *a*); this diminishes in extent before the gap in the endodermis closes (*b, c*). The endodermis of the departing leaf-trace becomes complete on the side towards the stele (*b*). As this takes place, tracheides destined to supply the branch begin to appear at first to either side of the xylem of the trace; they ultimately form an adaxial curved band joining the two ends of the leaf-trace xylem (*c*). This stage is represented in Phot. 29. The adaxial xylem increases in amount and becomes separate from the xylem of the trace, first on one side (Text-fig. 10, *d, e*; Phot. 30), and ultimately on the other also. Even before it is completely detached, the xylem of the branch arranges itself in the form of a medullated stele with scattered tracheides in the pith (Text-fig. 10, *e*; Phot. 31). Until this stage the stele of the branch has been enclosed by an endodermis common to it and the subtending leaf-trace, but the endodermis outside the latter now becomes indistinct and disappears. The endodermis becomes complete around the branch stele as this separates from the leaf-trace, but previously the endodermis on the adaxial side of the branch has become continuous with that of the main axis (Text-fig. 10, *e, f*; Phot. 31). Not only is this the case, but tracheides are developed between the xylem of the main stele and that of the branch, so that the xylem of the two is continuous for a short distance (Text-fig. 10, *e*; Phot. 31). Above this the two steles again separate, and each has its own complete endodermis (Text-fig. 10, *g*). A little higher the stele of the main axis disappears and the branch alone remains (*h*).

Before tracing the stele of the branch further the structure of the stele of the main axis must be described. It was mentioned above that this had an imperfect but extensive internal endodermis continuous with the external endodermis at the leaf-gap (Text-fig. 10, *a*). The outer endodermis then becomes complete, the inner endodermis disappearing (*b, c, d*), and later the xylem-ring is practically completed (*e, f*). Just at this level the connexion with the xylem of the branch takes place. From a little below the closure

of the xylem-gap scattered tracheides are present throughout the pith of the axis (Text-fig. 10, *d, e, f, g*; Phot. 31). Their distribution is shown diagrammatically in the reconstruction (Text-fig. 11). Still higher, on approaching the injured end of the axis, the xylem ceases to be lignified.

The development of the tracheides throughout the pith of this stele is

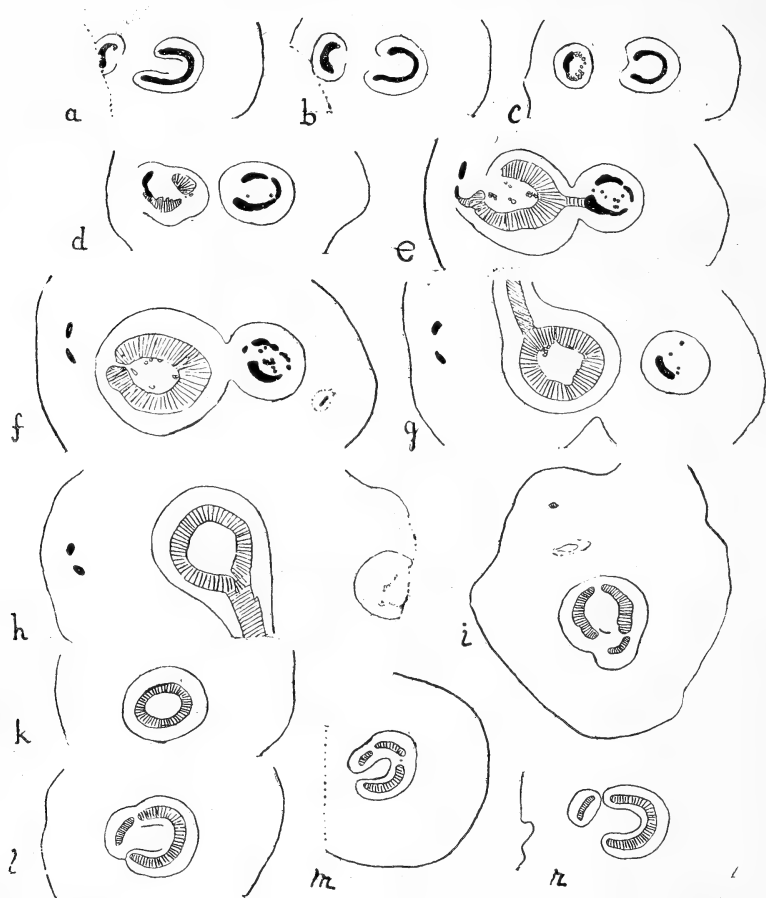

TEXT-FIG. 10. Series of transverse sections of the first branching specimen. Description in text.

a matter of some interest. Comparison with uninjured plants shows that normally no tracheides would have been developed in this position. Their development may be related to the influence on the young main axis of the wounding or of the development of the branch; probably the former is the important factor. Reasons have been given earlier in the paper for recognizing a poorly developed central or centripetal xylem in normal stems of *Botrychium Lunaria*. The scattered tracheides mixed with parenchyma in the pith of this wounded stele are most naturally regarded as a fuller development of this centripetal primary xylem. A point of interest is that

they appear in a pith which lower down was delimited by an internal endodermis, and might therefore be supposed to have been derived by cortical intrusion. The development of these tracheides throughout the pith thus strengthens the evidence against the cortical nature of the pith in *Botrychium*.

The origin of the stele of the branch and its relations to the subtending leaf-trace have been considered. The branch stele soon assumes the characters of a complete and independent stele with a large pith (Text-fig. 10, *g*), from which the scattered tracheides present lower down (*e*, *f*) have disappeared. Surrounding the pith is a wide zone of xylem with tracheides in radial rows, conjunctive tissue and phloem; the external endodermis is complete, and there is no trace of an internal endodermis. The branch stele is much larger than that of the main axis, and resembles in structure an adult rhizome with primary and secondary xylem. From this bulky stele two root-traces are first given off (Text-fig. 10, *g*, *h*), and then a first and second leaf-trace above these two roots respectively. There is nothing to indicate that the bulky pith in the lower part of the stele is of cortical origin. The gap left by the departure of the first leaf-trace closes almost at once in the endodermis, and a little later in the xylem-ring. This trace evidently supplied a reduced leaf, and, though of good size at its origin, rapidly diminishes in the cortex when it divides into two. A vestigial bud is present in the axil of this leaf (Text-fig. 10, *i*), and this is also the case for the second trace, which, however, dies out before reaching the periphery of the cortex.

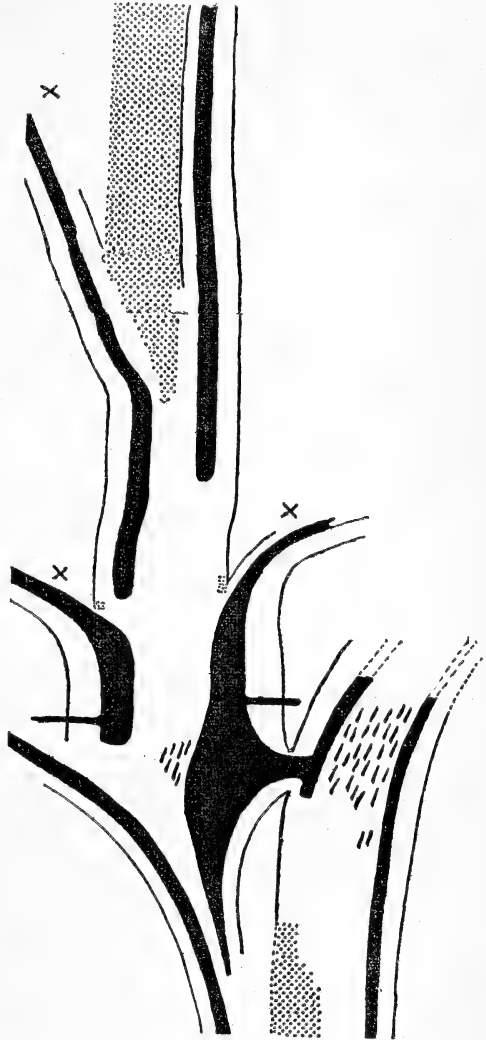

TEXT-FIG. 11. Reconstruction of the relations of the steles of the main rhizome and the branch in the first branching specimen.

An indication of internal endodermis is found before this trace separates, and the gap in the external endodermis is repaired almost as soon as made.

Above the origin of these two first leaf-traces the diameter of the stele of the branch diminishes until it is about that of the original main axis. The complete stele below the origin of the third leaf-trace has no indication of internal endodermis (Text-fig. 10, *k*). As the xylem of the trace separates, but while the external endodermis is still continuous, two strips of internal endodermis develop (*l*), and, on the separation of the trace, these join the edges of the gap in the external endodermis, and the internal endodermis becomes a complete lining to the stele (*m, n*). The branch thus on the whole repeats the development often found in plants developed from an embryo, and it is probable that the departure of the third leaf-trace would be a gradual one with a long leaf-gap.

The structure of the other branching specimens may be more briefly described, and the vascular relations in each case will be clear from the diagrams of transverse sections without the need of reconstructions.

The main axis, which bore the second branch, had had its apex cut off; the single branch had originated a considerable distance behind the wounded end on what must have been a mature region of the rhizome. The portion of the rhizome which bore the branch had the general structure characteristic of a marked intermediate region. The leaf-trace subtending the branch departed very gradually, and the long leaf-gap had an internal endodermis. Text-fig. 12, *a*, shows the previous leaf-gap still open and the subtending leaf-trace ready to depart; the gradual separation of the trace can be followed in Text-fig. 12, *a-g*. In this plant pericyclic xylem was developed in the stele of the main axis (Text-fig. 12, *g*; Phots. 23, 34). At a lower level a band of pericyclic xylem had developed on the abaxial side of the departing leaf-trace (Text-fig. 12, *b, c*; Phots. 32, 24). This soon dies out and plays no part in the vascular supply to the branch. The xylem of the subtending leaf-trace then shows an adaxial extension leading to the formation of a complete ring of xylem (Text-fig. 12, *d, e*; Phot. 33). This is clearly comparable to the adaxial xylem in the subtending leaf-trace of the first branching specimen, where there was no development of pericyclic xylem. As in that case, the adaxial xylem becomes separated from the departing leaf-trace, and ultimately gives rise to the vascular supply for the branch. The organization of the stele of the branch as followed upwards is, however, more irregular in this specimen. The adaxial xylem, after becoming detached from the leaf-trace (Text-fig. 12, *f*), forms an irregular group of tracheidal strands instead of becoming at once arranged to form the stele of the branch (Text-fig. 12, *g*; Phot. 34). On passing a little higher up these become rearranged to form the small medullated stele of the branch, which at once departs from the main

rhizome (Text-fig. 12, *h*). Meanwhile several irregular groups of tracheides have developed in the tissue between the stele of the branch and that of the main axis. These tracheides, like the adaxial group left behind by the branch, soon die out. Before this happens, however, the latter group passes across and fuses with the inner group of tracheides.

It is unnecessary to follow the stele of the branch in detail. It need only be said that the stele is small at its commencement, and does not exhibit the contraction or reduction shown by the former branch. The vascular relations of this branch to its subtending leaf-trace show a general correspondence with the branch previously described, but are less regular. In both these specimens the chief vascular attachment of the branch is to the adaxial side of the subtending leaf-trace, some distance above its

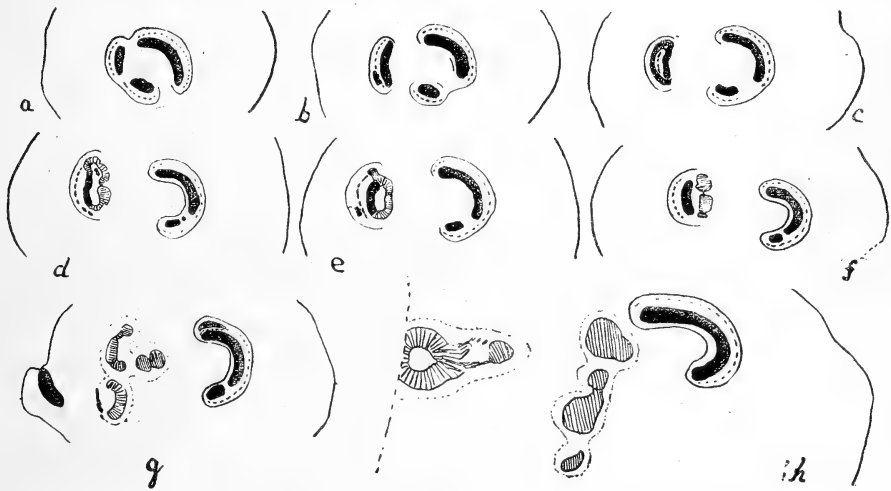

TEXT-FIG. 12. Series of transverse sections of the second branching specimen. Description in text.

separation from the main stele. In the two specimens now to be described the attachment of the branch is deeper in the axil of the leaf-trace, and more closely related to the stele of the stem.

The vascular relations were especially regular in the third specimen (Text-fig. 13; Photos. 35, 36). Here also the upper end of the main axis had been destroyed, and one axillary bud, a short distance behind the cut end, had produced a branch. As the subtending trace begins to leave the stele additional tracheides are evident to either side of the xylem, and practically connect the departing trace to the sides of the leaf-gap in the xylem (*a*). The additional xylem soon extends across the adaxial face of the leaf-trace (*b*), and the stele of the branch is organized from the first in this adaxial xylem (*b-e*). While this is going on, and even after the leaf-trace has departed (*e*), the xylem of the branch is connected by a tract of tracheides with the margins of the leaf-gap. The xylem of this branch,

derived mainly from the adaxial xylem of the subtending leaf-trace, has thus been throughout in connexion with the xylem of the stem stele. As the branch stele becomes quite independent a certain amount of the xylem between it and the stele of the axis dies out in the cortex. As in the case of the first branch described, the stele of the branch at its base has a greater diameter than the stele of the main axis at the same level; the branch stele soon diminishes in diameter. A slight development of pericyclic xylem occurs in the subtending leaf-trace (Text-fig. 13, *b*), but takes no part in the supply to the branch.

The fourth case of branching in *B. Lunaria* that I have studied is of great interest, but unfortunately only a number of hand sections were available. I owe the specimen to the kindness of my friend Professor

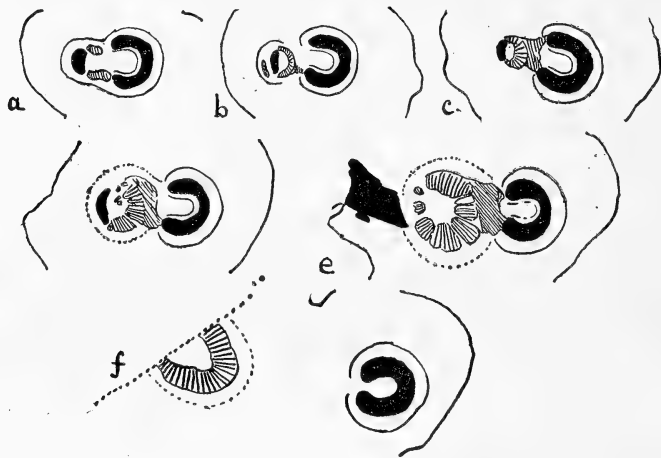

TEXT-FIG. 13. Series of transverse sections of the third branching specimen. Description in text.

Gwynne-Vaughan, who noticed the branching in some sections cut by a student in his laboratory, and obtained and arranged all the sections that had been cut of the piece of rhizome in question. The stout rhizome with typical adult structure of the stele had evidently been injured at the upper end, and the buds in the axils of the two uppermost leaves of the remaining portion of the xylem had developed as branches. The leaf below showed the usual vestigial axillary bud. The steles of the branches in this specimen were relatively small compared with that of the stele of the axis.

The main rhizome had a large stele with a well-marked external endodermis. The broad band of xylem around the large pith showed the distinction of primary and secondary wood described above in other large stems. The arrangement of the elements of the primary xylem was very suggestive of a distinction of centripetal and centrifugal xylem. Outside



the band of secondary xylem continuous with the centrifugal primary xylem, the cambial activity had been resumed, and a further zone of secondary xylem had been formed. This was in great part parenchymatous, but numerous tracheides had been developed in the radial rows of cells produced from the meristem. This resumption of secondary growth must be placed in relation to the development of the branches.

The general vascular relations of the branches to the main axis will be understood from Text-fig. 14. At the level where the series begins (A) one leaf-trace is nearing the periphery of the cortex, and the position of the vestigial bud in relation to this leaf is indicated by the slit in the next diagram. A second leaf-trace has departed leaving a wide gap in

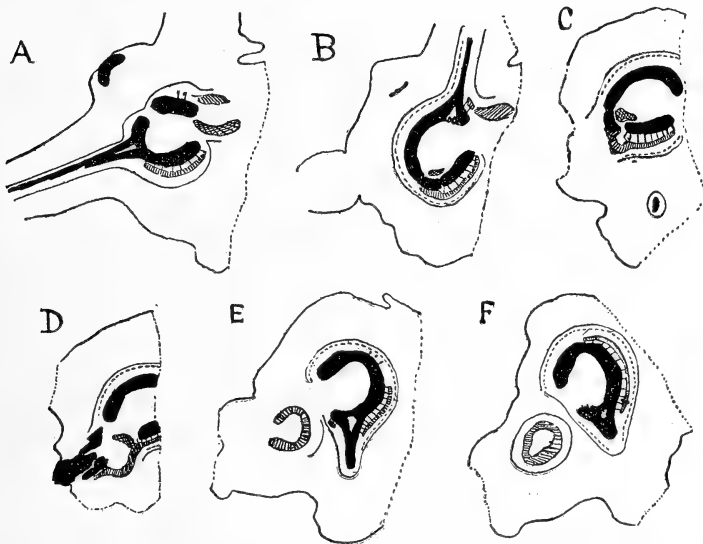

TEXT-FIG. 14. Series of transverse sections of the fourth branching specimen. Description in text.

the stele, and opposite the gap is the vascular supply for the first branch. The xylem for the branch is in part connected with the additional secondary xylem, and in part appears to come from within the leaf-gap. In B the attachment of a root-stele by one side of this gap is seen, and a root was attached on the other side between the levels of A and B. The stele is imperfect in the neighbourhood of the first branch, and the latter cannot be followed further. This section (B), however, shows the first indication of the vascular supply to the second branch. The leaf-trace subtending this branch still forms part of the complete vascular ring of the main stele, but is distinguishable by the outward slope of its tracheides. Internal to the xylem of this trace a group of tracheides has arisen at the periphery of the pith. This group of tracheides increases in size as the trace prepares

to depart (C). As the departure of the trace rapidly takes place the internal group of tracheides passes out through the leaf-gap and, along with an arc of tracheides continuous with the additional secondary xylem of the stele, constitutes the xylem of the base of the branch (D). This becomes arranged to form a definite stele, at first with a gap opposite to the subtending trace (E). This gap closes, and in F the small branch stele is seen in the cortex beside the main stele; the gap in the latter is now closing. Comparison of A and D will make it clear that the origin of the vascular supply to the first branch was similar.

The special interest of this specimen lies in the need of vascular connexions for the branch affecting the stele of the stem before the departure of the subtending leaf-trace, and in the resumption of active secondary thickening producing xylem to which another portion of the vascular supply to the branch is connected.

The fifth branching specimen (Phot. 37) was incomplete, the branch itself having been broken away. It was met with accidentally when cutting the basal region of a plant longitudinally. The specimen shows, however, the relation to the leaf-trace of the commencing tracheidal supply to the branch. The photograph shows the arrested end of the main axis, the departing leaf-trace, and the leaf-gap above it. The endodermis was completed at once on the departure of the trace. The latter itself is small, but from just above the level of its departure from the stele adaxial xylem to supply the branch has been developed. The tracheides of this adaxial xylem are comparatively short and wide. Just below the broken surface indications were evident of the arrangement of this xylem to form the stele of the branch.

If the several branched specimens of *B. Lunaria* described above are compared, it is evident that, while they present considerable differences in detail, the vascular connexions of the branch follow the same general plan. In considering them it is essential to bear in mind that the branch had its origin in a vestigial axillary bud called into activity by the arrest of the normal apical growth of the main axis. While the tissues laid down in the further growth of the bud itself will be strictly primary, any vascular connexions established in the region below the vestigial bud, either with the subtending leaf-trace or the stem stele, must be due to subsequent and, in a sense, secondary changes. This will be more marked when the vestigial bud called into activity is situated on a quite mature region of the rhizome some distance from the apex, and least so when the lateral growing point affected is close to the apical meristem of the main axis where the tissues are still immature.

Direct evidence in favour of the view just expressed could only be obtained from the study of buds in various stages of their growth into branches. The facts regarding the relations of the mature branches are,

however, consistent with and support it, especially if the structure be considered from above down, and not, as in the descriptions given, from below up. Down to a level which probably marks the position of the original bud, the structure of the branch is normal. Below this we come to the vascular connexions to the pre-existing tissues of the main shoot. These must be regarded as developed, under the influence of the developing bud, on the tissues occupying the axil of the leaf-trace. Further study of the anatomy of such structures may throw much light on the immediate causes of the organization of the vascular system. The remarkable fact comes out from the study of these few branches that these secondarily established vascular connexions are such as to allow of comparison with other lateral branches, the vascular supply to which is part of the primary organization of the plant.

While the relative position of the branch remains the same, its vascular supply may appear to come almost wholly from the subtending leaf-trace, or may in considerable part be derived from, or connected with, the tissues of the stem stele. The former case is best shown in the first branch, less clearly in the second, while connexion with the stem stele is marked in the third and fourth specimens. This variation in *Botrychium Lunaria* is of considerable interest when it is borne in mind that the branch in *Helminthostachys* is connected with the stele of the stem at the anterior end of the leaf-gap, and not with the subtending leaf-trace.

On considering all the facts, I am inclined to regard the vascular relations of the branch in the first specimen as most nearly representing what would be found if the development of the branch were immediate and primary. The endodermal relations show that this bud must have sprung into activity in a region so close to the apex of the main shoot that the endodermis was not yet differentiated. The preparations for the vascular supply of this branch at once suggest comparison with the more or less complete development of adaxial xylem in normal leaf-traces. It seems possible that the structure in the second and third examples can be brought into line with this; at any rate, whatever be the significance of the xylem connecting the branch and stem steles in these three cases, the main relation of the branch is to the adaxial xylem of the subtending leaf-trace. The fourth example, however, seems to show that the vascular connexions may be more irregular and not always reducible to one plan.

While all the details cannot be reconciled it seems to me that we are justified in looking on *Botrychium Lunaria* as having ancestrally or potentially a branched shoot, the branches springing from the leaf-axils. It seems justifiable further to compare the origin of the vascular supply to the branch with what is found in the branching of the Hymenophyllaceae and of some of the Zygopterideae. That variants should occur in *Botrychium* is not surprising; indeed, it is remarkable that the subsequent establishment of

vascular connexions for its branches should show so much in common with the primary structure in the branches of the groups mentioned.

#### SUMMARY.

1. Complete rhizomes of *Botrychium Lunaria* exhibit some variety in external form. Above the basal region with its crowded roots an ill-defined segmentation of the shoot can be traced; this is marked by the origin of one or two roots just above the leaf-gap, i. e. near the base of the segment of the shoot corresponding to the next leaf. The transition from the basal to the adult regions of the rhizome may be a gradual and direct one, none of the segments being especially elongated. In other cases a marked intermediate region, due to one or a number of segments being greatly extended and slender, may intervene between the basal and adult regions.

2. The medullation of the stele may take place without interruption of the external endodermis at the lower leaf-gaps, and without the development of an internal endodermis in any part of the plant. The band of endodermis closing the gap caused by the departure of a leaf-trace is a new formation, and may be developed before the internal endodermis is interrupted.

When an internal endodermis is present it is confined to the slender intermediate region of the rhizome, and may be more or less complete. It does not form a complete pocket extending down from the leaf-gap, and its distribution suggests a new formation to meet physiological needs, rather than the intrusion of a phloeotermal layer marking the inner limit of an intrusive cortex. The pith of *Botrychium Lunaria* is therefore regarded as wholly intrastelar and not as intrusive, whether an internal endodermis is present or not. This view is supported by the relations of the tissues in the apical region.

3. Centrifugal (or outer) primary xylem, centripetal (or inner) primary xylem, and secondary xylem can be distinguished in the stele of *B. Lunaria*.

In the non-medullated stele of the basal region the group of central tracheides is surrounded by a zone of tracheides showing indications of radial arrangement. On medullation taking place elements of the central xylem can still be recognized on the inside of the cylinder of outer xylem, and may occur scattered through the pith. Only primary xylem is present, and this also holds for the more or less specialized intermediate region of the rhizome. The transition to the fully adult region is marked by the appearance of tracheides arranged in regular radial rows immediately outside the centrifugal primary xylem. The medullary rays present in the zone of secondary xylem are cut off from the pith by the continuous zone of primary xylem.

The xylem is completely developed and lignified a short distance behind the apical meristem. No sharp limit can be drawn between the

early tangential divisions in the procambium giving rise to the elements of primary xylem, and the slightly later ones that give rise to the tracheides of the secondary xylem. The secondary growth is normally not progressive; under exceptional circumstances it may, however, be actively resumed.

The central (or centripetal) primary xylem is usually only represented by a few tracheides at the periphery of the pith. In one wounded stem numerous tracheides, the position of which was clearly centripetal, developed throughout the pith, and tracheides in a similar position are sometimes met with in normal stems.

4. The leaf-trace commonly departs as a segment of the vascular ring of the stele. The centripetal xylem, if present, disappears internal to the leaf-trace, so that the latter at its departure is an endarch collateral strand. In some small rhizomes the trace may depart from the ring of outer or centrifugal xylem, leaving the central xylem complete; or the central xylem may close across the gap before the outer xylem does. In both cases the xylem of the rhizome appears analysed into its outer and inner components.

5. The endodermis may be completed round the adaxial side of the departing leaf-trace, enclosing parenchyma between it and the protoxylem of the trace. Divisions take place in this adaxial parenchyma, and tracheides may develop in it; these extend round from the curved ends of the xylem of the leaf-trace, and form a more or less complete ring of xylem. Indications at least of this adaxial xylem, which is not directly continuous with the inner xylem of the stem, are commonly found. The adaxial xylem is frequently separated from the rest of the trace by continued growth of the parenchyma in the region of the periderm. It may, however, still be represented in the leaf-trace after this has entered the petiole.

A leaf-trace departing from a stele with secondary thickening usually exhibits secondary growth in the lower portion of its course through the cortex.

6. Under exceptional circumstances meristematic activity may commence in the pericycle, and lead to the development of a more or less extensive tract of pericyclic xylem outside the phloem. This has been found in the stem and in the departing leaf-trace. The pericyclic xylem, which suggests comparison with some cases of anomalous secondary thickening, may or may not be associated with the presence of a branch.

7. A single vestigial bud, similar to that described by Gwynne-Vaughan in *Helminthostachys*, is regularly present in the axil of every leaf of *B. Lunaria*. It is connected to the outside by an occluded slit, and remains embedded in the cortical tissue of the rhizome after the leaf has withered.

8. Under special conditions, especially when the growth of the main axis is arrested, branches may develop in the position corresponding to the vestigial buds, and evidently from one or more of the latter having been

stimulated to active growth. While the buds are part of the primary construction of the plant, the vascular connexions of the branch with the main shoot have to be established in more or less mature tissues; this accounts for the variety in detail found in this respect.

The chief vascular supply of the branch is derived from a development of xylem adaxially to the subtending leaf-trace. This xylem is strictly comparable to the adaxial xylem referred to under (5). The vascular supply to the branch may arise from the subtending leaf-trace when the latter has already separated from the stele, or it may arise lower down in the axil of the leaf-trace. A more or less extensive vascular connexion may also be present between the branch and the stele of the stem, in the neighbourhood of the leaf-gap.

The vascular supply to the branch becomes organized into a medullated stele. This is sometimes small, but in other cases is much larger than the stele of the parent rhizome; in the latter cases the stele of the branch diminishes in diameter above its base. The stele of the branch at first shows a gap opposite to the subtending leaf-trace, so that the latter *appears* as if it were derived from the branch stele. The stele of the branch, which shows a general resemblance to that of a plant developed from an mbryo, may acquire an internal endodermis; the origin of the pith, however, is below and independent of this.

#### CONCLUDING REMARKS.

As stated at the beginning of this paper, any full discussion of conclusions will be deferred until the corresponding facts for other Ophioglossaceae have been described. A brief reference to the conclusions towards which this study of *Botrychium Lunaria* appears to point is, however, necessary.

The re-examination of *B. Lunaria* has revealed a number of features in the anatomy which considerably modify our general conception of the construction of the plant. The most striking of these is the regular presence of a vestigial axillary bud in relation to every leaf, and the reference of the occasional branching of the rhizome to the active growth of one or more of these. This justifies us in regarding *B. Lunaria* as a potentially branched plant, the buds being part of the primary construction of the plant and not adventitious. This feature at once suggests comparison with *Helminthostachys*, and with the Hymenophyllaceae and Zygopterideae,<sup>1</sup> and it is with these latter groups and the Osmundaceae that comparisons would most naturally be made on the ground of general anatomy.

A distinction between inner (or centripetal) and outer (or centrifugal) primary xylem can be traced from the basal region throughout the plant. I am inclined to attach importance to this, especially in the light of the

<sup>1</sup> Cf. Scott, *Annals of Botany*, vol. xxvi, p. 59.

adult stelar structure in *Helminthostachys*, where inner and outer primary xylem are well developed. The two xylems appear to be strictly comparable to the outer and inner xylem in *Zygopteris*, and possibly to the outer and inner xylem in Osmundaceae. In *B. Lunaria* the outer primary xylem is well developed throughout the plant, while the inner xylem is, as a rule, only represented by a few tracheides round the periphery of the pith, which occupies its place in the expanded stele above the basal region. The secondary xylem comes immediately outside the primary, and there is no absolutely sharp distinction between the two. The relation between primary and secondary xylem is comparable to what is described for *Botrychioxylon*<sup>1</sup> and for *Zygopteris corrugata*.

The medullation of the stele has been examined in detail, since it appeared to be important to ascertain all facts which would throw light on the significance to be attached to the presence of an internal endodermis in the lower region of the rhizome. The view reached, that the pith is throughout intrastelar, and that the internal endodermis is a new formation and does not mark a morphological boundary, makes the pith in the Ophioglossaceae strictly comparable to the parenchyma enclosed by the xylem in the Zygopterideae. It would also be comparable to the pith of the Osmundaceae, as the origin of this is explained by Kidston and Gwynne-Vaughan, and to the pith of the Schizaeaceous stele as interpreted by Boodle. The conclusion to which my observations point, that the pith in the Ophioglossaceae is not due to 'pocketing' or 'intrusion of cortex', but is wholly intrastelar, goes beyond that of Bower. He accepted the endodermis provisionally as marking the limit between pith and cortex, and thus arrived at the view that the pith in *Botrychium* was in the basal region intrastelar, and in the upper portion of the plant largely intrusive and cortical. The further facts given in this paper appear inconsistent with any actual intrusion of cortex. The Ophioglossaceae would thus come into line in this respect with all the relatively primitive groups of Ferns, and the excellent statement recently made by P. Bertrand<sup>2</sup> on the nature of the differentiation of the procambium to form either a solid column of xylem, a medullated stele, or one with internal endodermis and phloem would apply to the Ophioglossaceae as well as to the Osmundaceae.<sup>3</sup>

The leaf-trace has been shown to exhibit a tendency to the completion of its ring of xylem by the development of adaxial tracheides extending from the ends of the arc of xylem which leaves the stele of the stem. Since any indication of centripetal xylem disappears before the leaf-trace departs from the stele of the stem, it does not appear that the adaxial xylem of the leaf-trace is

<sup>1</sup> Scott, Trans. Linn. Soc., vol. vii, pp. 373 ff.      <sup>2</sup> Progressus Rei Botanicae, iv, p. 208.

<sup>3</sup> The facts ascertained for *Botrychium Lunaria* appear to be irreconcilable with the statement of Jeffrey 'that the pith must in all cases be regarded as a derivation of the cortex' (Bot. Gaz., Dec. 1910, p. 412). But the general question has been sufficiently discussed by Bower (Ann. Bot., xxv, p. 555).

a continuation outwards of the centripetal xylem of the stem. The facts seem more satisfactorily explained by regarding the leaf-trace not as mesarch, but as completed by an adaxial extension of the centrifugal xylem. This view is supported by those cases in *Helminthostachys* in which a truly mesarch trace is completed adaxially; in such cases the two xylems can be clearly distinguished. The Ophioglossaceous leaf-trace on this view would present points of resemblance to the early departing trace in Zygoterideae and to the trace in the Hymenophyllaceae. It would also resemble that of *Osmunda*. Such a view agrees in general with Kidston and Gwynne-Vaughan's interpretation of the C-shaped leaf-trace in the Ferns, but since it regards the xylem of the trace (whether solid or tubular) as composed of centrifugal xylem extended round adaxially, and not as mesarch, it differs in some respects. On this view the hooks of xylem at the outer margin of the leaf-trace would be the last indication of the adaxial extension of the xylem.

The derivation of the vascular supply to axillary branches from the adaxial xylem of the subtending leaf-trace supports this comparison of the leaf-trace with those of the Hymenophyllaceae and Zygoterideae. Further facts are necessary before the variations in the vascular supply to the branches in *Botrychium* can be fully elucidated. In essentials, however, the comparison of the axillary branching in Ophioglossaceae, Hymenophyllaceae, and Zygoterideae is strengthened by the vascular relations in *B. Lunaria*. The Ophioglossaceae may throw light on the variable position of the branches, whether on the stem or the subtending leaf-trace found in the Zygoterideae.

These remarks will indicate, without entering into details, the general bearing of some of the additional features in the anatomy of *B. Lunaria* which have been described in this paper. A deeper analysis of the construction of the rhizome is necessary before such questions as the distinction of stem and leaf in its composition can be discussed. The stelar structure, the medullation, the construction of the leaf-trace, and the nature of the branching are all consistent with a relationship of the Ophioglossaceae to the ancient Fern stock, the general features of which are indicated in the relatively primitive groups of Ferns, such as Zygoterideae, Botryopterideae, Osmundaceae, Hymenophyllaceae, &c. The facts do not appear to point to a direct relationship to any particular known group. In any case it seems at present more important to elucidate the comparative morphology of these more ancient Ferns in all its details than to speculate on the problem of actual relationship.



## DESCRIPTION OF FIGURES IN PLATES XX AND XXI.

Illustrating Prof. Lang's paper on *Botrychium Lunaria*.

(All these figures are from untouched photographs.)

## PLATE XX.

Phot. 1. Transverse section of medullated stele in the intermediate region of the rhizome. Practically all the xylem is centrifugal and primary.  $\times 62$ .

Phot. 2. Transverse section of a stele showing the transition to the region with definite secondary thickening. Radial rows of secondary tracheides are developed irregularly outside the narrow zone of centrifugal primary xylem.  $\times 62$ .

Phot. 3. Transverse section of the stele of the adult region of the rhizome. Around the zone of primary wood (in which centripetal as well as centrifugal xylem may be represented) comes a broad zone of secondary xylem consisting of radial rows of tracheides and medullary rays which only extend inwards as far as the primary xylem.  $\times 35$ .

Phot. 4. Portion of the vascular ring of a similar stele more highly magnified. The distinction of primary and secondary xylem is well shown.  $\times 62$ .

Phot. 5. Portion of the vascular ring of the stele in Phot. 3, showing the primary and secondary xylem. Some of the primary xylem next the pith may be centripetal.  $\times 62$ .

Phot. 6. Transverse section of a stele at the base of a plant. The solid xylem consists mainly of central tracheides around which elements of the outer xylem are commencing to appear.  $\times 62$ .

Phot. 7. Transverse section of the stele of the same plant at a slightly higher level. The solid xylem consists of the central group of tracheides, and around it the tracheides of the outer xylem arranged more or less radially. A root-trace is departing from the stele.  $\times 62$ .

Phot. 8. Transverse section of the same stele at a still higher level. Parenchyma has appeared in the central xylem forming the beginning of the pith. The xylem is mostly composed of the outer xylem with elements of the inner xylem around and between the pith-cells.  $\times 62$ .

Phot. 9. Similar section of the stele of another plant. The two pith-cells in the centre are surrounded by the inner xylem, outside which comes an incomplete zone of tracheides of the outer xylem.  $\times 62$ .

Phot. 10. Transverse section of a stele near the base of a plant, showing on the right a leaf-trace about to depart. A tracheide of the inner xylem lies opposite the leaf-gap and marks the boundary between the pith and the 'pocket' of parenchyma internal to the departing trace.  $\times 62$ .

Phot. 11. Transverse section a little higher up than Phot. 10. The leaf-trace has separated from the stele but is still enclosed by the endodermis. Tracheides of the inner xylem have completely shut off the pith from the leaf-trace 'pocket'. The stele in this and the preceding photograph has a second endodermis some three cells further out in the cortex.  $\times 62$ .

Phot. 12. Transverse section of a stele showing a small pith, and to the left a large parenchymatous 'pocket' internal to a leaf-trace which is about to depart.  $\times 62$ .

Phot. 13. Transverse section slightly higher up than Phot. 12. The xylem of the trace has separated and the parenchymatous pocket forms a gap in the outer xylem only. The central xylem has become solid again; there is no true pith.  $\times 62$ .

Phot. 14. Section a little higher up than Phot. 13. The xylem of the trace is further out but still enclosed by the stellar endodermis. The gap in the outer xylem persists. The pith of the stele is reappearing.  $\times 62$ .

Phot. 15. Section still higher up than the preceding photograph. The pith has increased, almost replacing the central xylem, and communicates with the parenchyma of the gap in the outer xylem, which is almost closed. The leaf-trace is seen dying out in the cortex. A root-trace is attached to the xylem of the stele below.  $\times 62$ .

Phot. 16. Transverse section of the stele of the same plant as Photos. 12-15, but much higher up. The zone of xylem is wholly primary. The tracheides projecting into the pith correspond to elements of the central xylem. They disappear internal to the leaf-trace which is preparing to depart on the left.  $\times 62$ .

Phot. 17. Section a little higher up than the preceding photograph. The endarch leaf-trace has separated from the stele. A root-trace is attached to one side of the leaf-gap.  $\times 62$ .

Phot. 18. Transverse section of a small leaf-trace on its way through the cortex. The endodermis is complete adaxially and a number of adaxial tracheides are present, continuous on the right side with the curved extension of the xylem of the original leaf-trace.  $\times 62$ .

Phot. 19. Transverse section of a large leaf-trace on its way through the cortex; scattered adaxial tracheides are present on the concave inner face of the trace.  $\times 62$ .

Phot. 20. Longitudinal section of a leaf-trace passing through the cortex from an adult stele with marked secondary thickening. At the lower end of the photograph the leaf-trace shows shorter and wider secondary tracheides to the outside of the primary xylem; these disappear higher up. Two adaxial tracheides are seen to the inner side of the primary xylem of the trace.  $\times 62$ .

Phot. 21. Transverse section of a leaf-trace in the base of the petiole. The xylem has just divided into two and shows the hooks, interpreted as the last indication of the adaxial xylem; the hook on the right is most clearly seen.  $\times 62$ .

#### PLATE XXI.

Phot. 22. Longitudinal section of an adult stem with secondary thickening. From right to left the photograph shows: pith, primary xylem, secondary xylem, conjunctive parenchyma, phloem (represented by a crushed sieve-tube), and pericyclic xylem. The tracheides of the latter are short and arranged in groups which indicate their origin by irregular tangential divisions in the pericycle.  $\times 62$ .

Phot. 23. Transverse section of part of the stele of the rhizome of the second branching specimen. Pericyclic xylem is developed and lies outside the phloem.  $\times 62$ .

Phot. 24. Transverse section of the leaf-trace subtending the branch of the second branching specimen. An almost complete band of pericyclic xylem is present outside the phloem on the abaxial side of the trace.  $\times 62$ .

Phot. 25, 26. Longitudinal radial sections of the rhizome, showing the position and appearance of the enclosed vestigial axillary buds.  $\times 35$ .

Phot. 27. Transverse section of the stele of the adult region of the rhizome, showing a departing leaf-trace and the axillary slit leading down to the vestigial axillary bud.  $\times 40$ .

Phot. 28. Transverse section of another rhizome passing just below the level of the axillary slit, i. e. through the region in which the apex of the vestigial bud is probably situated.  $\times 62$ .

Phot. 29-31. Three transverse sections of the first branching specimen. In Phot. 29 the adaxial xylem of the subtending leaf-trace is completed. In Phot. 30 this has separated on one side from the leaf-trace and is becoming arranged to form the stele of the branch. In Phot. 31 the branch stele is still connected with the xylem of the subtending leaf-trace, but has also become continuous with the xylem of the main axis. Tracheides have developed throughout the pith of the main axis.  $\times 40$ .

Phot. 32-34. Three transverse sections of the second branching specimen. In Phot. 32 the subtending leaf-trace shows the pericyclic xylem. In Phot. 33 this has almost disappeared, but the band of adaxial xylem to supply the branch is complete. In Phot. 34 the adaxial xylem has separated from the subtending leaf-trace as an irregular group of tracheides from which the branch stele will be organized.  $\times 40$ .

Phot. 35, 36. Two transverse sections of the third branching specimen. In Phot. 35 the adaxial xylem forming the stele of the branch is still connected with the subtending leaf-trace and also with the xylem of the main stele in the neighbourhood of the leaf-gap. In Phot. 36 the subtending leaf-trace is departing, but the stele of the branch is still in connexion with the xylem of the main stele.  $\times 40$ .

Phot. 37. Longitudinal section of the fifth branching specimen, showing the departure of the subtending leaf-trace from the injured main stele, and the development of short tracheides adaxially to the leaf-trace. These were the first indications of the vascular supply to an axillary branch which had been broken off.  $\times 40$ .



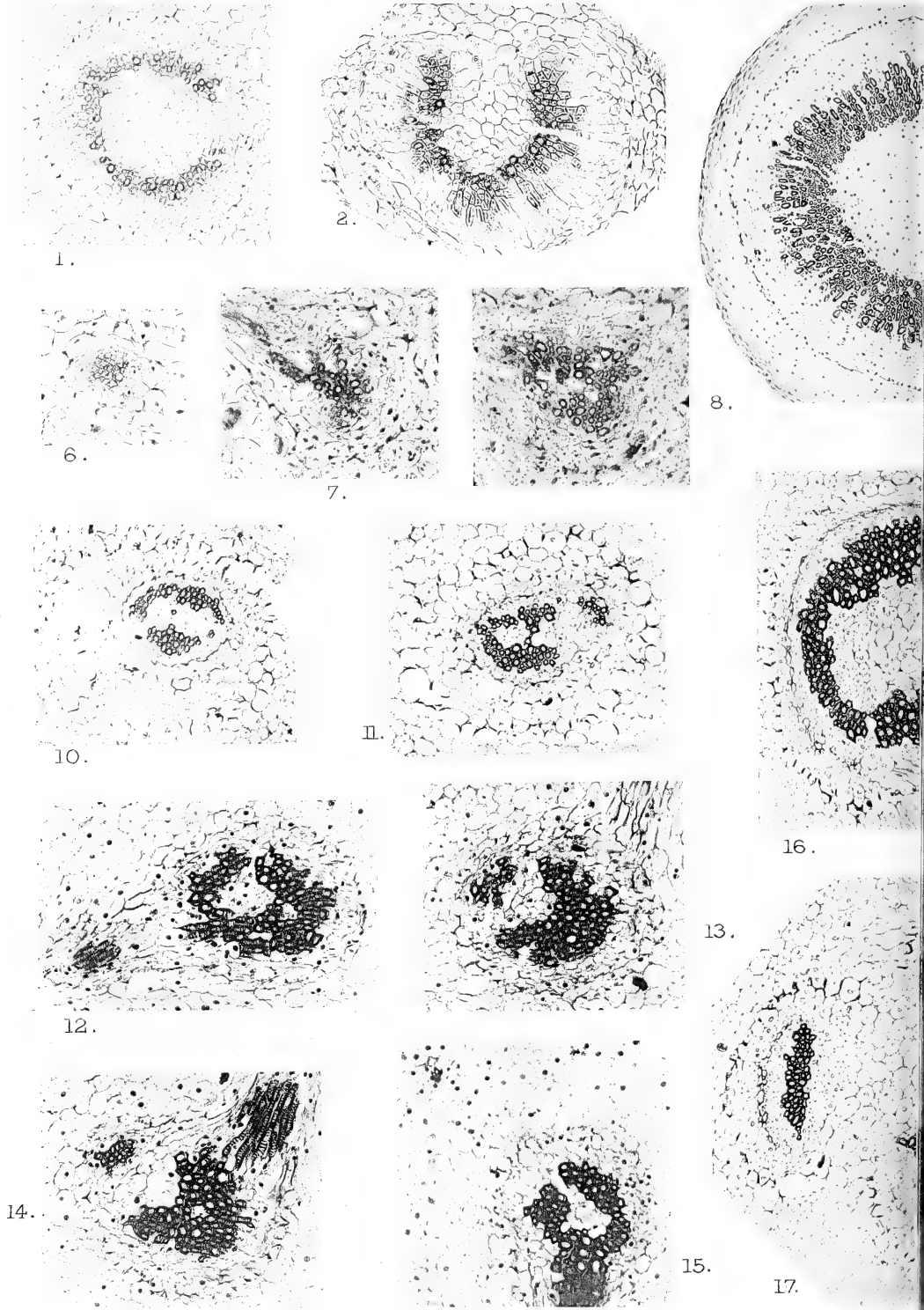

W.H.L. photo.

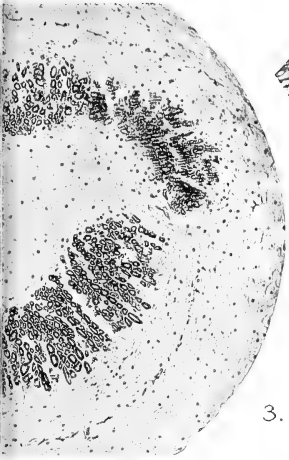

3.

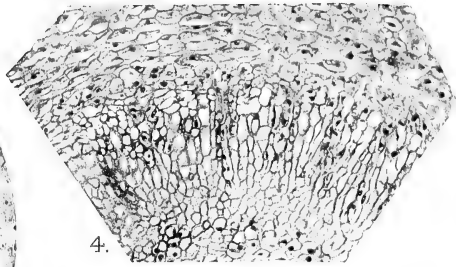

4.

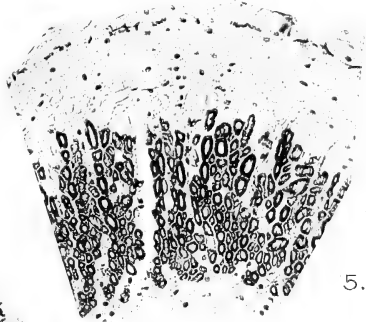

5.



20.

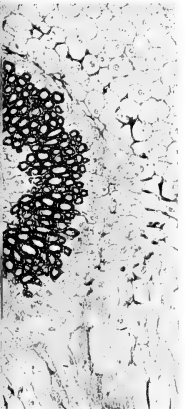

9.

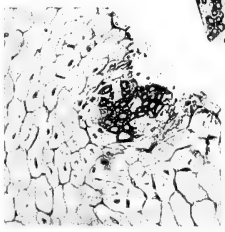

18.

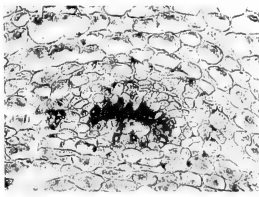

19.

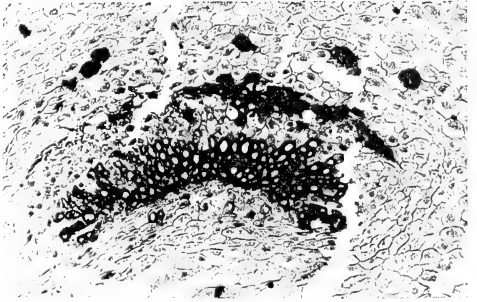

21.

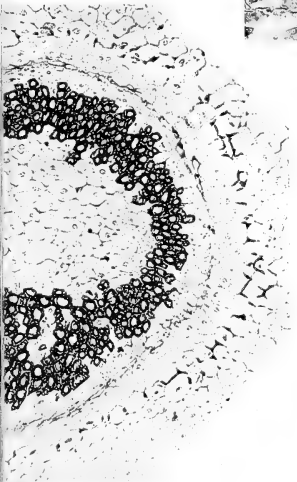



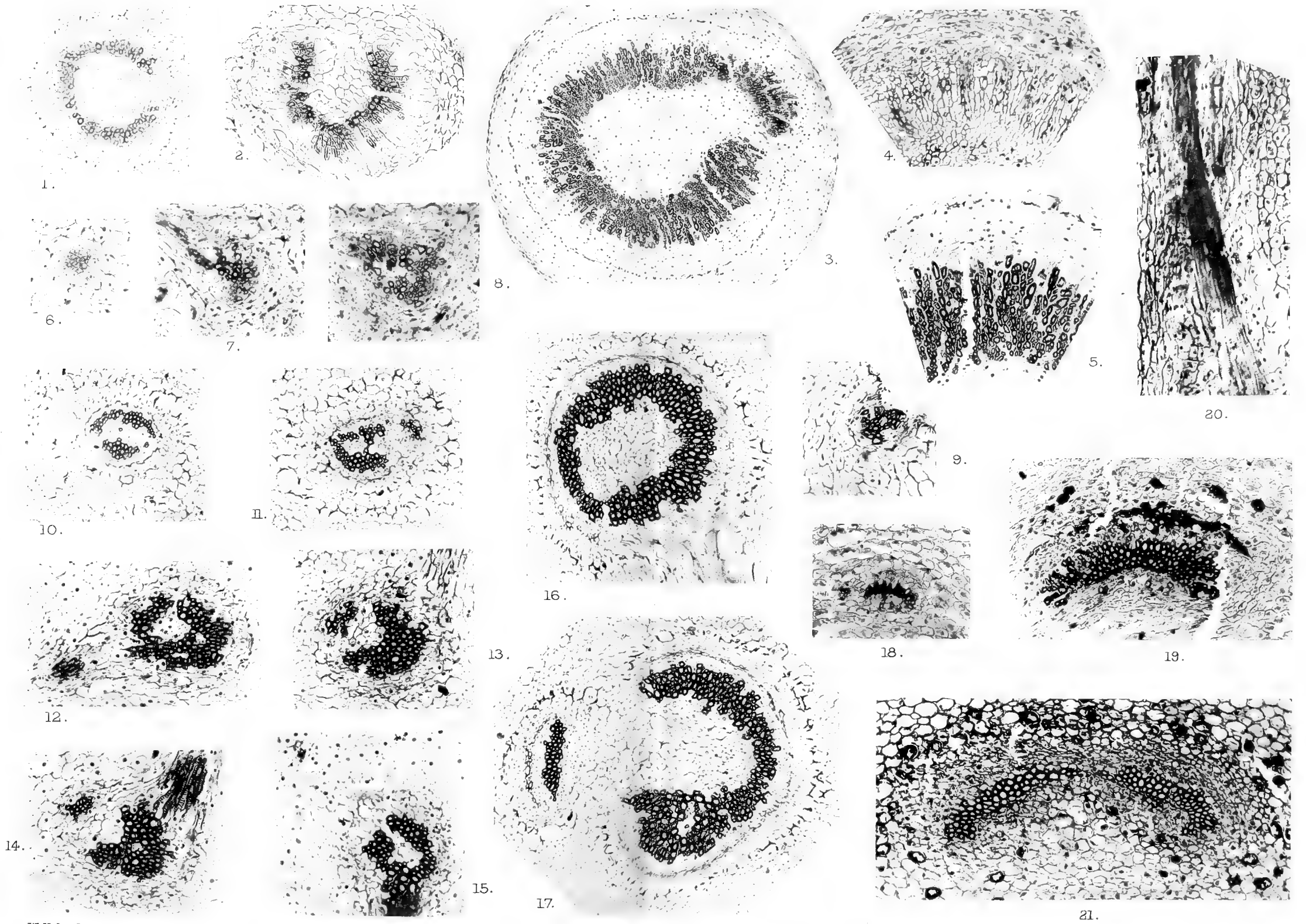

W.H.L. photo.

LANG — BOTRYCHIUM LUNARIA

Henth. coll.







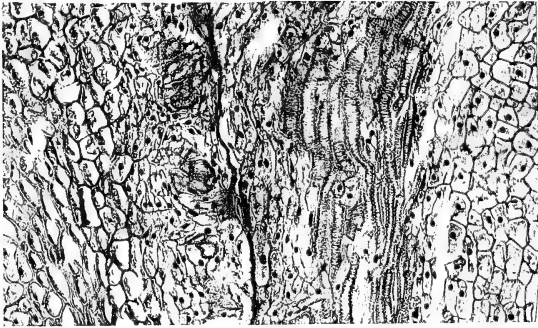

22.

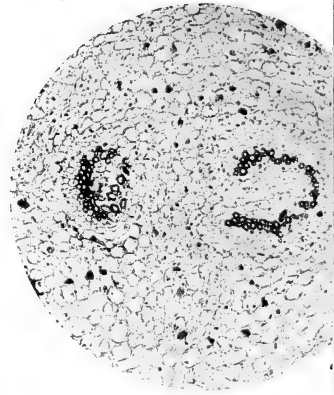

23.

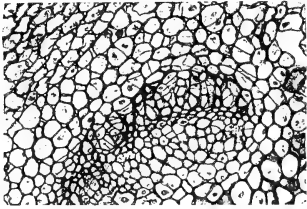

25.

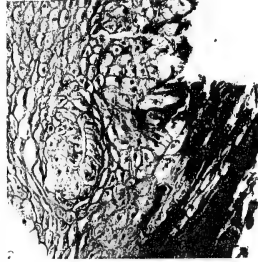

24.

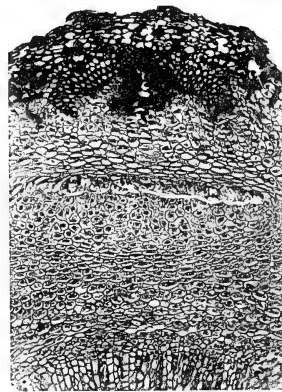

26.

27.

28.

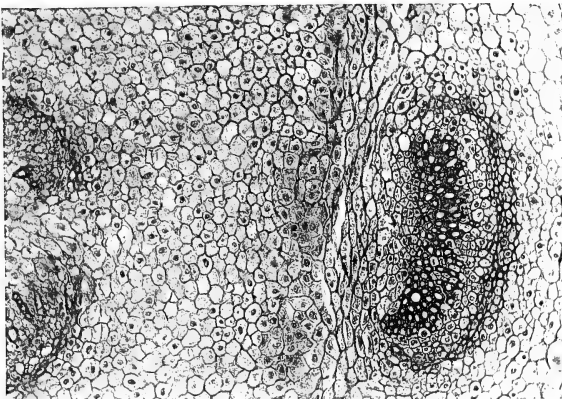

37.

W.H.L. photo.

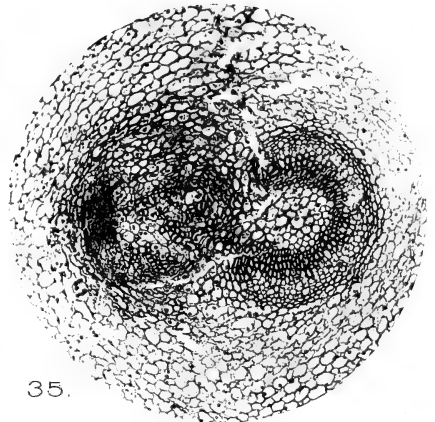
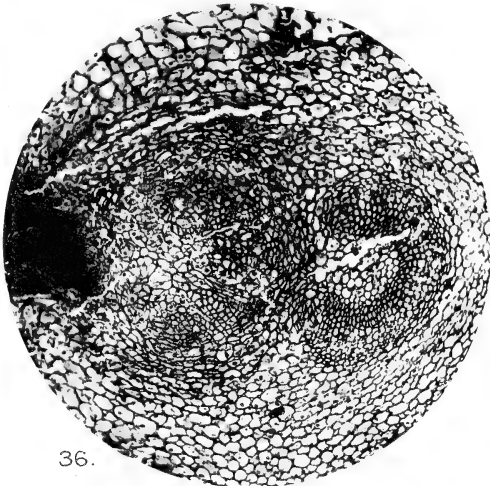
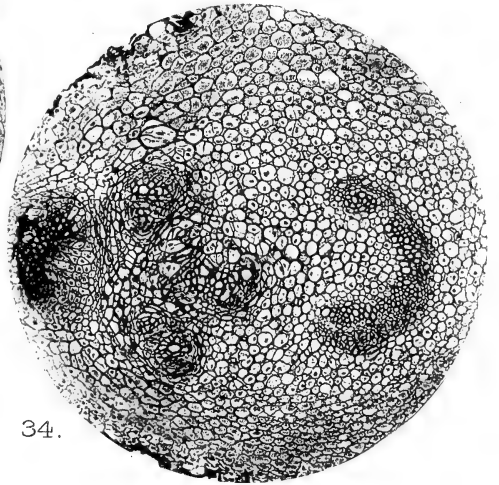
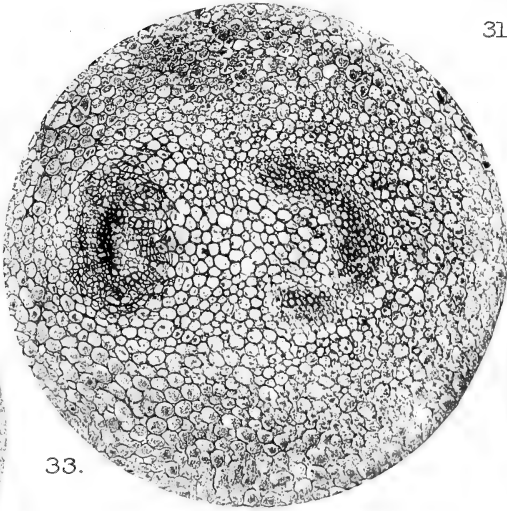
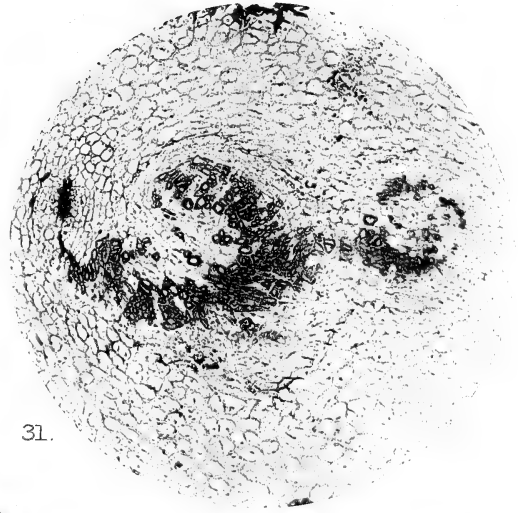
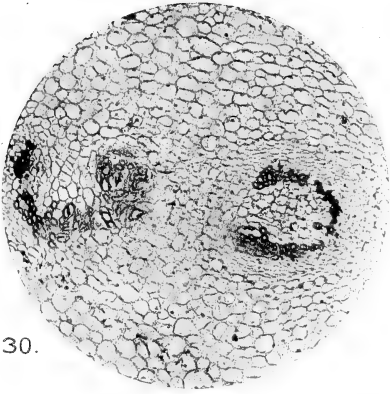



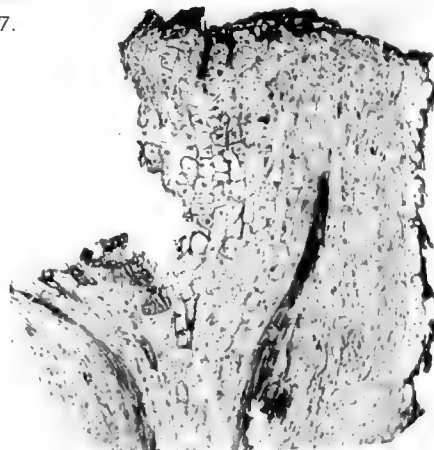
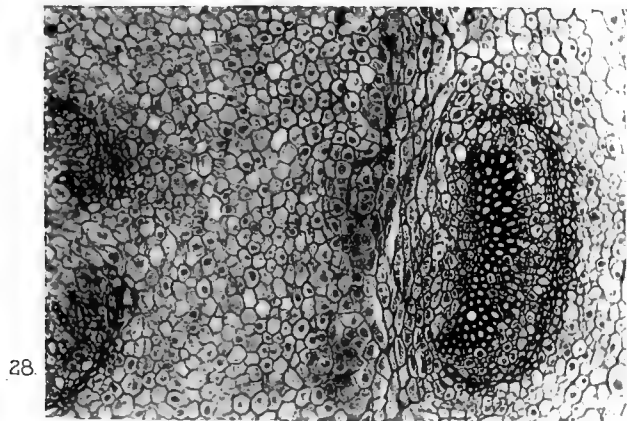
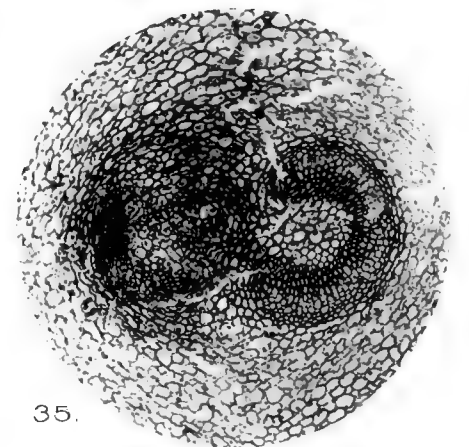
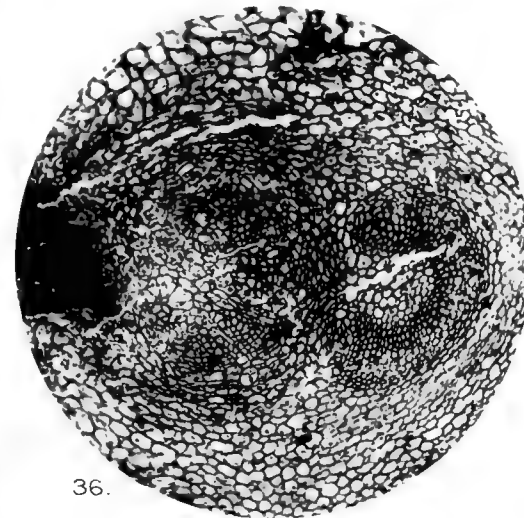
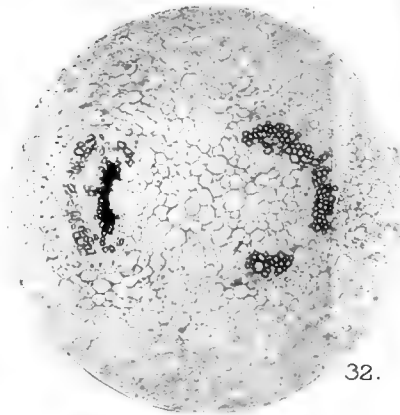
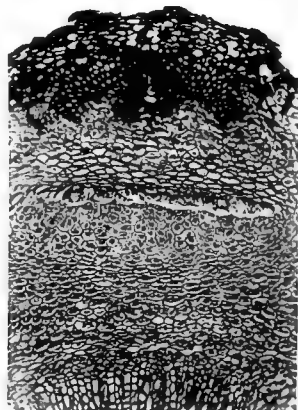
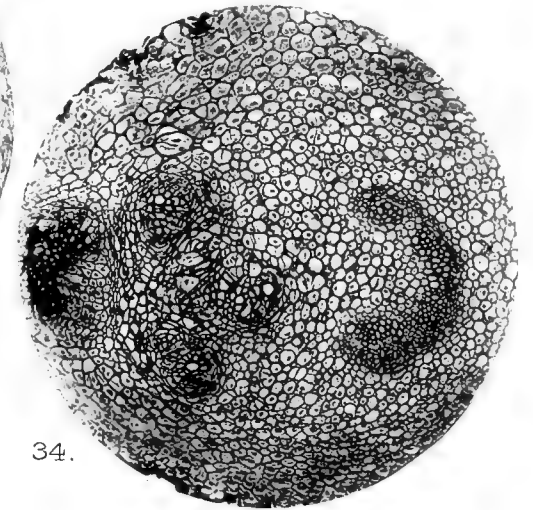
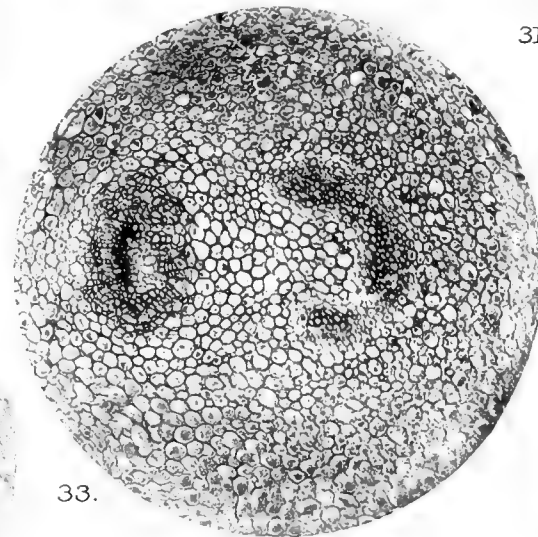
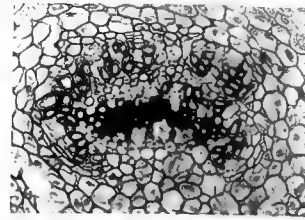
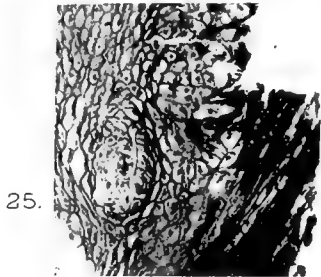
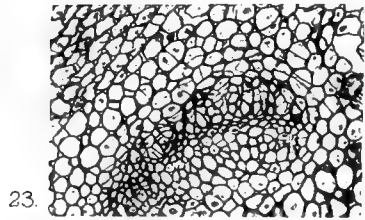
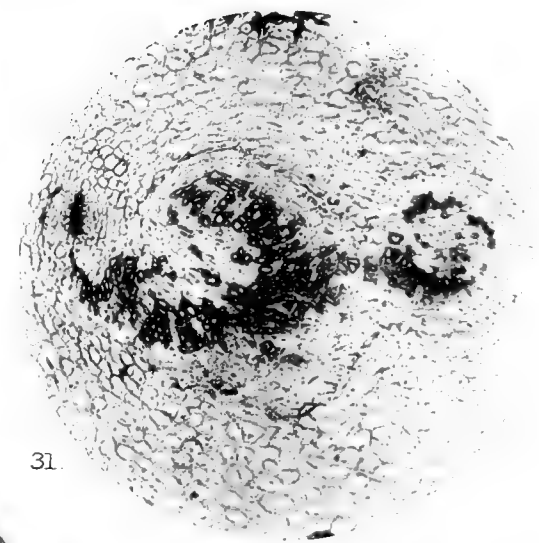
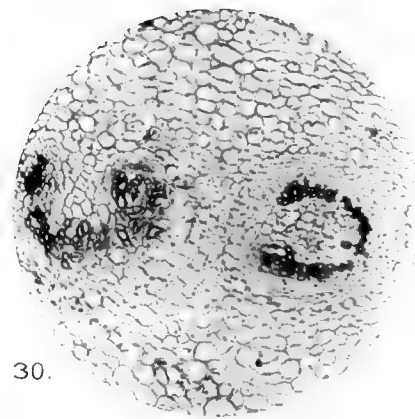
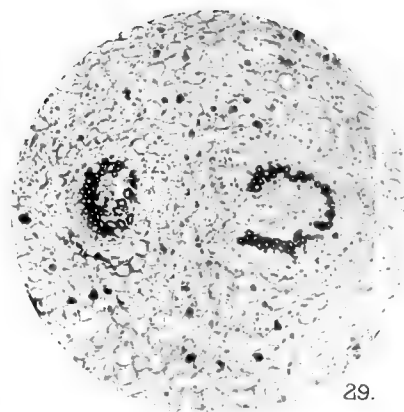

W.H. L. photo.

LANG — BOTRYCHIMUM LUNARIA

Herb. coll.



# Some Fossil Plants from Eastern Canada.<sup>1</sup>

BY

RUTH HOLDEN.

*Wilby Prize Student of Radcliffe College.*

With Plates XXII and XXIII.

THE geological formations of Eastern Canada, as a whole, have been well understood for a long time, owing mainly to the exhaustive researches of Sir William Dawson. There are, however, a few localities in Prince Edward Island and on the south shore of New Brunswick which have occasioned some uncertainty. Considering first New Brunswick, Dawson<sup>2</sup> has referred the greater part of the north coast of the Bay of Fundy to the Devonian. The only exceptions are one outcrop of Carboniferous age beginning about ten miles east of St. John, and three of Triassic, situated at Quaco, Salisbury Cove, and Gardiner's Creek. More recently, Mr. Ells<sup>3</sup> of the Canadian Government Survey discovered lignitic remains from the sandstones of Martin's Head, identical in anatomical structure with lignite from Quaco and the Trias of Prince Edward Island, described as *Dadoxylon Edvardianum*. Accordingly, it seems advisable to add Martin's Head to the list of Triassic localities.

As regards Prince Edward Island, Dawson<sup>4</sup> in 1868 considered this whole island to be Triassic, except for certain localities on the south shore, notably at Gallows Point and Des Sables. Here the red sandstones characteristic of the rest of the island are replaced by cliffs of a greyish, more argillaceous composition, which contain abundant fossil plants. The character of these remains, from their similarity to those of the Upper Coal Formation of Nova Scotia, led Dawson to the conclusion that these strata are, if not Permian, at least Upper Carboniferous. In 1871<sup>5</sup> these beds, together with a similar series on the west coast extending from Cape Wolfe towards the north point, are called 'Permo-Carboniferous'. Later,<sup>6</sup> this

<sup>1</sup> Contributions from the Phanerogamic Laboratories of Harvard University, No. 60.

<sup>2</sup> Dawson, J. W. : *Acadian Geology*, 3rd edition, p. 108.

<sup>3</sup> *Acadian Geology*, 4th edition, Notes and Addenda, p. 99.

<sup>4</sup> *Acadian Geology*, 3rd edition, pp. 116 ff.

<sup>5</sup> Dawson and Harrington : Report on the Geological Structure and Mineral Resources of Prince Edward Island.

<sup>6</sup> Dawson : *Journal Geological Society*, Aug. 1874.

view is set forth in greater detail with a proposition to divide the strata of the island into two groups, Permo-Carboniferous and Trias, the latter being subdivided into Upper and Lower. Since then, Mr. Francis Bain has discovered a number of fossil plants, including the so-called *Tylodendron Baini*, in the previously designated Lower Trias, which led him to regard it as Permian.<sup>1</sup> Still later, Mr. Ells of the Geological Survey of Canada re-examined the rocks of Prince Edward Island, and stated<sup>2</sup> that the greater part of the island is Permian, and that the Trias is of very limited extent.

Inasmuch as the beds under discussion, in both New Brunswick and Prince Edward Island, are richly fossiliferous, it seemed desirable to re-investigate them from a palaeobotanical standpoint. The receipt of the Wilby Prize of Radcliffe College enabled the writer to do this in the summer of 1911, and much material was collected from all these localities, which it is the object of this article to describe.

#### PRINCE EDWARD ISLAND.

Since the outcrops are much more numerous on Prince Edward Island, it will be advisable to describe them first. From Cape Traverse east to the Tryon River, there are occasional pieces of silicified wood to be picked up along the shore; they are, unfortunately, for the most part small and indifferently preserved. From Tryon River to Sable River, on the other hand, such pieces are exceedingly abundant, especially near Victoria. Here it is possible to collect specimens eighteen inches or more in length, and six or seven in diameter, lying partially buried in the mud and sea-weed, uncovered only at low tide. In addition to this petrified wood, many sandstone pith casts of *Tylodendron* may be found. From Sable River to Charlottetown good material is rare, though there is some wood at both Canoe Cove and Holland Cove. For some miles east of Charlottetown this fossiliferous layer is entirely lacking, but at Gallas Point, about twenty miles to the south-east, it reappears. Here tree trunks, sometimes two feet in diameter, may be seen extending into the cliffs. Usually the woody cylinder has been broken up and removed by the action of the tides, which accounts for the abundance of small pieces along the reefs. Pith casts may be found here, but they are comparatively rare. On the east side of Gallas Point, the grey fossiliferous sandstones are replaced by cliffs of a compact reddish sandstone, and in them are many impressions of *Tylodendron* and *Sternbergian* pith casts, *Cordaites* leaves, &c. On the islands of Hillsborough Bay, a ledge on the north shore of Governor's Island has an abundance of impressions, while at St. Peter's there are also pith casts of both the *Tylodendron* and *Sternbergian* types, together with a small amount of petrified wood.

<sup>1</sup> Canadian Record of Science, July, 1885.

<sup>2</sup> Report of 1883.



A considerable number of *Tyloedendron* pith casts and specimens of petrified wood were collected. All the wood from Gallas Point, St. Peter's, Holland Cove, and most of that from the vicinity of the Sable River, proved to be of different species of *Cordaites*. Certain specimens from Sable River, however, presented slightly different features, and will be referred to later.

Some of the pith casts presenting the characteristics of *Tyloedendron*, Weiss, and *Tyloedendron Baini*, Dawson, are shown in Pl. XXII, Figs. 1-9. Figs. 1-4 represent a particularly good specimen. It shows one of the swellings which recur at regular intervals, probably marking the nodes, and also the rhomboidal scars which completely cover the surface. These scars are of variable length, being considerably longer in the internodes than at the nodes. In the more highly magnified views (Figs. 3 and 4), it may be seen that the lower half of each rhombic area is characterized by a slit. This cast was found near Canoe Cove, almost entirely buried in the mud. Figs. 5 and 6 represent a similar specimen from the same locality. Here, too, the cleft ridges are well marked, but there is less of a nodal swelling. The upper part of Fig. 6 shows the pith to be crossed by transverse diaphragms similar to those of *Sternbergia*. Figs. 7-9 are different magnifications of another specimen. This specimen includes the region of the branch whorls, and also demonstrates the presence of diaphragms. Fig. 10 shows a petrified stem. This piece is of especial value, since it contains the pith, and also has a wound cap.

The nature of such stems was for a long time misunderstood. Weiss,<sup>1</sup> who originally defined the genus, considered them branches denuded of leaves. The rhombic areolae he took for the scars left by leaf-bases, and the split he believed to be caused by a resin canal. Potonié,<sup>2</sup> however, showed them to be pith casts, bearing the same relation to *Tyloedendron* as *Sternbergia* to *Cordaites*. The surface configuration he showed to be caused by the course of the protoxylem strands. The material from Prince Edward Island confirms these statements in detail. Pl. XXIII, Fig. 13, a transverse section of the stem shown in Fig. 10, shows the instanding protoxylems, causing the ridges and furrows on the stem. The manner of exit of the leaf-trace is elucidated by Figs. 15 and 16, cut from the same stem. When a protoxylem strand is going to the supply of a leaf, it starts from the furrow at the base of one of the rhombic scars. At first, it pursues a course which is chiefly upward and only slightly outward. Accordingly, it splits the scar, which does not become entire until about half-way up, when the trace turns and passes directly out. Fig. 15 shows one of these strands during its upward journey in the act of splitting the ridge; Fig. 16 shows it at the point where it begins to pass out. That its path is almost exactly

<sup>1</sup> Weiss: Die fossile Flora der jüngsten Steinkohlenformation u. des Rothliegenden im Saar-Rheingebiete, p. 182.

<sup>2</sup> Potonié, H.: Ueber die fossile Pflanzen-Gattung *Tyloedendron*. Jahrb. der Königl. Preuss. Geol. Landesanstalt, 1887, p. 311.

horizontal after it leaves the pith is demonstrated by the fact that a given transverse section of a stem sometimes includes a trace almost from pith to cortex. This 'hump' of the foliar strand is a perfectly constant phenomenon, each scar being characterized by the resulting slit.

The nature of the pith escaped the notice of Weiss, but, as recorded by Potonié, it is marked by anastomosing diaphragms. This feature has been referred to in connexion with Figs. 6 and 9; Fig. 14, a longitudinal section of the specimen represented in Fig. 10, also demonstrates their presence.

The ligneous structure of this interesting fossil was ascertained both from sections cut from undoubted *Tylo dendron*, and from pieces of petrified wood from the Sable River. It agrees exactly with that described by Dawson from Mr. Bain's specimen as *Tylo dendron Baini*,<sup>1</sup> and with that described by Potonié as *Araucarioxylon rhodeanum*,<sup>2</sup> Goepf. As represented by Figs. 17 and 18, the tracheides are pitted throughout their entire length, usually by one (Fig. 18), rarely by two (Fig. 17) rows of closely approximated pits. Further, the mouth of each pit is circular. As shown in Fig. 19 the rays are abundant, low, and normally uniseriate, though rarely diseriata.

There have been numerous theories as to the affinities of *Tylo dendron*. Its closely compressed and alternating pits clearly affiliate it with *Araucarioxylon*, Krauss. The question then arises whether it be related to the Cordaitales or to the Araucarineae. There are several criteria on which it has been proposed to differentiate the woods of these groups. Felix<sup>3</sup> attempted to do so on the number of pits on the radial wall of the tracheides: in *Cordaioxylon* there are generally three or four rows, while in *Araucarioxylon* there are normally but one or two. Gothan<sup>4</sup> enumerates several differences: in *Cordaioxylon* the mouth of the pit is elliptical, while in other Conifers, at least in the spring wood, it is usually circular. Further, the medullary rays of the Cordaitales are usually thirty to fifty cells high and two cells in width, as opposed to the Araucarineae, where they are rarely over ten cells in height or a single cell in width. On all these criteria, *Tylo dendron* is an Araucarian Conifer. Further, as pointed out by Potonié, the nodal swellings and instanding protoxylem strands causing the ridges and furrows of the pith casts are identical with similar structures in *Araucaria* and *Agathis*. Moreover, such characteristically Cordaitean features as the double leaf-trace, and the broad transitional region between primary and secondary xylem, are replaced by the Araucarian single trace and small amount of primary wood. Impressions present more evidence for merging

<sup>1</sup> Dawson: *New Plants of Erian and Carboniferous, and Character and Affinities of Palaeozoic Gym.*, p. 13.

<sup>2</sup> Potonié, loc. cit.

<sup>3</sup> Felix: *Ueb. d. verst. Hölzer von Frankenberg*, 1883.

<sup>4</sup> Gothan, W.: *Zur Anat. lebender u. foss. Gymn.-Hölzer*, 1905, p. 12.

*Tylo dendron* with the Araucarians. Several varieties of leafy branches, known as *Walchia*, and definitely associated with *Tylo dendron* pith casts, have been described, all bearing a close resemblance to different species of *Araucaria*. Of their fructifications little is known, further than that, as shown by Zeiller,<sup>1</sup> the scales of the female cone bear single seeds, another Araucarian feature. If all these criteria are reliable, the presence of *Tylo dendron* in Permian strata bears out the orthodox view that the Araucarineae are the oldest living family of the Coniferales.

When this evidence is weighed more carefully it is not so convincing. The worthlessness of Felix's distinction, based on whether or not the radial wall is covered with pits, Gothan has already detected. He points out<sup>2</sup> that *Dadoxylon stephanense* and *D. subrhodeanum* are described by Grand'Eury<sup>3</sup> as encircling Artisian pith casts; and yet the pitting of the radial walls of the tracheides is usually uniseriate. As regards the shape of the mouth of the pit, Gothan may be correct in stating that the pits of *Cordaites* always have elliptical openings, yet in the Conifers there seems to be no invariable rule. For example, *Agathis* has sometimes elliptical and sometimes circular openings, and such is the case throughout the Abietineae and Cupressineae. The other lines of evidence adduced above demonstrate that the relationship between *Tylo dendron* and the Cordaitales cannot be close, but do not prove a closer between *Tylo dendron* and the Araucarians. All living Conifers have low, uniseriate rays, instanding protoxylem strands, and no extensive development of primary wood. Though the character of the pitting of the tracheides suggests the Araucarian Conifers, recent investigations of Mesozoic woods have shown that closely compressed and alternating pitting is not the primitive condition for the Araucarineae.<sup>4</sup> Further, there are woods of the *Tylo dendron* type extending as far back as the Culm, yet no advocate of the antiquity of the Araucarian line would suggest that it extends as far as that. We can do no better than agree with Gothan<sup>5</sup> when he writes that '*Walchia* has not been proved to belong to the Araucarineae, and that the opposite is much more probable'.

#### SUMMARY.

1. There are abundant remains of *Tylo dendron* in the strata of the south shore of Prince Edward Island.

2. Since *Tylo dendron* is characteristic of the Permian, there can be no question that these strata are of that age.

<sup>1</sup> Zeiller: Études sur la flore fossile des dépôts houillers et permien des environs de Brive. Paris, 1892.

<sup>2</sup> Gothan: loc. cit., p. 15.

<sup>3</sup> Grand'Eury: Flore carbonifère du Dép. de la Loire, p. 257.

<sup>4</sup> Jeffrey, E. C.: The Araucarioxylon Type. Proceedings Am. Academy of Arts and Sciences, vol. xlviii, No. 13, Nov., 1912.

<sup>5</sup> Gothan, Walter: loc. cit., p. 13.

3. The affinities of *Tylodendron* are uncertain; it is not closely related to the Cordaitales, and there appear to be no sufficient grounds for relating it to any one living group rather than to another.

#### NEW BRUNSWICK.

Just west of Martin's Head, on the south shore of the Bay of Fundy, the grey sandstone characteristic of the Devonian gives way to cliffs of brown arenaceous rock, embedded in which there is a confusion of lignitic remains. Among them were found a number of tree trunks with woody cylinders much broken, but with the pith still present as a sandstone cast. Such casts were usually not more than 1 or 2 cm. in diameter, while others, from which all trace of organic material had disappeared, had sometimes a diameter of 5 or 6 cm. One, represented natural size in Fig. 11, was traced at least 100 cm. along the cliff without coming to any swellings such as are characteristic of the *Tylodendron* type of pith cast. In addition to these trunks there were some decorticated twigs, considerably flattened, but otherwise in a fair state of preservation. A few hundred feet further west this fossiliferous layer crops out again, containing bits of wood, but no twigs.

During the past winter this lignite has been subjected to a microscopic examination. To prepare it for sectioning, it was first softened by a sojourn of several days on a paraffin bath, in a mixture of equal parts of 70 per cent. alcohol and 5 per cent. caustic soda. The alkali was then thoroughly washed out with alcohol, and the lignite transferred to a mixture of glycerine and 30 per cent. alcohol. In this condition a preliminary examination may be made, the useless bits rejected, and those desired for further study treated with hydrofluoric acid, and then embedded in celloidin. Most of the wood was of no value from a structural standpoint, but occasionally well-preserved pieces were found. From these the ligneous structure could be ascertained without difficulty.

Fig. 11 shows one of the casts. As may be seen, the entire surface is covered with rhombic scars. These scars are of variable length, but always lack the slit characteristic of similar structures in *Tylodendron*. It may be suggested that imperfect preservation might have obliterated this feature, but examination of a large number of such casts, most of which were beautifully preserved, proves such not to be the case.

Thin sections of the small lignitic twigs referred to above show that the furrows of the pith cast represent instanding protoxylem strands. As would be inferred from the absence of a slit, the foliar trace passes out directly from the medulla, without the 'hump' characteristic of *Tylodendron*. The leaf-strand is single when it leaves the pith, but forks during its passage through the wood. A similar condition may be seen in the living *Agathis*. Fig. 24 shows in transverse section one of these traces in the process of splitting; Fig. 23 shows the double trace immediately after the split. In

these illustrations the division is approximately in a horizontal direction, but more frequently it is oblique, so that in a given transverse section the trace appears single all the way out. That the foliar traces are not persistent, as in both the living members of the Araucarineae, may be inferred from their abundance in the twigs and complete absence in the mature wood. The pith itself never contains diaphragms like those of *Cordaites*, *Tyloedendron*, and certain members of the living Abietineae. On the contrary, it is homogeneously parenchymatous, as shown in Fig. 20, a longitudinal section of one of the small lignitic twigs.

The wood itself is composed of tracheides and rays. The former are isodiametric, with no trace of annual rings; they are usually empty, though sometimes filled with a dark, pitch-like substance. The entire length of the radial wall is covered with bordered pits, which are always uniseriate and usually scattered. Fig. 22 represents a typical condition, though frequently they are further apart than is shown here, and rarely they are so closely compressed as to be flattened and angular. While they are as distant as the pits of the Abietineae and Taxodineae, they are never, as is the rule in these groups,<sup>1</sup> separated by the so-called bars of Sanio (cellulose thickenings embedded in the substance of the cell-wall). In this respect they resemble the wood of such types as *Brachyoxylon*<sup>2</sup> and *Paracedroxylon*.<sup>3</sup> As opposed to the latter, however, the mouths of the pits are sometimes circular and sometimes elliptical.

There is no vertical wood parenchyma, but ray parenchyma is extremely abundant. As is shown in Fig. 21, the rays are highly resinous and invariably uniseriate; their tangential and horizontal walls are thin and unpitted, but the radial walls have from 2 to 4 small piciform pits to each cross-field. The characteristics of the rays are thus seen to be exactly like those of the living Araucarineae.

Having described the salient points in the anatomy of our fossil, we may now consider its affinities. It seems probable that this wood represents the *Dadoxylon Edvardianum* described by Dawson<sup>4</sup> as characteristic of the Trias of Prince Edward Island, Quaco, and Martin's Head, for although his specimens differ in having the radial walls of the tracheides covered with 1-2 rows of contiguous, hexagonal pits, they agree with ours in such characters as simple rays, and absence of either annual rings or transverse lamellae in the pith. The discrepancy in the matter of pitting is probably due to imperfect preservation of the tissue in question in the case of the material investigated by Sir William Dawson.

<sup>1</sup> Gerry, Eloise: The Distribution of 'Bars of Sanio' in the Coniferales. *Annals of Botany*, xxiv, pp. 119-24, 1910.

<sup>2</sup> Hollick, A., and Jeffrey, E. C.: Studies of Cretaceous Coniferous Remains from Kreisler-ville, N.Y. *Mem. N. Y. Bot. Garden*, 3, pp. 1-138, 1909.

<sup>3</sup> Sinnott, E. W.: *Paracedroxylon*. *Rhodora*, II, pp. 165-73, 1909.

<sup>4</sup> Dawson, J. W.: *Acadian Geology*, 4th edition, Notes and Addenda, p. 99.

The pith cast is the most distinctive feature of our fossil. It suggests at once *Tylo dendron*, but differs from that characteristically Permian type in that there are no periodic swellings, and that the rhombic areolae are never slit at the lower end. Professor Seward<sup>1</sup> has described specimens of the pith casts of *Voltzia heterophylla*, Brongn., in the Strassburg Museum, which resemble the New Brunswick casts in the absence of nodal swellings, but differ in having the scars always slit like those of *Tylo dendron*. His observations are confirmed by those of Blankenhorn,<sup>2</sup> though it is possible that the latter author is referring to impressions of decorticated, and not delignified, stems. In the description of Weiss,<sup>3</sup> there is no doubt that such is the case, since he notes that each rhombic area, in addition to the slit, has in the centre an elliptical scar with a central thickening. Bronn<sup>4</sup> is also probably referring to surface impressions. Our specimen is, however, identical with a specimen of *Voltzia coburgensis*, Schaur., from the Keuper of Coburg, loaned by Professor Arthur Willey from the Peter Redpath Museum of McGill University, Montreal. Fig. 12 represents this cast, and its detailed resemblance to the New Brunswick specimen of Fig. 11 is evident. That this is *V. coburgensis* is shown beyond question by its similarity to the type figured by Schenk<sup>5</sup> from the Lettenkohle of Estenfeld. On the other hand, *V. coburgensis*, as figured by Potonié<sup>6</sup> under the name of *Voltziopsis coburgensis*, has sometimes the slit scars of *V. heterophylla*, though usually there is no slit. Further, the description of *Glyptolepis coburgensis*,<sup>7</sup> Schimper, which both Schimper himself and Potonié<sup>8</sup> consider the same as *Voltzia coburgensis*, Schaueroth, contains the following: 'cicatrices in ramis derelictis quadrato-rhombeae.' If by 'ramis derelictis' Schimper means pith casts, there seems to be every reason for calling our specimen *Voltzia coburgensis*. Schimper, however, goes on to say that the wood of *Glyptolepis* is probably *Araucarioxylon keuperianum*, Goepp. *Araucarioxylon keuperianum*<sup>9</sup> or *Dadoxylon keuperianum*<sup>10</sup> agrees with our specimen in the absence of annual rings, but differs in that the radial pits are sometimes biseriata, and always approximated closely; further, the rays are occasionally two cells in width. Accordingly, if Schimper be correct in referring the wood of *Araucarioxylon keuperianum*

<sup>1</sup> Seward, A. C. ('90): *Tylo dendron*, Weiss, and *Voltzia heterophylla*, Brongn. Geol. Mag., p. 218.

<sup>2</sup> Blankenhorn ('86): Die fossile Flora des Buntsandsteins und des Muschelkalks der Umgegend von Commern. Palaeontograph, vol. xxxii, p. 135, Pl. XXII.

<sup>3</sup> Weiss, C. E.: Ueber *Voltzia* und andere Pflanzen des bunten Sandsteins zwischen der unteren Saar und dem Rheine. N. Jahrb. f. Min., 1864, p. 279.

<sup>4</sup> Bronn: N. Jahrb. f. Min., 1858, p. 139.

<sup>5</sup> Schenk: Beiträge zur Flora der Vorwelt. Palaeontograph, vol. ii, p. 308, Pl. XLVI, Fig. 2.

<sup>6</sup> Potonié, H.: Lehrbuch der Pflanzenpalaeontologie, p. 302.

<sup>7</sup> Schimper: Palaeontologie végétale, v. 2.

<sup>8</sup> Potonié: loc. cit., 303.

<sup>9</sup> Goeppert, Monog. Conif. foss., p. 234.

<sup>10</sup> Endlicher: Syn. Conif., p. 289; Unger: Gen. et Spec., p. 379.

to *Voltzia coburgensis*, although he admits that he never found them in actual connexion, our specimen cannot be identified with his. The evidence furnished by the Coburg specimen and by Schenk's figure is, however, sufficient to warrant referring the New Brunswick fossils to *Voltzia coburgensis*, Schaur.

Before discussing further its affinities, it is necessary at this point to refer briefly to its external features. As defined by Brongniart,<sup>1</sup> *Voltzia* closely resembles *Araucaria excelsa* in general habit, even in heterophylly. The cones, however, are stated to have nothing in common with *Araucaria*, but simulate closely those of the Taxodineae, notably *Cryptomeria*. Each scale is double, consisting of a so-called 'Samen-' or 'Fruchtschuppe' which bears the seeds (two in *V. coburgensis*), and a 'Deckschuppe'. The 'Samenschuppe', or ovuliferous scale, is more or less deeply lobed. There are a number of minor differences between *V. heterophylla* and *V. coburgensis*, in the foliage, and especially in the structure of the cone. In the former, the cones are solitary, not more than three times as long as broad, and the cone scale is deeply two or three lobed, as contrasted with the latter, where the cones are grouped, ten times as long as broad, and the cone scale only crenulate. Further, *V. heterophylla* does not occur after the Muschelkalk, where it is replaced by *V. coburgensis*, which extends well into the Jura. Schimper recognized these differences and proposed to change the name *V. coburgensis* to *Glyptolepis coburgensis*;<sup>2</sup> while Potonié<sup>3</sup> used the name *Voltziopsis coburgensis* to include the cones of *Glyptolepis*, the pith casts of *Voltzia coburgensis*, and certain impressions known as *Cheirolepis*. Zittel,<sup>4</sup> however, does not consider these differences as of sufficient importance to warrant a generic distinction. The difference in configuration of the pith cast seems considerable, but until the wood structure of *Voltzia heterophylla* is known the best evidence is unavailable.

As regards systematic position, *Voltzia* is usually placed under the Taxodineae, as by Zittel,<sup>5</sup> Gothan,<sup>6</sup> Potonié,<sup>7</sup> Zeiller,<sup>8</sup> &c. Although the resemblance of the leaves to those of *Araucaria* is recognized, and the bract on the back of the ovuliferous scale homologized by Potonié with the ligule of *Araucaria*, the double nature of the cone scale is generally considered enough to justify including it with the Taxodineae. On the other hand, Endlicher, Unger, and Goepfert put it with the Cupressineae, while Schimper places it with the Abietineae. Recent investigations have shown the futility of attempting to classify on the basis of external appearances. For example, Dr. Jeffrey has shown that the genera *Geinitzia*,

<sup>1</sup> Brongniart, Ad. : Ann. Sci. Nat., Sér. 1. t. 15, 1828.

<sup>2</sup> Schimper : Paléontologie végétale.

<sup>3</sup> Potonié : Lehrbuch, p. 303.

<sup>4</sup> Zittel, Karl : Palaeontologie, p. 288.

<sup>5</sup> Zittel : loc. cit., p. 287.

<sup>6</sup> Gothan : Ueber die Coniferen und ihre Verwandten in ihrer Vorgeschichte. Naturwissenschaftliche Wochenschrift, June, 1911.

<sup>7</sup> Potonié : loc. cit., p. 300.

<sup>8</sup> Zeiller : Éléments de Paléobotanique, p. 267.

*Brachyphyllum*, *Widdringtonites*, *Thuyites*, &c., all previously referred to the Taxodineae or Cupressineae, are really, judged by anatomical structure, Araucarian Conifers.<sup>1</sup> A similar fate seems destined for *Voltzia coburgensis*. As regards external features, the size and general appearance of the leaves are Araucarian, while the double cone scale and two seeds are distinctly Abietineous. As regards internal structure, the nature of the medullary rays, absence of wood parenchyma, and large pith are Araucarian; while the scattered position of the pits is Abietineous. By far the most reliable criterion for diagnosing coniferous woods is the occurrence of 'bars of Sanio', since, as shown by Miss Gerry (op. cit.), they are present invariably in all coniferous tribes except the Araucarineae. *Voltzia* accordingly appears to be beyond question Araucarian. Within the last few years a number of fossil woods have been described by Gothan, Seward, Jeffrey, Sinnott, and others, which possess different combinations of structures which to-day are confined exclusively to either the Abietineae or Araucarineae. That these are transitional forms between the two great groups of Conifers seems evident, the question being whether they represent Araucarians on the way to becoming Abietineae, or vice versa. Dr. Jeffrey,<sup>2</sup> by a study of comparative anatomical, experimental, and palaeobotanical evidence, appears to have demonstrated that the Abietineae are older, and that it is the Araucarineae which become progressively more and more like the Abietineae in successively older geological formations. *Voltzia* is probably one of the earliest of these intermediate types; *Woodworthia*, which presents other combinations of Abietineous and Araucarian characters, is also Triassic. The antiquity of these genera does not in any way discount Dr. Jeffrey's phylogeny, for the distinguished and experienced palaeobotanist Nathorst, as a result of his extensive studies of the Mesozoic coniferous flora of northern Europe, has reached the conclusion that the Abietineae were abundant in circumpolar regions in the Trias.<sup>3</sup>

*Voltzia* is of especial interest in view of the different theories which have been advanced to explain the organization of the female cone of the Conifers. The generally accepted interpretation is that the Abietineous ovuliferous scale and sterile bract have, in the Taxodineae and Cupressineae, become more and more fused, though their double nature is still evident in some genera, e. g. *Cryptomeria*. It has been suggested by Seward<sup>4</sup> and Thomson<sup>5</sup> that the cone scale of the Araucarineae is entirely different morphologically from that of the remaining Conifers. It seems more probable, however, that in

<sup>1</sup> Hollick, A., and Jeffrey, E. C.: loc. cit.

<sup>2</sup> Jeffrey, E. C.: The Araucarioxylon Type. Proc. Am. Acad. Arts and Sciences, vol. xlviii, No. 13, Nov., 1912.

<sup>3</sup> Nathorst: Beiträge zur fossilen Flora Schwedens. 4<sup>o</sup>, Stuttgart, 1878.

<sup>4</sup> Seward, A. C., and Ford, Sibille O.: The Araucarineae, recent and extinct. Phil. Trans. Royal Soc., series B, vol. cxcviii, pp. 305-411, Pls. XXIII and XXIV.

<sup>5</sup> Thomson, R. B.: The Megasporephyll of *Saxegothea* and *Microcachrys*. Bot. Gazette, 47, 345-54, Pls. XXI-XXV, 1909.



them the process of adhesion has become more and more complete, until in *Agathis* there is no external evidence of the primitively double nature of the cone scale, while in *Araucaria* the sterile bract is now represented by the ligule. That this is the true explanation is indicated by the double series of vascular bundles in the cone scale of some species of *Araucaria*. That *Voltzia*, whose Araucarian affinities are proved by the absence of 'bars of Sanio', should have a double scale similar to that of *Cryptomeria*, is additional evidence that the condition now obtaining in the living Araucarians is, as in the Cupressineae and Taxodineae, the result of a coalescence of parts originally separate. As an intermediate stage between that of living Araucarineae and that of the Triassic *Voltzia* may be mentioned the Cretaceous *Protodammara*, which has a single scale and three seeds. It is interesting to note that the *Voltzia* type of cone scale, consisting of two segments, persisted into the Cretaceous. Hollick and Jeffrey (op. cit.) described this form under the name of *Dactylolepis cryptomerioides*, diagnosing it as Araucarian, with the suggestion that if there should prove to be any close affinity between this specimen and *Voltzia*, the latter would have to be removed from the Taxodineae, and placed in the Araucarineae. That this suggestion was justified is now evident from the wood structure of *Voltzia coburgensis*.

The occurrence of plant remains at Martin's Head is of importance in correlating the Trias of New Brunswick with that of the eastern United States. Newberry<sup>1</sup> figures, from the Newark of New Jersey, a pith cast which strongly resembles those from Martin's Head. He calls his specimen *Palissya*, though stating that the resemblance to *Voltzia coburgensis* is so great, that he is deterred from diagnosing it as such only by the absence of foliage referable to that genus. Both he and Fontaine<sup>2</sup> mention the occurrence of *Cheirolepis*, which Potonié (loc. cit., p. 303) considers to be sufficiently near to *V. coburgensis* to justify its inclusion in his new genus *Voltziopsis*. Accordingly, it seems probable that *V. coburgensis* is common to both localities. Another bit of evidence that these beds are coeval is afforded by the presence at Martin's Head of an *Equisetum*, which seems identical with that figured by Fontaine as *Equisetum Rogersii*, Schimper. Different authorities have correlated the Trias of the eastern United States with every horizon from the Permian to the Jura. Fontaine (loc. cit.), from a comparison of the plants, concluded that it is Rhaetic, but more recently Stur<sup>3</sup> showed that it is nearer the German Lettenkohlen or Lower Keuper. This conclusion is borne out by the plant remains from Martin's Head; for

<sup>1</sup> Newberry, J. S.: Fossil Fishes and Fossil Plants of the Triassic Rocks of New Jersey and Connecticut Valley. Monographs of U.S. Geol. Survey, 14, 1888.

<sup>2</sup> Fontaine: The Older Mesozoic Flora of Virginia. Monographs of U.S. Geol. Survey, 6, 1883.

<sup>3</sup> Die Lunzer-Lettenkohlen in den 'Older Mesozoic Beds of the Coal-Field of Eastern Virginia'. Verh. KK. Geol. Reichsanst., 1888, pp. 203-17.

*Voltzia coburgensis* has been described by Schenk (loc. cit.) as abundant in the Lettenkohle, and *Equisetum Rogersii*, Schimper, is probably identical with *E. columnaris* described by Bronn, also from the Lettenkohle. This correlation applies only to Martin's Head and the fossiliferous layers in the Trias of the eastern United States, so that, as pointed out by Wherry,<sup>1</sup> it is entirely possible that the Bunter below and the Rhaetic above may be represented also in the Connecticut Valley, New Jersey, Pennsylvania, and Virginia.

#### SUMMARY AND CONCLUSIONS.

1. There are present in the Trias of Martin's Head, New Brunswick, specimens of a Conifer which, on the character of the pith cast, may be referred to *Voltzia coburgensis*, Schaur.

2. The foliage of *Voltzia coburgensis* is Araucarian; the organization of the cone, Abietineous; and the anatomical structure intermediate between these two groups.

3. *Voltzia coburgensis* seems to be another transitional form and presents additional evidence for the derivation of the Araucarineae from the Abietineae.

4. Palaeobotanical evidence indicates that the Mesozoic strata of New Brunswick are of the same age as those of the eastern United States, and should be correlated with the Lettenkohle or Lower Keuper of Europe.

In conclusion, I wish to thank Dr. E. C. Jeffrey for helpful advice and assistance in securing the photomicrographs accompanying this article. I wish also to express my thanks to Professor Arthur Willey, of McGill University, for the loan of a specimen of *Voltzia coburgensis*.

---

#### EXPLANATION OF PLATES XXII AND XXIII.

Illustrating Miss Holden's paper on Fossil Plants from Eastern Canada.

##### PLATE XXII.

- Fig. 1. Pith cast of *Tylodendron*.  $\times \frac{3}{4}$ .  
 Fig. 2. Opposite side of same cast.  $\times \frac{3}{4}$ .  
 Fig. 3. Lower part of same cast.  $\times 1\frac{1}{2}$ .  
 Fig. 4. Nodal swelling of same cast.  $\times 1\frac{1}{2}$ .  
 Fig. 5. Another *Tylodendron* pith cast.  $\times \frac{3}{4}$ .  
 Fig. 6. Same cast, opposite side.  $\times \frac{3}{4}$ .  
 Fig. 7. Another cast.  $\times 1\frac{1}{2}$ .

<sup>1</sup> Wherry, Edgar T.: Age and Correlation of the 'New Red' or Newark Group of Pennsylvania. Proceedings Acad. Nat. Sciences of Philadelphia, July, 1912.

- Fig. 8. Same cast.  $\times \frac{3}{4}$ .  
Fig. 9. Opposite side of same cast.  $\times \frac{3}{4}$ .  
Fig. 10. Specimen of petrified wood.  $\times \frac{3}{4}$ .  
Fig. 11. Pith cast of *Voltzia coburgensis* from New Brunswick.  $\times 1$ .  
Fig. 12. Pith cast of *Voltzia coburgensis* from Coburg.  $\times 1$ .

PLATE XXIII.

- Fig. 13. Transverse section of *Tylodendron* stem shown in Fig. 10.  $\times 1^1$ .  
Fig. 14. Same stem, radial section.  $\times 2$ .  
Fig. 15. Portion of same stem, transverse section.  $\times 60$ .  
Fig. 16. Another portion of same.  $\times 60$ .  
Fig. 17. Same, radial section.  $\times 500$ .  
Fig. 18. Same, another radial section.  $\times 700$ .  
Fig. 19. Same, tangential section.  $\times 500$ .  
Fig. 20. *Voltzia coburgensis*, radial section.  $\times 60$ .  
Fig. 21. Same, tangential section.  $\times 500$ .  
Fig. 22. Same, radial section.  $\times 500$ .  
Fig. 23. Same, tangential section.  $\times 60$ .  
Fig. 24. Same, transverse section.  $\times 60$ .





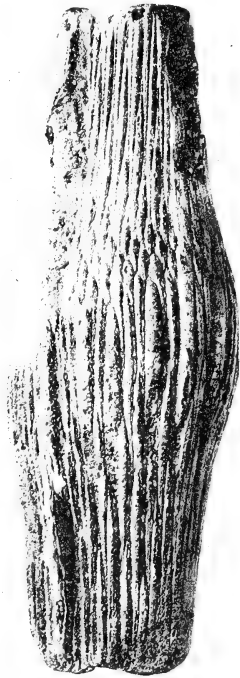

1.



2.



3.

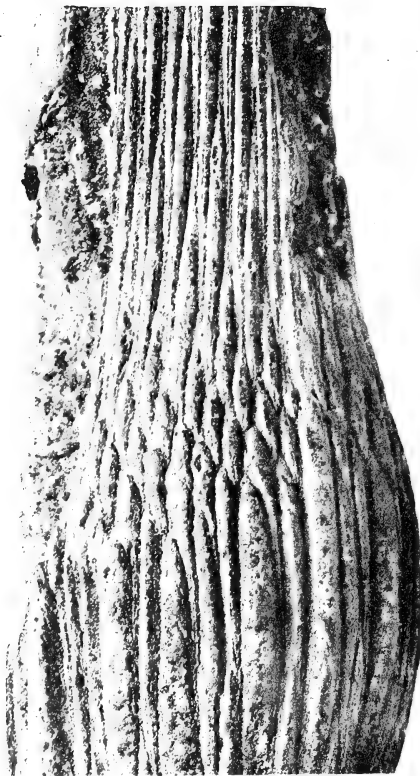

4.

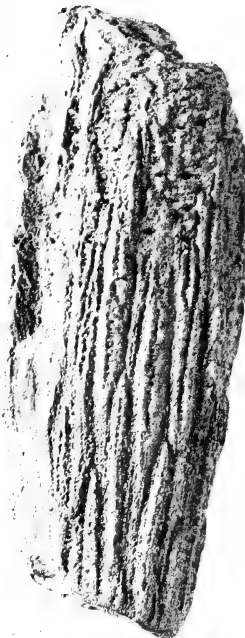

5.



6.

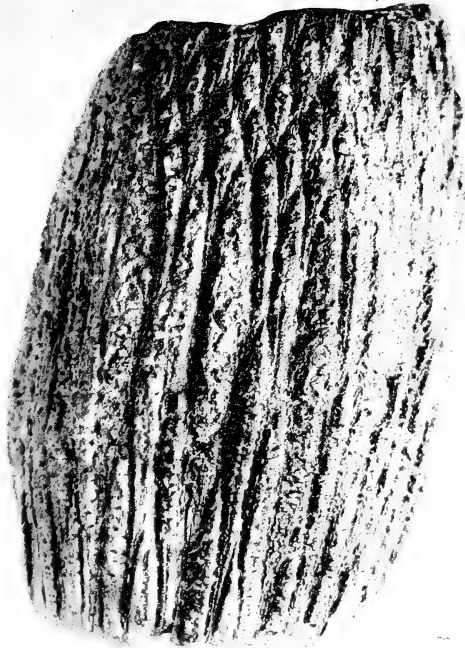

7.



8.



9.



10.

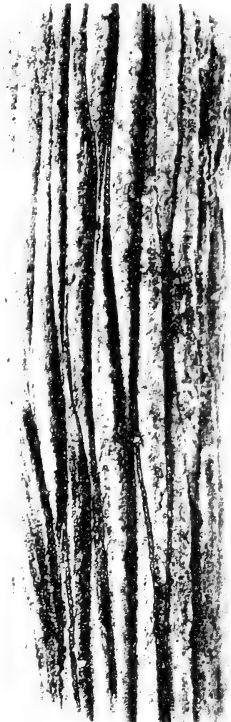

11.

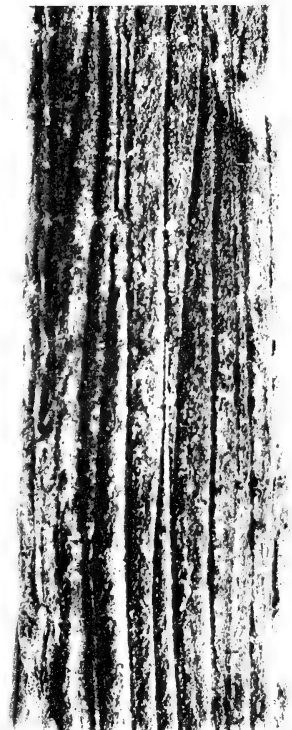

12.







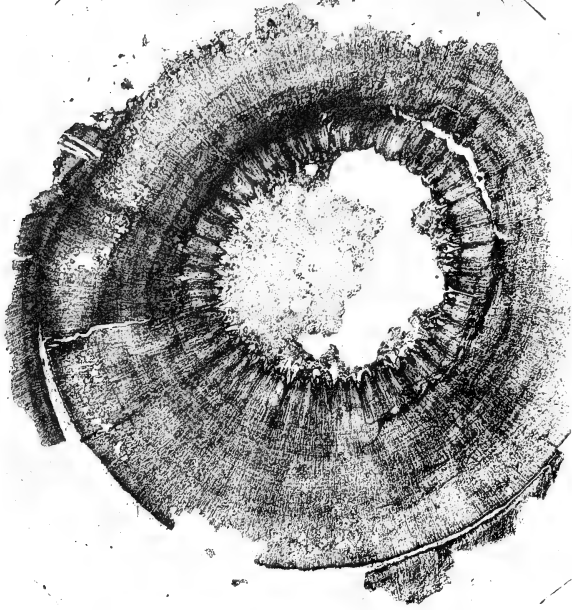

13.

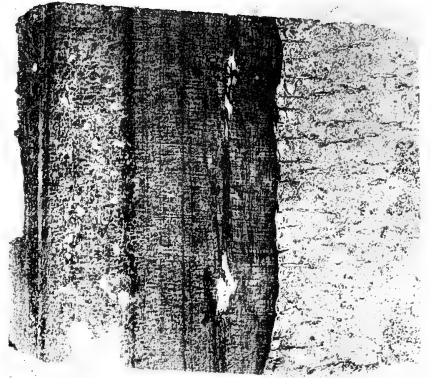

14.

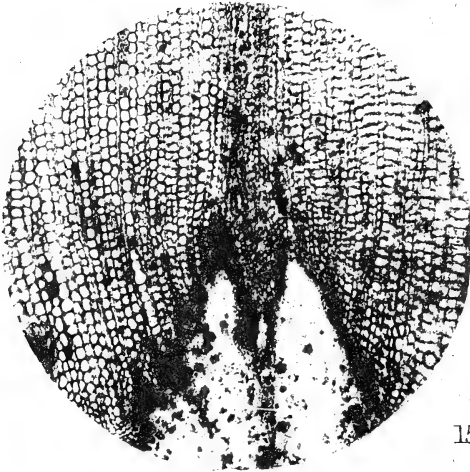

15.

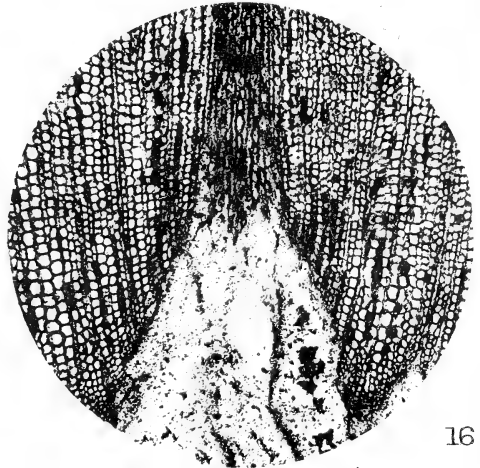

16.

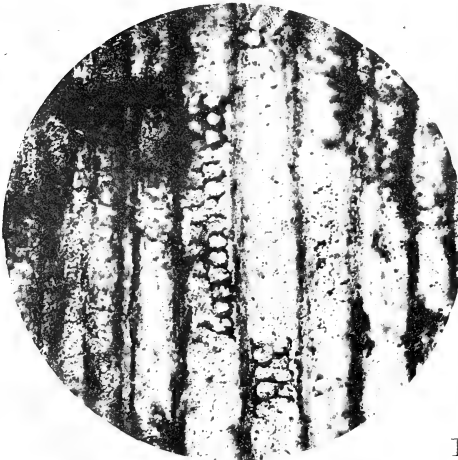

17.

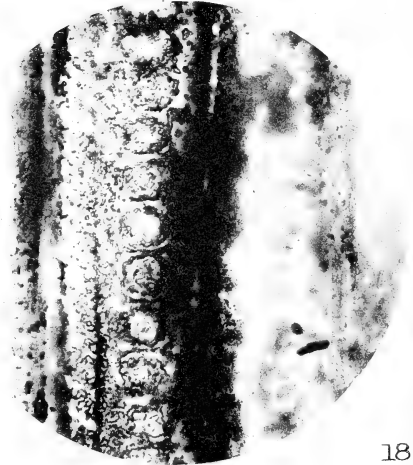

18.



19.

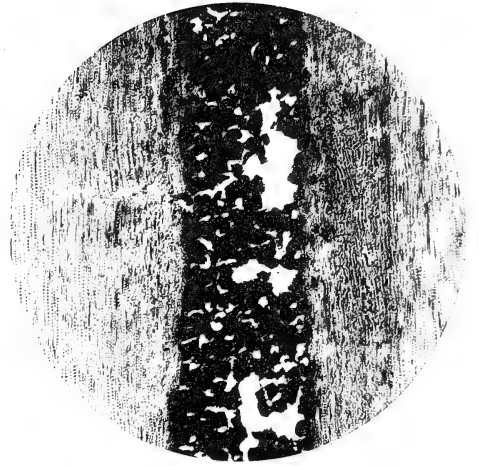

20.

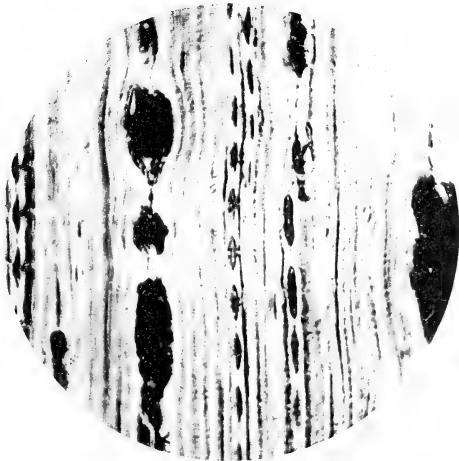

21.

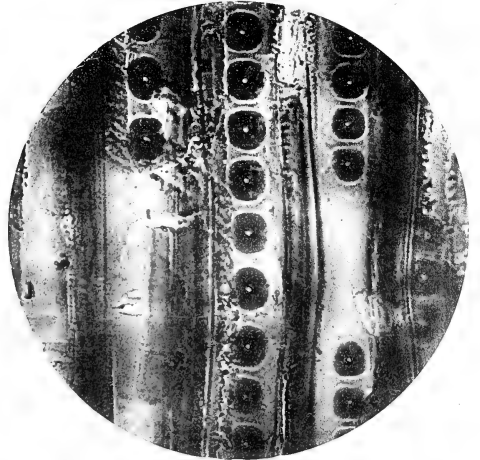

22.



23.



24.

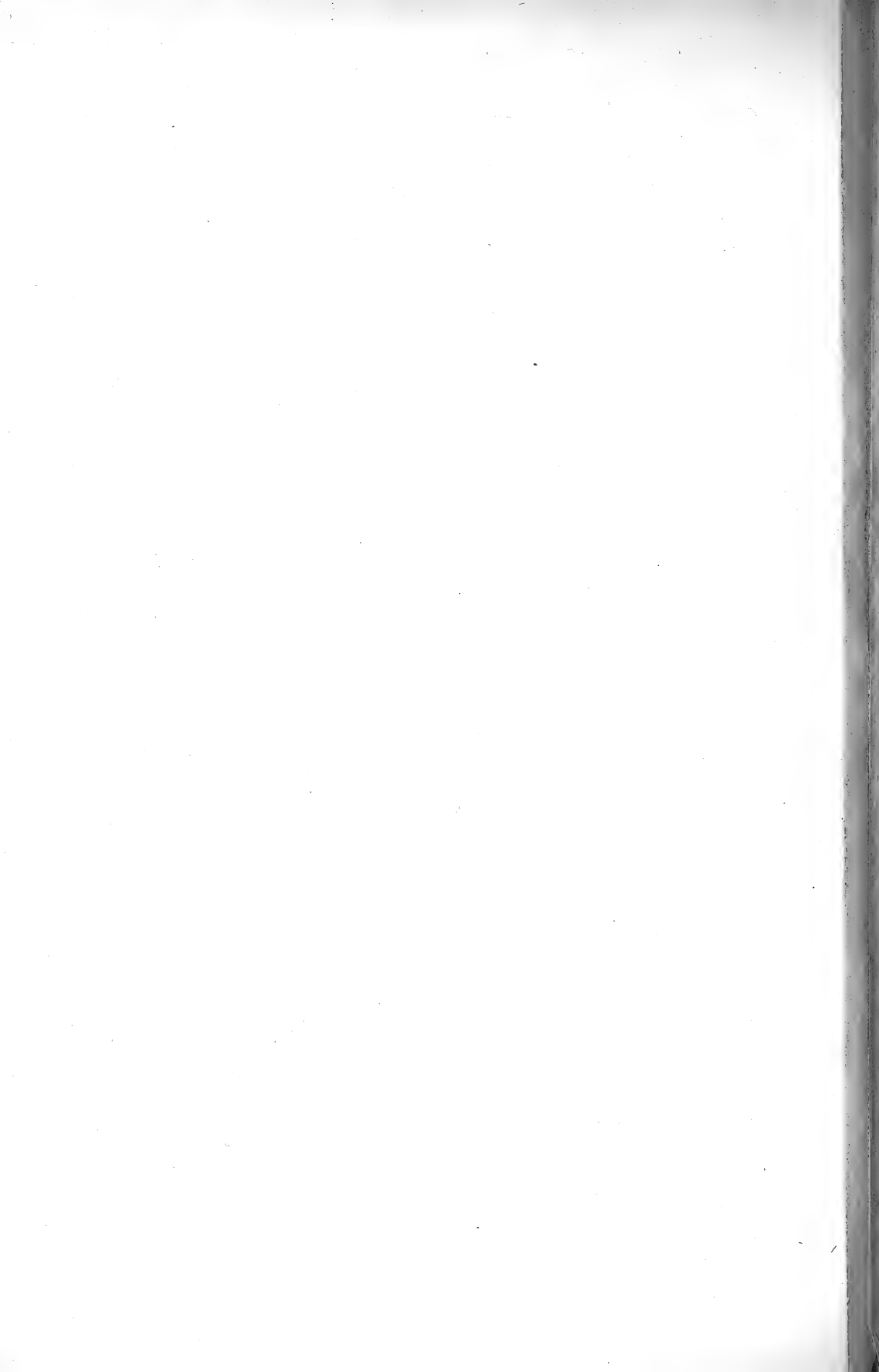

# A Consideration of the Facts relating to the Structure of Seedlings.

BY

T. G. HILL

AND

E. DE FRAINE.

With a Curve, two Diagrams and one Figure in Text.

THE consideration of the facts relating to the structure of seedlings leads to interpretations and conclusions which differ according to the habit of mind of the investigator; it is not proposed to enter into all of these here, but merely to give expression to some ideas which are the outcome of our work on this subject.<sup>1</sup>

At the present day anatomical investigations in the main are carried out from the point of view either of phylogeny or of physiology, and the subject of seedling anatomy may conveniently be considered from these two aspects.

## PHYLOGENY.

For the purposes of argument, it may be assumed that the cotyledons are really the same thing as foliage leaves—and this is our opinion—although modified to perform special functions; if they be organs *sui generis*, as is sometimes supposed, then much, if not all, of the interest attaching to them from the point of view of phylogeny disappears.



The examination of a large number of plants will generally lead to the possibility of arranging them in a series with the most complex and the most simple situated on either flank. The difficulty arises in deciding which of the two extremes is primitive, and here there seems to be a some-

<sup>1</sup> Hill, T. G.: On the Seedling-structure of certain Piperales. *Ann. Bot.*, xx, 1906. Hill, T. G., and de Fraine, E.: On the Seedling-structure of Gymnosperms, Pt. I. *Ann. Bot.*, xxii, 1908; Pt. II, id., xxiii, 1909; Pt. III, id., xxiii, 1909; Pt. IV, id., xxiv, 1910. de Fraine, E.: The Seedling-structure of certain Cactaceae. *Ann. Bot.*, xxiv, 1910. Hill, T. G., and de Fraine, E.: On the Seedling-structure of certain Centrospermae. *Ann. Bot.*, xxvi, 1912. Hill, T. G., and de Fraine, E.: On the Influence of the Structure of the Adult Plant upon the Seedling. *New Phyt.*, xi, 1912.

what remarkable unanimity of opinion, for it appears to be generally fashionable to consider the more complicated structures to be the more primitive, and from them to derive most simpler organizations. Indeed, there appears to be some danger of the theorem 'Reduction in Descent' becoming an axiom.<sup>1</sup>

This is perhaps natural, for it is certainly easier to work on this hypothesis than on its reverse: it is pretty safe to prophesy that Macaulay's New Zealander, when he does come to England and rummages in the ruins of Science Museums, will conclude that Stephenson's 'Rocket' and similar engines are reduced structures, and that the primitive locomotive is to be found in some such form as the 'Duchess of Cornwall'; he will certainly recognize in the 'Atlantic' a synthetic type, and he will indeed be a genius if he sees in the tea-kettle the forbear of the 'Rocket'.

We do not, of course, desire to imply that reduction in descent does not obtain, but rather to express the opinion that there is sometimes a tendency to invoke it without due consideration of the alternative proposition.

Either proposition is merely a generalized statement; no doubt if the ancestry of any plant were intimately known, it would be found that its evolutionary curve is neither  $\diagup$  nor  $\diagdown$ , but either  or ; that is to say, its history would show periods of specialization and amplification and periods of reduction, the general character of the curve depending on which side the resultant falls.

The matter is further complicated by the fact that a plant is a complex of characters, some of which are primitive, others reduced—sometimes to a condition which is indistinguishable from the primitive—whilst others are specialized, and, unfortunately, practically nothing is known about the interaction between the different characters. Thus in the case of Gymnosperms it does not follow, we think, that 'the coniferous forms show reduction'—with regard to their seedling anatomy—'on the Cycad type, . . . on the grounds of the generally acknowledged antiquity and primitiveness of the latter group'.<sup>2</sup>

And this opinion, apart from other considerations, which will be dealt with later, is supported by the fact that the cotyledons of *Ginkgo* and some Cycads are characterized by the presence of stomata.<sup>3</sup> This is a very surprising fact if the seed leaves of these plants have always been hypogeal and embedded in the endosperm of the seeds; it rather indicates that the hypogeal habit is a derived habit. Further, it may be remarked that neither tetrarchy nor diarchy is dominant in these plants,<sup>4</sup> and also that there

<sup>1</sup> Tansley, A. G. : Reduction in Descent. New Phyt., i, 1902.

<sup>2</sup> Thomas, E. N. : A Theory of the Double Leaf-trace founded on Seedling Structure. New Phyt., vi, 1907.

<sup>3</sup> Wigglesworth, G. : The Cotyledons of *Ginkgo biloba* and *Cycas revoluta*. Ann. Bot., xvii, 1903.

<sup>4</sup> Hill, T. G., and de Fraine, E. : Gymnosperms, Pt. III, loc. cit.

is a striking inconsistency in the behaviour of the cotyledonary bundles in the transition region.<sup>1</sup>

In attempting to determine the main question—primitive or reduced—the investigator naturally turns to the fossil plants to see what evidence they afford. Unfortunately, in the case of seedling-structure such evidence is practically nil; in fact it obtains only in one plant, *Bennettites*, which approximates so closely to the living Cycads that it affords practically no aid in the present connexion. Incidentally, it may be remarked that the Coniferae are of very great antiquity, and go back at least as far as the Permian, whereas the Cycadaceae first appear in mesozoic times.

We are, therefore, driven to the existing Pteridophytes, which is not altogether satisfactory, since they may not follow in many of the details of their structure the organization of their ancestors and of the other phyla to which their ancestors may have given origin. The further objection may be raised against the comparison of, say, Gymnosperms and Pteridophytes on account of the differences due to the seed habit.

In the modern Pteridophytes certain features, with regard to the structure of the sporelings, stand out with remarkable clearness.

1. The primary root is almost invariably diarch.
2. The leaf-trace of each of the first two leaves of the sporeling is a single strand.
3. These bundles show no signs of bifurcation such as obtains in so many of the higher plants.
4. There is no hypocotyl in the sense of this structure in the higher plants.

Considering these features; with regard to the root it is not at all remarkable that the organization of the primary root of a Fern and of a higher plant are so similar, for the radicle is one of the most conservative members of the plant, since its functions are definite, and there is no reason to suppose that the conditions of the existence of roots have altered to any appreciable degree through the ages, so that a variety of structure has not been called into being to meet varying requirements.<sup>2</sup>

It therefore does not appear unreasonable to suppose that a diarch root-structure is primitive: amongst the Angiosperms such an organization is extremely common, and with regard to the Gymnosperms diarchy, as far as our observations go, is by far the most common. This is shown in the following table, which gives the number and percentage of species of Gymnosperms in which the number of root-poles was constant within the limits indicated in the first column.

<sup>1</sup> Hill, T. G., and de Fraine, E.: Gymnosperms, Pt. III. Ann. Bot., xxiii, 1909, p. 456.

<sup>2</sup> In this connexion primary root-structure only is considered.

TABLE I.

No. of Root-poles.	No. of Species examined.	Percentage.
2	31	40.8
3	16	21.1
2 or 3	5	6.6
3 or 4	8	10.5
4	7	9.2
2, 3 or 4	2	2.6
4 or 5	2	2.6
5	2	2.6
6	1	1.3
3, 4 or 6	1	1.3
8	1	1.3

Triarchy, tetrarchy, and combinations of these occur in association with the third type of transition—which is correlated with a diarch root-structure—owing to the disturbing influence of polycotyledony or, in other cases, to a marked increase in the size of the seedling. And it is worthy of remembrance that even in those cases where the root-structure is to begin with 4-, 5-, or 6-arch, reduction to diarchy very commonly takes place.<sup>1</sup> Thus although, for obvious reasons, young seedlings, whenever possible, only were examined, no less than fourteen species were found to exhibit such a reduction. On the other hand, it is only fair to point out that the initial number of poles showed an increase, on being traced downwards, in seven species; but this obtained chiefly in the Cycadaceae, and in certain cases a subsequent reduction took place. In fact, this local variation in the number of poles of the root-structure is very commonly found in plants which have a tuberous hypocotyl; several Cycads show it,<sup>2</sup> also *Araucaria*<sup>3</sup> and other plants. The explanation of this is, we think, to be found in the fact that the swollen axis requires a greater dispersal of the vascular tissues, and this, possibly, is the explanation of the *Anemarrhena* type in *Eranthis*<sup>4</sup> and certain other plants.

The diarch root-structure in the Ferns is associated with single leaf-trace bundles of the two first foliage leaves,<sup>5</sup> and this also obtains in numerous Angiosperms and Gymnosperms. And in many of these cases the transition-phenomena, which are of Type 3, show resemblances to the Ferns; the cotyledon-traces are undivided, and their vascular rearrangements are very obscure, that is to say, the cotyledonary bundles do not show a well-marked bifurcation and rotation either in the petioles or in the axis, but run into the central region, where a rearrangement of the vascular

<sup>1</sup> Hill and de Fraine: Gymnosperms, Pts. I, II, and III, loc. cit.

<sup>2</sup> Matte: Sur le développement morphologique et anatomique des germinations des Cycadacées. Hill and de Fraine: Gymnosperms, Pt. III, loc. cit.

<sup>3</sup> Shaw, F. J. F.: The Seedling-structure of *Araucaria Bidwillii*. Ann. Bot., xxiii, 1909.

<sup>4</sup> See Tansley: Reduction in Descent, loc. cit.

<sup>5</sup> If the cotyledons are foliar members and are homologous with Fern leaves, a comparison, if drawn, must be made with the first-formed leaves of the Ferns.



elements takes place so as to bring about a root-like structure. Also, there is no structural hypocotyl; the hypocotyl of these higher plants shows root-structure throughout except for a very short region below the cotyledonary node, and the primary root-structure is diarch. Thus it is seen that with regard to the cotyledonary strands, the high transition and the consequent absence of a distinctive structural hypocotyl, certain Gymnosperms, e.g. *Cupressus obtusa*, *Libocedrus*, &c., and Angiosperms, e.g. *Pupalia purpurea*, *Claytonia*, &c., show marked Fern-like characters.

The next stage in the series is represented in plants such as *Phytolacca dioica*, *Lupinus venusta*, *Piper cornifolium*, *Pinus* and many other Gymnosperms in which the seed-leaf-trace bifurcates either on its way through the cortex to the central part of the axis or in the cotyledons themselves, this bifurcation being accompanied by vascular rearrangements which are inaugurated at different levels. This, it may be pointed out, is paralleled in the fronds of certain Ferns; in *Angiopteris*, for example, the first leaves have single leaf-traces, but in later formed leaves this single strand bifurcates at first at the periphery of the stem and then closer and closer to the central cylinder until two traces are given off from the cauline vascular strands instead of one.

In the higher plants the extreme case of this early division of the cotyledonary strands results in the formation of two bundles, e.g. in *Ephedra*, *Podocarpus*, *Araucaria*, and *Ginkgo*, and in the Nyctaginaceae and other Angiosperms, which are together equivalent to the single strand of forms such as *Taxus*, *Juniperus*, *Cupressus*, and *Callitris* amongst the Gymnosperms, and *Claytonia*, *Pupalia*, and *Ranunculus* amongst the Angiosperms.

The final stage in complication is due to the lateral bundles; these may fuse on to the single or on to the adjacent halves of the divided central strand, or, on the other hand, a series may be drawn, as in the Centrospermae,<sup>1</sup> in which the lateral bundles delay their fusion with the central strand more and more until, finally, they may occupy a prominent position within the hypocotyl, in the intercotyledonary plane, and give origin to two poles of the tetrarch root. In the extreme case the resulting root-structure will be tetrarch, e.g. *Convolvulus siculus*, but in less extreme instances the root-structure will be diarch throughout or tetrarch to begin with, becoming reduced to diarch, e.g. *Scorzonera hispanica*, *Achillea Ptarmica*, *Tagetes patula*, *Coreopsis tinctoria*, and *Helianthus lenticulatus*.

So much for an alternative hypothesis which, in its broad lines, was originally held by Tansley.<sup>2</sup> From the purely morphological point of view it has, we think, as much to recommend it as the theory of Miss Thomas.

To the latter investigator<sup>3</sup> it appears easier to imagine the derivation

<sup>1</sup> Hill and de Fraine: Centrospermae, loc. cit.

<sup>2</sup> The Meeting of the British Association at York. New Phyt., vol. v, 1906, p. 184.

<sup>3</sup> Loc. cit.

of all the modifications found from a tetrarch than from a diarch form', since diarchy is associated with extremely definite and constant features which suggest a certain 'stereotyped rigidity unfavourable to the evolution of new forms'; on the other hand, tetrarchy, particularly as seen in Gymnosperms, 'gives an impression of plasticity and variability' and 'ample scope for the derivation of all the modifications seen'. It must, however, be noted that the diarch rather than the tetrarch type of symmetry is characteristic of Gymnosperms—in fact, even triarchy is more usual than tetrarchy (Table I). Further, there is considerable reason for believing that it is the size of the seedlings which is the determining factor in producing the particular type of symmetry; but this is a question which will be considered at further length later.

The existence of an intermediate type between diarchy and tetrarchy has been demonstrated in certain plants, e.g. *Liriodendron tulipifera*, *Clematis Hendersoni*, and some Composites; in these the lateral bundles of the cotyledons enter the hypocotyl and attempt to form the intercotyledonary poles of a tetrarch root.

According to Miss Thomas, this is to be regarded as 'an ancestral feature not completely eliminated', for she finds it 'difficult to see what functional advantage would accrue from such a very abortive attempt to form the intermediate poles of a tetrarch root'. This intermediate type appears to be a fairly widespread one so far as our observations go, and it seems to be confined to large, or moderately large, seedlings. In small seedlings the one lateral bundle, so generally present on either side of the midrib of the cotyledon, fuses with the main bundle at a varying distance above the cotyledonary node, hence two bundles (bifurcated or not) enter the node, and the transition to a diarch root is rapidly effected. As the seedlings increase in size, so the tendency for the delay in the fusion of the laterals with the main bundle increases, resulting usually in the production of a tetrarch structure in the hypocotyl; this tendency finds its ultimate expression in the production of a tetrarch root. Size of seedlings almost, if not quite, determines whether or not the laterals shall penetrate the hypocotyl or fuse with the main cotyledonary strand before its entrance. The reason for the relation which exists between the delay in the fusion of the laterals and the size of the seedling is to be found, in all probability, in the physiological needs existent at this stage of growth; the larger the seedling the greater the need for increased vascular supply. This finds its expression in the expansion of the diarch to the tetrarch type, or at any rate in the production of a more or less persistent tetrarch stage. Correlated with this is the presence of a stem-structure in the hypocotyl.

If seedling-structure is to be used as an indicator of affinity, several difficulties are met with.

It is a curious fact that Type 3, in a pure or modified form, is by far and away the most common mode of transition in the Phanerogams. The question naturally arises, Does not this indicate that the possibilities of evolving distinct methods of transition, especially in plants characterized by small seedlings, are so limited that but little, if any, reliance can be placed on such characters? With regard to plants with large seedlings, the possibilities alluded to are greater, but, as will be seen later on, the anatomical features concerned are susceptible of being explained on purely physiological lines.

Then there are various anomalies, more or less serious, which have to be explained away. For instance, the marked resemblance in the seedling anatomy of the Gnetales, *Podocarpus* and *Araucaria*; the occurrence of the Anemarrhena type in the Ranunculaceae,<sup>1</sup> Cactaceae,<sup>2</sup> and Bignoniaceae;<sup>3</sup> and the resemblance between Ranunculaceae, Piperaceae,<sup>4</sup> and Araceae.<sup>5</sup> Further, the differences between closely allied genera and species are not altogether convenient; for example, *Nopalea* n. sp. and *Opuntia Ficus-indica* or *Opuntia albicans* and *Pereskia* n. sp. appear, on the use of these characters, more closely related than *Opuntia Ficus-indica* and *O. albicans*. Then, again, the details are not always constant in a single species, e. g. *Echinopsis multiplex*, *Pilocereus exerens*, and *Mamillaria rhodantha*. If further instances be required, they will be found in Lee's work on the Sympetalae; this author shows that in the Personales, Polemoniales, and Lamiales the prevailing type of transition is Type 3, but in each of the groups Polemoniales and Personales a single natural order shows, in part, a different arrangement. That is to say, orders, e. g. Bignoniaceae, and even genera which are usually accepted as being allied show different methods of transition.

<sup>1</sup> Sargent, E.: Theory of the Origin of Monocotyledons founded on the Structure of their Seedlings. Ann. Bot., xvii, 1903.

<sup>2</sup> de Fraine, E.: Cactaceae, loc. cit.

<sup>3</sup> Lee, E.: Observations on the Seedling Anatomy of certain Sympetalae. Ann. Bot., xxvi, 1912.

<sup>4</sup> Hill, T. G.: Piperales, loc. cit.

<sup>5</sup> This similarity of certain features of plants more or less widely separated is, of course, not restricted to vegetative features. Thus Church (Types of Floral Mechanism, Oxford, 1908) remarks that 'the possession of a *Mean Type* of Flower by any plant cannot be regarded as a necessary mark of "affinity" with any other: it may represent a reduction-phase which may be reached in many diverse phyla, and such forms would then resemble each other only by convergence of type; the significance of this diagram being purely biological, in that it represents a certain balance between modern floral organizations and the external environment on which they are dependent for their successful development, protection, and pollination. On the other hand, it is equally possible to regard it as indicating a definite generalized biological stage in the main line of phylogenetic evolution on which different phyla have superimposed different secondary devices of their own. . . . The prevalence of this Mean Type Diagram throughout the modern flora is one of the remarkable features of the vegetable kingdom. It is characteristic in its pure form, or as readily recognizable derivatives, of 30,000 species of Dicotyledonous flowers, or about *one-third* of all the flowers known in the world at the present time.'

The parallel between Church's Mean Type and Van Tieghem's Third Type of transition is sufficiently striking to need no further comment.

Further, the impression derived by Miss Winifred Smith<sup>1</sup> from a study of sapotaceous seedlings was that, 'while there is a characteristic type of anatomy for the order, it is subject to adaptive variations as to the number of strands, primary and otherwise.'

In cases where there is little or no doubt regarding the affinity of two plants or groups of plants, the seedling-structure may be correlated with the affinities determined on other characters, but in instances where the relationship is open to question, the details of seedling anatomy do not appear to help to any considerable degree, for the plants in question may have the same seedling-structure, which does not necessarily mean affinity, e. g. *Anemarrhena* and *Incarvillea*, and *Persoonia* and *Pinus*, or the seedling structure may be quite different, which does not necessarily indicate remote affinity, e. g. *Incarvillea Delayvei* and *Eccremocarpus scaber* (N. O. Bignoniaceae). In other words, it does not appear possible to assign a true value to the characters in question in cases where often they would prove of greatest worth.

For these reasons we see no necessity for preserving seedling anatomy from the fate already meted out to other structural features, e. g. secondary thickening, which were at one time considered as indicators of phylogeny, a conclusion arrived at, either entirely or in part, by others who have paid attention to the facts of seedling anatomy.<sup>2</sup> In fact, until more knowledge is obtained with regard to the interrelationship of plant members and the influence of environment—in a word, the influence of physiological necessity on morphological expression—we cannot determine with any degree of certainty the precise value of many anatomical characters.

#### PHYSIOLOGY.

Of the factors which have a bearing on the structure of seedlings, the influence of the adult structure<sup>3</sup> and the importance of the size of the seedling have already been considered. There are, however, many more—too numerous to deal with here—of which we propose to consider questions relating to the size and number of the vascular bundles, for it is upon these that the transition phenomena depend.

First, as regards the number of the cotyledonary bundles. The size of the seeds of Gymnosperms, and also Angiosperms, varies considerably, and depends to a great extent upon the amount of reserve food material. It is an important fact that when the amount of such reserve food is relatively large—and hypogeal seedlings are remarkably dependent on their cotyledonary food reserves for their early development, as contrasted with

<sup>1</sup> Smith, W.: The Anatomy of some Sapotaceous Seedlings. Trans. Linn. Soc. London, vol. vii, Bot., Pt. II, 1909.

<sup>2</sup> See Lee, loc. cit.; and Compton, R. H.: An Investigation of the Seedling Structure in the Leguminosae. Journ. Linn. Soc., June, 1912, xli.

<sup>3</sup> Hill and de Fraine: Proteaceae, loc. cit.

epigeal seedlings<sup>1</sup>—there is formed either a special structure for its removal, as the sucker in *Welwitschia* and *Gnetum*, or else the cotyledons are permanently hypogeal and perform the function of absorbing organs. This in the case of albuminous seeds: in examples of exalbuminous seeds the cotyledons may be hypogeal or epigeal, in which case the hypocotyl forms a more or less massive column. The larger the amount of food material, the greater must be the vascular supply if the translocation is to be completed in a reasonable amount of time. For, although a certain amount of water is taken up by a germinating seed through the seed-coat, it is reasonable to assume that the larger amount of water is supplied by the root-system when once it is formed. And with regard to the depletion of the hydrolysed food substances, the phloem, when differentiated, probably is more active than the parenchymatous elements.

Leaving out of consideration those plants, e. g. certain Gnetales, which have developed a special structure for this work, the Cycads have in their seeds the largest amount of food reserves; the number of cotyledonary bundles are also most numerous in this class. A further example is seen in *Araucaria*; *A. brasiliensis* as compared with *A. Cunninghamii* has a much larger seed, its cotyledons are more massive, are hypogeal, and contain more vascular bundles, and the hypocotyl is relatively much thicker.

In such cases we believe that the size of the seed, which presumably to a great extent is correlated with the amount of reserve food material, is the determining factor, and on it depends the size and number of the vascular bundles in the cotyledon, and thus is influenced the transition phenomena and the number of bundles and relative development of the hypocotyl.

With regard to the points here raised, although they are now being investigated, no information has so far been obtained, other than morphological, which warrants our idea that the number and more particularly the size of the bundles depend upon the amount of reserve food to be hydrolysed and translocated. Thus in the hypogeal seedling of the oak the area of the cross-sections of the vascular bundles in the base of the seed-leaves of the seedling, plotted against the weight of the seed, minus its seed-coat, before germination, gives a very irregular curve.

The problem, however, is not quite so simple as it appears, since the area of the cross-section of the bundles may not bear a definite relation to the similar measurements of the tracheae; the phloem must be taken into consideration, and also the capacity of the sieve-tubes; further, with regard to the weight of the seed, it must be ascertained whether it bears any relation to the amount of food substances it contains. For instance, it does not necessarily follow that the relation between the weights of the food

<sup>1</sup> Reed, T.: Some Points in the Morphology and Physiology of Fasciated Seedlings. Ann. Bot., 1912, xxvi.

stored in a small seed, and of the seed itself, is the same as for a larger seed of the same species. In fact, the most satisfactory method of attacking the problem is to ascertain the amount of water required, not only for the ordinary activities of the living tissues, but also for the hydrolysis and sufficient dilution of the food materials present, and to consider this in relation to the tracheae and the sieve-tubes. Also, the time factor and the temperature at which germination takes place must be taken into account if a complete investigation is to be made, for it is obvious that if hydrolysis takes place slowly, the capacity for water-carriage need not be so great as when hydrolysis occurs quickly; and, with regard to temperature, it need hardly be mentioned that the degree of heat considerably influences this process. In short, since germination is intimately bound up with physico-chemical reactions, it is obvious that any conditions influencing these must be severally investigated before their resultant can be ascertained.

It may not at first appear obvious how questions relating to translocation are connected with the number of bundles. Briefly put, the connexion appears to be this: Confining our attention to water-supply, it is obvious that in order that efficiency may be maintained a vascular strand must convey a certain amount of water to the part which it is its function to supply. The xylem of a bundle does not pour out water at its tip, like a fountain, but supplies the surrounding tissues throughout its whole course. If the xylem be so compact that there is little or no parenchyma between the tracheae, it is obvious that, no matter how numerous the tracheae may be, their capacity for supply is limited according to the extent of the outer surface of the xylem mass; so that, in order to obtain an increased supply of water, it is necessary in the first instance not to increase the number of tracheae, but to increase the amount of surface in contact with the tissues to be supplied. This, obviously, may be done by the branching of the strand, and possibly this may in part explain the larger number of cotyledonary bundles in plants possessed of large seeds, e.g. Cycads, *Quercus* and *Ricinus*, and also the presence of two bundles where one might be expected. For example, in *Ephedra*, although the cotyledons are not at all massive they may be very long, and are characterized by the possession of two vascular strands which remain separate throughout their course within the seed leaves. The xylem of these bundles is, however, very compact.

The same end may be attained by different means: it is obvious that if, instead of dividing, the bundle opens out tangentially, as it were, by the development of much parenchyma between the tracheae, the surface of the wood would be greatly increased; this is seen in *Cephalotaxus*, *Cupressus*, *Juniperus*, and also in *Persoonia*, where the seed-leaf bundles at the cotyledonary node are much elongated tangentially, whereas in *Pinus* there may be two bundles at the corresponding level.

It is hardly necessary to point out that there is an obvious limitation to this expansion of bundles, so that in the seedlings of plants characterized by seeds of some size, it is usual to find several cotyledonary bundles the xylem of which may be more or less expanded. This necessity for, and realization of, several seed-leaf bundles is one of the factors which results in a large hypocotyl; the other factors may next be considered.

The above remarks apply chiefly to hypogeal seedlings; in the case of seedlings with epigeal cotyledons, two features stand out prominently. If the seed leaves contain much reserve food material, e. g. the lupin, in addition to the problems relating to water supply and translocation of digested food

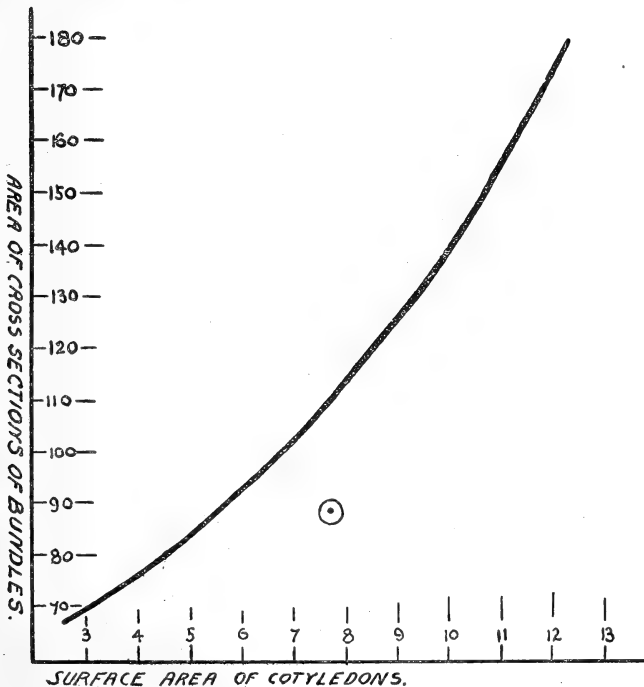

there is the additional one of mechanics. A seed leaf replete with food must have a broad base of insertion on the hypocotyl, and the petioles, if present, must be stout structures; also the hypocotyl, in order to bear the weight of the cotyledons, must be a fairly massive column. The mechanical requirements of such massive structures are met, in part, by the development and proper disposition of several vascular bundles.

But if the cotyledons do not contain much reserve food they, not infrequently in large seeds, early take on a photosynthetic function and exhibit a large surface; thus the same mechanical requirements may obtain, and also the desirability of an adequate supply of water. This is conveniently seen in the seedlings of *Fagus sylvatica*, a preliminary

investigation of which indicates that there is a close relationship between the surface of the expanded cotyledons and the total area of the cross-section of the bundles, as is shown by the accompanying curve, which is a particularly good one with the exception of one point.

Results of a similar nature have been obtained with the seedlings of *Acer*, but in view of the incompleteness of the investigation, it does not appear desirable to give figures in the present communication.

These observations are corroborated by the work of Salisbury,<sup>1</sup> who, in a different connexion, found that, in the case of the extra-floral nectaries of species of *Polygonum*, if the cross-sectional area of the xylem in the petiole be divided into the area of the corresponding nectary, the value obtained approaches a constant.

The remaining case is where the cotyledons of epigeal seedlings first absorb a copious endosperm and then function as foliage leaves, as in *Ricinus*; here, all the problems alluded to have to be considered.

In fact, the size of the seedling, and all which this connotes, is very important, and has a direct bearing on the seedling-structure. Our observations on the Gymnosperms and Angiosperms led us to this conclusion, and we were engaged upon an investigation on this subject when the appearance of Compton's important paper on the Leguminosae rendered the continuance of many of our observations on this particular point unnecessary. Attention, however, may briefly be drawn to some of the facts observed.

1. In large seedlings there is much more vascular tissue as compared with small seedlings (see analysis below).

2. Generally speaking, in large seedlings the number of vascular strands is greater; that is, the lateral cotyledonary bundles persist for a greater distance downwards.

In small seedlings at the base of the seed-leaf petioles a median strand only usually obtains. In larger seedlings two lateral bundles also are found at this level, whilst in still larger seedlings more than two laterals may occur.

3. In large seedlings the lateral bundles tend to produce a tetrarch stage in the hypocotyl; this tetrarchy may persist almost to the base of the hypocotyl and may result in a tetrarch root, e. g. *Dahlia*.

In smaller seedlings, tetrarchy, even when it does occur, is always transient. (see p 261).

4. Not infrequently, more especially in the case of Angiosperms, the main central bundle may bifurcate very high up, sometimes even in the blade, as in *Allionia* and other Centrospermae, and in *Lupinus*, and the halves separate widely and resume their normal orientation, leaving the protoxylem in an isolated position.

<sup>1</sup> Salisbury, E. J.: The Extra-floral Nectaries of the Genus *Polygonum*. Ann. Bot., xxiii, 1909.



5. Tetrarchy appears to be characteristic of large seedlings and diarchy of smaller ones. For example, in the Cactaceae, *Pereskia*, *Nopalea*, and *Opuntia* have typically a tetrarch root, whilst *Rhipsalis*, *Echinocereus*, *Echinopsis*, and *Mamillaria* have a diarch root.

Following is an analysis of some of the pairs of seedlings raised from seeds of closely related plants, which seeds were selected in order that the units of each pair might differ, as far as possible, in size.

In this analysis the following are the abbreviations used :

3rd column : 1 m. = 1 non-bifurcated main strand,

1 m. b. = 1 bifurcated main strand,

2 l. or 3 l. = 2 or 3 lateral strands.

4th, 5th columns : c. s. = cross-section.

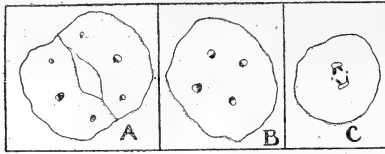

DIAGRAM 1. *Coreopsis tinctoria*.  $\times 28$ . In this and the following diagram the xylem is indicated by black areas. In both diagrams A, B, and C illustrate the levels similarly lettered in the analysis on p. 271.

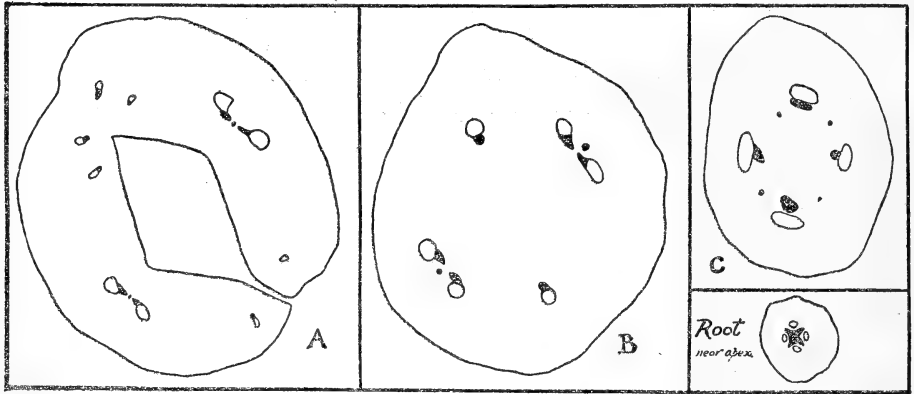

DIAGRAM 2. *Dahlia Merckii*.  $\times 28$ .

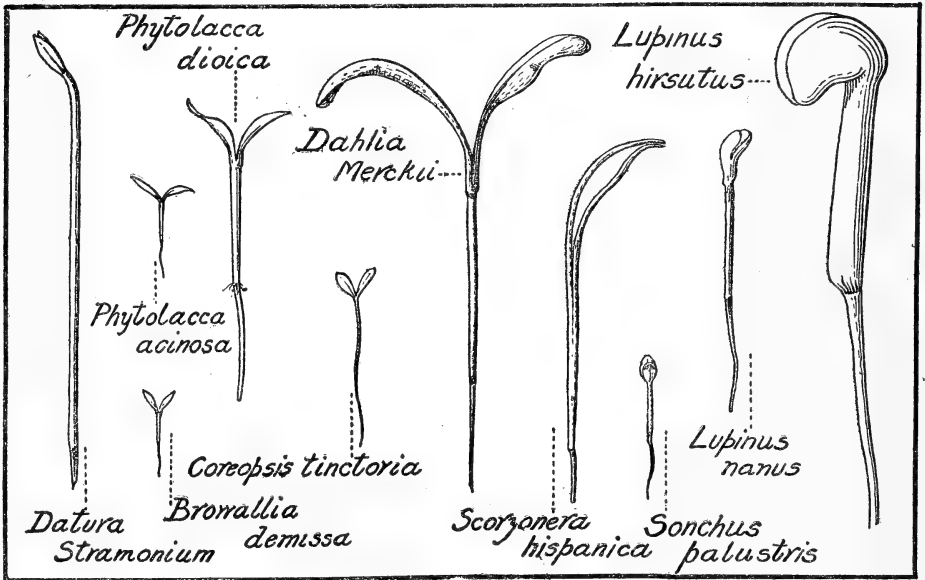

FIG. 1. Nat. size.

Area in square mm. of the cross-sections of the two cotyledonary petioles, the hypocotyl and the root, also of the xylem, the phloem, and the xylem and phloem taken at different levels, A, B, and C, corresponding to Diagrams 1 and 2.

Seedling.	Relative size. (See Fig. 1.)	Number of strands at base of each cotyle.	Level A.						Level B.						Level C.				Distance in mm. from top of hypocotyl to level of root-structure.
			C. S. of cot. petiole.		C. S. of xylem.		C. S. of phloem.		C. S. of hypocotyl.		C. S. of xylem.		C. S. of phloem.		C. S. of root.		C. S. of xylem and phloem.		
			C. S. of cot. petiole.	C. S. of xylem.	C. S. of phloem.	C. S. of xylem and phloem.	C. S. of hypocotyl.	C. S. of xylem.	C. S. of phloem.	C. S. of xylem and phloem.	C. S. of root.	C. S. of xylem.	C. S. of phloem.	C. S. of xylem and phloem.					
1. <i>Saponaria cerastoides</i> <i>S. Vaccaria</i> . . .	small large	1 m. 1 m. + 2 l.	11.55 85.16	0.19 0.87	0.38 1.88	0.57 2.75	13.89 109.50	0.14 0.94	0.48 1.46	0.62 2.40	10.55 62.91	0.24 1.12	0.55 1.67	0.79 2.79	0.13 2.0				
2. <i>Browallia denissa</i> . <i>Datura Stramonium</i>	small large	1 m. b. 1 m. b.	12.59 75.53	0.05 0.82	0.13 1.82	0.18 2.64	14.25 77.46	0.06 0.76	0.34 1.07	0.40 1.83	11.52 17.84	0.09 0.13	0.22 0.67	0.31 0.80	0.2 7.5				
3. <i>Phytolacca actinosa</i> . <i>P. dioica</i> . . .	small large	1 m. b. 1 m. b.	12.88 129.49	0.04 0.61	0.13 1.42	0.17 2.03	13.52 103.65	0.12 0.87	0.15 1.15	0.27 2.02	8.39 56.56	0.09 0.59	0.07 0.41	0.16 1.00	1.0 6.25				
4. <i>Coreopsis tinctoria</i> . (Diagram 1). <i>Dahlia Merckii</i> . (Diagram 2)	small large	1 m. + 2 l. 1 m. b. + 3 l.	26.14 173.32	0.13 1.04	0.19 2.79	0.32 3.83	23.24 186.04	0.15 1.18	0.23 3.29	0.38 4.47	13.88 91.96	0.12 1.29	0.17 3.61	0.29 4.90	0.2 1.2				
5. <i>Lupinus nanus albus</i> <i>L. hirsutus</i> . . .	small large	1 m. b. 1 m. b. + 2 l.	38.43 446.57	0.13 3.07	0.32 3.64	0.45 6.71	48.57 397.64	0.25 1.50	0.39 3.29	0.64 4.79	36.86 347.36	0.21 1.54	0.36 2.61	0.57 4.15	0.4 3.6				
6. <i>Sonchus palustris</i> . <i>Scorzonera hispanica</i>	small large	1 m. + 2 l. 1 m. + 4 or 5 l.	69.81 140.11	0.11 0.68	0.32 2.32	0.43 3.00	54.95 141.56	0.13 1.39	0.48 3.95	0.61 5.34	42.95 105.29	0.25 0.96	0.54 4.80	0.79 5.76	0.4 3.6				

1. Illustrated in Hill and de Fraime, *Centrospermae* (loc. cit., p. 180). In *S. Vaccaria* the laterals penetrate into the top of the hypocotyl, where they fuse on to the main bundles. Root diarch in both species.  
 2. Root diarch in both species.  
 3. Root diarch in both species.  
 4. *Dahlia*, root tetrarch. *Coreopsis*, tetrarch structure which eventually becomes reduced to diarch. The lateral bundles of *L. hirsutus* enter the hypocotyl. This is not so in *L. nanus*.  
 5. Root diarch in both species. The lateral bundles of *L. hirsutus* enter the hypocotyl. This is not so in *L. nanus*.  
 6. *Scorzonera hispanica* has a cotyledonary tube (8 mm. long); the laterals persist for some distance downwards; a diarch root-structure is eventually formed. *Sonchus palustris* has hardly any cotyledonary tube; the laterals fuse in pairs and die out almost immediately. Root diarch.

Sufficient has been said to show the enormous importance of physiology in questions relating to vascular tissues ; for our own part we are strongly of the opinion that no real further advance in our knowledge of morphology, more especially of the higher plants, is possible without an adequate investigation of the physiology of the members concerned.

With regard to the points raised in the present outline, we are engaged in their investigation, but, owing to the complexity of the work, definite conclusions cannot be expected for a considerable time.

Finally, we wish to draw attention to the desirability that those engaged on these and similar investigations should pay attention not only to the qualitative but also to the quantitative aspects of the subject.

UNIVERSITY COLLEGE,  
LONDON.

# Methods of Palaeobotanical Reconstruction.

BY

E. J. SALISBURY, B.Sc., F.L.S.

*Lecturer in Botany, East London College, University of London.*

With one Figure in the Text.

**T**HE rapid advances which our knowledge of Palaeobotany has made during the past few years have naturally resulted in a more detailed study and an increased accuracy of method in the reconstruction of fossil plants from petrified material.

Certainly one of the most important preliminaries to the investigation of any petrified structure consists in an accurate determination of the directions in which the sections have been cut.

Every one who works in this field is familiar with the fact that sections which approximate closely to the longitudinal or transverse planes are of very rare occurrence, so that not only are the vast majority of these oblique with regard to the main axis, but doubly oblique sections, not symmetrical about any plane, are also extremely common.

In the case of complex structures it is wellnigh impossible, and in some cases completely so, to think out unaided the distortions consequent upon such obliquities, and the difficulties of the problem are still further enhanced where serial sections are not available.

It is the object of the present paper to bring together the various methods which have been previously adopted for the reconstruction of petrified material, together with others which the writer has himself found useful in such investigations. These can be all regarded as belonging broadly to one of two classes according as they are applicable to the study of serial or non-serial sections.

## I. METHODS OF RECONSTRUCTION FOR SERIAL SECTIONS.

### (a) The wax sheet method.

In this method, which is that commonly employed by zoologists, the sections of the series are represented by sheets of wax, out of which are cut the structure as seen in each on an enlarged scale. For this purpose each section has to be drawn to the magnification of the required model, which can be done either by means of a camera lucida or by projection. If the

former be employed great care must be exercised to ensure that there is no distortion, and that all the drawings are perfectly comparable; the other alternative is to project an image of each section on to the plate-glass screen of a photo-micrographic apparatus over which has been stretched a sheet of tracing paper, the section is then drawn and a fresh piece of tracing paper substituted. By the latter method all distortion is avoided and the same magnification can be always obtained without difficulty.

By means of the drawings each section is then cut out of a wax sheet, connexions being left where isolated portions occur. The wax sections thus formed are placed in order and joined together, either by pricking with a hot needle and applying pressure, or by running melted wax around the edges.<sup>1</sup> It is obvious that the thickness of the wax sheets must have the same relation to the actual interval between the successive sections as the magnified representations bear to the real sections, and the accuracy of the model depends upon the assumption that the sections are equidistant and parallel.

The method is particularly useful in the reconstruction of the stems or other structures with an elongated axis; its chief defects, however, come from the fact that the successive sections of a series are frequently far from parallel, and the interval between them not a constant one. Where, as in stems, roots, and petioles, there is seldom any very rapid change in direction of either the structure as a whole or of its internal organization, and the series is, moreover, usually a long one, these objections are not of great importance. But in seeds and similar structures where rapid changes occur such considerations necessarily render it useless to the palaeobotanist.

If permanent models are required which shall be unsusceptible to extremes of temperature, the sheets out of which the sections were cut can themselves be built up and employed as a mould from which a plaster of Paris model can be made.

Professor and Miss Sollas<sup>2</sup> used this method with considerable success. They found that the plaster of Paris adhered readily to that which had freshly set, and by taking advantage of this fact they were able to add the sections one by one, so that all projections could be filled in with the plaster, and by means of a special apparatus each was planed down before adding the next in order.

#### (b) **The cardboard method.**

A method which has been adopted by the present writer, and which, though similar to the above, offers considerable advantages, is to paste drawings of the sections obtained by projection on to pieces of cardboard, which are then cut out and fixed in their appropriate positions by means

<sup>1</sup> See W. J. Sollas, *Phil. Trans. Roy. Soc., Ser. B*, vol. cxcvi, pp. 259-65.

<sup>2</sup> *Phil. Trans. Roy. Soc., Ser. B*, vol. ccii, pp. 231-2.

of wires. The intervals between the sections are thus represented by spaces, so that the alterations both in these intervals and in the planes of section can be allowed for. Further, the magnification of the model is in no way limited either by the size or thickness of the wax sheets or other material used.

(c) **The glass method.**

The most useful, and at the same time the most ingenious, of all the methods of this class is that invented by Professor Graham Kerr,<sup>1</sup> which, though primarily intended for the study of microtome sections, is, with certain modifications, of extreme value to the palaeobotanist. Here ground-glass sheets are employed; the successive sections are drawn upon them in pencil and the various structures differentiated by means of water-colour paints. A few drops of clove oil are placed upon each sheet and the next then added, so that the whole block thus formed appears transparent, whilst the structure itself stands out as if reconstructed. Graham Kerr's method is similar to that formerly employed by Vosmaer, but differs in the use of ground glass and an interposed fluid.

For the purpose of the palaeobotanist the sheets of glass should be attached by clips to three upright supports arranged in a triangular manner and permitting of movement in the vertical direction. In this way the variation in the interspaces can be allowed for and differences of angle obtained.

## II. RECONSTRUCTION OF NON-SERIAL SECTIONS.

Where serial sections are not available, or the structures under investigation are so short as to preclude series of more than 3 or 4 sections, the methods described above are of very little value. In all such cases it is necessary to assume, unless of course there be good evidence to the contrary, that all the sections at one's disposal have been cut from structures of approximately equal relative dimensions; and in the case of seeds where this method has been utilized such an assumption does not appear to have been unwarranted.<sup>2</sup>

At the outset a primary examination of all the sections is made in order to obtain all the dimensional data possible.

In any oblique section there is one plane in which the dimensions of the structure are not exaggerated by the direction in which it has been cut. By noticing these true values in all the sections at one's disposal, the real dimensions of several structures, such as the thickness of a testa or the width of a seed, are obtained.

The angle of obliquity of some of the remaining sections can then be

<sup>1</sup> Q. J. M. S., No. 177, p. 1, 1902.

<sup>2</sup> Oliver and Salisbury, *Ann. Bot.*, vol. xxv, 1911, p. 4.

deduced from these known values, and since the calculation of these angles involves considerable time it is usually much simpler to obtain them graphically. For example, the thickness of a testa is represented on the magnified scale by a horizontal line, and from one end of this a second line is drawn vertically upwards. Using the other end of the first line as a centre, an arc is then described having as a radius the magnified dimension of the testa in the oblique section. On joining up the centre to the point of intersection with the vertical, the angle of obliquity is obtained and can be read off by means of a protractor.

In this way from known values the plane of several of the sections can be determined, and by reversing the above graphical method the dimensions of other structures to those already known can be deduced from their oblique values, the latter being plotted at the known angles of section and projected on to the horizontal.

It will be seen that in this way quite a considerable number of dimensional values can be arrived at, and on the basis of these a preliminary ideal section of the structure as a whole can be drawn.

Each section is then measured along the line corresponding to the plane of intersection with the ideal section already constructed. The relative positions of the various parts and the boundaries of tissues along this imaginary line are plotted off along the edge of a strip of paper, so that for each section we have in convenient form the relative positions of its parts as they will appear when appropriately plotted.

If the original ideal section be approximately correct we should be able to fit in these lineal representations, so that the limits coincide at the angles which have already been determined.

In actual practice we shall find that our ideal section will undergo considerable modifications, after which we can proceed to reproduce it in the form of a model, using for the purpose some plastic and easily cut material such as plasticine.

It is obvious that for all the foregoing methods, and especially the last described, where the absence of serial sections greatly enhances the possibility of error, some means of checking the results must be adopted, and such a proof of one's results can be obtained by cutting the model at the angles and in the planes indicated by the plottings. If the model be a correct reconstruction the results will be magnified representations of the corresponding sections. Failure to obtain this will necessitate a revision of the model until any section can be reproduced upon it.

Adequately to cut such models in a perfectly flat plane necessitates the use of special apparatus, and a mechanism designed for this purpose will now be described by means of which the planes of obliquity of other sections, which do not admit of interpretation by the ordinary methods, can usually be elucidated (see Figure).



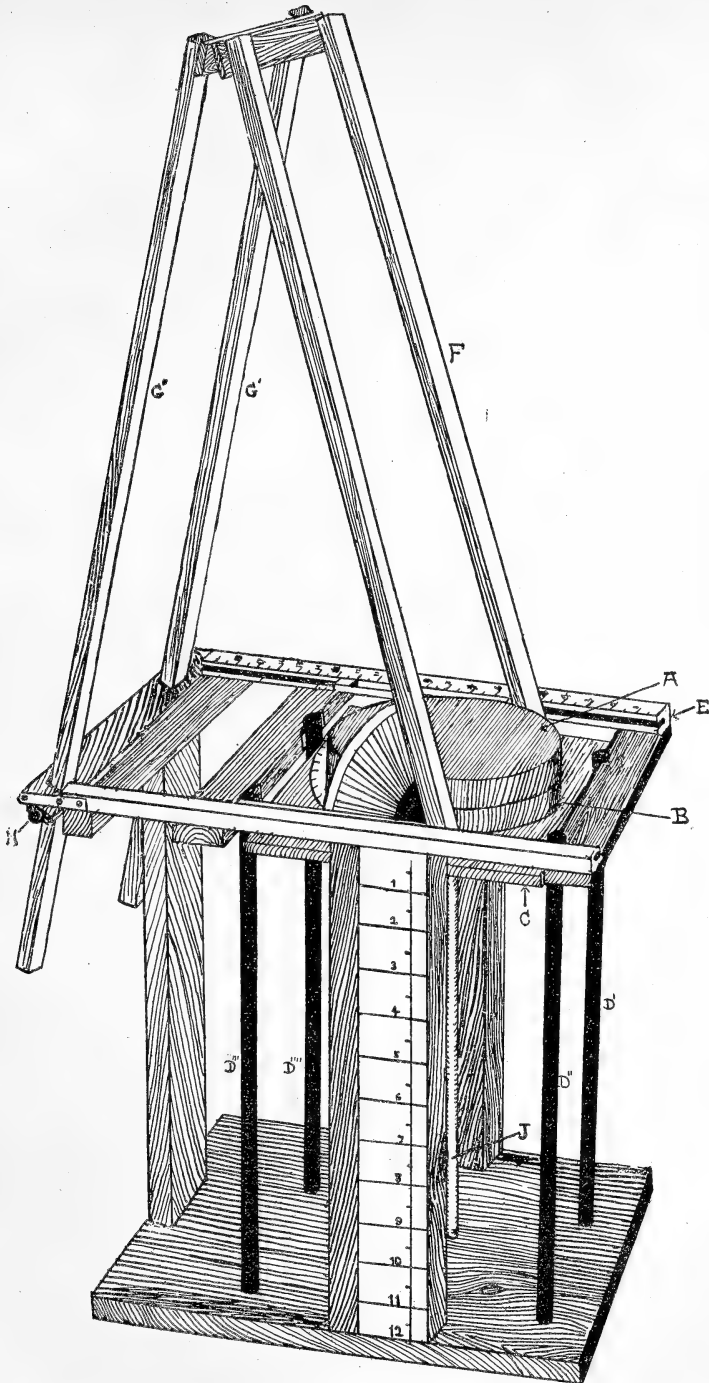

Apparatus for the cutting of models reconstructed from sections. A, removable platform for model; B, rotating platform; C, rising and falling platform carrying B; D'-D''', guides for the platform C; E, grooved sides of frame carrying runners which bear the cutting face F; G and G'', supports to the cutting face F; H, screw clamp for fixing the position of G''. The clamp for fixing the rod J carrying the platform C is not seen.

For the purpose of this apparatus the model is built up on a circular disc of wood A, of the same size as a rotating platform, B, in the instrument itself, upon which it rests. The disc bearing the model is removable and engages with the platform by means of three pins projecting from this latter, which are arranged in an asymmetrical manner so that the model, when removed, can only be replaced in the original position. The lower disc is attached by its axis to the rising and falling platform C, which moves along four upright metal guides, D', D'', D''', D''', fixed below into a base-board, and above carrying the rectangular framework E, which is further supported by uprights.

The effective length of the guides determines the extreme height of the models which can be cut. In practice a twelve-inch model has usually been found to give sufficient magnification for all purposes.

When the platform is at the highest limit the upper surface must be just above that of the rectangular frame; the internal width of this latter is slightly greater than that of the platform, whilst its length is more than double and so placed that the model is at one end.

A second frame, F, open at one extremity is hinged by the two free ends on to the upper sides of sliding runners which engage with grooves on the inner side of the horizontal frame. The hinges permit the former to be placed at any angle, whilst supports from its upper end, G', G'', enable it to be clamped in the desired position.

The model is cut by a taut wire drawn down the surface of the hinged frame, and scales appropriately placed give the necessary data as to the direction of the section, viz. the angle of the cutting plane; the position which the base of the frame F occupies along the horizontal grooves; the height of the rising platform; and the angle of the rotating platform.

It will be seen that such a mechanism enables one to cut the model in every possible direction, whilst the rising and falling platform can also, by clamping it at equal or unequal distances, be used for reproducing serial sections.

When utilizing the above for the elucidation by trial of the direction of a section which we have been unable to plot, the plane can be approximately arrived at by constructing a wire frame of the same shape as the outline of the section and placing this on the uncut model. In this way numerous trial sections can be avoided and thus much time spent in modelling is saved.

Whilst this instrument was constructed for the purpose of palaeobotanical research the use of some such check on one's observations might be of great advantage in other branches. Lawson has pointed out that the lateral position of the synaptic knot is probably often exaggerated owing to the obliquity of section.<sup>1</sup> And it may be that the effect of this on the form

<sup>1</sup> Trans. Roy. Soc., Edinburgh, 1911.

of the structures investigated is not sufficiently taken into account in other fields beside Cytology. However justified this suggestion, there is always a satisfaction and advantage in possessing some means by which a check approaching the nature of a proof can be applied to one's conclusions, and this is especially the case with histological detail such as the true form and arrangement of cells, which, as was found in the testa of *Conostoma oblongum*, might readily yield totally wrong interpretations.



# The Physiological Anatomy of the Periderm of Fossil Lycopodiales.

BY

MABEL H. KISCH, B.Sc.

*University of London, University College.*

With Plate XXIV and twenty-seven Figures in the Text.

## CONTENTS.

	PAGE		PAGE
HISTORICAL SURVEY . . . . .	281	(5) Cell Contents . . . . .	301
THE SPECIES EXAMINED . . . . .	287	(6) Intercellular Spaces . . . . .	303
THE PHELLOGEN . . . . .	287	(7) Heterogeneous Periderms . . . . .	304
(1) Place of Origin . . . . .	287	(8) Features of Mechanical Signifi- cance . . . . .	309
(2) Development . . . . .	288	(9) Zonation . . . . .	309
(3) Nature of the Meristem . . . . .	290	(10) Periderm Development in relation to Other Tissues . . . . .	313
(4) Position relative to the Secondary Tissue produced . . . . .	292	THE EXTERNAL MANIFESTATIONS OF PERIDERM DEVELOPMENT . . . . .	314
(5) Persistence . . . . .	296	(1) The Tissues outside the Periderm . . . . .	314
THE PERIDERM . . . . .	297	(2) The Outside Sculpture . . . . .	315
(1) General Description . . . . .	297	SUMMARY . . . . .	317
(2) Size and Shape of the Cells . . . . .	297	LITERATURE CITED . . . . .	318
(3) Character of the Radial Files . . . . .	298	EXPLANATION OF PLATE . . . . .	320
(4) Structure and Thickening of the Cell-wall . . . . .	300		

## HISTORICAL SURVEY.

THE earliest reference to the periderm of fossil plants was made by Witham in his description of the classical specimen of *Lepidodendron Harcourtii*, found in 1832. 'The tissue of the superficial layer', he writes, 'has a striking resemblance to that of the woody tissue of the Coniferae, the celluloses being disposed in regular series and of a form approaching the hexagonal, but without indications of medullary rays.'<sup>1</sup> This comparison with the wood of the Coniferae was repeated by Lindley and Hutton in their 'Fossil Flora', but they added that a vertical section showed that the meshes were 'merely sections of cellular tissue'.<sup>2</sup>

In 1839 Brongniart's monograph on *Sigillaria elegans*<sup>3</sup> was published, and in it appeared a more detailed and accurate description of the periderm under the name of the 'inner cortical zone'.<sup>4</sup> Brongniart commented on

<sup>1</sup> Witham (45).

<sup>2</sup> Lindley and Hutton (17), p. 47.

<sup>3</sup> Now known as *S. Menardi* or *Brardi*.

<sup>4</sup> Brongniart (8).

the absence of rays and pits, and drew attention to the characteristic appearance in radial section, which he explained as due to the uniform length of the cells in each row.

It was not till the work of Binney (1862-75) that the periderm of fossil Lycopods received any further attention,<sup>1</sup> with the exception of a paper by Dawes, in which the existence of a 'prosenchymatous zone' in a Halonial branch was noticed.<sup>2</sup> Binney was the first to point out the presence of an 'outer radiating cylinder' in *Stigmara*, as well as in *Lepidodendron*. He realized the secondary nature of the periderm, but he too fell into the error of believing it to be a vascular tissue, a 'pseudo-wood';<sup>3</sup> and it was on these grounds that he based his support of Dawson's theory that *Sigillaria* was a hard-wooded tree, and not a hollow and succulent plant,<sup>4</sup> though Dawson himself had referred only to the central axis.<sup>5</sup>

In 1871 appeared the first of Williamson's great series of memoirs which were to do so much for the study of Fossil Botany. Memoirs II and III were largely devoted to the Lycopods, and already here many of the erroneous ideas about the periderm were dispelled. From the first Williamson gave no support to the vascular theory. 'If I am correct in these determinations,' he writes in Memoir II, 'no question can arise as to the cortical nature of the thick, investing, and more external layers.'<sup>6</sup> Towards the end of Memoir III fossil periderm is compared for the first time to the cork of recent plants. 'I have got some magnificent specimens of bark,' says Williamson, 'which show that the two outer layers . . . increased in thickness through a meristem action. . . . Hence, we appear to have two concentric vertical zones in which these alternations occurred, one . . . the true cambium layer, and the other in the same plane as that which contributes to the growth of the cork-layer of the bark.' . . .<sup>7</sup>

In 1875, three years after the publication of Memoir III, appeared the memoir on *Sigillaria spinulosa* by Renault and Grand'Eury,<sup>8</sup> and this included a fairly detailed description of its peculiar Dictyoxylon cortex, as it appears in transverse and longitudinal sections. Three years later, Williamson, in his ninth Memoir, described what he thought was an English example of the same species,<sup>9</sup> and showed that the cells of the meshes were in a state of active division, and that there were signs of similar activity in the peripheral parenchyma. He also brought forward a theory as to the origin of the tissue, viz. that it was developed from a meristematic layer on the exterior; while in function he considered it similar to the 'phellem layer of living exogens'.<sup>10</sup>

<sup>1</sup> Binney (4), (5), (6), (7).

<sup>3</sup> Binney (5), p. 592.

<sup>5</sup> Dawson (10).

<sup>7</sup> Williamson (38), pp. 313-14.

<sup>9</sup> It was really a *Stigmara*.

<sup>2</sup> Dawes (9).

<sup>4</sup> Binney (5), p. 597.

<sup>6</sup> Williamson (37), p. 203.

<sup>8</sup> Renault and Grand'Eury (22).

<sup>10</sup> Williamson (39), p. 355.

Renault repeated his original observations on *Dictoxylon cortex* in his 'Structure comparée de quelques tiges,' &c. (1879)<sup>1</sup> under *Lepidodendron rhodumnense*, which is very similar to *Sigillaria spinulosa*, but he gave no explanation as to the origin or development of the *assise subéreuse*. On the other hand, it was just this aspect of the subject which appealed most to Williamson, and he returned again to it in his Memoir X in reference to *Lepidodendron Wunschianum*. 'The bast tissues', he writes, 'increase in thickness with the stem, . . . but no additional light is thrown on the physiological question, viz. whether the additions . . . are due to a plane of genetic activity on its external or its internal surface.'<sup>2</sup> In Memoir XI he added that the 'prosenchymatous zone' of *Lepidodendron selaginoides*, which he refers to later for the first time as *periderm*, appears under the leaf-bases in the form of detached arcs, and that the meristematic layer was on the outside of the tissue, owing to 'regular continuity of its peripheral border'.<sup>3</sup>

Some years later, in his monograph on *Stigmaria*, Williamson gave what he always considered his most complete notice of the history of the development of the periderm.<sup>4</sup> In this he described the outer layers of the prosenchymatous zone as being in a state of active division by both horizontal and vertical septa, and he explained the somewhat disturbed arrangement by concluding that the meristematic zone formed prosenchyma internally and parenchyma externally.

In Solms-Laubach's 'Einleitung in die Paläophytologie', which was published in German in the same year as the *Stigmaria* monograph (1887), the terms phellogen, periderm, and phelloderm are for the first time freely used in describing the fossil Lycopods, but it is explained that periderm is not to be taken in its physiological sense, since the leaf-bases beyond it do not dry up.<sup>5</sup> Solms locates the phellogen near the *outer* margin in *Lepidodendron selaginoides*, but, contrary to Williamson, on the *inner* margin in *Stigmaria*.

In 1891 appeared Bertrand's memoir on *Lepidodendron Harcourtii*.<sup>6</sup> Here the periderm is described as arising from a diffuse continuous cambium on the *inner* boundary of the tissue, though there are indications that the most delicate elements were towards the centre. Bertrand refers to the periderm under the name of cork, but he points out that it had not yet caused exfoliation.

Bertrand's work was followed the next year by Hovelacque's monograph on *Lepidodendron selaginoides*.<sup>7</sup> Hovelacque denies that the secondary cortical tissue is a phelloderm, as had been stated by Williamson and

<sup>1</sup> Renault (19).

<sup>3</sup> Williamson (41), pp. 285-6.

<sup>5</sup> Solms-Laubach (30).

<sup>7</sup> Hovelacque (15).

<sup>2</sup> Williamson (40), p. 498.

<sup>4</sup> Williamson (43).

<sup>6</sup> Bertrand (3).

confirmed by Solms-Laubach. He considers it a true periderm, derived from a diffuse phellogen on the *inner* surface, and he explains the layer of compressed cells, regarded as phellogen by Solms, as one of the zones of thinner walled, easily squashable cells which alternate with the ordinary prosenchyma in *L. selaginoides*.

In 1893 Hick noted the presence of a periderm zone in his new fossil *Xenophyton radiculosum*,<sup>1</sup> and in the same year appeared the last of Williamson's Memoirs, Part XIX, in which he brings further support for the conclusions of his *Stigmaria* monograph in the structure of a Halonial branch of *Lepidophloios*, where the 'meristemic zone' is figured between the outermost cortex and the prosenchyma.<sup>2</sup> Williamson again summed up the results of his work on the tissue in a paper for the Manchester Literary and Philosophical Society.<sup>3</sup>

Renault's last important work was more or less contemporaneous with these last papers of Williamson, for the 'Atlas' of his 'Flore fossile d'Autun et d'Épinac' was published in 1893 and the 'Texte' in 1896.<sup>4</sup> Two more species, *Sigillaria lepidodendrifolia* and *Lepidodendron esnostense*, are here described as having Dictyoxylon cortex similar to that of *S. spinulosa* and *L. rhodumnense*. In 1897, Renault and Roche described another species preserved in the Syringodendron condition with a cortex very like that of *Lepidodendron esnostense*.<sup>5</sup> They considered that it had undergone successive decortications along the concentric zones, and that it had a true cork layer renewed from the inner surface, and excluding gaseous interchange, which was provided for by the enlarged and persistent parichnos.

The next important addition to the knowledge of the periderm of the fossil Lycopods was made in 1900 in Seward and Hill's paper on a Lepidodendroid stem from Dalmeny (Williamson's *L. Wunschianum*), which had a band of secondary cortex several centimetres thick.<sup>6</sup> This is considered by the authors to be phelloderm, but it is not stated if there is any direct evidence of the position of the phellogen. The periderm is characterized by the presence of concentric bands of light-coloured cells, which are described as secretory in function. Seward and Hill are the first to point out the presence of intercellular spaces in the periderm of this species, and give more consideration than previous writers to the functions of the tissue, emphasizing its mechanical usefulness at the periphery.

In 1900 was published also the first edition of Scott's 'Studies'.<sup>7</sup> Scott states that in *Lepidodendron Harcourtii* the development of the periderm took place on both sides of the initial layer, but he reserves the type of *L. selaginoides* for a more detailed account of the tissue. Here

<sup>1</sup> Hick (14). *Xenophyton* is regarded by Weiss as the *Stigmaria* of *Lepidodendron fuliginosum*.

<sup>2</sup> Williamson (42).

<sup>3</sup> Williamson (44).

<sup>4</sup> Renault (21).

<sup>5</sup> Renault and Roche (23).

<sup>6</sup> Seward and Hill (29).

<sup>7</sup> Scott (24).



the view supported is that the phellogen was just inside the leaf-bases, and that the corky nature, even of the little tissue on the outer side, is very doubtful. With regard to *Stigmaria*, Scott agrees with Solms and differs from Williamson in believing that remains of the phellogen can be traced on the *inner* edge, but that the tissue was not impermeable. He gives a brief description of the periderm of species of *Sigillaria*, and points out that in all these plants the functions of the secondary cortex were probably very different, and much more important than in recent vegetation.

The periderm of *Lepidophloios fuliginosus* next received attention in the paper by Weiss on a Halonial branch of the species.<sup>1</sup> Here no phellogen layer can be distinguished, though the tissue is regarded as being probably phellogen, but Weiss considers it (unlike the periderm of the Dalmeny specimen) a closely-set, protective layer which would prevent the passage of air to the interior tissues; and, in a paper on the parichnos written a few years later, he says, 'A respiratory passage through the dense outer cortex and the impervious periderm would seem to be an essential requirement of the Lepidodendroid stem.'<sup>2</sup>

In 1906 Seward noted the formation of a wound periderm in *Lepidodendron aculeatum*,<sup>3</sup> and Scott the presence in places of a second periderm in *L. obovatum*,<sup>4</sup> but the next detailed account of the tissue is to be found in 1907 in Arber and Thomas's paper on *Sigillaria scutellata*.<sup>5</sup> Here the secondary cortex forms the bulk of the ribs of the species, and is regarded as phellogen, because the tangential walls of the outer layers are closer together and thinner than those of the more internal elements, and the parenchyma outside remains unchanged. In the same year an account was given by Watson of his new species, *Lepidodendron Hickii*, which had been included in the *L. Harcourtii* of Williamson. One specimen shows the first beginnings of the periderm, and it is stated that 'the central cell becomes the meristem and cuts off new cells on both sides';<sup>6</sup> but that in older sections it is impossible to locate the phellogen.

In 1908 Gordon described another new species, *Lepidophloios Scottii*, in the periderm of which there are zones of clear cells alternating with zones filled with dark material, which are taken as an indication of some sort of periodic rest.<sup>7</sup> In 1908 also, besides a paper by Weiss on a *Stigmaria* with centripetal wood possibly belonging to *Bothrodendron*,<sup>8</sup> where the thin-walled periderm with its outer cells tangentially extended is taken as evidence of Stigmarian nature, there was published the second edition of Scott's 'Studies'. In this, however, little is added to the original account of the periderm of the fossil Lycopods beyond bringing the book up to date by references to recent work.

<sup>1</sup> Weiss (33).

<sup>4</sup> Scott (25).

<sup>7</sup> Gordon (12).

<sup>2</sup> Weiss (35), p. 7.

<sup>5</sup> Arber and Thomas (1).

<sup>8</sup> Weiss (36).

<sup>3</sup> Seward (27).

<sup>6</sup> Watson (32), p. 9.

Three papers remain to be considered. In a note on the cortex of *Sigillaria mamillaris*, Arber and Thomas showed that the periderm was very similar to that of *S. scutellata*,<sup>1</sup> while Zalessky in 1909 gave a detailed account of the periderm in specimens referred by him to *Lepidodendron aculeatum*<sup>2</sup> and *Sigillaria Boblayi*.<sup>3</sup> In the former there are in one specimen peculiar wedge-shaped groups of thinner-walled, lighter-coloured cells, and in both species the tissue is assumed to be phelloderm owing to the presence of tangentially extended cells, with the tangential thinner than the radial walls, at places on the outer border.<sup>4</sup> In a further paper published in 1911, Zalessky describes shortly the periderm of his *Lepidodendron obovatum*, which is probably identical with *L. Hickii*, Watson.<sup>5</sup>

In 1910 appeared the second volume of Seward's 'Fossil Plants',<sup>6</sup> in which there is a full account of the periderm in various species of *Lepidodendron*, *Sigillaria*, *Stigmaria*, and *Bothrodendron*. Special stress is laid upon the indication of the position of the phellogen by the line along which splitting tends to take place. As a result any secondary cortex which has split off with the leaf-bases (frequently found in *Lepidophloios*, &c.) is regarded morphologically as true periderm, though it is uncertain whether or no it agreed with the cork of recent plants. By this means Seward locates the phellogen in *L. vasculare (selaginoides)*, *L. fuliginosum*, *L. Harcourtii*, and *Lepidophloios*, in all of which he finds the tissue is mainly thick-walled phelloderm.

Following the same test for the position of the phellogen in *Stigmaria*, Seward considers that in young specimens all the periderm is on the outer side of the phellogen, but that it is permeable and not of the nature of cork; that after a time phelloderm is formed on the *inner* side, and in old specimens constitutes the bulk of the secondary tissue. The zoning of the periderm of *L. selaginoides* and *L. Wunschianum*, and possibly of *Stigmaria*, is explained as due to the presence of secretory strands.

Seward comments on the great mechanical importance of the periderm, and draws special attention to the effect of its development on the external appearance. The older specimens of *L. selaginoides*, *L. Wunschianum*, *L. brevifolium*, and *Sigillaria* are all described as having thrown off their leaf-cushions and as possessing fissured bark.

The amount of space devoted in this volume to the consideration of the periderm of the fossil Lycopods compared to that in other text-books may be taken as some measure of the increase of knowledge of the tissue in recent years.

<sup>1</sup> Arber and Thomas (2).

<sup>3</sup> The *S. mamillaris* of Arber and Thomas.

<sup>5</sup> Zalessky (47).

<sup>2</sup> Not the same as Seward's *L. aculeatum*.

<sup>4</sup> Zalessky (46).

<sup>6</sup> Seward (28).

THE SPECIES EXAMINED.

The present paper is based on an investigation of the material in the collections at University College, London, and, by kind permission of Dr. A. Smith Woodward, of that in the Williamson Collection at the Natural History Museum. All the forms are British with the exception of *Sigillaria spinulosa*, which comes from Autun.

The following species showing a development of periderm have been examined :

<i>Lepidodendron selaginoides</i> ( <i>vasculare</i> )	<i>Sigillaria scutellata</i>
„ <i>Harcourtii</i>	„ <i>reniformis</i>
„ <i>Hickii</i>	„ <i>organum</i>
„ <i>brevifolium</i> ( <i>Veltheimianum</i> )	„ <i>elegans</i>
„ <i>intermedium</i>	„ <i>tesselata</i>
„ <i>obovatum</i> <sup>1</sup>	„ sp. ( <i>Eusigillariae</i> )
<i>L. (Lepidophloios) Wunschianum</i>	„ <i>spinulosa</i>
„ <i>fuliginosum</i>	<i>Bothrodendron mundum</i>
„ <i>Scottii</i>	<i>Stigmaria ficoides</i>
<i>Lepidodendron</i> sp.	„ of <i>Bothrodendron</i>
<i>Lepidophloios</i> sp.	„ sp.

The specimens examined of *Lepidodendron aculeatum*, *parvulum*, and *macrophyllum*<sup>2</sup> show no periderm.

THE PHELLOGEN.

(I) Place of Origin.

In all cases periderm formation originates in the *outer* cortex, from a zone of cells which may be situated

(a) almost immediately within the leaf-bases, with one to seven or so layers of primary cortex outside, as in

- Lepidodendron selaginoides*
- „ *brevifolium*
- „ *intermedium*
- „ *obovatum*
- „ *Wunschianum*

*Lepidophloios* sp.

All the ribbed *Sigillariae*

or (b) deeper in the outer cortex (about fifteen to thirty layers), as in

- Lepidodendron fuliginosum*
- „ *Scottii*
- „ *Harcourtii*
- „ *Hickii*

*Lepidophloios* sp.

*Stigmariae*.

<sup>1</sup> This species is not considered by Zalessky to be the true *L. obovatum*, Sternberg.

<sup>2</sup> The specimen shown in Text-fig. 1, B, may possibly be *L. macrophyllum*.

In *Bothrodendron* the periderm arises immediately within the radial primary cortex.

(2) **Development.**

The first beginnings of the phellogen may be seen in a few of the

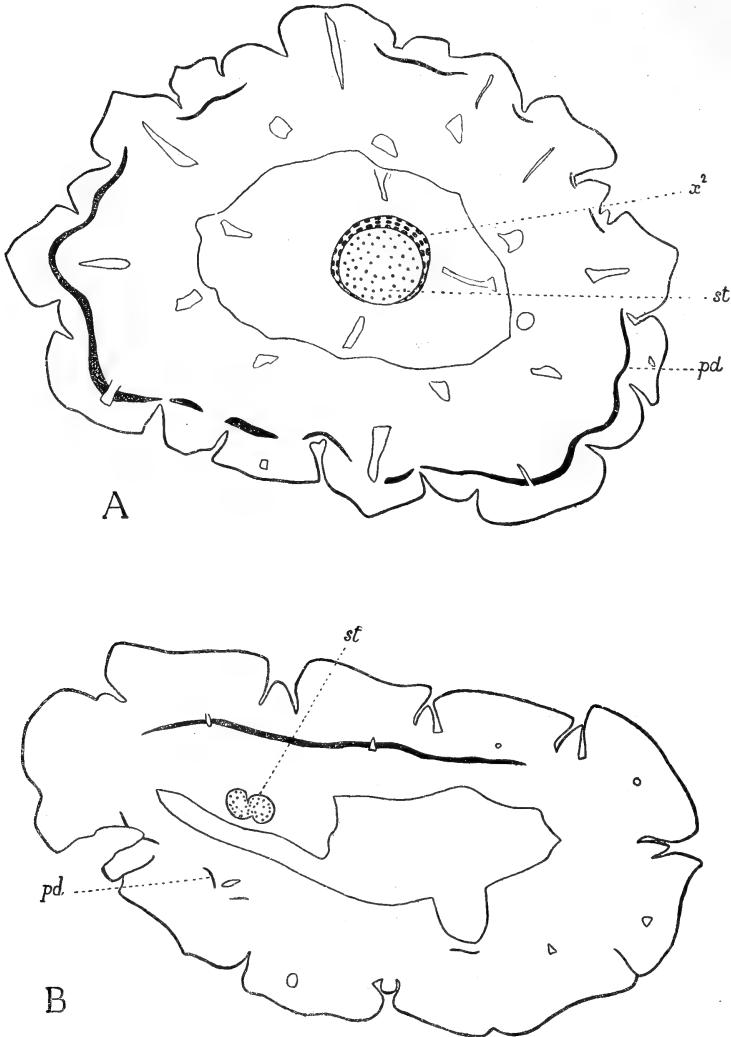

TEXT-FIG. 1. Diagrammatic transverse sections to show first beginnings of periderm formation. A, *Lepidodendron selaginoides*. Will. Coll., 342.  $\times 9$ . B, *Lepidodendron* sp. The developing periderm, *pd*, is shown in black; *st*, stele; *x*<sup>2</sup>, secondary wood. Will. Coll., 1922 E.  $\times 5$ .

younger specimens. It develops in detached areas round the stem, but not, as described by Williamson<sup>1</sup> and Hovelacque,<sup>2</sup> in regular arcs under each

<sup>1</sup> Williamson (41), p. 286, Pl. XLVII, Fig. 1. In the specimen figured the periderm really extends all round the stem, but is more strongly developed under the leaf-bases.

<sup>2</sup> Hovelacque (15), p. 158.

leaf-base. In *Lepidodendron selaginoides* and an undetermined *Lepidodendron* species these areas appear to be quite irregular in position (Text-fig. 1, A and B), but in another young twig they show a tendency to start from the middle of some of the leaf-bases (Text-fig. 2, A). In *Bothrodendron mundum* the secondary tissue is more regular in development, arising almost all round the stem at the same time (Text-fig. 2, B).

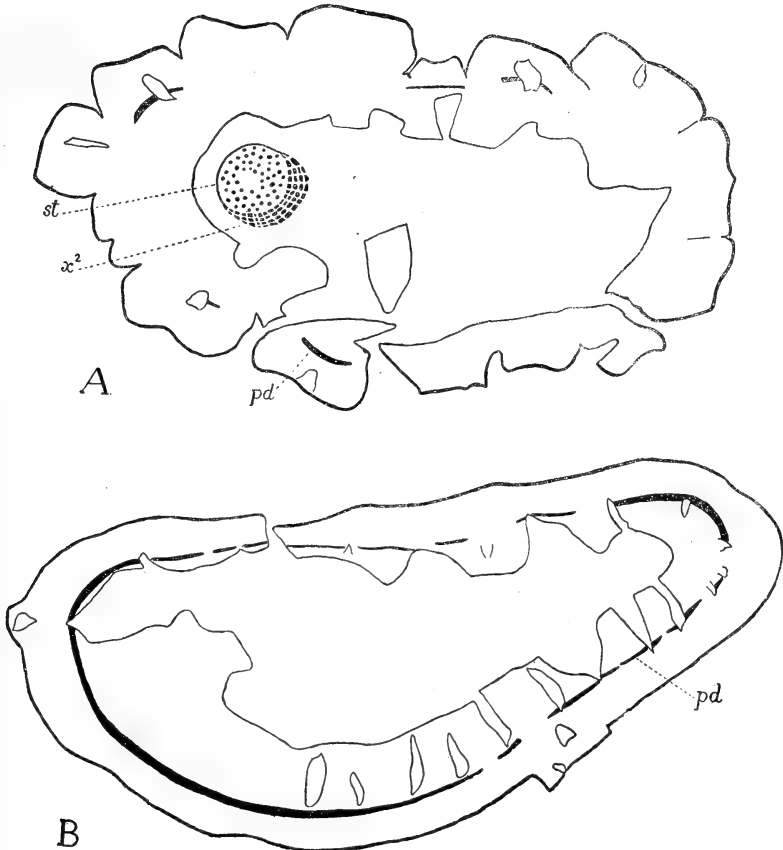

TEXT-FIG. 2. Diagrammatic transverse sections to show first beginnings of periderm formation. A, *Lepidodendron* sp. (*selaginoides*?). U. C. L. Coll., A 011. B, *Bothrodendron mundum*. *pd*, periderm; *st*, stele; *x*<sup>2</sup>, secondary wood. U. C. L. Coll., A 014.  $\times 12$ .

The developing meristem gradually extends until a complete cylinder is formed, but one or two gaps may remain for some time, as in *Lepidodendron Hickii*<sup>1</sup> and *L. fuliginosum*, and as a result of its irregular origin the secondary tissue produced is, at any rate at first, also irregular in thickness. Thus, in the specimens shown in Text-fig. 1, ten layers of periderm cells have already been formed in one place in A, and in B fourteen layers.

<sup>1</sup> Noticed first by Williamson (42), p. 7.

Watson noted that in *Lepidodendron Hickii* the phellogen was not yet formed all the way round, though part of the periderm was twenty cells thick;<sup>1</sup> while in a specimen of *Lepidodendron intermedium* there is an arc of secondary tissue which is thirty-five cells thick in the centre, but formed only on one side of the stem (Text-fig. 3).

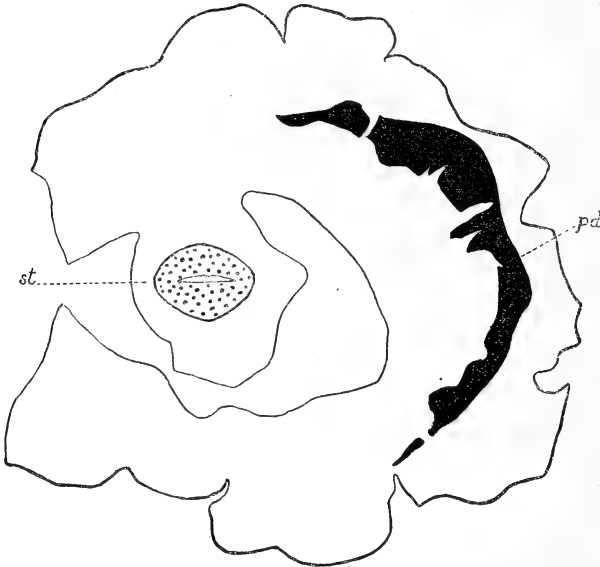

TEXT-FIG. 3. Diagrammatic transverse section of *Lepidodendron intermedium*, showing unequal development of periderm, *pd*; *st*, stele. U. C. L. Coll., A 48.  $\times 12$ .

### (3) Nature of the Meristem.

The phellogen arises by tangential divisions in certain of the cells of the outer cortex. Its formation, however, is not quite the same as

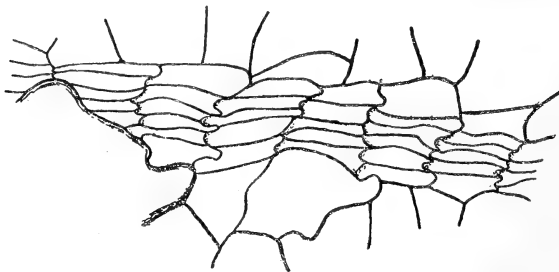

TEXT-FIG. 4. *Lepidodendron selaginoides*. Transverse section from the outer cortex showing the formation of the phellogen. Will. Coll., 342.  $\times 265$ .

is commonly found in recent plants, as it does not as a rule form a single continuous layer of meristematic cells, the products of which all pass directly into permanent tissue. The most regular case found is that of

<sup>1</sup> Watson (32), p. 9.

*Lepidodendron selaginoides*, where apparently a single layer of cells starts to divide (Text-fig. 4), but even here it seems probable that some of the secondary elements formed sometimes divide again. Text-fig. 4 shows the typical appearance of the flattened, thin-walled cells of the phellogen.

In other cases, as in *Lepidodendron Hickii*, *Bothrodendron*, and some young *Lepidodendron* species, the phellogenetic divisions may clearly be

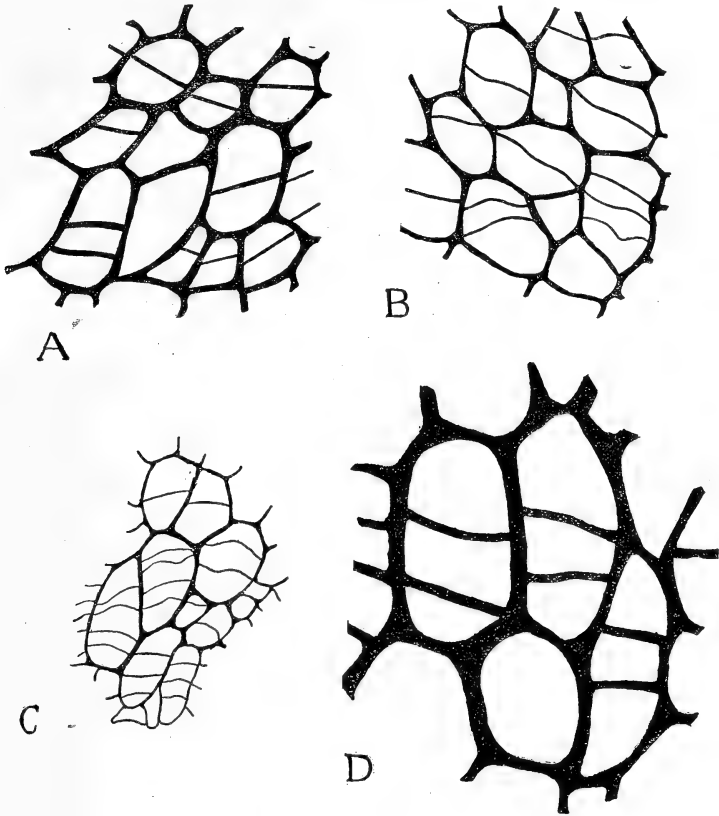

TEXT-FIG. 5. Transverse sections showing phellogenetic divisions starting in several layers of cells. A, *Lepidodendron* sp. Will. Coll., 1922 E. B, *Lepidodendron Hickii*. Will. Coll., 380 b. C, another *Lepidodendron* sp. U. C. L. Coll., A 49. D, *Bothrodendron mundum*. U. C. L. Coll., A 014. Slightly diagrammatic.  $\times 265$ .

seen starting in several layers of cells (Text-fig. 5), sometimes in two cells on the same radius.<sup>1</sup> The periderm of other species, of which there are no young examples, appears to have been similarly derived from this type of phellogen.

<sup>1</sup> Watson (loc. cit.) noted this in *L. Hickii*, and thought it might mark the beginning of a secretory passage, but there seems no reason to suppose this, especially as no such passages have been found in this species.

As is to be expected, the meristem keeps pace with the growth of the circumference by means of radial divisions (Text-fig. 6).

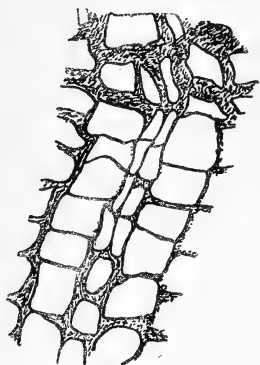

TEXT-FIG. 6. *Lepidodendron selaginoides*. Transverse section from the outer border of the periderm, showing files formed by radial divisions in the meristem to keep pace with growth. U. C. L. Coll., A 012.  $\times 265$ .

#### (4) Position relative to the Secondary Tissue produced.

Even in young specimens, such as those shown in Text-fig. 5, it is generally hard to tell in what direction and in what order the divisions have taken place, i. e. how much of the secondary tegumentary tissue formed corresponds morphologically to cork, and how much to phelloderm. In older specimens it is quite exceptional that the actual meristematic cells can still be distinguished with certainty. As a result their position has been a matter of much speculation, as has been pointed out in the historical review. Among recent observers, the reasons given by Arber and Thomas, Zalesky, and Seward for their determinations of the position of the phellogen, in the absence of direct evidence, have already been mentioned.<sup>1</sup>

In the present investigation the lines of split, on which reliance has been placed on the ground that the delicate phellogen would form a natural

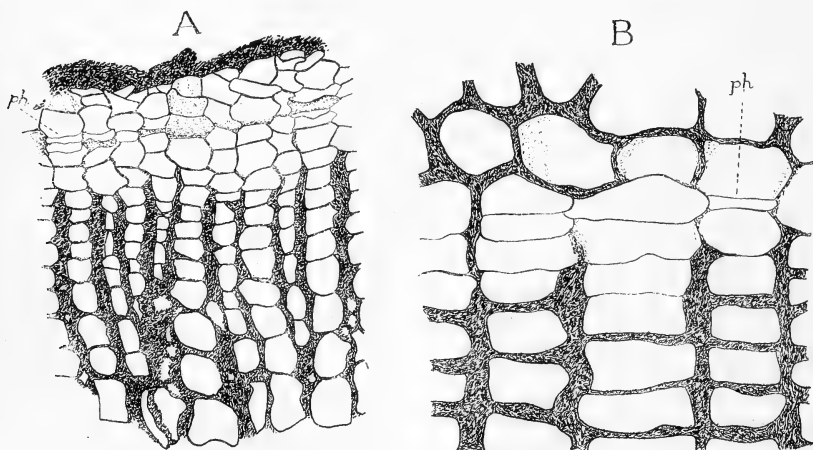

TEXT-FIG. 7. A, *Lepidodendron selaginoides*. U. C. L. Coll., A 012. B, *Sigillaria* sp. Will. Coll., 656. Transverse sections in the periderm showing the phellogen, *ph*.  $\times 265$ .

plane of weakness in the stem,<sup>2</sup> have been taken into consideration; but in the specimens examined the position, except in *Lepidodendron selaginoides*

<sup>1</sup> Loc. cit.

<sup>2</sup> Seward (28), pp. 107, 115, &c.



and some Stigmariæ, was rarely at all constant, partly perhaps a consequence of the phellogen frequently not forming a regular and continuous line of cells. Reliance has not been placed on the size or flattened appearance of some of the cells, unless accompanied by less thickness of the walls, and where the probable position of the phellogen is indicated, this has in all cases been coupled with the absence of any signs of it in other parts of the tissue.

The phellogen can still be distinguished in

(a) *Lepidodendron selaginoides*. In this species the phellogen is sometimes well preserved, as at *ph* in Text-fig. 7, A, where the thin-walled dividing cells may be clearly seen. Nearly all the secondary tissue formed is phelloderm, there being only one or two rows of cells on the outer side of the meristem. In older examples a few more layers of cells may be cut off towards the exterior. This determination agrees with that arrived at by nearly all observers except Hovelacque.<sup>1</sup>

(b) *Sigillaria* sp. (*Rhytidolepis*). The dividing cells are here found on the outer border of the secondary tissue, which therefore may be regarded as entirely phelloderm (Text-fig. 7, B).

In the following species there are *indications* of the position of the phellogen:

(a) The bulk of the secondary tissue appears to be phelloderm, with possibly one to four or five layers of cells formed on the outer side of the phellogen, for, although there are signs of recent divisions, it cannot be said exactly which are the meristematic cells (Text-fig. 8).

*Lepidodendron intermedium*

„ *obovatum*

*Lepidodendron* sp.

*Lepidophloios* (type of *Lepidodendron fuliginosum*)

*Lepidophloios* sp.

*Sigillaria scutellata*

*Sigillaria elegans*

*Sigillaria* sp.

Arber and Thomas came to the same conclusion about the position of the phellogen in *Sigillaria scutellata*,<sup>2</sup> and this is now further supported by the specimen shown in Text-fig. 7, B, which also belongs to the *Rhytidolepis* section. It should be noted that in all the ribbed *Sigillariæ* the periderm is split off internally.

In the *Lepidophloios* from the Williamson Collection (C. N. 1955) shown in Text-fig. 8, A, this determination does not agree with that of Seward, who states for a similar specimen, consisting of leaf-bases and

<sup>1</sup> Hovelacque (15), pp. 29, 158.

<sup>2</sup> Arber and Thomas (1), p. 141.

periderm, that the section had split off along the phellogen, so that the secondary cortical tissue preserved was formed on its outer side.<sup>1</sup>

(b) *Stigmariae*. The periderm of the *Stigmariae* presents at least two distinct types.

Type 1. The periderm is fairly regular in appearance (Pl. XXIV, Fig. 1), and seems to have been developed on the *outer* side of the phellogen. Only part of the periderm is generally preserved, and there are cambial-looking cells along its inner margin (see Text-fig. 9, A, *ph*). When, in rare cases, the whole of the periderm is present, the inner layers are seen to consist of very delicate and thin-walled cells which pass imperceptibly

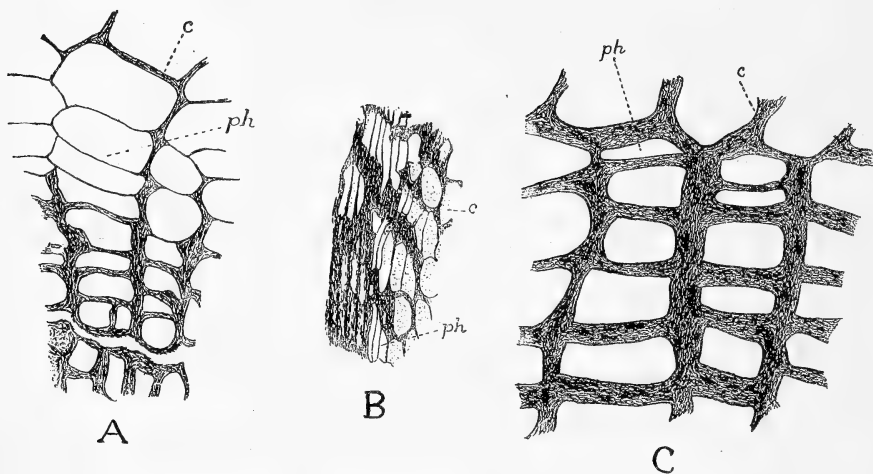

TEXT-FIG. 8. Sections showing indications of the position of the phellogen near the outer margin of the periderm. A, transverse section of *Lepidophloios* sp. Will. Coll., 1955. B, radial section of *Lepidodendron fuliginosum*. U. C. L. Coll., A 33. C, transverse section of *Sigillaria elegans*. *ph*, phellogen; *c*, cortex outside periderm. U. C. L. Coll., E 5 a. A and C  $\times 265$ , B  $\times 90$ .

into the primary cortex. This is shown in Pl. XXIV, Fig. 1. At *x* a cell may be seen which has just divided.

Type 2. The periderm consists of a very irregular, wide-celled outer portion (Pl. XXIV, Fig. 2, *a*), of which many of the cells retain the power of division and which may receive additions from the division of cells of the outer cortex, and a more regular and smaller-celled internal portion (Pl. XXIV, Fig. 2, *b*). This latter, which may greatly exceed the outer portion in thickness, is usually broken off abruptly on the inner side. In this type, though a disorganized band of cells is all that can generally be distinguished, the phellogen is probably at the junction of the two different kinds of tissue (Pl. XXIV, Fig. 2, *ph*), and forms the wide cells to the exterior and the narrower files on its inner surface by means of further radial divisions. Occasionally these divisions may lapse, and a wide-celled file extend some

<sup>1</sup> Seward (28), p. 109.

way on the inner side of the supposed phellogen line (see Text-fig. 20, B). Text-fig. 9, B, shows signs of the phellogen in one of these wide-celled Stigmariae in which none of the inner portion of the periderm is preserved.

This determination agrees in the main with that of Seward, except that he considers the first type as a younger stage of the second<sup>1</sup> (but the specimen of type 1 shown in Pl. XXIV, Fig. 1, for example, has more wood than the specimen of type 2 shown in Pl. XXIV, Fig. 2), while it would also reconcile the views of Solms<sup>2</sup> and Scott<sup>3</sup> that the phellogen was on the *inner* side of the periderm, inferred from type 1, and of William-

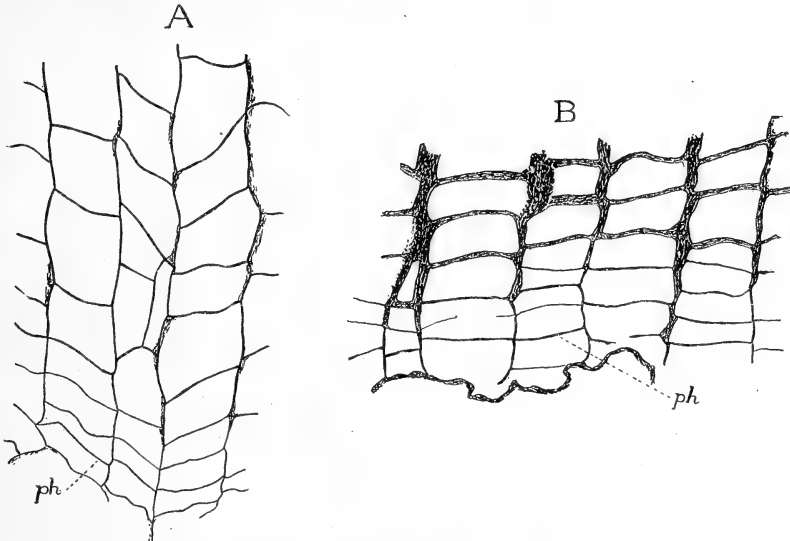

TEXT-FIG. 9. Transverse sections showing indications of the phellogen, *ph*, in Stigmariae. A, type 1. Will. Coll., 764. B, type 2. U.C. L. Coll., CC 7 h. The tissues on the inner side are not preserved.  $\times 265$ .

son<sup>4</sup> that it was near the *outer* margin, inferred from specimens of type 2 with a large development of the regular inner portion of the tissue.

In the following species no satisfactory indications of the position of the phellogen have been found during the present investigation, but in certain cases other observers have made comments as to its position, and these are given below:

*Lepidodendron Harcourtii* and *Hickii*. Scott<sup>5</sup> and Seward<sup>6</sup> consider that the phellogen is near the centre of the periderm. Bertrand thought it was on the inner side.<sup>7</sup>

*Lepidodendron brevifolium*. There is some indication that the phellogen was near the outer margin of the secondary tissue, where there

<sup>1</sup> Seward (28), pp. 243-4.

<sup>3</sup> Scott (24), p. 247, 2nd ed.

<sup>5</sup> Scott (24), p. 139.

<sup>7</sup> Bertrand (3), p. 86.

<sup>2</sup> Solms-Laubach (30), p. 274.

<sup>4</sup> Williamson (43), p. 21.

<sup>6</sup> Seward (28), p. 161, Fig. 179.

may be seen rather delicate-looking cells and traces of broken cell-walls.

*Lepidodendron Wunschianum*. Seward and Hill assumed that the secondary cortical tissue was all phelloderm,<sup>1</sup> but the outer margin is not preserved. The inner margin certainly shows no sign of the presence of meristem.

*Lepidodendron fuliginosum*. Weiss assumed that the secondary cortical tissue was all phelloderm.<sup>2</sup> Seward states that it is chiefly so.<sup>3</sup>

*Lepidodendron Scottii*.

*Bothrodendron mundum*.

*Sigillaria tessellata*.

*Sigillaria spinulosa*. In an allied species Renault and Roche speak of the *internal* renewal of the periderm layer.<sup>4</sup> The material available for the present paper did not show either margin of the secondary cortical tissue, but it will be shown later (p. 307) that it is more probable that the phellogen was on the outer side.

In an examination into the physiological anatomy of the periderm, this question as to the position of the phellogen in the tissue would seem to be of the greatest importance. It may therefore be stated at once that, whatever the morphological nature of the secondary tissue, there is no evidence to show that any of it was other than secondary cortex, even when some portion is formed on the outer side of the phellogen. It is probable from the whole nature of the periderm and its formation that in the fossil Lycopodiales there was not that strict division of labour which so sharply differentiates the cork from the phelloderm in the periderm of gymnospermous and dicotyledonous plants. If this is so the direction of the divisions (i. e. centripetal or centrifugal) is no longer connected with difference in function, and becomes a matter of minor significance.

#### (5) Persistence.

In the species examined the original phellogen was persistent, at least up to the time of preservation, and was not, as in so many recent plants, replaced at intervals by the development of a more internal phellogen.<sup>5</sup> Arber and Thomas have suggested that it was of a periodic nature, at any rate in *Sigillaria scutellata*, on account of the difficulty in distinguishing a definite cambial layer, and of the presence of concentric zones in the periderm, which they interpreted as rings of growth.<sup>6</sup> When it is remembered, however, what a very large number of specimens show no definite phellogen, and that only a few of these are at all regularly zoned, it

<sup>1</sup> Seward and Hill (29), p. 917.

<sup>3</sup> Seward (28), p. 153.

<sup>5</sup> With one possible exception (see p. 317).

<sup>2</sup> Weiss (33), p. 229.

<sup>4</sup> Renault and Roche (23), p. 17.

<sup>6</sup> Arber and Thomas (1), p. 141.

seems more likely that this condition is due to the vicissitudes incidental to petrification, rather than to preservation at a time of inactivity of the meristem.

#### THE PERIDERM.

##### (1) General Description.

The periderm forms a most striking feature of the stems and Stigmariæ of fossil Lycopods. It may attain a thickness of seven or eight centimetres, and, in petrifications of many specimens, periderm and xylem alone are preserved, while detached pieces of the tissue are also extremely common. Always easily recognizable, even in young specimens, by the character of its elongated cells and their arrangement in regular radial files, it may readily be distinguished near the periphery of the organ, where it forms a cylindrical or wavy band of tissue, often rather dark in colour, and very frequently showing some sort of zonation.

Generally the periderm presents a homogeneous appearance in transverse section, but, as has been mentioned, the outer layers of certain Stigmariæ are very conspicuously extended tangentially, while in *Sigillaria spinulosa* and other species of its type the outer portion forms a network, of which the strands consist of typical periderm cells, while the meshes are filled with thin-walled parenchymatous tissue.

##### (2) Size and Shape of the Cells.

The characteristic cells of the periderm, which have frequently been described, are prosenchymatous, often many times as long as broad, with parallel sides and pointed, somewhat gabled, ends.

In *transverse* section they are generally smaller than the cells of the outer cortex, and vary considerably, both in size and shape, even in adjacent files (see Text-fig. 7, &c.). On the whole they are radially elongated, except the outer cells near the phellogen, which are frequently tangentially extended. In the second type of Stigmarian periderm mentioned on p. 294, the tangential extension of many of the cells of the outer part of the tissue is most striking (Pl. XXIV, Fig. 2). It is not merely 'a necessary result of the position of the phellogen on the internal edge of the tissue and of the increasing girth of the axis',<sup>1</sup> but depends on the actual nature of the wide-celled portion, of which there are so few files compared to the number formed on the *inner* side of the supposed phellogen. In type 1 the extension is hardly noticeable (Pl. XXIV, Fig. 1).

In *radial* section the appearance of the periderm is very characteristic on account of the parallel sides of the cells, and of all the members of one file being of uniform length, so that the end walls form almost straight lines. The variations in appearance produced, owing to most sections being more

<sup>1</sup> Seward (28), p. 243.

or less oblique, may readily be understood by means of cutting small models. Thus sections, without departing far from the radial, may cross from one file into another with end walls at a different level, or, if somewhat transverse, may cut across the side instead of the end walls, making the cells appear comparatively short (see Text-fig. 16, C).

In *tangential* section the periderm cells, as already stated, are commonly narrower, and their ends more pointed than in radial view (see Text-fig. 17). It is from tangential sections that the heterogeneous nature of the cells in certain periderms, which will be referred to later (p. 304), becomes at once apparent.

### (3) Character of the Radial Files.

The cells of one radial file generally alternate with the contiguous cells of the files on either side, and frequently also with those above and

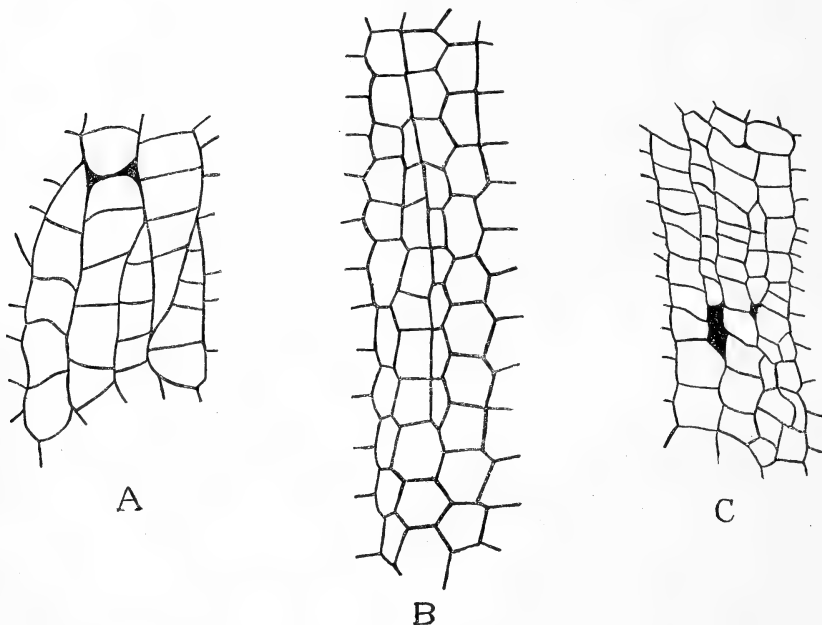

TEXT-FIG. 10. Diagrammatic transverse sections showing short files in the periderm. A, *Lepidodendron Hickii*. Will. Coll., 380 b. B, *Sigillaria scutellata*. U. C. L. Coll., B 12. C, *Lepidodendron selaginoides*. U. C. L. Coll., A 012.  $\times 265$ .

below. Haberlandt showed that in cork the former arrangement facilitated stretching in the tangential direction,<sup>1</sup> while according to the same authority great additional strength is given to prosenchymatous tissues by the close interlacing of their pointed ends.<sup>2</sup>

Typically in transverse section each radial file extends throughout the width of the periderm, but most preparations show frequent exceptions

<sup>1</sup> Haberlandt (13), p. 127, 4th ed.

<sup>2</sup> Loc. cit., p. 142.

(see Text-figs. 10 and 11, A; Pl. XXIV, Figs. 1 and 2, &c.). Often there are files which do not quite reach to the outer border of the secondary tissue; then there are some files which taper away before reaching the inner margin, and, in a few species, also some which at neither extremity reach the border of the periderm.<sup>1</sup> In *Stigmariae* the arrangement is specially irregular. The appearances produced are probably due to various causes. The files may not all run continuously in the same horizontal plane; or if the sections are not quite transverse, new files get cut across at intervals, first at the narrow ends of the cells, and then in the wider parts, while correspondingly other files gradually pass out of the section (Text-fig. 10, B). Then again the periderm may not have originated in a single layer of cells at the same level (Text-fig. 10, A, and Text-

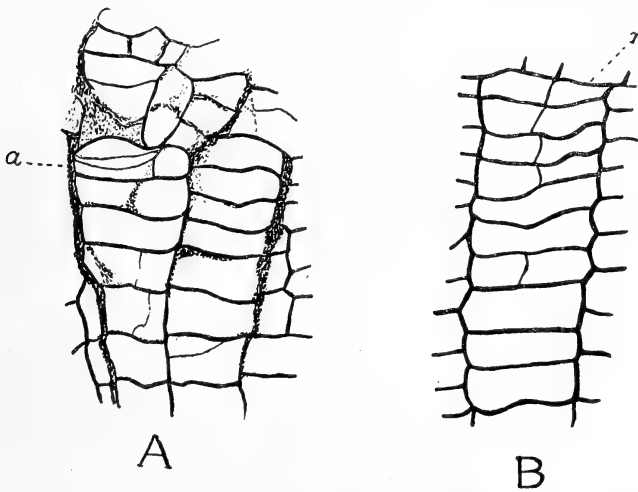

TEXT-FIG. 11. Transverse sections from the outer part of the periderm of *Stigmaria* (type 2). A, irregular tangential divisions at *a*. B, recently formed radial septa forming a new short file, *r*. U. C. L. Coll., CC 7 h.  $\times 90$ .

fig. 4); and further irregularity is caused by radial divisions in the phellogen to keep pace with growth (see Text-fig. 5), and possibly also by displacement.

It appears probable that in some cases short files may be produced by subsequent division of the cells of the periderm (Text-fig. 10, C). This would help to account for the very irregular arrangement in *Stigmariae* (Pl. XXIV, Figs. 1 and 2), and recently formed radial septa may be traced in places (Text-fig. 11, B). In the wide-celled type of *Stigmarian* periderm further tangential divisions may also take place (Text-fig. 11, A), as was mentioned on p. 294, and many of the cells of the cortex outside the periderm may start to divide (Pl. XXIV, Fig. 2, *e*), producing additional files, and

<sup>1</sup> Similar short files may be found in transverse sections of the secondary wood of these plants.

thus contributing to the irregular appearance. Sometimes almost the whole of the outer tissues appears to be in a meristematic condition.

#### (4) Structure and Thickening of the Cell-wall.

The outer primary cortex in the fossil Lycopodiales is typically thick-walled, and, in the species examined, the walls of the periderm cells are found to be of about the same thickness<sup>1</sup> (Text-fig. 8, &c.), though in some *Sigillariae* they are rather thicker, and in *Stigmariæ* often considerably thinner. The frequent appearance of the periderm as a thickened band is generally due to the smaller size of the cells, sometimes also to brown coloration of the contents.



TEXT-FIG. 12. Transverse section of a file of periderm cells of *Lepidodendron selaginoides*, showing the thickening of the walls. *ph*, phellogen; *c*, primary cortex. U.C.L. Coll., A 012.  $\times 40$ .

The stages in the thickening up of a file of periderm cells of *Lepidodendron selaginoides* are shown in Text-fig. 12, from the thin-walled cells of the phellogen at *ph*, to the mature cells with walls of the same thickness as the primary cortex *c* adjacent on the inner side. (The very thick appearance of the radial walls is local, and is probably due to swelling of the membrane in mineralization.)

The thickening is generally uniform over the surface of the periderm cell. Seward and Hill observed in *Lepidodendron Wunschianum* that in some of the outer cells the lumen was almost obliterated, but this they considered might be due to swelling during petrification.<sup>2</sup> In some other species there is in places noticeable swelling of certain of the walls. This is shown in Text-fig. 13, A, in a *Lepidophloios*, where it occurs on the radial walls, while in certain specimens of *Lepidodendron selaginoides* (Text-fig. 13, B) the outer tangential walls have the same appearance. This thickening is quite irregular in occurrence, and seems due to local swelling of the membranes, and possibly splitting of the middle lamella and subsequent filling with intercellular substance.

The walls of the periderm in general, as was noticed early, do not show any signs of pitting, not even of slit-like pits such as are found in the prosenchymatous tissues of recent plants.<sup>3</sup> Renault stated that the periderm of *Stigmaria Brardi* consisted of reticulated cells,<sup>4</sup> but these have since been referred to as if they were

<sup>1</sup> The thin-walled cells of the meshes of Dictyoxyton types are not here considered.

<sup>2</sup> Seward and Hill (29), p. 917, Pl. IV, Fig. 27.

<sup>3</sup> de Bary (11), p. 132, Haberlandt, &c.

<sup>4</sup> Renault (21), p. 195, Pl. XXXIX.



tracheides,<sup>1</sup> while in a recent paper Zalessky speaks of the ' *stries spirales* ' seen in vertical sections of the periderm of his *Lepidodendron obovatum*.<sup>2</sup>

As regards the thickening substance, one can say with certainty that it was not suberin. The walls of the secondary cortex must have been permeable to water, for, whenever the tissues outside are preserved, they show none of the characteristic signs of arrested activity and collapse produced in cells isolated by a zone of cork. The impossibility of the periderm being of the nature of true cork has been pointed out several times, chiefly in regard to *Stigmaria*,<sup>3</sup> though other writers who have recognized it as phelloderm have spoken of it as being cork-like in function,<sup>4</sup> or as having

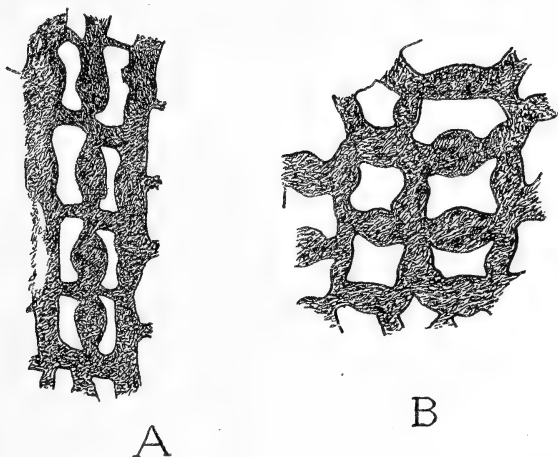

TEXT-FIG. 13. Transverse sections of certain periderm cells showing local swelling of the walls. A, *Lepidophloios* sp. U. C. L. Coll., A 32. B, *Lepidodendron selaginoides*. U. C. L. Coll., A 0121. x 265.

some suberized layers.<sup>5</sup> It should perhaps be mentioned that the cork crusts of some recent plants do not always have suberized walls, e.g. *Ulmus suberosa*, but the quantity produced makes up for defects in quality, and many of the cells are true cork.<sup>6</sup> In the plants under consideration the cortex nature of the periderm is confirmed by other qualities, and, though it may have contributed to the protection of the interior tissues, this was probably quite a secondary function.<sup>7</sup>

#### (5) Cell Contents.

The cells of the periderm of nearly all the species show as much sign of contents as the adjacent cortex, and there are therefore no indications

<sup>1</sup> Weiss (36), p. 223; Seward (28), p. 242.

<sup>2</sup> Zalessky (47), p. 5.

<sup>3</sup> By Williamson and Solms, and later by Scott and Seward.

<sup>4</sup> Weiss (33), p. 229.

<sup>5</sup> Arber and Thomas (2), p. 514.

<sup>6</sup> See Haberlandt (13), p. 125, 4th ed.

<sup>7</sup> Two cases of wound periderm in the fossil Lycopodiales have been mentioned, by Seward (27) and Weiss (34), but none has been examined in the present investigation.

that the periderm was an empty, air-filled tissue, as is the cork of recent plants. Of course a very large number of the cells are empty, while others contain black lumps, such as may also be seen in the xylem, or are coloured brown in large patches. But cells with traces of apparently real contents are also found, some types of which are illustrated in Text-fig. 14. Of these the appearance of one cell of B may have been produced by the mycelium

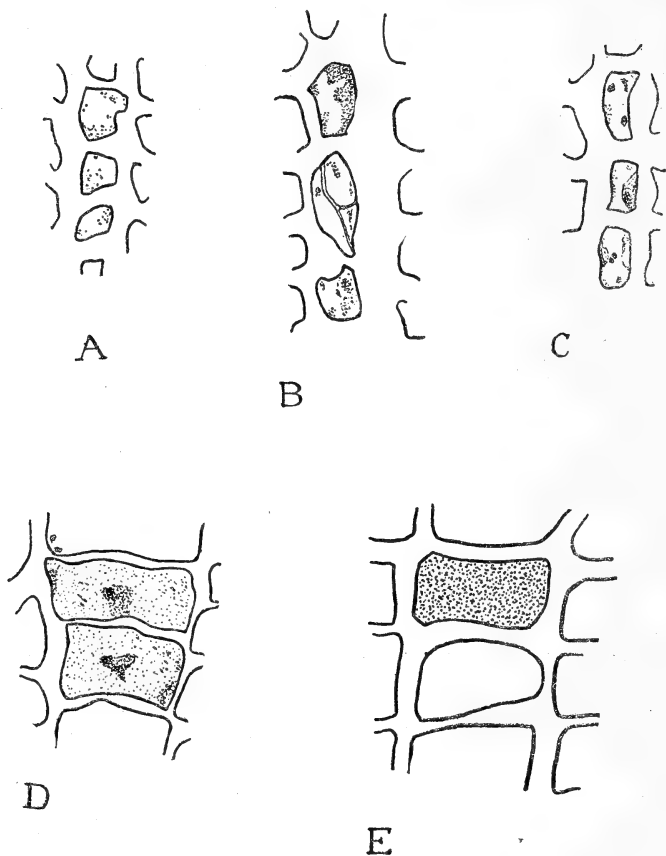

TEXT-FIG. 14. Types of the contents of periderm cells. A, *Lepidodendron selaginoides*. U. C. L. Coll., A 0122. B, *Sigillaria scutellata*. U. C. L. Coll., B 11. C, *Lepidodendron fuliginosum*. U. C. L. Coll., A 32. D, *Stigmaria*. U. C. L. Coll., D 8. E, *Lepidophloios* sp. U. C. L. Coll., A 39 c.  $\times 265$ .

of a fungus.<sup>1</sup> In E certain of the cells have an even brown stain, which may represent tannin or a like substance, while the contents of the periderm of *Lepidodendron Wunschianum* in tangential section have also been compared in appearance to vacuolated tannin.<sup>2</sup> Tannin and its decomposition products may, however, be found also in true cork.<sup>3</sup>

<sup>1</sup> Cp. Lignier (16), p. 197, Fig. 4.

<sup>2</sup> Seward and Hill (29), p. 916, Pl. III, Fig. 20.

<sup>3</sup> Haberlandt (13), p. 124.

The contents are fairly evenly distributed through the tissue, and not, like the dried-up remains of contents in cork, in greater quantity near the phellogen.

(6) Intercellular Spaces.

As regards intercellular spaces, the periderm partakes of the nature of the outer cortex. This is on the whole a closely set tissue with but few intercellular spaces, and a certain number have been found in the periderm of all the species except *Bothrodendron mundum* and *Sigillaria spinulosa*.

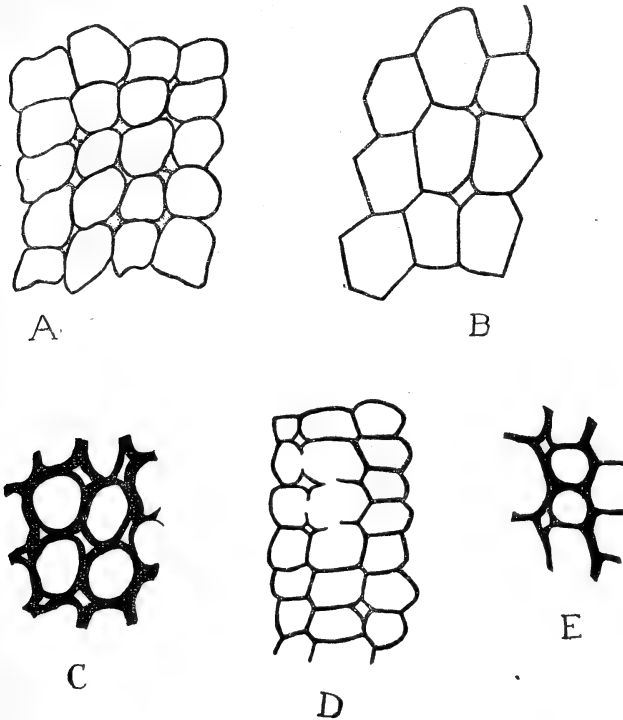

TEXT-FIG. 15. Intercellular spaces in the periderm. A, *Lepidodendron selaginoides*. U. C. L. Coll., A 012. B, *Stigmaria*. U. C. L. Coll., D 1. C, *Lepidodendron Wunschianum*. Will. Coll., 452. D, *Lepidodendron Hickii*. U. C. L. Coll., A 1. E, *Sigillaria* sp. U. C. L. Coll., S 37.  $\times 265$ .

Examples are shown in Text-fig. 15. In *Lepidodendron Wunschianum* the spaces are rather abundant, and attention was drawn to them by Seward and Hill.<sup>1</sup>

It would therefore appear that the periderm was at any rate as permeable to gases as the adjacent cortex.

<sup>1</sup> Seward and Hill (29), p. 915, Pl. III, Fig. 18.

(7) **Heterogeneous Periderms.**

Bearing in mind the general nature of the periderm cells as described, one may now turn to the species in which the secondary cortical tissue is not quite homogeneous.

(a) The simplest variation from the ordinary type consists in the occurrence in the periderm of many cells which have become chambered by horizontal, and occasionally also by vertical septa<sup>1</sup> (Text-fig. 16). These

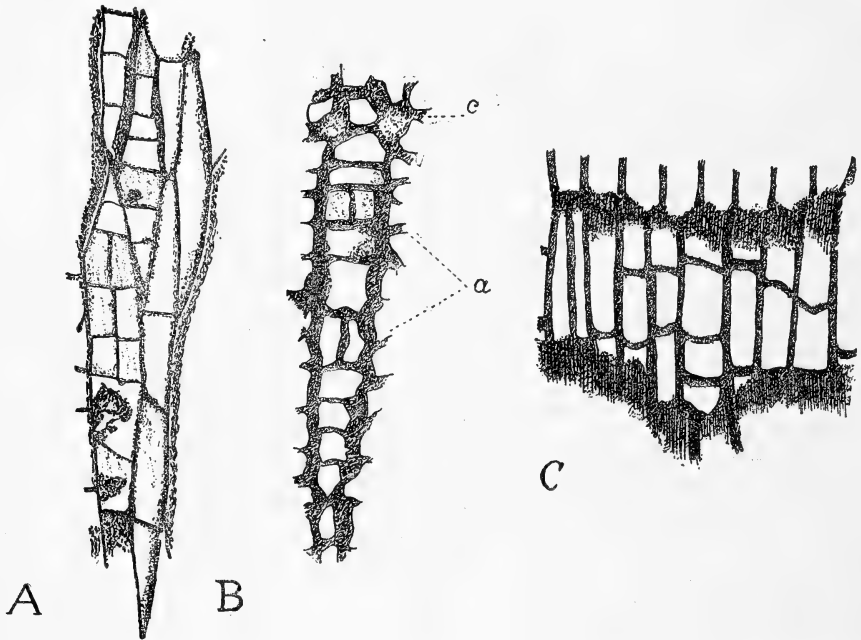

TEXT-FIG. 16. Chambered cells in the periderm of a *Lepidophloios* sp. A, tangential section showing both horizontal and vertical septa. U. C. L. Coll., A 39 g. B, transverse section near the outside of the periderm. a, cells divided by vertical septa; c, outer cortex. U. C. L. Coll., A 39 a. C, obliquely radial section from the outer border of the periderm. U. C. L. Coll., A 39 d.  $\times 90$ .

have been found in a species of *Lepidophloios* and also in a *Lepidodendron*. Of the former there are transverse (Text-fig. 16, B) and obliquely radial (Text-fig. 16, C) as well as tangential sections, from which it is seen that the chambered cells occur chiefly in the outer layers of the periderm.

(b) In the second case, as found in two forms of ribbed *Sigillaria*, one of which is referred to *S. reniformis*, there are the same chambered cells to be seen in tangential section, but they are arranged in definite vertical groups (Text-fig. 17), and are rather wider and lighter in colour than the rest of the periderm. The septa here seem to be all horizontal.

<sup>1</sup> The cells recall somewhat the chambered bast and libriform cells of recent plants, but the transverse walls are not specially thin.

In *Sigillaria scutellata* it has been noted that some of the cells, especially in the deeper portions of the phelloderm, are chambered,<sup>1</sup> but no vertical sections of this species have been examined in the present investigation.

(c) It would appear that the complex periderm known as 'Dictyoxyylon cortex' may be regarded as derived on similar lines to the above types. Dictyoxyylon cortex, as often described, consists essentially of a network;

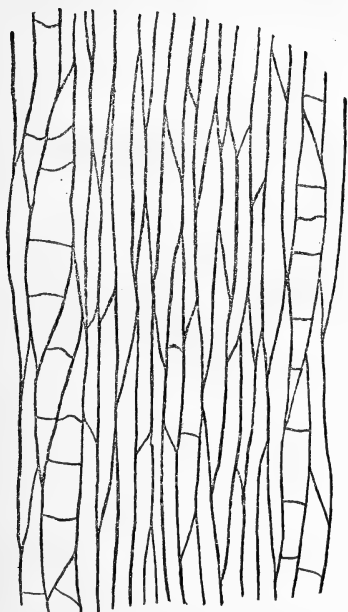

TEXT-FIG. 17. Tangential section in the periderm of *Sigillaria* sp., showing vertical groups of chambered cells. Will. Coll., 662.  $\times 100$ .

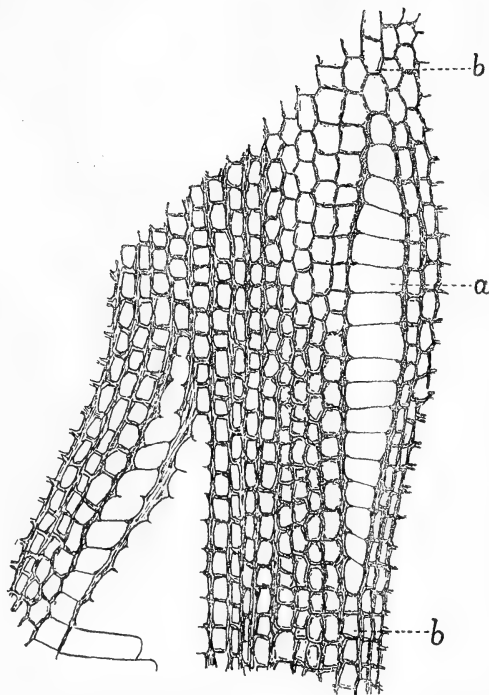

TEXT-FIG. 18. *Sigillaria spinulosa*. Transverse section in the periderm showing the origin of the thin-walled meshes, *a*, in the cells of the regular radial files, *b*. Will. Coll., 665.  $\times 100$ .

of which the strands are ordinary periderm cells, while the meshes, visible alike in transverse and vertical sections, are filled with thin-walled, brick-like parenchyma.<sup>2</sup> It is not to be confounded with the *primary* outer cortex of *Lyginodendron* and *Heterangium* with its strands of fibrous sclerenchyma, to which the term 'Dictyoxyylon' is also applied.

According to Renault, the meshes in *Sigillaria spinulosa*, &c., are not found in the inner part of the tissue, and gradually increase in size towards the periphery. From the transverse section shown in Text-fig. 18, it will

<sup>1</sup> Arber and Thomas (1), p. 142.

<sup>2</sup> Described in the following: *Lepidodendron rhodumnense*, *Lepidodendron esnostense*, *Sigillaria spinulosa*, *Sigillaria lepidodendrifolia*, *Stigmaria Brardi*.

be seen that the delicate mesh cells, *a*, are formed in the ordinary radial files by a certain number of the cells being left thin-walled, and becoming extended in the tangential direction, whilst typical periderm cells, *b*, are present both within and without.

By examining the meshes in tangential section it is found that these thin-walled cells divide by horizontal septa into chambered cells, while each segment may undergo further vertical divisions (Text-fig. 19, A), so that later the outline of the original extended prosenchymatous cell is lost; but

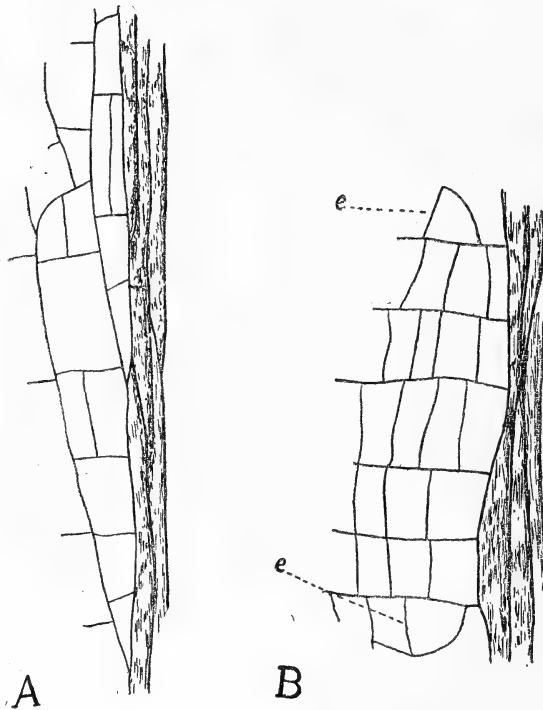

TEXT-FIG. 19. *Sigillaria spinulosa*. Tangential sections through two meshes, A and B. A still shows the extended thin-walled prosenchymatous cells of the mesh. In B the prosenchymatous form has been lost as a result of further divisions, but the pointed end-segments can still be seen at *e*. Will. Coll., 668.  $\times 100$ .

the occurrence of the pointed end-segments still gives the clue to the origin of the mesh (Text-fig. 19, B, *e*).

As there are no thin-walled meshes left in the inner portion of the tissue, and as they increase in size towards the exterior, it would seem probable that the smallest meshes were the first formed, and that larger groups of cells were left thin-walled as time went on, i.e. that the phellogen was near the *outer* margin.

The Dictyoxylon arrangement perhaps presented a means of economy of thickening material and adaptation to a continually increasing circum-

ference in a tissue which attained a great thickness (7 or 8 cm.), and the growth of which may have been very rapid.

(d) Turning to the irregular wide-celled forms of Stigmarian periderm, it is found from tangential sections that here also a large number of the wide outer cells are chambered.<sup>1</sup> Text-fig. 20, A, is drawn from a tangential section of the specimen figured in transverse section in Text-fig. 20, B, and it is seen that many of the cells show subdivisions.

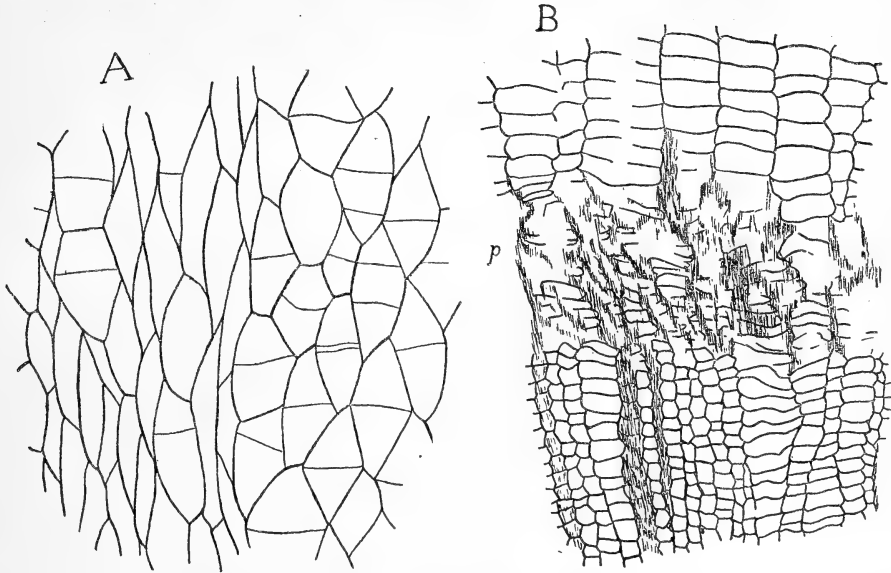

TEXT-FIG. 20. *Stigmaria* sp. (type 2). A, tangential section in the outer part of the periderm showing chambered cells. Will. Coll., 1785. B, transverse section of the same specimen; the probable position of the phellogen is shown at *p*. Will. Coll., 1780.  $\times 55$ .

In other cases, where more narrow files intermix with the distended ones and the wide cells which become chambered occur in irregularly lenticular areas, a somewhat Dictyoxylon-like appearance is produced in tangential section (Text-fig. 21). As has been mentioned, Williamson described a series of sections of the above type, thinking they were identical with Renault's *Sigillaria spinulosa*.<sup>2</sup> From this series, in which there is a large quantity of the regular inner portion of the periderm preserved, it is seen that the dividing cells occur in the outer wide-celled portion of the secondary tissue, and die out rapidly in the regular inner part.

It is probable that these Stigmariæ should be referred to stems which have similar heterogeneous periderms.<sup>3</sup>

<sup>1</sup> First noticed by Williamson (48), p. 20, Figs. 24 and 49.

<sup>2</sup> Williamson (39), pp. 353-6, Pl. XXV.

<sup>3</sup> As already found in *Clathraria* and *Stigmaria Brardi*, Renault (21), p. 194.

(e) Mention may be made here of the presence in one section referred to, *Lepidodendron brevifolium*, of wedges of light-coloured cells, much extended tangentially, which start in the cortex on the outside of the periderm, and project some way into it. The cells are thin-walled and have often broken down; the rest of the periderm is badly preserved, and unfortunately no tangential sections are available. Part of one of these wedges is shown (restored) in Text-fig. 22. Zalesky<sup>1</sup> mentions very similar wedges in the species he refers to *Lepidodendron aculeatum*, Sternb., and says that in tangential section the cells are 'divided by transverse, sometimes also by longitudinal, partitions into a row of cells'.

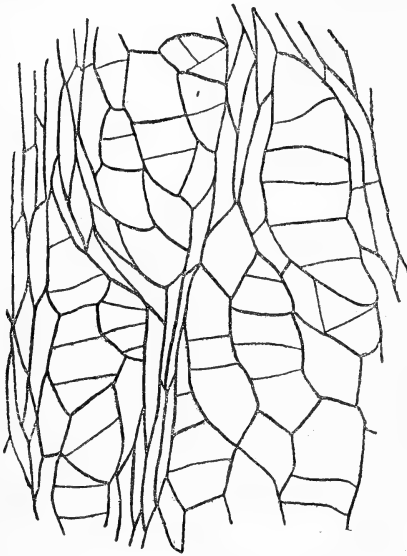

TEXT-FIG. 21. *Stigmaria* sp. (type 2). Tangential section in the periderm showing the wide chambered cells in lenticular groups. Will. Coll., 703.  $\times 30$ .

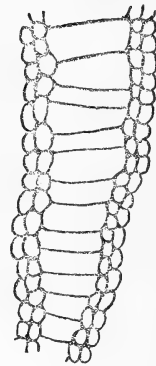

TEXT-FIG. 22. *Lepidodendron brevifolium*. Diagrammatic restoration from a transverse section of a specimen which shows wedges of lighter-coloured extended cells on the outer border of the periderm. U. C. L. Coll., A 50.  $\times 90$ .

In all the types described, heterogeneous periderms therefore arise by the further subdivision of certain of the cells. Whether these cells occur in definite groups or not, and though there may be vertical as well as transverse divisions, the original form of the mother-cell is retained, except in Dictyoxylon types; in the latter the dividing cells have remained quite thin-walled and are capable of further growth, so that the original outline of the periderm cell is lost and the daughter-cells form a parenchymatous tissue, which becomes conspicuous in transverse as well as longitudinal sections.

<sup>1</sup> Zalesky (46), p. 294.



## (8) Features of Mechanical Significance.

The cells of the periderm are generally well preserved and retain their clear outline, even in specimens which have been compressed quite out of their original form. They do not seem to have been easily extensible, and are inclined to break rather than stretch. The thin-walled periderms of *Stigmariæ* seem the least resistant to pressure, while many of the species are specially crushable along certain lines.

The periderm of the stems in its structure and position is well adapted in every way to withstand physical strains, and its obvious mechanical usefulness has been pointed out by Renault, Scott, Seward, and others. 'Architecturally,' to quote Seward, '*Lepidodendron* owed its power of resistance to the bending force of the wind to its stout outer bark formed of thick-walled elements produced by the activity of a cylinder of cortical meristem. The vascular axis, of insignificant diameter in proportion to the size of the stem, must have played a subordinate part, from a mechanical point of view, as compared with the solid mass of wood of a Pine or an Oak.'<sup>1</sup>

Although often irregular in its beginnings, the periderm gradually forms a ring of more or less uniform thickness round the organ. Sometimes it is deflected outwards where it is crossed by the leaf-traces, as in *Lepidodendron Harcourtii* and *fuliginosum*, or it may be sinuous as in *Sigillaria scutellata*, &c., following the outline of the ribs and furrows on the stem. By its position it probably contributed considerably to the support of the large number of evergreen leaves, which were very closely crowded, whether up the stem or at the extremities of the older branches. In *Lepidodendron selaginoides* a few extra layers of periderm are produced under each leaf-base, while in dichotomizing branches, as noticed by Seward,<sup>2</sup> there is often a stronger development of periderm in the fork. There also appears to be more periderm formed under the furrows of ribbed *Sigillariæ*, but this has not been determined with certainty, as the periderm is broken off internally.

## (9) Zonation.

Nearly all the species examined show some sort of zonation of the periderm. In *Dictyoxylon* types, for example, the zoned appearance is said to be due merely to the meshes being formed at more or less regular intervals.<sup>3</sup> The zones are obviously of different kinds in various cases, and furnish another illustration of the difficulties of determining with certainty histological details in fossil-work.

One may conveniently distinguish:

(a) *Colour zones.* Here the whole periderm is divided into two or more bands, caused by differences in colour or in the preservation of the

<sup>1</sup> Seward (28), p. 95.<sup>2</sup> Loc. cit., p. 119, Fig. 152.<sup>3</sup> Renault (19), p. 252.

cells. Such zones have been found in specimens of *Lepidodendron selaginoides*, *Hickii*, *brevifolium*, *Wunschianum*, *fuliginosum*, *Scottii* and sp., *Sigillaria elegans*, *scutellata*, &c.; but, as their occurrence is not at all constant, it is possible that they are to be accounted for by events incidental to penetration and petrification of the tissues. Pl. XXIV, Fig. 3, shows these zones in *Lepidodendron Scottii*, where bands of black carbonized cells alternate with bands in which the structure is still preserved.<sup>1</sup>

(b) *Zones caused by differences in size of the cells.* In *Sigillaria scutellata* and allied species there are fairly continuous zones at rather irregular intervals, caused by a few layers of cells having their tangential walls closer together than the rest of the periderm (Pl. XXIV, Fig. 4). Arber and Thomas considered them definite rings of growth, supporting their suggestion that the phellogen was of a periodic nature.<sup>2</sup> Of the zones described

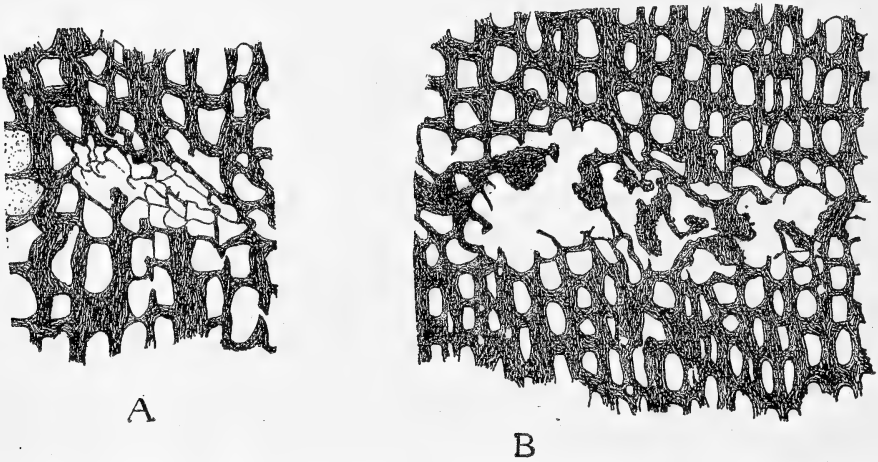

TEXT-FIG. 23. *Lepidodendron selaginoides*. Zones in the periderm. A, zone formed by thin-walled distorted cells. U. C. L. Coll., A 9. B, zone formed by breaking down of cell-walls. U. C. L. Coll., A 0123.  $\times 265$ .

they seem to be the most likely to have been formed at periods of diminished activity. The secondary wood, however, shows no sign of seasonal change, but it is possible that the nearness of the phellogen to the surface would make it more susceptible than the cambium to slight, unfavourable alterations in atmospheric conditions.

(c) *Zones formed by regular or irregular lines of cells which may be crushed or completely disorganized, or which may show signs of recent divisions.* Under this heading have been grouped the various types of zones found in the periderm of *Lepidodendron selaginoides*, *Wunschianum*, *Stigmariae*, &c. In *Lepidodendron selaginoides* they form irregularly concentric but not continuous lines, and consist of a few layers of cells, rather

<sup>1</sup> Gordon (12) suggested that these zones were due to some sort of periodic rest.

<sup>2</sup> Arber and Thomas (1), p. 141.

thin-walled and often crushed and distorted (Text-fig. 23, A), or with the walls broken down so as to produce a series of holes (Text-fig. 23, B). Sometimes one or two of the cells show signs of tangential division. In many sections the zones appear merely as broken, narrow, black bands.

In *Lepidodendron Wunschianum* the zones are much more continuous,

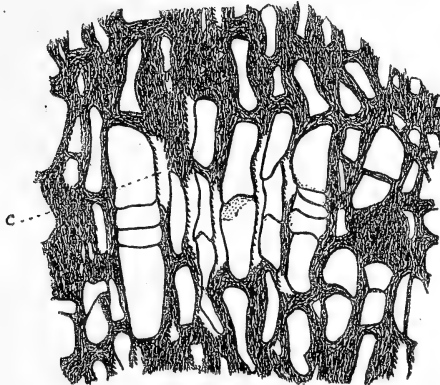

A

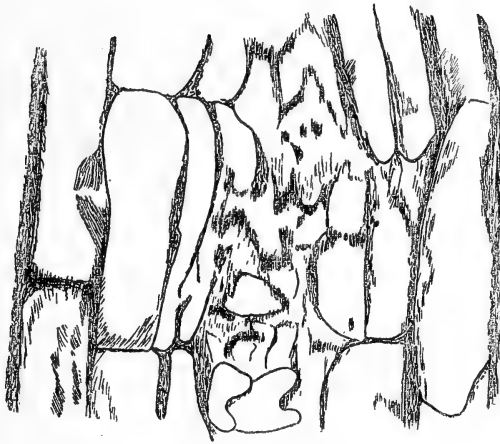

B

TEXT-FIG. 24. *Lepidodendron Wunschianum*. Zones in the periderm. A, transverse section. c, crack. Will. Coll., 452. B, radial section. Will. Coll., 446.  $\times 265$ .

and, owing to the lightness of colour of the cells and their thinner walls, they stand out as concentric white lines in the periderm. Many of the cells appear to have undergone recent division, and some are disorganized or, as is much of the periderm, masked by dark substance (Text-fig. 24). These

zones may also be traced in vertical sections (Text-fig. 24, B); they have been described and figured by Seward and Hill.<sup>1</sup>

In *Stigmariæ* the periderm is sometimes zoned by layers of very much crushed or broken-down cells (Text-fig. 25), and between these zones there are, in a few specimens, darker-coloured groups arranged more or less in rows.

As to the nature of all these zones, Hovelacque regarded them in *Lepidodendron selaginoides* as less resistant layers formed at periods of sluggish growth,<sup>2</sup> but more recently much stress has been laid upon their interpretation as secretory strands. This function was first ascribed to the

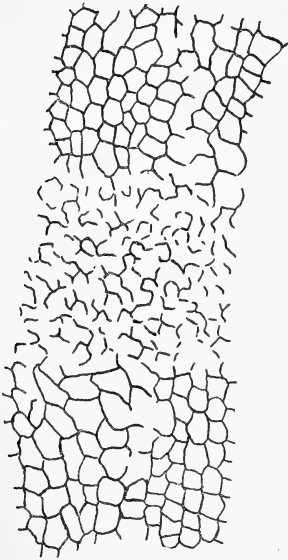

TEXT-FIG. 25. *Stigmaria* sp.  
Zones in the periderm. Will.  
Coll., 766. × 55.

concentric bands of cells in the periderm of *Lepidodendron Wunschianum*,<sup>3</sup> and was then extended to the zones of *Lepidodendron selaginoides*,<sup>4</sup> while it has been suggested that possibly the zones in *Stigmaria*<sup>5</sup> and *Syringodendron esnostense*<sup>6</sup> should be included in the same category. In *Lepidodendron Wunschianum* it is stated that 'at fairly regular intervals groups of the phelloderm cells underwent further division, and constituted definite strands of secretory cells', which, when disorganization is more advanced, consist mainly of 'oval and circular areas, which may be either empty or occupied by portions of thin-walled cells and products of secretion'. They are said to be probably lysigenous in development, and their appearance is compared with that of the resin-canals in the wood of Conifers and in *Copaifera Langsdorffii*.<sup>7</sup>

It should be noted that in the outer primary cortex of several species, including *Lepidodendron Wunschianum*, *Harcourtii*, *fuliginosum*, *Bothrodendron*, and *Xenophyton*, there are groups of cells which have been very generally interpreted as internal glands. It cannot be said, however, that the zones in the periderm show the distinctive character of secretory tissue. Although lysigenous glands in recent plants are surrounded by the remains of dissolved or obliterated cells, and not by an epithelium, yet their distinguishing feature is the formation of a passage, which starts in a single cell and proceeds in the centrifugal direction.<sup>8</sup> But in the zones of these periderms cavities are by no means general, even in the old specimens which

<sup>1</sup> Seward and Hill (29), p. 916, Figs. 2, 3, 12, 18, and 31.

<sup>2</sup> Hovelacque (15), p. 58.

<sup>3</sup> Seward (28), pp. 118, 121.

<sup>4</sup> Seward and Hill (29), p. 925.

<sup>5</sup> Tschirch (31), p. 508.

<sup>6</sup> Seward and Hill (29).

<sup>7</sup> Seward (28), p. 244.

<sup>8</sup> Seward and Hill (29), p. 916.

one may reasonably suppose to have reached full development, while dark substance seems too widely distributed over the sections to give reliable evidence of secreted material. The presence of cells showing signs of recent division is also unusual in secretory tissue, except in quite immature schizogenous glands.<sup>1</sup>

The appearance produced seems on the whole such as might be caused by the formation at intervals of layers or groups of cells with rather thinner walls (sometimes capable of division), which have in consequence been more liable to crushing or to degeneration; somewhat as in the corks of many recent plants, where concentric zones, not always seasonal, are formed by the alternation of wide, thin-walled cells with layers of flatter cells with thicker walls, stone cells, &c.<sup>2</sup>

#### (10) Periderm Development in relation to other Tissues.

The periderm appears early—before the secondary wood, where this is also developed—in all the species examined, except *Lepidodendron brevifolium* and *intermedium*, *Sigillaria scutellata*, *tesselata*, and *spinulosa*, and *Stigmariæ*, in which evidence on this point was lacking. Only two sections, one of which is of *Lepidodendron selaginoides*, show some few layers of secondary wood before periderm formation has extended round the stem (see Text-figs. 1 and 2).

Correlation of the amount of periderm formed, and the amount of secondary wood developed, does not show any apparent connexion between the tissues. The periderm is nearly always as thick as the secondary wood, frequently much thicker,<sup>3</sup> in all the specimens examined which were complete enough to allow of determination; but the periderm of *Lepidodendron selaginoides*, for example, is very much more strongly developed than that in a branch of *Lepidodendron Hickii* of about the same size, and which had no secondary wood. This serves to emphasize that these thick periderms had probably other functions than to compensate mechanically for the feeble development of the vascular system.

In this connexion it is noticeable that in all the fossil Lycopodiales there is a great deficiency of the tissues which generally serve for carbohydrate storage. There may be no definite pith, as in *Lepidodendron selaginoides*, or it is comparatively small, owing to the central concentration of the vascular axis. There is no wood parenchyma, except in the anomalous secondary zone of the type found in *Lepidodendron fuliginosum*. The medullary rays, which are all secondary, are generally very narrow and often contain tracheides.

<sup>1</sup> In this connexion it might be mentioned that the 'glands' in the primary cortex of *Lepidodendron fuliginosum* consist almost entirely of delicate meristematic cells.

<sup>2</sup> de Bary (11), pp. 113-14, &c.

<sup>3</sup> As in *Lepidodendron selaginoides*, *L. Wunschianum*, *Sigillaria scutellata*, &c.

*Lepidodendron selaginoides* is particularly lacking in these tissues, but its periderm is far more conspicuously developed than in *Lepidodendron Hickii* or *L. fuliginosum*. It is conceivable that the large secondary cortex took the place of the defective storage tissue, and that this might account for its striking development in these plants. Such a function would also be consonant with the formation of the great quantity of thin-walled periderm found in the underground Stigmarian rhizomes, where, from their nature and position, the mechanical function must have been of secondary significance. It is also possible that the storage of food reserves was more specially the part of the strongly developed, regular, interior portion of the periderm of certain types, while the less crushable, outer, wide-celled layers had a more mechanical and protective part, and in this connexion were aided by the meristematic properties of the cells of the outer cortex, in the event of rubbing off at the surface, or other vicissitudes to which rhizomes in the soil may be subject.

#### THE EXTERNAL MANIFESTATIONS OF PERIDERM DEVELOPMENT.

##### (1) The Tissues outside the Periderm.

As the periderm was not of the nature of cork, the tissues outside it do not dry up, but remain unchanged by its formation. This may be well seen by comparing a young *Lepidodendroid* stem without periderm with one in which it has attained considerable development. The cells of the leaf-bases and outermost primary cortex present the same appearance in both cases, and occasional divisions continue to take place. In some *Stigmariæ* it has been seen (p. 294) that such divisions are very frequent.

The tissues outside the periderm do not show much sign of tangential stretching, except sometimes in the angles between adjacent leaf-bases, and must be able to keep pace with the growth of the circumference. Among the intact specimens examined, the leaf-bases are still persistent with the following developments of periderm :

<i>Lepidodendron selaginoides</i>	about 200 rows of periderm cells.
" <i>Harcourtii</i>	"    120    "    "
" <i>Hickii</i>	"    20    "    "
" <i>Wunschianum</i>	"    20    "    "
" <i>brevifolium</i>	"    30    "    "
" <i>obovatum</i>	"    50    "    "
" <i>fuliginosum</i>	"    35    "    "
" <i>Scottii</i>	"    60    "    "
"    sp. ( <i>Lepidophloios</i> )	"    50    "    "
<i>Sigillaria scutellata</i>	"    120    "    "
" <i>elegans</i>	"    80    "    "
"    sp.	"    50    "    "

In *Bothrodendron*, *Stigmaria* type 1, and *Stigmaria* type 2 the outer primary cortex is persistent with a development of 10, 40, and 80 rows of periderm cells, respectively.

The lack of cork and the nearness to the surface of a delicate layer like the phellogen may be mentioned as lending support to Seward's suggestion, owing to the absence of annual rings in the wood, that these plants were not exposed to seasonal change but grew under uniform climatic conditions;<sup>1</sup> nor could the conditions have been extreme in character.

## (2) The Outside Sculpture.

It has been seen above that there is no evidence in the fossil Lycopods of the presence of bark, in the sense of dead and dried-up tissues which have been cut off by the production of a zone of cork; but the question still remains whether the leaf-bases, and subsequently the outer layers of the periderm, were thrown off during life as the natural sequence of increase in age and girth of the organ. This has been taken as the normal course of events by many writers. Among others, Hovelacque stated that in *Lepidodendron selaginoides* decortication would take place along the zones in the periderm,<sup>2</sup> and Renault along the zones between the meshes in the Dictyoxylon types,<sup>3</sup> while Williamson spoke of the outer tissues being thrown off in *Lepidodendron Wunschianum*, though not during life in *Stigmaria*.<sup>4</sup> More recently, Seward has described the stretching and gradual obliteration of the leaf-cushions, the production of longitudinal fissures, and later the exfoliation of the outer tissues both in *Lepidodendron* and *Sigillaria*,<sup>5</sup> so that in *Lepidodendron Wunschianum*, for instance, 'the bark presents a fissured appearance like that with which we are familiar on an old Oak or Elm stem.'<sup>6</sup> On the other hand, Potonié commented on there being no formation of bark, as the epidermis is retained and follows the growth in thickness of the stem.<sup>7</sup>

In considering this question it must be remembered that specimens are found showing every stage of decortication with the corresponding differences in external appearance, which originally led to the foundation of the false genera, *Bergeria*, *Aspidiaria*, *Knorria*, &c. The difficulty is to determine how far these specimens represent the condition of the plant during life. Stems with furrowed outer layers have certainly been found,<sup>8</sup> while the great prevalence of detached pieces of periderm, or of periderm and the tissues outside, might be adduced as pointing to some of these having been cast off during life.

<sup>1</sup> Seward (28), p. 269.

<sup>2</sup> Hovelacque (15), p. 158.

<sup>3</sup> Renault (21), p. 176; Renault and Roche (23), p. 8.

<sup>4</sup> Williamson (40), p. 497; (43), p. 26.

<sup>5</sup> Seward (28), pp. 94, 105, 118, &c.

<sup>6</sup> Loc. cit., p. 170.

<sup>7</sup> Potonié (18), pp. 219, 249.

<sup>8</sup> Described by Binney, Dawson, Williamson, Seward, &c.

As far as the present investigation goes, none of the petrifications examined show any sign of longitudinal fissures, except one obviously much mutilated specimen of *Lepidodendron brevifolium*. The oldest example of *Lepidodendron selaginoides* has a periderm two inches thick, which is divided into wedges, as is usual in this species, but the wedges taper inwards towards the centre of the stem; while there are specimens of *Lepidodendron Wunschianum* and of *Stigmariae* with still thicker periderm and no sign of furrows. Again, impressions of great size are found with the

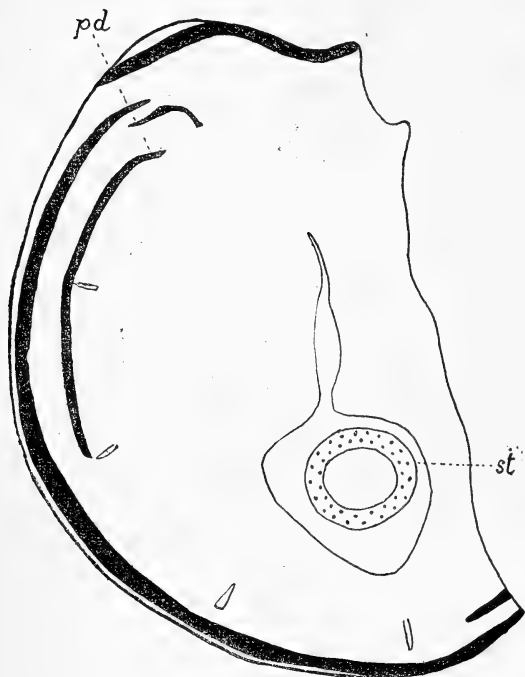

TEXT-FIG. 26. *Lepidodendron fuliginosum*. Diagrammatic transverse section of a specimen showing several narrow bands of periderm. The periderm, *pd*, is shown in black; *st*, stele. Will. Coll., 385.  $\times 2$ .

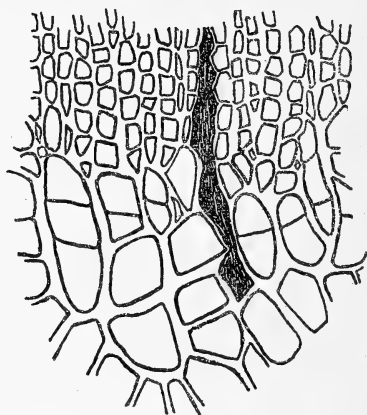

TEXT-FIG. 27. *Lepidodendron fuliginosum*. Transverse section in the periderm showing layers added by division of the cells on the inner margin. U. C. L. Coll., A 32.  $\times 90$ .

leaf-bases still intact and showing no fissuring or distortion, as, for example, a specimen attributed to *L. aculeatum* in the Natural History Museum, with leaf-cushions over two inches long.

There is another difficulty with regard to the exfoliation theory which was touched on by Williamson in his monograph on *Stigmaria*.<sup>1</sup> In *Lepidodendron selaginoides (vasculare)*, for instance, Hovelacque considered the periderm as true cork, but it is now generally recognized that the bulk of the secondary cortical tissue is phelloderm. If 'at a later stage the cushions

<sup>1</sup> Williamson (43), p. 21.



were thrown off, leaving the outer edge of the phelloderm as the superficial tissue,<sup>1</sup> the phellogen layer would disappear in the process, and it is not stated how further development of periderm, if any, continued. The production of a more internal phelloderm would be the obvious solution, but of this there is no mention in any of the old stems of the various species<sup>2</sup> described as having a fissured bark. Nor has any evidence been obtained of the formation of a second periderm in these plants, except in one small and apparently abnormal specimen attributed to *Lepidodendron fuliginosum* (Text-fig. 26). Here periderm formation has started at four different levels. The bands are all narrow and discontinuous, and there is nothing to show that one is developed to replace the other. Scott has also mentioned the formation in places of a second periderm in *Lepidodendron obovatum*,<sup>3</sup> while in one or two species (*Lepidodendron selaginoides* and *fuliginosum*) a few layers may be added to the periderm by division of the cortical cells on the inner margin, but these only form a string of four or five cells (Text-fig. 27).

In the massive corks of recent plants, when the stage of exfoliation has been reached, the cork layer is maintained at a uniform thickness by the internal renewal balancing loss by decortication, but there is no sign of this or any compensating arrangement in the periderm of the Lycopodiales should it also have been cast off during the life of the plant.

In the absence of any provision for the consequences of exfoliation, and also of any physiological reason for the formation of bark and later decortication in the development of a secondary cortex as opposed to cork, the evidence at present obtained may be held to support the remark of Scott that 'when the leaves were shed their bases remained attached to the stem, forming the leaf-cushions, which were persistent, even on the larger trunks'.<sup>4</sup>

#### SUMMARY.

The periderm of the fossil Lycopod attained a great and conspicuous development.

It is of the nature of secondary cortex, and is, for the greater part, morphologically phelloderm.

The cells are prosenchymatous; in certain species some become subdivided into groups of smaller cells, the extreme development of this condition producing the type of tissue known as Dictyoxylon cortex.

Concentric zones may be present in the periderm, due to differences in the nature of certain layers of cells.

The periderm forms a complete and apparently continually increasing cylinder near the periphery of the organ, and seems to have served as the

<sup>1</sup> Seward (28), p. 118.

<sup>2</sup> *Lepidodendron selaginoides*, *L. brevifolium*, *L. Wunschianum*, *Sigillaria*.

<sup>3</sup> Scott (25), p. 318; figured Seward (28), p. 154.

<sup>4</sup> Scott (24), p. 128.

main supporting tissue of the stems, for which it was well qualified by its physical properties.

In addition to its mechanical function it is possible that it acted as reserve storage tissue, for which there is no adequate provision elsewhere than in the cortex.

The periderm, as far as has been ascertained, does not appear to have become the outermost tissue, and is not primarily a protective integument, as is the periderm of recent plants.

The above investigation was undertaken at the suggestion of Professor F. W. Oliver, and I should like to take this opportunity of expressing my thanks to him for all his help and advice, and to Mr. T. G. Hill, who has also given me much kind assistance.

---

#### LITERATURE CITED.

1. ARBER, E. A. N., and THOMAS, H. H. : On the Structure of *Sigillaria scutellata*, Brongn., and other Eusigillarian Stems, in comparison with those of other Palaeozoic Lycopods. Phil. Trans. Roy. Soc., vol. cc B, 1908, p. 133.
2. ————— : A Note on the Structure of the Cortex of *Sigillaria mamillaris*, Brongn. Ann. Bot., vol. xxiii, 1909.
3. BERTRAND, C. E. : Remarques sur le *Lepidodendron Harcourtii* de Witham. Trav. et Mém. Fac. Lille, vol. ii, Mém. 6, 1891.
4. BINNEY, E. W. : On some Plants showing Structure from the Lower Coal Measures of Lancashire. Quart. Journ. Geol. Soc., vol. xviii, 1862, p. 106.
5. ————— : A Description of some Fossil Plants showing Structure, found in the Lower Coal Seams of Lancashire and Yorkshire. Phil. Trans. Roy. Soc., vol. clv, 1865, p. 579.
6. ————— : Observations on the Structure of Fossil Plants found in the Carboniferous Strata. Part iii, *Lepidodendron*. Palaeont. Soc. London, 1872.
7. ————— : Part iv, *Sigillaria* and *Stigmaria*. Ibid. 1875.
8. BRONGNIART, A. : Observations sur la structure intérieure du *Sigillaria elegans*. Arch. Mus. d'Hist. Nat., vol. i, 1839, p. 405.
9. DAWES, J. S. : Remarks upon the Internal Structure of *Halonina*. Quart. Journ. Geol. Soc., vol. iv, 1848, p. 289.
10. DAWSON, J. W. : On the Structure and Affinities of *Sigillaria*, *Calamites*, and *Calamodendron*. Quart. Journ. Geol. Soc., vol. xxvii, 1871, p. 147.
11. DE BARY, A. : Comparative Anatomy of the Phanerogams and Ferns. Oxford, 1884.
12. GORDON, W. T. : On *Lepidophloios Scottii*, a new Species from the Calcareous Sandstone Series at Pettycur, Fife. Trans. Roy. Soc. Edin., vol. xlvi, 1908, p. 443.
13. HABERLANDT, G. : Physiologische Pflanzenanatomie. Leipzig, 1896. Fourth edition, 1909.
14. HICK, T. : On a new Fossil Plant from the Lower Coal Measures. Journ. Linn. Soc. Bot., vol. xxix, 1893, p. 86.
15. HOVELACQUE, M. : Recherches sur le *Lepidodendron selaginoides*, Sternb. Mém. Soc. Linn. Normandie, vol. xvii, 1892, p. 5.
16. LIGNIER, O. : *Radiculites reticulatus*, radicle fossile de Sequoïnée. Bull. Soc. Bot. France, vol. vi, sér. 4, 1906, p. 193.
17. LINDLEY, J., and HUTTON, W. : The Fossil Flora of Great Britain, vol. ii. London, 1833-5.

18. POTONIÉ, H. : Lehrbuch der Pflanzenpalaeontologie. Berlin, 1899.
19. RENAULT, B. : Structure comparée de quelques tiges de la Flore Carbonifère. Nouv. Arch. Mus. d'Hist. Nat. Paris, vol. ii, sér. 2, 1879, p. 213.
20. ————— : Cours de Botanique fossile, vol. i. Paris, 1880.
21. ————— : Bassin Houiller et Permien d'Autun et d'Épinac, Flore Fossile, Part ii. Texte 1896, Atlas 1893.
22. RENAULT, B., and GRAND'EURY, C. : Étude du *Sigillaria spinulosa*. Mém. prés. par div. sav. à l'Acad. des Sciences, vol. xxii, 1875.
23. RENAULT, B., and ROCHE, A. : Sur une nouvelle Diploxylée. Bull. Soc. d'Hist. Nat. d'Autun, vol. xi, 1897.
24. SCOTT, D. H. : Studies in Fossil Botany. London, 1900. Second edition, vol. i, 1908.
25. ————— : The Structure of *Lepidodendron obovatum*, Sternb. Ann. Bot., vol. xx, 1906.
26. SEWARD, A. C. : Notes on the Binney Collection of Coal-Measure Plants. Part i, *Lepidophloios*. Proc. Phil. Soc. Cambridge, vol. x, 1899, p. 137.
27. ————— : The Anatomy of *Lepidodendron aculeatum*, Sternb. Ann. Bot., vol. xx, 1906.
28. ————— : Fossil Plants, vol. ii. Cambridge, 1910.
29. SEWARD, A. C., and HILL, A. W. : On the Structure and Affinities of a Lepidodendroid Stem from the Calciferous Sandstone of Dalmeny, Scotland, possibly identical with *Lepidophloios Harcourtii*, Witham. Trans. Roy. Soc. Edin., vol. xxxix, Part iv, 1900, p. 907.
30. SOLMS-LAUBACH, GRAF H. ZU : Fossil Botany. English edition, Oxford, 1891.
31. TSCHIRCH, A. : Angewandte Pflanzenanatomie. Leipzig, 1889.
32. WATSON, D. M. S. : On a Confusion of Two Species under *Lepidodendron Harcourtii*, Witham, in Williamson's nineteenth Memoir, with a Description of *L. Hickii*, sp. nov. Mem. Proc. Manchester Lit. Phil. Soc., vol. li, Part iii, 1907.
33. WEISS, F. E. : A Biseriate Halonial Branch of *Lepidophloios fuliginosus*. Trans. Linn. Soc. Bot., ser. 2, vol. vi, 1903.
34. ————— : A Probable Parasite of Stigmarian Rootlets. New. Phyt., vol. iii, 1904.
35. ————— : The Parichnos in the Lepidodendraceae. Mem. Proc. Manchester Lit. Phil. Soc., vol. li, Part ii, 1907.
36. ————— : A *Stigmaria* with Centripetal Wood. Ann. Bot., vol. xxii, 1908.
37. WILLIAMSON, W. C. : On the Organization of the Fossil Plants of the Coal Measures, Part ii. Phil. Trans. Roy. Soc., vol. clxii, 1872, p. 197.
38. ————— : Ibid., Part iii. Ibid., vol. clxii, 1872, p. 283.
39. ————— : Ibid., Part ix. Ibid., vol. clxix, 1878, p. 319.
40. ————— : Ibid., Part x. Ibid., vol. clxxi, 1880, p. 493.
41. ————— : Ibid., Part xi. Ibid., vol. clxxii, 1881, p. 283.
42. ————— : Ibid., Part xix. Ibid., vol. clxxxiv B, 1893, p. 1.
43. ————— : A Monograph on the Morphology and Histology of *Stigmaria ficoides*. Palaeont. Soc., London, 1887.
44. ————— : On the Light thrown upon the Question of the Growth and Development of the Carboniferous Arborescent Lepidodendra by a Study of the Details of their Organization. Mem. Proc. Manchester Lit. Phil. Soc., ser. 4, vol. ix, 1895.
45. WITHAM, H. : The Internal Structure of Fossil Vegetables found in the Carboniferous and Oolitic Deposits of Great Britain. Edinburgh, 1833.
46. ZALESSKY, M. D. : On the Internal Structure of the Stem of the Type of *Lepidodendron aculeatum*, Sternb., and *Sigillaria Boblayi*, Brongn. Mem. Imp. Russian Min. Soc., vol. xlvi, Part ii, p. 273, 1909.
47. ————— : Structure du rameau de *Lepidodendron obovatum*, Sternb., et Note préliminaire sur le *Caenoxylon Scotti*, nov. gen. et sp. Études paléobotaniques, Part i, St. Petersburg, 1911.

## EXPLANATION OF PLATE XXIV.

Illustrating Miss Kisch's paper on the Periderm of Fossil Lycopodiales.

(Photographs by Mr. F. Pittock, Zoological Department, University College.)

Fig. 1. Transverse section of the periderm of *Stigmaria*, type 1, showing the delicate cells on the inner margin, and at *x* a cell which has just divided. The short files in the periderm are well seen, and the primary cortex on both sides is preserved. U. C. L. Coll., D 8. × 45.

Fig. 2. Transverse section of the periderm of *Stigmaria*, type 2, showing the irregular, wide-celled outer portion, *a*, the smaller-celled internal portion, *b*, which is broken off towards the interior, the supposed line of the phellogen, *ph*, and the divisions in the cells of the outer cortex as at *c*. U. C. L. Coll., D 8. × 45.

Fig. 3. Colour zones in the periderm of *Lepidodendron Scottii* caused by differences in the preservation of the cells. U. C. L. Coll., A 41. × 35.

Fig. 4. Zones in the periderm of *Sigillaria scutellata* caused by the smaller size of a few layers of cells. U. C. L. Coll., B 11. × 35.

In all cases the peripheral edge of the section is placed uppermost on the plate.



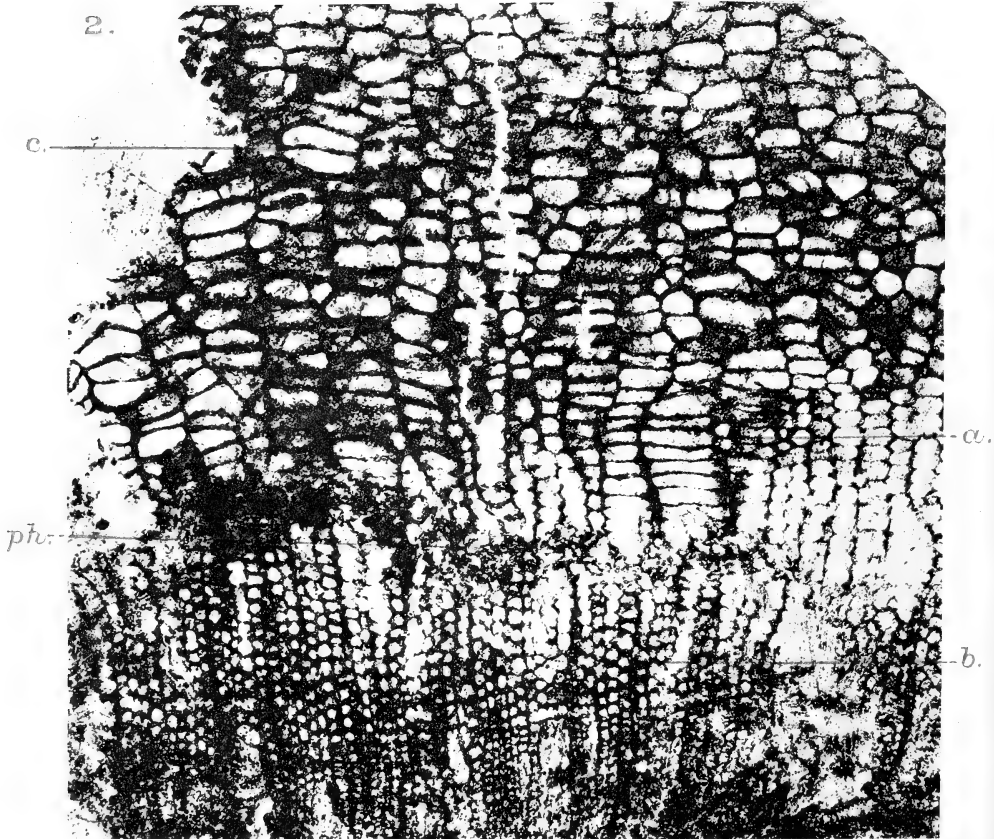
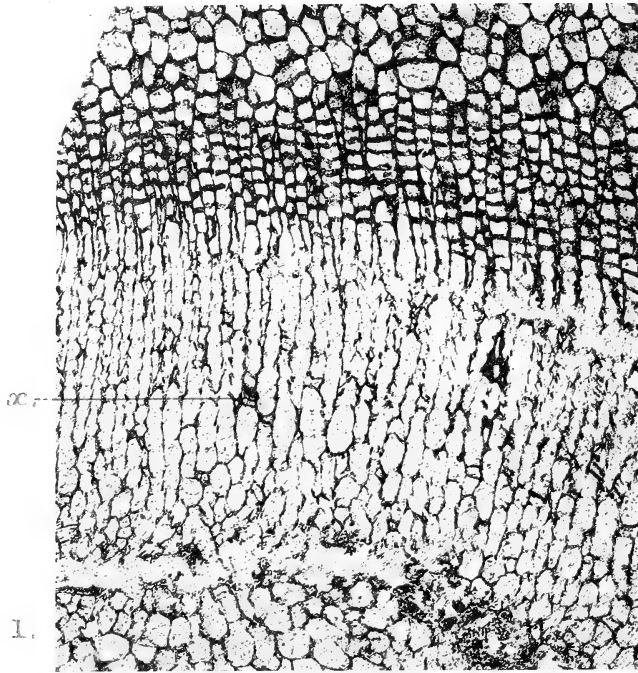

KISCH—PERIDERM OF FOSSIL LYCOPODIALES.



3.

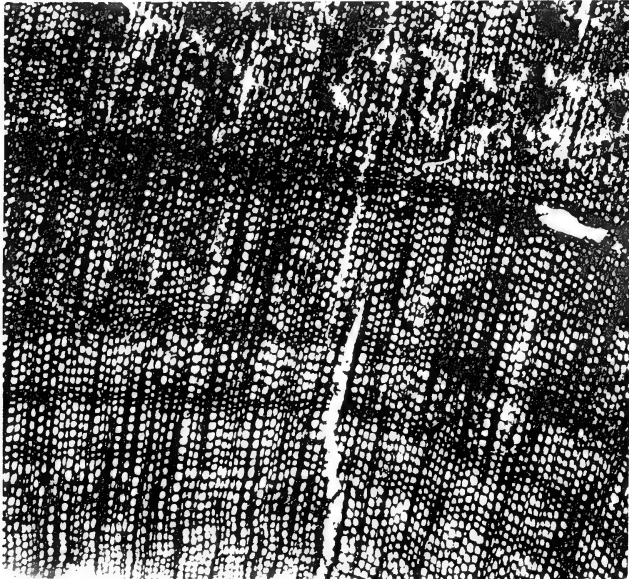

4.





# Contributions to the Life-history of *Actinostrobus pyramidalis*, Miq.

BY

W. T. SAXTON, M.A., F.L.S.

*Lecturer in Botany at the South African College, Cape Town.*

With Plates **XXV-XXVIII** and three Figures in the Text.

THE genus *Actinostrobus*, Miq., consists of two species of small trees or shrubs confined to Western Australia. *Actinostrobus pyramidalis* is fairly common in the neighbourhood of Perth, but *Actinostrobus acuminatus*, Parlat., is less easily accessible, though locally common on the sand plains between the Moore and Murchison Rivers. It has not been possible to secure fixed material of the last-named species, but from a study of herbarium specimens it is evident that it is very closely related to *A. pyramidalis* and would be extremely unlikely to show structural differences of much importance.

The present study is a continuation of the series of investigations on the structure and development of the Callitricheae, accounts of *Widdringtonia* and *Callitris* having been already published (19, 20, 21). A very small amount of the material for this investigation was collected in January and February, 1910, from a small tree in the temperate house, Kew Gardens, and for facilities in connexion with these collections thanks are due to Mr. Boodle, Keeper of the Jodrell Laboratory, Kew.

By far the larger number of collections were, however, made for me, and I am glad to take this opportunity of thanking very heartily Dr. A. Morrison, late Government Botanist in Western Australia, for the great trouble he has taken in securing and fixing material for me in all stages of development. He has also placed at my disposal some excellent dried specimens of both species of the genus, and has given me interesting information in regard to the time of pollination, &c., which has formed the basis of the 'field notes' below. Without his assistance the greater part of this study would have been impossible. Thanks are also due to Mr. Stiles, who handed over to me some material collected by him at Kew and Cambridge Botanic Gardens with a view to working on the genus. This material, however, as well as that collected by myself, did not yield anything except quite early stages, as, although pollen is plentiful, all female cones on the plants growing there become abortive.

## FIELD NOTES, &amp;C.

The plants of *Actinostrobus pyramidalis* growing in the neighbourhood of Perth are seldom above 10 feet high, and have a very similar habit to small trees of *Callitris*. The persistence of the old cones is a characteristic feature; Dr. Morrison informs me that they remain attached to the stems for several years before shedding their seeds, on the main stem and two or three grades of branches.

It seems probable that female cones, and perhaps a few male cones, may make their appearance at various seasons of the year, but the normal crop of young cones appears about May or June. Pollination takes place from June to August, the pollen being shed from one tree after another, in an apparently gradual succession. From the development of the ovules, however, it seems fairly certain that effective pollination only occurs about the first half of July. Dr. Morrison records the very interesting observation that a drop of fluid may be seen extruded from the open micropyle of the young ovules, in which doubtless the pollen-grains are caught and subsequently withdrawn on to the nucellus. Of the various devices facilitating pollination in Conifers, this would appear from the rather scanty records to be the commonest. The pollination drop has also recently been observed by the writer in *Widdringtonia*. In *Callitris*, ovules young enough to be likely to show this phenomenon have not at present been seen.

Approximately three months elapse between pollination and fertilization, the latter occurring about the second week in October. Fertilization is not so nearly simultaneous in different ovules as it is in *Pinus* and some other genera, but probably does not vary more than about a week, on either side of the average. It is interesting to note that although the winter seasons of 1910 and 1911 were very different, especially as regards rainfall, the average date of fertilization did not differ appreciably, collections covering that event having been made on October 12, 1910, and October 9, 1911.

Unlike some Conifers, in which the cones are often almost full grown at the time of fertilization, *Actinostrobus* cones are only about two-thirds of their mature size at that time. They attain their full size about a month later, when they can only be distinguished from previous years' cones by their green colour.

The female cones are terminal on very short branchlets, these being borne in the axils of foliage leaves near the base of a young branch. At the time when pollination takes place the cone scales are not widely spreading as they are in other Callitrineae, but are evidently prevented from diverging by the closely appressed barren scales of the cone. After pollination the fertile scales rapidly increase in size, and grow together over the top of the cone in the manner recently described for *Callitris* by Baker and

Smith (1). Owing, however, to the fact that the tips of the fertile scales are only slightly divergent, the second (inner) 'apex' is far less conspicuous than in *Callitris*, the original morphological apex being on a level with it, and more or less hiding it in an external view of the cone.

A median longitudinal section of a cone scale in a three-quarter grown cone is shown in outline in Text-fig. 1, indicating the points noted above, and also showing the course of the vascular bundles, and the position of a resin sac. In the Callitrineae the two distinct apices of the mature cone scales cannot be regarded as any evidence of the double nature of those structures; in the young scale only one apex is present, the second being produced, as shown by Baker and Smith (loc. cit.), simply by the bulging inwards and upwards, with mutual pressure, of the inner faces of the fertile scales. Since the authors quoted have carefully described and figured the process, it is not necessary to discuss it further. The two sets of vascular strands are present as usual, as shown in the figure.

Each cone terminates in a central columella, which, as in *Callitris*, contains a large resin cavity. The seeds are usually three-winged.

The male cones are 5-6 mm. in length, or sometimes less, when mature, and are found in the axils of foliage leaves, 6-10 occurring on one branchlet. The sporophylls are in six vertical rows, made up of about nine alternating whorls of three in the larger cones. The sporophylls are regularly peltate, like those of

*Widdringtonia* and *Callitris*, the peltate expansion having a brown margin, and the stalk bears usually three sporangia on its proximal side. The axis elongates rapidly at the time of dehiscence of the sporangia, as in many other Conifers, separating the sporophylls, and the sporangia open irregularly.

The plants are monoecious, like other Callitrineae.

#### LABORATORY INVESTIGATION.

The methods used in this investigation have been substantially the same as those employed in the study of *Callitris*. The fixing-agent employed for almost all the collections was the following:

Picric acid (saturated solution in 50 per cent. alcohol)	. 100 c.c.
Mercuric chloride (corrosive sublimate)	. . . . . 5 grammes.
Acetic acid (glacial)	. . . . . 5 c.c.

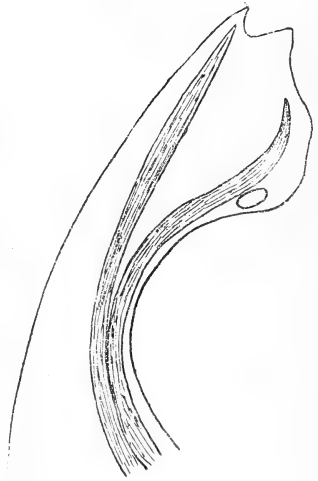

TEXT-FIG. 1. Longitudinal section of the upper part of a nearly mature cone scale.  $\times 9$ .

All material for microtome sectioning was embedded through cedar-wood oil, and in the later material it was found possible, with frequent changes of paraffin, to reduce the period in the oven to about four hours.

All microtome sections were cut with a Cambridge rocking microtome to a thickness of about  $7\mu$ , and stained with either Delafield's haematoxylin or (usually) Fleming's triple stain. All drawings were made from such sections except Text-fig. 1, and Pl. XXV, Figs. 17, 18, and 19, which are from hand sections, and all were made with the camera lucida.

#### 1. MICROSPORANGIUM AND MICROSPORES.

The position of the three sporangia on the stalk of the sporophyll is indicated in Pl. XXV, Fig. 1. The structure of the sporangium is exactly like that of *Callitris*. The wall, when mature, consists of a single layer of rather large and somewhat thick-walled cells, but in younger stages two layers of thin-walled cells are met with between the epidermis and the sporogenous tissue. The origin of these cells has not been determined, but the two layers are evidently derived from a single layer by periclinal divisions, and are probably morphologically part of the sporogenous tissue. The close resemblance in the stages that have been seen to the corresponding stages in *Funiperus*, as described recently by Nichols (17), makes it highly probable that the course of development is very similar; in *Funiperus* the two layers of thin-walled cells to which reference has been made are clearly shown to be derived from the sporogenous tissue.

Functionally they represent at least a part, and probably the whole, of the tapetum.

Unfortunately, my material only includes quite young, and mature or nearly mature, male cones, so that stages to illustrate sporogenesis have been missed.<sup>1</sup> The mature pollen-grain (Fig. 2) is exactly like that of *Widdringtonia* and *Callitris*, and is uninucleate at the time of pollination, the nucleus being surrounded by a layer of rather large starch grains. As seen in section, the exine is thin and the intine rather thick; it is very probable, however, that in the fresh state the real thickness of the intine is considerably less than appears in sections of fixed material. Observations on fresh pollen of related Conifers have indicated the difficulty of preventing considerable swelling of the intine in fixing material; possibly the difficulty might be overcome with special technique.

#### 2. THE FEMALE CONE AND THE OVULE.

Text-fig. 2 is a transverse section across a young cone, passing through the base of the ovules. The close resemblance of sterile and fertile scales, when young, is apparent, the innermost whorl bearing generally two ovules

<sup>1</sup> Since the above was written I have obtained late stages of spore-formation from cones procured from Kew through the kindness of Mr. L. A. Boodle. These have shown that the tetrad of spores is formed in a mother-cell which, unlike that of *Pinus*, does not become partitioned.

to each scale, the scales of the next whorl one ovule each, and all the outer whorls being completely sterile. There is, however, considerable variation in the number of ovules borne in a healthy cone, the minimum and maximum being about six and about twelve respectively.

The young ovule, about the time of pollination (Fig. 3), shows a long and widely open micropyle, and a nucellus free from the integument nearly to the base of the ovule. The integument is rather thick, and the cells which, at a later stage, close the micropyle are clearly defined on its inner surface, these having somewhat denser contents and more conspicuous nuclei than the other cells.

Very soon after this, a single cell near the base of the nucellus becomes differentiated from its neighbours. It is distinguished by a larger and less deeply staining nucleus and denser cytoplasm (Fig. 4). As far as has been seen, never more than one such cell is formed, and it becomes at once the megaspore mother-cell. This agrees closely with the corresponding stage in *Callitris*, where often only one megaspore mother-cell is formed; in that genus, however, two or three may be sometimes organized, this being probably co-ordinated with the occasional development of two or three embryo-sacs. In *Actinostrobus* there is a complete absence, as in *Callitris*, of any tissue specially differentiated as a tapetum. It seems clear, in spite of differences of opinion on the subject, that the so-called 'spongy tissue' of many Conifers is nothing more nor less than the sporogenous tissue of the megasporangium, generally, if not always, in the mother-cell stage. The

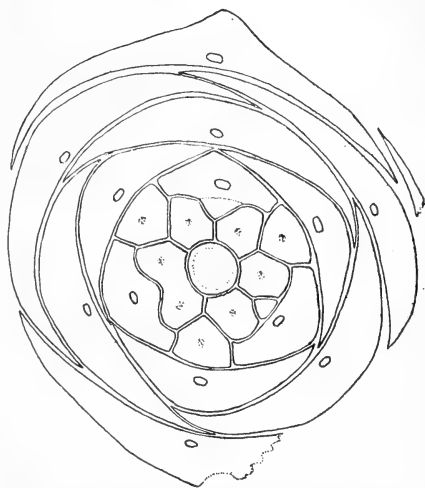

TEXT-FIG. 2. Transverse section across a young female cone.  $\times 25$ .

case of *Widdringtonia* and *Tetraclinis* (figured as *Callitris quadrivalvis* by Goebel (9)), where the sporogenous cells are absolutely alike until quite shortly before the division of the functional mother-cell, scarcely leaves room for doubt on this point. Bower (2), with special reference to the Cryptogams, has shown how largely sterilization of potentially sporogenous tissue has been responsible for differentiation and advance in the plant kingdom, and the conception of the spongy tissue of Conifers as potentially sporogenous not only co-ordinates more clearly the megasporangium and microsporangium, but also indicates better the undoubted connexion between the gymnosperm ovule and the megasporangium of the higher Cryptogams, where the sterilization of sporogenous tissue is a still more conspicuous

feature. In *Callitris* and *Actinostrobus* we have clearly an advance from the condition found in *Widdringtonia*, in the fact that sterilization occurs before any differentiation of sporogenous tissue is visible. This is, of course, only theoretical, as there is no means of distinguishing sporogenous tissue until it becomes microscopically visible.

At a slightly later stage than that described above, the mother-cell nucleus is found in synapsis (Fig. 5). At this time the cell has elongated somewhat and its wall has thickened considerably.

Further stages to illustrate the reduction divisions have unfortunately been missed, but Fig. 6, which shows a uninucleate megaspore, indicates that probably three cells, or at least three nuclei, are formed by the divisions of the mother-cell; but this cannot be stated with any certainty. In any case, the other megaspores very rapidly disorganize, and after one or two divisions in the functional megaspore can no longer be distinguished. The presence of a number of starch grains in the uninucleate megaspore is noteworthy, as they are not found either just before or just after this stage.

### 3. THE FEMALE GAMETOPHYTE.

Fig. 7, of a binucleate megaspore, shows that vacuolation only occurs between this and the eight-nucleate stage. The latter is shown in Fig. 8, which is a drawing of a whole ovule, serving also to illustrate the general structure of an ovule at this time as compared with the stage shown in Fig. 3.<sup>1</sup> The micropyle is now closed, the micropyle-closing cells appearing septate in the figure, due to their growing in a slightly different plane to that of the section. They are actually, however, usually, if not always, non-septate, as may be seen in transverse sections of the micropyle at the same stage. The transverse section closely resembles that of the micropyle of *Widdringtonia*, and has not been figured.

The upper part of the nucellus consists at this time of cells with thick walls and dense contents. These cells never divide and appear to be dead or dying, and the pollen-tubes do not now extend below this tissue, which is sharply differentiated from the meristematic tissue below it. The young embryo-sac lies a good deal nearer the base of the nucellus than is the case in *Callitris*, but is not so deeply placed as in *Widdringtonia*. The cells below the embryo-sac are in somewhat regular longitudinal rows, with dense contents, but are not quite so distinctly differentiated in this respect as are those of *Callitris*.

The early divisions of the nuclei, which lie in the lining layer of protoplasm in the embryo-sac, are simultaneous, but whether this applies to the later divisions has not been determined.

Cell formation is similar to that in *Widdringtonia*, alveoli being

<sup>1</sup> Fig. 3 and Fig. 8 are not, however, drawn to the same scale.

organized, each of which, before reaching very far towards the centre of the sac, cuts off a small cell at its base. The form of these small cells is clearly seen in Fig. 9. The alveoli are otherwise quite unsegmented, the apparent transverse walls appearing in the figure in some places, especially on the right, being due to other alveoli passing into the plane of the section. On reaching the centre of the prothallus, each alveolus is terminated by a wall, stages shortly after that represented in Fig. 9 showing, occasionally, the two end walls of opposite alveoli in contact. Apparently, however, they soon fuse together, as only a single wall can be distinguished later.

The apex of the prothallus is narrow and pointed, not truncate or rounded as in most Conifers.

The long inner cells of the alveoli in the upper half of the prothallus, except in the narrow part near the apex, are those from which, after cutting off some small cells at one or both ends, the archegonium initials are formed. Thus the archegonium initials are the largest cells in the prothallus at the time when they can first be distinguished, not amongst the smallest, as is often the case.

It appears as though every alveolus in the upper half of the prothallus, with the exception of the narrow apex, gives rise in this way to a cell which is of the nature of an archegonium initial, and in cases where no pollen-tubes have grown down the prothallus, these initials remain for some time unsegmented and are rather conspicuous, but where one or more normal pollen-tubes have grown down, only the initials in contact with the pollen-tube become functional archegonia, all the rest becoming transversely divided into several cells. This is indicated in the transverse section of a prothallus shown in Fig. 10. Since, however, the pollen-tubes are already in position when cell formation takes place, it is likely that some modification of the method just described must occur in the case of functional archegonium initials. Exactly what this modification may be has not been determined, but enough has been seen to make it clear that the initials always arise in a similar manner to that just described.

In a former paper (19) it was stated that in *Widdringtonia* the distribution of archegonia is determined largely by the position of the pollen-tube. It was subsequently shown, however, in *Callitris* (21) that archegonium initials might appear in an exactly similar position, in the absence of a pollen-tube in the prothallus.

The present study makes the position more clear, and as the point is of some importance, the degree of correlation between pollen-tube, archegonia, and archegonium initials may be briefly recapitulated as follows: The formation of archegonium initials in their normal position, laterally and deep-seated in the prothallus, is not determined by the position of the pollen-tube, but this position does determine which of the very numerous archegonium initials become functional archegonia.

Coulter (4), in a paper reprinted in Coulter and Chamberlain's 'Morphology of Gymnosperms' (5), makes the following statement: 'In cases where the pollen-tube assumes a lateral position in reference to the gametophyte (as in *Sequoia* and *Widdringtonia*), it has been demonstrated that the latter responds by the selection of numerous deep-seated and laterally placed archegonium initials.' I am not prepared to say whether, in point of fact, the prothallus of *Widdringtonia* does, or does not, behave in the way described, but I am not aware of any published work on the genus which justifies a statement that it does behave in this manner. What has been stated, and it applies equally to *Callitris* and *Actinostrobus*, is that archegonia (that is, fully formed archegonia, capable of further development when fertilized) are organized only in relation to pollen-tubes.<sup>1</sup> In another place Coulter and Chamberlain (5) remark, in connexion with *Widdringtonia* and *Callitris*, 'This position (i. e. of the pollen-tube) seems to determine the selection of archegonium initials, which begin to appear in groups beneath the surface.' This is an equally misleading statement.

Considerable stress has been laid on this point, since it must be emphasized that in *Actinostrobus* and *Callitris*, and doubtless also in *Widdringtonia*, though not proved in that genus, the position of the archegonium initials is a definite character of the female gametophyte, and not merely one correlated with the position of the pollen-tube. Coulter (4), in the paper cited above, apparently also correlates the 'micropylar' position of archegonia in most Conifers with the 'micropylar' position of the tip of the pollen-tube; it is, however, difficult to believe that the selection of archegonium initials in *Pinus* (to take a definite example) is influenced by the position of a pollen-tube which has only penetrated a short distance down the nucellus, and is still separated by a thick mass of nucellar tissue from the apex of the prothallus. Moreover, occasional abnormal prothalli of *Pinus* show laterally placed archegonia, without any evidence of a correspondingly placed pollen-tube, while sometimes a pollen-tube takes a very irregular course and enters an archegonium from the side.

The young archegonium of *Actinostrobus* has a very inconspicuous neck of two cells (Figs. 10, 11, 12), and a small nucleus which lies just below the neck. The evidence in regard to the cutting off of a ventral canal nucleus is very meagre. Three cases are figured (Figs. 13, 14, and 33), of which the second and third are almost certainly (the third certainly) abnormal, and the first quite possibly so. Figs. 13 and 14 are from the same prothallus as the abnormal pollen-tube of Fig. 32; and 13 is an

<sup>1</sup> The fact that there was some doubt whether all the archegonia in *Widdringtonia* had undergone any divisions after the 'initial' stage does not invalidate this statement. I have a preparation of *Sequoia*, also, which shows a lateral archegonium in a prothallus where no pollen-tube can be found.



isolated example of an archeogonium showing two nuclei in the normal positions of oosphere and ventral canal nuclei, respectively. Nearly all the other archeogonia of this prothallus have the structure shown in Fig. 14. This shows apparently a late stage of a division which might be interpreted as that cutting off the ventral canal nucleus, but it has certain peculiarities not characteristic of that division. In the first place, the number of chromosomes at each pole appears to be less in every case than the normal reduced number (eight); secondly, the upper group of chromosomes is very much smaller than the lower in every case, and seems to consist of only one or two chromosomes. The most reasonable interpretation seems to be that the whole ovule is an abnormal one, and that, instead of forming a normal ventral nucleus, the chromosomes of the central nucleus have separated out and discharged one or two of their number from the rest, which have then remained as chromosomes instead of becoming reorganized into a nucleus. If this explanation is more or less correct, it is evident that the occurrence of an apparently normally organized ventral nucleus in a neighbouring archeogonium can scarcely be regarded as good evidence that such a body is formed in normal prothalli. The third case is that of an archeogonium in which fertilization has already taken place, but which contains what can only be regarded as a ventral canal cell. If such a cell were normally organized, or if (as would be far more probable) a nucleus were formed which persisted for even a few hours, it is reasonably certain that it could not have been missed in normal preparations. A difference in the structure, size, and position of the archeogonium nucleus is, however, apparent between the stages shown in Figs. 10 and 12. This is interpreted as being due to the cutting off, between the two stages, of an ephemeral ventral canal nucleus, which completely and very rapidly disorganizes. Were it not, however, for parallel evidence in a related genus (*Widdringtonia*), one would be much more inclined to come to the conclusion that no ventral nucleus is normally cut off, as is said to be probably the case in *Torreya taxifolia* (6).<sup>1</sup> It is also worth noting that no ventral nucleus was identified in *Callitris*, which is much more nearly related to *Actinostrobus* than is *Widdringtonia*. The series obtained in *Callitris* was not, however, such a close one as that in *Actinostrobus*. A possible explanation, which is very frequently overlooked by investigators, of the persistent absence of a certain stage in a particular plant, is that the stage concerned only occurs at certain hours of the day or night, at which collections were not made.<sup>2</sup> In a recent paper by Lutman (15) on *Closterium*, it was shown that nuclear and cell division in that genus always occurred at night. I am not aware

<sup>1</sup> The case of *Torreya taxifolia*, however, is emphatically 'not proven'.

<sup>2</sup> Since the above was written I see that Burlingame, working on *Araucaria* (Bot. Gaz., Feb., 1913, p. 99), suggests a similar explanation of the difficulty experienced in securing certain stages of development.

whether any investigator of Conifer morphology has ever tested the value of collections made during the night, but it is undeniable that certain stages are repeatedly met with in day collections, while others are extremely rare. The current explanation, that the rare stages are those passed through very quickly, is no doubt true in some cases, but where a single collection includes an approximately equal number of stages before and after the one looked for, which still is persistently absent, it is not unreasonable to infer that it may only occur at a certain time of the day or night other than that at which the collection was made, or at least far more frequently at such a time.

The mature archegonia are always found (in normal prothalli) in lateral groups of about twenty-five to thirty, abutting on the lower part of a pollen-tube, one such group being formed in relation to each pollen-tube. It is not always quite clear whether the pollen-tube is actually within the tissue of the prothallus, but it is certainly so in many cases, and where not apparent may be due to the crushing of the outer cells. Thus it is probable that archegonia are always deep-seated, and certain that they usually are. Part of a tangential section of a prothallus cutting a single group of archegonia transversely is shown in Fig. 15. The microphotograph reproduced in Pl. XXVIII, Fig. 53 shows a similar section.

The archegonia which may be eventually found in prothalli in which no normal pollen-tubes occur, vary a good deal, but a typical case is shown in Fig. 16, the cells in which contents are drawn being quite sharply differentiated from the rest.

Some other points in connexion with the older ovule and prothallus may now be mentioned, although some are only to be observed subsequently to fertilization.

Alternating with the three wings of the integument are found three large secretory cavities in the tissue, which may be about 3 mm. long, 1 mm. wide, and 0.1 mm. thick. Their position in transverse section is indicated in Fig. 17, and one of them is drawn on a larger scale in Fig. 18. It is very probable that resin is secreted in these cavities, but having only fixed material at my disposal, which has been repeatedly washed in alcohol, it has not been possible to determine this point. It is seen in Fig. 17, and more clearly in Fig. 19, that the nucellus has also three quite rudimentary wings, corresponding in position to those of the integument. The outline of the prothallus in cross-section may be sub-triangular (Fig. 19), almost circular (Fig. 17), or somewhat elliptical (Fig. 16).

The megaspore membrane is, from the first, very thin and inconspicuous, but thickens somewhat in a quite old prothallus. Its thickness when a good-sized embryo has been formed is indicated in Fig. 20, which also shows two of the marginal starch-packed cells. Two cells near the margin, one uninucleate the other binucleate, are shown in Fig. 21. Practically all

the cells near the middle of the prothallus, and especially those near the advancing embryo, become binucleate or four-nucleate. One such four-nucleate cell is drawn in Fig. 22. A dividing nucleus in a prothallus cell is shown in Fig. 23. The chromosomes are very thick, and it is not possible to show more than about half of them in a drawing. The number passing to each pole is eight. A single dividing nucleus in a prothallus cell is quite commonly met with, but only one case has been seen of two dividing nuclei side by side in the same cell. This, however, serves to establish the fact that the four-nucleate cells are derived from the binucleate by simultaneous mitosis of the two nuclei.

The binucleate and four-nucleate cells are exactly like those of *Widdringtonia* and *Callitris*, and it is here necessary to correct a completely inaccurate statement made by Coulter and Chamberlain (5) in reference to this point. They state (p. 262), 'Saxton has observed the same free nuclear division in the primary endosperm cells of *Widdringtonia*' (primary cells are defined on the same page as 'those open towards the centre of the sac'—i. e. the alveoli), 'but in this case the cells usually become only binucleate (occasionally multinucleate), and this binucleate or multinucleate condition persists in the permanent tissue, as if the last stage of other forms were omitted in *Widdringtonia*.' Without further comment, I add the following extracts from my own statements in the two papers cited by Coulter and Chamberlain in this connexion: 'A large number of nuclear divisions have been seen in the "alveoli", certain features of which strongly recall the peculiar divisions described by Lawson as occurring at this time in *Cryptomeria*. The wall between the nuclei, however, is always developed, but in cases where its width does not nearly equal the diameter of the cell, it is just possible that wall and fibres may disappear again, and thus give rise to a binucleate cell. It has not been demonstrated, however, that binucleate cells ever originate in this way' (20, p. 35). 'The cells at first formed are invariably uninucleate . . .' (19, p. 167). 'It seems perfectly clear . . . that the binucleate (and in some cells multinucleate) condition arises by karyokinetic division of the original single nucleus' (19, p. 170).

This bi- and multinucleate condition of older prothallial cells is more widely distributed in the Pinaceae than the literature of the subject would indicate. They are also known to occur in the Taxaceae, having been recorded in *Podocarpus* (Coker (3) and Gibbs (8)), and *Taxus* (Jaeger (11)). In *Cephalotaxus* also, the writer has had the privilege of examining some excellent preparations made by Mr. L. A. Boodle, in which several free nuclear divisions may be seen in a single cell of the prothallus.

From the writer's preparations of other Conifers, and published records, the following facts have been noted: In *Araucaria Cookei* binucleate, and occasionally four-nucleate, cells seem to be more or less the rule in the

central part of the prothallus, at the time when the archegonia are mature. Such cells are fairly frequent in *Cupressus* at a later stage, but very rare in *Pinus*. I cannot agree with Miss Ferguson (7) that the formation of such cells in *Pinus* is always delayed to such a late stage as that to which she refers, though undoubtedly the first-formed cells are always uninucleate, as they are in Callitricheae. From the remarks made by Miyake (16) in connexion with *Cunninghamia*, though he is not very explicit, one concludes that binucleate cells are occasionally found in the older prothallus.

In *Sequoia* I have not been able to demonstrate such cells at the time when archegonia are about mature, but my preparations are not good enough to say definitely that they are absent. Lawson (14) does not mention the point. To summarize, the phenomenon is by no means confined to the Callitricheae, but is more conspicuous in them than in any other Pinaceae. In the Taxaceae, as far as known, it is much more prevalent, possibly owing in some cases to the small size of the nuclei, as noted in preparations of *Podocarpus Thunbergii*.<sup>1</sup> On the whole, there is no evidence that the character is of any importance, except as a nutritive adaptation.

#### 4. THE MALE GAMETOPHYTE.

The pollen-grain, as first found in the micropyle, still contains only a single nucleus. The thin exine bursts, and starch is no longer found surrounding the nucleus. In the example figured (Fig. 24) the grain is lodged on the side of the integument, just above the nucellus, but normally the pollen becomes attached to the apex of the nucellus.

The divisions giving rise to the nuclei of the pollen-tube have not been seen, the next figure (25) showing a well-organized body cell, and two small nuclei, exactly alike in size and structure, embedded in a single mass of cytoplasm in advance of the body cell. In this figure one sterile nucleus is in advance of the other, but in later stages, until the body cell divides, they are almost invariably abreast. The tube takes a somewhat sinuous course (Figs. 8 and 25) through the middle of the nucellus, and may occasionally branch quite close to the apex. It has not been observed to branch in the lower (meristematic) part of the nucellus. The number of pollen-tubes growing down the nucellus is commonly two. Their position in a transverse section of the nucellus is shown in Pl. XXVI, Fig. 26. Sometimes three or four pollen-tubes are found. The tubes reach the tip of the embryo-sac long before cell formation begins (Fig. 27), and at once grow into the prothallial cavity. The pollen-tube and its contents take up practically their final position before wall formation begins, though it is probable that a very slight amount of growth may occur later. Shortly before the body cell divides, the tip of the tube has the structure shown

<sup>1</sup> Miss Gibbs (8), however, figures a case where the nuclei are very large.

in Fig. 28. The nucleus of the body cell has increased in size, and its appearance is that of a nucleus about to prepare for division. The cytoplasm is dense and very homogeneous, and the wall is more distinct than in earlier stages. This is the structure of the pollen-tube shortly after wall formation is complete, and Figs. 29 (a transverse section of the pollen-tube and adjacent tissues) and 10 show that it is completely embedded in the tissue of the prothallus, and not lying, as is often the case in *Widdringtonia*, between the megaspore membrane and the prothallial cells. It is quite possible, however, that it does sometimes lie on the outside of the prothallus.

Since some collections included pollen-tubes both before and after division of the body cell, efforts were made to secure stages of this division, but entirely without success, although every stage in the rounding off of the male cells has been seen in numerous preparations, and many others show a body cell like that of Fig. 28. It is, of course, impossible to state precisely the period elapsing between the various stages seen of the rounding off of the male cells, but the short time which elapses between their formation and the occurrence of fertilization makes it likely that these would differ, in time, by only a very few hours. Other investigators have evidently also had difficulty in securing this division, it having only been recorded in comparatively few genera, the latest of these being *Juniperus communis*, var. *depressa*, where Nichols (17) figures a few stages of the division, but confesses to failure in the endeavour to obtain a complete series. As he gives a *résumé* of the work previously done on the same division in other genera, it is not necessary to say more on that score, but taking into consideration the various researches of recent years, and the fact that all investigators collect at short intervals round about the time of fertilization, shortly before which the body cell divides, the conclusion seems inevitable that the body cell much more frequently divides at an hour (doubtless in the night) when collections are seldom or never made, than at any other time. The alternative view would be that the whole division is passed through in an exceedingly short space of time.

As first seen after their formation (Fig. 30) the two male cells appear to be still enclosed in the mother-cell wall. This is a stage which has apparently not been noted previously, it having been assumed that the male cells are not formed within a mother-cell wall. Coulter (4), however, remarked in this connexion, 'it is not an unreasonable expectation that some of the male cells may be found to be formed within mother-cells.' No trace of the mother-cell wall can be seen at a slightly later stage.

Whether the body cell moves down at about the time of its division, or whether the sterile nuclei move up, cannot be positively determined, but from the fact that the end of the pollen-tube is some way below the male cells, the second alternative seems probable. In any event, the two sterile

nuclei are now found beside the lower male cell as shown in Figs. 30, 31, and 12. Soon after the stage of Fig. 30, the two sterile nuclei begin to disorganize. The male cells at the same time become hemispherical, and then gradually separate from one another and round out, eventually becoming almost egg-shaped (Fig. 31). The two male cells are always exactly one above the other in the tube. Occasionally the disorganized remains of the sterile nuclei may be found in the same tube with mature male cells, as shown in the figure, but more often no trace of them is left. That this stage is one very shortly before fertilization is indicated by the fact that another pollen-tube closely adjacent to the one figured was already empty, having fertilized two archegonia in contact with it. In Fig. 10 each of the two pollen-tubes shows one of its two male cells cut transversely.

It is necessary here to correct another misstatement in Coulter and Chamberlain's 'Morphology of Gymnosperms': they assert, in regard to *Widdringtonia*, that 'the single pollen-tube penetrates the megaspore membrane, and . . . only after entering within the membrane does the generative cell divide', but the latter statement can only be attributed to a vivid imagination on the part of those authors, as, from the context, it is fairly clear that 'generative cell' was not written merely by a slip of the pen for 'body cell'. It is obvious from the description, and Figs. 17, 30, 31, and 32, in my paper on the genus (20), to which reference is made, that the body cell has been formed long before the tube reaches the megaspore membrane, and that the only division which occurs after entering within the membrane is that of the body cell.

At about this time it is noticeable that a good many ovules become abortive, and it seems clear that this is due in all cases to the pollen-tube failing to reach its normal position. It is sometimes found that the tubes never get beyond the nucellus; in other cases they penetrate a little way into the prothallus, but not to the region of archegonium initials. As many as four tubes, extending various distances down the ovule, have been found in one series of sections, all showing the rather undersized body cell characteristic of abortive tubes. Apparently the body cell never divides in these abortive tubes.

It is very rarely that any other abnormality is met with in a pollen-tube, but the case shown in Fig. 32 is of some interest. Reference has already been made to this tube as the one found in the same prothallus as that in which the archegonia of Figs. 13 and 14 were contained. It includes four nuclei and a good deal of cytoplasm. The lowest nucleus is slightly larger than the other three, while the latter are very close to one another in a common mass of cytoplasm. No other nuclei are present in the tube. It may be seen that the size and organization of these nuclei are very much the same as those of normal male cells. (All the later stages of the pollen-tube are drawn to the same scale.) The likely explanation seems to be

that all four nuclei (two male cells and two sterile nuclei) were embedded in a common mass of cytoplasm, which did not, therefore, become organized into definite cells around the two male nuclei only, but remained diffuse in the tube. Since all four nuclei were exposed to the same nutritive conditions, they all developed to an approximately equal size. The lowest nucleus, being in contact with the larger bulk of the cytoplasm, has, however, grown a little larger than the rest. It is probable, as noted above, that the archegonia associated with this tube were slightly abnormal, though not markedly so.

##### 5. FERTILIZATION AND EMBRYOGENY.

Since the details of proembryo formation were not satisfactorily elucidated in either *Widdringtonia* or *Callitris*, attention has been somewhat concentrated on this phase of the life-history in *Actinostrobos*, and all the points of chief importance have been satisfactorily made out.

Certain points were definitely ascertained in regard to the development of the proembryo of *Widdringtonia*, which Coulter and Chamberlain (5) have incorrectly amplified. They say: 'Saxton states, furthermore, that walls appear in the proembryo of *Widdringtonia* before the eight-nucleate stage, which probably means that they appear during the transition from the four-nucleate to the eight-nucleate stage, as in most Pinaceae.' In the paper (20) to which reference is there made, a figure was given, described in the text, of a proembryo containing five resting nuclei, between which walls had already been laid down. If Coulter and Chamberlain wish to ignore the conclusions to which investigated facts have led the investigators, they should at least be very careful not to misstate the facts.

Assuming, as is at least reasonably probable, that *Callitris* and *Widdringtonia* agree with one another in the main points of their proembryo development, the following are the facts known in regard to fertilization and embryogeny in those genera: (1) The male and female nuclei at the time of fertilization are equal in size and similar in structure. (2) The first division of the fusion nucleus results in the formation of two free nuclei. (3) Walls are formed while there are still less than eight nuclei in the proembryo. (4) Subsequent divisions result in a mature proembryo of about a dozen cells or less, which completely fills the archegonium. (5) In *Callitris* at least, perhaps not in *Widdringtonia*, groups of two or three cells probably separate from one another, and in each group the lowest cell (in regard to the apex of the prothallus, not to the apex of the archegonium) gives rise to the embryo, and the cell next above it to the suspensor.

There is now presented a fairly complete account of the corresponding phases in *Actinostrobos*.

Fertilization has been seen in a considerable number of preparations,

and, with one or two exceptions, both male cells have proved to be functional. They always fertilize two archegonia which are either adjacent or separated by one unfertilized archegonium, one of them being vertically above the other as regards the long axis of the prothallus.

After fertilization the numerous unfertilized archegonia quickly degenerate, and evidently function as a nutritive tissue, taking the place, in this respect, of the jacket cells commonly present in other Conifers, but which are quite absent here.

The male and female nuclei are of approximately equal size and similar structure, both immediately before and during fertilization, as shown in Figs. 33, 34, and 34 *a*. As far as the sexual nuclei are concerned, each of these figures is typical of a number of preparations, but in other respects each shows an interesting abnormality. Reference has already been made to Fig. 33 as the only case seen of a ventral canal cell. No such structure has been seen in other preparations; also the two neck cells are intact, and the male nucleus has evidently penetrated the archegonium from the side.

Fig. 34 is the only case noted where the second male nucleus was definitely identified in a degenerate condition left behind in the tube. The body shown at the apex of the archegonium appeared to be the collapsed remains of the cytoplasm of the functional male cell, but this is not certain, and in other cases it is clear that the cytoplasm passes into the archegonium, as well as the male nucleus, at the time of fertilization. The exceptional case figured is, however, interesting in comparison with the same stage in *Sequoia* (Lawson (14)), where the cytoplasm is normally left behind in the tube.

Fig. 35 is about the same stage of fusion as Fig. 34, but is the only case noted showing a clear difference in size between the male and female nuclei.

The two sexual nuclei may almost always be seen to be surrounded by a starch sheath. Its origin is obscure, as no starch is visible in either the mature male cell or the mature archegonium. Its appearance in later stages is rather sporadic; speaking generally, it is not seen in connexion with any nuclei in mitosis, except early in the first division, but reappears after the daughter nuclei are fully organized. It has practically disappeared by the time the proembryo is mature, and is never seen after the suspensor begins to elongate.

To make the following description clear, the terms 'apex' and 'base' and 'long axis' will refer to the *archegonium* and not to the prothallus. Since the long axis of the archegonium is at right angles to that of the prothallus, the need for such a distinction is obvious.

In the first division, the spindle (Fig. 36) is seen to be entirely intranuclear, as usual, and the poles are rather broad. The stage figured is



evidently before the splitting of the chromosomes, and sixteen can be counted on the equator of the spindle (Fig. 36 *a*). At this time no segregation of the chromosomes into two groups (representing ♂ and ♀) could be seen, but this would hardly be expected except at an earlier stage of division.

The spindle may be oblique to the long axis (Fig. 36) or parallel to it (Pl. XXVII, Fig. 37). It may be that it starts parallel to the plane of fusion of the maternal and paternal nuclei, and subsequently becomes parallel to the long axis, but the number of preparations of these stages is not sufficient to substantiate the suggestion. Fig. 37 shows the two daughter nuclei reorganizing, with the spindle still quite evident between them. No cell-plate is laid down and the spindle disappears completely.

The basal nucleus next divides to form two daughter nuclei, placed one above the other, or somewhat obliquely (Figs. 38 and 39), and is very quickly followed by the upper nucleus, which divides in a transverse plane. We have thus the arrangement represented in longitudinal section in Fig. 40, in which it is most clearly shown that cell-plates have been formed from the spindles, traces of which can still be seen between the pairs of daughter nuclei. The segmentation is then completed by the formation of a cleavage plane between the two pairs of daughter nuclei, giving the arrangement shown in Fig. 41.

The later stages are sometimes difficult to interpret, because it is often impossible to say whether a group of embryonic cells is formed from one fertilized archegonium, or from two adjacent archegonia, the wall between adjacent archegonia being exactly like that between adjacent proembryo cells. In any case, it is certain that some cell divisions follow the stage of Fig. 41, probably only occurring in the two basal cells, but it is unlikely that their sequence or number is constant. Parts of proembryos are shown in section in Figs. 42 and 43, in which the divisions in progress are probably the last which occur in the formation of the mature proembryo.

The mitotic figures of Fig. 42, from both the sections in which they are seen, are drawn on a larger scale in Figs. 42 *a* and 42 *b*. The stage of division is slightly later than that shown in Pl. XXVI, Fig. 36, after the splitting of the chromosomes, and thirty-two chromosomes, i. e. sixteen for each daughter nucleus, can be counted in each mitosis.

Each cell of the mature proembryo, except the two apical cells, which appear to take no further part in the development, gives rise by a mitotic division to two cells of very unequal size, the larger of which becomes the suspensor, and the smaller the embryo initial. This mitosis always occurs towards that side of the cell nearest the basal end of the prothallus (Figs. 44 and 45). In this division the sporophytic number of chromosomes (16) has again been counted (Fig. 45 *a*). The two resulting cells (suspensor and embryo initial) are shown very shortly after their formation in Fig. 46, and somewhat later in Fig. 47, when the difference in size of the

nuclei is more pronounced. A few starch grains are seen in the suspensor in this figure, but are seldom found at such a late stage.

After this the suspensors rapidly elongate and their walls thicken, and they form an intertwining mass of long tubes in the region previously occupied by the disorganizing, unfertilized archegonia, eventually breaking down nearly all the apical tissue of the prothallus (Pl. XXVIII, Fig. 54).

The large nucleus of the suspensor is very persistent, as well as conspicuous, and may be identified for quite a long time in the development of

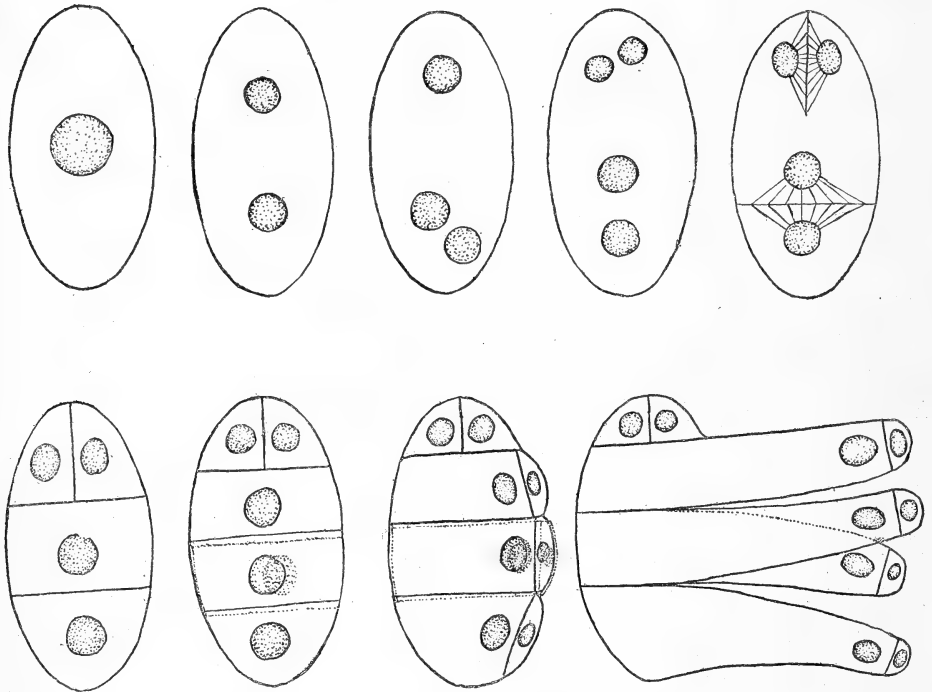

TEXT-FIG. 3. Series of diagrams to illustrate the development of the proembryo, formation of embryo cells, and elongation of the suspensors.  $\times$  about 350. (The apex of the prothallus is supposed to be to the *left*, in these diagrams.)

the embryo. It remains near the embryo, embedded in a small mass of cytoplasm, the rest of the suspensor being devoid of contents.

A group of four suspensors and embryo initials is shown in Fig. 48, shortly after the suspensors have begun to elongate, and two at a later stage in Fig. 49; a somewhat similar group is shown in the microphotograph (Fig. 54).

The embryo initials remain undivided for a considerable time, something like ten days or a fortnight, and the first division wall is vertical, as shown in Figs. 50 and 55 (microphotograph), this being quickly followed by

a second vertical wall in each of the resulting cells, in a plane at right angles to the first. There is thus formed a single tier of four cells at the tip of the suspensor. The next division is transverse (Fig. 51). The subsequent development has not been followed closely, but scattered stages, such as those shown in Figs. 52 and 56 (microphotograph), indicate that the later stages are very similar to those of *Pinus* and other Conifers. Embryonal tubes are a conspicuous feature, as in many other Conifers, and are well shown in Fig. 56. It is perhaps worth noting that the four cells formed by the first divisions in the embryo initial always remain associated, constituting a single embryo.

The number of cotyledons in the mature embryo is always two, as noted by Hill and de Fraine (10), and in spite of the large number of embryos which begin to develop, no case of more than one embryo reaching an advanced stage has been observed. The development of the proembryo, and the differentiation of suspensors and embryo initials, are indicated in the series of diagrams in Text-fig. 3.

## 6. CONCLUSIONS.

The chief result of the present study has been the more detailed knowledge now obtained of the proembryo and embryo development, which has emphasized the conclusion previously reached (20, 21), that these stages in the Callitrineae are radically different from the corresponding stages in all other Conifers. There can be no doubt that the proembryo development is substantially the same in *Callitris* and *Actinostrobus*, and to a less extent in *Widdringtonia* also.

The close resemblance between *Actinostrobus* and *Callitris* in almost every respect is very remarkable, and tends to emphasize the differences between these Australasian genera on the one hand, and the African genus of the Callitrineae, *Widdringtonia*, on the other.

In previous studies the opinion has been expressed, both by the present writer and by others who have investigated those Conifers with lateral archegonia, that this (i. e. lateral position of archegonia) is probably an 'ancient' character. The evidence was perhaps mainly the fact that they were associated with many other 'ancient' characters in the Araucarians; in any case, the evidence was not complete, and Coulter (4) has justly criticized the view, and stated sound arguments for an opposite opinion. Land (13) and Pearson (18) had previously taken the position that this tendency might represent an advance towards Gnetoid conditions. Further study of the Callitrineae has tended to show that Coulter's view is likely to be the right one, and some further evidence has been recently brought forward in this direction by the writer (22) from an abnormal Pine prothallus with only lateral archegonia, although opinion will doubtless differ

as to its value. The present conclusions, based largely on the study of *Actinostrobus*, supplemented by published work on other Conifers with lateral archegonia, are as follows: (1) The occurrence of prothalli with lateral archegonia, in Conifers, is regarded as a 'mutation' from the usual type of prothallus. (2) The production of a prothallus with lateral archegonia probably occurred at least twice in the phylogeny of the group: (a) When the Araucarians were differentiated from the Abietineae, which may be regarded as having taken place quite early in the history of Conifers, soon after differentiation from the Cordaitales. In the Abietineae the somewhat widely separated archegonia of the Cordaitales, as figured in *Cycadinocarpus* (Coulter and Chamberlain after Renault (5)), approximated more closely, while in the Araucarians they separated more widely. In preparations of *Araucaria Cookei* and *A. excelsa* the writer has found the archegonia to lie, with their apices pointing obliquely outwards, very slightly below the rather flattened apex of the prothallus. Each archegonium has its own layer of well-defined jacket cells, and a rather large number of neck cells, which lie at the bottom of a canal very similar to that leading to each archegonium in *Pinus*. It is stated (Seward and Ford (23)), that the archegonia may be deep-seated in some cases, but more work is needed on the genus before such a statement can be definitely accepted; it is not even clear whether 'deep-seated' in this connexion may not mean, merely, sunken at the base of a canal, as in *Pinus*. (b) When the Cupressineae, Callitrineae, and Sequoiineae materialized: doubtless a later event than the Araucarian differentiation. The close resemblance, in many respects besides the lateral archegonia, between *Sequoia* and the Callitrineae has already been emphasized, and the conclusion seems justified that the two tribes were derived from a common ancestry with lateral archegonia, while the Cupressineae developed and retained the apical group with a common jacket layer. Where any trace of a jacket layer does occur in Callitrineae, it also surrounds a group of archegonia as a rule, and not individual archegonia. More often specialized jacket cells do not become differentiated at all.

As regards other relationships, it has been suggested before that of all Conifers the Callitrineae come nearest to the Gnetales. The formation of the embryo and suspensor from a single proembryonal cell is by no means dissimilar to what occurs in *Ephedra* (Land (13)) and *Welwitschia* (Pearson (18)), though the formation of a cleavage plane instead of a cell-plate is admittedly an important difference. The first three series of divisions in the embryo are also identical with those in *Welwitschia* (Pearson (18)). Coulter (4), although regarding any attempt to select the tribe of Conifers most nearly related to the Gnetales as 'peculiarly unprofitable', nevertheless implies on a later page that his own selection is the Cupressineae. Doubtless he is quite justified in saying that any such

connexion may mean only the parallel development of the two groups ; it very probably does ; but it seems of interest to note a likelihood that in certain respects the Callitrineae have perhaps developed in a similar direction to the Gnetales, and that to a somewhat less extent the Cupressineae have also done so.

The general question of Conifer classification is to be discussed in another place, and no further reference need be made to it here.

7. SUMMARY.

1. About three months elapse between pollination and fertilization in *Actinostrobus*.

2. Each microsporophyll bears usually three sporangia.

3. The mature pollen-grains are uninucleate.

4. From six to twelve (usually nine) ovules are borne in each female cone.

5. A single megaspore mother-cell is formed in the nucellus, and no spongy tissue is organized.

6. Archegonia are formed from the alveoli, after the cutting off of some small cells at base and apex, and are deep-seated, a group of twenty-five to thirty being found abutting on the lower end of each pollen-tube, which reaches about half-way down the prothallus.

7. Large secretory cavities are found in the tissue of the integument, alternating with the wings.

8. The older cells of the prothallus are generally binucleate or four-nucleate.

9. The male gametophyte agrees very closely with that of Cupressineae, but the two male cells appear to be enclosed within a mother-cell wall when first formed.

10. The two male cells fertilize two approximately adjacent archegonia.

11. In fertilization the sexual nuclei are practically alike in size and structure.

12. Wall formation in the proembryo occurs during, and following, the transition from the binucleate to the four-nucleate condition (i. e. earlier than in most Pinaceae), and the proembryo completely fills the archegonium.

13. Most of the cells of the mature proembryo give rise, by a very unequal division, to a suspensor and an embryo initial.

14. The first two division walls in the embryo initial are vertical.

15. Further development of the embryo is the same as in other Conifers.

16. The haploid and diploid numbers of chromosomes are eight and sixteen, respectively.

17. The occurrence of lateral archeogonia in Conifers is regarded as a specialized condition, which probably arose independently at least twice in the history of the group.

---

#### LITERATURE CITED.

1. BAKER, R. T., and SMITH, H. G. : A Research on the Pines of Australia. Sydney, 1910.
2. BOWER, F. O. : Studies in the Morphology of Spore-producing Members. 1894-1903.
3. COKER, W. C. : Notes on the Gametophytes and Embryo of *Podocarpus*. Bot. Gazette, vol. xxxiii, 1902, pp. 89-107, Pls. v-vii.
4. COULTER, J. M. : Evolutionary Tendencies among Gymnosperms. Bot. Gazette, vol. xlviii, 1909, pp. 81-97.
5. ——— and CHAMBERLAIN, C. J. : Morphology of Gymnosperms. The University of Chicago Press, Chicago, 1910.
6. ——— and LAND, W. J. G. : Gametophytes and Embryo of *Torreya taxifolia*. Bot. Gazette, vol. xxxix, 1905, pp. 161-178, Pls. A, i-iii.
7. FERGUSON, M. C. : Contributions to the Life-history of *Pinus*, with Special Reference to Sporogenesis, the Development of the Gametophytes, and Fertilization. Proc. Wash. Acad. Sci., vol. vi, 1904, pp. 1-102, Pls. i-xxiv.
8. GIBBS, L. S. : On the Development of the Female Strobilus in *Podocarpus*. Ann. Bot., vol. xxvi, 1912, pp. 515-711, Pls. xlix-liii.
9. GOEBEL, K. : Outlines of Classification and Special Morphology. English translation, 1887.
10. HILL, T. G., and DE FRAINE, E. : On the Seedling Structure of Gymnosperms. I. Ann. Bot., vol. xxii, 1908, pp. 689-712, Pl. xxxv.
11. JAEGER, L. : Beiträge zur Kenntniss der Endosperm-bildung und zur Embryologie von *Taxus baccata*. Flora, vol. lxxxvi, 1899, pp. 241-88, Pls. xv-xix.
12. JUEL, H. O. : Ueber den Pollenschlauch von *Cupressus*. Flora, vol. xciii, 1904, pp. 56-62, Pl. iii.
13. LAND, W. J. G. : Fertilization and Embryogeny in *Ephedra trifurca*. Bot. Gazette, vol. xlv, 1907, pp. 273-92, Pls. xx-xxii.
14. LAWSON, A. A. : The Gametophyte, Archegonia, Fertilization, and Embryo of *Sequoia sempervirens*. Ann. Bot., vol. xviii, 1904, pp. 1-28, Pls. i-iv.
15. LUTMAN, B. F. : Cell and Nuclear Division in *Closterium*. Bot. Gazette, vol. li, 1911, pp. 401-30, Pls. xxii, xxiii.
16. MIYAKE, K. : The Development of the Gametophytes and Embryogeny of *Cunninghamia sinensis*. Beih. Bot. Centralbl., xxvii, 1911, pp. 1-25, Pls. i-v.
17. NICHOLS, G. E. : A Morphological Study of *Juniperus communis*, var. *depressa*. Beih. Bot. Centralbl., vol. xxv, 1910, pp. 201-41, Pls. viii-xvii.
18. PEARSON, H. H. W. : Further Observations on *Welwitschia*. Phil. Trans. Roy. Soc. London, B, vol. cc, 1909, pp. 331-402, Pls. xxii-xxx.
19. SAXTON, W. T. : Preliminary Account of the Development of the Ovule, Gametophytes, and Embryo of *Widdringtonia cupressoides*, Endl. Bot. Gazette, vol. xlviii, 1909, pp. 161-78, Pl. xi.
20. ——— : Contributions to the Life-history of *Widdringtonia cupressoides*. Bot. Gazette, vol. l, 1910, pp. 31-48, Pls. i-iii.

21. SAXTON, W. T.: Contributions to the Life-history of *Callitris*. Ann. Bot. xxiv, 1910, pp. 557-69, Pls. xlv, xlvi.  
 22. ———: Note on an Abnormal Prothallus of *Pinus maritima*, L. Ann. Bot., vol. xxvi, 1912, pp. 943-5.  
 23. SEWARD, A. C., and FORD, S. O.: The *Araucarieae*, recent and extinct. Phil. Trans. Roy. Soc., London, B, vol. cxcviii, 1906, pp. 305-411, Pls. xxiii, xxiv.

## EXPLANATION OF FIGURES IN PLATES XXV-XXVIII.

Illustrating Mr. Saxton's paper on *Actinostrobilus*.

NOTE. All figures of longitudinal sections are oriented with the longer axis of the ovule vertical and the micropylar end upwards, except Figs. 36-43, which are with the longer axis of the ovule horizontal (approximately) and that of the archegonium vertical, with the apex of the archegonium upwards. The orientation of Figs. 53-56 (Plate XXVIII) is indicated by an arrow.

In all: *a* = archegonium; *b* = body cell; *c* = micropyle closing cells, *d* = megaspore mother-cell; *e* = embryo cell; *f* = neck cells; *g* = secretory cavity; *h* = sterile nuclei of the pollen-tube; *i* = integument; *k* = embryonal tubes (secondary suspensors); *m* = male cells; *n* = nucellus; *p* = prothallus; *s* = suspensor; *t* = pollen-tube; *v* = ventral nucleus;  $\delta$  = male nucleus;  $\varphi$  = female nucleus.

### PLATE XXV.

- Fig. 1. Transverse section through the stalk of the microsporophyll.  $\times 80$ .  
 Fig. 2. Section of a mature pollen-grain.  $\times 1,100$ . July 13.  
 Fig. 3. Longitudinal section of a young ovule, before pollination.  $\times 120$ .  
 Fig. 4. Young megaspore mother-cell, in longitudinal section.  $\times 550$ . June 1.  
 Fig. 5. Megaspore mother-cell in synapsis.  $\times 950$ . June 1.  
 Fig. 6. Megaspore with remains of non-functional megasporos.  $\times 950$ .  
 Fig. 7. Binucleate megaspore.  $\times 800$ . July 13.  
 Fig. 8. Longitudinal section of a whole ovule at the time when the young embryo-sac contains eight nuclei.  $\times 160$ . July 13.  
 Fig. 9. Part of the prothallus in longitudinal section at the time when cell formation is taking place.  $\times 200$ . Oct. 12.  
 Fig. 10. Transverse section of prothallus, showing position of young archegonia and pollen-tubes.  $\times 200$ . Oct. 12.  
 Fig. 11. Transverse section of the neck of an archegonium.  $\times 340$ .  
 Fig. 12. Longitudinal section of part of a prothallus, showing three archegonia and the contents of a pollen-tube.  $\times 340$ . Oct. 19.  
 Fig. 13. Only case seen of an archegonium showing a ventral canal nucleus. (See text.)  $\times 485$ . Oct. 14.  
 Fig. 14. Abnormal archegonium. (See text.)  $\times 450$ . Oct. 14.  
 Fig. 15. Tangential section of part of a prothallus, cutting a single group of archegonia transversely.  $\times 190$ . Oct. 12.  
 Fig. 16. Transverse section of a prothallus, in which no pollen-tube was found, showing very deep-seated archegonia.  $\times 100$ . Oct. 12.  
 Fig. 17. Transverse section of an ovule, showing the structure of the integument.  $\times 15$ .  
 Fig. 18. Part of the same section, showing one of the secretory cavities on a larger scale.  $\times 50$ .  
 Fig. 19. Transverse section of a nucellus and prothallus.  $\times 24$ .  
 Fig. 20. Two cells at the margin of a fairly old prothallus, showing the megaspore membrane.  $\times 650$ .  
 Fig. 21. Two cells near the margin of the same prothallus as Fig. 26.  $\times 650$ .  
 Fig. 22. Prothallus cell with four nuclei.  $\times 500$ .

Fig. 23. Dividing nucleus in a prothallus cell.  $\times 860$ .

Fig. 24. Pollen-grain in the micropyle of the ovule.  $\times 950$ .

Fig. 25. Young pollen-tube in the apex of the nucellus.  $\times 200$ . Aug. 23.

PLATE XXVI.

Fig. 26. Transverse section of nucellus showing two pollen-tubes.  $\times 120$ .

Fig. 27. Tip of a pollen-tube which is just passing into the prothallus, some time before cell formation begins. The megaspore membrane had not been penetrated at this time, and had somewhat contracted. It therefore does not appear in the figure.  $\times 360$ . Sept. 12.

Fig. 28. The tip of the pollen-tube very shortly before the body cell divides. It is now far down in the prothallus.  $\times 360$ . Oct. 4.

Fig. 29. Transverse section of a pollen-tube and surrounding tissue of the prothallus and nucellus, to the outside of the latter.  $\times 200$ .

Fig. 30. The contents of a pollen-tube very shortly after the formation of the two male cells. The latter are seen to be still enclosed in a delicate mother-cell wall.  $\times 360$ . Oct. 4.

Fig. 31. Contents of a mature pollen-tube, just before fertilization.  $\times 360$ . Oct. 12.

Fig. 32. Tip of an abnormal pollen-tube.  $\times 360$ . Oct. 4.

Fig. 33. Archegonium showing the male and female nuclei in contact. A ventral canal cell is shown, which is certainly not a normal feature of the archegonium.  $\times 775$ . Oct. 9.

Fig. 34. Archegonium and part of pollen-tube. The male and female nuclei are fusing, and the cytoplasm of the functional male cell, together with the second male cell, is left behind in the tube.  $\times 205$ . Oct. 9.

Fig. 34 *a*. The fusing nuclei and starch sheath of Fig. 34.  $\times 775$ .

Fig. 35. Similar to Fig. 34 *a*, but showing a distinct difference in size between the two nuclei.  $\times 775$ . Oct. 9.

Fig. 36. Archegonium showing the first division of the fusion nucleus.  $\times 485$ . Oct. 9.

Fig. 36 *a*. Part of Fig. 36 on a larger scale.  $\times 830$ .

PLATE XXVII.

Fig. 37. A later stage than Fig. 36. The daughter nuclei reorganizing. No cell plate is being formed.  $\times 830$ . Oct. 9.

Fig. 38. The division of the lower daughter nucleus. A cell plate is being formed between the grand-daughter nuclei.  $\times 700$ . Oct. 12.

Fig. 39. A later stage, after the wall is complete.  $\times 485$ . Oct. 12.

Fig. 40. Stage between Figs. 38 and 39, showing cell-plates practically complete between both pairs of grand-daughter nuclei.  $\times 485$ . Oct. 9.

Fig. 41. Later stage showing wall formation complete in the proembryo. One of the neck cells is still visible.  $\times 485$ .

Fig. 42. Section showing some of the later divisions in proembryo cells. The upper cell is one of the two upper cells corresponding to those of Figs. 40 and 41.  $\times 485$ . Oct. 12.

Figs. 42 *a* and 42 *b*. Parts of the dividing nuclei of Fig. 42, drawn on a larger scale, from each of the two sections in which they are seen.  $\times 830$ .

Fig. 43. A similar section to Fig. 42.  $\times 485$ . Oct. 12.

Fig. 44. Mitosis in a mature proembryo cell, cutting off an embryo cell from a suspensor.  $\times 485$ . Oct. 12.

Fig. 45. A slightly later stage than Fig. 44, showing the formation of a cell plate.  $\times 485$ . Oct. 12.

Fig. 45 *a*. Part of Fig. 45 on a larger scale. Sixteen chromosomes may be counted at each pole.  $\times 830$ .

Fig. 46. Suspensor and embryo cell, shortly after the division is complete.  $\times 485$ . Oct. 12.

Fig. 47. A slightly later stage than Fig. 46. The suspensor is just beginning to elongate.  $\times 830$ . Oct. 12.

Fig. 48. A group of four suspensors and embryo cells, at a later stage. Only the ends of the suspensors are shown in the section. One binucleate prothallus cell has been drawn; the other surrounding prothallus cells are not shown.  $\times 360$ . Oct. 12.



Fig. 49. Two suspensors and embryo cells at a later stage, when the embryo cell has enlarged preparatory to its first division.  $\times 360$ . Oct. 12.

Fig. 50. End of suspensor and embryo, after the formation of the first (vertical) division wall.  $\times 485$ . Nov. 1.

Fig. 51. Transverse division in one of the four cells of the first-formed tier. No wall could be certainly identified between the two nuclei, but doubtless it would be visible at a slightly later stage.  $\times 485$ . Nov. 1.

Fig. 52. A much later stage, showing the formation of embryonal tubes from the embryo cells next to the suspensor. The suspensor nucleus is still quite conspicuous at this time.  $\times 205$ . Nov. 11.

PLATE XXVIII.

Fig. 53. Microphotograph of a similar section to Fig. 15.  $\times 150$ . Oct. 9.

Fig. 54. Microphotograph showing a group of suspensors and embryos, about the same age as Fig. 49. The multinucleate prothallus cells can also be seen.  $\times 150$ . Oct. 14.

Fig. 55. Microphotograph of a similar stage to Fig. 50.  $\times 450$ . Nov. 1.

Fig. 56. Microphotograph of a later stage than Fig. 52. The embryonal tubes are now very conspicuous.  $\times 150$ . Nov. 21.



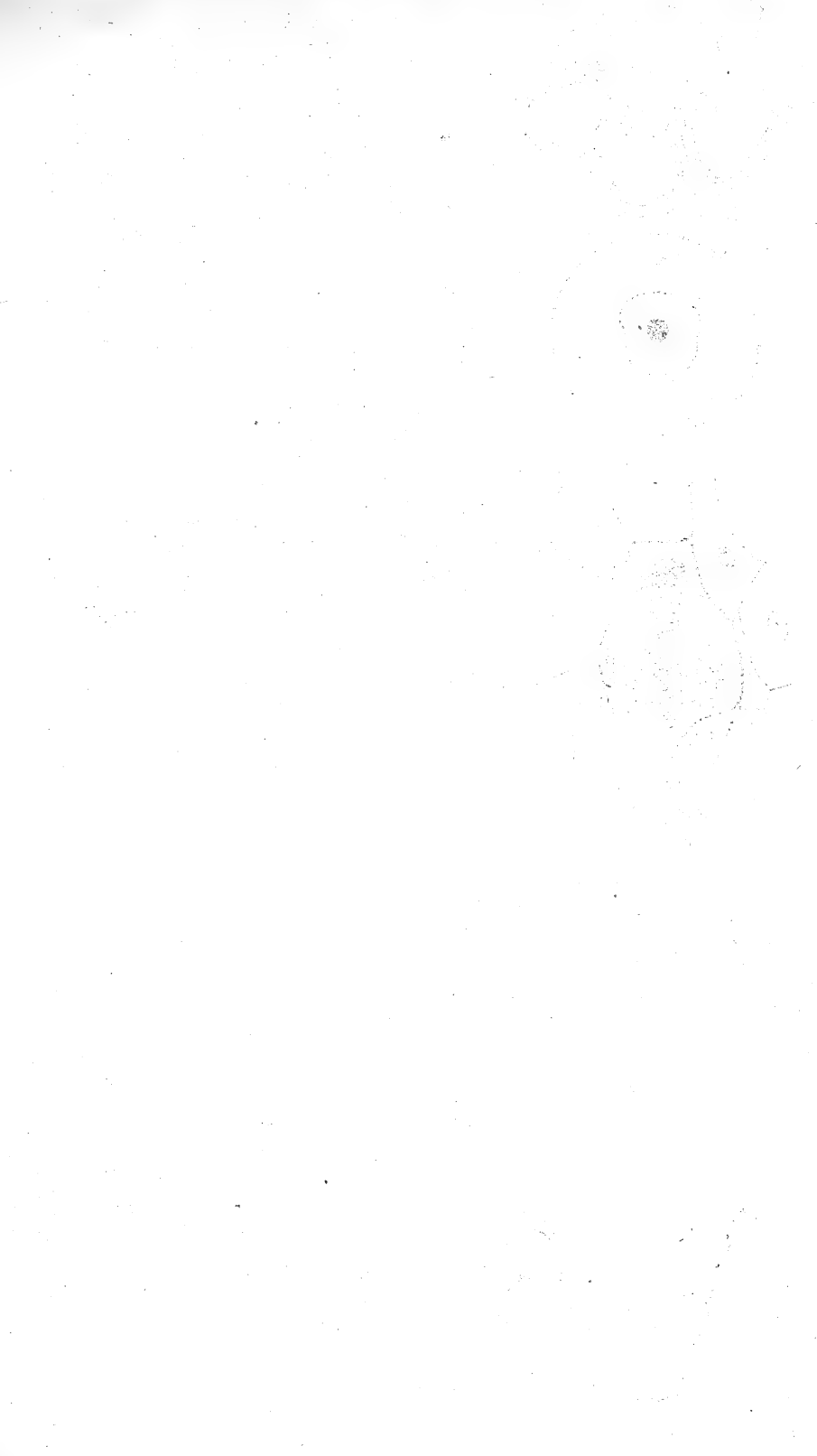

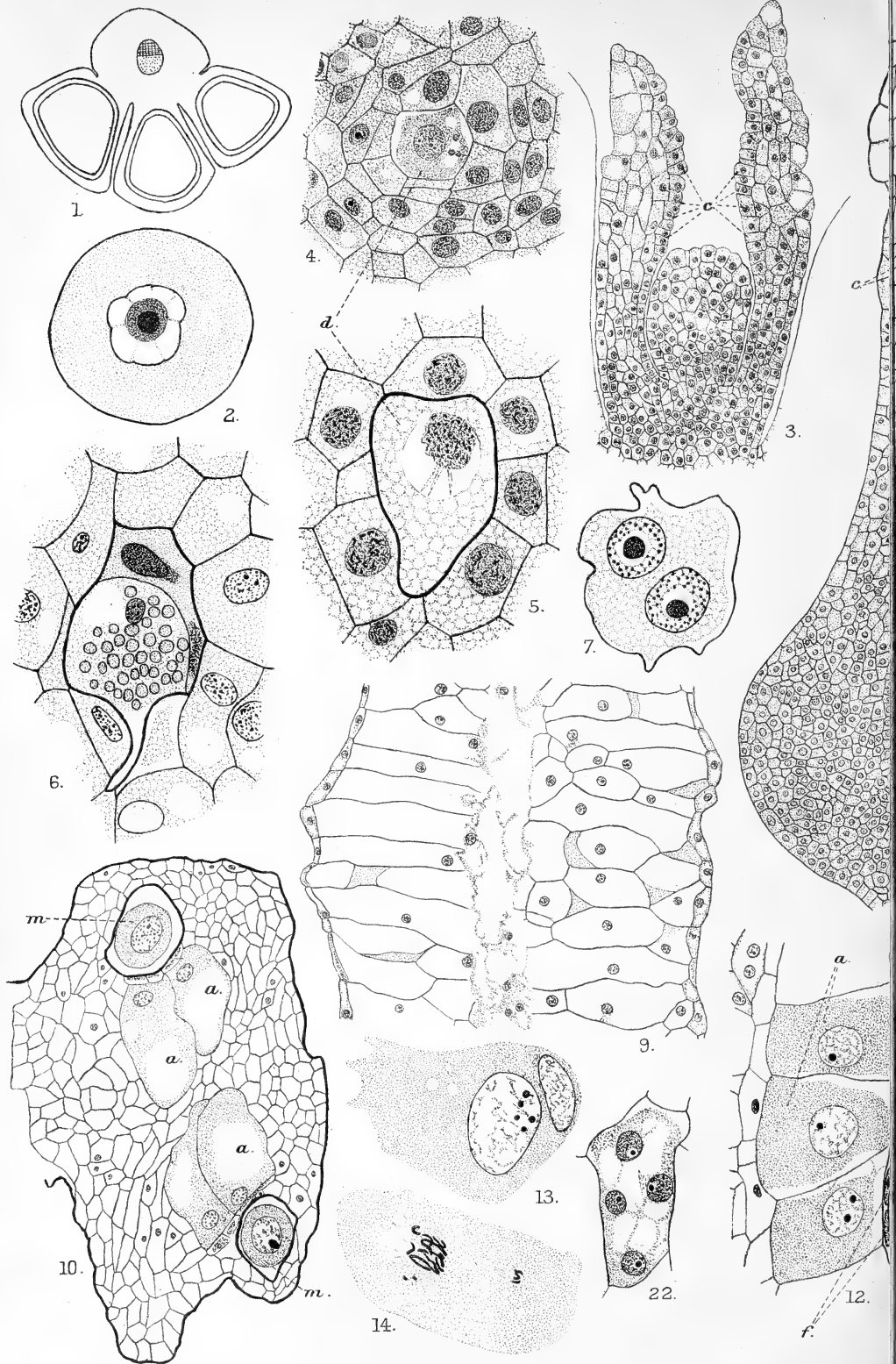

W.T. Saxton del.

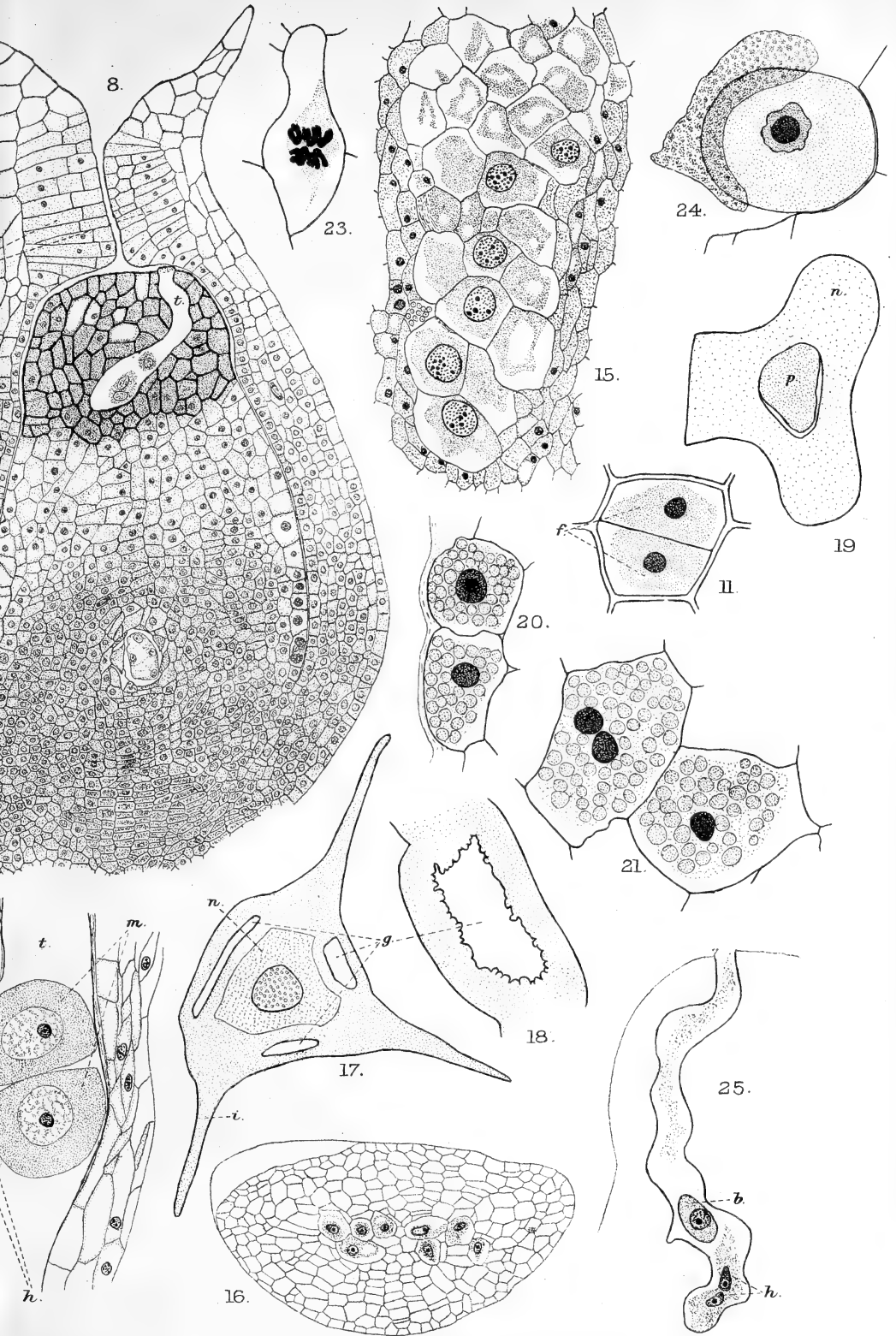



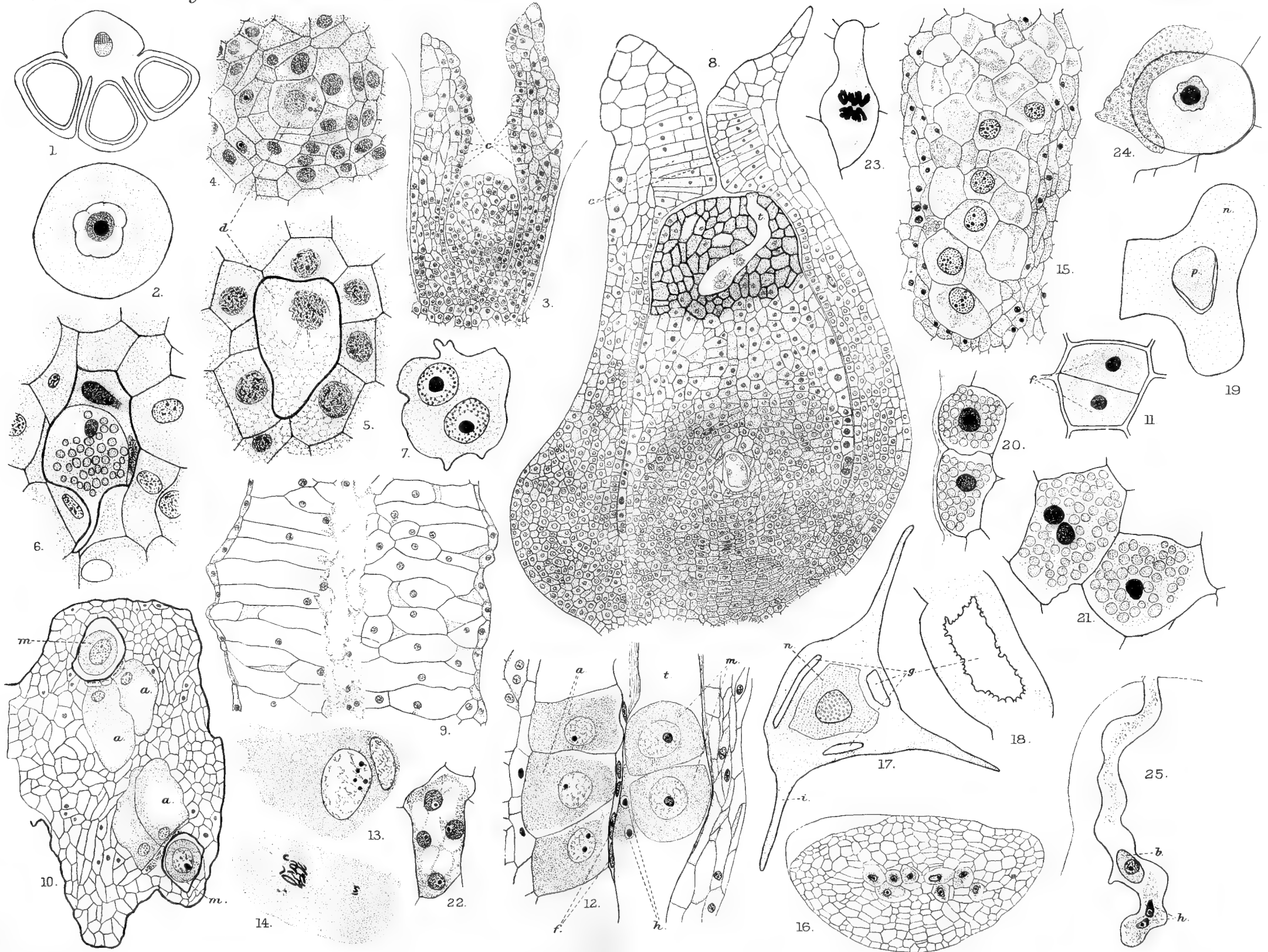

W.T. Saxton del.

SAXTON-ACTINOSTROBUS.

Henth. lith. et imp.





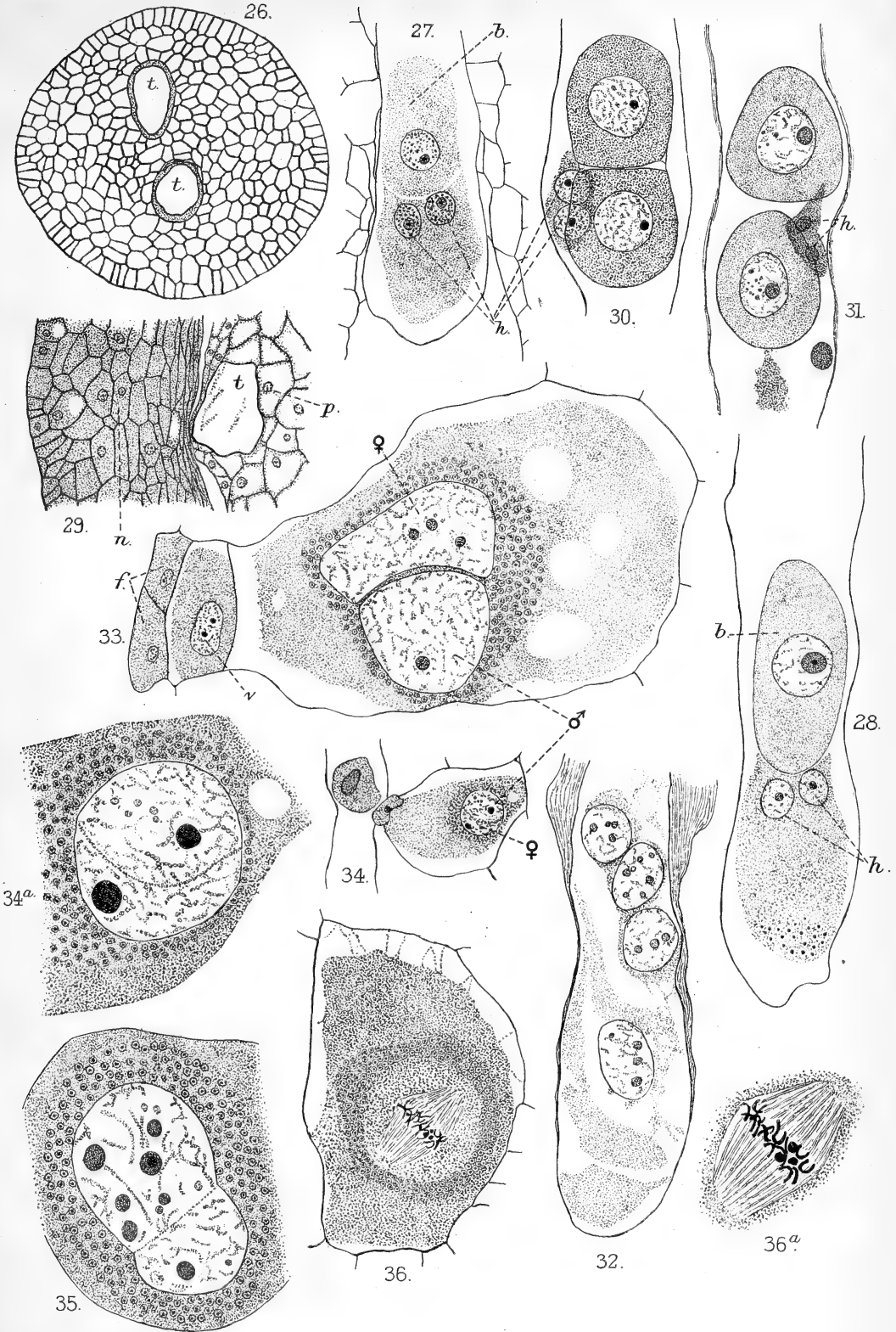

W.T. Saxton del.

Huthlith. et imp.



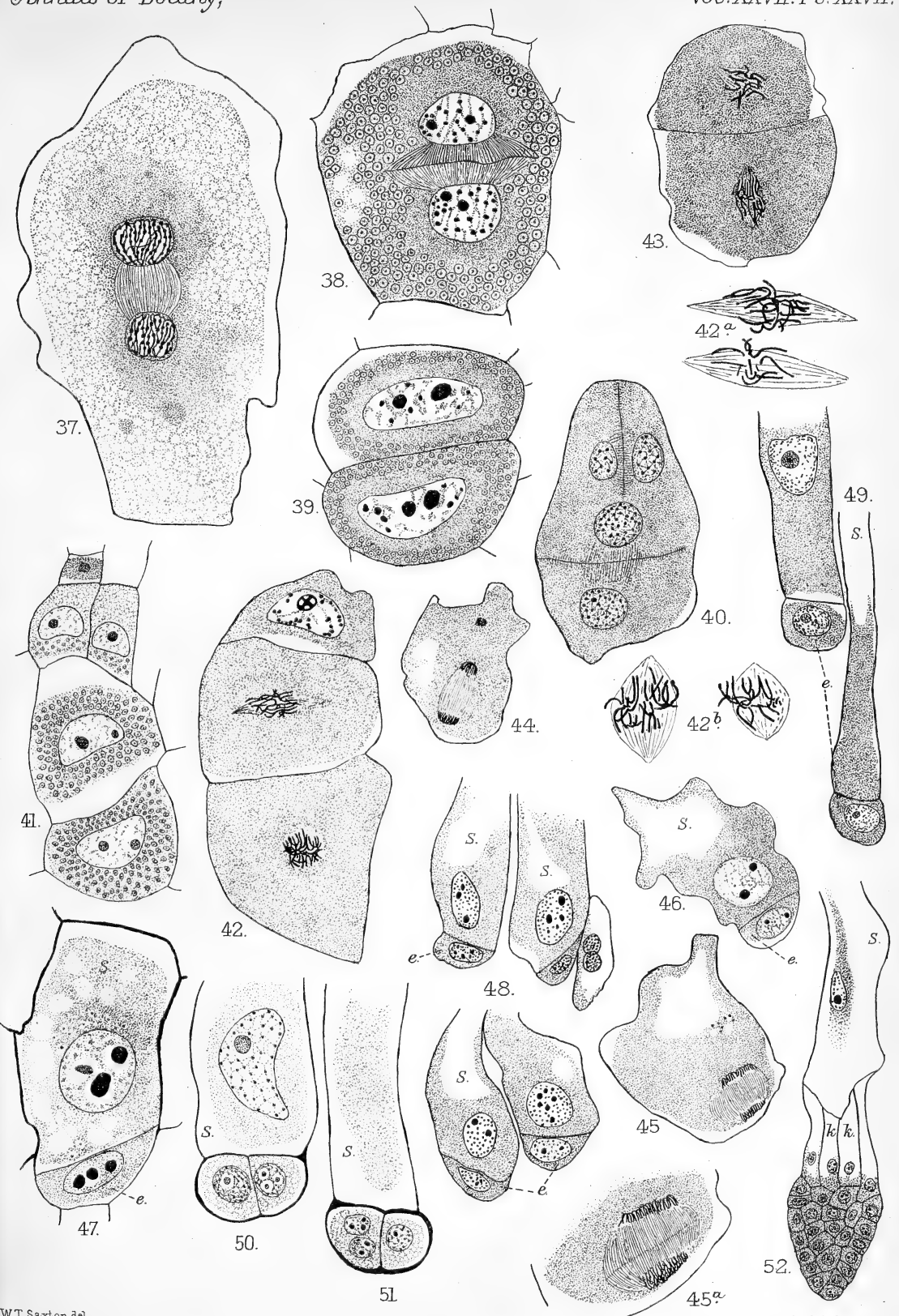

W.T. Saxton del.

Huth lith. et imp.

SAXTON-ACTINOSTROBUS.

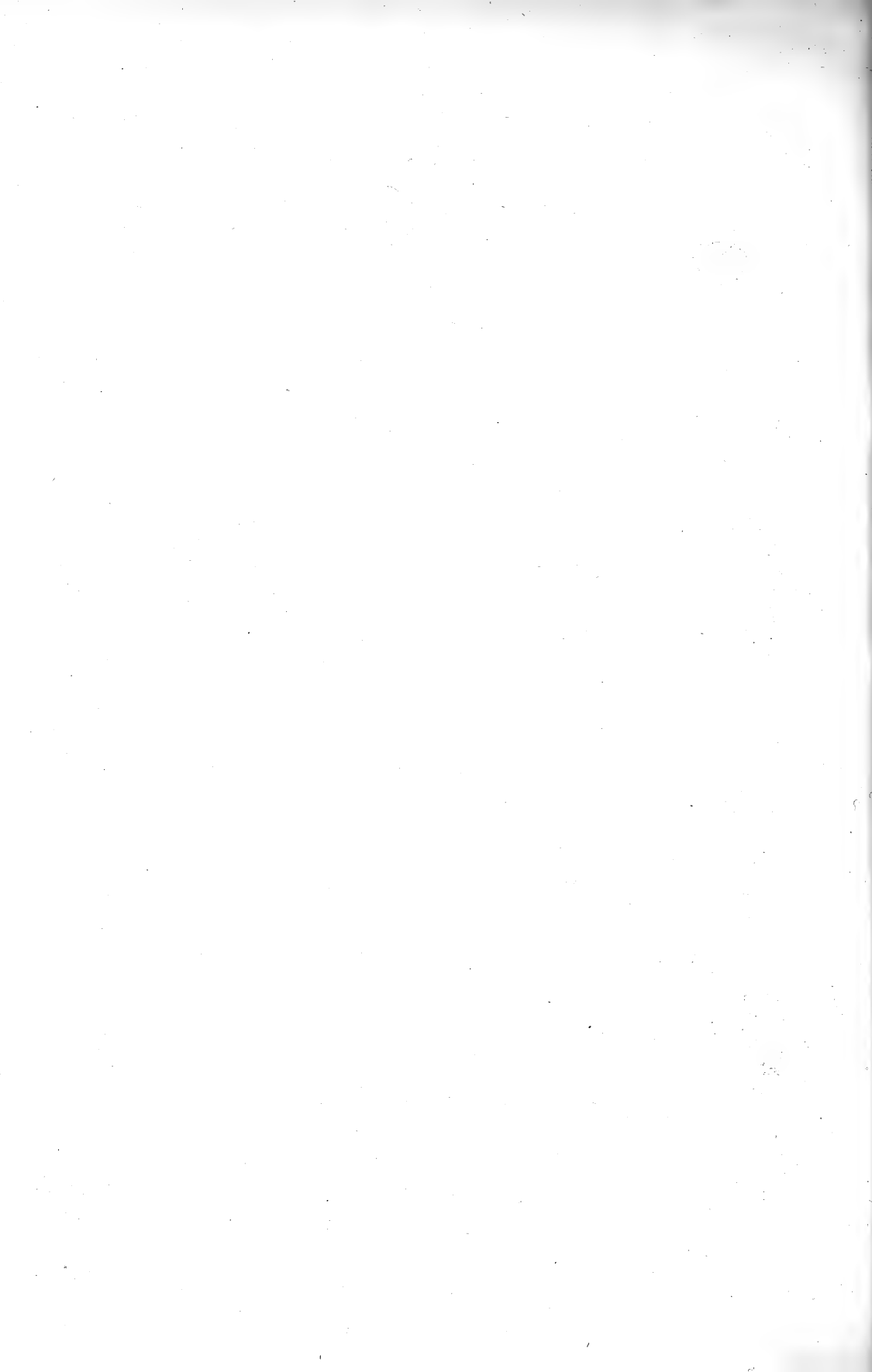





54.

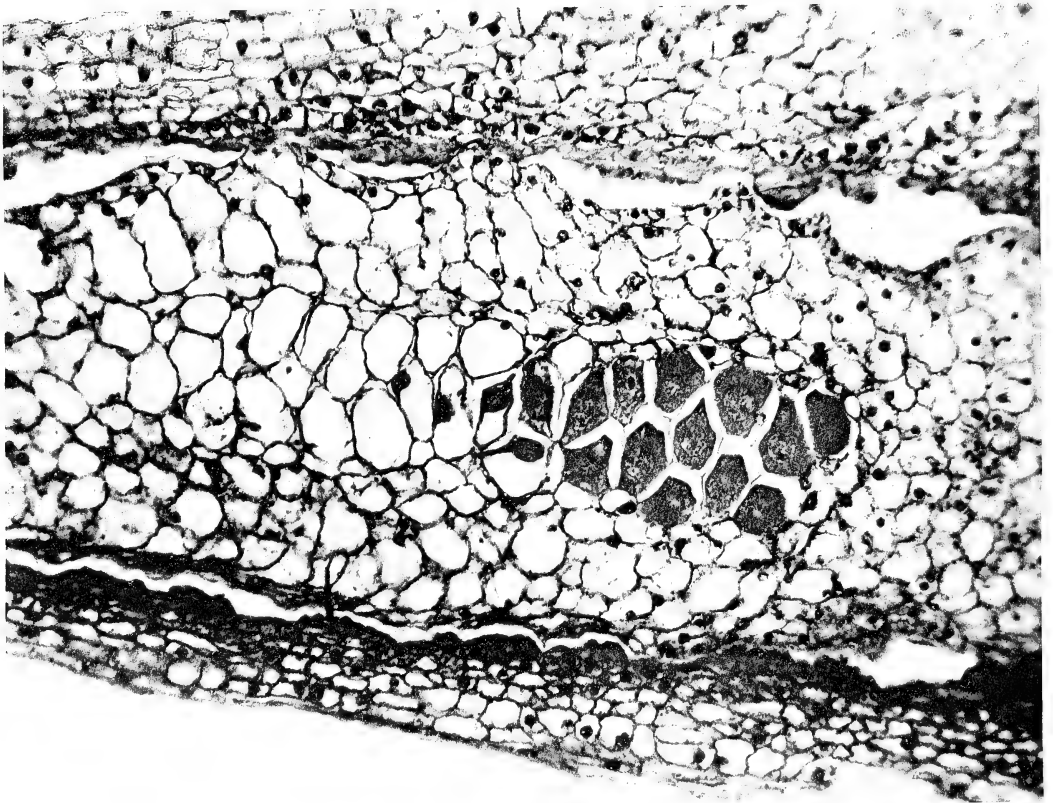

53.

SAXTON — ACTINOSTROBUS.

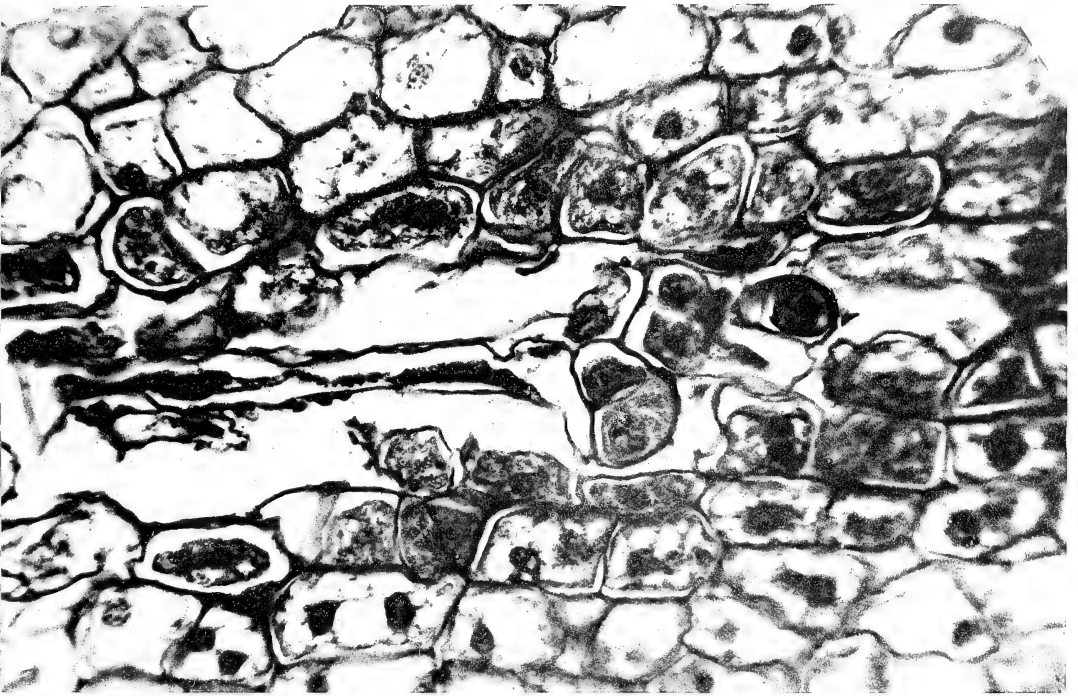

55.

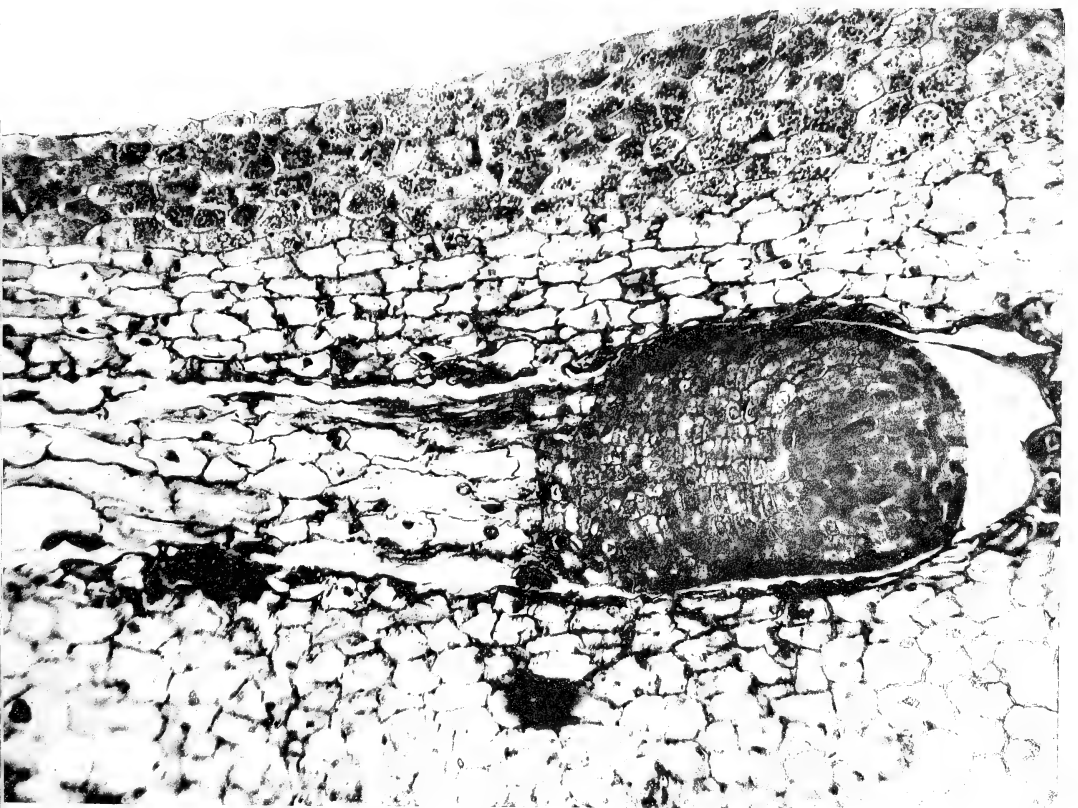

56.





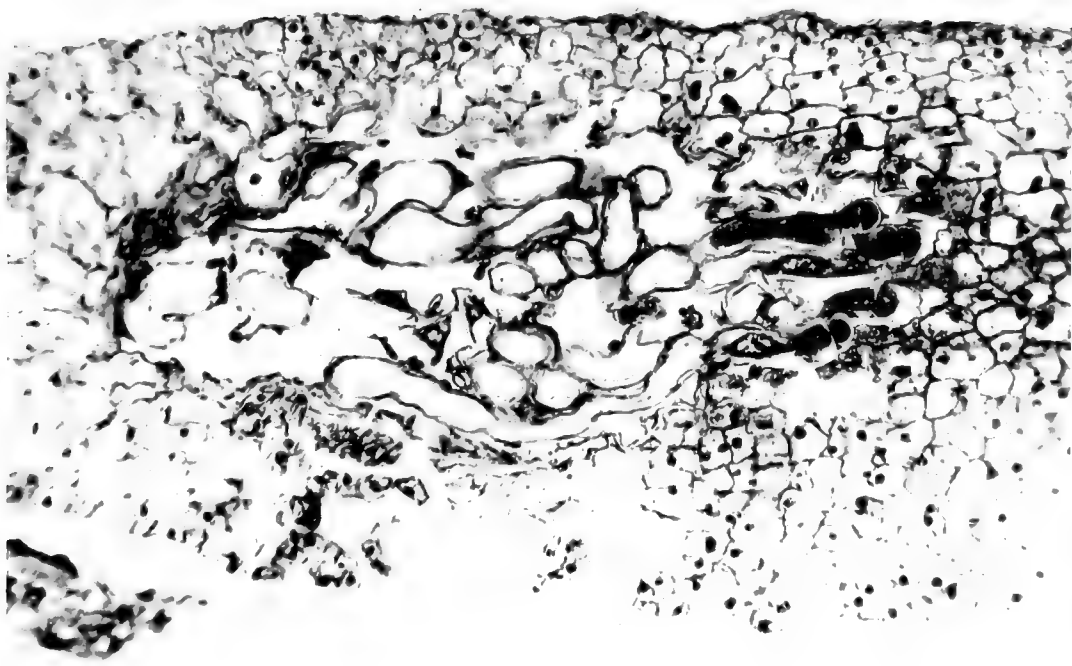

54.

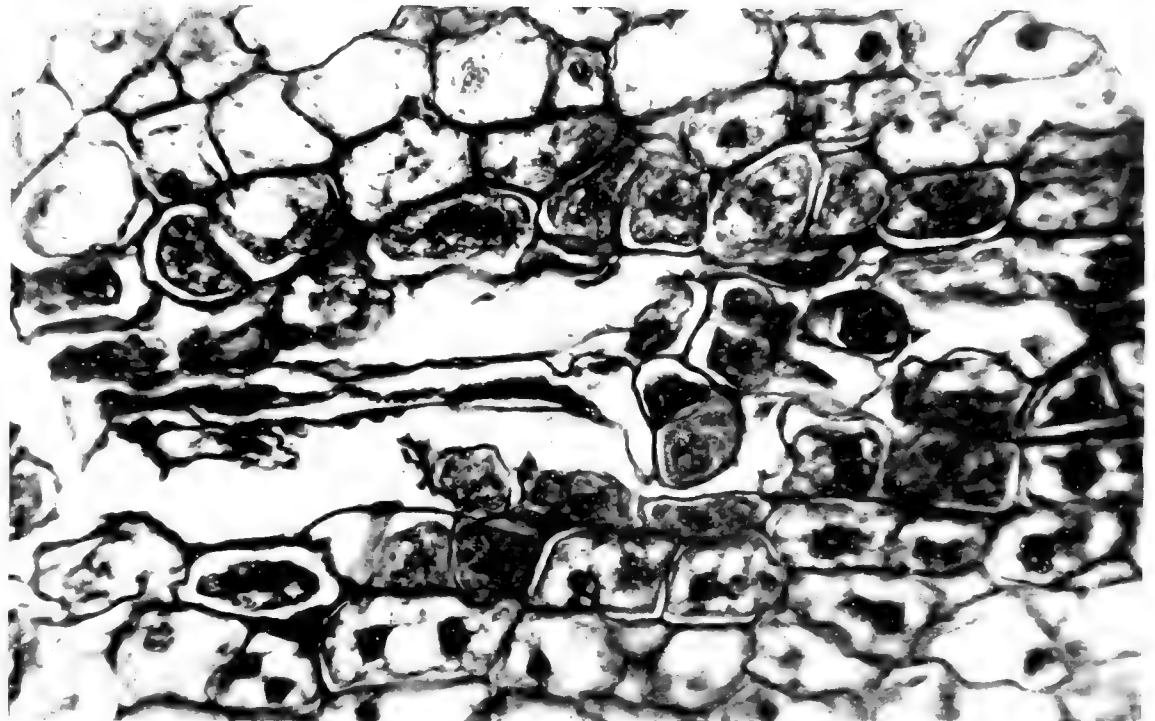

55.

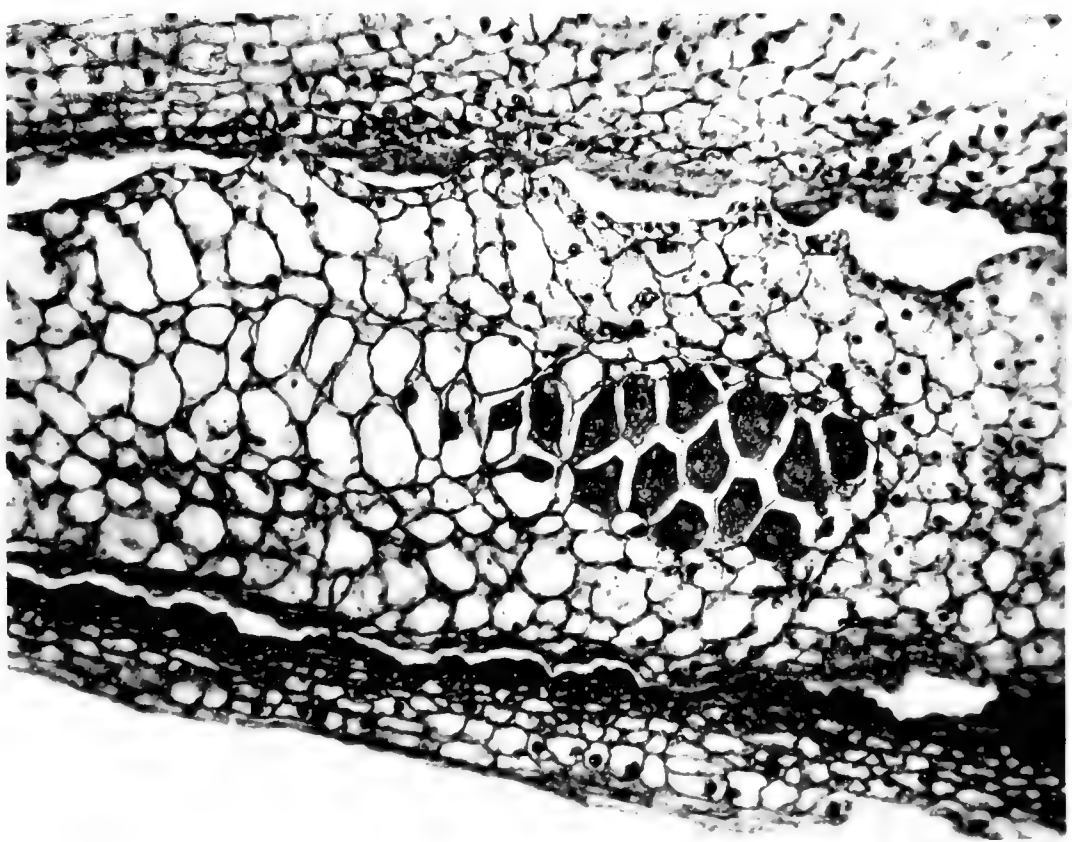
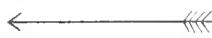

53.

SAXTON — ACTINOSTROBUS.

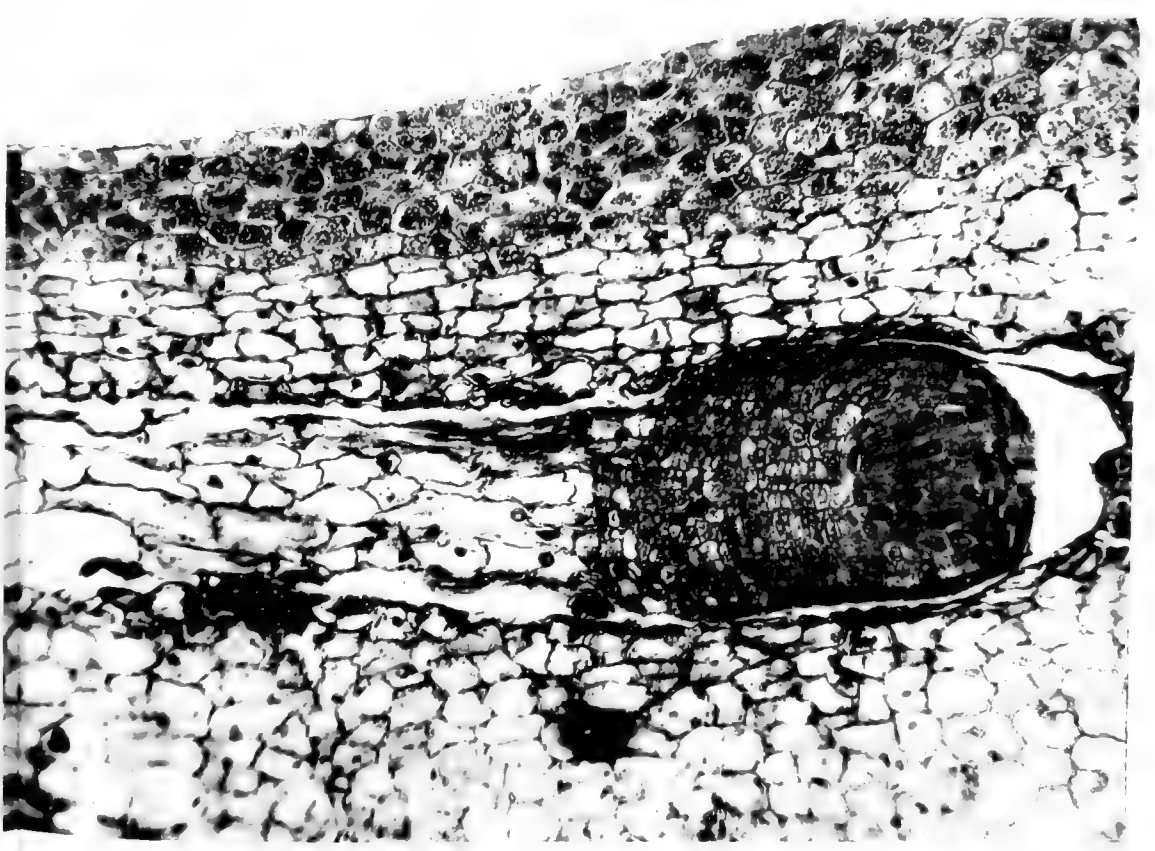

56.

Huth. coll.



# Some Points in the Anatomy of the Leaf of *Welwitschia mirabilis*.

BY

H. TAKEDA.

With Plate XXIX and five Figures in the Text.

SINCE the publication of Hooker's elaborate monograph (8), internal features of this singular plant have already been investigated by various botanists, such as de Bary (4), Bertrand (1), Strasburger (17, 18), and Bower (2, 3). Quite recently Miss Sykes (now Mrs. Thoday) has made contributions to our previous knowledge in two papers (19, 20), in which she refers to the publications of the previous workers. It seems to me, however, that there are still some interesting anatomical features left undescribed, and also certain points requiring a thorough examination.

The material of the adult leaf used for my study was dried. It was boiled in water for a short time and then soaked in spirit, and it shows the structure wonderfully well preserved. The whole leaf is 60 cm. in length and deeply cut into strips about 2 cm. in breadth. These strips are inserted on a stem 10 cm. in height, 17 cm. in the longer diameter, with much-branched roots. The cotyledon and young leaf of seedlings which were raised by Mr. Hales of Chelsea Physic Garden were also examined for comparison. One of the seedlings was about three weeks old and bore two cotyledons nearly 3 cm. in length, and  $5\frac{1}{2}$  mm. in breadth. In this stage the leaves had not yet developed, but showed themselves as small projections at the apex of the hypocotyl between the connate bases of the cotyledons. The other seedling was about seven months old, and had developed young leaves about 6 cm. long.

Sections were cut by hand or microtome in three directions: transverse, horizontal (parallel to the surface of the leaf), and longitudinal (radial to the vascular bundle). Certain elements of tissue were macerated out by means of Schultze's macerating fluid. Various kinds of reagents and simple as well as combination stains were used. Some sections were mounted for permanent preparations in Canada balsam, or in glycerine-jelly either coloured or uncoloured.

**The Nervation.** The nervation of the leaf is a simple sort of 'nervatio

Goniopteridis', which becomes more or less irregular owing to the aberrant path of the lateral transverse branches or veins, as already described by de Bary (4, p. 303) and Sykes (19, p. 181). One point to note here is that the short branch given off from the transverse branches is always directed towards the apex, and never towards the base of the leaf!

The cotyledon is elliptical-ob lanceolate and connate at the base, and shows a similar kind of nervation in a looser and more or less irregular manner. Two bundles enter each cotyledon, and traverse the latter straight up to the apex, taking a parallel course. At the very base of the cotyledon, which is connate and forms a very short tube, each of these two bundles gives off a lateral bundle; this again divides, a little further up, into two. Thus there are six main bundles present in the cotyledon: two central, two lateral, and two marginal ones. The 'marginal' bundles are much weaker than the rest and die away about midway of the whole length of the cotyledon, while the 'lateral' bundles also do not really reach the apex. The veins are much more irregular and more oblique than in the adult leaf. These veins anastomose or end blindly, just as in the foliage leaf (Pl. XXIX, Fig. 1).

The nervation with three pairs of bundles derived from the double leaf-trace seems to me to be the phylogenetically primary one, and this design is also found in the young leaf.

It has been stated both by Bower (2, p. 19) and by Hill and de Fraine (7, p. 323) that four bundles enter the cotyledon. They seem to have not noticed the real base of the cotyledon and taken the connate portion of the cotyledon for a structure belonging to the hypocotyl.

The nervation of the young leaf of my material shows a very interesting feature. In the portion about 3 cm. in distance from the apex the nervation is practically the same as in the cotyledon, i. e. it shows six main bundles and very oblique veins (cf. Fig. 1). However, a difference is to be noticed, inasmuch as the 'marginal' and 'lateral' bundles do not directly fuse with the 'central' ones, but are only connected, transversely, by the veins.<sup>1</sup> Further downwards there are to be seen new bundles of different lengths running parallel to the long axis of the leaf. These lie between the three pairs of bundles above noted, as already described by Bower (3, p. 586). Thus a direct connexion between the central pair of bundles and the 'lateral' + 'marginal' ones on either side, as a result of branching, such as we see in the case of the cotyledon, does not exist. This is brought about by the new bundles of secondary origin. The central pair of bundles, therefore, only form the direct continuation of the hypocotyledonary bundles; all the others are connected together by the plexus of vascular bundles in the 'crown', which are differentiated later (cf. 3, p. 585 et seq.).

<sup>1</sup> For the section of this stage cf. Bower (3), Pl. XXXII, Fig. 7. My 'marginal' and 'lateral' bundles correspond to his 'secondary vascular bundles'.

The constant addition of new bundles at the base of the adult leaf is the peculiarity of *Welwitschia*, which is not known anywhere else. The phylogenetically primary design of the nervation is somewhat blurred in the young leaf, and is completely obliterated in the adult leaf, but it is well retained in the cotyledon.

**The Epidermis.** The epidermal cell is practically prismatic, with a thin inner wall and very much thickened outer wall (Figs. 3, 6). The cell-lumen is very much narrowed towards the outer side of the cell, owing to the enormous thickening of the lateral walls. Two layers can be distinguished in the outer wall: a cuticularized layer and a non-cutinized layer. The cuticularized layer contains a considerable amount of minute crystals and granules of calcium oxalate. The non-cutinized layer chiefly consists of cellulose and does not react to phloroglucin. The middle lamella of the partition-wall between two epidermal cells is very conspicuous. The cuticle is not very thick and measures about  $2.5\mu$  in the thickest part, and is far thinner on the guard cell.

The description and figure of the epidermis given by Sykes (19, p. 180) differ surprisingly from my own. One of the most striking things is that the outermost layer, which should be nothing else but cuticle, is said to come down at the corner of the cells through the middle (cuticularized) layer and touches the cellulose wall. This should be the middle lamella of the partition-wall between two contiguous epidermal cells. It might appear as if it were a projection of the cuticle, but it is not a continuation of the latter at all. I was also at a loss to understand the misty covering of the epidermal cells delineated in her Fig. 3. It seems to me that it may represent a portion of the outer wall of other epidermal cells lying in the lower level of focus, since there is no superficial layer of wax or anything of that sort.

The epidermal cells of the cotyledon more or less differ from those of the leaf. In surface view they are rather irregular, and are elongated longitudinally. The size of each cell is larger than in the adult foliage leaf. In transverse section (Fig. 5) each cell appears broader than high. In my material there is no evidence of a cuticularized layer; the outer wall consists chiefly of cellulose, and is very much thicker than the other, and shows the middle lamella above referred to clearly. The thin cuticle covers the whole surface.

The epidermal cells of the young leaf are of irregular shape and larger size than those of the adult leaf, just as in the cotyledon. But when the development of the bundles of secondary origin begins, then the epidermal cells show a tendency to assume a more regular shape, and their size becomes smaller than that of those near the apex; this probably shows the beginning of the secondary structure of the leaf.

Two layers, cellulose and cuticularized, are already differentiated in

the outer wall of the epidermal cell of the young leaf, in the latter of which are deposited minute granules of calcium oxalate.

**The Stoma.** Stomata are present on both surfaces of the leaf, and are situated in parallel rows, and in general are longitudinally orientated, as in most of the Conifers (Fig. 4). In the cotyledon they are arranged rather irregularly, and are orientated sometimes obliquely, but in rare cases even transversely (Text-fig. 1). I have also noticed in the cotyledon an immature stage of a 'twin-stoma' (Text-fig. 2).

In the adult leaf the subsidiary cells are much shorter than the surrounding epidermal cells and lie over the guard cells, so that very little of the latter is visible in surface view (Figs. 3, 4). In the three-week-old cotyledon

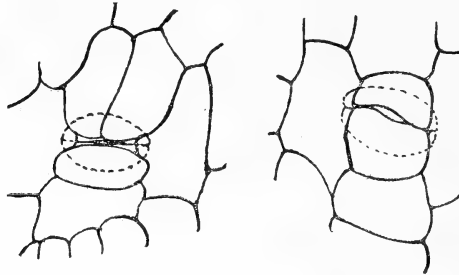

TEXT-FIG. 1. Transversely orientated stomata from cotyledon.  $\times 285$ .

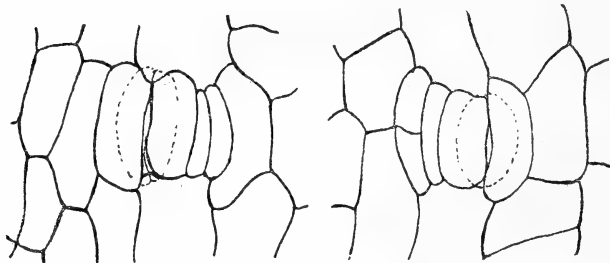

TEXT-FIG. 2. Immature stage of 'twin stomata' from cotyledon.  $\times 285$ .

and in the six-month-old leaf the subsidiary cells are scarcely shorter than the surrounding epidermal cells, and are only inclined towards the stoma (Fig. 5).

The guard cells are of the usual type of somewhat kidney shape (Fig. 2). In the median transverse section the outer ridge shows itself relatively prominent, and the inner ridge is wanting, as in *Ephedra* (Fig. 3). The dorsal wall is very much thickened, except at the base. The thickening on both the dorsal and ventral side of the guard cell is due, not to cutinization, but to lignification, as in *Gnetum*, *Ephedra*, Cycads, and Psilotaceae. At the end portion of the stoma, where the guard cells meet each other, the wall is also lignified (Fig. 2). The structure of the guard cell of the

cotyledon and of the young leaf is much the same as that of the adult leaf, but the walls are less thickened. In my material of the cotyledon I have noticed that only the upper portion of the dorsal wall is lignified (Fig. 5).

The figures and descriptions of the stoma given by Sykes (19, p. 182, Pl. XVII, Figs. 2, 3) do not seem to be correct; her Fig. 2 only represents a section cut near the end portion of the stoma, 'M' in this figure being not the ventral wall of the guard cell. 'M' in her Fig. 3 is very puzzling, because, in fact, 'Z' in this figure corresponds to 'M' in Fig. 2.

The development of the stoma has been traced in the young leaf, and particularly in the cotyledon. An initial cell divides longitudinally into

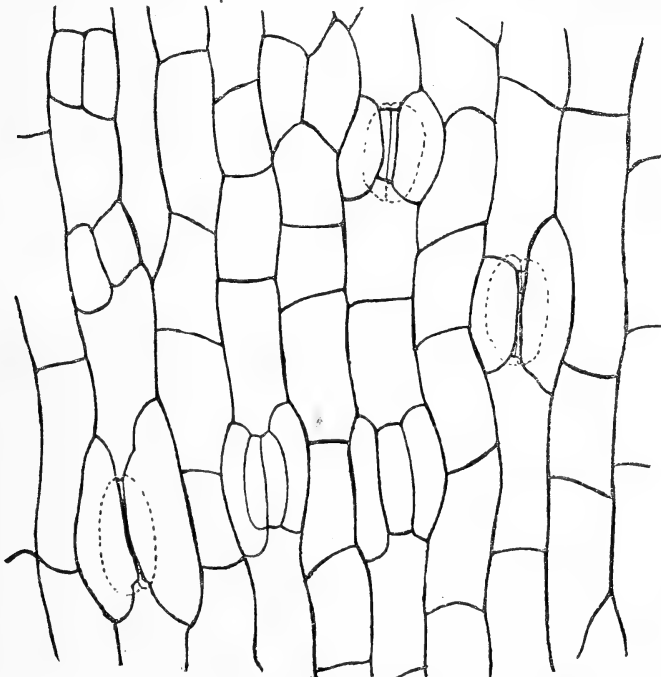

TEXT-FIG. 3. A portion of epidermis from cotyledon, showing successive stages in the development of the stoma.  $\times 285$ .

two. One of the daughter-cells again divides in the same way, so that there are three cells formed. The two lateral ones become subsidiary cells, while the central one will be the mother-cell of the stoma. The mother-cell divides longitudinally and forms the two guard cells. Thus a stoma with two parallel subsidiary cells is formed from one single initial cell. This is the simplest and probably the typical case (Text-fig. 3). One or both of the subsidiary cells may further divide transversely, longitudinally, or sometimes obliquely (Fig. 4, Text-fig. 4).

It has been observed occasionally that in the three-celled stage, which is the result of two successive divisions of the initial cell, a lateral cell,

instead of the central one, becomes a stoma-mother-cell; then, although four cells will be formed by the last division, a cell belonging to the next row, which bordered this mother-cell, will function in the place of subsidiary cell (cf. Text-figs. 1, 2). It seems to me that, at any rate in the cotyledon, occasionally even such an abnormality occurs as one of the cells of the two-celled stage directly becoming a stoma-mother-cell, while only three cells are cut off from the initial cell, one of which will become a subsidiary cell (Text-fig. 5).

**The Mesophyll.** This tissue of the adult leaf has been thoroughly described and figured by Hooker (8). In the cotyledon and the young leaf examined by me the palisade tissue is feebly differentiated, consisting of two layers of cells on the upper surface and of one layer on the other. Amongst these cells, or sometimes directly under the epidermis, one often finds cells with very scanty contents. A group of those cells also occurs on the margin of the cotyledon as well as of the young leaf. These are

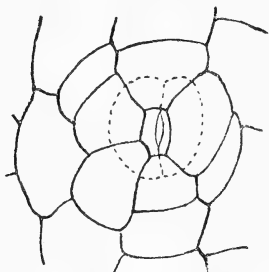

TEXT-FIG. 4. A stoma from cotyledon, showing much divided subsidiary cells.  $\times 285$ .

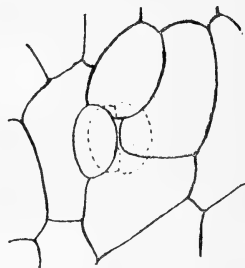

TEXT-FIG. 5. An abnormal stoma from cotyledon.  $\times 285$ .

the cells which will later be converted into sclerenchymatous fibres (cf. Fig. 9). This can be particularly well traced in the young leaf.

The centre of the leaf is occupied by thin-walled parenchymatous cells with intercellular spaces. They are isodiametric in shape, or more or less elongated longitudinally, and locally pitted. These and the palisade cells are full of protoplasm with chloroplasts, and constitute chlorenchyma. Sykes (19, p. 181) assumes, without however giving any reason, that these cells function as water-storage organs. This assumption is, however, improbable, since the presence of the chloroplasts and intercellular spaces, as described above, does not admit of such a supposition.

In the adult leaf minute crystals of calcium oxalate occur in these isodiametric cells as well as in some of the palisade tissue bordering the former. The crystals are deposited on the cell-wall, but never in the cell-lumen.



**The Spicular Cell.** There is no need of describing in great detail the well-known spicular cell. One can distinguish two layers of wall: an outer comparatively thin and lignified wall, and an inner thick and un-lignified one; crystals of calcium oxalate are embedded in the former. Miss Sykes, however, in her description reversed the actual order. Her error seems to be due to a misunderstanding of Bower's correct statement: 'As the cell increases in size the cell-wall becomes differentiated into an outer cellulose wall and an inner lignified wall' (3, p. 590). What he means by 'outer cellulose wall' here is evidently nothing else but the middle lamella of the wall, from the inner layers of which the 'spicular cell' becomes differentiated (cf. 3, Pl. XXXIII, Fig. 17).

I have not observed any spicular cell in the cotyledons of my material.

**The Vascular Bundle.** The vascular bundle of the adult leaf has already been fairly well described by Hooker (8), de Bary (4), Bertrand (1), and Sykes (19). The xylem elements are radially arranged, and are interspersed with parenchymatous cells (Fig. 7). The metaxylem consists of dense spiral or reticulate tracheides, with bordered pits at intervals on their radial and tangential walls. The secondary xylem consists chiefly of tracheides, generally with uniseriate bordered pits, and of a few tracheae with multiseriate bordered pits with transversely elongated orifice (I use the terms 'trachea', 'tracheide', and 'vessel' as proposed by Rothert (cf. 12, p. 16), simply because it is more intelligible than de Bary's usage). The tracheae are of the Gnetaceous character, viz. the perforation is incomplete, and are perforated with one or occasionally two simple large round, or more or less irregular pits.

The xylem-parenchyma is un-lignified and never appears as a continuous ray in a transverse section. The cells are of the same height, and are never straight, but their walls are always more or less irregularly curved, and they give off short projections in the radial direction which come into contact with those of the neighbouring cells (Fig. 10).

The sieve-tube is much elongated and possesses an oblique end-wall. The sieve-plates are of the Gymnospermic type, and are present not only on the sloping wall, but also on the vertical wall of both the radial and tangential sides, as in *Cycas*, *Dammara*, and *Ginkgo*. They occur between two sieve-tubes as well as on the wall which abuts on the phloem-parenchyma (Fig. 11).

The phloem-parenchyma is disposed radially, and the cells are vertically elongated and are nearly uniform in height.

The transverse branch of the bundle has a similar structure to that of the main bundle on a much smaller scale. The xylem is composed chiefly of tracheides with reticulate thickening, with bordered pits at intervals. These connect with the metaxylem of the main bundle. Neither spiral

nor annular vessels have been observed. The xylem-parenchyma is exceedingly scanty. There are no sclerenchymatous fibres present.

The structure of the vascular bundles of the cotyledon (Fig. 9) and of the young leaf hardly differs in essential points from that of the adult leaf. The xylem consists of annular and spiral tracheides of protoxylem, and of dense spiral and reticulate tracheides with scattered bordered pits. A few unligified fibres occur on the phloem side (Fig. 9, *scl. f.*). In the mature part of the young leaf these fibres also occur on the xylem side.

**The 'Transfusion-tissue'.** This tissue is remarkably well developed in the leaf of *Welwitschia*, and has been described and figured by Hooker (7, p. 19, Pl. IV), de Bary (4, pp. 335, 382, Fig. 157), Bertrand (1, p. 16, Pl. II, Fig. 1), and Sykes (19, p. 182, Pl. XVII). I have here very little to add to de Bary's accurate and detailed description (4, p. 382). This tissue, which surrounds both the main bundles and veins, forms an almost complete sheath of tracheides of usually one or occasionally two layers. This tracheidal sheath is, in the case of the main bundle, usually separated from the vascular elements by either a layer of parenchyma on the side, or by a mass of sclerenchyma on the upper and lower side of the bundle. The cells lateral to the bundle are much narrower than the other; they are elongated and have reticulate thickening, while those above and below the bundle are much larger, nearly isodiametric, and have reticulate thickening or small bordered pits between meshes of the thickened bars (Fig. 7, *w. t.*). The degree of lignification of the cell-wall is, so far as the reaction of phloroglucin shows, less than in the xylem elements of the bundle, as Zimmermann (23, p. 7) observed in certain Conifers.

In my material of the three-week-old cotyledon and of the six-month-old leaf I have noticed some elements of the 'transfusion-tissue' have made their appearance on the lateral side of the larger bundles. Particularly towards the apex of the young leaf the 'transfusion-tracheides' are fairly abundant (cf. 19, p. 182). They are usually separated from the bundle by a layer of parenchymatous cells, or occasionally join the xylem. Sykes states (19, p. 214) that the first-formed elements arise on the phloem side of the bundle, but this is not the case with my material. The shape of the first-formed elements is more or less elongated in the direction parallel to the bundle. The membrane is lignified and possesses reticulate bars (Fig. 8, also cf. Fig. 9).

I have dealt with the significance of this tissue in general in a special paper (21).

**The Mucilage Canal.** In the adult leaf one often notices the presence of mucilage canals. These occur between bundles, and always on the phloem side. They are round in transverse section and comparatively short, varying from a few millimetres to as much as 1 cm. or more, and they run parallel

to the long axis of the leaf. They arise lysigenously owing to deliquescence of certain mesophyll cells. Similar mucilage canals occur in all parts of plants, except in a very young seedling. According to Hooker (9, p. 12), even spicular cells are sometimes included in the contents of the canal.

#### GENERAL CONCLUSIONS AND SUMMARY.

It would not be advisable to draw phylogenetic conclusions from the anatomy of the leaf only. Yet there are not a few important points which exhibit the typical Gymnospermic characters, and especially show a close relationship to other members of the Gnetales.

The paired bundles in the cotyledon, the leaf (here the primary bundles alone should be taken into account), and in the bracts,<sup>1</sup> which are derived from the 'double leaf-trace', are worthy of notice. The paired bundles are to be seen in the leaf and bract of *Ephedra*, whereas in *Gnetum* this point is of more Angiospermic character.

The leaves are always opposite and decussate in these three genera, although tricyclic leaves sometimes occur in *Ephedra*.

Cyclic leaves are not known in any other group of Gymnosperms except in Cupressineae and in Araucarineae (*Dammara*).

It has been pointed out that the base of the cotyledons in *Welwitschia* is connate. The connate leaf-base is to be seen in the leaves and bracts of these three genera. In *Gnetum* the leaves are very slightly connate, so that this character is not clearly comprehended in an older stage.

The structure of the stoma is also on the whole similar in all these genera. The development of the stoma is very much the same in *Welwitschia* and in *Gnetum* (22).

The hypodermal sclerenchyma with unligified wall is present in these three genera.

One of the interesting features is the occurrence of crystals and granules of calcium oxalate in the cell-wall of various parts of the plant, such as the epidermis (16, p. 541; 4, p. 102) and mesophyll (16, p. 521; 4, pp. 141, 335) of the leaf, in the spicular cell (16, p. 527; 4, p. 133), in the epidermis (1, p. 14) and parenchyma (16, p. 521) of the stem, and in the soft tissue of the root. This character prevails in Conifers<sup>2</sup> and very seldom occurs

<sup>1</sup> A detailed account of morphology of the bracts will be dealt with in a special paper.

<sup>2</sup> I have observed myself this phenomenon in various parts of the following plants: 1. Spicular cells with crystals in *Araucaria imbricata* (leaf and pith), *Acropyle Pancheri*, *Dammara australis*, *Fokienia Hodginsii*, *Sciadopitys verticillata* (leaf), *Torreya californica* and *T. taxifolia* (cortex). 2. Crystals deposited in the cortex (in the widest sense) of *Araucaria imbricata*, *Callitris rhomboidea*, *Fitzroya patagonica*, *Juniperus communis*, *Libocedrus decurrens*, *Saxe-Gothaea conspicua*, *Sciadopitys verticillata*, *Taxus baccata*, *Thuja* sp., *Torreya californica*, *T. taxifolia*, *Wellingtonia gigantea*, and *Widdringtonia cupressoides* (also cf. 16). 3. In pith of *Araucaria imbricata*, *Saxe-Gothaea conspicua*, and *Torreya californica*. 4. In the outer wall of the epidermis of certain species of the following twenty-nine genera: *Abies*, *Acropyle*, *Actinostrobus*, *Athrotaxis*, *Callitris*, *Cedrus*, *Cephalotaxus*, *Cryptomeria*, *Cunninghamia*, *Cupressus*, *Dammara*, *Fitzroya*, *Fokienia*, *Glyptostrobus*, *Juniperus*, *Libocedrus*, *Phyllocladus*, *Picea*, *Pinus*, *Prumnopitys*, *Pseudotsuga*, *Sequoia*, *Sciadopitys*, *Taivania*, *Taxodium*, *Taxus*, *Tetraclinis*, *Tsuga*, and *Widdringtonia*. 5. In chlorenchyma of all known coniferous genera except *Larix* and *Pseudolarix*, where I have failed to detect any trace of this substance, probably being due to my material.

in Angiosperms (13, p. 1107; 11, p. 98, tab. 3, Figs. 1-3; cf. also 13, p. 2). It is also interesting to notice that in *Ephedra* this mineral salt occurs in the cell-wall, while in *Gnetum*, *Ginkgo*, *Ceratozamia*, *Cycas*, *Dioon*, *Encephalartos*, and *Zamia*, it is deposited in the cell-lumen as clustered crystals.

The phloem is of the Gymnospermic type, the companion cell being absent.

The presence of tracheae seems somewhat to enfeeble our view of regarding these three genera as Gymnosperms, yet the perforation is not typical Angiospermic, but incomplete, showing only transition. Another interesting point is that the mode of the development of the bordered pits in Gnetales is of the type predominant in Conifers (on this subject another paper is in view).

From the facts here mentioned I consider *Welwitschia* and all other members of Gnetales as Gymnosperms, and cannot agree with the hypotheses recently put forward by Hallier (5, 6) and Lignier and Tison (9, 10). I am also not in favour of the hypothesis that the Gnetales have a closer relationship to the Cycadales than to the Coniferales. As far as the anatomical features are concerned, *Welwitschia* is more closely related to *Ephedra* than to *Gnetum*.

In conclusion I express my hearty thanks to Professor Farmer for his kind criticism.

---

#### BIBLIOGRAPHY.

1. BERTRAND, C. E. : Anatomie des Gnétacées et des Conifères. Ann. Sc. Nat., Bot., sér. 5, xx, 1875.
2. BOWER, F. O. : On the Germination and Histology of the Seedling of *Welwitschia mirabilis*. Quart. Journ. Micr. Sc., xxi, 1881.
3. ——— : On the Further Development of *Welwitschia mirabilis*. Ibid.
4. DE BARY, A. : Comparative Anatomy of Phanerogams and Ferns. Engl. Trans., 1884.
5. HALLIER, H. : Provisional Scheme of the Natural System of Flowering Plants. New Phytologist, iv, 1905.
6. ——— : Ein zweiter Entwurf des natürlichen Systems der Blütenpflanzen. Ber. d. D. Bot. Gesellch., 1905.
7. HILL, T. G., and DE FRAINE, E. : On the Seedling Structure of Gymnosperms, IV. Ann. Bot., xxiv, 1910.
8. HOOKER, J. D. : On *Welwitschia* : a New Genus of Gnetaceae. Trans. Linn. Soc. London, Bot., xxiv, 1863.
9. LIGNIER, O., et TISON, A. : Les Gnétales sont des Angiospermes apétales. Compt. Rend. Acad. Sci., cliii, 1911.
10. ——— : Les Gnétales. Ann. Sc. Nat., Bot., sér. 9, xvi, nos 1 à 3, 1912.
11. PFITZER, E. : Ueber die Einlagerung von Kalkoxalat-Krystallen in die pflanzliche Zellhaut. Flora, lv, 1872.
12. ROTHERT, W. : Ueber den Bau der Membran der pflanzlichen Gefässe. Bull. Acad. Sc. Cracovie, 1899.

13. ROTHERT, W.: Ueber die anatomischen Differenzen der Gattungen *Dracaena* und *Cordyline*. Bull. Dép. Agr. Ind. Néerland., No. 24, 1909.
14. SCHEIT, M.: Die Tracheidensäume der Blattbündel der Coniferen, etc. Jenaische Zeitsch. f. Naturwissenschaft, xvi, 1883.
15. SOLEREDER, H.: Systematic Anatomy of the Dicotyledons. Engl. Trans., 1908.
16. SOLMS-LAUBACH, GRAF ZU: Ueber einige geförnte Vorkommnisse oxalsäuren Kalkes in lebenden Zellmembranen. Bot. Zeitg., 1871.
17. STRASBURGER, E.: Die Coniferen und die Gnetaceen. 1872.
18. —————: Leitungsbahnen. 1891.
19. SYKES, M. G.: The Anatomy and Morphology of the Leaves and Inflorescences of *Welwitschia mirabilis*. Phil. Trans., cci, ser. B, 1910.
20. —————: The Anatomy of *Welwitschia mirabilis*, Hook. f., in the Seedling and Adult States. Trans. Linn. Soc. London, Bot., ser. 2, vii, 1910.
21. TAKEDA, H.: A Theory of 'Transfusion-tissue'. Ann. Bot. xxvii, 1913, p. 359.
22. —————: Development of the Stoma in *Gnetum Gneton*. Ibid., p. 365.
23. ZIMMERMANN, A.: Ueber das Transfusionsgewebe. Flora, lxxiii, 1880.

## EXPLANATION OF FIGURES IN PLATE XXIX.

Illustrating Mr. Takeda's paper on the Leaf Anatomy of *Welwitschia mirabilis*.

All figures were drawn with the aid of Abbé's drawing apparatus.

- Fig. 1. Cotyledon showing the nervation.  $\times 4\frac{1}{2}$ . *C.b.* = central bundle. *L.b.* = lateral bundle. *M.b.* = marginal bundle. *Conn.* = connate portion at the base.
- Fig. 2. Stoma in surface view. From a horizontal section cut at the level of the outer ridge of the guard cell.  $\times 450$ .
- Fig. 3. Epidermis of the under surface of the leaf. Stoma are cut at the median portion.  $\times 450$ . *C.* = cuticle. *C.l.* = cuticularized layer. *M.l.* = middle lamella. *C.w.* = cellulose wall. *Scl.f.* = sclerenchymatous fibre. *Spic.* = spicular cell. *Pal.* = palisade parenchyma.
- Fig. 4. Surface view of the epidermis of the under side of the leaf.  $\times 285$ .
- Fig. 5. A portion of a transverse section of the cotyledon (under surface).  $\times 450$ .
- Fig. 6. Longitudinal section of a stoma of the upper surface of the leaf.  $\times 450$ . Lettering is same as in Fig. 3.
- Fig. 7. Transverse section of a vascular bundle of the leaf.  $\times 285$ . *Pr.x.* = protoxylem. *W.t.* = water-storing tracheides. *X.p.* = xylem parenchyma.
- Fig. 8. Water-storing tracheides of the cotyledon. From a longitudinal section; compare with Fig. 9.  $\times 500$ . *Chl.* = chlorophyll-containing cell.
- Fig. 9. Transverse section of the main bundle of the cotyledon.  $\times 450$ . *Pr.x.* = protoxylem. *Pr.ph.* = protophloem. *Scl.f.* = sclerenchymatous fibre. *W.t.* = water-storing tracheide.
- Fig. 10. Portion of the xylem-parenchyma. From a longitudinal section of the leaf; compare with Fig. 7, *X.p.*  $\times 285$ .
- Fig. 11. Portion of sieve-tubes and phloem-parenchyma. From a horizontal section of the leaf.  $\times 500$ .
- Fig. 12. A portion of a longitudinal section of vessels.  $\times 450$ .





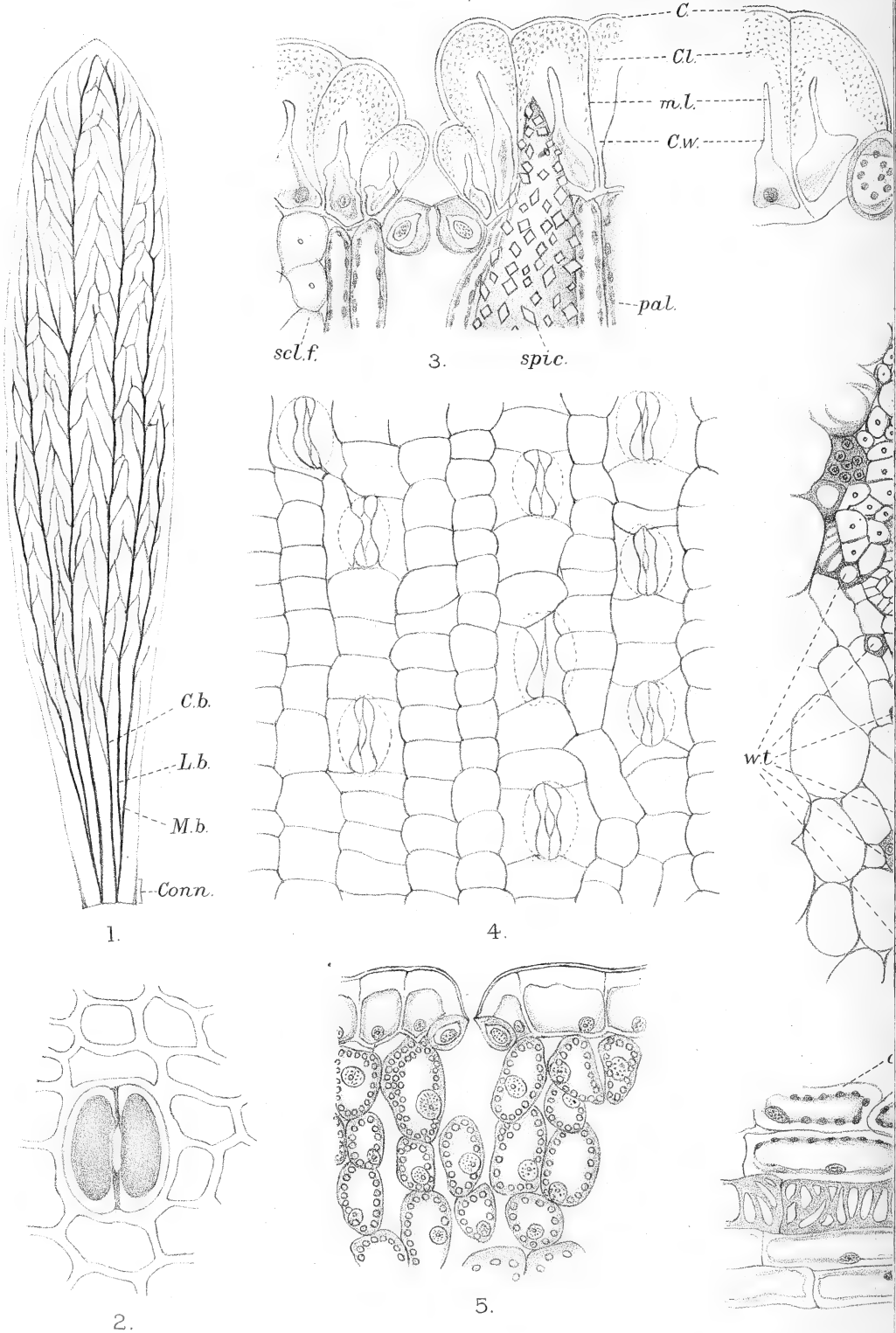



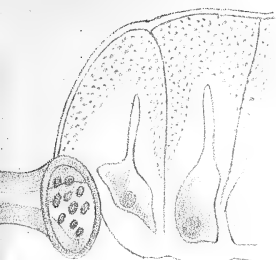

6.

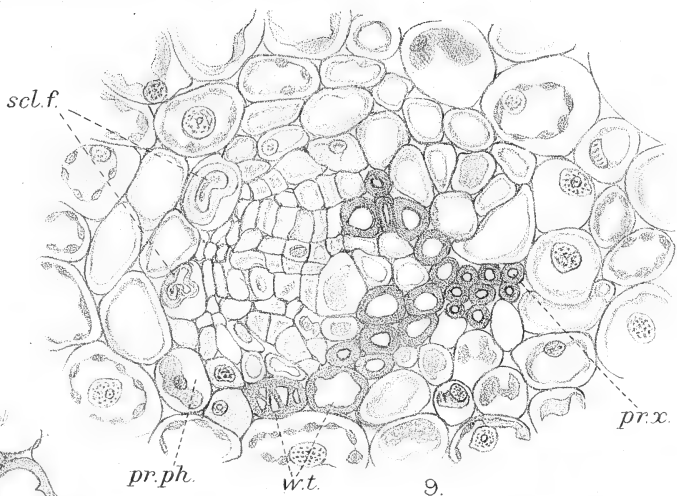

9.

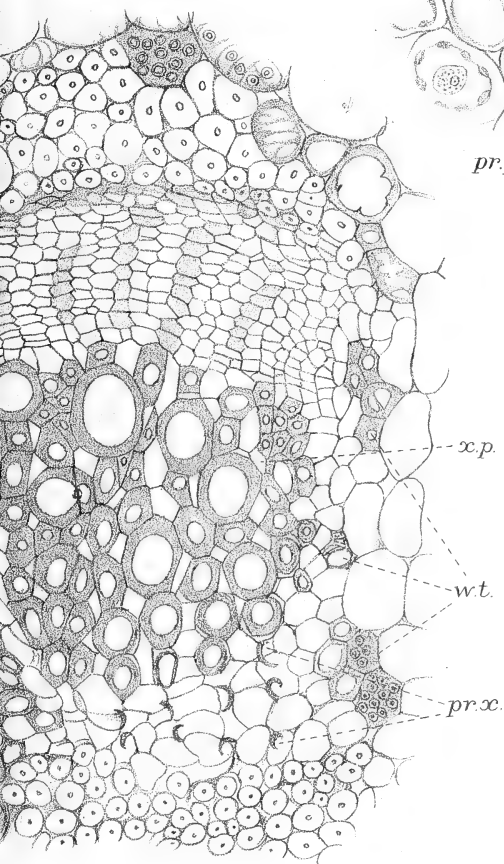

7.



10.

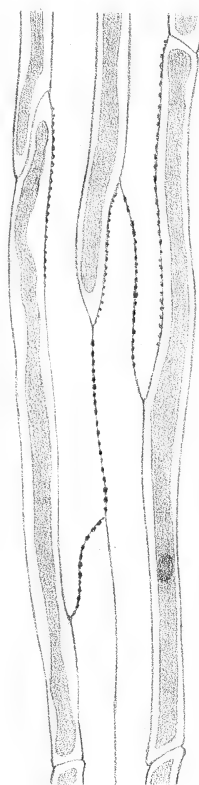

11.

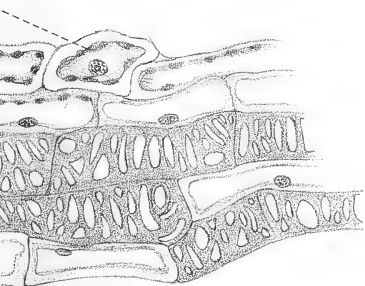

8.

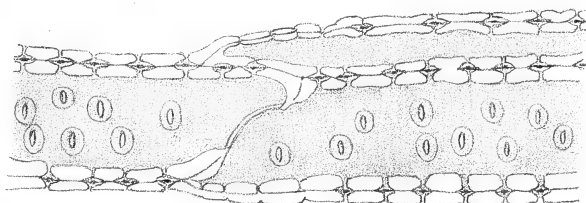

12.



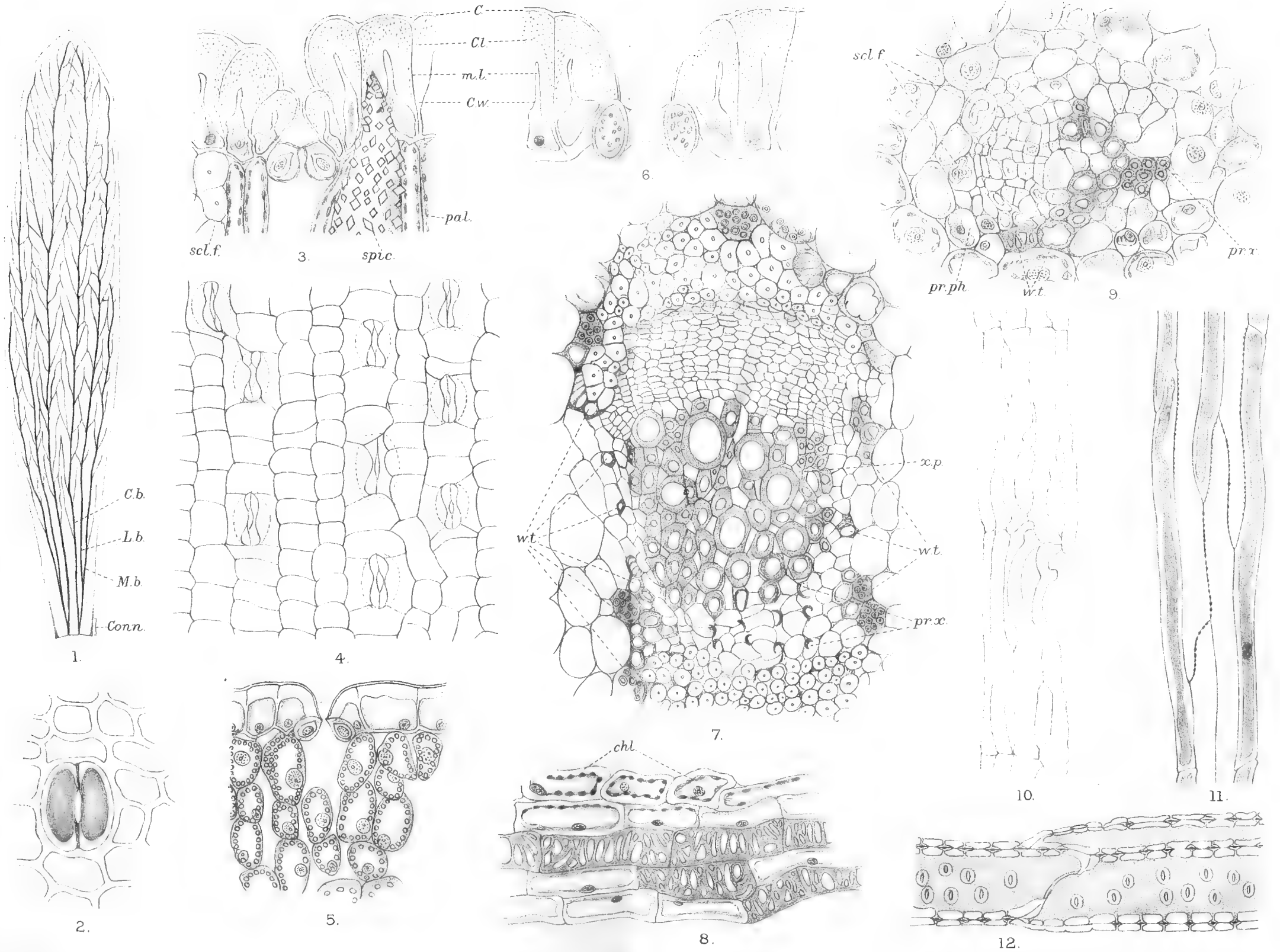

TAKEDA.—WELWITSCHIA.

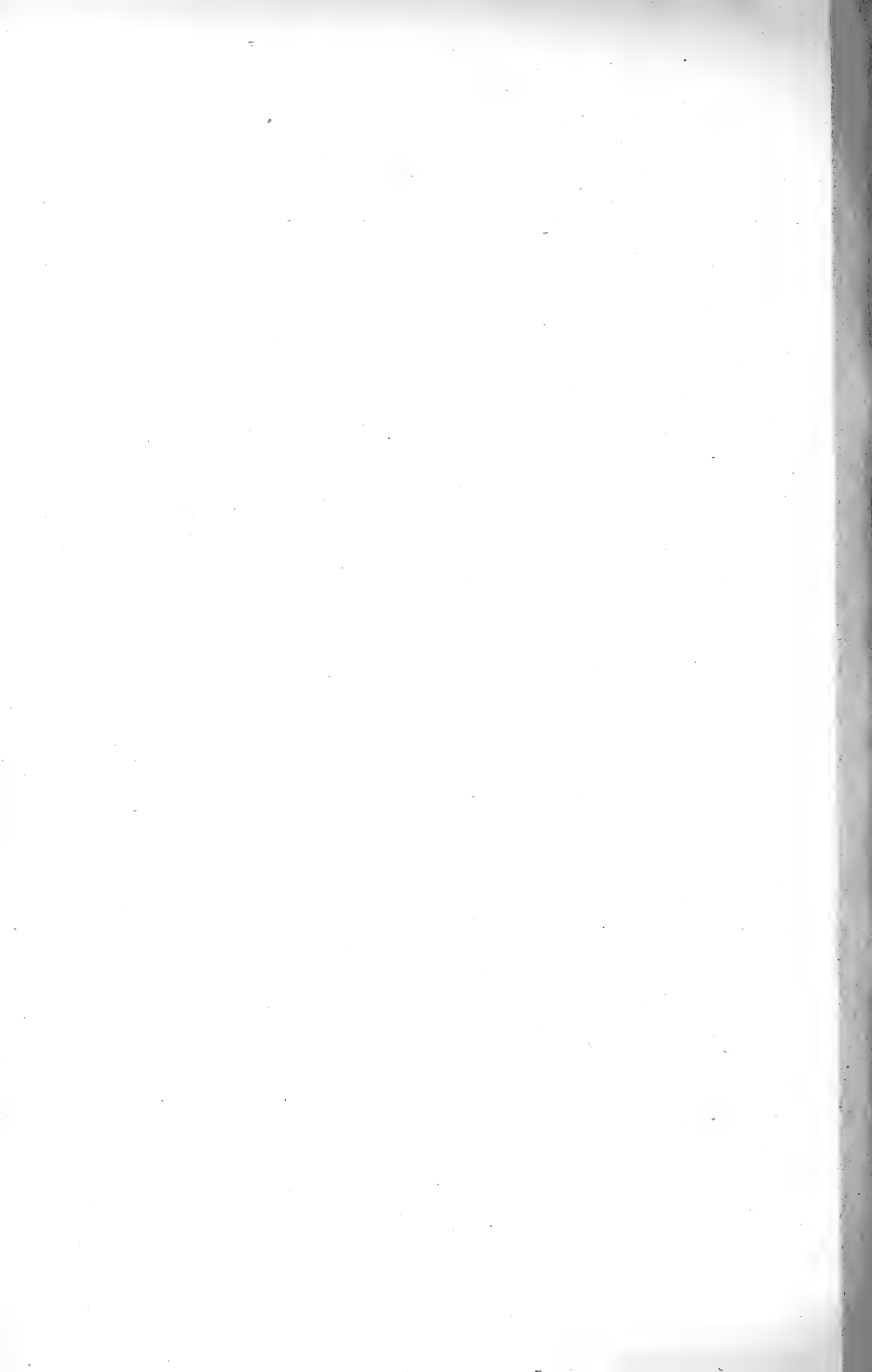

## A Theory of 'Transfusion-tissue'.

BY

H. TAKEDA.

THE 'transfusion-tissue', first described by Frank (4, p. 167, Taf. iv), afterwards named and more emphasized by von Mohl (7, p. 10), and more recently thoroughly investigated by Worsdell (14), has been stated by the last-named author to 'have been phylogenetically derived from the centripetally formed xylem of the vascular bundle' and to serve 'as an auxiliary conducting-system' (14, p. 318), a view which has been more fully elaborated by Bernard (1), and seems to be universally accepted by modern eminent botanists.

In an interesting paper recently published, Miss Carter (3) shows that in the cotyledon of certain Conifers examined by her, the first-formed elements of this tissue always arise on the lateral side of the bundle, but not, even where centripetal xylem is present, on the adaxial side of the bundle. This fact well corresponds to the case which I have described in the cotyledon of *Welwitschia mirabilis* (13, p. 354). It is well known that the vascular bundles in the adult leaf of this plant are completely surrounded by a sheath of 'transfusion-tracheides'. Development of these tracheides takes place at the lateral side of the vascular bundle, as it does in the case of the cotyledon, and later scattered elements appear on the xylem side or the phloem side, or both, without any intimate connexion, and afterwards a complete sheath of one or occasionally two layers of tracheides is formed (13). These 'transfusion-tracheides' are, in the main, parallel bundles, always separated by masses of unlignified sclerenchymatous fibres on the upper and lower sides of the bundle, for these fibres become differentiated very early, prior to the formation of the 'transfusion-tracheides', so that connexion between the xylem and 'transfusion-tissue', if at all, is only to be established on the lateral side of the vascular bundle.

The lateral origin of 'transfusion-tissue' was already described by Scheit (9, p. 628) thirty years ago in the adult leaves of the Conifers. It always starts on the lateral side of the vascular bundle and in the pericyclic region of that.<sup>1</sup> The tissue extends in general horizontally and forms wings,

<sup>1</sup> Scheit (l. c.) has attributed the elongated form of the first-made elements to the influence of stretching of the xylem. This is, however, probably due to the fact that these elements arise in the pericycle.

or is distributed more or less scattered round the bundle, and often even completely surrounds the latter, and occasionally comes into contact with the centripetal xylem, if any elements of this latter tissue are present at all. Worsdell (14, p. 316) maintains that the 'transfusion-tissue' is centripetally developed in the cotyledons of *Ginkgo* and *Cycas*. But in these cases centripetal xylem is considerably more developed than the centrifugal part, so that it obscures tracing the course of development. Recent researches on the Conifers by Miss Carter (3), and on *Welwitschia* by me (13), clearly show that there is no room for doubt that the tissue is first formed not centripetally but laterally. Worsdell (l. c., p. 318) also supports his hypothesis 'by the presence of the transfusion-tissue on the ventral side of the xylem', and 'by the very frequent extension of the lateral transfusion-tissue towards the ventral side of the bundle'. This seems to me to have no value as a support of his view of an intimate relation between the 'transfusion-tissue' and centripetal xylem, since this presence and extension is not a starting-point but a terminal portion of the tissue in question. It is true that in *Cycas* the 'transfusion-tissue' comes into contact with the centripetal xylem, which is rather to be expected, for in this case the centrifugal xylem is exceedingly feebly developed, and the function of the xylem is mostly carried out by the centripetal xylem. Connexion between 'transfusion-tissue' and xylem of the bundle is usually to be seen, even in *Welwitschia*, where the sheath of 'transfusion-tracheides' is generally separated from the vascular bundle, for one occasionally sees connexion on the lateral side. This does not favour the hypothesis that the tissue under consideration is a modification of centripetal xylem, for this connexion simply indicates the mutual function of these two tissues, which will be discussed later.

Before we pass on to a consideration of the function of 'transfusion-tissue', I will just remark here that most of the later-formed elements of this tissue owe their origin to the mesophyll-parenchyma, or, in case the vascular bundles are surrounded by an endodermis, to pericyclic cells, which we can clearly see by comparing the size, shape, and position of 'transfusion-tracheides' with the adjacent cells. The elements also do not arise in a definite order, but in an irregular way, as one often sees immature tracheides mingled with full-grown ones.

The function of the 'transfusion-tissue' has been discussed by those botanists who have dealt with this tissue. The view which is most universally accepted is, however, that the tissue in question is to conduct water, serving as an auxiliary conducting system. The functional character is also sometimes made use of in supporting the supposition that this tissue represents a modification of the centripetal xylem (cf. 14, p. 316). It is difficult to accept this assumption in the case of *Welwitschia*, for the leaf of this plant is both longitudinally and transversely traversed by larger

and smaller bundles which form a dense network, and can conduct and supply water to every part of the leaf, and it is not similar to the case of certain Cycads or broad-leaved Podocarps. Another objection is that the cells are so short that there must be much disadvantage in conducting water. Lastly, the tissue is better developed near the apex of the leaf, where conduction of water is less necessary.

If we look at this tissue without such prejudice there seems to be no reason why we could not regard it as a water-storage organ. I may perhaps give here some examples of similar tissue occurring in the Angiosperms. It is very familiar to us that the termination of vascular bundles in the leaves of various Dicotyledons is provided with short water-storing tracheides. In some cases, as shown by Heinricher (5) in *Capparis* spp., *Centaurea* spp., and *Astrolopium repandum*, and as in *Armeria vulgaris*, the water-storing tracheides extend much further down, and frequently occur even for some distance along vascular bundles. These strongly remind us of the 'transfusion-tissue' in the leaf of *Gnetum* (9, p. 626; 12, p. 149) and in the cotyledon of *Welwitschia* (13). To give another example, it is well known that epiphytic Orchids have adapted various organs for water storage. In spite of the tremendous amount of aqueous tissue of parenchymatous cells, the stem of certain species of *Dendrobium* possesses thick-walled tracheide-like water-storing cells along the bundle, which are arranged in the same fashion as we see in the adult leaf of *Welwitschia*. Of course, broad-leaved plants store water in a rather different way from what is seen in the Gymnosperms, namely, in most cases by parenchymatous aqueous cells. Still, if we examine those Angiosperms<sup>1</sup> which possess only scaly or acicular leaves, the water-storing device is just as we see it in the Gymnosperms. An interesting case of occurrence of water-storing tracheides in the pith<sup>2</sup> of *Cephalotaxus Koraiana* has been recorded by Rothert (8). These tracheides are more or less isodiametric in shape, resembling the 'transfusion-tracheides' in the leaf, and have reticulated bars and bordered pits. It is worthy of special notice that these tracheides are, according to the author, derived from parenchyma and do not indicate any sign of vestigial centripetal xylem. Scheit (9, p. 632) has pointed out that 'transfusion-tissue' is much more abundant in the leaves of those Conifers which grow in dry localities than those growing in damper places (this point is reversely referred to in Miss Carter's paper, p. 982). This fully shows that this tissue is nothing but a water-reservoir brought forth by physiological necessity. If it is not, where could we find water-storing tissue in the Gymnosperms?<sup>3</sup>

<sup>1</sup> E.g. Casuarinarae; many species of Tamaricaceae; certain members of Proteaceae, such as *Personia*, *Franklandia*, &c.

<sup>2</sup> Comparable with the parenchymatous water-storing cells in the pith of *Ledum palustre*.

<sup>3</sup> In the cladode of *Phyllocladus* isolated parenchymatous water-storing cells are present. This is probably unique among the Gymnosperms.

Correlating these facts, we have very little difficulty in regarding the 'transfusion-tissue' as a tracheidal water-storing tissue, the elements of which may well be called water-tracheides, as generally termed.

Then we can duly perceive that the so-called 'accessory transfusion-tissue' occurring in the leaves of Cycads, *Ginkgo*, and of broad-leaved Podocarps is a real auxiliary conducting system, transmitting water from the vascular bundle towards the margin of the leaf, though of course it is quite evident that this tissue is derived from mesophyll-parenchyma.

The tracheidal water-storing tissue occurs not only in the ordinary leaves, but also in the bracts and cone-scales (mostly of female cones) of the Gymnosperms, where storing water is necessitated.<sup>1</sup>

Not only in recent plants, but also in some fossil Gymnosperms and Lycopods, the 'transfusion-tissue' has been described.<sup>2</sup> In these plants the tissue in question occurs just as it does in *Welwitschia*, surrounding vascular bundles and being more or less separated from the latter. It appears to me highly probable that this tissue here also served as a water-reservoir, as it does in the recent plants.

In the foregoing pages I have endeavoured to show the origin and function of the 'transfusion-tissue', and now it is quite clear that the tissue in question is not a modification of the centripetal xylem, nor is it an auxiliary conducting system, but it is a special sort of water-reservoir derived from pericyclic as well as mesophyll parenchyma.

#### SUMMARY.

The orthodox 'transfusion-tissue' always arises laterally, and generally from the pericyclic region of the vascular bundle, quite independent of the centripetal xylem. Mesophyll-parenchyma often takes a share. Therefore, it is not a vestige of the centripetal xylem and is not to be reckoned as of phylogenetic importance.

Its function is water-storing.

The so-called 'accessory transfusion-tissue' serves to transmit water from the vascular bundle towards the margin of the leaf, and this is, as is well known, derived from mesophyll-parenchyma.

<sup>1</sup> The water-storing tissue in the bracts and scales of the Conifers has been thoroughly investigated by Bernard (2), who calls this tissue 'le bois centripète'. It is quite obvious that these parts of plants require water, as we see in the husk of the common hazel.

<sup>2</sup> A general account of this is found in Scott (10); also a description of the 'transfusion-tissue' in *Prepinus*, &c., is given by Jeffrey (6).



## BIBLIOGRAPHY.

1. BERNARD, CH. : Le bois centripète dans les feuilles des Conifères. Beiheft z. Bot. Centralbl., xvii, 1904.
2. ————— : Le bois centripète dans les bractées et dans les écailles des Conifères. Ibid., xxii, 1907.
3. CARTER, M. G. : A Reconsideration of the Origin of 'Transfusion-tissue'. Ann. Bot., xv, 1911.
4. FRANK, A. : Bot. Zeitg., 1867.
5. HEINRICHER, E. : Ueber einige im Laube dicotyler Pflanzen trockenen Standortes auftretende Einrichtungen, &c. Bot. Centralbl., xxiii, 1886.
6. JEFFREY, E. C. : On the Structure of the Leaf in Cretaceous Pines. Ann. Bot., xxii, 1908.
7. MOHL, H. VON : Bot. Zeitg., 1871, Nos. 1, 2.
8. ROTHERT, W. : Ueber parenchymatische Tracheiden, &c., im Marke von *Cephalotaxus*-Arten. Berichte d. D. Bot. Gesellschaft, xvii, 1899.
9. SCHEIT, M. : Die Tracheidensäume der Coniferen, &c. Jenaische Zeitschr. f. Naturwissenschaft, xvi, 1883.
10. SCOTT, D. H. : Studies in Fossil Botany. 2nd ed., 1908-9.
11. SYKES, M. G. : Anatomy and Morphology of the Leaves and Inflorescences of *Welwitschia mirabilis*. Phil. Trans., cci, ser. B, 1910.
12. STRASBURGER, E. : Leitungsbahnen, 1891.
13. TAKEDA, H. : Some Points on the Anatomy of the Leaf of *Welwitschia mirabilis*. Ann. Bot., xxvii, 1913, p. 347.
14. WORSDELL, W. C. : On the 'Transfusion-tissue'. Trans. Linn. Soc. Lond., Bot., ser. 2, v, 1897.



## NOTES.

**DEVELOPMENT OF THE STOMA IN GNETUM GNEMON.**—In connexion with my study of *Welwitschia*<sup>1</sup> I may here describe the development of the stoma in *Gnetum Gnemon*, which shows a similar type to the former plant. The structure of the stoma is very much the same as already described in *Gnetum africanum*.<sup>2</sup> Stomata are present on the under surface of the leaf, except on the veins, and are irregularly orientated. A mature epidermal cell has a sinuous outline resembling that in *Tmesipteris*. One of the epidermal cells becomes an initial cell which divides into two by a line usually parallel to the long axis of the cell (Fig. 1). One of these cells divides again in the same way (Fig. 2). In the normal case, the

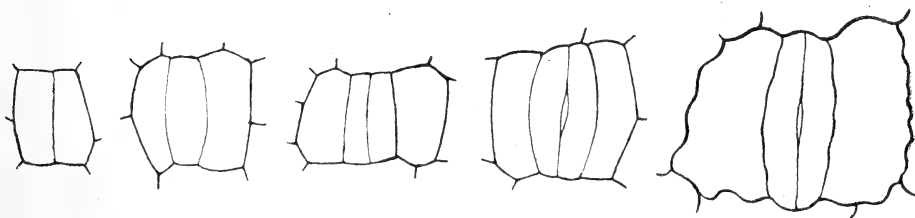

Fig. 1.

Fig. 2.

Fig. 3.

Fig. 4.

Fig. 5.

FIGS. 1-5. Successive stages of development of stoma, Fig. 5 being a mature one.  $\times 830$ .

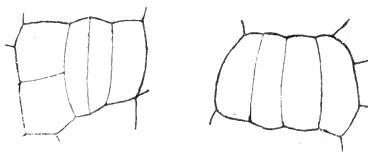

Fig. 6.

Fig. 7.

FIGS. 6, 7. Transverse and longitudinal divisions of subsidiary cells.  $\times 830$ .

central one of these three cells will become a stoma-mother-cell, which subsequently divides in the same fashion, giving rise to two guard-cells (Figs. 3, 4); the other two will be subsidiary cells. Thus a stoma with two subsidiary cells is formed from one single epidermal cell.

Sometimes one or both of the subsidiary cells divide longitudinally, transversely, or obliquely (Figs. 8, 9), so that more than four cells are cut from an initial cell. In such a case those cells which immediately border upon the guard-cells seem to function as subsidiary cells. This further division of subsidiary cells may start before the guard-

<sup>1</sup> Takeda: *Ann. Bot.*, xxvii, current number, 1913.

<sup>2</sup> Duthie: *Ann. Bot.*, xxvi, 1912, p. 600.

cells are formed (Figs. 6, 7). In the mature stage the original boundary lines of an epidermal cell will be very sinuous, while those division lines which are formed within an epidermal cell will take a much less sinuous appearance (Figs. 5, 8-10).

Occasionally in the above described three-celled stage, one of the marginal cells, instead of the central one, becomes a stoma-mother-cell. In this case, an

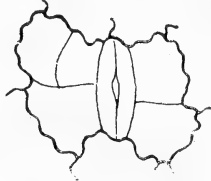

FIG. 8. A mature stoma with divided subsidiary cells.  $\times 450$ .

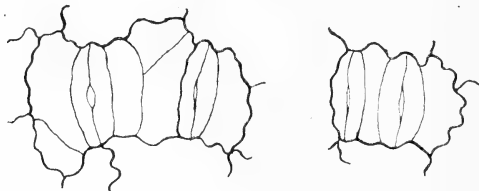

Fig. 9.

Fig. 10.

FIGS. 9, 10. 'Twin stomata'; Fig. 9 being not quite typical.  $\times 450$ .

epidermal cell or a division of an epidermal cell abutting on the stoma would take the place of a subsidiary cell. It often happens, in such a case, that the other part of the epidermal cell further divides once or twice and forms another stoma, so that a 'twin-stoma' results (Figs. 9, 10). Except in rare cases, it has been observed that a perfect 'twin-stoma' is not formed from one single epidermal cell, but usually one of the neighbouring epidermal cells will join as a subsidiary cell (Figs. 9, 10).

Very seldom a stoma is formed diagonally to the epidermal cell, as has also been observed in the cotyledon and bract of *Welwitschia*.

H. TAKEDA.

THE ROYAL COLLEGE OF SCIENCE,  
LONDON.

**NOTE ON AN ATTACHED SPECIES OF SPIROGYRA.**—It is well known that members of the Zygnemaceae do not, as a rule, form attaching organs, the filaments being commonly found floating freely in still or slowly running fresh water. There are, however, species of *Spirogyra* on record which are frequently attached to some substratum: such are *S. adnata* and *S. fluviatilis*, which are often found anchored to submerged stones, and *S. setiformis*, which according to Kny may occasionally be attached by rhizoids, but is more often found in freely floating masses. Rhizoids have also been observed in other species of *Spirogyra*, and in species of *Zygnema* and *Mougeotia*, but only under special conditions, either in culture solution, or during conjugation as irregular outgrowths from a conjugating tube. We have

but little knowledge of the manner in which these rhizoids are produced, and of the conditions which determine their formation.

The present note relates to a specimen of *Spirogyra* which has not yet been observed in a fertile condition, but which closely resembles *S. adnata*, and which will be provisionally referred to that species. The material was found as small tufts of bright green filaments attached to a log, which was completely submerged in the running water of a chain of ponds in the neighbourhood of Hampstead Heath. The sterile filaments appeared in July, 1912, and persisted until late in January, 1913, with somewhat variable algal associates, consisting of *Vaucheria* and *Cladophora* in the summer and autumn, and of *Draparnaldia* during the winter months.

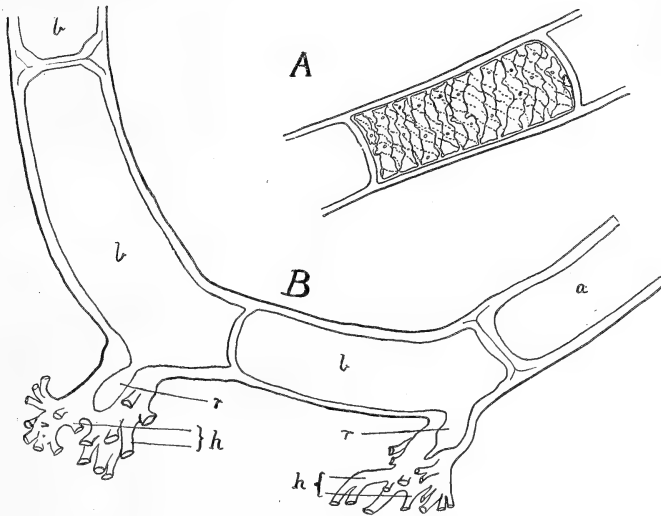

FIG. 1. *Spirogyra adnata* (?). A. Typical assimilating cell with three chromatophores; pyrenoids only shown as seen at upper focus: position of lower chromatophores indicated by dotted lines: nucleus omitted. B. Lower part of filament dissected from log, showing assimilating cell (a), basal cells (b), with rhizoids (r) bearing haptophores (h), o which the broken ends only are seen: cell-contents omitted.

No conjugation has been seen, although the spot has been under constant observation.

The cells of the filaments vary from about 40 to 45  $\mu$  in diameter, and are from one to three times as long as they are broad. The longest cells are those which are about to undergo division, in the upper part, or which bear rhizoids, in the lower part of the filaments. There are usually three chromatophores, with a slightly crenate edge, and with very small distant pyrenoids; but four or even five may occur. In the assimilating cells, the chromatophores are closely set, each one making three or four turns (Fig. 1 A), but in the basal and attaching cells they are loosely arranged, or nearly straight, especially in the neighbourhood of the rhizoids (Fig. 2). The cell-walls are stout and often distinctly lamellose in the lower cells (Fig. 1 B).

By teasing out the filaments from their woody base, it may be seen that the lower cells are elongated, with irregular and often nearly colourless plastids. They

may be attached directly by a spreading disc-like group of haptophores, borne on a short stout rhizoid, or they may extend for some distance horizontally, below the surface of the woody matrix, and then may produce assimilating branches as well as rhizoid-bearing cells. It is very difficult to demonstrate the behaviour of this rhizome-like basal region owing to the fragile nature of the material.

The rhizoids are rarely septate, and appear to be enucleate. Ends of one or two chromatophores, however, elongate, and extend into the first-formed protuberance.

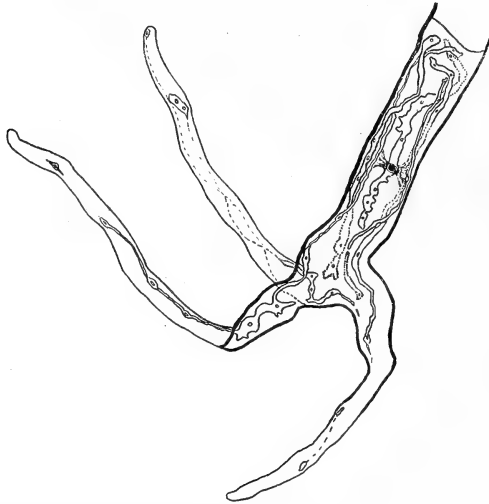

FIG. 2. *Spirogyra adnata* (?), showing basal cell which had attached itself to a glass dish by means of three rhizoids, into each of which chromatophores have penetrated.

These appear to keep pace for a time with the growth of the tube, but they may fragment into small pieces, which may be seen either isolated, or connected only by an attenuated thread of granules, at intervals along the length of the tubes: these fragmented pieces appear to always contain at least one pyrenoid.

The rhizoids may be formed either as lateral or terminal protuberances; and in cells with lamellose walls, the inner cellulose lining of the walls appears to break through the outer gelatinous layers. The initial outgrowth may either branch and give rise to other more slender tubes (Fig. 2), or it may at once form a bunch of outspread haptophores with thick gelatinous walls (Fig. 1 B). It seems probable that, as in the cases described by Borge, the rhizoids are formed primarily as the result of contact stimulus, but further observations are needed on this and other points.

E. M. DELF.

**ON THE OCCLUSION OF THE STOMATA IN TRADESCANTIA PULCHELLA.**—Whilst studying the effects of traumatic stimuli on the leaves of *Tradescantia pulchella* an interesting instance of stomatal occlusion was discovered. The wounds were made by incisions and by the removal of portions of the lamina, and it was thought at first that the occlusion was in the nature of a wound response,<sup>1</sup> tending to check excessive transpiration. The examination of a large number of mature uninjured leaves showed, however, that the stomatal occlusion was a constant feature.

In transverse section the leaves show an epidermis composed of very large cells, devoid of chlorophyll, those of the under side, to which the stomata are confined,

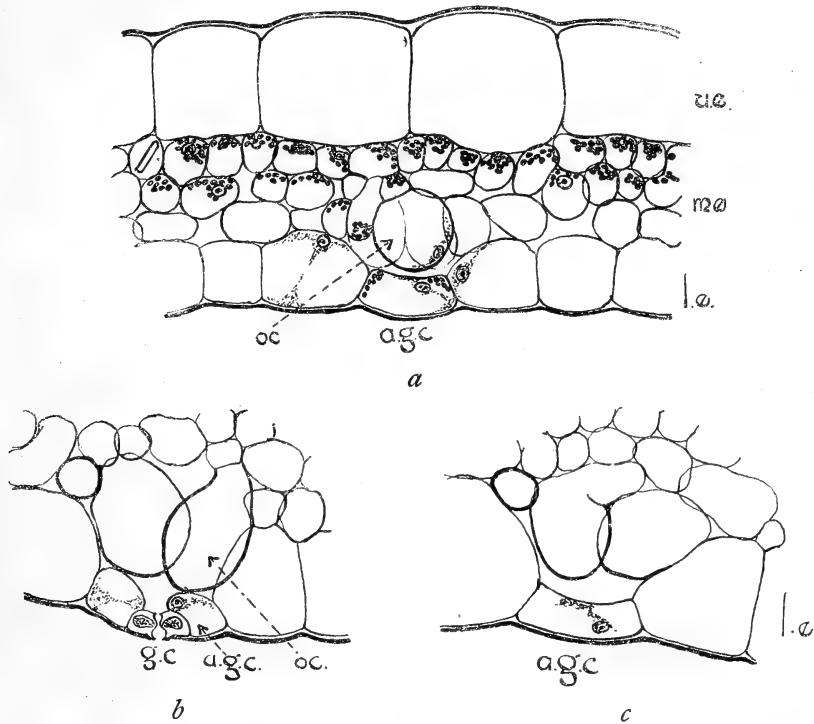

FIG. (a) Portion of leaf of *T. pulchella* in transverse section to show distribution of tissues and occluding growths; (b) and (c) show other views of occluded stomata. *u.e.* upper epidermis; *l.e.* lower epidermis; *m.e.* mesophyll; *g.c.* guard cells of stoma; *a.g.c.* auxiliary cells; *oc.* occluding growths.

being somewhat the smaller. The epidermis encloses, in the young laminae, a perfectly homogeneous mesophyll composed of rounded cells with abundant chlorophyll. In the mature leaves the layer of mesophyll immediately abutting on the lower epidermis enlarges somewhat and seems to lose some of its chloroplasts. It is from this layer that the occluding growths arise, as bladder-like swellings which gradually fill up the cavity below the guard cells in a similar manner to tyloses (Fig., *a*, *b*, *c*). When

<sup>1</sup> Occlusion by parenchymatous ingrowths has been recorded for *Equisetum*, as a traumatic response, by Strasburger (Leitungsbahnen, 1891; Der Bau der Kryptogamen), and I have also observed it in the leaves of *Cycas revoluta*.

mature the walls of the hypertrophied cells become brownish in colour and are slightly thickened, but do not show any trace of lignification. In none of the leaves examined were the outgrowths sufficiently large to prevent the proper working of the guard cells, though they occasionally came into contact with the auxiliary cells of the stomata. To determine the age of the leaf at which this occlusion commenced, leaves of all ages were sectioned, and it was found that, whilst there was no trace of abnormality in the young stages, the outgrowths began to develop as soon as the leaf was fully expanded and were complete in many cases within thirty days. A somewhat parallel case is figured by Haberlandt<sup>1</sup> for *Pilea elegans*, in which, however, the occluding cell is much thickened and touches the guard cells. He also refers to similar cases in *Camellia japonica* and *Prunus Laurocerasus*. Küster<sup>2</sup> amplifies Haberlandt's statement and cites Molisch<sup>3</sup> as recording stomatal occlusion in *Tradescantia guianensis*, *T. pilosa*, and *T. zebrina*. Haberlandt<sup>4</sup> also records the complete choking of the stomata of *Tradescantia viridis* by the hypertrophy of the auxiliary cells.

The plants of *T. pulchella* upon which the observations here recorded were made, were grown in a greenhouse which was not supplied with artificial heat, and in which, consequently, the temperature was only slightly higher than that obtaining outside. As this species is a native of Mexico it was thought that the low temperature had possibly had the effect of preventing adequate root absorption, and a number of experiments were performed with a view to testing the accuracy of this idea. In the first series an additional supply of water was given to a number of plants, which otherwise were under identical conditions with their fellows, and it was found that this treatment did not result in any noticeable diminution in the development of the swellings. In the second series a number of cuttings from the original plants were allowed to thoroughly establish themselves in a warmer plant-house, in which a constant temperature of 75°-80° F. was maintained. They were liberally watered, and under these conditions very few cases of stomatal occlusion (four out of sixty examined) were found. Further investigation is, of course, necessary before the cause of these outgrowths can be regarded as settled, but the above observations were thought to be of sufficient interest to record.

H. S. HOLDEN.

UNIVERSITY COLLEGE, NOTTINGHAM.

<sup>1</sup> Haberlandt: Physiologische Pflanzenanatomie, 1909, p. 423.

<sup>2</sup> Küster: Pathologische Pflanzenanatomie, 1903, pp. 106-7.

<sup>3</sup> Molisch: Ber. Senckenberg. Naturf. Ges., 1887, p. 117.

<sup>4</sup> Haberlandt: Ueber d. Bezieh. zw. Funktion u. Lage des Zellkerns bei d. Pflanz., 1887.



# FLORAL MECHANISM

By A. H. CHURCH, M.A., D.Sc.

LECTURER IN BOTANY IN THE UNIVERSITY OF OXFORD

## The following statement has been drawn up by Professor Sydney H. Vines

THE object of this work is to provide the botanical student with a complete description of the development, morphology and mechanism of the principal types of flowers. Whilst giving the kind of information that is to be found in Payer's *Organogénie de la Fleur*, and in the late Professor Eichlér's well-known *Blüthendiagramme*, it supplements this with an account of the ecology of the flower, including pollination and the formation of fruit and seed. Hence, when complete, it will be the most comprehensive treatise on the flower that has yet been published.

The general plan of the work may be gathered from Part I, which was published in 1908 as a royal 4to volume of 211 pages. In it are described the following twelve types of floral structure, selected from familiar garden flowers that bloom in the early part of the year (January–April):—

<i>Helleborus niger</i> . . .	Christmas Rose.	<i>Viola odorata</i> . . . . .	Sweet Violet.
<i>Galanthus nivalis</i> . . .	Snowdrop.	<i>Narcissus Pseudo-Narcissus</i>	Daffodil.
<i>Jasminum nudiflorum</i>	White Jasmine.	<i>Erica carnea</i> . . . . .	Heath.
<i>Crocus vernus</i> . . .	Blue Crocus.	<i>Ribes sanguineum</i> . . . . .	Flowering Currant.
<i>Richardia africana</i> . . .	White Arum Lily.	<i>Cydonia japonica</i> . . . . .	Scarlet Cydonia.
<i>Daphne Mezereum</i> . . .	Mezereon.	<i>Vinca major</i> . . . . .	Greater Periwinkle.

In connexion with each type, two or three allied species are described for purposes of comparison.

The description of each type is illustrated by a full-page coloured plate, giving an accurate longitudinal section of the flower, and by a black-and-white plate giving the inflorescence, the floral diagram, and other structural details. As each subsidiary species has also a coloured plate allotted to it, the volume contains no less than forty coloured and fourteen uncoloured plates, in addition to a large number of figures, chiefly developmental, included in the text. It can be obtained at the original price of £1 1s. net by subscribers to Part II.

It was hoped that the reception of so striking a volume as Part I would have been such as to justify the Delegates of the Press in proceeding forthwith to publish Part II, the material for which is in readiness. Inasmuch as this anticipation has unfortunately not been realized so far, the Delegates are not disposed to undertake the publication of Part II without some assurance that the necessarily large expenditure involved will meet with the general support of those who, in one way or another, are interested in flowers. But the University Press has received such warm commendations of the work from Botanists who desire to push on the study of Botany in the English-speaking countries that they desire, if possible, to continue publication. They propose, therefore, to ask for subscriptions for copies of Part II at One Guinea each, on the understanding that Part II will, like Part I, consist of descriptions of twelve types of flowers, with allied forms, and be similarly illustrated, though it may be found necessary to reduce somewhat the number of coloured plates. Any copies not subscribed for will not be sold at less than thirty shillings each.

*Science Progress*:—‘Without doubt one of the most interesting botanical books of recent years, and one which in its turn should become a classic.’

*Journal of Botany*:—‘In noticing this very beautiful and elaborate work, one remark seems obvious—there is nothing else like it.’

*Nature*:—‘A valuable contribution to botanical literature, excellent alike in the text and in the illustrations, and the execution is worthy of the Clarendon Press. . . . No botanical school can afford to neglect so valuable and suggestive a storehouse of information.’

Order Forms may be had on application.

Published by WILLIAM WESLEY & SON, London

# The New Phytologist

A British Botanical Journal.

Edited by A. G. TANSLEY, M.A., University Lecturer in Botany, Cambridge,  
in consultation with the Staff of the Cambridge Botany School.

Assistant Editor: F. CAVERS, D.Sc.

THE NEW PHYTOLOGIST was founded in 1902 to afford a medium for the publication of original papers, critical articles and reviews, summaries of recent advances in botanical knowledge, and occasional notes and correspondence on botanical topics. Preference is given to those contributions dealing with matters of general interest to botanists and to those branches of the science undergoing rapid current development. The journal is well illustrated, and is issued once a month (except August and September). The minimum size of the annual volume is 360 pages, 8vo. Annual subscription price, 15s., post free; single numbers, 2s. each.

Vols. I, 6 and 7 out of print. Vols. 2-5, 8-II, 15s. each.

## New Phytologist Reprints.

No. 1 (Out of print). LECTURES ON THE PHYSIOLOGY OF MOVEMENT IN PLANTS (1907). By Sir F. DARWIN.

No. 2. LECTURES ON THE EVOLUTION OF THE FILICINEAN VASCULAR SYSTEM. By A. G. TANSLEY. Pp. viii and 142, with Glossary, Bibliography, Index, and 101 figures in the Text. Price 3s. 6d., post free. Five Copies for 15s., post free.

No. 3 (Out of print). THE PHYLOGENY AND INTER-RELATIONSHIPS OF THE PTERIDOPHYTA (1907). By Lady ISABEL BROWNE.

No. 4. THE INTER-RELATIONSHIPS OF THE BRYOPHYTA.

By F. CAVERS.

Pp. viii and 203, with Full Literature Lists, Phylogenetic Tables, Index, and numerous Figures in the Text. Price 4s. net; 4s. 4d. post free. Five Copies for 18s.

No. 5. FLORAL EVOLUTION: WITH PARTICULAR REFERENCE TO THE SYMPETALOUS DICOTYLEDONS. By H. F. WERNHAM.

Pp. vi and 140, with Phylogenetic and other Tables, and an Index.  
Price 3s., post free. Five Copies for 13s. 6d., post free.

No. 6. THE VEGETATION OF JAPAN. By H. TAKEDA.

Pp. 21. Price 1s. post free.

Application for the Reprints should be made direct to the NEW PHYTOLOGIST, Botany School, Cambridge.

*Vol. I nearly ready, price to be raised on publication.*

*In Four Volumes quarto. Cloth. Subscription price £2 2s. net per volume.*

## The Flora of South Africa

By Dr. RUDOLF MARLOTH, Author of 'Das Kapland'

180 Coloured plates, 100 Monochrome plates and numerous illustrations in the text.

HENSLOW (G.). THE HEREDITY OF ACQUIRED CHARACTERS IN PLANTS. 24 plates. 8vo, cloth. 1908 (pub. 6s. net). 4s.

To prove Darwin's contention that evolution—so far as plants are concerned—depends upon the inheritance of acquired characters. The argument is based on the observations of modern ecologists.

WILLIAM WESLEY & SON

28 ESSEX STREET, STRAND, LONDON.

Vol. XXVII. No. CVII. July, 1913. Price 14s.

# ANNALS OF BOTANY

EDITED BY

DUKINFIELD HENRY SCOTT, M.A., LL.D., D.Sc., FOR. SEC. R.S.

LATELY HONORARY KEEPER OF THE JODRELL LABORATORY, ROYAL BOTANIC GARDENS, KEW

JOHN BRETLAND FARMER, D.Sc., M.A., F.R.S.

PROFESSOR OF BOTANY, ROYAL COLLEGE OF SCIENCE, LONDON

FRANCIS WALL OLIVER, M.A., D.Sc., F.R.S.

QUAIN PROFESSOR OF BOTANY, UNIVERSITY COLLEGE, LONDON

AND

ROLAND THAXTER, M.A., Ph.D.

PROFESSOR OF CRYPTOGAMIC BOTANY IN HARVARD UNIVERSITY, CAMBRIDGE, MASS., U.S.A.

*ASSISTED BY OTHER BOTANISTS*

LONDON

HUMPHREY MILFORD, OXFORD UNIVERSITY PRESS  
AMEN CORNER, E.C.

EDINBURGH, GLASGOW, NEW YORK, TORONTO, MELBOURNE, AND BOMBAY

1913

# CONTENTS.

	PAGE
PRAIN, SIR DAVID.—The Mercurialineae and Adenoclineae of South Africa . . . . .	371
BAKER, SARAH M.—Quantitative Experiments on the Effect of Formaldehyde on Living Plants. With Plates XXX and XXXI and four Figures in the Text . . . . .	411
BOWER, F. O.—Studies in the Phylogeny of the Filicales. III. On Metaxya and certain other relatively primitive Ferns. With Plates XXXII–XXXIV and two Figures in the Text . . . . .	443
HILL, ARTHUR W.—The Floral Mechanism of the Genus Sebacea. With Plate XXXV and two Figures in the Text . . . . .	479
ARBER, AGNES.—On the Structure of the Androecium in Parnassia and its bearing on the Affinities of the Genus. With Plate XXXVI and four Figures in the Text . . . . .	491
BLACK, CAROLINE A.—The Morphology of Riccia Frostii, Aust. With Plates XXXVII and XXXVIII . . . . .	511
HOLDEN, RUTH.—Contributions to the Anatomy of Mesozoic Conifers. No. I. Jurassic Coniferous Woods from Yorkshire. With Plates XXXIX and XL . . . . .	533
TAKEDA, H.—Morphology of the Bracts in Welwitschia mirabilis. With Plate XLI and two Figures in the Text . . . . .	547
FRASER, H. C. I. (Mrs. D. T. GWYNNE-VAUGHAN).—The Development of the Ascocarp in Lachnea cretea. With Plates XLII and XLIII . . . . .	553
THODAY, D.—On the Capillary Eudiometric Apparatus of Bonnier and Mangin for the Analysis of Air in investigating the Gaseous Exchanges of Plants. With two Figures in the Text . . . . .	565
 NOTE.	
BARTLETT, A. W.—Note on the Occurrence of an Abnormal Bisporangiate Strobilus of Larix europaea, DC. With two Figures in the Text . . . . .	575

---

## NOTICE TO SUBSCRIBERS.

The subscription-price of each volume is thirty shillings, payable in advance: the Parts, four in number, are supplied as they appear, post free to subscribers in the United Kingdom, and with a charge of 1s. 6d. per annum for postage to subscribers residing abroad. The price of individual Parts is fixed at a higher rate. Intending subscribers should send their names, with subscription, to HUMPHREY MILFORD, Oxford University Press, Amen Corner, London, E.C.

As the earlier volumes of the Annals of Botany are becoming scarce, Vol. I will only be sold as part of a complete set; and Parts will not as a rule be sold separately, after the publication of the volume to which they belong. A few extra copies of particular Parts at present remain on hand, for which special application must be made to the Editors, Clarendon Press, Oxford.

---

## NOTICE TO CONTRIBUTORS.

In future, English contributors should address their papers to Professor F. W. OLIVER, F.R.S., University College, Gower Street, London, W.C.; and contributors in America to Professor R. THAXTER, Harvard University, Cambridge, Mass.

Papers sent in with a view to publication *must be type-written* and *must conclude with a summary of the contents*. The illustrative figures should be planned so as to fill properly a 4to or an 8vo plate. The maximum space available for figures in a 4to plate is  $8\frac{1}{4} \times 11\frac{1}{4}$  inches, in an 8vo plate  $8\frac{1}{4} \times 5\frac{1}{4}$  inches. Attention to this will conduce to the rapid publication of papers if accepted.

Each contributor to the Annals of Botany is entitled to receive gratis one hundred separate copies of his paper, and may purchase additional copies if he informs the Editors of his wishes in this respect when he returns corrected proofs. The price of these additional copies will depend upon the amount of text and the number of plates in the paper.

# The Mercurialineae and Adenoclineae of South Africa.

BY

D. PRAIN, C.I.E., F.R.S.

*Director of the Royal Gardens, Kew.*

## INTRODUCTORY.

IN a former paper (Ann. Bot., xxv. 575-638) the writer, in reviewing the Euphorbiaceous genera *Erythrococca*, Benth., and *Micrococca*, Benth., discussed a suggestion made by Baillon in 1862 (Adansonia, iii. 167-76) that these two genera, with *Claoxylon*, A. Juss., *Adenocline*, Turcz., and *Seidelia*, Baill., are referable to *Mercurialis*. There is little to add to the reasons given in 1911 for adopting another view. But as a revision of *Erythrococca* and *Micrococca* was called for then<sup>1</sup> when preparing the 'Flora of Tropical Africa', so now, in preparing the 'Flora Capensis', a similar revision is required of *Seidelia* and *Adenocline*, and of certain South African species included in 1862 by Baillon in *Mercurialis*, but transferred in 1866 to two new genera, *Leidesia* and *Paradenocline*, proposed (DC. Prodr., xv. 2, 792; 1141) by Müller.

## HISTORY OF MERCURIALIS PROCUMBENS.

When Linnaeus dealt with *Mercurialis* in the first edition of the 'Species Plantarum' in 1753 only his fourth species, *M. procumbens*, Linn. (Sp. Pl., ed. 1, 1036), was African. The earliest reference to this species is over half a century older; it was one of the plants obtained in South

<sup>1</sup> Since that revision appeared one doubtful point has been cleared up. It was stated (Ann. Bot., xxv. 605) that *Claoxylon sphaerocarpum*, O. Kuntze (Rev. Gen. Pl., iii. 2, 248), almost certainly belongs to some other genus. Through the kindness of Dr. N. L. Britton, Director-in-Chief, New York Botanic Garden, we have seen the original specimen; it is really *Croton sylvaticus*, Hochst. Since 1911 it has been necessary to describe two new species of *Micrococca*: *M. scariosa*, Prain (Kew Bulletin, 1912, 192), an East African species representing a new section; and *M. lancifolia*, Prain (Kew Bulletin, 1912, 282), a Madagascar plant most nearly allied to the South-east African *M. capensis*. To the synonyms of the genus *Micrococca* must be added *Mercurialis* § *Trismegista*, Endl. (Gen. Pl., 1111 [1840]); to those of the species *M. Mercurialis*, Benth., should be added *Ricinokarpos indica glabra Mercurialis folio*, Burm. (Thes. Zeyl., 205 [1737]). From a recent contribution to African botanical literature by Dr. Mildbraed (Wiss. Ergebn. Deutsch. Zentr.-Afr. Exped., 1907-8, ii. 452 [1913]) we learn that Dr. Pax now treats *Claoxylon* § *Discoclaoxylon*, Müll. arg., as a distinct genus *Discoclaoxylon*, Pax, and that he also treats *Claoxylon* § *Athroandra*, Müll. arg., as a distinct genus *Athroandra*. Both decisions, as has been explained (Ann. Bot., xxv. 596, 605), though permissible, are really unnecessary; the latter, however, had been, with a defect of orthography, anticipated by Pierre (Fl. Trop. Afr., vi. 1, 868). The generic name used by Pierre and by Pax is not permissible; if the group *Athroandra* be treated as a *genus* the name to be used is *Chloropatane*, Engl.

Africa and grown at Leiden which Hermann intended to figure; in his posthumous catalogue of 1698 it was named *Mercurialis africana dicoccos, folio violae tricoloris* (Par. Bat., App. 10). In 1720 Boerhaave included this plant in his genus *Ricinokarpus* (Ind. alt. Lugd.-Bat., i. 254) as *R. afra: Mercurialis procumbens, dicoccos, Africana, folio violae tricoloris*, thus modifying Hermann's name and adding the epithet 'procumbens'. In 1737 Burmann, in his list of Hermann's African plants (Thes. Zeyl., App. 16), again modified Hermann's name by shortening it to *Mercurialis africana, minor, lucida*.

The plant which bore these names at Leiden is known from specimens in the British Museum (Natural History) collection written up by Gronovius as 'Ricinocarpus afra, B. Ind. 1, 254 syn. Mercurialis procumbens dicoccos africana folio violae tricoloris, Par. B., Ap. 10 H'. The same herbarium includes another specimen of the plant from Clifford's garden. Linnaeus did not enumerate the species in the 'Hortus Cliffortianus' in 1737, and the legend with this specimen, 'Ricinocarpus afra Mercurialis Linn. Gen. 910 afra', which must date from after 1742, was not written by him. But the species was apparently accounted for in the 'Viridarium Cliffortianum' in 1737; in 1740 Royen (Fl. Leyd. Prodr., 203) recorded *M. androgyna*, Linn. (Virid. Cliff., 98), as being Hermann's African *Mercurialis*—Boerhaave's African *Ricinokarpus*. Moreover, in 1753 (Sp. Pl., ed. 1, 1036) Linnaeus not only accepted Royen's identification of *M. androgyna*, Linn., with Boerhaave's African 'Ricinokarpus'; he substituted for his own term 'androgyna' the word 'procumbens' which Boerhaave had intercalated in Hermann's name. Besides, in 1753 and again in 1755, Linnaeus, as Dr. Jackson has shown the writer, noted the presence in his own herbarium of the plant whose name had thus been changed from *M. androgyna* to *M. procumbens*.

When Boerhaave defined *Ricinokarpus* he characterized it as a genus with 3-coccos capsules, and included in it two species. The first of these, *R. afra*, which is *Mercurialis procumbens*, Linn., he did not describe in full; we know, however, that its capsules are 2-coccos, and that it does not accord with the generic definition. The second species, which Boerhaave named 'R. americana flore albo spicato folio circaeae acutiori', was raised at Leiden from seed collected by Hartog between Berbice and Surinam. This species has 3-coccos capsules, and does accord with the generic definition. This latter plant appears to have been lost at Leiden between 1720 and 1737; it is not included in the Cliffortian 'Hortus' or 'Viridarium' of 1737, or in Royen's 'Prodromus' of 1740.

The circumstance that *Ricinokarpus*, Boerh., was a complex of two genera led to some misunderstanding. Possibly because the only part of *Ricinokarpus* which he knew was the African part, Linnaeus in 1737 (Gen. Pl., ed. 1, 307) reduced Boerhaave's genus to 756 *Mercurialis*, Tournef.,

remarking that the plant he had in mind differs from the European species in being androgynous. Later in the year J. Burmann published his 'Thesaurus Zeylanicus'; in an appendix thereto (Cat. Afr. Pl. Herm., 16) the African *Mercurialis* of Hermann, which had been treated by Boerhaave as the first species of *Ricinokarpus*, was referred to Hermann's genus, not to that of Boerhaave. In the body of the work (Thes. Zeyl., 204) the name *Ricinokarpus* was restricted by Burmann to that part of Boerhaave's genus which is represented by Hartog's 3-coccous plant from Surinam; his account of *Ricinokarpus indica hirsuta foliis Urticae vulgaris fructus in parvis acetabulis gerens* ends with the remark 'triccocum adeoque omnia ut in Ricinokarpo Boerhavii cujus notas vide definitas in ejus Ind. H. L. Bat.'

The ancipital nature of Boerhaave's genus was also realized by Royen, who followed Linnaeus in associating Boerhaave's name *Ricinokarpus* with the 2-coccous African species and suggested that the new generic name which was necessary should be applied to the 3-coccous American species. Linnaeus before the close of 1737 adopted this suggestion, and published the proposed new genus (Coroll. Gen., 19), on Royen's authority, as 986 *Acalypha*: *Ricinocarpus*, Boerh. Burm. 92. This arrangement did not disturb the citation of *Ricinocarpus*, Boerh., under 756 *Mercurialis* in the 'Genera' itself; it was repeated and regularized in 1742 (Gen. Pl., ed. 2, 456), when 865 *Acalypha*, Roy., was given as the equivalent of *Ricinocarpus*, Boerh. Burm. 92, while under 910 *Mercurialis*, Tournef. (l. c., 481), was still cited *Ricinocarpus*, Boerh., by implication now only so far as the 2-coccous African species was concerned.<sup>1</sup> This arrangement, though immediately convenient, did not alter the facts that the African portion of *Ricinokarpus*, Boerh., belongs to a genus apart from *Mercurialis*; that it is the American portion of *Ricinokarpus*, Boerh., which alone agrees with Boerhaave's generic definition, and was alone entitled to Boerhaave's generic name; and that the identification of *Ricinokarpus*, Burm., as based on the plant figured at t. 92 of the 'Thesaurus', with *Ricinokarpus*, Boerh., as based on Hartog's species from Surinam, was not justifiable. Apart from these drawbacks, however, the establishment of *Acalypha*, Roy., made the situation intelligible; all that was required to regularize it was the formal transfer, as *A. Ricinocarpus*, of Hartog's Surinam species to the genus of which Royen had made it the basis. Unfortunately when, in 1753, the opportunity for this arrived, Linnaeus omitted the Surinam plant from the first edition of the 'Species Plantarum'. When, in 1764, he did deal with Hartog's plant, instead of referring it to the

<sup>1</sup> The object Linnaeus had in view when he adopted Royen's genus *Acalypha* appears to have been the suppression of a generic name which was exposed to the risk of ambiguity. Kuntze (Rev. Gen. Pl., ii. 615) has, however, interpreted the action of Linnaeus differently. According to Kuntze, Royen allowed Linnaeus to use him as a 'dummy', while 'die Verdrängung von Ricinocarpus Burm. durch *Acalypha* L. "Royen" war ein offenbares Unrecht von Linné gegen seinen früheren Chef Burmann'. The facts of the case do not, however, seem to bear out this somewhat severe conclusion.

genus that Royen had based upon it, Linnaeus placed it in *Croton* as *C. Ricinocarpos*, Linn. (Sp. Pl., ed. 2, 1427). Had the repudiation of Royen ended here our inquiry into the African *Mercurialineae* would not have been affected. But Linnaeus, in trying to place the Surinam portion of *Ricinocarpos*, Boerh., on a surer footing, obscured the identity of the African part. He balanced his omission of the American species in 1753 by the elision in 1763 of his own *Mercurialis procumbens*. This was to carry reparation too far; though, even so, small harm need have happened had not Linnaeus endeavoured to account for the references under the African species. Two citations, Hermann's of 1698 and Boerhaave's of 1720, were transferred to *Solandra capensis*, Linn. (Sp. Pl., ed. 2, 1407), the other two, his own of 1737 and Royen's of 1740, were repeated under *Croton Ricinocarpos*. Since the names of Hermann, Boerhaave, and Royen connote the same species it was inevitable that Linnaeus should find his action as regards the synonyms of Hermann and Boerhaave unsatisfactory. His personal copy of the second edition of the 'Species Plantarum' shows that, prior to 1771, he struck his pen through both; the plant he had described as *Solandra capensis* proved to be a *Hydrocotyle*, which was republished in 1781 by the younger Linnaeus (Suppl. Pl., 176) as *H. Solandra*. Another home was sought for the unlucky synonyms; they were cited in 1771 (Mantiss. Pl., 298) under a new species collected in South Africa by Koenig and described as *Mercurialis afra*, Linn. Again the citation proved unsatisfactory; again the plant turned out to be a *Hydrocotyle*. In his own herbarium, Linnaeus struck his pen through the name *Mercurialis afra*, and wrote the sheet up afresh as *Hydrocotyle villosa*. The specimen is now in the *Hydrocotyle* cover, where it was laid by Linnaeus; the name, published in 1781 by his son (Suppl. Pl., 175), was unaccompanied by the synonyms of Hermann and Boerhaave, which Linnaeus thus left homeless after all.

The plants of Solander and Koenig, identified in succession with Hermann's African *Mercurialis*, Boerhaave's African *Ricinocarpos*, at any rate came from the Cape; in each case, when he realized that these plants belonged to another genus, Linnaeus abandoned the synonyms. But the reduction of his own *Mercurialis androgyna* to his own *Croton Ricinocarpos* involved the assumption that *M. androgyna* differed generically from the African plant of Hermann and Boerhaave, and that it was a native of Surinam. The name *M. androgyna*, as used by Royen in 1740, connoted that African plant and no other; this new citation by Linnaeus involved therefore a further repudiation of Royen. As, however, Royen was cited by Linnaeus along with himself, this repudiation, though undeniable, is manifestly unintentional. It is, therefore, more than probable that, even when he wrote *Croton Ricinocarpos* where he ought to have written *Acalypha Ricinocarpos*, Linnaeus did not really desire to discredit Royen.

In the absence of any specimen written up by Linnaeus as '*Mercurialis*



androgyna', it is arguable that *M. androgyna*, Roy. (Fl. Leyd. Prodr., 203), the African plant of Hermann and Boerhaave, may have differed from *M. androgyna*, Linn. (Virid. Cliff., 98), and that the latter, since Linnaeus says so, really was the Surinam *Ricinokarpus* of Boerhaave. This is to contend that we must concede that Linnaeus knew his own species, and that therefore we must accept his identification. The argument is plausible, and in its favour is the consideration that it influenced an author so careful as Müller, who (DC. Prodr., xv. 2, 798) has quoted *M. androgyna*, Linn., as the equivalent of 'Croton Ricinocarpus, Linn. quoad syn. Boerh. et patriam Surinamiam'. But the argument is less weighty than it appears; it can only be employed at all if the period at which Linnaeus's recollection was most vivid be treated as negligible. The word 'androgyna', as used by Linnaeus in 1737, is not a *nomen triviale* in the sense conveyed by the specific epithets first employed in 1753; it is only an apt condensation of the note appended to the generic definition of 756 *Mercurialis* (Gen. Pl., ed. 1, 307) of the same year. The association of Royen with Linnaeus in 1737 was so close that even under ordinary circumstances Royen was unlikely to have used the name *M. androgyna* in 1740 for a plant other than that so named by Linnaeus only three years before. The circumstances in this case were, however, unusual. In 1737 Linnaeus found himself in a difficulty through his having failed to observe what Burmann did observe, that *Ricinokarpus*, Boerh., is an ancipital genus. That difficulty centred in the statement by Linnaeus that the plant which is *Mercurialis androgyna*, Roy., was also the basis of *Ricinokarpus*. Later in the year, Linnaeus adopted a suggestion made by Royen which overcame the difficulty. The acceptance of Müller's identification involves, then, the assumption that by 1740 Royen had fallen into error as regards the name applied in 1737 by Linnaeus to the plant to whose existence the difficulty that Royen had solved was due. The intrinsic improbability of Müller's hypothesis is heightened by the existence of a Cliffortian specimen which certainly is *M. androgyna*, Roy. (1840), and must either be *M. androgyna*, Linn. (1737), or be a plant from Clifford's garden for which Linnaeus failed to account. An examination of the contents of the *Mercurialis* cover in the Linnean herbarium disposes of the suggestion that the recollection of Linnaeus as to the identity of his *M. androgyna* of 1737 was clearer in 1763, when he referred it to *Croton* as *C. Ricinocarpus*, than it was in 1753, when he referred the same plant to *Mercurialis* as *M. procumbens*.

In that *Mercurialis* cover five species are represented. Three of these have been written up by Linnaeus himself as—1, *perennis*; 2, *annua*; 3, *tomentosa*. These represent respectively the three species so named in 1753 (Sp. Pl., ed. 1). Another has been written up by Linnaeus, without a serial number, as *androgyna*, this word being afterwards struck through by him and the name *ambigua* substituted. The reason for this change is

apparent; the plant is androgynous, so that the deleted name is suitable; but it is a European not an African one, and therefore is neither the plant which Royen in 1740 believed to be *M. androgyna*, Linn., nor the plant which Linnaeus himself in 1763 believed to be *M. androgyna*, Linn. Like the species numbered 1, 2, and 3, this unnumbered plant is fully accounted for; it is the species published in 1763 (Sp. Pl., ed. 2, 1465) as *M. ambigua*, Linn. The last species in the *Mercurialis* cover is upon a sheet headed by Linnaeus, in larger script, MERCURIALIS; at foot, with a pencil '4', he has written in ink '*Croton*', and then struck this through in order to substitute *Mercurialis* in his usual hand. To this last endorsement Sir J. E. Smith, in pencil, has added '*procumbens*, Sp. Pl., ed. 1, 1036', and also '*Croton Ricinocarpos*, Sp. Pl., ed. 2, 1427', with a further memorandum that these determinations were based upon specimens in herb. Banks. The specimen to which these various annotations refer belongs to the South African plant of Hermann and Boerhaave. It was in the Linnean herbarium in 1763; though it is not a native of America, and therefore cannot be Boerhaave's Surinam *Ricinocarpos*, this specimen, the expression '*caulis pollicaris*' indicates, is that on which the brief account of *Croton Ricinocarpos* was based. While this much is certain, it is also probable that the reference of the species to *Croton* instead of to *Acalypha* may be a *lapsus* due to the presence of the cancelled name '*Croton*' on the sheet. There is, at any rate, little room for doubt that this name '*Croton*' was struck through and the name '*Mercurialis*' substituted when the first edition of the '*Genera Plantarum*' was under preparation. The circumstance that Linnaeus, though he did not write up the sheet as '*procumbens*', did write it up as '4' makes it almost certain that the species on this sheet is really the fourth *Mercurialis* of 1753, and that Smith, on the strength of the Cliffortian and Gronovian specimens of the same plant in herb. Banks, was as fully justified in treating this Linnean specimen as the type of *Mercurialis procumbens*, as he was in considering it the type of *Croton Ricinocarpos*.

The subsequent history of this species has been uneventful. As *Mercurialis procumbens* it was neglected until, in 1866 (DC. Prodr., xv. 2, 1141), Müller, with less than his customary caution, placed it in the newly founded genus *Paradenocline*. As *Croton Ricinocarpos*, Linn., it was taken up by Aublet in 1775 (Pl. Guyan., 883); by Willdenow in 1805 (Sp. Pl., iv. 1, 551); by Geiseler in 1807 (*Croton*. Monogr., 66); and by Sprengel in 1826 (Syst. Veg., iii. 877). These authors, following Linnaeus or each other, all failed to note that the plant they were dealing with bears little resemblance to that described by Boerhaave, or to observe that it is an African species to which the locality and the citation from Boerhaave cannot apply. In 1821 Steudel apparently noticed that *Croton Ricinocarpos* could hardly be a *Croton*, for he suggested (Nomencl., ed. 1, 524) the resuscitation of the name *Mercurialis androgyna*. This was not necessary,

because, as Richter showed in 1840 (Cod. Linn., 952), *M. androgyna* of 1737 and the suppressed *M. procumbens* of 1753 must be identical.

The evidence available shows that *M. androgyna*, Linn. (Virid. Cliff., 98) of 1737, *M. procumbens*, Linn. (Sp. Pl., ed. 1, 1036) of 1753, and *Croton Ricinocarpos*, Linn. (Sp. Pl., ed. 2, 1427, quoad diagn. tantum) of 1763 are identical. It shows that the two last are based on the same specimen, and it suggests that this specimen, which, alone among those he could then have owned, supplied the evidence in support of the note of Linnaeus under 756 *Mercurialis* in 1737, may also be a co-type of the species named *M. androgyna* in the same year.

Müller, whose conclusions have been generally accepted, in 1866 decided that all three are different. According to him *M. androgyna*, Linn., is *Croton Ricinocarpos*, Linn., so far as Boerhaave's American *Ricinokarpus* and the locality Surinam are concerned, whereas *Croton Ricinocarpos*, Linn., as to the plant described, but excluding Boerhaave's American synonym and the locality Surinam, is identical with *Leidesia capensis*, Müll. arg. (DC. Prodr., xv. 2, 763), also (l. c., 699) named *L. Sonderiana*. These conclusions seem incompatible. In identifying *Croton Ricinocarpos* with *Leidesia capensis*, Müller has excluded Boerhaave's American synonym and the Surinam plant, thus leaving *Mercurialis androgyna* as part of his species (l. c., 793); further on (l. c., 798) Müller has cited *M. androgyna*, Linn., as being Boerhaave's Surinam plant. Whereas Linnaeus had included under *Croton Ricinocarpos*, Linn., both his own *M. androgyna* and Boerhaave's Surinam *Ricinokarpus*, Müller excluded first the one and then the other, thereby implying, no doubt unintentionally, that the African species to which the description of *Croton Ricinocarpos* applies is a *tertium quid*. Müller's reference to the specimen in the Linnean herbarium must not be interpreted as implying that the name quoted was written up by Linnaeus: in citing Smith's identification of the plant as the basis of *Croton Ricinocarpos*, Müller has not mentioned Smith's simultaneous identification of the same specimen as *Mercurialis procumbens*. On the contrary, instead of agreeing with Smith that, because they are based on the same specimen, *Mercurialis procumbens* and *Croton Ricinocarpos* must be identical, Müller has cited the two names under two distinct genera.

This then completes the story of the 2-coccos African plant included by Boerhaave in 1720 in his 3-coccos genus *Ricinokarpus*, which in 1866 became the basis of Müller's distinct and valid genus *Leidesia*, Müll. arg. The history of the 3-coccos American plant on which, from his description, we learn that Boerhaave meant to base *Ricinokarpus*, and on which we know that Royen in 1737 based the genus *Acalypha*, has yet to be written; no one has identified any particular Surinam plant as being that named by Boerhaave '*Ricinokarpus americana; flore albo spicato folio circaeae acutiori*'.

The considerations which influenced Royen when he made this plant the basis of the genus *Acalypha* have already been explained. Seeing that this is the plant to which alone the generic definition of *Ricinokarpus* formulated by Boerhaave applies, the action suggested by Royen and adopted by Linnaeus was perhaps unfortunate. Burmann (Thesaur. Zeyl.) showed a better appreciation of the case when he maintained Boerhaave's name *Ricinokarpus*, and strove to establish effectively the genus that Boerhaave had in view. With this object Burmann added to *Ricinokarpus* seven 3-coccous species, all, as Burmann believed, members of Boerhaave's genus. Unfortunately, as Kuntze has pointed out (Rev. Gen. Pl., ii. 615), *Ricinokarpus*, Burm., instead of being precisely equivalent to the American portion of *Ricinokarpus*, Boerh., is a *mélange* of three genera. The first of Burmann's seven species, which is figured (Thesaur. Zeyl., t. 92), is a *Tragia*; the sixth is the species treated by Endlicher in 1840 as the basis of *Mercurialis* § *Trismegista* (Gen. Pl., 1111), and made by Bentham in 1849 the type of the genus *Micrococca* (Hook. Niger. Fl., 503); the other five, of which the last is also figured (Thesaur. Zeyl., t. 93, Fig. 1), do belong to what Royen identified with the genus *Ricinocarpus*, Boerh., as represented by the Surinam plant collected by Hartog. Boerhaave so defined *Ricinokarpus* that we know which of the two species therein included is the type of his genus. Burmann provided no generic definition; it cannot, therefore, be said with certainty which of the three genera that he included in *Ricinokarpus* best interprets his conception. It was on this account incumbent on Linnaeus to treat the first species, which Burmann had figured (Thesaur. Zeyl., t. 92), as the type of *Ricinokarpus*, Burm. But this plant is very different from *Ricinokarpus*, Boerh., which is also the type of *Acalypha*, Roy.; it is, in fact, a *Tragia*, so that the identification by Linnaeus (Coroll. Gen., 19) of *Ricinokarpus*, Burm., with *Ricinokarpus*, Boerh., is not intelligible.<sup>1</sup> It is then remarkable to find an authority on matters of the kind so competent as Kuntze, after an accurate statement and a careful discussion of the facts, arriving at conclusions (Rev. Gen. Pl., ii. 615) which these facts appear to controvert. Thus Kuntze has said that because Linnaeus supposed that *Ricinokarpus*, Burm., is identical with *Ricinokarpus*, Boerh., therefore *Acalypha*, Roy., being a homonym of *Ricinokarpus*, Boerh., must be reduced to *Tragia*, Linn., of which *Ricinokarpus*, Burm. non Boerh., is a homonym. Further, Kuntze has said that, because Burmann did apply the name *Ricinokarpus* to certain species which appear to be congeneric with *Ricinokarpus*, Boerh., it is, therefore, necessary to employ—Kuntze says 'to reinstate'—the genus '*Ricinocarpus*, Burm.'

As regards the former conclusions: *Acalypha*, Roy., is a part—the

<sup>1</sup> What is practically the converse of this curious confusion was caused by Thunberg in 1794 (Prodr. Pl. Cap. 14) when he published as *Tragia capensis* a species of *Ctenomeria*, Harv., and as *T. villosa* a species of *Acalypha*, Roy.

3-coccos part—of *Ricinokarpos*, Boerh.; no part of *Ricinokarpos*, Boerh., is referable to *Tragia*, Linn.; therefore *Acalypha*, Roy., is not referable to *Tragia*, Linn. As regards the latter conclusion: Linnaeus was compelled to treat *Ricinokarpos*, Burm., as represented by the species placed first in order by Burmann under his genus and figured at t. 92 of the 'Thesaurus Zeylanicus'. This plant is a member of the genus *Tragia*, Linn., which has priority; the use of the name *Ricinocarpos*, Burm., advocated by Kuntze, is therefore precluded.

It would have been satisfactory if Royen had emulated Burmann in an effort to retain the name *Ricinokarpos* for the genus which Boerhaave intended so to characterize. But a generous regret that this was not done cannot alter the circumstance that, even when the criteria recognized by Kuntze in respect of the determination of the priority of generic names are observed, the genus *Acalypha*, Roy., remains properly characterized and validly established.

#### ADDITIONAL SOUTH AFRICAN MERCURIALINEAE.

The next *Mercurialis* after that of Hermann to be reported from South Africa was *M. annua*, Linn., recorded by N. L. Burmann (Fl. Cap. Prodr., 27. bis [31]) in 1768, and again by Thunberg (Prodr. Pl. Cap. 78) in 1794 and (Fl. Cap. ed. Schult., 387) in 1823. Müller in 1866 ignored both Burmann's record of 1768 and the similar record by Baillon made (*Adansonia*, iii. 158) in 1862; Thunberg's record he disposed of by reducing *M. annua*, Thunb. non Linn., to *Leidesia capensis*, Müll. arg. (DC. Prodr., xv. 2, 793). Had Burmann's statement been of a general character, some confusion between *M. annua* and *Leidesia capensis* might well have been suspected, and Müller's caution in accepting this South African record of a European species would have been natural. But the statement is a precise one; Burmann saw the Cape specimen of *M. annua*, Linn., in the herbarium of Oldenland, who, as we know from the elder Burmann,<sup>1</sup> gave especial attention to introduced plants already established at the Cape in 1737.

As regards the treatment accorded to Thunberg it has to be observed that there is nothing in what Thunberg says of *M. annua* which could prevent his plant from being the Linnean one, and the only sheet of

<sup>1</sup> To his *Thesaurus Zeylanicus* the elder Burmann attached two catalogues of Cape plants. The first of these, already quoted, which occupies pp. 1-23, enumerates the Cape plants of Hermann; the second, pp. 24-34, enumerates the Cape plants collected by Oldenland and by Hartog. The final page of this catalogue is devoted to *Plantae Exoticae in Capite Bonae Spei aequae laete germinantes ac in earum Patria*. The fact that there is no *Mercurialis* enumerated in this catalogue of Oldenland's Cape plants, and yet that there was a *Mercurialis* from the Cape among the specimens in Oldenland's herbarium, leaves us with little doubt that Oldenland considered this *Mercurialis* to be only an exotic species in the Cape Peninsula. It is not mentioned in the actual list of exotic species alluded to. But this is not surprising; that list is confined to plants of economic or aesthetic interest, and does not include garden- or field-weeds like *M. annua*.

*M. annua* in herb. Thunberg, which Müller has examined, and which, through the kindness of Professor Juel, the writer has also seen, shows that Müller's identification needs to be qualified. There are on Thunberg's sheet of *M. annua* two specimens; though he has written up both as *M. annua*, they belong to two species. One of the two has also been written up, correctly, by Müller as *M. annua*; the other, which Müller has written up as *Leidesia Sprengeliana*, is *Mercurialis procumbens*, Linn., and is what Müller later described as *L. capensis*. The reduction of *M. annua*, Thunb., to *L. capensis*, Müll. arg., involves the assumption that, of the two plants on his sheet, Thunberg had the *Leidesia* more particularly in view. This assumption, however, is not justifiable. Besides mixing two species on the sheet, Thunberg at one time had become confused with regard to their provenance; the sheet, on the reverse, is endorsed, by Thunberg himself, 'e Japonia Thunberg'. This proves that when he wrote this legend Thunberg knew that the specimens had been gathered during his travels. Neither species grows in Japan; Thunberg realized this in time, for he did not include *M. annua* in his 'Flora Japonica'. The *Leidesia* specimen could only have been gathered in South Africa; there is no reason for supposing that its companion was gathered anywhere else. Müller, in 1866, had the less justification for ignoring the genuine *M. annua* specimen in herb. Thunberg, because in 1862 Baillon (*Adansonia*, iii. 158) had recorded the presence in herb. Jussieu of a Cape specimen of *M. annua* named *Urtica capensis*<sup>1</sup> by Lehmann in 1832. There is, however, a stronger reason for believing that by *M. annua* Thunberg really intended the Linnean plant, and that the admixture of *Leidesia capensis*, Müll. arg., was fortuitous. We find in South Africa a second *Leidesia*, so closely allied to *L. capensis* that it only differs in having smaller capsules and seeds, rather fewer stamens, and rather fewer teeth on the leaf-margin. Yet this species, first described by Thunberg (*Fl. Cap. ed. Schult.*, 546) in 1823, was published, not as a *Mercurialis*, but as an *Acalypha*, *A. obtusa*, Thunb.<sup>2</sup> The doubt

<sup>1</sup> Baillon (l. c.) states that this specimen is a 'Un. i.' one; that is, a specimen of the 'Württemb. Reise-Verein' also known as the 'Naturhist. Reise-Verein zu Esslingen' or the 'Esslinger Reise-Verein'. This 'Verein' was founded by Steudel and Hochstetter in 1826 (*Flora*, ix. 1, 87). In 1832 it advertised (*Flora*, xv. 2, 406): 'Cap-Pflanzen gesammelt von Ecklon und herausgegeben v. d. Württembergischen Reiseverein, gekauft 1829. 692 sp.' In 1829 (*Flora*, xii. 1, 113) we find it announced that the 'Reiseverein' had just received a collection containing some three hundred species made by Ecklon of Cape Town. Lehmann's *Urtica capensis* is no doubt one of the species alluded to in that notice.

<sup>2</sup> The specimen of this plant, written up by Thunberg himself as *Acalypha obtusa*, is the basis of *Leidesia obtusa*, Müll. arg. (*DC. Prodr.*, xv. 2, 793). According to Steudel in 1841 (*Nomencl.*, ed. 2, i. 10), the name used by Sprengel when he took up this plant was the variant *A. obtusata*. No doubt, in intention, *A. obtusata*, Spreng., and *A. obtusa*, Thunb., are identical. But, in practice, Sprengel caused his name to cover not only *Leidesia obtusa*, Müll. arg. (= *Acalypha obtusa*, Thunb.), with 2-coccos capsules, but also a species with 3-coccos capsules treated by Müller as the basis of a distinct genus *Paradenocline* (l. c. 1141) which was in 1880 merged by Bentham in *Adenocline*, Turcz. To this genus *Adenocline* belongs another species described by Thunberg (*Fl. Cap.*, ed. Schult., 546) as *Acalypha acuta*, though in his herbarium he has written up some of the

felt by Müller has, however, been dispelled by Schlechter and by Kässner, who since 1866 have found that *M. annua* is present, as an introduced weed of cultivated ground, in the Cape and the Tulbagh divisions of the Coast region of South Africa. It is, however, to be noted that the Outeniqua locality given by Thunberg for *M. annua* (ed. Schult., 387) must relate to the *Leidesia*, which does occur in woods, not to the *Mercurialis*, which is only to be found in fields and gardens.

The next *Mercurialis* recorded from South Africa was *M. triandra*, E. Mey., a very distinct species described in 1829 (Linnaea, iv. 237) from specimens collected within the Orange River catchment area by Drège. This is the species which in 1858 was treated by Baillon (Étud. gén. Euphorb., 465, t. 9, fig. 7) as the basis of his genus *Seidelia*. Drège's other species of *Mercurialis* from South Africa were not enumerated till 1843 (Zwei Pfl. Documente, 201), where, in addition to *M. triandra*, E. Meyer has recorded *M. annua*?, Drège, and *M. tricocca*, E. Mey. The former is not *M. annua*, Linn.; it has a quincuncially imbricate in place of a valvate male calyx and a 3-coccous in place of a 2-coccous capsule, so that it is not even Mercurialineous. Curiously, the other species, *M. tricocca*, E. Mey., is in intention, and partly in practice, the same species with 3-coccous capsules and imbricate male calyx-lobes. But along with this non-Mercurialineous plant Meyer issued as *M. tricocca* both the *Leidesia* which Linnaeus had named *Mercurialis procumbens* and the one which Thunberg had named *Acalypha obtusa*.

The same year, 1843, saw the publication by Meissner (Hook. Lond. Journ. Bot., ii. 556-9), from specimens obtained by Krauss, of four species of *Mercurialis*, which, as they have 3-coccous capsules and imbricate calyx-lobes, are not Mercurialineae but belong to *Adenocline*, Turcz. They were enumerated again by Krauss himself in 1845 (Flora, xxviii. 84) with the addition (l. c., 85) of *M. tricocca*, on this occasion as limited by Ecklon and Zeyher to the plant with imbricate calyx and 3-coccous capsules, and without the confusion created by Meyer. In 1846 Kunze raised at Leipzig, from Cape seed sent by Zeyher, this same species, for which he provided a new name, *M. violaeifolia* (Ind. Sem. Hort. Bot. Lips. MDCCCXLVI, c. diagn.).<sup>1</sup> This 3-coccous plant he described more fully in 1847 (Linnaea, xx. 55), along with another raised from South African seed, which he had issued as *M. Zeyheri*, but which he now believed (l. c., 54) might be Meissner's *M. bupleuroides*. This latter plant, though undoubtedly, like Meissner's

sheets so described as *A. glabrata*. This species, according to Steudel, was taken up by Sprengel as *Acalypha acuta*. In 1843, however, when establishing the genus *Adenocline*, Turczaninow (Bull. Soc. Imp. Nat. Mosc., xvi. 1, 59) altered its trivial name 'acuta' to 'Mercurialis'.

<sup>1</sup> It appears possible that Kunze, in using this name, may have been subconsciously influenced by the idea that the plant designated might be Hermann's *Mercurialis africana dicoccos folio violae tricoloris*. It certainly much resembles Hermann's species in externals, but the imbricate calyx and the 3-coccous capsules show that it is not the same plant.

one, an *Adenocline*, differs sufficiently from *M. bupleuroides* to justify the use of the name *M. Zeyheri*.

Besides the *Urtica capensis*, already referred to, which is *Mercurialis annua*, Linn., there was distributed a second *Urtica capensis* (Un. It. 814, Eckl.), which is *Mercurialis procumbens*, Linn. We learn from Ecklon and Zeyher, in 1847 (*Linnaea*, xx. 213), in connexion with Zeyher's 3844 from Table Mountain, that Sprengel had altered the name of this second *Urtica capensis* to *Mercurialis capensis*, which, they further suggest, may be only E. Meyer's *M. tricocca*. It is not what was intended by E. Meyer as *M. tricocca*, because its capsules are 2-coccous. But it was in practice mixed by E. Meyer with *M. tricocca*, and we learn from Sonder that Sprengel fell into the converse error and mixed *M. tricocca* with it. In removing these misapprehensions Sonder, in 1850 (*Linnaea*, xxiii. 111, 112), provided brief diagnoses, restricting the name *M. tricocca*, E. Mey., to the plant on which, in 1866, Müller was to base his genus *Paradenocline*, and similarly restricting the name *M. capensis*, Spreng., to the plants on which, in 1866, Müller was to found his genus *Leidesia*. Sonder at the same time added to our debt by adequately diagnosing, as *M. pumila*, Sond., one of the species on which, in 1858, Baillon was to base the genus *Seidelia*. But Sonder's work is not free from defects. In the first place he overlooked the fact that the characters of *M. tricocca* are essentially those of his own genus *Diplostylis* (l. c., 113), which is a homonym of *Adenocline*, Turcz. Again, though he did notice that his *M. capensis* appeared variable, he did not observe that it really included two species. Lastly, through some misapprehension, he identified *M. tenella*, Meissn., which belongs to his own 3-coccous genus *Diplostylis*, with *M. triandra*, which is a 2-coccous species most closely related to his own *M. pumila*.

In 1858 Baillon based on *M. triandra*, E. Mey., and *M. pumila*, Sond., the valid Mercurialineous genus *Seidelia*, and treated all the species of *Mercurialis* enumerated by Krauss in 1845 as members of Turczaninow's genus *Adenocline*. In so doing he used Thunberg's specific name 'acuta' for the species which Turczaninow had termed *A. Mercurialis*, but maintained Turczaninow's name for the species termed *M. tricocca* by E. Meyer. As to this Baillon further followed Meyer's practice and included (*Étud. gén. Euphorb.*, 457) along with *M. violaefolia*, Kunze, which is an *Adenocline*, both of the species on which, eight years later, Müller was to found the genus *Leidesia*.

The year 1862 was marked by the appearance of Baillon's classical paper (*Adansonia*, iii. 169-76), in which all the forms reported from South Africa that are referable to the Mercurialineae and to the Adenoclineae were once more treated as species of *Mercurialis*. The action was less drastic, perhaps, than it appears; Baillon admitted the existence, within his widened genus, of five distinct sections. In dealing with the species from



South Africa which are referred to this widened genus (l. c., iii. 158-60), Baillon followed Sonder almost too closely, for under *M. capensis* he still included the two species of *Leidesia*, while under *M. triandra* he repeated Sonder's misapprehension as regards *M. tenella*. While properly adopting Kunze's name, *M. violaeifolia*, in place of E. Meyer's name, *M. tricocca*, Baillon has attributed the former name to E. Meyer; under *M. bupleuroides* he has quoted *M. annua*, Drège, which is really *M. violaeifolia*. His treatment of the species in the *Adenocline* section, as we shall find when dealing with that genus, is even more unsatisfactory.

The treatment of the sections was, after all, only an amplification of that proposed by Endlicher (Gen. Pl., IIII) in 1840. Endlicher's *Mercurialis*, which included *M. alternifolia*, Lamk. (= *Micrococca Mercurialis*, Benth.), was subdivided into  $\alpha$  *Linostosis*, with leaves opposite and capsules 2-coccous = the true *Mercurialis*, Linn.; and  $\beta$  *Trismegista*, with leaves alternate and capsules 3-coccous = *Micrococca*, Benth. In enumerating the South African species, Baillon placed in *Linostosis* only *M. annua*, Linn. In *Trismegista* Baillon placed two species: (1) *M. capensis*, which, while it is not a *Linostosis* because its leaves are mostly alternate, is not a *Trismegista* because its capsules are 2-coccous; and (2) *M. violaeifolia*, which, although it has 3-coccous capsules, cannot be a *Trismegista* because its male calyx-lobes are imbricate and its styles are 2-partite. To Endlicher's two sections Baillon added a section *Adenocline*, with 3-coccous capsules, divided styles, and imbricate calyx-segments, a section *Seidelia*, with 2-coccous capsules and cruciately 4-valved anthers, and, lastly, a section *Erythrococca* with, as was then erroneously believed, indehiscent fruits. All of these sections are natural groups; they are, indeed, valid genera. The only one of the five in respect of which Baillon, in dealing with the Cape species, was at fault is his *Trismegista*, which in the first place does not include any species really belonging to that section as limited by Endlicher, and, further, is a mixture of two genera, *Leidesia* and *Adenocline*. In the synoptic summary which follows his general paper (*Adansonia*, iii. 175), Baillon departed from this arrangement to the extent of reducing *Adenocline* as a whole to *Trismegista*, an unfortunate afterthought, seeing that *Adenocline* is not a member of the group *Mercurialineae*, and does not belong to the sub-tribe *Acalypheae* or *Dysopsidae*. Notwithstanding its imperfections, Baillon's treatment supplies the basis for a review of the situation. The number of South African forms referable to *Mercurialis*, as extended by Baillon in 1862, was known to be twelve. One of them is *M. annua*, Linn., which calls only for mention in passing; it is a true *Mercurialis*, but it is only an alien weed at the Cape. Four of the others agree with *Mercurialis* proper in having 2-coccous capsules, simple styles, and a valvately partite male calyx; the remaining seven differ from *Mercurialis* proper in having 3-coccous capsules, 2-partite styles, and a quincuncially imbricate male calyx.

All four 2-coccous forms deviate from *Mercurialis* proper in having alternate leaves and in being normally monoecious. Two of the four, which have firm opaque leaves, only 2-3 anthers, and quite glabrous capsules, differ further from *Mercurialis* in having cruciately 4-valved mature anthers. These became the basis in 1858 of the valid genus *Seidelia*, Baill. The remaining two, which have flaccid, pellucid leaves, 4-7 stamens with only 2-valved anthers, and hispidulous capsules, though generically distinct, had not so far been separated either sectionally or generically from *Mercurialis*, except when in 1858, and then, perhaps, only by accident, Baillon referred them to *Adenocline*.<sup>1</sup>

One of the 3-coccous forms with a 2-partite style and imbricate male calyx-lobes agrees with the two preceding forms in having flaccid, pellucid leaves and in being monoecious. This was, in 1858, referred by Baillon, but only in company with the two preceding forms, to *Adenocline*; it was not so treated by Turczaninow, and Sonder, whose *Diplostylis* is a homonym of *Adenocline*, left this monoecious species in *Mercurialis* as *M. tricocca*. The remaining six 3-coccous forms with 2-partite styles and imbricate calyx-lobes have firmly herbaceous leaves and are dioecious. They constitute the genus *Adenocline*, Turcz. (1843): *Diplostylis*, Sond. (1850).

None of the three forms with flaccid, pellucid leaves have ever been confused with *Seidelia*. They have, however, been much confused in books and in herbaria among themselves. In three instances—by E. Meyer under the name *Mercurialis tricocca*, by Sprengel under the name *M. capensis*, and by Baillon under the name *Adenocline Mercurialis*—all three have been treated as belonging to the same species. More often, however, the existence of two species among the forms with flaccid, pellucid leaves has been admitted. In literature—as, for example, by Sonder and by Baillon—it has been the custom to distinguish between a species with 2-coccous capsules, termed *M. capensis*, and another species, with 3-coccous capsules, termed by Sonder *M. tricocca*, by Baillon *M. violaeifolia*. As a consequence, the species described by Thunberg as *Acalypha obtusa* has never, in any published work, been separated from the species described by Linnaeus as *Mercurialis procumbens*. In collections, however, the confusion has been somewhat different. Nearly allied as *Acalypha obtusa* and *Mercurialis procumbens* are, they are easily sorted out and have rarely been laid into herbaria side by side. On the other hand, in spite of their differing as regards their stamens—central in *Acalypha obtusa*, peripheral and 2-seriate in *M. violaeifolia*; their capsules—2-coccous in the former, 3-coccous in the latter; their styles—simple in the first, 2-partite in the second; and their male calyces—valvately partite in one, quincuncially imbricate in the

<sup>1</sup> As *Adenocline Mercurialis*, which Baillon attributed to Turczaninow, but which did not include Turczaninow's species so named, though it did include *Mercurialis procumbens*, Linn., *Acalypha obtusa*, Thunb., and *Mercurialis violaeifolia*, Kunze.

other—these two plants so closely resemble each other that even in the field the most careful of collectors have at times been led astray.

To Müller our thanks are due for having, in 1866, determined this double confusion. He rectified matters by establishing the genus *Leidesia* for the reception of *M. capensis*, Sond., and at the same time by distinguishing as *L. obtusa* the somewhat elusive species which, as to bibliography, had hitherto been merged in its 2-coccous congener, but, as to practice, was in herbaria mainly to be met with in the covers containing the 3-coccous South African species with flaccid, pellucid leaves. This last species, with androgynous inflorescences, 3-coccous capsules, 2-partite styles, and imbricate calyx-lobes, Müller treated as a distinct genus, *Paradenocline*, Müll. arg., most nearly allied to *Adenocline*, Turcz. When doing so, Müller pointed out that these two genera, *Adenocline* and *Paradenocline*, conjointly form a distinct and natural group, which he named Adenoclineae and referred to the sub-tribe Hippomaneae (DC. Prodr., xv. 2, 1139).

The recent history of these South African groups has not been eventful. It has, however, been found necessary to add to *Leidesia* a new species, *L. formula*, Prain (Kew Bulletin, 1912, 337), and to *Adenocline* another new species, *A. stricta*, Prain (l. c., 338).

#### REVIEW OF SEIDELIA.

The genus *Seidelia* was established by Baillon in 1858 (Étud. gén. Euphorb., 465, t. 9, fig. 7) for two South African species till then included in *Mercurialis*. One of these, first collected by Drège in the Orange-Vaal basin, is *M. triandra*, E. Mey. (Linnaea, iv. 237), published in 1829; the other, found by Zeyher in the Coast Region of Cape Colony, is *M. pumila*, Sond. (Linnaea, xxiii. 112), published in 1850. In 1862 Baillon replaced *Seidelia*, as a distinct section, in *Mercurialis* (*Adansonia*, iii. 160, 175).

When dealing with *Seidelia* in 1866 (DC. Prodr., xv. 2, 947) Müller differed from Baillon in two respects. Müller treated the two species accepted by Baillon as varieties of one; at the same time he transferred the whole section 'Seidelia' from *Mercurialis* to *Tragia*. The only apparent reason for this transfer is that *Seidelia* and *Tragia* normally have each three stamens. The transfer was not accepted by Hooker in 1868 (Harv. Gen. S. Afr. Pl., ed. 1, 338); it was repudiated by Bentham in 1880 (Gen. Pl., iii. 311). Hooker followed Baillon in recognizing two species; Bentham accepted Müller's view that there is but one variable *Seidelia*. For this view there was as little ground as there was for the transfer of *Seidelia* to *Tragia*. Bentham has stated that *Seidelia* is closely allied to *Adenocline*; the differences between the two as regards flowers, to which Bentham was fully alive, make this statement as hard to accept as Müller's view that *Seidelia* is closely allied to *Tragia*. There is, no doubt, a general similarity between some species of *Adenocline* and certain species of *Mercurialis*;

there is a close affinity between *Mercurialis* and *Seidelia*. But between *Adenocline* and *Seidelia* there is little external resemblance and even less affinity; *Adenocline* belongs to the Gelonieae, *Seidelia* to the Acalyphaeae.

The nearest relationship of *Seidelia* is with the genus *Leidesia*. Both agree with *Mercurialis* in their simple styles, 2-coccous capsule, and valvately partite male calyx; both differ from *Mercurialis* in having alternate, not opposite leaves; both are usually monoecious, *Mercurialis* is usually dioecious. They differ from each other because in *Seidelia* the anthers are cruciately 4-valved and the female calyx and hypogynous disc-glands are well developed, while in *Leidesia* the anthers are 2-valved and the female calyx and hypogynous disc-glands are usually small or obsolete. In *Seidelia* the capsules are glabrous; in *Leidesia* they are setulose.

#### REVIEW OF LEIDESIA.

The genus *Leidesia* was founded by Müller in 1866 (DC. Prodr., xv. 2, 792) to include two South African species. One is the plant which Linnaeus named *Mercurialis androgyna* in 1737, *M. procumbens* in 1753, and *Croton Ricinocarpos* in 1763. The other is the plant described by Thunberg in 1823 as *Acalypha obtusa* (Flor. Cap., ed. Schult., 546). The history of the first species has been recounted. The second species has a brief history; it never was formally transferred from *Acalypha*. This, however, is not because the plant is an *Acalypha*, but because Sonder in 1850 (Linnaea, xxiii. 112) and Baillon in 1862 (Adansonia, iii. 158) did not separate these two South African congeners.<sup>1</sup>

Since the word *Leidesia* is an anagram of the name *Seidelia* (DC. Prodr., xv. 2, 793) it is probable that, when he devised the name *Leidesia*, Müller thought *Seidelia* a valid genus, the transfer of which to *Tragia* was a sudden, as well as an unhappy afterthought. A possible sequel of this afterthought is the citation by Müller under *Leidesia* of 'Mercurialis, sect. Seidelia, Baill., Rec. d'obs. bot., vol. 3, p. 158 pr. p. et p. 175 pr. p.' (l. c., 792). This reduction contradicts the citation of 'Mercurialis, sect. Seidelia' as a whole, under *Tragia*, sect. *Seidelia* (l. c., 947). That the citation at p. 792 is a *lapsus* we learn from a third passage (l. c., 1141) where the correct name 'Mercurialis, sect. Trismegista' is used.

Of the three names applied by Linnaeus to the first species on which the genus *Leidesia* is based, Müller only associated the last one with this plant with 2-coccous capsules; the first name he associated with an American, the second name with an African species, both of which have 3-coccous capsules. Even as regards the third name Müller decided that it must be set aside.

<sup>1</sup> In 1843 E. Meyer (Drège, Zwei Pfl. Documente, 201) also aggregated the two species of *Leidesia*, and united both with a 3-coccous plant which he had named *Mercurialis tricocca*. The same amalgamation was repeated by Baillon in 1858 (Étud. gén. Euphorb., 457) under the name *Adenocline Mercurialis*, Baill. non Turcz.

When he examined the South African sheet of *Mercurialis annua* in herb. Thunberg, Müller wrote up the portion which belongs to *Leidesia* as *L. Sprengeliana*. This name, however, he altered to *L. Sonderiana* (DC. Prodr., xv. 2, 699), and as a further afterthought changed to *L. capensis*, Müll. arg. (l. c., 793). These earlier tentative names indicate that the term 'capensis' was taken up by Müller from Sprengel and from Sonder, who in turn had taken it up from specimens collected on Table Mountain by Ecklon and issued (Un. It. 814) as *Urtica capensis*, Thunb. Sonder in 1850 (Linnaea, xxiii. 112) assumed that this identification was correct, and further, relying upon Thunberg (Flor. Cap., ed. Schult., 155), assumed that, if the plant really were *U. capensis*, Thunb. (Prodr. Pl. Cap., 31 of 1794), it must also be *U. capensis*, Linn. f., of 1781 (Suppl. Pl., 417) and of 1784 (Syst. Veg., ed. 14, 850). Baillon in 1862 (Adansonia, iii. 158) realized that caution was needed in connexion with this name, and showed that one 'Un. It.' specimen, named *U. capensis*, Thunb., by Lehmann, is *Mercurialis annua*, Linn. But while dealing appropriately with this plant, Baillon accepted Sonder's verdict as regards Ecklon's n. 814, and in this he was followed by Müller in 1866. Baillon quoted Thunberg and copied from him the Linnean citation of 1784; Müller quoted Thunberg and copied from him the Linnean citation of 1781. But neither Baillon nor Müller examined the specimens in the *Urtica* covers in the herbaria of Thunberg and of Linnaeus. As a consequence, both Baillon and Müller have failed to observe that the *Mercurialis capensis* of Sprengel and Sonder and Baillon (*Leidesia capensis*, Müll. arg.) has no more to do with *Urtica capensis*, Thunb., or with *U. capensis*, Linn. f., than these two plants have to do with each other.

The specimen which forms the basis of *Urtica capensis*, Linn. f. (Suppl. Pl. 417), was presented by Thunberg to Linnaeus, without a name, after the appearance of the second *Mantissa* in 1771. The specimen was written up by Linnaeus, in his usual hand, as 'T. 326' and as '*Urtica africana*'; it is in the *Urtica* cover in the Linnean herbarium now (Jackson, Ind. Linn. Herb. 148). The description was not published until after the death of Linnaeus; when publishing it, the younger Linnaeus, possibly by accident, altered his father's name '*africana*' to *capensis*. The specimen is a good one; the description is apt; the plant is the one which has been treated by Müller (DC. Prodr., xv. 2, 864) as *Acalypha decumbens, a villosa*. The endorsement 'T. 326' having been written by Linnaeus, not by Thunberg, suggests that the number was not bestowed on the specimen by Thunberg. In any case, Thunberg was not able to decide what, among the plants he had presented to Linnaeus, the species which the younger Linnaeus had described as *Urtica capensis* might be. The duplicate kept by Thunberg himself of the specimen now in the *Urtica* cover of the Linnean herbarium which is the type of *U. capensis*, Linn. f., was used by Thunberg as the type of

*Tragia villosa*, Thunb. (Prodr. Pl. Cap., 14, and Flor. Cap., ed. Schult., 37), while *U. capensis*, Thunb., is altogether different. The specimens of *Urtica* in herb. Thunberg, kindly lent for study by Professor Juel, show that under *U. capensis* there are two sheets written up as 'capensis  $\alpha$ ' and 'capensis  $\beta$ ' respectively. On the 'capensis  $\alpha$ ' sheet we find two plants; one of the two, which agrees with the description, is *Australina capensis*, Wedd. (Ann. Sci. Nat., sér. 4, i. 212 (1854)); the other is *Droguetia Thunbergii*, N. E. Brown (Kew Bulletin, 1913, 80).<sup>1</sup> The sheet marked 'capensis  $\beta$ ' has only *Australina capensis*, Wedd.

The relationship of *Leidesia* to *Seidelia*, and of both to *Mercurialis*, we have already learned; the three genera taken conjointly constitute a distinct group, the Mercurialineae,<sup>2</sup> characterized by its valvately partite male calyx, its simple styles, and its 2-coccous capsule.

#### REVIEW OF PARADENOCLINE.

The genus *Paradenocline* was proposed by Müller in 1866 (DC. Prodr., xv. 2, 1141) to include a South African species with all the facies of a *Leidesia*, which nevertheless had to be excluded not only from that genus but from the subtribe Acalypheae in which *Leidesia* is placed, because the species in question has a quincuncially imbricate male calyx and has 2-partite styles. So far as can be ascertained, this species was first collected by Drège in the neighbourhood of Paarl. From E. Meyer we learn that Drège, when he first found the plant, thought that he had met with the European *Mercurialis annua*. In 1843 E. Meyer issued the Paarl specimens of this species under Drège's name. But Drège collected the same plant at Addo in Uitenhage, and we learn from specimens of this gathering written up in herb. Lübeck, that this is the species to which E. Meyer intended to restrict the name *M. tricocca*, also issued for the first time in 1843. Actually, however, in 1843 Meyer included under his *M. tricocca* not only this 3-coccous species but both of the species of *Leidesia* in which the capsules are 2-coccous, the styles are simple, and the male calyces are valvately partite. From Sonder we learn that some time prior to 1850 Sprengel

<sup>1</sup> *Droguetia Thunbergii*, N. E. Brown, is similarly mixed in herb. Thunberg with *Urtica caffra*, Thunb. (Prodr. Pl. Cap., 31; Flor. Cap., ed. Schult., 155). Under this species, again, two sheets have been written up as 'caffra  $\alpha$ ' and 'caffra  $\beta$ ' respectively. The 'caffra  $\alpha$ ' sheet has *Droguetia Thunbergii*, N. E. Brown, only; with this plant, however, the description of *U. caffra* does not tally. The 'caffra  $\beta$ ' sheet has a plant with which Thunberg's description of *U. caffra* exactly agrees. This plant is another species of *Australina*, which must therefore be known as *A. caffra*. When Weddell monographed the Urticaceae he had not seen this type specimen in herb. Thunberg, because he suggested (DC. Prodr., xvi, 1, 60) that *U. caffra*, Thunb., may be *Fleurya peduncularis*, Wedd., and because he has described the species which is *U. caffra*, and which therefore must be known as *Australina caffra*, under the name *A. acuminata*, Wedd. (Ann. Sci. Nat. sér. 4, i. 212 (1854)).

<sup>2</sup> The name *Mercurialineae* is here employed in a more restricted sense than that understood by Pax (Nat. Pflanzenf., iii. 5, 46).

had written up the same aggregate of three species and two genera as *M. capensis*. In 1858 Baillon renamed the same conglomerate *Adenocline Mercurialis*, using this name in a sense different from that in which it was employed in 1843 by Turczaninow.

Though it was not recognized that Meyer in 1843 had used two names, *M. annua*, Drège non Linn., and *M. tricocca*, E. Mey., for the same plant, it was soon noticed that more than one plant had been issued under the name *M. tricocca*, and we learn from Krauss that by 1845 Ecklon and Zeyher had already restricted the incidence of the name *M. tricocca* to the species with 3-coccous capsules. Sonder in 1850 (Linnaea, xxiii. 111) adopted what had been Meyer's intention and Ecklon and Zeyher's usage; by providing a brief diagnosis of the plant Sonder for the first time made it possible to cite Meyer's name. But Sonder's action was too late to effect its purpose. In 1846 Kunze had applied to the same species the name *M. violaeifolia* (Ind. Sem. Hort. Bot. Lips. MDCCCXLVI, c. diagn.), and in 1847 had described it more fully under the same name (Linnaea, xx. 55). Kunze again referred to the species as *M. violaeifolia* in 1851 (Linnaea, xxiv. 162); it is under this name therefore that Baillon accounted for the species in 1862 (Adansonia, iii. 159). There is nothing to indicate that Kunze suspected his *Mercurialis violaeifolia* to be what Drège had mistaken in the field for *M. annua*, or to be what E. Meyer intended to indicate and Krauss did indicate by *M. tricocca*. But the name employed by Kunze does suggest that, whether he believed the two plants to be identical or not, he had gone to Hermann's phrase *Mercurialis africana dicoccos folio violae tricoloris* for the idea which his own specific epithet conveys. The description given by Kunze is so careful—the only serious error is the statement that the styles are entire—that it is most unlikely that he should have thought his 3-coccous species identical with the 2-coccous plant of Hermann. The name selected by Kunze had, however, a curious after-effect.

When Müller first referred to the species on which his *Paradenocline* was based (DC. Prodr., xv. 2, 793) he adopted from Baillon the name used by Kunze, and termed the plant *P. violaeifolia*; as an afterthought (l. c., 1141) Müller treated as a certainty the idea which Kunze's name 'violaeifolia' suggests. Since Kunze's name may have been based on Hermann's name, and since Linnaeus has cited Hermann's plant under *M. procumbens*, Müller decided that *M. violaeifolia*, Kunze, and *M. procumbens*, Linn., are identical, and that the name *Paradenocline violaeifolia*, Müll. arg., must be replaced by the name *P. procumbens*.<sup>1</sup> Even if the premisses had been sound, the conclusion could not have been sustained; *P. procumbens*, Müll. arg., is a species which does not occur in the Linnean herbarium, and has not been

<sup>1</sup> On p. 793 both names are used—*P. procumbens* in the note under the generic description of *Leidesia*, *P. violaeifolia* in that under the account of *L. obtusa*.

referred to in any of the writings of Linnaeus; the plant which Linnaeus in 1753 did term *Mercurialia procumbens* is a species of *Leidesia*.

When founding the genus *Paradenocline* in 1866 Müller indicated its affinity to *Adenocline*, Turcz., to which genus Baillon in 1858 had, after a fashion, transferred its solitary species. Müller treated the two genera as constituting a distinct group, the Adenoclineae, founded by him in 1865 (Linnaea, xxxiv. 203) and characterized by its circumferentially inserted stamens and certain other characters. From *Adenocline* Müller distinguished *Paradenocline* because in the latter the anther cells are at first pendent as in *Mercurialis* itself; he made no use of the erroneous character of entire styles which he had copied from Kunze. Bentham may have observed that this latter difference was non-existent; he believed the former character to be at least inconstant, and decided in 1880 (Gen. Pl., iii. 310) to revert to the view adopted by Baillon in 1858. In this Bentham was followed by Pax in 1890 (Nat. Pflanzenf., iii. 5, 49). This action is, however, somewhat too drastic and may, in part at least, have been encouraged if not induced by an error into which Bentham has been betrayed in his statement that *Adenocline*, Turcz., is a monoecious genus. The flaccid, pellucid foliage, the annual habit, and the androgynous inflorescences render *Paradenocline*, Müll. arg., so different from *Adenocline*, Turcz., that the claim of the former to rank as, at least, a distinct section is not open to dispute.

#### REVIEW OF ADENOCLINE.

The genus *Adenocline* was established by Turczaninow early in 1843 (Bull. Soc. Imp. Nat., Mosc., xvi. 1, 59) to include some South African species collected by Drège and Zeyher. Only one of these was known before 1843. This is the plant which Thunberg in his herbarium wrote up as *Acalypha glabrata*, but which was described in 1823 (Flor. Cap., ed. Schult., 546) as *A. acuta*, Thunb., a name repeated by Steudel in 1841 (Nomencl., ed. 2, i. 10).

When in 1843 E. Meyer referred what is *Paradenocline*, Müll. arg., to *Mercurialis*, he did not name any of the plants that Turczaninow included in *Adenocline*. Later in 1843 Meissner described as species of *Mercurialis* specimens of most of the species of *Adenocline*. That Meissner had not seen Turczaninow's paper is shown by his reference under *M. bupleuroides* to specimens collected by Drège and cited by Turczaninow. By way of compensation there appeared in 1844 (Flora, xxvii. 121) a *résumé* of Turczaninow's paper. Continuing the seesaw, Krauss, who had collected most of the specimens alluded to by Meissner in 1843, gave a *résumé* of Meissner's paper in 1845 (Flora, xxviii. 84) without observing that he was dealing with Turczaninow's genus, and without the attention of the editor of 'Flora' being attracted to this fact. It is clear that Turczaninow's paper was unknown to Kunze in 1847, when he dealt, as a species of *Mercurialis*,



with an *Adenocline* raised at Leipzig from South African seed (Linnaea, xx. 54). It was still unknown to Sonder when in 1850 (Linnaea, xxiii. 113) he published as *Diplostylis*, Sond., the genus already established as *Adenocline*, Turcz.

So long as this neglect of his more accurate observation only involved the inclusion of *Adenocline* in *Mercurialis*, Turczaninow was under no obligation to re-enter the field. Lamarck in 1796 (Encyc. Meth., iv. 120) had recognized as a species of *Mercurialis* a plant with alternate leaves and 3-coccos capsules; Endlicher in 1840 (Gen. Pl., 1111) had founded a distinct section for its accommodation. All the South African species which Meissner, Krauss, and Kunze had treated as species of *Mercurialis* agree with *M. alternifolia*, Lamk., as regards their capsules, and all but one do so as regards their phyllotaxis. So long as they could feel that an imbricate in place of a valvate calyx, and 2-partite in place of a simple style were negligible differences, Meissner and Krauss and Kunze were at liberty to conclude that any *Adenocline* might be referred to Endlicher's *Mercurialis*, sect. *Trismegista*. When, however, in 1849 Bentham based on Lamarck's species the genus *Micrococca* (Hook., Niger Flor., 503) the *raison d'être* of Endlicher's *Trismegista* disappeared, and, notwithstanding the advocacy by Thwaites and others of a different view, the soundness of Bentham's judgement has remained unshaken. The establishment of *Micrococca*, Benth., rendered the separate generic recognition of the South African 'Trismegistae' of Meissner, Krauss, and Kunze inevitable, though it is possible that when Sonder in 1850 proposed his genus *Diplostylis* he was as unconscious of this fact as he was of the circumstance that Turczaninow had appreciated the situation seven years before. The publication and acceptance of *Diplostylis* made it, however, incumbent upon Turczaninow to point out the true state of affairs. This he did in 1852 (Bull. Soc. Imp. Nat., Mosc., xxv. 2, 179, 180).

In 1858 Baillon (Étud. gén. Euphorb., 456) accepted Turczaninow's genus and included it in *Mercurialis violaeifolia*, placing *Adenocline* in his Dysopsidae, a group which includes *Acalypha*, midway between *Mercurialis* and *Seidelia*. In 1862 Baillon modified this view and widened the limits of *Mercurialis* so as to include *Adenocline*, Turcz., in the first instance (Adansonia, iii. 159) as a distinct section, but, as an afterthought (l. c., 175), as an integral portion of Endlicher's section *Trismegista*. In 1866 Müller accepted the genus as limited by Turczaninow and Sonder (DC. Prodr., xv. 2, 1139), placing it and *Paradenocline* in a distinct group, the Adenoclineae, which he referred to the sub-tribe Hippomaneae. The genus was accepted by Hooker in 1868 (Harv. Gen. S. Afr. Pl., ed. 2, 338), by Bentham in 1880 (Gen. Pl., iii. 310), and by Pax in 1890 (Nat. Pflanzenf., iii. 5, 49). Hooker did not discuss the limitation or the affinities of *Adenocline*. Bentham disapproved of Müller's treatment; like Baillon in 1858, he

treated *Paradenocline* as part of *Adenocline*; like Baillon also, he replaced the genus in the sub-tribe *Acalypheae*, between *Leidesia* and *Seidelia*. In this Bentham has been followed by Pax, who has placed *Adenocline* between *Erythrococca* and *Mercurialis*.<sup>1</sup> It is, however, doubtful whether *Paradenocline* ought not to be given a generic status; there is no doubt that it deserves at least sectional rank, and that its unqualified inclusion in *Adenocline* is hardly justified. There is no question that any reversion to the view of Baillon that *Adenocline* is closely related to *Mercurialis* is a retrograde step. Probably the disregard which recent authors have shown for Müller's facts is traceable to the effect of Müller's conclusion. In transferring *Adenocline* and *Paradenocline* to the *Hippomaneae*, Müller has shown almost as little consideration for the natural characters of his group as did those authors who have held that *Adenocline* is a part of, or is allied to, the genus *Mercurialis*. But the fact that Müller did not happen to suggest the most suitable position for the *Adenoclineae* is no excuse for a reversion to a view which Müller had shown to be erroneous, and affords no justification for the suppression of this natural group. The *Adenoclineae* of Müller agree so absolutely with the *Geloniceae* as defined by Bentham (*Gen. Pl.*, iii. 253) that their natural situation is not really a matter for debate.

Little difficulty is experienced in separating the species that are to be met with in *Adenocline* proper. Among the seven species included, one, *A. acuta*, Baill., is at once distinguished from the other six by having opposite leaves. Among the remaining six, one, *A. stricta*, Prain, has all the leaves sessile, and has large leafy stipules. The other five have at least the lowest leaves distinctly petioled. Two of the five have the upper leaves also petioled; they are *A. ovalifolia*, Turcz., with leafy stipules, and *A. humilis*, Turcz., with minute stipules. Of the three that remain, two, *A. sessilifolia*, Turcz., and *A. Zeyheri*, Prain, have the lower petioled leaves narrow-lanceolate; they are distinguished from each other because in *A. sessilifolia* the upper sessile leaves are entire, in *A. Zeyheri* they are serrate. In the last species of our list, *A. bupleuroides*, Prain, at least the lowest and petiolate leaves, sometimes even the upper sessile leaves also, are wide-ovate or orbicular. Simple, however, as the task of discrimination is, there have been difficulties, largely of a bibliographical nature, in accounting for certain names, and in one case, that of *A. Zeyheri*, some real difficulty has been met with in dealing with the actual specimens.

In 1843 Turczaninow enumerated five species, two with opposite leaves, *A. Mercurialis* (Drège 2301, male) and *A. pauciflora* (Drège 3441, both male and female); three with alternate leaves, *A. ovalifolia* (an unnumbered

<sup>1</sup> For some reason Bentham has stated, and Pax has accepted the statement, that *Adenocline* is a monoecious genus. One of the most characteristic features of *Adenocline* proper is that all the species are strictly dioecious. *Paradenocline* is monoecious, but this is one of the circumstances which renders its separate recognition, at least as a section, desirable.

male plant collected by Zeyher), *A. humilis* (Drège 8223, male), and, lastly, *A. sessilifolia* (Drège 1867 and 1868, both male). The second species is a spurious one; in the male specimens the leaves are not opposite, so that this portion has to be excluded from the species *A. pauciflora* and transferred to *A. humilis*; with which it agrees. At the same time the female specimen, which does have opposite leaves and therefore is *A. pauciflora*, Turcz., is only the other sex of *A. Mercurialis*, Turcz. The last 'species', *A. sessilifolia*, is a mixture of two distinct plants.

Meissner's species of 1843 were *Mercurialis tenella* = Krauss 1191 male = *Adenocline humilis*, Turcz.; *M. bupleuroides* = Krauss 1169 male, a species unknown to Turczaninow—though Meissner has placed here Drège 1867 definitely and Drège 8223 doubtfully, these two plants differ specifically from each other and from *M. bupleuroides*; *M. serrata* = Krauss 1190 male = *A. ovalifolia*, Turcz.; *M. caffra* in two varieties,  $\alpha$  *brevipes* = Krauss 156 male = *A. pauciflora*, Turcz., as to description, and  $\beta$  *longipes* = Krauss 1192 = *A. Mercurialis*, Turcz. The treatment by Turczaninow and Meissner is thus singularly uniform. The chief differences are that Meissner found room only for two varieties, *M. caffra*,  $\alpha$  *brevipes* and  $\beta$  *longipes*, where Turczaninow had recognized two species, *A. pauciflora* and *A. Mercurialis*; also that the two authors treated Drège 1867 differently. But in the latter case the discrepancy is apparent rather than real; Turczaninow united Drège 1867 with *A. sessilifolia*, a species unknown to Meissner, while Meissner united Drège 1867 with *M. bupleuroides*, a species unknown to Turczaninow. As a matter of fact, Drège 1867 belongs to neither species, but is identical with the one for which, in 1847, Kunze half-heartedly suggested the name *M. Zeyheri*.

In 1850 Sonder had only four species. The first is *Diplostylis angustifolia*, and as this includes Drège 1868 it is = *A. sessilifolia*, Turcz. Sonder has cited four gatherings: Drège, 1868; Ecklon & Zeyher, 40; Ecklon & Zeyher, 39 (Riet Valley); Zuurberg, Zeyher. The last is not in herb. Sonder, and the identification is somewhat improbable. The other three are conspecific. The second species is *D. bupleuroides*; only two gatherings are quoted, in both cases the plant is *M. bupleuroides*, Meissn. Equally simple is *D. caffra*, since all the gatherings cited belong either to *M. caffra*,  $\alpha$  *brevipes*, Meissn., or  $\beta$  *longipes*, Meissn., and all belong either to *A. pauciflora*, Turcz., or to *A. Mercurialis*, Turcz.; but Sonder's treatment is an improvement on that of both Turczaninow and Meissner, since it amalgamates what were two poor species and two indifferent varieties. But the remaining species, *D. serrata*, Sond., is a *mélange* of two plants. There are in herb. Sonder four specimens to which this name has been attached. One of these is part of 'Ecklon & Zeyher 39', collected at Swellendam by Mund; another is 'Zeyher 1516', collected by Stack; both of these are *A. ovalifolia*, Turcz. The third is part of 'Ecklon & Zeyher 39', gathered

by these collectors themselves near Uitenhage; the last is 'Drège 1867 a': both of these are *Mercurialis Zeyheri*, Kunze. Sonder then made the limits of *Adenocline sessilifolia* natural by excluding Drège 1867; he also made the limits of *Mercurialis bupleuroides* natural by excluding Drège 1867. But he did so at the expense of his own *Diplostylis serrata*, which he clearly intended to be identical with *Mercurialis serrata*, Meisn. = *Adenocline ovalifolia*, Turcz. In reality *D. serrata*, Sond., is a mixture of *A. ovalifolia*, Turcz., and *M. Zeyheri*, Kunze (Drège 1867).

In overhauling *Adenocline* in 1852, Turczaninow introduced some improvements. He deleted the spurious *A. pauciflora*, so that his *A. Mercurialis* became strictly homonymous with *Diplostylis caffra*. He removed Drège 1867 from *A. sessilifolia*, so that this species became strictly homonymous with *Diplostylis angustifolia*. Turczaninow once for all set Drège 1867, which so far had been the invariable stumbling-block, on a sound footing by treating it as the valid species that it is. But from this point onwards fortune was unkind to Turczaninow. He had not seen a specimen of *Mercurialis Zeyheri*, Kunze, and did not know, any more than Kunze himself did, that this is the species to which Drège 1867 belongs. Turczaninow had not seen any specimen of *M. serrata*, Meissn.; he, therefore, did not know that Meissner's plant is his own *A. ovalifolia*. Nor did Turczaninow see all the specimens of *Diplostylis serrata*, Sond.; he therefore did not know that Sonder had confused under this name two unmistakable species. But Turczaninow did possess a specimen of Drège 1867; he knew that Sonder had included this in *D. serrata*. In giving the name *Adenocline serrata* to Drège 1867, Turczaninow only did what was natural. But, thanks to this misplaced reliance on Sonder's judgement, Turczaninow's *A. serrata* happens to be that portion of Sonder's *Diplostylis serrata* which is not the original *Mercurialis serrata* of Meissner. In the matter of *Adenocline humilis* Turczaninow was even more unfortunate. Sonder had guessed that *Mercurialis tenella*, Meissn., was only *M. triandra*, E. Mey., and therefore not an *Adenocline* or *Diplostylis* at all. Turczaninow mistook this surmise for a record of observation and failed to notice that *M. tenella*, Meissn., from the description, must be *A. humilis*, Turcz. Thinking that *M. tenella* really was disposed of, Turczaninow had only *M. bupleuroides*, Meissn., left to account for. He fell a victim to the temptation and identified *M. bupleuroides* with his own *A. humilis*!

The confusion that had grown up between the publication of *Adenocline* by Turczaninow in 1843 and that author's revision nine years later is, it will be seen, less serious than at first sight appears, and has been due to Meissner and Sonder and Turczaninow having been unable to compare each other's material. The confusion which has taken place since 1852 is less easy to account for. Baillon in 1858 substituted for the specific names 'Mercurialis' of Turczaninow, and 'caffra' of Meissner and Sonder, the older name 'acuta'

of Thunberg. This is quite intelligible. What, however, is not intelligible is that Baillon did not treat the name *Adenocline Mercurialis*, Turcz., as a synonym of *A. acuta*, Baill.; he maintained the name *A. Mercurialis*, ostensibly on the authority of Turczaninow, to connote a mixture of *Paradenocline procumbens*, Müll. arg., *Leidesia capensis*, Müll. arg., and *L. obtusa*, Müll. arg. The use of the name *A. sessiliflora* in place of *A. sessilifolia* is no doubt a mere *lapsus*. But it is hardly possible to explain the retention of *A. pauciflora*, Turcz., after Turczaninow had confessed that no such species exists. Finally *A. humilis*, Baill., which is said to be *Mercurialis serrata*, Meissn., and if it be so is therefore *Adenocline ovalifolia*, Turcz., cannot possibly be *A. humilis*, Turcz. In 1862 Baillon treated the five species recognized in 1858 rather differently. All of them were now looked upon as species of *Mercurialis*; some of them only were placed in the section *Adenocline*. The *A. Mercurialis* of 1858 was transferred to the section *Trismegista* and subdivided into *M. capensis*, corresponding to the genus *Leidesia* as a whole, and *M. violaeifolia*, corresponding to Müller's proposed genus *Paradenocline*. The other four species were now reduced to three, one of which, *M. caffra*, is the opposite-leaved *Adenocline acuta*, Baill., the true *A. Mercurialis*, Turcz., as to the identity and limitation of which mistake is barely conceivable. The non-existent *A. pauciflora* was still kept up as *M. pauciflora*, while all the alternate-leaved species of *Adenocline*, Turcz., and *Diplostylis*, Sond., with, in addition, *M. annua*, Drège non Linn., which is Baillon's own *M. violaeifolia*, were lumped together as *M. bupleuroides*, Meissn., the one species described by Meissner of which Turczaninow never saw a specimen.

Only one more step was required to complete the confusion. This Müller took when, in 1866, he united the conglomerate 'bupleuroides' and the fictitious 'pauciflora' of Baillon under the name *Adenocline pauciflora*, Müll. arg. (DC. Prodr., xv. 2, 1139), thus using for this widened species the one name employed by Turczaninow in 1843 which that author in 1852 found it necessary to cancel. That the species thus proposed is a composite one needs no demonstration; Müller has tacitly admitted the fact by making a careful attempt to separate as varieties the species of Turczaninow, Sonder, and Meissner. In so doing, Müller has not always succeeded in keeping clear of the pitfalls dug by his predecessors; he has, besides, initiated difficulties. Among these may be noted the statement under  $\gamma$  *humilis* that it is the female portion of Drège 3441 which is the same as *A. humilis*, Turcz., whereas we know from Turczaninow's statement and from the actual specimens that the female part of Drège 3441 has opposite leaves. Müller has referred Drège 1867 both to  $\delta$  *bupleuroides* and to  $\zeta$  *transiens*; the statement that Hout Bay, mentioned under  $\epsilon$  *serrata* in connexion with Krauss 1190, is in Natal is erroneous—the locality is in the Cape Peninsula; the statement under  $\theta$  *tenella* that Krauss 1191 is a Natal

plant is also erroneous—this specimen came from the Humansdorp division of Cape Colony. Again, Zeyher 1516, one of the types of *Diplostylis serrata*, Sond., is cited under  $\delta$  *bupleuroides*, which it does not greatly resemble; while *Mercurialis Zeyheri*, Kunze, which is identical with  $\zeta$  *transiens*, is cited under  $\gamma$  *humilis*. Finally,  $\gamma$  *humilis* and  $\theta$  *tenella* are the same plant; this is also the case with  $\beta$  *ovalifolia* and  $\eta$  *serrata*. These blemishes, however, are more than compensated for by the advance made by Müller in separating the group Adenoclineae from the group Mercurialineae.

#### SUMMARY.

A careful examination of the material available and of the statements made by botanical writers shows that, of the South African species which have from time to time been treated as species of *Mercurialis*, Linn., only one is really a member of the genus. This species, *M. annua*, Linn. (Sp. Pl., ed. i, 1036), is, however, only an introduced weed of cultivated ground which, although evidently already introduced before 1737, is even yet mostly to be met with in or near the Cape Peninsula. Of the remaining species, about one-third are really Mercurialineae, using this term in a sense somewhat more restricted than that in which it has been employed by Pax (Nat. Pflanzenf., iii. 5, 46); the rest are Adenoclineae, using this term as it was used by Müller (DC. Prodr., xv. 2, 1139). The Mercurialineae, a group within the subtribe Acalypheae, are represented in South Africa by two endemic genera, *Seidelia*, Baill. (1858), and *Leidesia*, Müll. arg. (1866). The Adenoclineae, a group within the subtribe Gelonieae, though more numerous, are referable to a single endemic genus *Adenocline*, Turcz. (1843), which, however, includes two distinct sections, one corresponding to the genus *Diplostylis*, Sond. (1850), the other to the genus *Paradenocline*, Müll. arg. (1866).

The salient characters of these various groups are as follows:—

I. MERCURIALINEAE [Acalyphearum grex]. Herbs, annual or with persistent base. Calyx closed in bud, valvately lobed. Stamens central; anther-cells subglobose, divaricate. Ovary 2-celled; styles short, entire. Capsule 2-coccous.

1. *Mercurialis*, Linn. Leaves opposite, herbaceous. Stamens 8–20; anthers 2-celled, 2-valved, cells at first pendulous. Hypogynous disc of 2 linear-subulate scales alternate with the carpels. Inflorescences usually 1-sexual, rarely androgynous.—Species 6; five European, one Asiatic. One of the European species occurs as an introduced weed in South Africa.

2. *Seidelia*, Baill. Leaves alternate, herbaceous. Stamens 3 or 2; anthers 2-celled, at length cruciately 4-valved; cells ascending. Hypogynous disc of 2 minute glands alternate with the carpels. Capsule glabrous. In-

florescences usually androgynous, rarely 1-sexual.—Species 2, endemic in South Africa.

3. *Leidesia*, Müll. arg. Leaves alternate, or occasionally opposite or subopposite at the lower branches, usually pellucid and flaccid, rarely herbaceous. Stamens 3–7; anthers 2-celled, 2-valved; cells ascending. Hypogynous disc of 2 minute glands alternate with the carpels, or obsolete. Capsule hispidulous. Inflorescences androgynous.—Species 3, endemic in South Africa.

II. ADENOCLINEAE [Geloniearum grex]. Herbs with persistent base, rarely annual. Calyx quincuncially imbricate. Stamens peripheral, 2-seriate; anther-cells obovoid, divaricate. Ovary 3-celled, with the odd cell posterior; styles slender, 2-partite. Capsule 3-coccous.

4. *Adenocline*, Turcz. Stamens 6–12; anthers 2-valved. Hypogynous disc of 3 staminodiform glands alternate with the carpels.—Species 8, all endemic in South Africa.

§ *Paradenocline*, Müll. arg. (gen.). Leaves alternate or occasionally opposite or subopposite at the lower branches, pellucid and flaccid. Anther-cells at first pendulous. Inflorescences androgynous.—Species 1, annual.

§§ *Diplostylis*, Sond. (gen.). Leaves usually all alternate, in one species (*A. acuta*) all opposite, herbaceous. Anther-cells ascending. Inflorescences always 1-sexual.—Species 7, all with a persistent base.

#### I. MERCURIALIS, Tournef.

*Mercurialis*, Tournef. *sec.* Linn., Gen. Pl., ed. 1, 307, syn. Boerh. excl. (1737); Thunb., Flor. Cap., ed. Schult., 387 (1823); Benth. *in* Benth. et Hook. f., Gen. Pl., iii. 309 (1880); Pax *in* Engl. & Prantl, Nat. Pflanzenf. iii. 5, 49, fig. 29 B–D (1890).

*Flores* monoici vel casu (*M. annua*) dioici, apetalii. ♂ *Calyx* tenuiter membranaceus, in alabastro clausus, globosus vel ovoideus, per anthesin valvatim 3-partitus. *Stamina* 8–20, centralia, filamentis liberis; antherae terminales, apertae patenter 2-valves; locelli primum penduli. *Ovarii rudimentum* 0. ♀ *Calyx* alte 3-sectus. *Discus hypogynus* e laminis 2 lineari-subulatis carpidiis alternantibus compositus. *Ovarium* 2-loculare; ovula in quoque loculo solitaria; styli breves, erecti vel divergentes, intus papilloso, indivisi. *Capsula* didyma in coccus 2-valves dissiliens, pericarpio membranaceo, endocarpio crustaceo. *Semina* ovoidea vel globosa; testa crustacea; albumen carnosum; cotyledones latae, planae.—*Herbae* annuae vel rhizomate perennante; glabrae vel pubescentes. *Folia* opposita.

*M. annua*, Linn., Sp. Pl., ed. 1, 1035 (1753); Burm., Fl. Cap. Prodr., 27 bis [31] (1768); Thunb., Prodr. Pl. Cap., 78 (1794), et Fl. Cap., ed. Schult., 387, quoad descr. sed spp. Outeniq. excl. (1823); Baill., Adansonia, iii. 158

(1862). *Folia* firmula, distincte petiolata, ovata, acuta, margine crenata, glabra; annua.

[VII. a.] SOUTH-EAST AFRICA: **Cape.** Coast Region: Cape Div. near Capetown, *Oldenland*; *Thunberg*! *Lehmann*! *Schlechter*, 1364! Tulbagh Div.; Tulbagh, *Kässner*, 1287!

*Mercurialis annua*, Linn., is a species widely spread in the Mediterranean basin, whence it extends northwards to Central and Western Europe, and westward to Madeira and the Canaries. It appears to have been introduced to South Africa, as a weed, before the middle of the eighteenth century, but even yet it has not become very common or spread very far from the Cape Peninsula.

## 2. SEIDELIA, Baill.

*Seidelia*, Baill., Étud. gén. Euphorb., 465, t. 9, fig. 7 (1858); Hook. f. in Harv., Gen. S. Afr. Pl., ed. 2, 338 (1868); Benth. in Benth. et Hook. f., Gen. Pl., iii. 310 (1880); Pax in Engl. & Prantl, Nat. Pflanzenf., iii. 5, 50, fig. 31 C (1890).

*Mercurialis*, E. Mey. in Linnaea, iv. 237 (1829); Sond. in Linnaea, xxiii. 112, pro parte (1850): nec Linn.

*Mercurialis* § *Seidelia*, Baill., Adansonia, iii. 160, 175 (1862).

*Tragia* § *Seidelia*, Müll. arg. in DC. Prodr. xv. 2, 947 (1866).

*Flores* monoici vel casu (*S. pumila*) dioici, apetalii. ♂ *Calyx* tenuiter membranaceus, in alabastro clausus, depresso globosus, per anthesin valvatim 3-partitus. *Stamina* 3 vel 2, centralia, segmentis alterna, filamentis basi brevissime connatis; antherae terminales, apertae cruciatim 4-valves; locelli erecti. *Ovarii rudimentum* 0. ♀ *Calyx* brevis, alte 3-fidus. *Discus hypogynus* e glandulis 2 parvulis carpidiis alternantibus compositus. *Ovarium* 2-loculare; ovula in quoque loculo solitaria; styli breves, recurvi, patentes, indivisi. *Capsula* parva didyma in coccus 2-valves dissiliens, pericarpio membranaceo, glabro, endocarpio tenuiter crustaceo. *Semina* ovoidea; testa crustacea; albumen carnosum; cotyledones anguste ovatae.—*Herbae* annuae, glabrae. *Folia* alterna.

## CLAVIS SPECIERUM.

*Folia* ovato-oblonga, margine crenata, distincte petiolata 1. *S. pumila*.  
*Folia* lineari-lanceolata vel linearia, margine integra vel utrinsecus  
 1-2-dentata, sessilia vel subsessilia 2. *S. triandra*.

1. ***S. pumila***, Baill., Étud. gén. Euphorb., 466 (1858). *Folia* firmula, distincte petiolata, ovato-oblonga, obtusa, margine crenata; annua.—*Mercurialis pumila*, Sond. in Linnaea, xxiii. 112 (1850); Baill., Adansonia, iii. 160 (1862). *Tragia triandra*, a *pumila*, Müll. arg. in DC. Prodr., xv. 2, 947 (1866).



[VII. a.] SOUTH-EAST AFRICA: Cape. Coast Region: Uitenhage Div.; at Amsterdamsvlakte between the Coega River and the Zwartkops River, *Zeyher*, 3843!

For some reason which is not readily apparent, Müller has treated this species as a variety of the next one.

2. *S. triandra*, Pax in Engl., Bot. Jahrb., x. 35 (1888), et in Engl. & Prantl, Nat. Pflanzenf., iii. 5, 50, fig. 31 C (1890). *Folia* firmula, sessilia vel subsessilia, lineari-lanceolata vel linearia, obtusa vel subacuta, margine integra vel prope apicem utrinsecus 1-2-dentata.—*Mercurialis triandra*, E. Mey. in Linnaea, iv. 237 (1829) et in Drège, Zwei Pfl. Documente, 201 (1843); Sond. in Linnaea, xxiii. 113, syn. Meissn. excl. (1850); Baill., Adansonia, iii. 160, syn. Meissn. excl. (1862). *Seidelia Mercurialis*, Baill., Étud. gén. Euphorb., 466, t. 9, fig. 7 (1858). *Tragia triandra*,  $\beta$  genuina, Müll. arg. in DC. Prodr., xv. 2, 947 (1866).

[VI.] SOUTH-WEST AFRICA. Orange-Vaal Basin: Northern Cape Colony: Richmond Div.; Winterveld, near Limoenfontein and Groot Tafelberg, 3000-4000 ft., *Drège*, 796! Hanover Div.; near Hanover, *Sim*, 13! Griqualand West: Kimberley, *Marloth*, 869!

### 3. LEIDESIA, Müll. arg.

*Leidesia*, Müll. arg. in DC. Prodr., xv. 2, 793 (1866); Benth. in Benth. et Hook. f., Gen. Pl., iii. 310 (1880); Pax in Engl. & Prantl, Nat. Pflanzenf., iii. 5, 50, fig. 31 A, B (1890).

---

*Mercurialis*, Herm., Par. Bat., App. 10 (1698); Burm., Thes. Zeyl., App. 16 (1737); Linn., Gen. Pl. [756], ed. 1, 307, quoad syn. Boerh. tantum (1737), et Sp. Pl., ed. 1, 1035, pro parte (1753); Sond. in Linnaea, xxiii., pro parte (1850): nec Tournef.

*Ricinokarpos*, Boerh., Ind. alt. Lugd.-Bat., i. 254, quoad sp. afr. sed diagn. gen. excl. (1720).

*Croton*, Linn., Sp. Pl., ed. 2, 1427, quoad syn. *Ricinocarpus*, Boerh., partim tantum (1763): nec Linn. Gen.

*Acalypha*, Thunb., Pl. Cap., ed. Schult., 546 partim (1823): nec Royen.

*Adenocline*, Baill., Étud. gén. Euphorb., 457, partim (1858): nec Turcz.

*Mercurialis* § *Trismegista*, Baill., Adansonia, iii. 158, partim et quoad *M. capensis* tantum, 175, partim (1862): nec Endl.

*Flores* monoici, apetalii. ♂ *Calyx* membranaceus, in alabastro clausus, minute apiculatus, per anthesin valvatim 3-partitus. *Stamina* saepius 4-7, nonnunquam (*L. firmula*) 3, centralia, filamentis basi hinc inde connatis;

antherae terminales, apertae patenter 2-valves; locelli adscendentes. *Ovarii rudimentum* 0. ♀ *Calyx* parvus, 3-fidus, vel obsoletus. *Discus hypogynus* e glandulis 2 parvulis carpidiis alternantibus compositus vel obsoletus. *Ovarium* 2-loculare; ovula in quoque loculo solitaria; styli breves, lineares, indivisi. *Capsula* parva, didyma, in coccos 2-valves dissiliens, pericarpio membranaceo hispidulo, endocarpio tenuiter crustaceo. *Semina* subglobosa; testa crustacea; albumen carnosum; cotyledones latae, planae.—*Herbae* annuae. *Folia* ad ramificationes opposita vel subopposita ceterum alterna. *Bractea*e calycibusque maris hispidulae.

## CLAVIS SPECIERUM.

Folia caulibusque firmula, minute crebre crenata, quam lata longiora 1. *L. firmula*.  
 Folia caulibusque flaccida, tenera, fere aequae longa ac lata:—  
     Folia utrinsecus 4-7-dentata 2. *L. procumbens*.  
     Folia utrinsecus 1-3-crenata 3. *L. obtusa*.

1. *L. firmula*, Prain in Kew Bull., 1912, 337 (1912). *Herba* rigidiuscula, intricatim ramosa. *Folia* firmula, breve petiolata, ovato-lanceolata vel lanceolata, manifeste longiora quam lata. *Stamina* 3, raro 4. *Flores feminei* breve pedicellati.

[VI.] SOUTH-WEST AFRICA. German South-West Africa: Great Namaqualand; Gamokab, Schinz, 898! Karukab, Schinz, 899! Grootfontein, Dinter, 700!

A very distinct species.

2. *L. procumbens*. *Herba* flaccida, diffuse ramosa. *Folia* tenera, longe petiolata, deltoideo-ovata, subacuta vel obtusa, margine 4-7-crenata. *Stamina* saepius 6-7. *Flores feminei* sessiles.—*Mercurialis africana dicoccos*, folio violae tricoloris, Herm., Par. Bat., App. 10 (1698). *M. androgyna*, Linn., Virid. Cliff., 98 (1737); Roy., Fl. Leyd. Prodr. 203 (1740); Steud., Nomencl., ed. 1, 524 (1821). *M. africana, minor, lucida*, Burm. f., Thes. Zeyl., app. 16 (1737). *M. procumbens*, Linn., Sp. Pl., ed. 1, 1036 (1753). *M. annua*, Thunb., Fl. Cap., ed. Schult., 387, quoad loc. Outeniqua tantum (1823): nec Linn. *M. tricocca*, E. Mey. in Drège, Zwei Pfl. Documente, 201, partim (1843) nomen. *M. capensis*, Spreng. ex Eckl. et Zeyh. in Linnaea, xx. 213 (1847), nomen; Sond. in Linnaea, xxiii. 112, syn. Linn. f. et Thunb. excl. (1850); Baill., Adansonia, iii. 158, syn. Linn. et Lehm. excl. (1862). *Ricinokarpus*; *afra*, Boerh., Ind. alt. Lugd.-Bat., i. 254 (1720). *Croton Ricinokarpus*, Linn., Sp. Pl., ed. 2, 1427 (1763); Aubl., Hist. Pl. Guy., ii. 883 (1775); Willd., Sp. Pl., iv. 551 (1805); Geisel., Croton. Monogr., 66 (1807); Spreng., Syst., iii. 877 (1826) omn. quoad descr. et quoad syn. *M. androgyna*, sed excl. syn. Boerh. et patr. Surinam. *Urtica capensis*,

Eckl. Un. It., 814, *ex* Sond., l. c. (1850): nec Linn. f., nec Thunb. *Adenocline Mercurialis*, Baill.; Étud. gén. Euphorb., 457, partim (1858): nec Turcz. *Leidesia Sonderiana*, Müll. arg. in DC. Prodr., xv. 2, 699 (1866), nomen. *L. capensis*, Müll. arg., l. c., 793, *sed* syn. *Urtica capensis*, excl. (1866).

[VI.] SOUTH-WEST AFRICA. Transvaal: Houtboschberg, 6,500 ft., *Rehmann*, 5923! *Schlechter*, 4427!

[VII. a.] SOUTH-EAST AFRICA: **Cape.** Coast Region: Cape Div.; Table Mountain, *Ecklon*, 814! *Zeyher*, 3844! *Masson*! *Wright*, 426! Longloof, *Dümmer*, 1376! Devil's Mountain, 1,200 ft., *Ecklon*! *Harvey*, 504! *Bolus*, 2941! *Wilms*, 3623! above Overige Kloof, 2,800 ft., *Schlechter*, 408! above Groote Schuur, *Wolley Dod*, 607! George Div.; Outeniqua Mountains, *Thunberg*! Roode Muur, *Drège* (*M. tricocca*,  $\delta$ )! near George, *Burchell*, 5847! *Moyle Rogers*! Knysna Div.; Yzer Nek, *Burchell*, 5247! Karratera River, *Drège* (*M. tricocca*,  $\epsilon$ ). Albany Div.; without precise locality, *Bowie*, 18! Stockenstroom Div.; between Kala and Ugie, 5,000 ft., *Bolus*, 10284!

[VII b.] **Natal.** Griqualand East; Malawe Forest, *Tyson*, 2118! Natal; Ismont, 2,000 ft., *Wood*, 1867!

3. **L. obtusa**, Müll. arg. in DC. Prodr., xv. 2, 793 (1866). *Herba* flaccida, diffuse ramosa. *Folia* tenera, longe petiolata, orbiculari-ovata, obtusa, margine 1-3-crenata. *Stamina* saepissime 4-5. *Flores* femineï sessiles.—*Acalypha obtusa*, Thunb., Fl. Cap., ed. Schult., 546 (1823); *Lehm. ex* Baill., *Adansonia*, iii. 159 (1862). *A. obtusata*, Spreng. *ex* Steud., *Nomencl.*, ed. 2, i. 10, pro parte maxima (1840). *Mercurialis tricocca*, E. Mey. in *Drège*, *Zwei Pfl. Documente*, 201, pro parte: *a* partim et *b* partim (1843): nomen. *M. capensis*, Sond. in *Linnaea*, xxiii. 112, partim (1850); Baill., *Adansonia*, iii. 158, quoad syn. *Lehm. tantum* (1862); Spreng. in *Herb. Berol. ex* Müll. arg., l. c. (1866): nec Spreng. *ex* Eckl. et *Zeyh. Adenocline Mercurialis*, Baill., Étud. gén. Euphorb., 457, partim (1858): nec Turcz.

[VII a.] SOUTH-EAST AFRICA: **Cape.** Central Region: Willowmore Div.; Karroo, between the Great Zwarte Bergen and Aasvogel Berg, 2,000 ft., *Drège* (*M. tricocca*,  $\alpha$  in *Herb. Kew*!) Somerset Div.; between Zuurberg and Brintje's Hoek, *Drège* (*M. tricocca*,  $\beta$  in part)! woods at the foot of the Boschberg, 3,000 ft., *Macowan*, 1752! without precise locality, *Miss Bowker*!

Coast Region: Cape Div.; Shore near Smitswinkel Bay, *Wolley Dod*, 3302! without precise locality, *Thunberg*! *Lehmann*! Uitenhage Div.; Zuurberg Range, *Drège*! Zwartkops River, *Ecklon & Zeyher*, 35! near Uitenhage, *Prior*! Port Elizabeth Div.; Baakens River Valley, *Mrs. Paterson*, 841! Alexandria Div.; near Barville Creek, *Burchell*, 4091! Albany Div.; Dassie Krantz, *Rogers*, 3961!

Very nearly allied to *L. procumbens*, but usually a smaller plant, with decidedly

smaller capsules and seeds. It bears a close general resemblance to *Adenocline* (Paradenocline) *violaeifolia*, with which it has frequently been mistaken both in the field and in herbaria.

#### 4. ADENOCLINE, Turcz.

*Adenocline*, Turcz. in Bull. Soc. Imp. Nat. Mosc., xvi. 1, 59 (1843), in Flora, xxvii. 121 (1844), et in Bull. Soc. Imp. Nat. Mosc., xxv. 2, 179 (1852); Baill., Étud. gén. Euphorb., 456, t. 9, fig. 6 (1858); Müll. arg. in DC. Prodr., xv. 2, 1139 (1866); Hook. f. in Harv., Gen. S. Afr. Pl., ed. 2, 338 (1868); Benth. in Benth. et Hook. f., Gen. Plant., iii. 310 (1880); Pax in Engl. & Prantl, Nat. Pflanzenf., iii. 5, 49, fig. 30 A-E (1890).

*Acalypha*, Thunb., Fl. Cap., ed. Schult., 546, partim (1823); Spreng. ex Steud. Nomencl., ed. 2, i. 10 (1840): nec Royen.

*Mercurialis*, Meissn. in Hook., Lond. Journ. Bot., ii. 556 (1843); Krauss in Flora, xxviii. 84 (1845); Kunze in Linnaea, xx. 54 (1847); Sond. in Linnaea, xxiii. 111, pro parte (1850).

*Mercurialis* § *Adenocline*, Baill., Adansonia, iii. 159 (1862).

*Mercurialis* § *Trismegista*, Baill., l. c., 158, partim (*M. violaeifolia* tantum) et 175 pro parte maxima (1862).

*Diplostylis*, Sond. in Linnaea, xxiii. 113 (1850).

*Paradenocline*, Müll. arg. in DC. Prodr., xv. 2, 1141 (1866).

*Flores* dioici, rarissime (*A. violaeifolia*) monoici, apetalii. ♂ *Calyx* membranaceus, alte 5-partitus; lobi quincuncialiter imbricati. *Stamina* 6–12, saepissime tamen 10, 2-seriata, circa centrum floris glanduligerum inserta, exteriora cum calycis segmentis alternantia, filamentis liberis; antherae terminales, apertae 2-valves. *Ovarii rudimentum* 0; glandulae intrastaminales numerosae. ♀ *Calyx* parum major, alte 5-partitus; lobi quincuncialiter imbricati: *Discus hypogynus* e glandulis 3 capitatis staminodiiformibus carpidiis alternantibus compositus. *Ovarium* 3-loculare, loculi 2 laterali-anteriores, tertius posterior; ovula in quoque loculo solitaria; styli tenues, alte 2-partiti, recurvo-patentes, basi brevissime connati. *Capsula* parva, 3-dyma, in coccus 2-valves dissiliens, pericarpio membranaceo glabro, endocarpio tenuiter crustaceo. *Semina* subglobosa; testa tenuiter crustacea; albumen carnosum; cotyledones anguste ovatae.—*Herbae* tenues diffusae, saepius basi perennantes ibique sublignosae, raro (*A. violaeifolia*) annuae, tenerae. *Folia* alterna vel raro (*A. acuta*) opposita; stipulae parvulae vel majusculae. *Flores* minimi, ♂ saepius plurimi axillares; ♀ singuli opositifolii pedicello subito refracto cymam uniparam efficientes.

CLAVIS SPECIERUM.

- Inflorescentiae androgynae; folia tenera, ad ramificationes subopposita, ceterum alterna; annuae [§ 1. **Paradenocline**] 1. *A. violaefolia*.  
 Inflorescentiae 1-sexuales; folia herbacea; perennantes [§ **Diplostylis**]:—  
 Folia opposita, longe petiolata 2. *A. acuta*.  
 Folia alterna:—  
 Folia omnia sessilia, ovata, serrata; stipulae majusculae, foliaceae 3. *A. stricta*.  
 Folia saltem inferiora ac petiolata:—  
 Folia ac superiora ac inferiora distincte petiolata:—  
 Stipulae majusculae, foliaceae 4. *A. ovalifolia*.  
 Stipulae minimae 5. *A. humilis*.  
 Folia superiora sessilia vel subsessilia:—  
 Folia inferiora petiolata orbicularia vel ovata, obtusa 6. *A. bupleuroides*.  
 Folia inferiora petiolata anguste lanceolata, acuta:—  
 Folia superiora sessilia serrata 7. *A. Zeyheri*.  
 Folia superiora sessilia margine integra 8. *A. sessilifolia*.

§ 1. **PARADENOCLINE.** *Caules* flaccidi, annui. *Folia* tenera, longe petiolata, ad ramificationes subopposita, ceterum alterna. *Inflorescentiae* androgynae. *Antherarum* loculi demum subreflexi.—*Mercurialis*, E. Mey. in Drège, Zwei Pfl. Documente, 201, partim (1843); Krauss, loc. supra cit., 85 (1845); Kunze, loc. supra cit., 55 (1847); Sond., loc. supra cit., 111 (1850): omn. pro parte. *Mercurialis* § *Trismegista*, Baill., loc. supra cit. quoad *M. violaefoliam* tantum (1862). *Adenocline*, Baill., loc. supra cit. (1858); Hook. f., loc. supra cit. (1868); Benth., loc. supra cit. (1880); Pax, loc. supra cit. (1890); omn. pro parte. *Paradenocline*, Müll. arg. in DC. Prodr., xv, 2, 1141.

1. ***A. violaefolia.*** *Herba* monoica. *Folia* ovata, acuta, basi minopere cordata, margine breve acute distanter serrata; stipulae lanceolatae, minutae.—*Acalypha obtusata*, Spreng. ex Steud., Nomencl., ed. 2, i, 10 partim (1840). *Mercurialis annua*, Drège ex E. Mey. in Drège, Zwei Pfl. Documente, 201 (1843): nec Linn. *M. tricocca*, E. Mey., l. c. sed quoad spp. partim tantum (1843), nomen; Eckl. et Zeyh. ex Krauss in Flora, xxviii, 85 (1845), nomen; Sond. in Linnaea, xxiii, 111, syn. Thunb. excl. (1850). *M. violaefolia*, Kunze, Ind. Sem. Hort. Lips. MDCCCLXVI c. diagn. (1846), et in Linnaea, xx, 55 (1847) et xxiv, 162 (1851); Baill., Adansonia, iii, 159, syn. Thunb. excl. (1862). *Adenocline Mercurialis*, Baill., Étud. gén. Euphorb., 457, sed quoad spp. partim tantum (1858), nomen: nequaquam *A. Mercurialis*, Turcz. *A. procumbens*, [Benth. ex] Pax in Engl. & Prantl, Nat. Pflanzenf., iii, 5, 49 (1890). *Paradenocline violaefolia*, Müll. arg. in DC. Prodr., xv, 2, 793 (1866), nomen. *P. procumbens*, Müll. arg., l. c., 793, 1141 (1866): nequaquam *Mercurialis procumbens*, Linn.

[VIIa.] SOUTH-EAST AFRICA: Cape. Central region: Willowmore Div.; between Zwartberg and Aasvogelberg, *Drège* (*M. tricocca*  $\alpha$  in *Herb. Brit. Mus.*)! Graaf Reinnet Div.; Oudeberg Mountains, 3,000 ft., and near Graaf Reinnet, 2,500 ft., *Bolus*, 429!

Coast Region: Clanwilliam Div.; Zeekoe Vley, 400 ft., *Schlechter*, 8502! near Zwartbosch Kraal, 400–500 ft., *Schlechter*, 5174! Malmesbury Div.; Kloof near Hopefield, *Bachmann*, 1265! pass near Malmesbury, 900 ft., *Schlechter*, 1603! Paarl Div.; near Paarl, 1,000 ft., *Drège* (*M. annua*)! Cape Div.; Green Point, *Zeyher*, 3842 in part! *Harvey*! Waterfall on Devil's Mountain, *Harvey*! Constantia, 800–1,000 ft., *Krauss*, 1821; Oatland's Point, *Wolley Dod*, 2922! Muizenberg, *Schlechter*, 1278! Swellendam Div.; Kinko River, near Swellendam, *Zeyher*, 3842 in part! Uitenhage Div.; Addo, *Drège*, 2346 (*M. tricocca*,  $\gamma$ )! Alexandria Div.; Zuurberg, *Drège* (*M. tricocca*  $\beta$  in part)!

Very different from the remaining species of the genus, but in general facies closely resembling *Leidesia obtusa*.

§ 2. DIPLOSTYLIS. *Caules* herbacei, basi perennantes ibique sublignosi. *Folia* membranacea saepissime alterna et breve petiolata vel subsessilia, raro (*A. acuta*) opposita longe petiolata. *Inflorescentiae* 1-sexuales. *Antherarum* loculi adscendentes.—*Acalypha*, Thunb. partim, loc. supra cit. (1823); Spreng. partim, loc. supra cit. (1840); nec Royen. *Adenocline*, Turcz., loc. supra cit. (1843, 1844 et 1851); Baill., loc. supra cit. syn. (*A. Mercurialis* excl. (1858); Müll. arg., loc. supra cit. (1866); Hook. f., loc. supra cit. (1868); Benth., loc. supra cit. syn. (*Paradenocline* excl. (1880); Pax, loc. supra cit. syn. (*Paradenocline* excl. (1890). *Mercurialis*, Meissn., loc. supra cit. (1843); Krauss, loc. supra cit. syn. Eckl. et Zeyh. excl. (1845); Kunze partim, loc. supra cit. (1847). *Mercurialis* § *Adenocline*, Baill., loc. supra cit. (1862). *Diplostylis*, Sond., loc. supra cit. (1850).

2. *A. acuta*, Baill., Étud. gén. Euphorb., 457 (1858); Müll. arg. in DC. Prodr., xv. 2, 1141 (1866); Pax in Engl. et Prantl., Nat. Pflanzenf., iii. 5, 49, fig. 30 A–D (1890). *Herba* dioica. *Folia* omnia longe petiolata, opposita, ovata, acuta, crenata vel serrata; stipulae laceratae.—*Acalypha acuta*, Thunb., Fl. Cap., ed. Schult., 546 (1823); Spreng. ex Steud., Nomencl., ed. 2, i. 9 (1840). *Adenocline Mercurialis*, Turcz. in Bull. Soc. Imp. Nat., Mosc., xvi. 1, 60 (1843), et xxv. 2, 179 (1852); Flora, xxvii. 121. (1844). *A. pauciflora*, Turcz. ll. cc. quoad Drège 3441 ♀ (1843, 1844 et 1852); Baill. Étud. gén. Euphorb., 457, partim (1858). *Mercurialis caffra*,  $\alpha$  *longipes* et  $\beta$  *brevipes*, Meissn. in Hook. Lond. Journ. Bot., ii. 558 (1843); Krauss in Flora, xxviii. 84 (1845). *M. Dregeana*, Meissn., l. c., 559 (1843); Krauss, l. c. (1845). *M. subcordata*, Buching. ex Krauss, l. c. (1845). *M. pauciflora*, Baill., Adansonia, iii. 159, partim (1862). *Diplostylis caffra*, Sond. in Linnaea, xxiii. 115 (1850).

[VI.] SOUTH-WEST AFRICA. Transvaal: Barberton; Rimer's Creek, *Thorncroft*, 250! 5592! Highland Creek, 3,000 ft., *Galpin*, 841! Houtbosch, *Rehmann*, 5963! Shilouvane, *Funod*, 863!

[VII a.] SOUTH-EAST AFRICA: Cape. Central Region: Somerset Div.; Somerset East, *Scott Elliott*, 643! Philipstown Div.; near Philipstown, 2,000-3,000 ft., *Ecklon & Zeyher*!

Coast Region: Stellenbosch Div.; Hottentots Holland, *Zeyher*, 3842 partly! Caledon Div.; Oaks, *Prior*! Swellendam Div.; Voormanbosch, *Zeyher*, 3842 partly! George Div.; forest near George, *Prior*! Outeniqua Mountains, *Rehmann*, 259! Knysna Div.; Gouwkamma, *Krauss*, 1192! Ruigte Valley, *Drège*, 2301 a! Groene Valley, *Burchell*, 5625! Humansdorp Div.; near the Kromme River, *Drège*, 2301 b! Uitenhage Div.; near the Van Stadens River, *Drège*, 2301 c! without precise locality, *Thunberg*! *Masson*! Port Elizabeth Div.; Baakens River, *Burchell*, 4339! *Mrs. Paterson*, 838! Algoa Bay at Cape Recief, *Ecklon*, 611! *Ecklon & Zeyher*, 37! Krakakamma Forests, *Zeyher*, 552! *Ecklon*, 828! Alexandria Div.; Olifants Hoek, *Ecklon & Zeyher*, 36! Bathurst Div.; mouth of Great Fish River, *Burchell*, 3735! between Sunday River and Fish River, *Thunberg*! near Port Alfred, *Schönland*, 788! 1544! *Schlechter*, 2732! Albany Div.; near Grahamstown, *Bolton*! *Bolus*, 2681! *Penther*, 914! Howison's Poort, *Mrs. H. Hutton*! *Macowan*, 318! Trapp's Valley, *Miss E. Anstey*, 9! Atherstone, *Rogers*, 3301! without precise locality, *Miss Bowker*! *Williamson*! *Macowan*, 222! Fort Beaufort Div.; near Fort Beaufort, *Ecklon & Zeyher*, 38! Stockenstroom Div.; Katberg, *Shaw*! East London Div.; *Ratray*, 128! 158!

[VII b.] Natal. Transkei; Kentani, 1,500 ft., *Umtata Convent*, 495! Tembuland; Bazeia, 2,500 ft., *Baur*, 128! Perie Forest, *Schönland*, 851! Pondoland; woods near Port Donald, 3,500 ft., *Tyson*, 1782! without precise locality, *Bachmann*, 803! Griqualand East; Maclear Div., near the River Chivenka, 4,300 ft., *Bolus*, 10285! Natal; Notote, *Gerrard*, 32! Ingoma, *Gerrard & McKen*, 1175! Mount Insizwa, *Krook*, 906! woods near Byrne, 3,000 ft., *Wood*, 1816! Zuurberg Bush, *Wood*, 1987! near Van Reenen, 5,200 ft., *Schlechter*, 6958! Umlaas, *Krauss*, 156! without precise locality, *Gerrard*, 545! *Cooper*, 3151!

*Adenocline acuta* is the most widely distributed of the species in this genus. It is also the most readily distinguishable, owing to its uniformly opposite long-petioled leaves. Within the species it is possible to recognize two fairly distinct forms which correspond to the two varieties of *Mercurialis caffra*, Meissn., recognized by Meissner. The former, *M. caffra*,  $\alpha$  *brevipes*, represents what originally was considered by Meissner to constitute the species *M. caffra*. The latter, *M. caffra*,  $\beta$  *longipes*, Meissner at one time considered a distinct species, *M. Dregeana*. It is the latter plant which corresponds to *Adenocline Mercurialis*, Turcz., because it was based upon

the same Drègean specimen. The plant which forms the original *M. caffra*, later *M. caffra*, *a brevipes*, is the same as that portion of *Adenocline pauciflora*, Turcz., which has opposite leaves. The two plants can be fairly easily sorted out in herbaria because *a brevipes* usually dries to a straw-yellow or yellowish-green colour, whereas *β longipes*, the original *Adenocline Mercurialis*, Turcz., dries green. But there is no other tangible differential character, for both forms vary in size of leaf, length of petiole, character of leaf-base, and tothing of the leaf-margin. As the only certain character is one that can hardly be expected to prove of value in the field no good purpose is served by the continued recognition of Meissner's two varieties.

3. *A. stricta*, Prain in Kew Bull., 1912, 338. *Herba* dioica. *Folia* sessilia, alterna, oblonga vel oblongo-lanceolata, acutè serrata; stipulae oblongae, foliiformes.

[VII a.] SOUTH-EAST AFRICA: Cape. Coast Region: Bredasdorp Div.; Reitfontein Poort, 100–200 ft., Bolus, 8603! Schlechter, 9694!

A very distinct species readily distinguished by its sessile leaves and very large leafy stipules.

4. *A. ovalifolia*, Turcz. in Bull. Soc. Imp. Nat. Mosc., xvi. 1, 60 (1843) et xxv. 2, 179 (1852); Flora, xxvii. 121 (1844). *Herba* dioica. *Folia* omnia breve petiolata, alterna, inferiora ovata, superiora ovato-lanceolata, margine acute serrata; stipulae majusculae, foliaceae.—*Trianthema debile*, Spreng. ex Turcz., Bull. Soc. Imp. Nat. Mosc., xvi. 1, 60 (1843). *T. dubium*, Spreng. ex Turcz., l. c., xxv. 2, 179 (1852). *Mercurialis serrata*, Meissn. in Hook. Lond. Journ. Bot., ii. 557 (1843); Krauss in Flora, xxviii. 84 (1845). *M. bupleuroides*, Kunze in Linnaea, xx. 54, syn. *M. Zeyheri* excl. (1847); Baill., Adansonia, iii. 159, pro parte (1862); nec Meissn. *Diplostylis serrata*, Sond. in Linnaea, xxiii. 114, quoad Zeyher 1516 et quoad Eckl. & Zeyh. 39, partim (1850). *Adenocline humilis*, Baill., Étud. gén. Euphorb., 457 (1858); nec Turcz. *A. pauciflora*, *β ovalifolia*, Müll. arg. in DC. Prodr., xv. 2, 1139; *δ bupleuroides*, Müll. arg., l. c., 1140 quoad Zeyher 1516 tantum; et *ε serrata*, Müll. arg., l. c., 1140 (1866).

[VII a.] SOUTH-EAST AFRICA: Cape. Coast Region: Cape Div.; Houtsbay, 0–150 ft., Masson! Krauss, 1190; Bolus, 1093! 7059! Schlechter, 958! Wolley Dod, 1652! Harvey, 626! Sandhills on Cape Plats, Wolley Dod, 1882! Simonstown, by Noah's Ark Battery, Wolley Dod, 2819 in part! Swellendam Div.; without precise locality, Mund (Ecklon & Zeyher 39), partly! Riversdale Div.; Kaffir Kuils River, Stack (Zeyher, 1516)! East London Div.; East London, Wood, 3137! Komgha Div.; near Kei River Mouth, Flanagan, 842!

var. *rotundifolia*, Prain. *Folia* inferiora suborbicularia, superiora ovata, ceterum typi.—*A. pauciflora*, *a rotundifolia*, Müll. arg. in DC. Prodr., xv. 2, 1139 (1866).



[VII a.] SOUTH-EAST AFRICA: **Cape.** Coast Region: Cape Div.; Simonstown, by Noah's Ark Battery, *Wolley Dod*, 2819 mainly! without precise locality, *Forbes*!

The variety perhaps hardly deserves recognition apart from the type.

5. **A. humilis**, Turcz. in Bull. Soc. Imp. Nat. Mosc., xvi 1, 61 (1843) et xxv. 2, 172 sed ibi syn. Meissn. et syn. Sond. excl. (1852); Flora, xxvii. 121 (1844). *Herba* dioica. *Folia* omnia breve petiolata, alterna, basalia orbiculari-cordata, superiora ovato-lanceolata, margine nunc crenata vel obscure serrata nunc integra; stipulae minimae, lanceolatae.—*Adenocline pauciflora*, Turcz., l. c., xvi. 1, 60, quoad spp. ♂ foliis alternis (1843); Baill., Étud. gén. Euphorb., 457, partim (1858). *Mercurialis tenella*, Meissn. in Hook. Lond. Journ. Bot., ii. 556 (1843); Krauss in Flora, xxviii. 84 (1845). *M. triandra*, Sond. in Linnaea, xxiii. 113, quoad syn. Meissn. (1850); Baill., Adansonia, iii. 160, partim et quoad syn. Meissn. (1862); nec E. Mey. *M. pauciflora*, Baill., l. c., 159, partim (1862). *M. bupleuroides*, Baill., l. c., partim (1862); nec Meissn. *Adenocline pauciflora*, γ *humilis*, Müll. arg. in DC. Prodr., xv. 2, 1140 syn. Kunze excl. (1866), et θ *tenella*, Müll. arg., l. c. (1866).

[VII a.] SOUTH-EAST AFRICA: **Cape.** Coast Region: Mossel Bay Div.; banks of Great Brak River, *Burchell*, 6157! Humansdorp Div.; Zitzikamma, *Krauss*, 1191. Stockenstroom Div.; Katberg, *Drège*, 3341 (male plant only)! 8223! Queenstown Div.; Hangklip Mountains, 6,000 ft., *Galpin*, 1782!

Central Region: Graaf Reinet Div.; Cave Mountains, 4,400 ft., *Bolus*, 697 mainly! 4570!

Closely resembles *A. ovalifolia*, but is readily distinguished by its smaller size and its minute stipules.

6. **A. bupleuroides**. *Herba* dioica. *Folia* alterna, inferiora orbicularia vel obovata, obtusa, breve petiolata, superiora ovato-lanceolata lanceolata vel linearia, acuta, sessilia, omnia margine acute serrata; stipulae lanceolatae, foliaceae.—*Mercurialis bupleuroides*, Meissn. in Hook. Lond. Journ. Bot., ii. 557, quoad Krauss 1169 tantum (1843); Krauss in Flora, xxviii. 84 (1845); Kunze in Linnaea, xx. 54, syn. *M. Zeyheri* exclus. (1847); Baill., Adansonia, iii. 159, partim (1862). *Diplostylis bupleuroides*, Sond. in Linnaea, xxiii. 114, quoad Gueinzus 172 tantum (1850). [*D. longifolia*, Sond. MSS. in Herb. Harv. T. C. D.] *Adenocline humilis*, Turcz. in Bull. Soc. Imp. Nat. Mosc., xxv. 2, 179, partim et quoad syn. Meissn. et syn. Sond. (1852); nequaquam Turcz., l. c., xvi. 1, 61. *A. pauciflora*, δ *bupleuroides*, Müll. arg. in DC. Prodr., xv. 2, 1140, quoad Krauss 1169 et Gueinzus 172 tantum (1866).

[VII a.] SOUTH-EAST AFRICA: **Cape.** Coast Region: Uitenhage Div.; Elands River, *Ecklon & Zeyher*, 39 partly! Albany Div.; near Grahamstown, *Miss M. Daly*, 903! Featherstone's Kloof, 2,500 ft., *Galpin*,

255! East London Div.; near Nahoon, *Ratray*, 216! Komgha Div.; near the Gwenkala River, *Flanagan*, 695!

[VII b.] Natal. Griqualand East; Mount Currie, 5,300 ft., *Tyson*, 1798! 1833! Natal; near Durban, *Gueinzus*, 172! above Pinetown, 2,200 ft., *Wood*, 5003! Clairmont, *Wood*, 10636! Inchanga, 2,000–3,000 ft., *Wood*, 7184! Inanda, 1,800 ft., *Wood*, 253! Tugela, *Haygarth* in *Herb. Wood*, 10155! Ingoma, *Gerrard & McKen*, 1168! Nottingham, *Buchanan*, 149! near Krantz Kloof, 1,500 ft., *Schlechter*, 3179! Alexandra, Dumisa, 2,000 ft., *Rudatis*, 634! Zululand; Entumeni, 2,000 ft., *Wood*, 741!

var. *Peglerae*. *Folia* superiora quae sessilia cum inferioribus petiolatis orbicularia vel obovata, obtusa.

[VII b.] SOUTH-EAST AFRICA: Natal. Transkei; Kentani, *Miss Pegler*, 871!

7. **A. Zeyheri**. *Herba* dioica. *Folia* alterna, omnia lanceolata margine parce serrata, inferiora breve petiolata, superiora sessilia; stipulae lanceolatae, foliaceae.—*Adenocline sessilifolia*, Turcz. in Bull. Soc. Imp. Nat. Mosc., xvi. 1, 61 quoad Drège 1867 tantum (1843), nec Turcz., l. c., xxv. 2, 180. *A. serrata*, Turcz., l. c., xxv. 2, 180 syn. excl. (1852). *A. pauciflora*,  $\gamma$  *humilis*, Müll. arg. in DC. Prodr., xv. 2, 1140, quoad syn. (*Mercurialis Zeyheri* tantum (1866));  $\delta$  *bupleuroides*, Müll. arg., l. c., quoad Drège 1867 tantum (1866); et  $\zeta$  *transiens*, Müll. arg., l. c. (1866). *Mercurialis bupleuroides*, Meissn. in Hook. Lond. Journ. Bot., ii. 557, quoad Drège 1867 tantum (1843); Kunze in Linnaea, xx. 54, quoad syn. *M. Zeyheri* (1847); Baill., Adansoniana, iii. 159, partim (1862). *M. Zeyheri*, Kunze, l. c. (1847). *Diplostylis serrata*, Sond. in Linnaea, xxiii. 114, excl. Zeyher 1516. (1850).

[VII. a.] SOUTH-EAST AFRICA: Cape. Central Region: Graaf Reinet Div.; near Graaf Reinet, 4,000 ft., *Bolus*, 697 partly!

Coast Region: Knysna Div.; between Groene Valley and Zwart Valley, *Burchell*, 5678! Humansdorp Div.; Humansdorp, *Rogers*, 3082! Uitenhage Div.: sand dunes near Uitenhage, *Ecklon & Zeyher*, 39 partly! Port Elizabeth Div.; near Port Elizabeth at Walmer and Humewood, *Mrs. Paterson*, 1030! Albany Div.; Grahamstown, *South*! Howison's Poort, 2,000 ft., *Glass*, 191! Without precise locality, *Drège*, 1867 a! 1868 partly!

This species is nearest, as Kunze originally suggested, to *A. bupleuroides*, but is most readily mistaken for *A. sessilifolia*. It is, however, easily distinguished, when carefully examined, from both.

8. **A. sessilifolia**, Turcz. in Bull. Soc. Imp. Nat. Mosc., xvi. 1, 61, quoad Drège 1868 tantum (1843) et xxv. 2, 180 (1852); Flora, xxvii. 121, pro parte (1844). *Herba* dioica. *Folia* alterna, inferiora anguste lanceolata, breve

petiolata, superiora lineari-lanceolata, sessilia, omnia margine integra; stipulae lineares.—*Diplostylis angustifolia*, Sond. in *Linnaea*, xxiii. 113 (1850). *Adenocline sessiliflora*, Baill., *Étud. gén. Euphorb.*, 457, t. 9, fig. 6 (1858). *Mercurialis bupleuroides*, Baill., *Adansonia*, iii. 159, pro parte (1862); nec Meissn. *Adenocline pauciflora*,  $\eta$  *sessilifolia*, Müll. arg. in DC. *Prodr.*, xv. 2, 1140 (1866). *A. pauciflora*, Pax in Engl. & Prantl, *Nat. Pflanzenf.*, iii. 5, 49 fig. 30 E (1890); nec Turcz.

[VII a.] SOUTH-EAST AFRICA: **Cape.** Coast Region: Clanwilliam Div.; Brakfontein, *Ecklon & Zeyher*, 40! Malmesbury Div.; between Mamre and Saldanha Bay, *Drège*, 1868! Cape Div.; Riet Valley, near Laudenbach, *Ecklon & Zeyher*, 39 partly! Uniondale Div.; near Avontuur, *Bolus*, 2460!

A very distinct species.

#### DISTRIBUTION OF SEIDELIA, LEIDESIA, AND ADENOCLINE.

In the enumeration of the species of these three endemic South African genera, the geographical area of each, so far as this is known, has been stated in accordance with the subdivision of the African continent adopted for the genera *Erythrococca* and *Micrococca* in an earlier paper (*Ann. Bot.*, xxv. 632-4). All the species of the three genera here dealt with are confined to the south of the tropic of Capricorn, and are met with only in the areas VI and VII of the previous paper. They, therefore, occur only in the catchment area of the Orange-Vaal or to the south and south-east of that catchment area, or in both of these regions.

The South-eastern Region it was found convenient to divide into a western, or Cape, half from the Kei River westward, and an eastern, or Natal, half to the east of that stream. In the present instance it is convenient to subdivide the South-western Region into a western or Namaqualand half, and an eastern or Transvaal-Griqualand half.

In the Namaqua portion of South-West Africa only one species, *Leidesia firmula*, is found; the species is there endemic. In the eastern half of South-West Africa three species are met with: *Seidelia triandra*, *Leidesia procumbens*, and *Adenocline acuta*. Only the first of these three is endemic; the two others are cases of overflow from the Cape portion of South-East Africa.

In the Eastern or Natal half of South-East Africa we again find three species, two of which, occurring only as overflows from the Cape portion of South-East Africa, are *Leidesia procumbens* and *Adenocline acuta*, species which also overflow into the Transvaal. The third Natal species, *Adenocline bupleuroides*, though not endemic, is almost as distinctive of Natal as *Seidelia triandra* is of Griqualand; it only extends as an overflow into the Cape region proper for some little distance to the west of the Kei River.

We find, then, that three of our four areas, Namaqua, Griqua, and Natal, have each one distinctive species, but that the species which is distinctive of Natal overflows westward into the Cape area proper. On the other hand, this Cape area, though exhibiting no overflow into Namaqua, does show an overflow into Natal and into the Transvaal by means of *Leidesia procumbens* and *Adenocline acuta*. In the Cape region itself there are eight other species, all of them endemic; the endemic Cape element is thus 72 per cent. of the whole. The details of this distribution are shown more succinctly in the subjoined conspectus, wherein overflow species are marked (x), introduced species [x].

CONSPECTUS OF THE DISTRIBUTION OF THE SOUTH AFRICAN  
MERCURIALINEAE AND ADENOCLINEAE.

Species.	VI. South-West Africa.		VII. South-East Africa.	
	Namaqua.	Griqua-Vaal.	Cape.	Natal.
MERCURIALINEAE.	<i>Mercurialis annua</i> . . .	—	[x]	—
	<i>Seidelia triandra</i> . . .	—	—	—
	„ <i>pumila</i> . . .	—	x	—
	<i>Leidesia obtusa</i> . . .	—	—	x
	„ <i>procumbens</i> . . .	—	(x)	x
„ <i>firmula</i> . . .	x	—	—	(x)
ADENOCLINEAE.	<i>Adenocline violaeifolia</i> . .	—	x	—
	„ <i>acuta</i> . . .	—	x	(x)
	„ <i>stricta</i> . . .	—	x	—
	„ <i>ovalifolia</i> . . .	—	x	—
	„ <i>humilis</i> . . .	—	x	—
	„ <i>bupleuroides</i> . . .	—	—	(x)
	„ <i>Zeyheri</i> . . .	—	—	x
„ <i>sessilifolia</i> . . .	—	—	x	—
Totals . .	1	3	12	3

# Quantitative Experiments on the Effect of Formaldehyde on Living Plants.<sup>1</sup>

BY

SARAH M. BAKER,

*Quain Student at University College, London.*

With Plates XXX and XXXI and four Figures in the Text.

THERE are no chemical problems so fascinating or so elusive as those which are continually presenting themselves in connexion with the metabolism of living plants and animals. The complexity of the reactions involved, and the microscopic dimensions of the tissues in which they take place, render an exact study of any one process an exceedingly difficult task. In general, it is only by the accumulation of a mass of more or less indirect evidence, obtained by many observers working from different stand-points, that any indication can be obtained of the course of a reaction as it occurs in living tissues.

The present investigation was undertaken in the hope that some light might be thrown on the problem of photosynthesis by a careful and detailed study of the action of formaldehyde on living plants. These hopes have only in part been realized, as the process appears to be much more complicated than has often been supposed.

## Previous Work on the Subject.

Almost all the chemical theories which, from time to time, have been brought forward to explain the process of carbon assimilation in green plants, begin from the assumption that formaldehyde is the first product in the reduction of carbon dioxide.

From a purely chemical point of view, much evidence is available that, if a suitable source of energy is provided, carbon dioxide can be converted into carbon monoxide or formaldehyde in the presence of water, and thence in alkaline solution to ketoses and aldoses. The recent work of Stoklasa<sup>2</sup>

<sup>1</sup> Thesis approved for the Degree of Doctor of Science in the University of London.

<sup>2</sup> Stoklasa and Zdobincky: *Biochem. Zeit.*, 1911, xxx. 433-56; and Stoklasa, Sebor, and Zdobincky: *Biochem. Zeit.*, 1912, xli. 333-72.

and Berthelot<sup>1</sup> and their collaborators on the effect of ultra-violet light on carbon dioxide and water seems in some ways closely analagous to natural photochemical reactions. Besides this, Usher and Priestley<sup>2</sup> have brought forward evidence of the production of formaldehyde and hydrogen peroxide from carbon dioxide and water by means of chlorophyll in sunlight.

Direct evidence as to the presence of formaldehyde in plant tissues<sup>3</sup> or its effect on living plants has, however, been meagre. The well-known toxicity of formaldehyde precluded its application in aqueous solutions, except at very great dilutions.<sup>4</sup>

Th. Bokorny<sup>5</sup> was the first to try the effect of formaldehyde vapour on plants. He found that cress seeds could be grown, in an air-space containing formaldehyde vapour, for thirty days, while those without formaldehyde came to grief much sooner. But Viktor Grafe<sup>6</sup> considerably elaborated and extended Bokorny's methods, and tried the effect of formaldehyde and other vapours on seedlings of *Phaseolus vulgaris*. He found that in light formaldehyde vapour could be tolerated up to a large percentage in the air, but its toxic effect at once became pronounced in darkness, or on colourless parts of the plant. He also found a noticeable increase in the size of the formaldehyde cultures in light (as compared with controls free from carbon dioxide), but no sign of increase in the dark. He tried several other compounds: acetic, salicylic, and benzoic aldehydes, and also acetic and benzoic acids, but found no increase in these cases. Although these results indicate the possibilities of using formaldehyde in vapour form as a source of carbon for higher plants, they are all purely qualitative, and it seemed very desirable to have a definite quantitative determination of its effect on living plants in order to test the value of the chemical theories, involving the production of formaldehyde, in the course of photosynthesis.

#### General Aim of the Experiments.

The quantitative treatment of living material is a process involving many difficulties. In the experiments to be described the idea has been to subject plants to the action of formaldehyde vapour, and to estimate the gross effect of the reagent by weighing the cultures dry before and after treatment. Dry seeds have been used as the starting-point for every experiment, and, in order to grow these in an atmosphere of known composition and under as nearly as possible natural conditions, a somewhat complicated apparatus was used, which it is necessary to describe in detail before proceeding to the actual experiments.

<sup>1</sup> Berthelot and Gaudechon: Compt. Rend., 1910, cli. 395-7.

<sup>2</sup> Usher and Priestley: Proc. Roy. Soc., vol. lxxxiv, B, p. 101.

<sup>3</sup> Bokorny: Chem. Zeit., 1909, xxxiii. 1141-2 and 1150-1.

<sup>4</sup> Bokorny: Biochem. Zeitschr., 1911, xxxvi. 83-97.

<sup>5</sup> Bokorny: Pflügers Archiv für Physiologie, Bd. cxxviii, S. 565, 1905.

<sup>6</sup> Grafe: Ber. d. Deut. Bot. Ges., xxix, 1911, Heft iv, S. 19.

### General Experimental Methods.

The first essential was to grow the plants under as nearly normal conditions as possible. The whole apparatus (shown diagrammatically in Fig. 1) was set up in a sunny conservatory. The cultures, contained in three inverted glass bell-jars, were set side by side at the south end of the house. For each experiment two controls were used, one with normal air containing carbon dioxide, the other with air free from carbon dioxide. A continuous current of air was passed through the whole apparatus, so that no 'damping off' of the cultures occurred. The organic vapour to be tested was introduced into the air-current in minute traces just before it was bubbled into the critical culture. A special method of watering was used, so that the plants could grow undisturbed in the apparatus for four or five weeks.

Desiccated seeds were used as the starting-point for each culture, because their dry weight could be accurately ascertained, and also so that the young plants should become accustomed to the treatment from the first. When first set they were moistened with pure distilled water; their further requirements were supplied from an automatic waterer, set above each culture, in the form of a nutrient solution (containing 0.2 gramme each of  $\text{KH}_2\text{PO}_4$ ,  $\text{KNO}_3$ ,  $\text{MgSO}_4$ , and  $\text{CaSO}_4$  per litre).

After three or four weeks' growth, the culture without carbon dioxide showed signs of flagging, and this condition necessarily stopped the particular experiment; for a vigorous growth of mould or bacteria on any of the cultures would have vitiated the weight relations involved. All the cultures were therefore removed from their bell-jars and measured or photographed. Then they were quickly carried to an oven, heated for some hours to  $80^\circ$ – $100^\circ$ , dried in a calcium chloride desiccator, and weighed. After subtracting the weight of nutrient salts, calculated from the weight of nutrient solution given to the plants, this gave the final dry weights of the cultures. These could be compared directly with the original dry weights of the seeds used.

The important difference between these experiments and others on similar lines is that here the plants are weighed and put into the apparatus as seeds, and growth can continue for some weeks in a continually changing atmosphere containing a given amount of any desired vapour. Also, on account of the air-current, the vapours to be experimented upon can be used in very minute quantities, comparable to the amount of  $\text{CO}_2$  normally present in air, and the chances of poisoning effects are reduced to a minimum.

### Details of the Experimental Methods.

#### *The Treatment of the Seeds.*

The seeds were weighed out—after being kept some time in a calcium-chloride desiccator—on to small tared glass 'Petri dishes', about five or

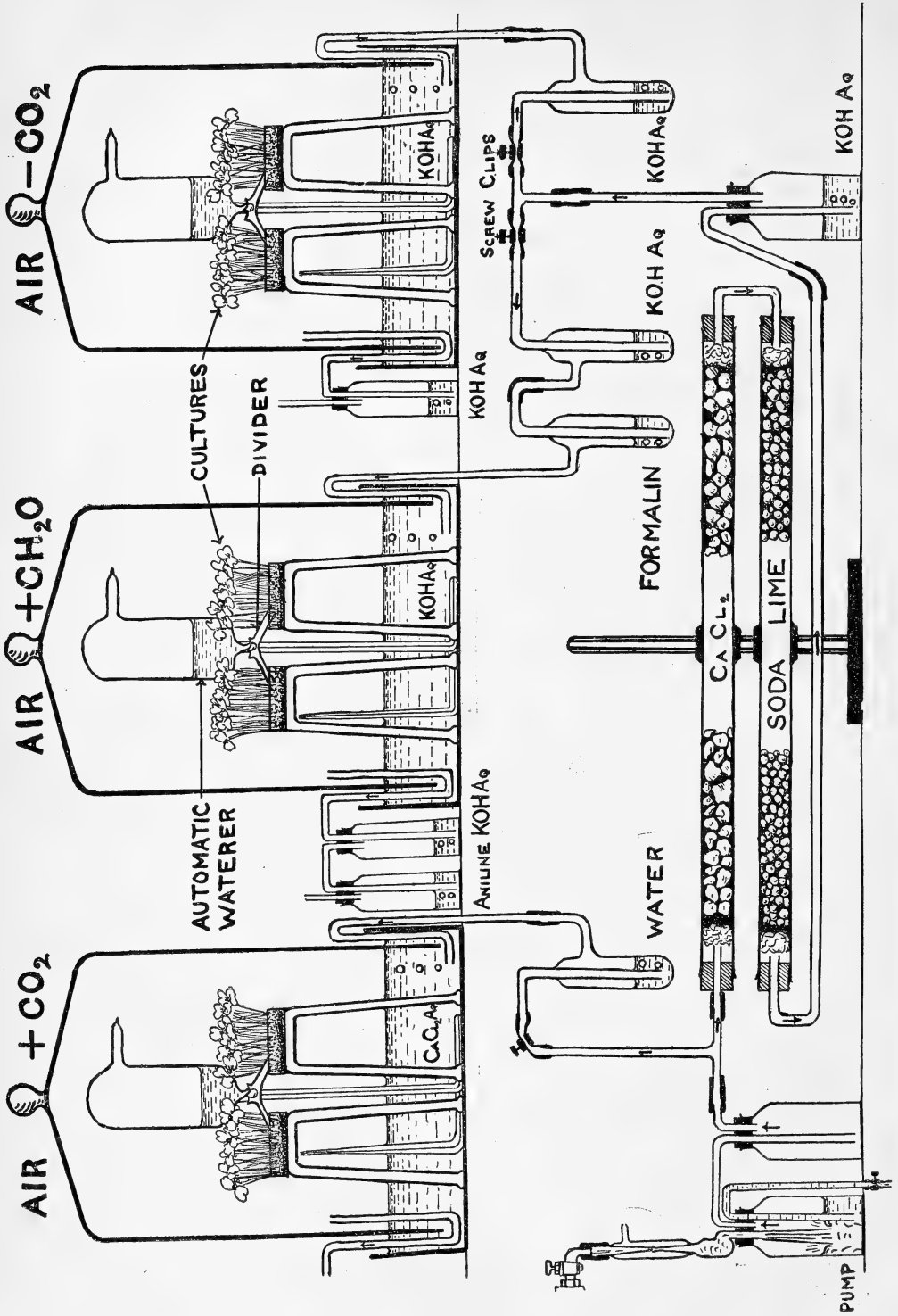

TEXT-FIG. 1. Diagram of apparatus used to investigate the effects of organic vapours on plants. Arranged for the use of formaldehyde.



six centimetres across, filled with dry sand. The sand was then moistened with distilled water, and the cultures set on glass tripods in a large bath of water. Where carbon dioxide was to be excluded, this water contained 10 per cent. of stick potash, and where the air contained carbon dioxide a little calcium chloride was added to the water to prevent algal growths. A weighed waterer containing nutrient solution was set above each culture. Then a glass bell-jar, supported on the edges of a large porcelain 'developing dish', was inverted over each culture (or pair of cultures) so that its rim was covered to a depth of about three centimetres by the water or potash solution in the bath. The only connexion with the outside was now through the air inlet- and exit-tubes, which dipped, through the solution in the bath, under the rim of the bell-jar.

*The Watering of the Seeds.—The Automatic Waterer.*

The solution to this problem gave the key to the whole investigation.

A watering apparatus was required which would give small and regular quantities of water over a considerable period of time, and, if possible, introduce no organic substance, such as rubber tubing, into the gas globe. After experimenting for about eighteen months with various forms of siphon-tube, connected with a reservoir, outside the gas globe, through which water could be introduced by a tap worked by hand, it was found that all such methods were highly unsatisfactory.

An automatic waterer was then devised, of which Text-fig. 2 is a diagrammatic sketch. It is composed of a glass reservoir drawn out into a narrow outlet-tube below. Two glass tubes were sealed into the top of the reservoir. One of these was drawn out into a fine end, which could be opened for filling the apparatus and then sealed again with a blowpipe. The other tube was sealed into a long piece of capillary tubing, conveniently bent to form a stand for the apparatus. The principle upon which its action depends is very simple. The apparatus is filled by putting the outlet-tube under water and applying suction at the open end of the filling-tube. The end of the filling-tube is then sealed over. Now no water can escape from the apparatus until an equivalent volume of air has entered the space above it. There are now only two possible entries for air: one is through the water, of which more later;

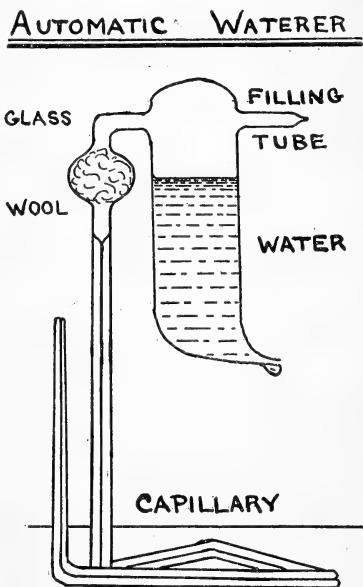

TEXT-FIG. 2.

the other is through the long bent capillary tube. By means of a well-known physical formula<sup>1</sup> it is possible to calculate the length and bore of tubing required to allow any given volume of air to enter at any temperature under the driving pressure represented by the height of the column of water in the reservoir. The necessary length is rather unwieldy for the small amounts of water (about 10 grammes per fortnight) required in these experiments. It works out to about 50 centimetres of 0.05 mm. bore capillary. But as the air admitted varies as the fourth power of the radius, and inversely as the length, a small decrease in the bore of the capillary is equivalent to a large increase in length, and so a convenient length of 0.5 mm. tubing was used, and this was then drawn out into exceedingly fine capillary at the end. The adjustment is made by breaking off small pieces of the fine capillary. Then the volume of water expelled is exactly equal to the volume of air admitted. The apparatus works admirably until the capillary tubing becomes blocked by condensed water, and the small bulb leading into the capillary tubing was filled with glass wool to prevent this as long as possible. No doubt this principle could be applied to a larger watering apparatus, the air being admitted through capillary tubing of suitable length, waxed into a well-fitting cork.

In actual practice it was found, however, that the other entry for air, through the solution itself, allowed sufficient water to escape, without the adjustment of the capillary, when the temperature underwent the usual diurnal variations, and so the end of the capillary was sealed over. The air above the water in the reservoir became so rarefied in the cool of evening that air bubbles were sucked up through the liquid, with the result that next day, as the air warmed again, water was expelled. This method of watering was the more convenient because the water-supply was automatically regulated to the needs of the plants; on hot days much water was expelled, on cool days little. But it could not be used to give much more water than about 15 grammes a week in summer unless a huge air-bulb were made at one side, and, of course, in a carefully regulated laboratory, where the temperature could be kept fairly constant, it would prove inadequate even for the needs of mustard seeds.

As a rule, one waterer was set above each culture, one culture occupying each bell-jar, but in one or two of the final experiments it was found convenient to make large waterers—the reservoirs about 4 cm. in diameter and 15 cm. high—which would hold sufficient water to last four or five weeks for two cultures, and have two cultures in each bell-jar. The water

<sup>1</sup> The volume of gas  $V$ , passing per second through a tube of length  $l$  and radius  $r$ , under a difference of pressure ( $p_1 - p_2$ ) is represented approximately by the equation  $p_2 V = \frac{(p_1^2 - p_2^2)}{16 l \eta} \pi r^4$ , where  $\eta$  is the coefficient of viscosity of the gas. (See Poynting and Thomson : Properties of Matter, p. 212, London, 1905.)

was then divided equally between the two cultures by allowing it to fall into the opening of a 'divider', i. e. a symmetrically bent glass tube open at both ends, and with another opening blown out at its apex (Text-fig. 1, Divider). The amount of nutrient solution given to the cultures could be accurately determined by weighing the waterers before and after each experiment.

*The Air Supply.*

A continual stream of air was kept passing through the apparatus, which prevented the 'damping off' of the cultures, so that healthy growth was maintained throughout. The importance of this in physiological experiments has been emphasized by F. F. Blackman.<sup>1</sup> In order to prevent any chance of the entrance of CO<sub>2</sub> through a possible leakage, and also to facilitate smooth running, pressure was used to drive the air through the apparatus, instead of suction. This is easily obtained from an ordinary water-suction pump by allowing the water and air drawn through with it to run through a trebly bored rubber cork into a bottle. The air is then forced out through a glass tube at the top of the bottle, while the water runs out through a siphon-tube reaching to the bottom. The use of a siphon-tube, instead of an outlet-tube worked with a tap, is to allow for variation in the water-pressure. The siphon adjusts the level of the water in the bottle, automatically, through a considerable range of pressures (Text-fig. 1, Pump).

*The Purification of the Air-current.* (See Text-fig. 1.)

From the pump the air was led first through an empty 'safety' bottle, then through calcium chloride to dry it, then through soda lime, and finally through two bubblers, filled with strong potash solution, to free it from carbon dioxide. As a final precaution, the bell-jars containing the cultures without carbon dioxide were inverted in troughs of dilute potash, and the entering air was bubbled through this. By adjustment of the screw clips next to the two glass T-pieces, the air could be divided equally between the three cultures, and was passed simultaneously through all the bell-jars. At one time, two experiments were running together, using five bell-jars, all worked from the same pump. The pressure required is small, provided the whole apparatus is air-tight.

*The Introduction of Small Traces of Formaldehyde Vapour into the Air-current.*

This was effected in three ways:

(a) The air was bubbled through ordinary commercial 'formalin', which is an aqueous solution of formaldehyde of about 40 per cent. concentration,

<sup>1</sup> Blackman: Phil. Trans. Roy. Soc., clxxxvi, 1895, B, pp. 485-502.

containing certain quantities of methyl alcohol and organic acids as impurities. These impurities were absorbed by the potash through which the vapour was passed, as it entered the bell-jar (Text-fig. 1).

(b) The air was passed over solid paraform, at known temperature. This is a polymer of formaldehyde, which yields the aldehyde in the form of pure vapour on heating.

(c) The air was passed through a 'diffusion bulb' containing formalin. This little apparatus (Text-fig. 3) was used for introducing more volatile

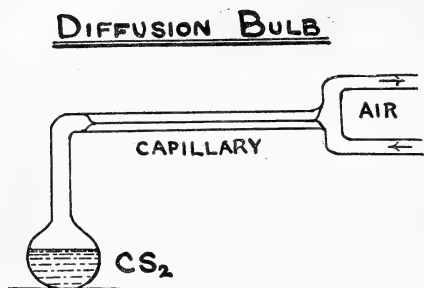

TEXT-FIG. 3.

vapours, such as carbon disulphide, into the air-current when required (see p. 441). The bulb was filled with the liquid (in this case formalin) by the method of heating and cooling, and then the air-current passed along the glass-tube, sealed into the opening of the capillary, T-piece fashion. The air carries with it the traces of formaldehyde vapour which diffuse through the capillary, thus leaving its vapour pressure at the opening of

the capillary always zero. This keeps the amount of vapour diffused out constant at a given temperature, the driving pressure being always equal to the vapour pressure of formaldehyde at that temperature.

#### *The Air Outlet.*

The air passed out of the bell-jar through a long bent glass tube, opening above the liquid in the bath and passing under the rim of the bell-jar through this liquid. In the cultures where carbon dioxide was excluded, the air passed out from the bell-jar through a caustic potash bubbler, to prevent possible access of carbon dioxide by a back rush of air; and where formaldehyde or acetic aldehyde was the vapour, this was cleared out of the air by bubbling through aniline. The pump was, however, about seven metres from the bell-jars, so that contamination of the air-stream was not probable.

### EXPERIMENTAL RESULTS.

#### Effect of Formaldehyde Vapour in the Air.

##### *Amount of Formaldehyde in the Air-current.*

Determined in a separate experiment by weighing the diffusion bulb, bubbler, or U-tube, containing the formalin or paraform used as the source of formaldehyde, before and after the passage of a known volume of dry

air, and subtracting from this loss in weight the weight of water and alcohol caught in a calcium chloride tube.

It was not thought worth while to make a long series of observations, through a range of temperatures and pressures in order to ascertain the exact percentage of vapour in the air at any time during the experiment (as, of course, both temperature and pressure varied widely during the course of a single day); but these values indicate roughly the concentration of the vapour under mean conditions. They are probably somewhat higher than the actual concentration in the bell-jar, because the caustic potash solution will dissolve and also destroy a certain fraction of the formaldehyde bubbled through it.

*Values:*

Source of CH <sub>2</sub> O.	Properties of the air.			Weight CH <sub>2</sub> O in vol. V. gm.	% CH <sub>2</sub> O in air by weight.
	Vol. litres.	Press. mm.	Temp.		
Diffusion bulb, cap. 4 cm., 0.5 mm. bore . . .	25.3	762	13°	0.0002	0.0006
Formalin solut. about 40 %	28.316	not obs.	16°	0.1782	0.5303
	56.632	" "	16°	0.3464	0.5155
Paraform in tube . . .	28.316	757	16°	0.0301	0.0872
	28.316	758	17°	0.0304	0.0880

For comparison, it may be noted that the maximum percentage of carbon dioxide normally present in the atmosphere is only 0.04 %, so that there is an adequate supply of potential carbon for purposes of photosynthesis produced by both the last two methods of producing formaldehyde.

A. EFFECT OF FORMALDEHYDE IN LIGHT.

The plants used in all these experiments were White Mustard—*Brassica alba*, Boiss.—and about sixty seeds were the starting-point for each culture.

EXPERIMENT I. May, 1911.

Source of formaldehyde: formalin in a diffusion bulb.

Amount of formaldehyde in air, about 0.0006 per cent.

Temperature range, 11° to 23°.

Duration, 23 days.

Atmosphere.	Orig. dry weight.	Final dry weight.	Final/orig. weight.
Air - CO <sub>2</sub> + CH <sub>2</sub> O	0.4050 gm.	0.2265 gm.	55.9 %
Air - CO <sub>2</sub>	0.4015 "	0.2175 "	54.2 %
Air + CO <sub>2</sub>	0.3995 "	0.4255 "	106.2 %

*Notes.*—The slight increase in weight of the formaldehyde culture made it appear possible that, with a greater concentration, assimilation might take place.

## EXPERIMENT II. July, 1912.

Source of formaldehyde: solid paraform at room temperature.

Amount of formaldehyde in air, about 0.09 %, or about three times as much potential carbon as in normal air containing 0.04 % of carbon dioxide.

Temperature range, 21.2° to 29.8°.

Duration, 22 days.

<i>Atmosphere.</i>	<i>Orig. dry weight.</i>	<i>Final dry weight.</i>	<i>Final/orig. weight.</i>
Air - CO <sub>2</sub> + CH <sub>2</sub> O	0.3865 gm.	0.3105 gm.	80.34 %
Air - CO <sub>2</sub>	0.3855 "	0.2451 "	63.59 %
Air + CO <sub>2</sub>	0.3875 "	0.4446 "	114.74 %

*Notes.*—A photograph of these cultures is shown in Plate XXX A. The effect of formaldehyde was to make the plants stouter and with somewhat broader cotyledons than those without carbon dioxide. The second leaves were developed, but to a less extent than in presence of carbon dioxide.

In the two following experiments the concentration of formaldehyde in the air was five times as great as in Experiment II; and yet it will be seen that there is only a very slight additional increase in dry weight produced. From this it appears probable that the maximum assimilation of formaldehyde has been obtained.

## EXPERIMENT III. June, 1911.

Source of formaldehyde: formalin at room temperature.

Amount of formaldehyde in air, about 0.52 %, or more than fifteen times as much potential carbon as is present in normal air containing 0.04 % of carbon dioxide.

Temperature range, 14° to 25°.

Duration, 24 days.

<i>Atmosphere.</i>	<i>Orig. dry weight.</i>	<i>Final dry weight.</i>	<i>Final/orig. weight.</i>
Air - CO <sub>2</sub> + CH <sub>2</sub> O	0.4015 gm.	0.3585 gm.	89.3 %
Air - CO <sub>2</sub>	0.3985 "	0.2590 "	65.0 %
Air + CO <sub>2</sub>	0.3965 "	0.4035 "	102.0 %

## EXPERIMENT IV. May, 1912.

Source of formaldehyde: formalin at room temperature.

Temperature range, 14.5° to 20.8°.

Duration, 26 days.

<i>Atmosphere.</i>	<i>Orig. dry weight.</i>	<i>Final dry weight.</i>	<i>Final/orig. weight.</i>
Air - CO <sub>2</sub> + CH <sub>2</sub> O	0.3845 gm.	0.3144 gm.	84.37 %
Air - CO <sub>2</sub>	0.3885 "	0.2608 "	67.01 %
Air + CO <sub>2</sub>	0.3860 "	0.4316 "	111.8 %

A fifth experiment was performed to see if a still further increase in the amount of formaldehyde would cause any increase in dry weight. The

percentage of formaldehyde in the air was about four times as great as in Experiments III and IV.

EXPERIMENT V. November, 1912.

Source of formaldehyde: formalin at about 50°.

Temperature range, 5° to 15°.

Duration, 28 days.

<i>Atmosphere.</i>	<i>Orig. dry weight.</i>	<i>Final dry weight.</i>	<i>Final/orig. weight.</i>
Air - CO <sub>2</sub> + CH <sub>2</sub> O	0.3780 gm.	0.3715 gm.	98.28 % (?)
Air - CO <sub>2</sub>	0.3840 "	0.1936 "	50.42 %
Air + CO <sub>2</sub>	0.3830 "	0.3645 "	95.17 %

*Notes.*—A photograph of these cultures is shown in Pl. XXX B. Formaldehyde at this concentration had decidedly toxic effects. The chief symptoms were stunted growth, little heliotropism, and a collapse of the hypocotyls. This last effect caused some of the plants to fall over into the potash solution, and, in spite of washing, some of this was probably retained over the surface, which caused the great increase in dry weight. This has, therefore, no special significance.

B. EFFECT OF FORMALDEHYDE IN THE DARK.

The general methods were the same as before, only the whole apparatus was set up in a dark room and the bell-jars covered with black paper; also the check dark experiment had carbon dioxide in the air.

EXPERIMENT VI. November, 1911.

Source of formaldehyde: formalin at room temperature.

Temperature range, 8.5° to 13.3°.

Duration, 33 days.

<i>Atmosphere.</i>	<i>Orig. dry weight.</i>	<i>Final dry weight.</i>	<i>Final/orig. weight.</i>
Air - CO <sub>2</sub> + CH <sub>2</sub> O, dark	0.3895 gm.	0.1498 gm.	38.48 %
Air + CO <sub>2</sub> , dark	0.3960 "	0.2247 "	56.50 %
Air + CO <sub>2</sub> , light	0.3840 "	0.3155 "	79.56 %

*Notes.*—A photograph of these cultures is shown in Pl. XXXI c. The effect of formaldehyde in the dark was not notably toxic. The diminished etiolation and slight development of root-hairs were the most noticeable features of the formaldehyde culture, and these effects were in part produced by deficient water-supply.

A second experiment was performed to see whether a gain in weight would be shown in the dark if chlorophyll had been formed in the leaves first. The two 'dark' cultures were first kept fourteen days in light, without carbon dioxide, and then the bowls were transferred bodily into the dark room. The formaldehyde bell-jar was not lifted at all in the process.

## EXPERIMENT VII. November, 1912.

Light without carbon dioxide, and then darkness.

Source of formaldehyde: formalin at room temperature.

Temperature range, 6° to 15°.

Duration, 28 days.

Atmosphere.	Orig. dry weight.	Final dry weight.	Final/orig. weight.
Air - CO <sub>2</sub> + CH <sub>2</sub> O, dark	0.3845 gm.	0.2869 gm.	74.62 %
Air + CO <sub>2</sub> , dark	0.3845 "	0.3175 "	82.52 %
Air + CO <sub>2</sub> , light	0.3830 "	0.3645 "	95.17 %
Air - CO <sub>2</sub> , light	0.3840 "	0.1936 "	50.42 %

Notes.—A photograph of these cultures is shown in Pl. XXXI D. The effect of formaldehyde was immediately toxic. The first symptom was a collapse of the hypocotyls just below the cotyledons, and after that no etiolation was produced. The relative large weight of both the 'dark' cultures, compared with the 'light' culture without carbon dioxide, was no doubt due to decreased respiration under the conditions obtaining in the dark room, where the temperature was uniformly lower than in the conservatory.

#### Discussion of Results.

The cultures in light, with traces of formaldehyde in the air, show uniformly an increase in dry weight compared with the cultures free from all carbon. This increase in dry weight seems to depend also, to some extent, on the amount of formaldehyde present in the air, but does not appear to be proportional to it. That is, after a certain percentage of the vapour in the atmosphere, a greater concentration does not cause a corresponding increase in dry weight. This seems to indicate that the maximum increase in weight possible with formaldehyde has been attained; and that, therefore, the percentage of the gas was no longer a determining factor in the reaction. The increase in dry weight is not so great as the decrease due to respiration, so that plants will not continue to grow indefinitely in formaldehyde. The increase due to formaldehyde is not so great as that due to carbon dioxide, even when the proportion of potential carbon in the air is greater in the former vapour. It would be natural to attribute the apparent gain in weight, under the influence of formaldehyde, to a decrease in the respiratory activities of the plants, but for the fact that the dark cultures show increased respiration due to formaldehyde stimulation.

Benedicenti and De Ton<sup>1</sup> have performed a series of experiments on *Nicotiana*, *Papaver*, and *Pelargonium*, and find that these plants show uniformly an increase in respiration, under the stimulus of formaldehyde vapour in darkness, until poisonous concentrations are reached. The only possible inference is, therefore, that the plant can make use of formaldehyde, for

<sup>1</sup> Benedicenti and De Ton: *Atti del Reale Istituto Veneto di Scienze, Lettere ed Arti*, 1901-1902, t. lxi, p. 329.



the synthesis of food materials, to a limited extent in light, but not at all in darkness. Bouilhac<sup>1</sup> and V. Grafe,<sup>2</sup> working by different methods, have previously come to a similar conclusion.

It may cause surprise that there was no greater increase in dry weight, even in the cultures under carbon dioxide. But it must be borne in mind that, during the first half of each experiment, before the cotyledons are unfolded, no assimilation can take place; and even in the latter part of the experiment a comparatively small green area has to supply materials for the respiration of the whole of the root and hypocotyl, besides its own requirements, before any increase in dry weight will be shown. It appears that in practice no actual increase in dry weight occurs until the first true leaves are unfolded; the assimilation due to the cotyledons being only sufficient to compensate for the losses in the first stages of germination. As explained above (p. 413), it was not possible to continue an experiment long after the culture without carbon dioxide showed symptoms of flagging, and so none of the cultures were continued for more than a few days after the leaves appeared in the culture under carbon dioxide.

#### *The Products of Photosynthesis with Formaldehyde.*

Qualitative experiments, on cultures grown simultaneously with Experiment V, in the light, confirmed Grafe's statement that no starch is formed from formaldehyde either in light or darkness, though the cotyledons contained some sugar. This need not necessarily lead to the conclusion that the process of photosynthesis is abnormal with formaldehyde, but merely that the reaction is not sufficiently vigorous to warrant the storage of starch in the corpuscles. Grafe also states that formaldehyde inhibits the action of amylase, the enzyme supposed to be the agent concerned in the synthesis of starch from sugar. This was not investigated.

#### *Poisonous Action of Formaldehyde.*

Grafe and Bokorny have already shown that traces of formaldehyde in the air do not poison plants in the light. The poisonous effect is, however, shown when the concentration of formaldehyde is sufficiently high, even in light (see Experiment V, light). The present experiments also show that plants grown from seed in the dark, under formaldehyde, show no symptoms of poisoning, provided always that the formaldehyde is purified by bubbling through caustic potash solution. Grafe's idea that the presence of chlorophyll acts as a protection against formaldehyde poisoning does not explain the case, for symptoms of poisoning were shown immediately after passing formaldehyde into a green culture in the dark (Experiment VII). The general conclusion to be drawn from the results appears to be that the light, or high temperature resulting from it, makes it possible for plants to

<sup>1</sup> Bouilhac et Gustiniani : Comptes Rendus, cxxxvi, 1903, pp. 1155-7.

<sup>2</sup> Grafe : loc. cit.

endure a larger dose of formaldehyde without poisonous effects than they otherwise would; also, that the plants can become accustomed to a certain amount of formaldehyde if reared from seed in presence of the vapour. The question has not been further investigated.

*Theoretical Deductions from Results.*

The basis for further inquiry was the observation that formaldehyde may function, to a limited extent, as a source of food-material for plants in light, but not in darkness. This shows that the plant is possessed of some agency by means of which it is able to absorb formaldehyde. More than this cannot be assumed, for there are several explanations of the way in which formaldehyde might be used by the plant after its absorption. These may be expressed under two main headings: either formaldehyde is the first step in photosynthesis, and its further elaboration requires light energy; or it is the last step in respiration, and is only used by the plant for photosynthesis after being converted by the respiratory processes into carbon dioxide. In either case there is a further possibility that the agency in question, which may be an enzyme, does not attack formaldehyde specifically, but is a general reagent for the aldehydic grouping, used to polymerize or oxidize quite a different compound in the plant tissues.

This last question led to a few experiments on acetic aldehyde, to see whether the aldehyde group would again be attacked.

**Effect of Traces of Acetic Aldehyde in the Air.**

*Amount introduced into the Air-current.*

It was almost impossible to estimate this accurately, especially in water solution, because of the extreme volatility of the aldehyde, which caused the concentration to change continually. The method used was the same as for formaldehyde (see p. 419).

*Values.*

<i>Source of Aldehyde.</i>	<i>Properties of Air.</i>			<i>Wt. of CH<sub>3</sub>CH<sub>2</sub>O evolved.</i>	<i>% CH<sub>3</sub>CH<sub>2</sub>O by pressure in air.</i>
	<i>Vol.</i>	<i>Press.</i>	<i>Temp.</i>		
	<i>litres.</i>	<i>mm.</i>		<i>grms.</i>	
Pure aldehyde in bubbler.	2.36	773	13°	3.8435	52.1
	1.18	773	12°	1.8800	51.3
40 % water solution of aldehyde	4.72	772	15.5°	0.7159	4.9
	4.72	773	15°	0.2584	1.8

Besides the uncertainty of these values the potash solution destroys a large proportion of the aldehyde vapour, forming a bright orange solution. However, the results serve to show that a large proportion of aldehyde could be obtained in the air. Probably the diffusion-bulb method, with pure aldehyde in the bulb, would be the best method of introducing it, but this was not used in the experiments.

*Effect of Acetaldehyde in the Air, in Light.*

EXPERIMENT I. December, 1912.

Source of aldehyde: pure liquid aldehyde.

Temperature range, 8° to 14°.

Duration, 14 days.

<i>Atmosphere.</i>	<i>Orig. dry weight.</i>	<i>Final dry weight.</i>	<i>Final/orig. weight.</i>
Air - CO <sub>2</sub> + CH <sub>3</sub> CH <sub>2</sub> O	0·3845 gm.	0·3326 gm.	86·50 %
Air - CO <sub>2</sub>	0·3850 "	0·3111 "	80·83 %
Air + CO <sub>2</sub>	0·3845 "	0·3279 "	85·28 %

*Notes.*—The effect of acetaldehyde on the plants, in this concentration, was strongly toxic. Most of the seeds germinated, and in some the cotyledons were unfolded, but they remained colourless, and the roots showed no geotropism.

The high value merely means inhibition of respiration.

EXPERIMENT II. February to March, 1912.

Source of aldehyde: 10% water solution.

Temperature range, 9·5° to 11°.

Duration, 19 days.

<i>Atmosphere.</i>	<i>Orig. dry weight.</i>	<i>Final dry weight.</i>	<i>Final/orig. weight.</i>
Air - CO <sub>2</sub> + CH <sub>3</sub> CH <sub>2</sub> O	0·3910 gm.	0·2915 gm.	74·54 %
Air - CO <sub>2</sub>	0·3885 "	0·2545 "	65·53 %
Air + CO <sub>2</sub>	0·3860 "	0·3530 "	91·45 %

*Notes.*—The increase in weight shown in presence of acetic aldehyde was probably due to retardation of respiration and general growth, as the cotyledons were unfolded a day later in aldehyde than in the 'control' cultures. There were no other symptoms of poisoning. The temperature and light conditions were so poor that the experiment was not considered conclusive.

EXPERIMENT III. July to August, 1912.

Source of aldehyde: 40% water solution.

Temperature range, 17·5° to 23·5°.

Duration, 28 days.

<i>Atmosphere.</i>	<i>Orig. dry weight.</i>	<i>Final dry weight.</i>	<i>Final/orig. weight.</i>
Air - CO <sub>2</sub> + CH <sub>2</sub> O	0·3870 gm.	0·2446 gm.	63·20 %
Air - CO <sub>2</sub> + CH <sub>2</sub> O	0·3875 "	0·2615 "	60·67 %
Air - CO <sub>2</sub>	0·3865 "	0·2455 "	63·52 %
Air - CO <sub>2</sub>	0·3860 "	lost	—
Air + CO <sub>2</sub>	0·3845 "	0·4325 "	112·40 %
Air + CO <sub>2</sub>	0·3850 "	0·3775 "	98·95 %

*Notes.*—The experiment was run with two cultures in each bell-jar, the first of the two cultures being nearer the light in every case; unfortunately the second culture without CO<sub>2</sub> was lost by an accident. The experiment

was continued until the two cultures without CO<sub>2</sub> showed signs of flagging (the ones with aldehyde were the first to do so). They may be taken as showing conclusively that acetic aldehyde cannot be used by the plant for photosynthesis. The plants showed no symptoms of poisoning under acetic aldehyde.

*Conclusion from Results.*—Acetic aldehyde cannot be used for photosynthesis, though its poisonous action tends to retard respiration, especially under unfavourable temperature conditions. Hence the aldehyde group is not the sole reason for the reaction in the case of formaldehyde, but the agency which can make use of formaldehyde in the plant is specific for that compound.

#### THE FORMALDEHYDE QUESTION.

The question remains (see p. 424): Is formaldehyde the first step in a complicated series of reactions requiring light energy in photosynthesis, or is it the last step in respiration, and hence converted by the plant into carbon dioxide? Without an answer to this primary question, the results with formaldehyde have no significance, as we cannot tell their real meaning. The obvious method of attacking this problem was to determine, quantitatively, the ratio between the weight lost and carbon dioxide evolved by the plants in respiration, with and without formaldehyde in the atmosphere. For, if formaldehyde is absorbed by the plant and converted into carbon dioxide, there will be more carbon dioxide evolved for a given loss of weight in the plant than under normal conditions. Before attempting to determine this, it was, however, necessary to find whether there was any definite relation between the weight lost and the carbon dioxide evolved during normal respiration, and to determine this relation if it was sufficiently definite.

#### *Quantitative Determination of the Ratio between the Loss in Weight of the Plants and the Carbon dioxide evolved during Respiration in Darkness.*

The only experiments in which a direct determination has been made of the ratio obtaining between the loss in weight of plants and the carbon dioxide of respiration were made some years ago by T. C. Day.<sup>1</sup> Day undertook an elaborate quantitative study of the chemical processes taking place during the earlier stages of the germination of barley. He found that a certain proportion of oxygen was absorbed and retained by the seeds, in excess of that oxidized to form carbon dioxide; but that, having allowed for this, the proportions between the loss in wet weight and dry weight of the seeds and the carbon dioxide evolved in respiration approximated very closely

<sup>1</sup> T. C. Day: Experiments on Germinating Barley and Influence of Temperature on Germinating Barley. Journ. Chem. Soc. Trans., 1880, pp. 645-58, and 1891, pp. 664-77.

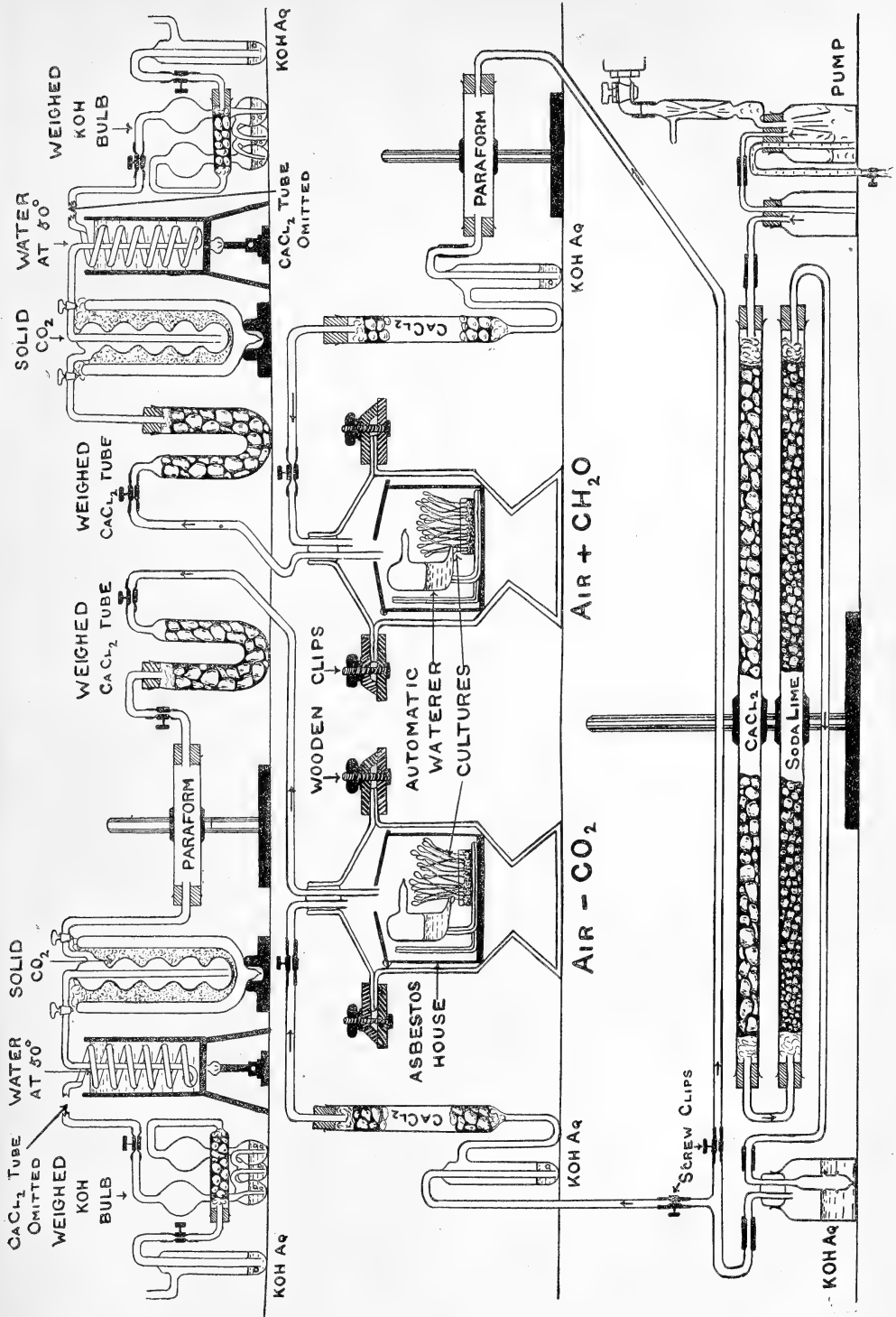

TEXT-FIG. 4. Diagram of apparatus used to estimate the quantitative effect of formaldehyde on plants in the dark. In the last experiments the position of the paraform tube and the KOH : CaCl<sub>2</sub> tube before the formaldehyde culture were reversed, so that the paraform tube was next to the culture.

to those represented by the chemical formula for the complete oxidation of a glucose :—

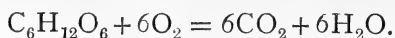

As there is no reason to believe that there is a definite or general chemical process always concerned in the complex oxidation reactions included under respiration, it was essential to determine these weight relations for mustard seeds germinating under the experimental conditions. For this purpose, several modifications of the original apparatus were necessary, and finally a somewhat complicated apparatus was used.

#### *General Experimental Methods.*

The apparatus used was similar to that shown diagrammatically in Text-fig. 4, except that the paraform tubes and the absorption apparatus for formaldehyde were omitted. The aim of the experiments was to find the loss in weight of the cultures, and also the total weight of carbon dioxide and water evolved during growth. The seeds, which had been desiccated over calcium chloride, were grown, as in the former experiments, on tared Petri dishes filled with dry sand. A separate experiment with three weighed amounts of the same seed, heated to 80°–100°, gave the loss in weight on heating and hence the true dry weight of the seeds. A second experiment gave the total gain in weight of the seeds on hydrolysis, by hydrolysing them with dilute acid. When first set, the seeds were moistened with a weighed amount of pure distilled water, and their later requirements were supplied by means of nutrient solution from an automatic waterer (as described on p. 415) of suitable size. The waterer could also be accurately weighed, before and after the experiment, which gives the amount of nutrient solution given to the culture. The seeds, supported on the base of the waterer, were contained in a 'vacuum' desiccator, with two glass tubes sealed through its glass stopper, through which a continual current of air was passed over them. Light was carefully excluded from the desiccator with a black cloth shade. The air-current was produced by pressure from a water-jet pump (as described on p. 417), freed from CO<sub>2</sub> (as in the former experiments) by means of soda lime and strong caustic potash, and dried by calcium chloride.

After from seven to fourteen days the plants had grown to the height of from 3 to 7 cm. They were then weighed, first wet and then dry. The drying was effected by heating to 80°–100° for some hours, and cooling in a calcium chloride desiccator.

#### *The Absorption of Carbon Dioxide.*

This was effected by means of a Liebig's absorption bulb, filled with very concentrated potash solution and with a calcium chloride tube sealed on to it to prevent loss of water from the bulb; the air-current was passed

through this bulb after leaving the cultures and the drying-tube. To prevent a possible backrush of air containing carbon dioxide, another potash bubbler was connected on to the exit-tube of the weighed Liebig bulb. It was found that the potash solution in the Liebig bulb had to be absolutely saturated, at room temperature, and the calcium chloride fresh and perfectly dry, or water escaped. If these precautions were observed, and the weighed apparatus was kept covered from dust, results could be obtained quite as accurate as the weighings of the seeds with which they were to be compared.

#### *The Absorption of Water.*

The quantitative determination of the water relations of the plants was a very fascinating problem, but the practical difficulties involved were so great that no really satisfactory method has so far been found. The observations are, however, sufficiently accurate to indicate the general nature of the relations.

The first important point is to keep the same water-absorbing medium throughout the apparatus, so that the air should not be more efficiently dried at one point than another, and so take up water from a reagent which is supposed to dry it, as is the case, for example, when air dried in sulphuric acid passes over calcium chloride. Calcium chloride was chosen as this drying reagent, not because it is the most efficient, but because it is clean and convenient, and gives no possibility of acid gases, even when acted upon by organic vapours.

Before commencing each experiment every precaution must be taken to exclude water from the whole apparatus. The desiccators, tap grease, tubing, &c., must all be dried with calcium chloride before use.

The first absorbent for water is a calcium chloride U-tube next to the desiccator containing the culture. This was kept open towards the desiccator, even when no air-current was passing, in order to keep the exit-tube dry.

In a few preliminary experiments it was found that while the U-tube absorbed about 1.5 grm. of water, about 2 grm. were lost in some way. The only possibility of loss was by condensation on the walls of the desiccator. To obviate this a second absorbent for water was made. This was a small 'house' of asbestos board, made to fit into the desiccator, which held the waterer and culture and had a hole in the roof for the air-tubes. The 'house' was varnished over the outside with shellac varnish, so that it could be weighed before and after each experiment. The rough inner surface of the 'house' absorbed much of the water of transpiration.

A third measure of water was by the original and final wet weighings of the seeds. For these weighings, in which a free evaporating surface of water was present, special methods had to be employed.

In the earlier experiments the method of timed weighings was employed. Allowance was made for the amount of water lost during weighing, by weighing the loss in the next interval of the same time. The weighings were done as rapidly as possible, but could not be very accurate, because of the continually changing values.

The second method used was to weigh the wet cultures, or 'house' inside a small paper hood which completely protected them from the outside air, and which could be weighed before or after the weighings. Even by this method a small loss, due to evaporation or condensation on the hood, occurred, but its amount was not great and its estimation could not lead to serious errors.

Besides these losses, a small loss always occurs in transferring the wet cultures to or from the desiccators. This was reduced as much as possible by speed in manipulation.

*Precautions to render the Apparatus Air-tight.*

It is of the utmost importance, in these experiments, that the whole apparatus should be absolutely air-tight. A considerable number of experiments were made before this result could be attained. The first essential is to have all rubber connexions irreproachable; absolutely sound, well-fitting corks, and thick pressure tubing, closed with double screw-clips, for all connexions. The second essential is to have air-tight ground-glass joints round the stoppers and lids of the desiccators. This last was not easy to secure. It was found that, though every joint was carefully greased, and then sealed over with paraffin wax, after about a week little bubbles of air worked their way through the grease round the desiccator lids, collected under the wax sheath, and finally cracked the wax and sprung a leak. After several experiments had been spoiled in this way, it was found that the desiccator lids could be kept air-tight by applying a little pressure from the outside to counteract the internal air-pressure. For this purpose my brother—Mr. G. R. Baker—designed and made a wooden clip to hold the lids tightly together. This consisted of a wooden frame fitting under the flange of the desiccator, with four wooden clips screwed down from it on to the upper edge of the desiccator lid, by means of metal thumb-screws. Two of these are shown in section in Text-fig. 4. When these were screwed down, and the lids greased and waxed round, no sign of leakage could be detected in any part of the apparatus during the whole time.

Finally, to prevent the movement of air from one part of the apparatus to another when the air-current was not passing, the screw-clips at each side of the weighed apparatus and the desiccator were closed, immediately after stopping the pump. Only one of these was kept open, that between the desiccator and the calcium chloride U-tube, in order to prevent the air exit- and inlet-tubes from condensing moisture.



EXPERIMENTAL RESULTS.

*Determination of the true Dry Weight of Desiccated Seeds.*

The seeds were weighed out on to tared watch-glasses, heated for several hours to 80°-100°, cooled in a calcium chloride desiccator and weighed.

*Results:—*

	<i>Expt. 1.</i>	<i>Expt. 2.</i>	<i>Expt. 3.</i>
Original weight	0.4010 gm.	0.4010 gm.	0.3980 gm.
Final weight	0.3860 "	0.3855 "	0.3830 "
Water lost	3.74 %	3.62 %	3.77 %

Mean amount of water lost = 3.71 %

This mean value was used in calculating the dry weight of the seeds in the respiration experiments. In the later experiments two or more weighed quantities of ground seeds were heated, simultaneously with the cultures, to give their loss in weight on heating. This was necessary because of the impossibility of exactly regulating the temperature of the oven, and also because, after prolonged heating, some charring was produced.

*Determination of the Gain in Dry Weight due to Hydrolysis.*

In order to find the true loss in dry weight due to respiration, it was necessary first to know the total gain in weight due to hydrolysis of sugars, &c., during germination. This was not easy to determine, and even when concordant results were finally obtained, they can only roughly indicate the real value in the plant, because an inorganic hydrolysing agent was used whose action may differ widely from that of the enzymes in the germinating seeds.

The mustard seeds were found to contain no starch, but a considerable reserve of fats and proteins, together with the glucoside of mustard oil.

On hydrolysing them in the ordinary way with 10 % HClAq and evaporating off the acid over a water-bath, so much charring of the sugars occurred that it was impossible to obtain concordant results. Besides this, the uncharred sugars were so deliquescent that they formed syrupy drops even in the desiccator. Experiments were made in which the HClAq was distilled off from a weighed retort *in vacuo* at temperatures of 20° to 30°. Here less charring occurred, but it was necessary to dry the weighed vessel for some hours in a current of dry air at 50°, and the action of the remaining HCl vapour on the seeds at this temperature seemed to induce further charring. The results were more nearly concordant, but were not considered sufficiently satisfactory.

The final method employed was to digest the seeds, previously ground to powder in a dry pestle and mortar, with 10 c.c. of 2 % HClAq for five to eight hours, and then to allow the mixture to stand for two or three weeks in a vacuum desiccator over stick potash until all signs of moisture

were gone. Then they were heated to 80°–100°, cooled in a calcium chloride desiccator, and weighed. A blackening over the surface was still produced, but this may have been rather an oxydase action than due to true charring.

	<i>Expt. 1.</i>	<i>Expt. 2.</i>	<i>Expt. 3.</i>	<i>Expt. 4.</i>	<i>Expt. 5.</i>	<i>Expt. 6.</i>
	<i>grm.</i>	<i>grm.</i>	<i>grm.</i>	<i>grm.</i>	<i>grm.</i>	<i>grm.</i>
Original weight	0·4715	0·3917	0·4767	0·4084	0·3998	0·4259
Original dry weight	0·4540	0·3772	0·4590	0·3826	0·3745	0·3989
Final dry weight	0·4801	0·3968	0·4853	0·4062	0·3954	0·4234
Gain in dry weight	0·0261	0·0196	0·0263	0·0236	0·0209	0·0245
% gain due to hyd.	5·75 %	5·21 %	5·73 %	5·78 %	5·23 %	5·75 %
Mean value for gain in hydrolysis = 5·58 %						

The mean of these results has been used in calculating the loss in dry weight during respiration. The total loss during respiration was taken as the loss in dry weight observed in the respiration experiment plus this value for the gain in dry weight on hydrolysis.

#### *Experimental Results for Respiration.*

The first two experiments were running simultaneously from October 7 to 21, 1912. Of the two cultures, Experiment 2 grew far the more luxuriantly, as the waterer of Experiment 1 was not correctly adjusted, and so the plants suffered through insufficient water-supply. At the end of the experiment the plants in Experiment 1 were only 3 cm. high and were of stunted and irregular growth. In Experiment 2, however, the plants were 10 cm. high and very healthy in appearance, but they grew out at the top of their 'house' before it was possible to stop the experiment, and so reached the 'dead' space between the air inlet- and exit-tubes, and no doubt a certain amount of the water of transpiration was lost on the sides of the desiccator, and perhaps also some of the carbon dioxide was 'dead-locked' between the air-tubes.

The third experiment was running from October 24 to November 4, 1912. The plants were well grown, about 3 cm. high; the same waterer was used as for Experiment 2.

The wet weighings in all these experiments were done by the method of 'timed' weighings. The balance used was by Becker, London, but only sensitive to 0·0005 grm.

QUANTITATIVE RESULTS ON RESPIRATION IN DARKNESS.

	<i>Expt. 1.</i>	<i>Expt. 2.</i>	<i>Expt. 3.</i>
	<i>grm.</i>	<i>grm.</i>	<i>grm.</i>
Orig. wt. . . . .	0·4020	0·4020	0·4000
Orig. dry wt. . . . .	0·3870	0·3870	0·3850
Final dry wt. . . . .	0·3670	0·3426	0·3865
Change in dry wt. . . . .	-0·0200	-0·0444	+0·0015
Gain on hydrolysis . . . . .	0·0224	0·0224	0·0223
Total loss in resp. dry . . . . .	0·0424	0·0668	0·0208
Dist. water given . . . . .	4·7225	3·3590	3·2235
Nut. soln. given . . . . .	0·5985	7·3965	5·0335
Total water given . . . . .	5·3210	10·7555	8·2570
Water on seeds . . . . .	1·5810	6·6020	5·1320
Water in CaCl <sub>2</sub> . . . . .	0·6735	0·4925	1·3955
Water in 'house' . . . . .	3·0510	3·3260	1·7185
Total water caught . . . . .	5·3055	10·4205	8·2460
Loss in wet wt. . . . .	0·0155	0·3350	0·0110
H <sub>2</sub> O evolved in resp. . . . .	0·0269		0·0098
CO <sub>2</sub> evolved in resp. . . . .	0·0590	0·0885	0·0285
<i>Theoretical Values.</i>			
CO <sub>2</sub> calc. from dry wt. . . . .	0·0620	0·0981	0·0303
CO <sub>2</sub> calc. from wet wt. . . . .	0·0568		0·0403

The last two sections show the values for carbon dioxide, calculated from the found loss in dry weight and wet weight of the plants respectively, on the assumption of the quantitative formula for respiration representing the complete oxidation of a glucose :—

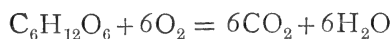

Parts by weight . . . . . 30            32            44            18

(The proportions obtaining when a polysaccharide, such as saccharose or starch, is oxidized are sufficiently close to these to be within the limits of experimental error.) It will be seen that, except in the 'wet' values of Experiment 2, which (as explained above, p. 432) are probably low because the plants grew out of their 'house', these calculated values approximate very closely to the found weights of CO<sub>2</sub>. This shows that in mustard seeds, under the experimental conditions, respiration is, in the main, represented by a reaction in which carbohydrate is converted quantitatively into carbon dioxide and water.

There is, therefore, a somewhat surprising agreement with the results of Day (previously cited, p. 426) for germinating barley. This is particularly remarkable when it is remembered that mustard is an oily and barley a starchy seed. Besides this, Day's experiments were only concerned with the very first stages of germination, before the plumule had appeared; while in the present experiments it has been found that by far the greater

proportion of carbon dioxide (about 80 per cent.) is evolved after the cotyledons have emerged. In the present investigation no constant gain in weight of the seeds has been detected, which could be attributed to absorption of oxygen; this may be due to the comparatively prolonged experiments. Day, on the other hand, did not take into account the gain in dry weight due to the hydrolysis of his seeds, which has been found to be such an important factor in these experiments.

#### QUANTITATIVE EXPERIMENTS ON THE FORMALDEHYDE PROBLEM

(see p. 426).

Having found the relation between the loss in weight of the plants and the amount of carbon dioxide evolved by them in respiration under normal conditions, it was possible to proceed to investigate the question: Is formaldehyde a step in respiration and converted by the plant into carbon dioxide, or is it merely a step in photosynthesis, requiring light energy for its further elaboration?

#### *General Experimental Methods.*

The apparatus used is shown diagrammatically in Text-fig. 4 (p. 427). It consists fundamentally of the ordinary respiration apparatus, with arrangements for introducing small traces of formaldehyde into the air and for removing it again quantitatively.

In these experiments two exactly similar cultures, with desiccators, &c., of the same dimensions, were grown simultaneously. In one culture the formaldehyde was introduced into the air before it passed over the cultures; in the other 'check' experiment it was introduced immediately after the air had passed the calcium chloride tube. When the air had been quantitatively freed from formaldehyde and any other volatile substance used to condense this, the 'check' experiment should show exactly the same weight relations between the loss in weight of the plants and the carbon dioxide evolved during respiration as was found in the earlier respiration experiments.

The general method of procedure was exactly the same as in these experiments (see p. 428 et seq.).

A great many experiments were made before the quantitative absorption of formaldehyde could be satisfactorily accomplished. A short account of these may perhaps be given before proceeding to the final method used, as they not only indicate some of the difficulties involved, but also some of the capabilities and dangers of the gravimetric method of plant physiology.

#### *Experiments in which Chemical Absorbents for Formaldehyde were used.*

There are two general chemical methods for the estimation of formaldehyde. One depends on its oxidation to formic acid. This is obviously

unsuitable for the present experiments, as formic acid would be even more readily absorbed by the potash bulb used to absorb carbon dioxide than the aldehyde itself. The other depends on its absorption by ammonia to form formamide. Ammonia itself was too volatile for convenient use in the present experiments, so a modification of the method was used and aniline was chosen as the absorbent for formaldehyde. This works fairly efficiently, but the great drawback to its use was the difficulty of reabsorbing the aniline vapour carried away by the air-current.

The first absorbent used was fused calcium chloride, but this did not absorb the vapour quantitatively.

The second absorbent was calcium chloride and then concentrated sulphuric acid, but the sulphuric acid dried the air so much more efficiently than calcium chloride that the potash bulbs lost water, and their change in weight gave no measure of the carbon dioxide absorbed by them.

The results show one or two interesting points, however, and so they are recorded here.

- Expt. 1. Source of  $\text{CH}_2\text{O}$  . . . Formalin solution.  
 Absorbents . . . . . Aniline, then  $\text{CaCl}_2$ .  
 Expt. 2. Source of  $\text{CH}_2\text{O}$  . . . Paraform.  
 Absorbents . . . . . Aniline, then  $\text{CaCl}_2$ .  
 Expt. 3. Source of  $\text{CH}_2\text{O}$  . . . Paraform.  
 Absorbents . . . . . Aniline, then  $\text{CaCl}_2$ , then  $\text{H}_2\text{SO}_4$ .

*Results:—*

	<i>Expt. 1.</i>		<i>Expt. 2.</i>		<i>Expt. 3.</i>	
	+ $\text{CH}_2\text{O}$ .	- $\text{CH}_2\text{O}$ .	+ $\text{CH}_2\text{O}$ .	- $\text{CH}_2\text{O}$ .	+ $\text{CH}_2\text{O}$ .	- $\text{CH}_2\text{O}$ .
	<i>gm.</i>	<i>gm.</i>	<i>gm.</i>	<i>gm.</i>	<i>gm.</i>	<i>gm.</i>
Loss in dry wt. . .	0·0188	0·0304	0·0131	0·0108	0·0193	0·0231
Gain on hyd. . . .	0·0223	0·0223	0·0225	0·0223	0·0223	0·0223
Total loss in resp.	0·0411	0·0527	0·0356	0·0331	0·0416	0·0454
Gain of KOH bulb	+ 0·0770	0·0000	+ 0·0927	+ 0·0652	+ 0·0023	- 0·0105
$\text{CO}_2$ calculated . .	0·0603	0·0774	0·0524	0·0484	0·0612	0·0576

These results serve to show the inadequacy of the chemical methods of absorbing formaldehyde. In Experiment 1 the water solution of formaldehyde, after the culture without formaldehyde, absorbed the whole of the carbon dioxide as well as the aniline. In Experiment 3 the sulphuric acid used to absorb aniline caused a loss of water from the potash bulbs. In Experiment 2 the whole of the aniline was not absorbed. But, as a slight increase in the weight of carbon dioxide was shown by the formaldehyde culture in all these experiments, it was thought probable from these results that formaldehyde was used as a source of carbon dioxide; but as the amount of aniline passing through would depend on the speed of the air-current, which was hard to regulate uniformly, no real conclusion of any kind can be drawn from the experiments.

The variations in weight between the two check cultures are chiefly due to differences in the water-supply, which is a very important factor in respiration in the dark.

*Physical Methods for the Absorption of Formaldehyde.*

The experiments detailed above led to the final abandonment of chemical methods for absorbing formaldehyde. The physical method used was as follows. The formaldehyde was condensed out of the air by cooling it to the temperature of solid carbon dioxide. Formaldehyde polymerizes at 0° to form its polymer, the solid paraform, whose vapour pressure at this very low temperature would be negligible.

*Experimental Methods.*

The condensing apparatus is shown in Text-fig. 4. The air was first passed through an empty Walther's condenser, which was cooled in carbon dioxide snow contained in a vacuum cylinder. At this temperature the formaldehyde should condense and the traces of carbon dioxide in the air pass on. The air was then warmed in a water bath at about 50°, and passed through a long calcium chloride tube (not shown in the diagram) to bring it to room temperature, and the humidity of air dried by calcium chloride, in order that no evaporation of water may take place from the potash bulb. It was necessary to have the glass apparatus sealed together with ground-glass taps because of the low temperature. The taps were greased with a mixture of vaseline, rubber, and paraffin-wax, and were air-tight.

The carbon dioxide and water were estimated in the same way as in the former experiments (p. 431 et seq.), and the plants were treated similarly.

*Notes.*—In Experiment 1 the apparatus was newly set up and was not dried sufficiently long before the experiment, hence the irregular wet weight values.

In Experiment 4 a certain quantity of water condensed in the air exit-tubes, and so escaped estimation.

The excess of water, apparent in all the formaldehyde cultures, is partly due to partial condensation of the formaldehyde from the air-current into the water on the cultures and also into the calcium chloride tube.

After the first two experiments were completed, it was found that only a very small trace of formaldehyde had actually been passing over the formaldehyde culture, as a large proportion of the vapour was absorbed by the concentrated potash and the calcium chloride, which intervened between the culture and the source of formaldehyde. For this reason, in the last two experiments the positions of the paraform tube and potash

bubbler were reversed, so that the paraform tube came next to the culture. In the Experiments 3 and 4, therefore, the full percentage of formaldehyde yielded by paraform at room temperature (about 0.0875%; see p. 419) was present in the air which passed over the formaldehyde culture.

In all these experiments (except the 'check' without formaldehyde of Experiment 4, which suffered from excessive water-supply) growth was healthy and the plants vigorous and well developed. No toxic symptoms, except the sparse production of root-hairs, were shown by any of the formaldehyde cultures.

Each experiment lasted from ten to fourteen days, and the plants varied in height from 3-10 cm., according to the prevailing temperature conditions.

The Balance used was by Oertling, London, sensitive to 0.0001 gm. and taking a 250 gm. load.

*Quantitative Results on the Effect of CH<sub>2</sub>O in Darkness.*

	<i>Expt. 1.</i>		<i>Expt. 2.</i>		<i>Expt. 3.</i>		<i>Expt. 4.</i>	
	+ CH <sub>2</sub> O.	- CH <sub>2</sub> O.	+ CH <sub>2</sub> O.	- CH <sub>2</sub> O.	+ CH <sub>2</sub> O.	- CH <sub>2</sub> O.	+ CH <sub>2</sub> O.	- CH <sub>2</sub> O.
	<i>grms.</i>	<i>grms.</i>	<i>grms.</i>	<i>grms.</i>	<i>grms.</i>	<i>grms.</i>	<i>grms.</i>	<i>grms.</i>
Orig. wt. . . . .	0.4006	0.4003	0.3998	0.4000	0.4036	0.4040	0.4090	0.3996
Orig. dry wt. . . . .	0.3470	0.3467	0.3690	0.3692	0.3734	0.3738	0.3940	0.3857
Final dry wt. . . . .	0.3333	0.3296	0.3577	0.3378	0.3456	0.3357	0.3784	0.3796
Loss in dry wt. . . . .	0.0137	0.0171	0.0113	0.0314	0.0278	0.0381	0.0156	0.0061
Gain on hydrolysis . . .	0.0223	0.0223	0.0223	0.0223	0.0225	0.0225	0.0227	0.0223
Total loss in resp. dry	0.0360	0.0394	0.0336	0.0537	0.0503	0.0606	0.0383	0.0284
Dist. water given . . .	4.4993	3.7722	4.5016	5.1525	6.4749	6.0366	6.1381	5.5325
Nut. soln. given . . . .	2.3957	2.3994	3.1317	3.1672	3.8469	7.7656	5.3754	5.7964
Total water given . . .	6.8950	6.1716	7.6333	8.3197	10.3218	13.8022	11.5135	11.3289
Water on seeds . . . . .	1.9101	1.7110	1.9563	2.7190	5.4852	8.3693	8.5885	8.3411
Water in CaCl <sub>2</sub> . . . . .	0.4517	0.6334	0.6988	0.6376	0.3217	0.2857	0.4513	0.2676
Water in 'house' . . . .	5.2175	4.0922	5.0845	4.9417	4.6569	5.1136	2.3814	2.5856
Total water caught . . .	7.5793	6.4366	7.7396	8.2983	10.4638	13.7686	11.4212	11.1943
Loss in wet wt. . . . .				0.0214		0.0336	0.0923	0.1346
H <sub>2</sub> O evolved . . . . .				0.0323		0.0270		
CO <sub>2</sub> evolved . . . . .	0.0495	0.0561	0.0511	0.0718	0.0655	0.0805	0.0576	0.0365
<i>Theoretical Values.</i>								
CO <sub>2</sub> calc. from dry wt.	0.0528	0.0576	0.0493	0.0787	0.0739	0.0889	0.0559	0.0404
CO <sub>2</sub> calc. from wet wt.				0.0788		0.1232		

*Conclusions.*—The quantitative results show that in presence of formaldehyde vapour the carbon dioxide evolved during respiration is exactly the same in amount as in normal respiration. Hence formaldehyde is not converted by the plant into carbon dioxide, nor can it be utilized for the synthesis of food materials in the dark, for any gain in weight on either of

these two accounts would alter the proportion obtaining between the loss in dry weight of the plant and the amount of carbon dioxide evolved.

This result is the reverse of that obtained from a consideration of the former results (with aniline as absorbent for formaldehyde, see p. 435), which were comparative but not strictly quantitative. This illustrates the great danger in drawing definite conclusions from purely comparative data.

#### *Theoretical Deductions from Results.*

This leads to the conclusion that formaldehyde, as it can be assimilated to some extent by plants in light (p. 422), is probably a step in photosynthesis, but that the further steps in this process also require light energy. In this case, the next step after formaldehyde must be a substance still more unstable than formaldehyde itself. Recent work on this subject, e. g. Usher and Priestley's<sup>1</sup> investigations on the extra-cellular production of formaldehyde from carbon dioxide in light, as well as the theories of Baeyer, Erlenmeyer, and Bach, are only concerned with the first step in photosynthesis, the assumption being that the subsequent processes—carried out, according to Usher and Priestley's work,<sup>1</sup> by the protoplasm—consist merely in the polymerization of formaldehyde. The electrical theory of photosynthesis, announced by J. Harvey Gibson,<sup>2</sup> also only accounts for the production of formaldehyde from carbon dioxide. The experiments which have been described seem to indicate that, if formaldehyde is part of the natural scheme of photosynthesis, the subsequent processes are much more complex than has often been supposed. It should, however, be noticed that such an authority as Meldola<sup>3</sup> seems to lean to the less simple explanations of the phenomenon.

Various suggestions have been brought forward at different times as to the nature of the substances formed from formaldehyde in photosynthesis. Fischer<sup>4</sup> suggested glycerose, and Piloty<sup>5</sup> glyceric aldehyde with dihydroxy-acetone, as steps in building up the hexose molecule. These substances have not been found in plants, nor would the processes require light energy.

In my opinion the most plausible suggestion is that due to Collie,<sup>6</sup> that keten, or some similar compound, is the first step in the process, after the production of formaldehyde. This substance keten, whose formula is  $\text{CH}_2$ ,



is the first member of the extraordinarily reactive series of compounds, of the same general formula, known as polyketides. From substances of this

<sup>1</sup> Usher and Priestly: Proc. Roy. Soc., lxxxiv, B, p. 101.

<sup>2</sup> Gibson: Ann. of Bot., 1908, xxii, p. 117.

<sup>3</sup> Meldola: Trans. Chem. Soc., lxxxix, p. 749 et seq.

<sup>4</sup> Fischer: Ber. d. Deutsch. Chem. Ges., 1890, xxiii, 2138.

<sup>5</sup> Piloty: Ber. d. Deutsch. Chem. Ges., xxx, 3166.

<sup>6</sup> Collie: Trans. Chem. Soc., 1907, xci, 1806.



series, Collie and others.<sup>1</sup> have been able to produce representatives of almost all the groupings present in plants and animals (including many nitrogen compounds), by means of such reactions as hydrolysis, in ammoniacal or faintly alkaline solutions, at ordinary temperatures. This suggestion practically combines the formaldehyde hypothesis with the ingenious and suggestive multiple-photosynthesis hypothesis,<sup>2</sup> and it has moreover much chemical evidence to support it. The formation of the exceedingly unstable  $\text{CH}_2=\text{CO}$  molecule from formaldehyde would probably be endothermic, and so require light energy.

The action of certain of these polyketides on plants is at present under investigation, but it would be useless to go into a further discussion of this theory until more experimental data are available.

#### SUMMARY.

Experiments have been described in which seeds were grown in an atmosphere containing known quantities of formaldehyde vapour in light and darkness. A comparison of the change in dry weight with that of control cultures with and without carbon dioxide revealed the fact that formaldehyde could be used for the synthesis of food materials to some extent in the light. The gain in dry weight produced was about half the loss due to respiration, and an increase in the percentage of formaldehyde in the air did not produce a corresponding increase in dry weight after a certain concentration. An excess of formaldehyde was toxic.

In the dark formaldehyde was not assimilated, but seemed to stimulate respiration. Its poisonous effect was more marked than in light.

Experiments with acetic aldehyde showed that formaldehyde was not assimilated in light merely by virtue of the aldehyde group; for acetic aldehyde could not be taken up by the plants.

The results were capable of two interpretations: either formaldehyde is a step in respiration, and converted by the plant into carbon dioxide before it can be assimilated; or it is the first step in photosynthesis, and its further elaboration by the tissues requires light energy.

In order to decide between these two possibilities, quantitative experiments were made in which the change in dry weight of the cultures could be directly compared with the carbon dioxide evolved during respiration. It was found that this ratio agreed closely with that calculated for the complete oxidation of a carbohydrate. When formaldehyde was passed over the cultures in the dark, there was no change in the quantitative relations between the loss in dry weight of the cultures and the carbon dioxide of respiration. Hence formaldehyde was not converted into carbon dioxide by the plants, nor used as a source of food materials in the dark.

<sup>1</sup> Cf. chapter on Polyketides in Stewart: *Recent Advances in Organic Chemistry*, London, 1908, p. 44.

<sup>2</sup> Brunner and Chouard: *Ber. d. Deut. Chem. Ges.*, 1886, xix, p. 595.

Probably, therefore, formaldehyde may function as a stage in photosynthesis; but the production from it of sugars and other food materials requires light energy. This is in contradiction to most chemical theories on the subject; but the results tend to confirm such a hypothesis as that of Collie, which postulates the production from formaldehyde of a still more unstable substance, keten ( $\text{CH}_2=\text{CO}$ ), before it is further elaborated into food materials.

In conclusion, I have to acknowledge my obligation to Mr. T. G. Hill, whose advice and criticism have been of the utmost assistance throughout the investigation.

---

### EXPLANATION OF PLATES XXX AND XXXI.

Illustrating Miss Baker's paper on the Effect of Formaldehyde on Living Plants.

A. Plants grown under formaldehyde in light, Expt. II. Source of formaldehyde: solid paraform at room temperature. Centre:  $\text{Air}-\text{CO}_2+\text{CH}_2\text{O}$ . Right hand:  $\text{Air}-\text{CO}_2$ . Left hand:  $\text{Air}+\text{CO}_2$ .

B. Plants grown under formaldehyde in light, Expt. V. Source of formaldehyde: formalin at  $50^\circ$ . Centre:  $\text{Air}-\text{CO}_2+\text{CH}_2\text{O}$ . Left hand:  $\text{Air}-\text{CO}_2$ . Right hand:  $\text{Air}+\text{CO}_2$ .

C. Plants grown under formaldehyde in darkness, Expt. VI. Source of formaldehyde: Formalin at room temperature. Centre:  $\text{Air}-\text{CO}_2+\text{CH}_2\text{O}$  dark. Left hand:  $\text{Air}+\text{CO}_2$  dark. Right hand:  $\text{Air}+\text{CO}_2$  light.

D. Plants grown for fourteen days in light without  $\text{CO}_2$  and then transferred to dark room and grown 14 days with formaldehyde, Expt. VII. Source of formaldehyde: Formalin at room temperature. Centre:  $\text{Air}-\text{CO}_2+\text{CH}_2\text{O}$  dark. Left hand:  $\text{Air}+\text{CO}_2$  dark. Right hand:  $\text{Air}+\text{CO}_2$  light.

---

### APPENDIX.

In the course of the above investigation a few experiments were tried with other organic vapours, not aldehydes. The results obtained were all negative; but, as they may serve to indicate the applicability of the method, they are appended here.

The apparatus and experimental details were the same as those described for formaldehyde (pp. 413-18).

#### EXPERIMENTS ON THE QUANTITATIVE EFFECT OF CARBON DISULPHIDE AND ACETYLENE ON MUSTARD AND CRESS PLANTS IN LIGHT.

##### 1. Effect of Acetylene in the Air-current.

The acetylene was produced by bubbling the air through pure water at known temperature, and then passing the saturated air over calcium carbide. A quantity of acetylene was produced equivalent to the amount of water vapour in saturated air at the temperature.

*Amount of Acetylene in the Air.*

Temperature of water varied from 1° to 9°.

Partial pressure of water = from 4.9 mm. to 8.6 mm. = p. press. C<sub>2</sub>H<sub>2</sub>.

From this it can at once be calculated by simple proportion that at ordinary atmospheric pressure of 760 mm. the partial pressure of acetylene is 0.64% to 1.13% of the total atmospheric pressure.

*Results.—Effect of C<sub>2</sub>H<sub>2</sub> in Light.*

Plant used: Cress (*Lepidium sativum*).

Several unsuccessful experiments were devoted to working out the general method, from March to June, 1910.

Final Experiment, June, 1910:

<i>Atmosphere.</i>	<i>Orig. dry weight.</i>	<i>Final dry weight.</i>	<i>Final/orig. weight.</i>
Air - CO <sub>2</sub> + C <sub>2</sub> H <sub>2</sub>	0.2015 gm.	0.1002 gm.	49.7 %
Air - CO <sub>2</sub>	0.2010 "	0.1387 "	60.0 %
Air + CO <sub>2</sub>	0.1996 "	0.2520 "	158.0 %

*Notes on the Morphology of the Cultures.*

The effect of acetylene on the plants was to render them rather stout in appearance, about half their normal height, and non-heliotropic.

*Conclusions.*—Even from this one result it is immediately obvious that there is no assimilation of acetylene. The loss in weight, in excess of the culture without carbon dioxide, is interesting as indicating that the gas stimulated the respiratory activities of the plants.

**2. Effect of Carbon Disulphide in the Air-current.**

*Amount of Carbon Disulphide introduced into the Air.*

Determined in a separate experiment by weighing the diffusion bulb before and after the passage of a known volume of dry air.

*Values:*

<i>Dimensions of Capillary.</i>		<i>Properties of Air.</i>			<i>Time t</i>	<i>Weight given off</i>	
<i>Length.</i>	<i>Bore.</i>	<i>Vol. litres.</i>	<i>Press. mm.</i>	<i>Temp.</i>	<i>in hours.</i>	<i>in t hours.</i>	<i>in 1 hour.</i>
4 cm.	0.5 mm.	28.31	760	14°	6.0	0.0045	0.00075
4 cm.	0.5 mm.	14.26	767	13°	2.5	0.0029	0.00125
10 cm.	0.5 mm.	3.54	not obs.	16°	1.125	0.0002	0.00018

As 1 litre of air weighs about 1.32 gm., the mean per cent. by weight of carbon disulphide in the air is about:

With 4 cm. capillary	.	.	0.00135
„ 10 cm.	„	.	0.00042.

*Experiments with Carbon Disulphide in Light.*

EXPERIMENT I. February–March, 1911. Plants used: Cress.

Length of capillary in diffusion bulb, 10 cm.

Temperature ranged from 10° to 18°.

<i>Atmosphere.</i>	<i>Orig. dry weight.</i>	<i>Final dry weight.</i>	<i>Final/orig. weight.</i>
Air + CS <sub>2</sub> - CO <sub>2</sub>	0·1982 gm.	0·1145 gm.	57·8 %
Air - CO <sub>2</sub>	0·1972 "	0·1105 "	56·0 %
Air + CO <sub>2</sub>	0·1977 "	0·1180 "	59·7 %

*Notes.*—As the weather was dull and cold throughout, none of the plants were very vigorous.

EXPERIMENT II. March–April, 1911. Plants used: Cress.

Length of capillary in diffusion bulb, 4 cm.

Temperature ranged from 9·5° to 18°.

<i>Atmosphere.</i>	<i>Orig. dry weight.</i>	<i>Final dry weight.</i>	<i>Final/orig. weight</i>
Air + CS <sub>2</sub> - CO <sub>2</sub>	0·2005 gm.	0·1255 gm.	62·6 %
Air - CO <sub>2</sub>	0·2015 "	0·1385 "	69·2 %
Air + CO <sub>2</sub>	0·2000 "	0·1575 "	78·8 %

*Notes.*—Plants under this concentration of carbon disulphide showed signs of poisoning. The chief symptoms were an entire absence of heliotropism and geotropism, and a curled appearance. Besides this, there was often a reversal of the usual sequence in the emergence of root and shoot from the seed, and in many cases the cotyledons were bright orange in colour.

EXPERIMENT III. April–May, 1911. Plants used: White Mustard (*Brassica alba*, Boiss.).

Length of capillary in diffusion bulb, 10 cm.

Temperature ranged from 11° to 27°.

<i>Atmosphere.</i>	<i>Orig. dry weight.</i>	<i>Final dry weight.</i>	<i>Final/orig. weight.</i>
Air - CO <sub>2</sub> + CS <sub>2</sub>	0·3990 gm.	0·2455 gm.	61·5 %
Air - CO <sub>2</sub>	0·3995 "	0·2525 "	63·2 %
Air + CO <sub>2</sub>	0·3990 "	0·3400 "	85·4 %

*Notes.*—Both cultures without CO<sub>2</sub> were beginning to shrivel, when the experiment was stopped; the other was vigorous and showing second leaves.

*Conclusions.*—As in the experiments with acetylene, there is no assimilation with carbon disulphide. The slight apparent increase in the first experiment was due, no doubt, to some irregularity in the lighting. It was also performed at an unfavourable time of year. Again, in this case the vapour has the effect of increasing respiration, though not to the same extent as acetylene, a fact which has been observed before by other methods.<sup>1</sup>

<sup>1</sup> Cf. H. E. and E. F. Armstrong: Proc. Roy. Soc., 1910, lxxxii, B, p. 588.



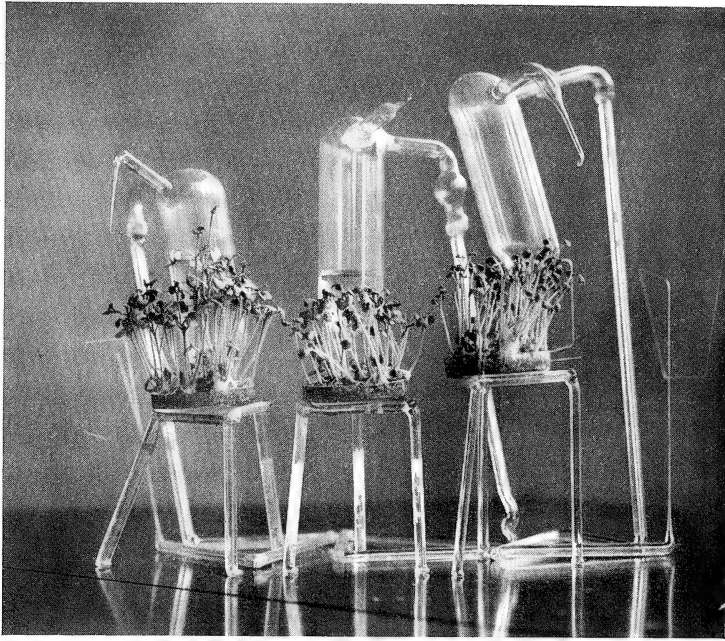

A

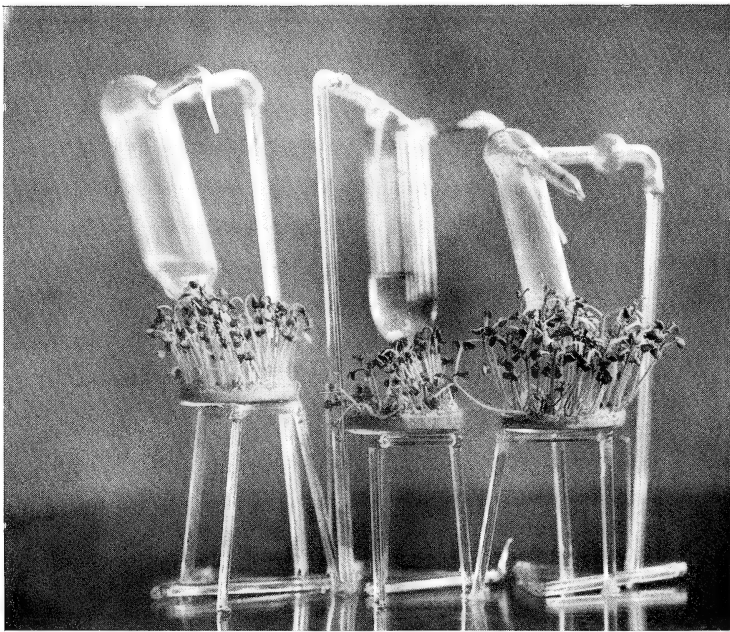

B

BAKER—FORMALDEHYDE

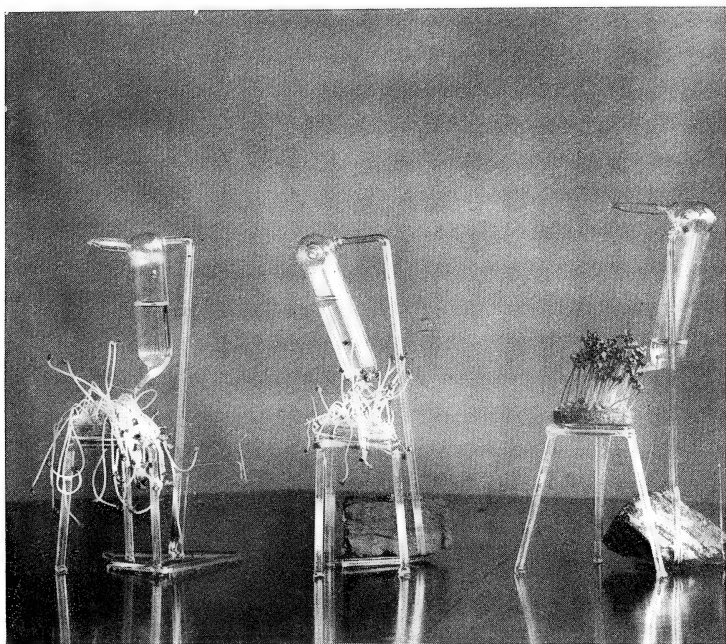

C



D

BAKER—FORMALDEHYDE





## Studies in the Phylogeny of the Filicales.

### III. On *Metaxya* and certain other relatively primitive Ferns.

BY

F. O. BOWER, Sc.D., F.R.S.

*Regius Professor of Botany in the University of Glasgow.*

With Plates XXXII-XXXIV and two Figures in the Text.

IN dealing phyletically with any large group of organisms, it is essential to strike a balance between relatively constant and relatively variable characters. The greater the constancy of a character the greater its value for the purpose of arrangement of the organisms in question, according to their natural relation by descent. The less constant features will take a subordinate place according to the degree of their fluctuation. This is the general principle which should underlie any natural system of classification.

In the case of the Filicales this simple and fundamental principle has often been neglected, and the remark applies not only to the characters used in the older systems, such as the sporangium and the sorus, but also to those newer characters in Ferns, which are beginning to derive an added clearness from the intensive study of their morphology and anatomy from a general and comparative point of view. In treating here of *Metaxya*, and certain other relatively primitive Ferns, the attempt will be made to assess at their proper value for phyletic purposes some of these characters; and in particular to see whether the position which the sorus holds relative to the margin of the sporophyll is not a more reliable feature, in Ferns at large, than it has commonly been held to be. Certain facts which bear upon this question will be described first, and a discussion will follow on their use in the phyletic grouping of the Filicales.

METAXYA, PRESL, TENT. PTERID., 1836.

The genus *Metaxya*, the name of which was intended to imply an intermediate position, was constituted by Presl to receive one species. It was designated by him *Metaxya rostrata*, but it is now currently named *Alsophila blechnoides*, (Rich.) Hk. (see Christensen's 'Index Filicum', p. 40). This Fern has suffered vicissitudes of terminology, a fact which at once

shows that cross relations exist, and suggests that it may be a synthetic type. It had been variously ascribed to *Polypodium*, *Aspidium*, *Alsophila*, and *Amphidesmium* before Presl placed it in a substantive genus by itself. Sir William Hooker introduced it as a substantive genus into his 'Genera Filicum', and figured it on his Plate XLII, B. It is noted as a very handsome genus of South American Ferns, allied in habit to *Trichopteris*. But in his 'Species Filicum' (vol. i, p. 35) he places *Metaxya* as a sub-genus of *Alsophila*; while later, in the 'Synopsis Filicum', it is no longer distinguished as a sub-genus, but is merged into *Alsophila*, appearing as its first species. Sir William Hooker thus took three successive steps in his treatment of the Fern. First, he accepted it as a valid genus (Gen. Fil.), then he reduced it to a sub-genus (Sp. Fil.), and finally he merged it in *Alsophila* (Syn. Fil.). Diels (Engler u. Prantl, i. 4, p. 132) adopts the middle position of Hooker. Christ ('Farnkräuter,' p. 324) places it also as the first species of *Alsophila*, under the sub-genus *Amphidesmium*, Shott. A more divergent position is, however, taken by Grisebach ('Flora of the British W. Indian Islands,' p. 697), who places it in *Polypodium* § *Phegopteris*. It will be shown that a more exact examination of its details will tend to support the original position of Presl, and to uphold *Metaxya* as a genus distinct from *Alsophila*, and occupying an interesting position phyletically, which well justifies his old name for it.

The single species, *Metaxya rostrata*, is an inhabitant of Tropical America, and is well represented in herbaria. From inspection of dry specimens few would doubt that it is correctly given a place in relation to the Cyatheaceae, and especially with *Alsophila*. But to form an opinion on its true phyletic relation to these Ferns and others, it is desirable to make a revision of its details, anatomical and developmental, for which material properly preserved is necessary. This was kindly supplied by Mr. Stockdale, from British Guiana, and to him my best thanks are accordingly due.

It is a large handsome Fern, with creeping rhizome and leaves a metre long. These are borne in close succession, so that they may sometimes form a sort of terminal crown. The leaves are singly pinnate, with a hard smooth, dark-coloured rachis, while the numerous large pinnae are lanceolate, and slightly serrate at the tip; but lower down the margin is entire. The veins run parallel outwards from the thickened midrib, and are only occasionally forked. The internodes of the creeping axis vary in length. Branches are from time to time formed in relation to the leaf-bases. The bud appears on the abaxial side, and in the median plane of the leaf. In fact their position relative to the leaf is the same as in *Lophosoria*. Further, the pith of the bud (which as will be seen later is solenostelic) is continuous here also with that of the axis; that is, the solenostele inserts itself without closing upon the abaxial side of the undivided leaf-trace, as in *Lophosoria*.

At a short distance out from the midrib are the sori, and as one is

frequently formed on each vein, they form an irregular line on each side of it. But, not uncommonly, two sori, or even more than two, may be borne on each vein, a feature which is specially noted by Presl as characteristic (l. c., p. 59). The sori project convexly from the lower surface of the leaf, and are slightly oval in outline, while numerous hairs project beyond the level of the densely grouped sporangia. A very good Habit-figure of the pinnae and sorus is given in Hooker's 'Genera Filicum', Tab. XLII, B.

The leaf is, apart from the sorus, destitute of hairs when mature. But the rhizome is permanently covered by a dense felt of brownish colour. The individual hairs are unbranched, and bear no terminal gland. They resemble, in fact, the unbranched hairs in *Lophosoria*. There is, however, no representative of the larger branched hairs, each borne upon an emergence, which are so marked a feature in that Fern, and are believed to prefigure the scales which are so prevalent in the Cyatheaaceae. These, as well as scales, seem to be wanting in *Metaxya*.

It was chiefly the description of its anatomy, given by H. Karsten in his 'Vegetationsorgane der Palmen' (p. 125, and Pl. IX, Figs. 1-4), which led me to examine *Lophosoria quadripinnata*, (Gmel.)<sup>1</sup> In referring to this work, and to Mettenius's memoir on *Angiopteris*, de Bary ('Comp. Anat.,' Engl. Edn., p. 286) persistently placed *Alsophila blechnoides* (= *Metaxya rostrata*, Presl) in juxtaposition with *Lophosoria*. Naturally curiosity was awakened to see what the structure of *Metaxya* really is, and this led to an inquiry for supplies from Mr. Stockdale.

Transverse sections of an internode of the rhizome show a complete solenostele, slightly oval in outline, as is the section itself. The structure is essentially the same as that of the horizontal runner of *Lophosoria*, except that the sclerenchymatous thickening of the walls of the ground tissue is in the old stock spread generally, instead of being restricted to definite bands, and that the solenostele, and especially the xylem of it, is rather thinner (Fig. 1). A section, transversely through the petiole, discloses an uninterrupted leaf-trace, with the meristele crinkled, and the margins turned sharply inwards (Fig. 2). In the mature petiole the ground tissue becomes very hard and sclerotic. The vascular supply of the pinna comes off from the elbow of the petiolar strand, just as in *Lophosoria* (see Part II of these Studies; 'Ann. of Bot.,' vol. xxvi, 1912, Pl. XXXV, Fig. 14). But whereas in the large leaves of the latter Fern the petiolar meristele was apt to be divided into separate strands (l. c., Pl. XXXIV, Fig. 9), in *Metaxya* this has never been observed.

<sup>1</sup> I wish here to acknowledge the friendly protest of Dr. Carl Christensen against my use of the specific name *Lophosoria pruinata*, Presl. He writes in a letter to me thus: 'The species was described by Swartz as *Polypodium glaucum*. This name being invalidated by the earlier *P. glaucum*, Thbg., Gmelin renamed it *P. quadripinnatum*. Unaware of this new name Swartz himself renamed his species *P. pruinatum*. It seems to me that Gmelin's name must stand.' To this opinion I naturally assent.—F. O.

The series of drawings, shown in Fig. 3, I-VI illustrate the general structure of the rhizome of *Metaxya* at the departure of a leaf-trace, and of its attendant abaxial bud. The series reads from the apex downwards, and the orientation is as in the creeping rhizome. Fig. 3, I, shows the leaf-trace in the petiolar base, approaching the foliar gap, while several roots are there seen traversing the cortex. In II a junction has been made near to, but not exactly at the lower margin of the leaf-gap, while it is seen that the incurved margin of the leaf-trace does not itself form the junction. In III, however, the flanges which projected inwards at the point of first junction have smoothed down, and slightly lower the opposite margin of the meristele joins the upper margin of the foliar gap. The section shown in IV traversed the bud which, as has been mentioned above, is frequently present on the abaxial side of the leaf-base. Its vascular supply, which is from the first solenostelic, arises, as in *Lophosoria*, as a diverticulum of the foliar trace, and the consequence is that the pith of the main axis is continuous with that of the runner. This is shown also in V, which is added as supplying a fact which is unusual in the more primitive solenostelic Ferns, viz. the interruption of the solenostele by a perforation which is not a foliar gap. It is, in fact, similar in nature to those 'perforations' which are found in the more advanced types. This will be returned to later, as a fact of theoretical interest. Finally, as seen in VI, the irregularities caused by the insertion of the leaf and the runner being past, the regular solenostelic structure is resumed, and is interrupted only by the origin of the vascular supply to the roots. This comes off usually on the lower side of the creeping rhizome.

Passing to details, the meristele in the petiole is defined by a well-marked endodermis, followed by a pericycle of one or two layers. The 'divergents' correspond to the convexities of the crinkled trace, and number from twenty to thirty in a full-sized trace. The protoxylem is not always clearly defined, while the tracheides often form only a single row. In the solenostele of the axis, which is delimited as before, the phloem is not profuse in quantity. The xylem-ring may consist of only three layers of tracheides, but in large rhizomes it usually comprises eight or more. There is no clearly defined protoxylem in the axis, and parenchyma cells are scattered through its xylem.

The sori of *Metaxya* have never been examined with the attention they deserve, considering how divergent are the vegetative characters of this Fern from those of the genus with which it has usually been placed. In point of fact the analysis of Sir William Hooker, published in 1838, still remains the best hitherto given. Examining the mature sorus from above, it will be found that the number of sporangia is far in excess of that in *Lophosoria*, or of any species of *Gleichenia*, while its form is that of a flattened oval mass, of rather large area (Fig. 4). Countings of the number of

sporangia in a single sorus gave as results figures falling between fifty and hundred, while those of *Lophosoria*, or *Gleichenia*, vary from about sixteen downwards. Further, it will be seen that the orientation, as shown by the position of the annulus, is not uniform in the mature state, while the hairs which accompany the sporangia, being longer than they, are a prominent feature, as they are also in certain species of *Alsophila*, which were associated by Presl in his genus *Trichopteris*.

The sori originate as solid projections from the lower surface of the leaf, opposite a nascent vein (Fig. 5). The receptacle thus formed is massive, and, as seen in a section cut transversely to the vein, it is at first essentially like that of *Lophosoria*. It soon produces simple hairs and sporangia. The former are distributed generally over the surface of the receptacle, but are more numerous round the periphery; the sporangia are borne on the flattened apex, and as many as six or seven may be seen in a single transverse section, as against three in *Lophosoria*. The sporangia of a single sorus appear all of the same age; thus *Metaxya* is, like *Lophosoria*, technically a type of the Simplices, not of the Gradatae, like the other Cyatheoids with which it has habitually been ranked.

If vertical sections be cut so as to follow the course of the veins of the pinna, the sorus presents a very different appearance from anything seen in *Lophosoria*, or in any species of *Gleichenia*. The receptacle follows the course of the vein for some considerable distance. In the case shown in Fig. 6, its length is fully twice the width shown in Fig. 5. The sorus is in fact oval, while those of *Lophosoria* and of *Gleichenia* are circular. As before, hairs and sporangia, all of approximately the same age, are seen arising from the upper surface. Fig. 7 shows a more advanced sorus, cut transversely to the vein. The sporangia are further developed, but all still show approximately a like condition. Their segmentation is in all essentials the same as that in *Lophosoria*, though the type is less massive and the stalk thinner (cf. 'Ann. of Bot.,' 1912, Pl. XXXV). It will be seen also that the vascular tissue extends into the receptacle, but here it is by arching outwards of the rows of tracheides from the vein, rather than by extension of a definite strand of tracheides into the receptacle. Lastly, if a tangential section be cut so as to traverse the stalks of the sporangia and the hairs, their distribution and structure are shown in Fig. 8. It is thus seen how the numerous hairs form an adequate protection to the young sporangia. The sporangial stalks show uniformity of structure and of orientation. The number of cells in the transverse section is usually four, corresponding to the four rows of cells of which the short stalk is composed.

In form the mature sporangia have a rather elongated form of the head, surrounded by an almost vertical annulus (Fig. 9, I-V). A feature of special importance is that the annulus is interrupted at the stalk, so that not only does the sporangium differ from those of the Cyatheaceae by the

vertical position, but also by the interruption of the annulus. In form the sporangia are slightly flattened. In Fig. 9 I and III represent their flattened sides, with the cells of the annulus slightly collapsed on ripening; II and IV show them as seen on edge, and with the cells of the annulus fully convex. In Fig. 9, I, the face corresponding to the 'central' face of the Gleicheniaceus sporangium is shown. The annulus is definitely interrupted at the insertion of the stalk, and the cells on either side of the stalk are relatively thin-walled. On the side opposite the stomium the full induration begins at the third cell, and is continued for sixteen cells. Then follow two relatively thin-walled cells; next come the four cells of the stomium, encroaching in this view far over the face of the sporangium; and finally two thinner-walled cells follow, connecting up with the stalk. The whole series numbers twenty-seven cells. The tabular cells are in this case only seventeen in number.

Fig. 9, II, represents a similar sporangium seen on edge with the base of one of the hairs (*h*) attached to its stalk. The convexity of its sides is seen, while twelve cells of the annulus are visible. Of these the two lowest correspond to the two thinner-walled cells in Fig. 9, I. The third drawing (Fig. 9, III), which was made from a rather peculiar sporangium, represents the opposite face to that shown in Fig. 9, I, viz. that which corresponds to the 'peripheral' face in *Gleichenia*. It is, moreover, to be noted that the sporangium here represented was the 'looking-glass' image of that in Fig. 9, I, as regards the side on which the stomium occurs. The fact may be stated thus: that in these sporangia as viewed from the peripheral side the stomium may be either right or left; in Fig. 9, I, which is seen from the 'central' side, it is right; in Fig. 9, III, which is here seen from the 'peripheral' face, it is also to the right, which could only happen if they were 'looking-glass' images of one another. The peculiarity of the sporangium seen in Fig. 9, III, consists in the annulus being continuous across the insertion of the stalk, a condition not unique, but less common than the interrupted state; and the number of the cells of the annulus is here rather larger than in the previous case, viz. thirty. The stomium is as before, but it is seen that its four cells do not encroach upon the 'peripheral' face as they did upon the 'central' face of the sporangium in Fig. 9, I. It thus appears that the stomium is not laterally symmetrical. The number of tabular cells of the 'peripheral' face is here larger, viz. twenty-five.

The next drawing, Fig. 9, IV, shows an average sporangium on edge, presenting its stomium in surface view. The relation which this bears to the annulus and to the 'peripheral' face of the sporangium is the same as before seen in Fig. 9, I. The 'central' face, upon which the cells of the stomium encroach, is to the left, while the 'peripheral' is behind and to the right, owing to slight obliquity in position of the sporangium. Lastly, the stalk shows in Fig. 9, II, four cell-rows, and in Fig. 9, I and IV,

each three, but in Fig. 9, III, only two. These facts are consistent with the stalk being composed of four rows of cells, as will be seen to be the case from transverse sections.

These drawings give a comprehensive idea of the external characters of the sporangium of *Metaxya*. It should be compared with that of *Lophosoria*, since there is so obvious a similarity between these types of Ferns. By comparison with Pl. XXXV, 'Annals of Botany,' 1912, which illustrates *Lophosoria*, it will be seen that not only are the sporangia of *Metaxya* much smaller, but also more elongated, and composed of fewer cells. For instance, the cells of the complete annulus in Fig. 18 of *Lophosoria* total 39, those in Fig. 9, I, of *Metaxya* are only 27, and in Fig. 9, III, 25. Or again, the cells on the peripheral face of the sporangium of *Lophosoria* shown in Fig. 18 of Pl. XXXV (1912) number 60, but those in Fig. 9, I, of *Metaxya* are 17, or in Fig. 9, III, they are 25. The number of cell-rows composing the stalk is also smaller. Lastly, there is the very essential difference in the position and interruption of the annulus. This is in *Lophosoria* markedly oblique, and continuous; in *Metaxya* it is as a rule interrupted at the stalk, and shows only traces of the oblique position, being almost vertical. Moreover, the stomium is ill-defined in *Lophosoria*, but in *Metaxya* it appears of the well-defined type characteristic of so many of the advanced Leptosporangiate Ferns. The spore-output per sporangium appears to be the usual number of 64.

In writing some time ago on the sorus of *Gleichenia*, it was pointed out ('Ann. of Bot.,' xxvi, p. 275) that in *G. pectinata* the Gleicheniaceus type of sorus has reached the point of ineffectiveness in its increase in number of sporangia, since they are so closely packed that, being all of like age and dehiscing by a median slit, they cannot shed their spores when ripe. It was shown that there are four possible ways out of the difficulty, which may be adopted singly or in combination: (1) by increasing the length of the sporangial stalk, (2) by adopting a lateral dehiscence, (3) by extending the area of the sorus, or (4) by elongating the receptacle. *Gleichenia* adopted none of these, but other Ferns did, and have progressed as a consequence. *Metaxya* is one of them. Its receptacle has remained of about the same height as in *Gleichenia*, but its area is greatly enlarged, while the sporangia have lateral dehiscence, and are rather longer stalked. Thus a combination of three of the modifications above noted is to be found in the sori of *Metaxya*. The transverse dehiscence is shared by all the more advanced Leptosporangiate Ferns. The elongation of the stalk is here only relatively slight. It is the increase of the area of the receptacle which is the most marked feature, which in the absence of any elongation of the receptacle makes the large number of sporangia in the simple sorus of *Metaxya* a practical possibility. It is naturally to certain sections of the comprehensive genus *Polypodium* that we shall look for conditions which

parallel these : and in point of fact *Metaxya* was included in *Polypodium* by several of the early authors. But it is to be remembered that there the sorus is a mixed one, while here all the sporangia arise simultaneously. The further discussion of this point will be reserved for the concluding part of the memoir.

From the characters detailed above there is sufficient ground for upholding Presl's view that *Metaxya* should be regarded as a substantive genus. The characters which mark it off from *Alsophila*, the genus to which it had been attached by Sir William Hooker and others, are the creeping habit, the unbranched hairs and the absence of scales, the solenostelic structure of the axis without medullary strands, the undivided leaf-trace, and, most important of all, the characters of the sorus and sporangium ; these are the flattened and enlarged receptacle, the simultaneous origin of the sporangia, the almost vertical annulus, and its interruption at the insertion of the stalk. The Fern is technically one of the Simplices, for all its sporangia arise simultaneously, a character which it shares with *Lophosoria*. In fact, these two monotypic genera lie aloof from the Cyatheaceae, and show characters both anatomical and soral which are more primitive than theirs, while the fact that the dermal appendages in both are hairs, not scales, points to the same conclusion. On the other hand, the two genera are clearly allied to one another. This comes out not only in the characters named, but also in the peculiar relation of their runners to the leaves, and in the attachment of their vascular supply to that of the leaf. They differ, however, in their sori and sporangia ; for while *Lophosoria* has few large and stout sporangia with a complete oblique annulus, *Metaxya* has a very large number of smaller sporangia in each sorus, but the annulus is almost perfectly vertical, and is interrupted at the stalk. It has been shown in a previous memoir that *Lophosoria* possesses characters reminiscent of the *Mertensia* section of *Gleichenia*. *Metaxya* shares with both the creeping habit, solenostelic structure, and undivided leaf-trace, dermal hairs, and simple simultaneous sorus. But the divergence from that type is seen in *Lophosoria* in the upright habit and sometimes divided leaf-trace ; in *Metaxya* it appears in the soral characters rather than in habit or anatomy.

#### HEMITELIA SETOSA, (KLF.) METT.

Having thus seen two Ferns with undoubted Cyatheaceous affinity, both showing a solenostelic structure, and most markedly in axes with a prone habit, it became a question of interest whether any of the true Cyatheaceae show similar characters. Gwynne-Vaughan, in his second memoir on Solenostelic Ferns ('Ann. of Bot.,' xvii, p. 710), has pointed out how *Alsophila excelsa* in its sporeling stage actually passes through such a condition of solenostely in its upright axis, but rapidly becomes dictyostelic by overlapping of the leaf-gaps. It would seem probable that if any



true Cyatheoid Fern bore runners like those of *Lophosoria* or *Metaxya*, these would probably be solenostelic. The fact that they may be illustrated in the case of *Hemitelia setosa*. On a large plant of that species, in the Edinburgh Botanic Garden, there was borne an underground runner, which after a horizontal course turned above ground as an upright leafy shoot. I here acknowledge the kindness of the Director in having it cut off close to the main stock and sent to me. It was over  $1\frac{1}{2}$  inches in diameter, and very fleshy, though covered by an external band of brown sclerenchyma. But when cut in transverse section it showed an advanced type of Cyatheoid structure, with dictyostele showing commonly three leaf-gaps in one transverse section; there were also numerous strands forming a medullary system. Thus the thick runner carried no special interest, as bearing on the present question.

A second runner of smaller size was, however, found arising laterally from the larger runner, and presenting externally an appearance not unlike those of *Lophosoria*. This was cut into sections, and was found to be solenostelic (Fig. 10). It will be noted that in the central medulla two small strands are present, showing that even at an early stage in a small runner the medullary system may be constituted (*m.s.*). A special interest attaches to the vascular supply at the base of the small runner for comparison with that in *Lophosoria*. So transverse sections were cut to its extreme base, and it was found that the solenostele did not close at insertion on that of the main shoot, but remained an open ring with a massive cylinder of pith. This, in the case in point, was still traversed by the two small strands, which passed down through the open tube to connect with the medullary system of the main axis. Except for the existence of these medullary strands, the arrangement is essentially as in *Lophosoria*. But the presence of a medullary system may be held as a feature of advance, which has a parallel in other characters of *Hemitelia*, such as the greater disintegration of the leaf-trace, the presence of dermal scales, of a partial indusium, and a basipetal succession of the sporangia in the sorus, as against the more concrete leaf-trace, the absence of scales and of any indusium, and the simultaneous origin of the sporangia in *Lophosoria*. Thus, though *Hemitelia setosa* shows these characters of advance, it also shows the interesting primitive feature of solenostely in its small runner.

But this is not the first example of pronounced solenostely which has been described among Cyatheoid Ferns with a basipetal sorus. The old observations of Stenzel on *Alsophila aculeata*<sup>1</sup> show an example which corresponds very closely with those above described. From an old stock numerous runners arise, each related to a leaf-base as in *Lophosoria*; while their anatomy showed at least in their lower region an uninterrupted tube. These runners, as in *Lophosoria*, usually turned downwards at first, and

<sup>1</sup> Verhandl. d. K. Leop. Carol. Akad. d. Naturforscher, 1861, p. 16, Tab. I, II.

bore on their surface the bases of arrested leaves ; but some grew upwards at once. Anatomically they ultimately repeated the structure of the main axis. But at the extreme base Stenzel describes the stele as a simple strand ('einfacher Faden'), and he explains that only where the branch emerges from the cortex of the parent plant does the stele widen out, 'like a filter,' and then, growing on as a cylinder, forms the vascular tube of the branch. In this case the structure of the young runner appears to have been more rudimentary at first than that in *Lophosoria* or *Metaxya* ; it corresponds more nearly with that in *Cibotium Barometz*, to be described below ; but the contracted region of the stele is longer continued in the *Alsophila* than in that Fern. Doubtless there is considerable variation between species in this, which is a feature probably dependent in some degree upon the strength of development of the individual runner.

These facts from *Alsophila* and *Hemitelia* suggested a like inquiry for *Cyathea*, and naturally the soboliferous species *Cyathea mexicana*, Schlecht and Cham, was used, material being available from the Glasgow Garden. The buds are very numerous ; their position is sometimes below the leaf-base, as in *Lophosoria* ; sometimes more than one may be found there. Transverse sections of the upper part of one of these shoots show the ordinary Cyatheaceous structure. Towards the base it closes into a solenostele which narrows basally, but in the material examined it was not found to contract to the *Lindsaya* condition. It is thus seen that all the genera of Cyatheae may form runners, as a rule on the abaxial side of the leaf-base ; and in all of them the basal region shows a simpler vascular arrangement than the mature Cyatheaceous structure. In all of them the solenostelic type is present at least for a greater or less distance from the extreme base.

In *Lophosoria* and *Metaxya* we see two genera naturally related to the Cyatheae, with which they have always been classified. But they differ from them (i) in their habit, which in *Metaxya* is permanently trailing, in *Lophosoria* it is temporarily so in the runners ; (ii) in their pronounced solenostely ; (iii) in their undivided, or in *Lophosoria* only slightly divided, leaf-trace ; (iv) in their dermal appendages being hairs, not scales ; (v) in the simple character of the sorus ; (vi) in the details of their sporangia. All these characters indicate for them a relatively primitive position at the base of the Cyatheoid series, while they link it to the Gleicheniaceae. It was concluded in a previous memoir ('Ann. of Bot.,' xxvi, p. 269) from comparisons of *Lophosoria* on the one hand with the Gleicheniaceae, and on the other with the Cyatheae, that the creeping habit was relatively primitive, and that the upright axis of the Cyatheaceous Tree-ferns was a secondary derivative from it. This conclusion is very greatly strengthened by the additional facts from *Metaxya*. For this Fern shows dorsiventrality more fully and permanently than *Lophosoria*, and with it the solenostelic struc-

ture ; and this goes along with other primitive characters named. We may now therefore conclude more confidently than before that in the Cyatheaes the dendroid type is secondary and derivative.

#### DICKSONIEAE.

But there is the other family of dendroid Ferns to be considered, viz. the Dicksonieae. They are clearly marked off from the Cyatheaes by the position of their sori. While these in the Cyatheaes are constantly superficial in origin, as in the Gleicheniaceae, the Dicksonieae have their sori as constantly marginal in origin, corresponding in this feature to the Schizaeaceae. Prantl has demonstrated the marginal origin of the sporangia in the various genera of the Schizaeaceae in his great monograph on the family ('Schizaeaceen,' pp. 39-45). But the detailed evidence has never been fully given for the Dicksonieae, so as to relate the origin of the receptacle of the sorus, or the sporangia themselves, distinctly to the marginal series of cells of the developing leaf. It has been stated by Burck ('Indusium der Varens,' p. 43) and by Glück ('Die Sporophyll-Metamorphose,' Flora, 1895, p. 19) that it is so ; but the mere statement that it is so, without the recognition of the segmentation which leads to it, amounts to nothing more than a bare assertion. On the other hand, the present Fig. 11 of *Dicksonia Scheidei* demonstrates the segmentation of the leaf-margin, and how while the lower and upper indusium flaps arise as upgrowths from the surfaces of the leaf, the receptacle originates from the marginal cell itself of the section. It will be shown below that the same holds also for various members of the Dicksonieae and other related Ferns. We may provisionally accept the essential distinctness of the Cyatheaes from the Dicksonieae, as based upon this constant difference of origin of their sori. The question will now be taken up of the habit and structure of the Dicksonieae for comparison with what has been seen in the Cyatheaes.

Gwynne-Vaughan, in his papers on Solenostelic Ferns ('Ann. of Bot.,' vol. xvii, p. 689, &c.), has dealt with various types which belong to the Dicksonieae, and in fact his best examples have come from that family, or its immediate derivatives. He has described for *Cibotium* (*Dicksonia*) *Barometz* how the stelar condition 'must be regarded as dictyostelic, although it is very near solenostely'. The overlapping of the leaf-gaps, which he noted, depends on the degree of elongation of the creeping axis ; where the internodes are relatively long the solenostelic state, without any medullary strands, is typically seen in the bulky axis. As he points out (l. c. p. 709), lateral shoots are formed 'at the back of the leaf-trace' ; in fact, they correspond in position to those of *Lophosoria*, or *Metaxya*. Thus *C. Barometz* may be held to have, as regards habit and vascular structure, a similar relation to the dendroid Dicksonieae to that which *Metaxya* bears to the dendroid Cyatheaes. The examination of its runner, or lateral

shoot, shows very similar results. Sections at various levels from its apex downwards are seen in Fig. 12, I–VI. The first (I) shows the young axis with a complete solenostele, and laterally the lowest leaf of the shoot is attached, with its leaf-trace divided into five strands. In II the solenostele has opened, and the leaf-trace, now reduced to four strands, is moving towards the leaf-gap, which it joins first by one margin (III), finally by both; but even after this is accomplished the divisions of the leaf-trace into separate strands may remain (IV). Later the ring is completed (V). Passing downwards the solenostele contracts, and the central pith is reduced until it finally disappears, together with the internal endodermis (VI). The central mass of soft tissue has the appearance of phloem, but isolated tracheides are not uncommon near its margin (Fig. 13). Towards the base of the shoot the soft tissue becomes still more reduced. In essentials this behaviour is as in *Metaxya* and *Lophosoria*, but at the base of the bud the stelar structure is of a more primitive type than in those Ferns.

A still more interesting type is seen in *Thyrsopteris elegans*, which has already been shown to have a truly marginal sorus, with the first sporangia springing from the very apex of it ('Land Flora,' p. 588, Fig. 329). As the vascular structure of *Cibotium* and *Dicksonia* is now fairly well known, it seemed desirable to obtain like facts for *Thyrsopteris* also, since that Fern has sori so like those of the Dicksonieae, though in some ways more primitive than they. The plant shows in less degree than *Dicksonia* the dendroid habit: it is in fact a stunted type of Tree-fern. The published descriptions of its habit are not very explicit. Kunze ('Die Farrenkräuter,' p. 3) says that 'the stem or root-stock is hitherto unknown'. Hooker ('Species Filicum,' i, p. 64) describes it as 'arborescent?', and quotes Kunze's remark that 'this Fern is said to have a caudex as thick as a walking-stick, whence it is supposed to be arborescent'. Diels, however ('Nat. Pflanzenfam.,' i. 4, pp. 122–3), describes the stem as attaining  $1\frac{1}{2}$  metres in height, but as thick as the thigh, and closely covered by the scars of old leaves. Christ ('Farnkräuter,' p. 331) quotes the same words, but adds that no trace of a creeping rhizome is present. There are now well-developed plants growing in Kew and in Edinburgh, and smaller specimens in other collections. In Glasgow we have some received by gift from the Edinburgh Botanic Garden, for which I record my thanks to the Director, others obtained by purchase.

The fact that a strong bud may come above ground at some distance from the parent plant, as seen at Kew and in Edinburgh, indicates the presence of a 'runner' like those of the Cyatheoids. One of the young plants given from the Edinburgh garden was shaken out from the soil, and showed a massive piece of axis, about 2 inches long, from which arose two long thin runners, with stunted leaves and long internodes. One of these had come above ground, and bore foliage leaves. The insertion of the runners

was essentially the same as in other cases, viz. on the back of the leaf-base. The material was thus at hand for anatomical observation. Externally, the surface was covered by dermal appendages. These were of two sorts: soft woolly, but unbranched hairs, and in less numbers long stiff dark-coloured bristles ('Borsten').

If a section be cut of the petiole of a small leaf, an undivided horse-shoe-shaped trace is seen, with incurved margins, and not very markedly crinkled. The xylem is more massive in the neighbourhood of the marginal crooks, but towards the median plane it thins out to a single layer of tracheides (Fig. 15, *c*). In a large leaf the trace may be separated into three portions (Fig. 14), having the same relative positions as those in *Lophosoria* (see 'Ann. of Bot.,' xxvi, p. 284). The trace is very much convoluted and crinkled and the number of the 'divergents' is very large, as many as eighty having been counted.

Where the axis is small, for instance about the base of a small runner, its vascular system may be a simple solenostele (Fig. 15, *a*). But where larger, a single strand, or sometimes more than one, may be found in the pith (Fig. 15, *b*). Tracing the origin of the medullary strand it is found that it separates at the opening of the leaf-gap preparatory to receiving the leaf-trace, as described by Gwynne-Vaughan for *Pteris elata*, or *Dennstaedtia rubiginosa* ('Ann. of Bot.,' xvii, Pl. XXXIII, Figs. 13, 14). It runs down the centre of the pith, and frequently ends blind where the runner is small; but in stronger axes it may connect up with that from the next lower leaf-gap, and constitute a continuous rod. In larger shoots the same method is found, but the medullary strands connect so as to form a considerable medullary system. This is illustrated by the series of sections shown in Text-fig. A, 1-8, which show transverse sections taken at short intervals from a thick stock, and arranged in succession from below upwards. In all of the sections it will be seen that the continuity of the solenostele as a ring is unbroken, even where a leaf-trace is being given off. This is a point of difference from what is seen in the young runner, where the ring opens on the giving off of a leaf-trace. This continuity is maintained in the old stem by a broad strap of vascular tissue—the compensation strand, or tongue of Tansley ('Ann. of Bot.,' xix, p. 507, &c.), which connects with the medullary system. It is in fact the correlative of the small strand already noticed in young runners (Fig. 15), and it arises like it from the anterior margin of the foliar gap. But notwithstanding the fact that the ring as seen in transverse section appears always as a complete one, there is still indirect communication between the outer parenchymatous system and the inner by a passage down the hollow of the gutter-shaped trace.

The sections may now be described in detail. In Text-fig. A 1, 2, 3 show the steps of separation of the leaf-trace (*a*), and in 4 the petiole itself has separated from the axis, leaving only a flattened side to the section.

In 1 the leaf-trace appears as a projecting thinner part of the solenostele showing already the crinkled outline characteristic of the leaf-trace. Opposite it is a broad vascular strap—the compensation tongue. Two other leaf-traces (*b, c*) are already indicated by thinner regions of the ring. The medullary system consists of several strands of various size, disposed roughly in a ring, two lying irregularly near to the centre. In Text-fig. A, 2, the compensation tongue has fused at its margins with the incurved sides of the foliar gap, while processes which will form the hooks of the leaf-trace point inwards into the space thus enclosed. The medullary strands are disposing themselves in a circle with a central strand. This arrangement becomes clearer in 3 and 4, which also show the final separation of

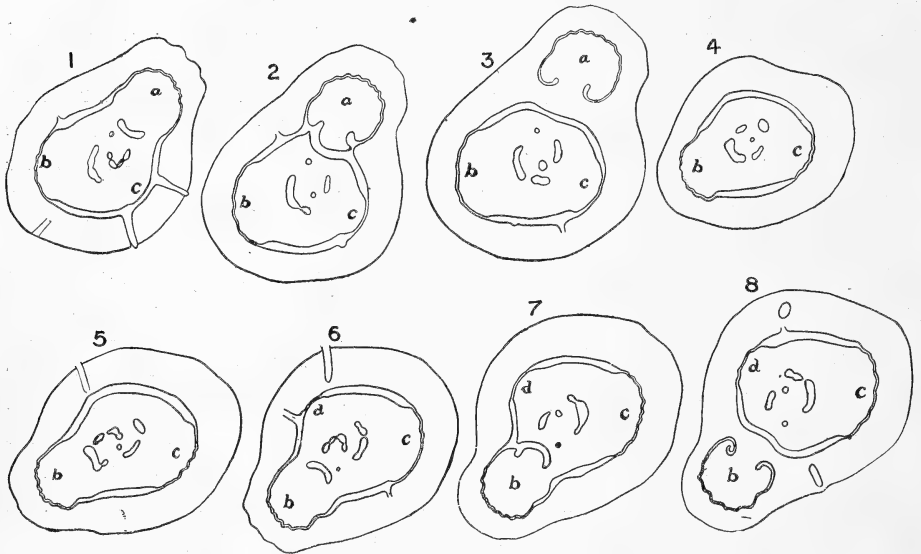

TEXT-FIG. A.

the leaf-trace (3), and of the petiole itself (4). Meanwhile, the traces *b* and *c* have become more definite, and in 5 the trace *b* appears as a thinner region strongly arching outwards. Opposite the gap thus forming, the broad compensation tongue already recognizable in 3 and 4 is moving outwards to the gap. In 6, 7, and 8 the stages already followed above for the trace *a* are repeated, with the same result. It is to be noted that already in 8 the compensation tongue for the leaf-gap *c* has been formed from the medullary system. From these drawings the plan of the vascular system of the shoot is sufficiently indicated. It is polycyclic, the outermost cycle being a closed solenostele: the middle cycle is somewhat irregular, but is fairly constant, with its connexion outwards at each leaf-gap with the solenostele. Centrally is a simple strand of rather irregular position, which appears to connect with the middle cycle

at or near to the exit of each leaf-trace. The stem of *Thyrsopteris* is said by Diels to attain the thickness of a man's thigh. In such stems it is probable that the vascular system may show greater complexity of polycyclic than is here described. But this has not yet been seen.

#### SACCOLOMA.

Of Ferns whose structure has hitherto been figured and described, the nearest correspondence to these details of *Thyrsopteris* is found in a stock examined by H. Karsten ('Vegetationsorgane der Palmen,' 1847, Pl. IX, Figs. 5 and 6), and described under the name of *Dicksonia Lindeni*. He speaks of the Fern as having an upright axis, while it had runners springing from the leaf-bases, and their vascular supply came off as a conical or cylindrical bulging of the vascular cylinder of the main shoot. This is as in *Lophosoria* and *Metaxya*, or in *Thyrsopteris* itself, while the habit appears to have been like that of *Thyrsopteris*, having like it runners which may rise upright when strong enough. He found the full-grown stem to be polycyclic. The outermost ring was a complete solenostele, as in *Thyrsopteris*, but in his Fig. 6 it is interrupted at one point close to the outgoing leaf-trace. A second ring lay within, more regular and connected than that seen in *Thyrsopteris*, and opposite an outgoing leaf-trace in Fig. 6 a compensation tongue is clearly shown.

The Fern named *Dicksonia Lindeni* by Karsten is now recognized as a variety of *Saccoloma domingense*, (Spr.) Prantl (see Prantl, 'Arb. K. Bot. Gart. zu Breslau,' 1893, p. 19; also Christensen, 'Index Filicum'). This suggests further comparison with the well-known drawings of Mettenius of *Saccoloma elegans*.<sup>1</sup> The details are slightly different, and the stock requires a full elucidation; but the main features appear to be the same. The further question, however, arises as to the sorus of *Saccoloma*. Is its receptacle, like those of *Dicksonia* and *Thyrsopteris*, of truly marginal origin? This point has been examined on material of *Saccoloma elegans* collected in Jamaica. Unfortunately, owing to the seasonal condition of the plant, it was not possible in August, 1909, to obtain all stages of the development, but enough was secured to show that the receptacle is of exact marginal origin.

This is shown by the Figs. 16, *a*, *b*. In the first of these (*a*) a leaf-margin is shown with regular segmentation and a marginal cell; it is, however, becoming rounded off prior to the formation of the sorus. Fig. 16, *b*, shows a more advanced state, in which the alternate segmentation is still readily recognized, and the marginal cell occupies a median position. But the development of the two sides has become unequal, and already the two lips of the indusium appear as swellings on either side of the slightly conical receptacle, the centre of which is occupied by the marginal cell itself. It

<sup>1</sup> Abhandl. a. d. K. Sächs. Ges. d. Wiss., vi (1863), p. 531, Pl. VI, Figs. 1-4. *S. elegans* is a synonym for *S. domingense*, Prantl.

will be noticed that of the two indusial lips that on the abaxial (lower) side at first develops the stronger, and the whole sorus comes to be tilted over to the adaxial side. The same is also the case, though in less degree, in *Dicksonia* (Fig. 11) and in *Odontosoria* (see below, Fig. 17). In later stages this inequality is made up, and even reversed, so that in the final state the sorus in all of these Ferns appears to be shifted distinctly to the lower side, while the upper flaps of the successive sori fuse laterally to form a continuous flange (compare Kunze, 'Farrenkräuter,' Taf. XLI, c). This is particularly well shown in Goebel's Fig. 10, 'Flora,' 1912, p. 47, and he describes the nature of the sorus of *Saccoloma* thus: 'That which has been described as the "scarcely modified leaf-margin" is composed of the contiguous outer flaps of a two-flapped indusium. These outer flaps are larger than the inner. Still one sees the several sori clearly limited by a seam-like swelling, so that there can be no doubt of the interpretation thus given,' &c. The facts of development above given fully demonstrate the correctness of this conclusion, while comparison of other species, as well as with species of *Davallia*, further strengthen the position. Still the sori themselves remain distinct, each with its own separate receptacle, and with the 'inner' or lower flap of the indusium separate also for each individual sorus.

Owing to the fact that my Jamaican material presented an incomplete series of stages for developmental study, a full account cannot be given at present for *Saccoloma*. But enough has been seen from rather advanced conditions of the sori to make it certain that a one-sided gradation of origin of the sporangia is present. The most advanced sporangia are those nearest to the lower or 'inner' flap of the indusium, while passing from these towards the upper or 'outer' flaps, which are fused as a false 'leaf-margin', a succession of younger sporangia is seen. The sorus has, in fact, undergone just such a modification as might have been anticipated in a type of marginal origin, with equal development on both sides, which had become phyletically shifted to the lower surface of the leaf, with consequent unequal development of its sides. Moreover the biological advantage of such protection is too obvious to need detailed explanation.

As regards the dermal appendages, broad brown scales are found in *Saccoloma elegans*, together with simple hairs. They all fall away, however, from the leaves at an early stage, and in the mature state the surfaces of the lamina and the petiole are quite bare. Thus as regards the anatomy *Saccoloma* appears to be closely linked with the relatively primitive *Thyrsopteris*, which had itself arrived at a condition advanced in anatomical complexity when compared with *Cibotium Barometz*. In point of dermal appendages it is advanced relatively to both of them; also in its partial merging of the sori, and in their one-sided, gradate sequence of sporangia. The sum of these characters will give it a higher phyletic position than the Dicksonieae, though the anatomy will leave little doubt of its natural affinity with this family.



## LINDSAYA. ODONTOSORIA.

The close relation of the individual sori of the marginal series in *Saccoloma* only involves their indusium, of which the 'upper' flap is merged into an apparent leaf-margin, though the 'lower' flaps of the individual sori remain separate. But in *Lindsaya* and some other Davallieae both flaps merge, while the receptacles also become continuous as a marginal, or apparently intramarginal, flange. The clear indication of what has occurred is found by comparison of individual cases where the fusion is incomplete. Some of these will be described below.

On the other hand, the vascular construction of the stem of *Lindsaya*, as described by Tansley ('Ann. of Bot.,' xvi, March, 1902), is of a type which may be held as more primitive than that of any solenostelic Fern. We see the stage of structure, which in *Lindsaya* is permanent, rapidly passed through in the runner of *Cibotium Barometz*, and it probably figures in the early development of many Ferns. In fact, the axis of *Lindsaya* appears to have retained permanently a condition which is only rudimentary and transitional elsewhere. Thus, anatomically, *Lindsaya* stands on a relatively low plane, though its soral condition is relatively advanced.

The developmental tendencies of the Davallieae, as they affect the sori, are towards their passage from the margin to the lower surface, and towards their fusion. These modifications, combined with some others, do not necessarily progress on parallel lines, with the result that there is some difficulty in the grouping of the different forms, and synonymy is profuse and confusing. The two plants on which observations have been made are *Odontosoria retusa*, (Cav.) J. Sm., and *Lindsaya lancea*, (L.) Bedd. The former was supplied from the Edinburgh Botanic Garden, the latter collected in Jamaica. The material of the latter was insufficient for a complete study of the development, but it sufficed to show that the condition is essentially similar to that seen in *Odontosoria*, which was more fully examined. As in *Saccoloma*, the first indication of the future sorus is a flattening of the margin on the young pinnule (Fig. 17, *a*). The construction of it has been by successive segments cut off from a marginal cell, which still retains its identity, but it lags behind the last segments in its activity of growth, so that these overtop it right and left (Fig. 17, *b*). That on the abaxial side takes the lead slightly over the other, so that the receptacle, in which the marginal cell is still visible, takes an oblique slope. This is maintained even in later stages, though, owing to stronger growth, the adaxial or 'upper' lip of the indusium soon overtops the abaxial or 'lower' (Fig. 18). The vascular tissues develop in the region below the receptacle, and as a vascular commissure there links the several veins together laterally, each vertical section shows a more or less prominent mass of tracheides spreading below the receptacular surface. On the latter the sporangia begin to

appear, and the largest constantly occupies a position which is at least near to, if not actually coincident with, the margin of the pinna. Other sporangia appear later in lateral positions, mostly on the adaxial side. Hairs are also formed in considerable numbers. A transverse section of a sorus at this stage is shown in Fig. 19, and from such a section it is clearly proved that the sorus, though continuous and marginal, is essentially a gradate one in its early stages. The oldest sporangia form a fairly regular series in a central position between the indusial lips, while those which follow are laterally placed. It will be noted that the early segmentation of the sporangia is such as to produce a fairly massive stalk, and resembles that of the Gradatae generally. A further point for note is the irregular lobing of the indusial lips (Fig. 18). The laciniae thus produced are chiefly upon the lower lip, and they are a more marked feature in *O. retusa* than in *L. lancea*. It is also seen that while the lips are only slightly unequal in *O. retusa*, and the sorus consequently appears terminal, they are much more unequal in *L. lancea* (Fig. 20); and the sorus is distinctly intramarginal (Fig. 21). The sporangia are closely packed between the lips in the latter Fern, and arise in the later stages of the sorus after the manner of the Mixtae. But the sequence is not long continued; in fact, neither *Odontosoria* nor *Lindsaya* appear to be at all pronounced cases of the mixed condition of the sorus.

It is thus seen that the sori of the Ferns above described are in an intermediate condition between the Gradate and the Mixed types. The receptacle, usually a projecting body in the Gradatae, has become flattened (Fig. 18), and the basipetal sequence, though it can be traced in the younger stages, is not strictly adhered to. This at once suggests the question whether the position of the annulus is oblique, as in the Gradatae, or vertical, as in the Mixtae. A similar question would apply to *Saccoloma*. Unfortunately, the Jamaican material did not suffice to decide the question for that Fern or for *Lindsaya lancea*, though in both cases evidence of an oblique position of the annulus was seen. But examination of the sporangia, both in *Odontosoria retusa*, (Cav.) J. Sm., and in *Lindsaya repens*, (Bory) Bedd.,<sup>1</sup> showed that in certain sporangia the annulus was clearly oblique, and the sequence of its cells was not interrupted at the insertion of the stalk. There is, however, some variety of detail in different sporangia. In Fig. 22 an example is shown of the sporangium of *Lindsaya repens*, in which, though the induration of the ring stops opposite the insertion of the stalk, still the sequence of cells is continued past it, so that a complete oblique ring is present, as in the Dicksonieae. A similar condition has been observed in *Odontosoria retusa*. Here again, though the induration ceases opposite to the stalk, the series of cells of the annulus is continued past it. This con-

<sup>1</sup> This plant is named in the Synopsis Filicum *Davallia (Odont.) repens*, Desv., and Hooker there notes that its place is 'quite doubtful between *Odontosoria* and *Lindsaya*'.

dition, which thus is seen in both species, is not uniform for either. Both are variable. It is, however, a condition which would naturally be anticipated in Ferns of Gradate origin, in which the receptacle was flattened and the sorus (with a tendency to becoming a mixed one) compressed laterally between the indusial lips. The sporangia, in such a case, would be forced to open upwards, and for this a vertical annulus would be the proper mechanism, while the induration of its basal region would be mechanically ineffective. Such conditions as those seen in the Ferns named give a strong support to the view that the *Lindsaya-Davallia* type has been derived from some Gradate, and probably from a Dicksonioid source.

#### DAVALLIA.

Having touched upon Ferns so nearly related to *Davallia* as those last mentioned, it is necessary briefly to allude to this genus. But it would be impossible in this memoir to do more than take a single sample of the species, and examine its sorus developmentally. A thorough comparative study of the sori of the genus is urgently wanted, which would probably lead to the recognition of many details conducive to a phyletic grouping of the Ferns of this affinity. This can only be suggested at present in the roughest outline. It is already known that the sori of certain *Davallias* show a mixed condition, but that in their earliest stages the first sporangia arise in a median position, which may be taken as a reminiscence of a basipetal sequence in their ancestry ('Phil. Trans.,' vol. cxcii, p. 76). This fact was seen in *D. Griffithiana*, which later shows very clearly a mixed condition (l. c., Figs. 134, 135). It must remain for further inquiry to show, for the various species, what balance there may be between the originally basipetal and the derivative mixed condition of the sorus in the genus at large.

But the question of present interest for us is the position of the sorus at its initiation: is it in the first instance marginal? This point has been examined in *D. pentaphylla*, Bl., a species in which, when mature, the sori are distinctly intramarginal, though not in so high a degree as in some species. Sections through very young sori prove that the origin of the sorus is nevertheless truly marginal, as in the related genera above described. Fig. 23 shows a very young state in *D. pentaphylla*, in which the receptacle lies between the two marginal flaps, and itself holds a marginal position. The two indusia differ, however, slightly from the first in bulk and in structure. That which is to be the lower (*l*) takes the precedence while young, but it is the less bulky, running out later into a single layer of cells (Fig. 24, *l*). The upper lip, which extends, as in *Lindsaya* and *Saccoloma*, as an apparent extension of the leaf-surface when mature, hangs back slightly at first (Fig. 24, *u*), but is more bulky, consisting throughout of several layers of cells. It shows at first a marginal segmentation, but this soon ceases, and the greater part of the mature flap, which then appears like

a continuation of the flattened pinna, consists of tissue produced by intercalary growth, signs of which are already seen in Fig. 24.

It may be a question what exact relation the two indusial flaps bear to the marginal segmentation of the pinna. Some sections give the appearance as though the succession of segmentation was continued directly into the marginal segmentation of the upper flap, a condition not improbable, seeing that it becomes ultimately so much the larger. The exact genetic relations in Fig. 23 seem uncertain on this point. But whatever these relations may actually be, there can be no reason to doubt the substantial correspondence of the receptacle and the two flaps with the correlative parts seen in *Lindsaya* and *Saccoloma*, and ultimately in *Dicksonia* and *Thyrsopteris*. It may, in fact, be considered as conclusive that the sorus in *Davallia* is of the marginal type.

Such questions in *Davallia* become more insistent in *Nephrolepis* and *Oleandra*, genera which have usually been classified with the *Davallias*, though their sori appear in the mature state to be much further intramarginal than they are in *Davallia*. The latter of these genera has not been examined developmentally. But in *Nephrolepis biserrata*, (Sw.) Schott, the matter has been investigated, though, owing to certain technical difficulties, the development has not been fully followed. Fig. 25 shows a comparatively early stage of the sorus, which clearly corresponds in essentials to that of *Davallia*, but the inequality of the two lips is here so strongly marked as to make it a still more open question whether or not the receptacle itself originated in a marginal position. It may be held that the lip (*l*), in Fig. 24, of *Davallia* is the phyletic counterpart of the body marked (*l*), in Fig. 25, of *Nephrolepis*, which is often described as the 'indusium'. The hollow behind it is the receptacle. The large body marked (*u*) in Fig. 25, which appears as a continuation of the leaf-surface, is the correlative of the upper lip (*u*) in the *Davallia*. The difference between the two sori appears to lie in the much greater inequality of development of the two sides in *Nephrolepis*, and especially in the very extended development of the upper lip (*u*). In the *Davallia* this soon loses its marginal segmentation, and its greater part results from intercalary activity. But in *Nephrolepis*, as is shown by Fig. 25, an active marginal segmentation appears to account for the predominance of the upper lip. It must remain for the present uncertain whether or not this activity was developmentally continuous with that at the margin of the pinna before the sorus appeared. If that were shown to have been the case, it would indicate that there had been a sort of 'phyletic slide' of the originally marginal sorus to the lower surface of the pinna. That such a transition can occur will be shown in the next memoir of this series, which will deal with the Blechnineae, and it may be hoped that before long such questions will be set at rest for the Ferns now under consideration by a careful comparative study of the development of their sori. Meanwhile,

the cursory observations now made indicate that in all these Ferns the sorus is phyletically marginal in origin, but that the more advanced types may show a shifting of the sorus towards the lower surface. The biological significance of this is obvious, for protection of the young sorus is thereby secured, and this consideration therefore supports the view here advanced.

Three lines of argument should be used in arriving at such a conclusion as that above stated. First, the comparative use of detailed observations which form the immediate foundation upon which it may be based, by providing intermediate steps from the originally marginal state to the superficial. It is admitted that the series here given is an incomplete one, and that the whole question will have to be gone over again, and tested by numerous examples. The second line of argument is that based on the comparisons and conclusions of the systematists, chiefly relating to external characters, upon which the current grouping has been based. The probability is that such conclusions are correct. The third is the argument from physiological probability. In the present case, these three lines of evidence coincide in support of the conclusion as stated. Accordingly, the proper place of *Nephrolepis* (and probably also of *Oleandra*) in a phyletic system should be in near relation to *Saccoloma* and *Davallia*, notwithstanding the position of the sorus on the lower surface of the leaf. But their place in the system will be more distal than those genera where the sorus is more nearly marginal.

The similarity in position of the sorus, and in form of the indusium between *Nephrolepis* and the Aspidieae, is very striking. Commonly, there is this difference between Ferns of the Davalloid and those of the Aspidioid affinity: that where the sorus is 'phyletically' marginal the vein terminates in its receptacle, while, where it has been 'phyletically' superficial, the sorus is seated on a vein which still continues its course. But this does not appear to be a perfectly dependable rule. Any exceptions to it would still further accentuate the striking parallelism which these Ferns show. But, nevertheless, it must be concluded that the two groups have been distinct in their descent. The one is essentially marginal, the other essentially superficial, in the position of the sori. They illustrate in a remarkable degree the convergent development of two distinct phyletic lines.

#### LOXSOMA.

This Fern, as interesting as it is enigmatical in its relationships, has again come into prominence through a recent paper by Professor von Goebel ('Flora,' 1912, Band cv, p. 33, &c.). He has there not only figured the sorus afresh, but also described the prothallus, hitherto unknown. After a general survey of the known characters of *Loxsoma*, he concludes (p. 45) that there is no ground for placing *Gleichenia* in near relation with *Loxsoma*, and that the same holds for the Hymenophyllaceae. He considers that it

is more nearly related to the Cyatheaceae than to Gleicheniaceae: he suggests that it is a reduced form as regards its sporangium, and especially that the annulus, with its well-known incomplete induration, is a derivative from the type of the Cyatheaceae. His discovery of stiff appendages ('Borsten') upon the older prothalli provides a line of parallel comparison, for such 'Borsten' occur also on the prothalli of the Cyatheaceae. While welcoming the facts which von Goebel has added, I regret not being able to accept his conclusion, and I shall here re-state an alternative opinion, already expressed elsewhere ('Land Flora,' pp. 571-4).

It is an unfortunate circumstance that the term 'Cyatheaceae' has been used in a more extended, as well as in a restricted, sense. Diels (Engler u. Prantl, i. 4, p. 113), Christ ('Farnkräuter,' p. 10), and Christensen ('Index Filicum,' p. xvi.) have all applied it in the more extended sense, so as to include the Dicksonieae, the Thyrsopterideae, and the Cyatheae (or Alsophileae)—that is, to comprise Gradate Ferns, some with marginal, some with superficial sori. But Hooker, in the 'Synopsis Filicum' (pp. 9 and 15), separated his Tribe I, Cyatheae, from his Tribe II, Dicksonieae. Though he thus separated the main genera of Cyatheoids from the Dicksonioids, he placed the marginal *Thyrsopteris* with the superficial Cyatheae, and such superficial genera as *Onoclea* and *Hypoderris* with the marginal Dicksonieae. So that still in his system the position of the sori was not given its proper diagnostic importance. It will be pointed out later that it is essential to keep the distinction between marginal and superficial sori clearly in view, if a truly phyletic classification is to be arrived at: and, if that be so, clearly the relation of *Loxsonia* will be with the Schizaeaceae on the one hand, and with the Dicksonieae on the other, rather than with the Gleicheniaceae or the Cyatheae in the restricted sense.

Professor von Goebel demonstrates the presence of 'Borsten' on flattened prothallus of *Loxsonia*. They resemble structurally the stiff dark hairs which cover the rhizome of that Fern. He points out that their presence on the prothallus is a characteristic of the Cyatheaceae *in the widest sense*, and of some few Polypodiaceae, and that they are recorded from no representative of the Gleicheniaceae or Schizaeaceae. In his 'Organographie' (p. 412) he records that these hairs are present in *Balantium antarcticum*, so that they are not diagnostic between the marginal series (Dicksonieae) and the superficial (Cyatheae). The fact that they are present in *Loxsonia* may therefore be held as confirming a relationship with the marginal series, viz. with the Dicksonieae. But, on the other hand, the fact that they are absent from the prothalli of the Gleicheniaceae and Schizaeaceae, as also from those of the Osmundaceae, must not be held in any way to preclude comparisons with those relatively primitive types in respect of other characters, and particularly of those of the sorus and sporangium.

The sorus of *Loxsonia* is marginal in origin, with a cup-shaped indusium, from the centre of which the receptacle springs. Upon it the sporangia arise in a basipetal sequence. The position and structure of the sorus correspond to what is seen in *Thyrsopteris*, but the sporangia of *Loxsonia* differ in having an oblique, though imperfectly indurated annulus, and their dehiscence in a median plane. I have made new drawings of the sporangia from three different aspects. Fig. 26, *a*, shows a sporangium with its attendant hairs presenting its 'peripheral' face; that is, the side which is away from the receptacle. The annulus is seen with its distal side composed of large indurated cells, while the slit of dehiscence lies in the median plane. The basal side of the annulus is not indurated, though the sequence of its cells is easily traced, and sometimes they show a partial induration. The tabular cells which lie within the ring constitute the 'peripheral' face of the sporangium, and they are seen to be numerous. Fig. 26, *b*, shows the same sporangium from the opposite side, i. e. it represents the 'central' face, which is turned towards the receptacle. It is composed entirely of thin-walled tabular cells, and the annulus is wholly out of sight. Fig. 26, *c*, shows a similar sporangium seen laterally, and it brings out the conical form which the sporangium usually shows. The apex of the cone is at the centre of the 'peripheral' face. The biological meaning of the imperfectly indurated annulus was explained in my *Studies*, IV, *Leptosporangiate Ferns* ('Phil. Trans.,' vol. cxcii, p. 49). The comparative conclusion there arrived at was that *Loxsonia* appears to be a link connecting the *Gleichenia-Schizaea* affinity with the *Dennstaedtiinae*. As Professor von Goebel has now suggested that *Loxsonia* is a reduced type from the *Cyatheaceae*, and rejects the comparison with the *Gleicheniaceae*, I take this opportunity of re-stating my position in the matter.

In my view the underlying type of sporangium is the same in all Ferns which show an oblique annulus. Especially is this the case for the *Gleicheniaceae* and *Schizaeaceae*, as was fully shown in my *Studies*, IV, on *Leptosporangiate Ferns* ('Phil. Trans.,' vol. cxcii, p. 101). In all of them a 'peripheral' is distinguished from a 'central' face, and in all the more primitive types, where the sorus is not monangial, the position of these faces relatively to the receptacle is that which the above terms imply. The differences lie, not as von Goebel's diagram ('Flora,' vol. cv, p. 41, Fig. 7) would suggest, in the position of the ring, but in the greater or less proportions of the two faces. I would point out that in von Goebel's Fig. 7 (*l. c.*, p. 41), which is here reproduced as Fig. 27, while in (I) the orientation of the sporangium of *Loxsonia* is quite correctly given *relatively to the receptacle of the sorus*, in his diagram (II) of *Gleichenia* the receptacle is omitted, and the orientation of the sporangium *relatively to the leaf-surface* is shown, which is quite a different thing. I venture to amend his diagram in Fig. 27 *bis* by putting in the receptacle, and turning it into a position corresponding to that of the

Fig. 27, I, and adding a sporangium facing the first, so as to show what is actually seen in *Gl. flabellata* or any of the *Mertensia* section. It will then be seen that the annulus in Fig. 27, I, and in the right-hand sporangium of Fig. 27 *bis*, is in the same position *relative to the receptacle* (*pl.*), and that is the proper basis for the comparison.

But the point which is the most striking in the sporangium of *Loxsonia*, as compared with that of any other Gradate Fern, is the median dehiscence. The median dehiscence is, however, the rule in the Simplices, such as the Schizaeaceae and Gleicheniaceae. The question will then be whether or not it is probable that this character of *Loxsonia* is a survival from some simpler type of Ferns. Professor von Goebel's opinion is that it is not a survival, but a secondary acquired condition, derived from some Cyatheaceous source. Against this it may be urged that no such modification of the Cyatheaceous type is known elsewhere; nor does it seem probable, for it would, in fact, be a reversal of such a progression as we have reason to believe has actually taken place, having been determined by the mechanical requirements of the gradate sorus. The case made out in No. II of these Studies ('Ann. of Bot.,' vol. xxvi, p. 311) for a probable progression from the Gleicheniaceae type, through *Lophosoria* to the Cyatheaceous type, involves a transition from a simple to a gradate sorus, together with a change from a median to a lateral dehiscence. Similarly, I suggest that in the Schizaeaceae, *Loxsonia*, and the Dicksonieae there has been a progression from simple (marginal) to a gradate sorus, and from a median to a lateral dehiscence. But, in the case of *Loxsonia* the two changes have not synchronized. While it has acquired the gradate sorus, it has retained the median dehiscence characteristic of the living Schizaeaceae. In these latter Ferns, the stomium is not of an elaborate type, as shown by Prantl's figures ('Schizaeaceen,' Pl. V, Fig. 81; Pl. VI, Fig. 98; Pl. VII, Fig. 104; Pl. VIII, Fig. 141). In all of the four genera the split appears as little more than an interruption of the continuity of the indurated ring, without a definitely constructed stomium such as is seen in the Cyatheaceae; and this is what is the state in *Loxsonia*. Further, the form of the sporangium of *Loxsonia* resembles markedly that of *Lygodium*, though the lopsidedness is not so extreme (cf. Fig. 26, *c*, with Prantl's figure of *Lygodium*, l. c., Pl. VI, Fig. 97). But the annulus in *Loxsonia* is a wider ring, as, in point of fact, it is in *Aneimia* also, and the 'peripheral' face larger as a consequence. On the other hand, the spore output is only sixty-four, as against the larger numbers of the Schizaeaceae, though the form of the spores is similar. The general conclusion is, then, that there is a substantial similarity of the sporangia of *Loxsonia* to those of the Schizaeaceae, though not to any one genus of that family. If this be a true comparison, then we may look on *Loxsonia* as a Fern having, like the Schizaeaceae, a marginal origin of the spore-bearing members, and as having progressed to the state of a gradate sorus, but



retained the median dehiscence with modifications which are peculiar to itself. In fact it exhibits a state transitional between a Schizaeaceous and a Dicksonioid type. Such a progression would in the peripheral series of Ferns run parallel to that seen in the superficial series, as exemplified by Gleicheniaceae, *Lophosoria*, and the Cyatheoids.

Other lines of comparison accord with this conclusion. The dermal appendages on the rhizome of *Loxsonia* are stiff brown bristles ('Borsten'), with longitudinal, as well as transverse, septation towards the base. They resemble the stiff brown bristles of *Thyrsopteris*. But flattened rammenta, which are so marked a feature in the Cyatheae, are absent in both. The solenostelic structure described in detail by Gwynne-Vaughan ('Ann. of Bot.,' vol. xv, p. 71) corresponds to what is seen in many relatively primitive Ferns. It may, however, be specially noted that it is characteristic of the creeping Aneimias of the section *Aneimiorrhiza* (cf. Boodle, 'Ann. of Bot.,' vol. xiv, p. 359). The undivided leaf-trace of *Loxsonia*, in particular, has been compared by Gwynne-Vaughan with that of the Dennstaedtiinae on the one hand, and with that of *Aneimia* on the other. But, as regards the Cyatheaceae in the widest sense, to which von Goebel would refer *Loxsonia*, it may be remarked that in them the tendency is to subdivision of the leaf-trace, extending in *Cibotium* and in *Cyathea* to the extreme leaf-base. In *Loxsonia*, however, the leaf-trace is undivided, and continues upwards in that condition, as it does also in *Aneimia*. Thus, the rough vascular structure would indicate a nearer similarity to the Schizaeaceae than to the Cyatheaceae in the widest sense. Accordingly, in attempting to place *Loxsonia* phyletically, it should, in my opinion, be regarded as the sole representative of a distinct tribe; and its position appears to lie about the limit between the Simplices and Gradatae. And as its sorus is marginal, it takes its place in the marginal series, between the Schizaeaceae and the *Dicksonia-Dennstaedtia* series. It may be held generally to be an up-grade type, though the biological requirements of the sorus have led to a reduction of one side of the annulus.

A fossil referable to a somewhat similar position has recently been described by H. H. Thomas (*Stachypteris Halli*, a new Jurassic Fern, 'Proc. Camb. Phil. Soc.,' vol. xvi, p. 610), in which spike-like marginal sori are found. There is some uncertainty as to the details of its sorus, but sufficient is known to countenance its reference also to an intermediate position between Schizaeaceae and the Dicksonioids, somewhat similar to that now ascribed to *Loxsonia*.

#### ON THE PHYLETIC VALUE OF SORAL POSITION

A considerable number of relatively primitive Ferns have been discussed in the above pages, chiefly as regards their external morphology, their coarse anatomy, and their soral condition. They fall into two

sequences, viz. (1) those with their *sori superficial*, and (2) those with a *marginal position of the sori*. The latter are characterized by the fact—now demonstrated for *Thyrsopteris* ('Phil. Trans.,' vol. cxcii, p. 67), *Cibotium*, *Saccoloma*, *Odontoloma*, *Davallia*, and *Lindsaya*—that the receptacle originates from the actual margin, while the marginal initials appear themselves to give rise in certain cases to the earliest sporangia. A similar condition was long ago demonstrated by Prantl for the Hymenophyllaceae ('Die Hymenophyllaceen,' 1875, Taf. V), and shown by him to hold with singular constancy in the Schizaeaceae ('Die Schizaeaceen,' 1881, pp. 39-46), while *Loxsonia* appears also to share this character. These groups of Ferns, which show natural relationship in other features also, so that they have habitually been ranked together, constitute a great series characterized by having their *sori marginal*.

In a second great series the *sori* are as constantly superficial, having in their origin no direct relation to the margin of the leaf. They include the Gleicheniaceae, Matonineae, *Metaxya*, *Lophosoria*, and the Cyatheaes, with their related or derivative forms, such as the Woodsiaeae, *Struthiopteris*, and *Onoclea*, *Peranema*, and *Diacalpe*, the Nephrodieae, and their derivatives and relative forms. Also *Plagiogyria*, and the related Pterideae on the one hand, and the Blechnaeae on the other, are all, strictly speaking, types with *sori* of superficial origin. However nearly these may approach the margin of the fertile pinnae, in no case have they been shown to be actually derived from it. Indeed, to describe the *sori* of any of these Ferns as marginal is not in accordance with the observed developmental facts. In all cases their *sori* arise superficially from the flattened surface of the leaf.

The value of the distinction upon which this grouping is based as a phyletic criterion will depend upon its constancy. In the series with the *sori superficial* the constancy of that feature is believed to be absolute, with the exception of certain anomalous cases to be noted below. But the same cannot be said for the series which has the *sori typically marginal*. It will be necessary to look into this matter in detail. At the outset it would appear to be biologically a natural and advantageous adjustment that the sorus, if actually marginal, should be deflected for purposes of protection towards the lower surface of the leaf. It will be seen that this has repeatedly happened. But it will be shown that comparative reasons indicate these changes as secondary and biologically adaptive.

Looking back to the most primitive living types of Ferns, the Eusporangiatae, it is evident that the Ophioglossaceae have typically the marginal position of their spore-bearing members; also, that the Marattiaceae bear as typically their *sori* upon the leaf-surface. But the Osmundaceae, which in so many features occupy a position at the very base of the Leptosporangiate Series, are as a family indeterminate in this respect. Moreover, their sporangia are not disposed in definite *sori*. In *Osmunda* the sporangia

are in serried ranks which are essentially marginal, though they may spread on to the surfaces. In *Todea* they are seated on the lower surface. *The Osmundaceae are, however, the only living family which shows this indefiniteness.* Certain isolated exceptions occur elsewhere, but no other whole family is characterized thus. All are either characteristically marginal or superficial. It may be held from these facts that while the Eusporangiate families had already resolved this question of the position of their spore-bearing organs relatively to the leaf-margin, the Osmundaceae represent a very ancient type of Leptosporangiate Ferns in which the question was still undecided. This family may in fact in some sense suggest, or even represent, the indeterminate ancestry from which the Leptosporangiate Ferns, with their two distinct sequences, the marginal and the superficial, originally sprang.

We have seen that the superficial position of the sori is, with certain exceptions, constant in those Ferns which have adopted it. The exceptions must be considered in their bearing upon the constancy of such characters for phyletic comparison. Examples are found in *Polystichum aculeatum*, (L.) Schott, var. 37, *anomalum*, Hk. & Arn., and certain aberrant forms of *Scolopendrium vulgare*. The former of these is a variety of *P. aculeatum*, which grows on the Horton Plains, Ceylon, and was described in 1856 by Hooker and Arnott. The peculiarity consists in the appearance of the sori 'usually on the superior face'. Hooker states ('Sp. Fil.,' iv, p. 27) that 'the species is in cultivation at Kew, and retains its usual peculiarity of bearing the sori on the upper or anterior side of the frond'. Here it would appear that there has been in some way a transference of the stimulus, whatever it be, to sorus-formation to a spot where it is not typically present; for the sori themselves appear to be quite normal, except for their position. A somewhat similar state, though accompanied by malformation of the leaf, is to be found in some of the extravagant monstrous forms of *Scolopendrium vulgare*. Such cases, however, do not appear to me to throw any satisfactory light on the phyletic story. They may serve some time as points of attack on the question what it is that determines soral development at all. But the very suddenness of their appearance and the isolation of their occurrence stamps them as anomalies, rather than as dependable phyletic signs.

Very much the same may be said of the occasional occurrence of the sori in *Deparia Moorei* superficially. In the species *D. prolifera* they appear to be as a rule marginal, though in some Sandwich Island specimens they incline to the lower surface, as in *Davallia*.<sup>1</sup> A marginal position is the rule also in *D. Moorei*; but isolated sori are found not uncommonly upon the upper surface, and even at a distance from the margin. The absence of intermediate steps in *D. Moorei* suggests again an anomalous transfer of the stimulus to soral formation in the young primordium, rather

<sup>1</sup> Compare Mettenius, *Farnsgattungen*, vi, p. 63, and Pl. VI, Figs. 17-20.

than any significant fact for morphological comparison in Ferns at large. Such cases as these are few and isolated, so that they do not appear to indicate any stable modification of the usual marginal arrangement.

But quite a different view must be taken of that gradual and very general modification of position of the sorus which is seen in the derivatives of the Dicksonioid series. Here, with the sori typically marginal in origin, as they are now demonstrated to be in *Thyrsopteris*, *Cibotium*, *Saccoloma*, *Odontoloma*, and *Davallia*, there is seen to be a phyletic drift towards a position of the sorus upon the lower surface. It is probably a biological adaptation by which better protection is secured. But even in cases where the indusial lips have become very diverse in size and structure, the 'upper' having grown to all appearance like a continuation of the foliar expanse, still the receptacle is as truly marginal in origin as in the types where both lips are practically equal. It is thus clear that in these facts there is nothing to detract from the importance of the marginal position in its phyletic aspect. All that we see is a biological adaptation which tends to mask the original position of the sorus on the margin of the leaf.

The converse, viz. the approach of the sori to the marginal position in certain Ferns where they are typically superficial, is seen in the Pterideae. In simple cases, such as *Plagiogyria* and *Adiantum*, it is quite obvious that these are merely special cases of the location of superficial sori near to the margin. The consequence is, however, that a curious convergent phyletic has occurred; so that the appearance of some truly marginal types, such as *Lindsaya*, is very closely similar to that of some superficial types, such as *Pteris*. It may, indeed, be the case that sometimes the line of demarcation has not been rightly drawn. Developmental evidence from the earliest stages will have to decide in questionable cases.

An almost equivalent convergence is seen between the Aspidieae, which arose from a superficial origin, and such genera as *Nephrolepis* and *Oleandra*, the origin of which appears to have been from marginal types. Here, again, it is upon a basis of observation of the earliest stages of development of the sori, combined with wide comparison by other criteria, that it may be possible to allocate such converging types to their respective phyletic sources.

But the Davallieae, the Pterideae, and the Aspidieae are all relatively advanced types. None of the Ferns quoted as showing this convergence are really primitive. It follows that, notwithstanding such instances of convergence, and notwithstanding the modifications from type, sudden or gradual, such as have been above mentioned, a great body of fact establishes this conclusion: *That from a very early period the Leptosporangiate Ferns have progressed along two parallel lines, the one characterized by a marginal, the other by a superficial position of the spore-bearing organs; and that these lines have remained phyletically distinct throughout.*

If the course of events has really been as thus sketched, and the distinctness of the two phyla be as stated above, it will be apparent that in the phyletic treatment of Ferns the criterion of position of the sorus must take precedence, in point of early appearance and of constancy, over several others to which importance has habitually been attached. For instance, all the stelar types may be illustrated in either of these sequences; also all the three conditions of the sorus, simple, gradate, and mixed. The size and spore-output of the sporangium vary through a wide range in each. In each the more primitive types show hairs, while scales appear in the more advanced. Various minor characters also fluctuate within the series named. In fact, excepting the most fundamental features of the protostele and of the sporangium itself, there is no character so deeply seated in point of early appearance and constancy as the position of the spore-bearing members relatively to the leaf-margin. Accordingly, in the systematic treatment of the Filicales full weight should be given to it. The Leptosporangiate Ferns (exclusive of the indeterminate Osmundaceae) will then be naturally divided into two sequences which may be fitly styled the Leptosporangiatae Marginales and the Leptosporangiatae Superficiales. And the grouping of the families will be tentatively thus :

	<i>Marginales.</i>	<i>Superficiales.</i>
Simplices.	{ Schizaeaceae	Gleicheniaceae Matoniaceae
Gradatae.	{ Loxsomaceae Hymenophyllaceae Dicksonieae Thyrsopterideae	Cyatheae Woodsieae Onocleinae
Mixtae.	{ Davalliaceae Oleandreae	Aspidieae Blechninae Asplenieae Pterideae

The above table does not attempt to indicate phyletic sequences with accuracy or completeness. It is constructed merely to show the main constituents of the two great series. Moreover, certain large groups are intentionally omitted, such as the Polypodiinae and Acrostichinae, the Vittarieae and Taenitidinae, since it is quite uncertain how these will have to be split up and phyletically grouped, until much further detailed work has been done upon them. It is seen that in both the series there are representatives of the three soral conditions. But the lines of limitation of these cut athwart the two main series; in fact, the distinctions which they

embody do not lead to a phyletic classification, which should be the end ultimately to be aimed at. They represent merely 'states' which may be transitional or final in any phyletic sequence. It will be apparent at once that the grouping according to the original position of the sorus, since it is based upon a very early and a very constant distinction, is phyletically of greater value than any grouping based on features less constant and later in appearance. And this seems to be the true character of the distinction between *Simplices*, *Gradatae*, and *Mixtae*. That they are 'states' passed through in distinct phyletic lines was fully realized when these distinctions were first drawn ('Phil. Trans.,' vol. cxcii, p. 123). The three divisions were then held to 'illustrate three steps in the evolution of the sporophyte in the Order'. Moreover it was clearly stated that 'the members of each category are not to be taken as necessarily of common descent, but are grouped according to common adaptation'.

The same may, I think, be said of Professor von Goebel's recent suggestion to recognize two groups of Leptosporangiate Ferns as constituted from related forms (*Archegoniatenstudien*, xiv, 'Flora,' Bd. 105, p. 51, 1912). Of the Filices Leptosporangiateae he distinguishes as Group I, *Sporangiis longicidis* (the sporangium opening by a longitudinal slit), the Osmundaceae, Schizaeaceae, and the Gleicheniaceae. As Group II, *Sporangiis brevicidis* (the sporangium opening by an oblique or transverse slit), the Cyatheaceae, Hymenophyllaceae, and Polypodiaceae. This distinction seems to me to suffer under the same disability as that of the *Simplices*, *Gradatae*, and *Mixtae*, in that it also cuts athwart the lines based on the earlier and more constant character of soral position; while in itself it is based on a circumstance which can be explained as a concomitant, or it might even be held merely as a mechanical consequence of the arrangement of the sporangia in the sorus.

The objection to either of these methods of segregation of Leptosporangiate Ferns is in essence the same as that which opposes the suggestion of Kühn to classify the Polypodiaceae according to the nature of their dermal appendages. But they have the advantage in dealing with parts, the sporangia, which are of greater importance than the hairs: and it was the hairs which Kühn took as the foundation of his method (*Die Gruppe der Chaetopterides unter den Polypodiaceen*, 'Festschrift zu dem Jubiläum der K. Realschule zu Berlin,' 1882). Here again a character which is now known to have changed in a number of distinct progressive lines had been selected. We now know that the segregation of these lines is founded on characters anterior to, and more constant than, the distinction of those types of the dermal appendages which he used.

For the reasons thus stated, I find myself unable to accept Professor von Goebel's suggested partition of the Leptosporangiate Ferns. The partition according to the original position of the sorus appears to me

to have the advantage in leading towards a truly phyletic classification, since it is based upon a very early and remarkably constant character.

Returning in conclusion to the genus *Metaxya*, we may consider its position in the scheme thus sketched. It is clearly one of the Superficiales, and its near relation to the Cyatheaes, which has always been recognized, is indisputable. But it shares with *Lophosoria* the distinction of standing aloof from them. It is more primitive than they in several important characters, such as the creeping habit, the presence of hairs and absence of ramenta, the simple solenostelic axis and undivided leaf-trace, the simultaneous sorus and almost vertical, interrupted annulus. Like *Lophosoria* it is technically one of the Simplices, and the other characters named as primitive will justify its being placed in the superficial series below any of the true Cyatheaes. Its relation is probably nearest to certain species of *Alsophila* with hairy sori. But until these species have been more exactly examined the degree of that relationship cannot be defined.

The question, however, remains what relation, if any, there is between *Metaxya* and Ferns other than the Cyatheaes. It cannot escape notice that several of the early writers named it *Polypodium* (*P. rostratum*, Willd., *P. Humboldtii*, Poir., *P. blechnoides*, Sw.). A similarity may certainly be traced in general external characters, such as the creeping habit, the simple pinnation, and the flat hairy sori, to various types of *Polypodium*, and especially to the *Phymatodes* section of the genus. But they differ in the scaly dermal coverings, the high degree of subdivision of the vascular tracts in both leaf and axis, and in their mixed sorus. An apparent similarity of habit to *Neocheiropteris palmatopedata*, (Bak.) Christ, that remarkable Fern from Southern China, suggested an examination of its characters, as possibly supplying some intermediate or explanatory condition. But this anticipation was not realized. Text-fig. B shows a series of transverse sections of the rhizome of that Fern at the insertion of a leaf. The vascular system is seen to resemble other Polypodiaceous types in showing in the axis a large number of small meristemes disposed in a ring, while the leaf-trace also consists of a large number of small strands. The disposition of these is, however, along lines similar to those of the solenostele and the undivided leaf-trace of *Metaxya*, but both vascular tracts have been broken up by numerous 'perforations'. It is, however, worthy of note that occasionally such 'perforations' are seen in *Metaxya* (compare Fig. 3, v), so that the difference in this respect is only one of degree.<sup>1</sup> Scales are present in *Neocheiropteris*

<sup>1</sup> Since the above was written, Professor Gwynne-Vaughan has quoted to me a considerable number of instances among Ferns ranked under the comprehensive name of *Polypodium*, where the subdivision of the meristemes by perforations is in abeyance or less complete than in *Neocheiropteris*. It would be going too far afield to extend the present observations in this direction, and doubtless he will make his own statement on the point. But meanwhile the fact that such states occur is evidence of the correctness of the view put forward in the text.

as a dermal covering. The sori resemble those of *Metaxya* in their large area and in their position, and in the presence of numerous hairs scattered among the sporangia. But the latter have thin and long stalks and an interrupted annulus, while the sorus appears to be of the mixed type.

Notwithstanding that *Neocheiropteris* does not provide so convincing a link of connexion as was anticipated, the opinion may still be held, and its validity tested by further observations, that there is a natural relation between *Neocheiropteris* or *Phymatodes* and *Metaxya*. A Fern modelled on the *Metaxya*-type with numerous perforations in the stele and leaf-trace, with scales in place of simple hairs, and with a mixed sorus and long-stalked sporangia with a vertical annulus, would inevitably be classed as

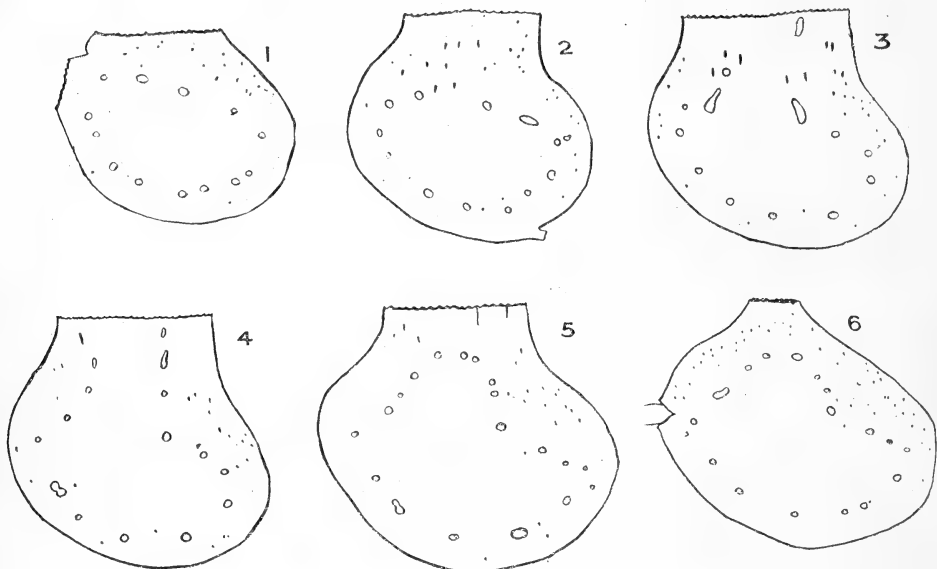

TEXT-FIG. B.

a *Polypodium*. But all these would be natural progressive steps from the condition of *Metaxya*, such as are abundantly illustrated elsewhere. There is reason to believe that they may have been taken by forms derivative from the *Metaxya*-type. But so far we have succeeded in recognizing no intermediate forms which would link *Metaxya* definitely with such Polypodioid derivatives. Till the gap is closed by such links, the suggested relation cannot count as more than a working hypothesis. But it is an hypothesis which should stimulate further inquiry.

## SUMMARY.

1. *Metaxya rostrata*, Presl, which has currently been included in the genus *Alsophila*, as *A. blechnoides*, (Rich) Hk., should be retained as Presl placed it, viz. as the single species of a substantive genus.



2. The characters which distinguish it from *Alsophila* are the creeping habit, the unbranched hairs and absence of scales, the solenostelic structure of the axis and undivided leaf-trace, the flat receptacle and simultaneous origin of the numerous sporangia, and the almost vertical annulus, interrupted at the insertion of the sporangial stalk.

3. These characters collectively place it in a position phyletically more primitive than the true Cyatheae, in a somewhat similar independent position to that held by *Lophosoria*.

4. Notwithstanding the dictyostelic structure with medullary strands shown in their upright axes, all the genera of the true Cyatheae may at times show a solenostelic structure in their runners, which arise from dorsal buds, as in *Lophosoria* and *Metaxya*.

5. *Thyrsopteris* shows a solenostelic structure of its axis, with a medullary system built up from 'compensation strands'. Its leaf-trace is undivided at the base. This structure closely corresponds to that of *Saccoloma*.

6. The sori of all such species of *Thyrsopteris*, *Dicksonia*, *Saccoloma*, *Odontosoria*, *Lindsaya*, and *Davallia* as have been examined developmentally arise from the actual leaf-margin, their indusia being of the nature of surface growths.

7. The sori are quite separate in *Thyrsopteris* and *Dicksonia*: but they have their upper indusial flaps fused laterally in *Saccoloma*; both flaps are fused, and their receptacles also in *Lindsaya*, while a vascular commissure may join the distal ends of the veins, which are elsewhere free. These fusions are secondary and derivative characters which indicate phyletic advance.

8. The first sporangia of the sori of the genera named appear to be strictly marginal in their origin, followed by a 'gradate' sequence in the more primitive types, such as *Thyrsopteris* and *Dicksonia*, but becoming 'mixed' in more specialized types, such as *Lindsaya* and *Davallia*.

9. The sporangia of *Thyrsopteris* and *Dicksonia* have a complete oblique annulus, but in the more advanced types it tends to become vertical, and is interrupted at the stalk as in *Davallia*.

10. In all the more advanced types, and particularly in *Davallia*, the sorus, though developmentally marginal, is diverted to the lower surface by the advance in strength and complexity of the upper indusial flap which forms a false margin of the leaf.

11. This appears to have become accentuated further in *Nephrolepis*, and probably also in *Oleandra*, and thus the sori have the appearance of being superficial.

12. Except for this phyletic slide of the sorus to the lower surface in these relatively advanced types, the sorus is constantly of marginal origin in all the Dicksonioid and Davallioid series, as it is also in *Loxsonia*, in the Hymenophyllaceae, and in the Schizaeaceae.

13. In *Loxsona* we see an isolated monotypic genus which has marginal sori like the Schizaeaceae, *Thyrsopteris* and *Dicksonia*, and is, like both of them, solenostelic, with hairs as dermal appendages. Its sporangia are of the Schizaeoid type, and retain the dehiscence in the median plane. But the sorus has become gradate as in *Thyrsopteris* and *Dicksonia*. Its phyletic position is probably somewhere between, or in relation to, these types.

14. The Leptosporangiate Ferns (excluding the Osmundaceae which appear in this respect to be indeterminate) fall into two distinct series: the 'Superficiales', in which the origin of the sorus is constantly from the leaf-surface, and the 'Marginales', in which it is as constantly from the margin.

15. So far as the value of the general phyletic characters for the Ferns can be estimated, the criterion of position of the nascent sorus may be held to take precedence, in point of early origin and constancy, over any soral characters except the primal features of the sporangium itself, and over any anatomical characters of the axis derivative from the protosteles.

---

## DESCRIPTION OF THE FIGURES IN PLATES XXXII–XXXIV.

Illustrating Prof. Bower's paper on *Metaxya* and certain other relatively primitive Ferns.

### PLATE XXXII.

Fig. 1. Transverse section of the rhizome of *Metaxya*, showing the solenostelic structure and coarse superficial hairs.  $\times 3$ .

Fig. 2. Transverse section of the petiole of *Metaxya*.  $\times 3$ .

Fig. 3. 1–VI. Successive transverse sections through a rhizome of *Metaxya*, arranged in basipetal sequence, and traversing the base of a leaf and the young bud which springs from it. For details see the text.  $\times 2$ .

Fig. 4. Three nearly mature sori of *Metaxya*, photographed in surface view. Considerably enlarged.

Fig. 5. Vertical section through a young sorus of *Metaxya*, traversing the vein below it transversely. The receptacle is already of considerable size, and bears hairs, while the numerous young sporangia, all nearly of the same age, are already initiated.  $\times 250$ .

Fig. 6. Vertical section through a sorus of *Metaxya* of the same age as the last, but following the course of the vein. The receptacle is here seen to be extended along the vein, and it bears numerous sporangia and hairs.  $\times 250$ .

Fig. 7. Vertical section of a rather more advanced sorus of *Metaxya*, showing seven sporangia and numerous hairs. All the sporangia are of nearly the same age.  $\times 250$ .

Fig. 8. Transverse section through the stalks of sporangia and attendant hairs in *Metaxya*, showing their relative positions and regular orientation.  $\times 250$ .

Fig. 9. 1–V. Sporangia of *Metaxya* seen from various points of view. For details see the text.  $\times 125$ .

### PLATE XXXIII.

Fig. 10. Transverse section of a small runner of *Hemitelia setosa*, showing the solenostelic structure (*sol*), with two small medullary strands (*m.s.*). *sc* = sclerenchyma.  $\times 2$ .

Fig. 11. Vertical section through the sorus of *Dicksonia Scheidei*, still sufficiently young to

show the course of the marginal segmentation, and to demonstrate that the actual marginal cell directly forms the apex of the receptacle of the sorus. The upper (*u*) and lower (*l*) indusial flaps arise as superficial, that is intramarginal upgrowths.  $\times 250$ .

Fig. 12. 1–VI. Successive transverse sections of a runner of *Cibotium Barometz*, from the insertion of the lowest leaf to its extreme base. For details see the text.  $\times 2$ .

Fig. 13. Photograph of a transverse section at the base of a runner of *Cibotium Barometz*, showing the ‘*Lindsaya*’ condition.

Fig. 14. Transverse section of a petiole of *Thyrsopteris elegans*.  $\times 2$ .

Fig. 15. *a, b, c*. Successive transverse sections of a small runner of *Thyrsopteris elegans*. *a* is near to the base of insertion, and shows a simple solenostele, with the origin of a root; *b* is higher up, and a medullary strand is seen within the solenostele; *c* is again higher, and shows a leaf-trace given off, the leaf-gap nearly closed, with a thickening of the lip preparatory to giving off a compensation strand.  $\times 6$ .

Fig. 16. *a, b*. Successive stages in the development of a sorus in *Saccoloma elegans*, showing that the origin of the receptacle is strictly marginal and the individual flaps superficial. It is to be noted that the lower flap (*l*) takes precedence at first over the upper (*u*).  $\times 250$ .

Fig. 17. *a, b*. Successive stages in the development of a sorus of *Odontosoria retusa*, showing the marginal origin of the receptacle and the proportions as in *Saccoloma*.  $\times 250$ .

Fig. 18. A more advanced stage in the marginal sorus of *Odontosoria retusa*. *u* = upper, *l* = lower indusium. The vascular receptacle bears the oldest sporangium centrally, i.e. it takes the position of the marginal cell, while other sporangia and hairs originate laterally.  $\times 100$ .

Fig. 19. Transverse section of a sorus of *Odontosoria retusa* of same age as Fig. 18, traversing it in a plane *a, b*, while the plane of Fig. 18 would correspond to the plane *c, d*. It is seen that the oldest sporangia form a linear series in a median position.  $\times 100$ .

Fig. 19 *bis*. Base of sporangium of *Odontosoria retusa*, showing the oblique annulus with its induration interrupted at the insertion of the stalk.  $\times 125$ .

#### PLATE XXXIV.

Fig. 20. A single pinna of *Lindsaya lancea*, showing the furcate venation, and the sori fused laterally to form an almost continuous, apparently intramarginal series. Both upper and lower indusial flaps confluent, the upper forming the false margin of the pinna.  $\times 6$ .

Fig. 21. A small part of the marginal region of a similar pinna, showing an incomplete lateral fusion of the sori, which explains how the *Lindsaya* sorus was arrived at. To the left is an almost isolated sorus of the *Saccoloma* type. To the right a more complete fusion is seen, while vascular commissures connect the receptacles laterally. From a drawing by Mr. Thompson.  $\times 70$ .

Fig. 22. A sporangium of *Lindsaya repens*, (Bory) Bedd., showing the annulus as a continuous ring, but the induration of its cells is not continued beyond the insertion of the stalk.  $\times 250$ .

Fig. 23. A vertical section through a very young sorus of *Davallia pentaphylla*, showing the marginal segmentation leading up to the receptacle, which appears as a valley between the two indusial flaps. As before, the lower (*l*) takes precedence at first of the upper (*u*).  $\times 250$ .

Fig. 24. A similar section of the sorus of *D. pentaphylla*, but older. The lower indusium (*l*) has run out to a single layer of cells; the upper (*u*), which ultimately forms the false margin of the leaf, is more bulky, and shows signs of intercalary activity. The first sporangium occupies a central position on the receptacle, and a later one is seen laterally, thus indicating a gradate sequence.  $\times 250$ .

Fig. 25. A vertical section of the young sorus of *Nephrolepis biserrata*, (Sw.) Schott, showing the great inequality of the indusial flaps. The lower (*l*) is markedly intramarginal; the upper (*u*) appears very definitely as a continuation of the leaf-surface, and has an active marginal segmentation.  $\times 250$ .

Fig. 26. *a, b, c*. Sporangia of *Loxsona*, seen from three different points of view. For details see the text.  $\times 100$ .

Fig. 27. Photographic reproduction of the diagrams of Professor von Goebel (‘*Flora*’, cv, Heft i, p. 41, Fig. 7). But his diagram (II) has been orientated afresh, in relation to the placenta (*pl*), and duplicated, so as to show the condition seen in *G. flabellata*, where, seated upon the leaf lamina, is a sorus, with slightly raised receptacle or placenta (*pl*), and sporangia on either side of it. This is shown in Fig. 27 *bis*.





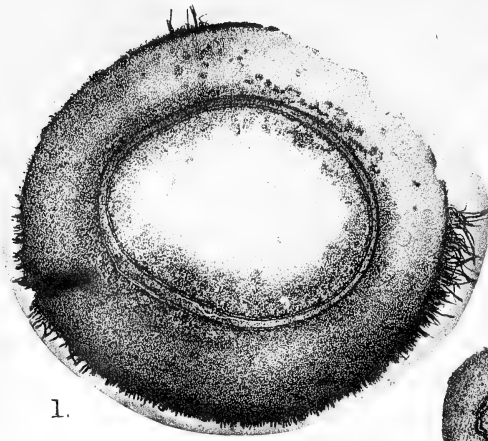

1.

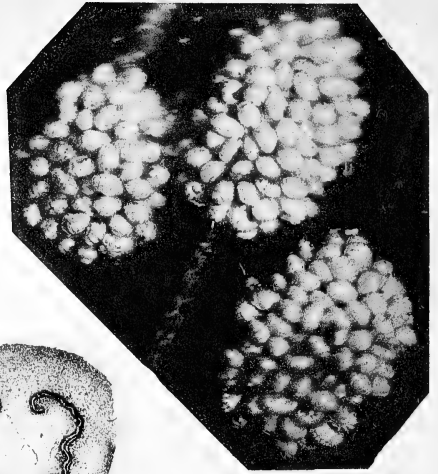

2.

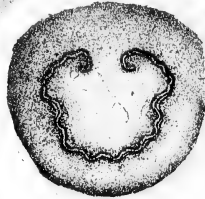

4.



I



II

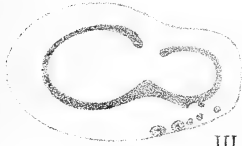

III

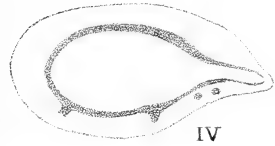

IV

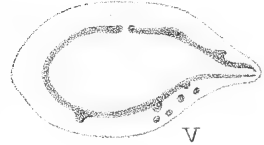

V



VI

3.

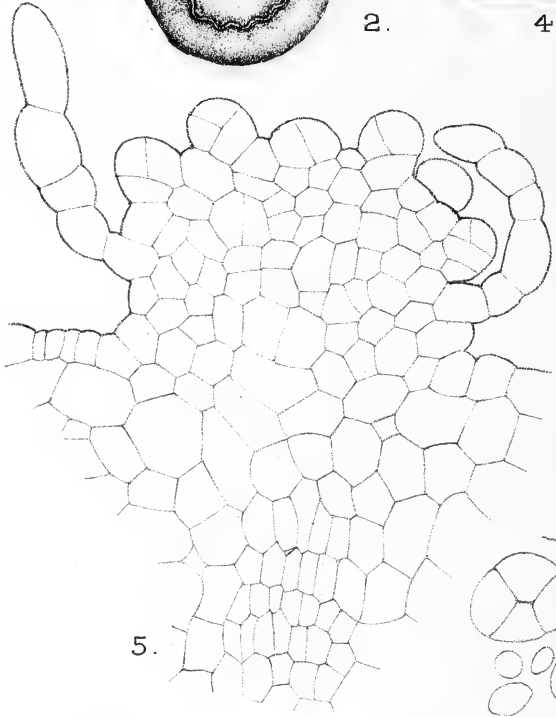

5.



9.

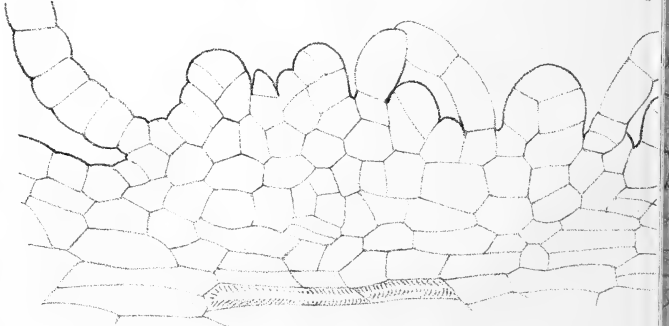
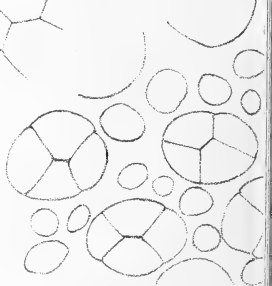

6.

F.O.B. del.

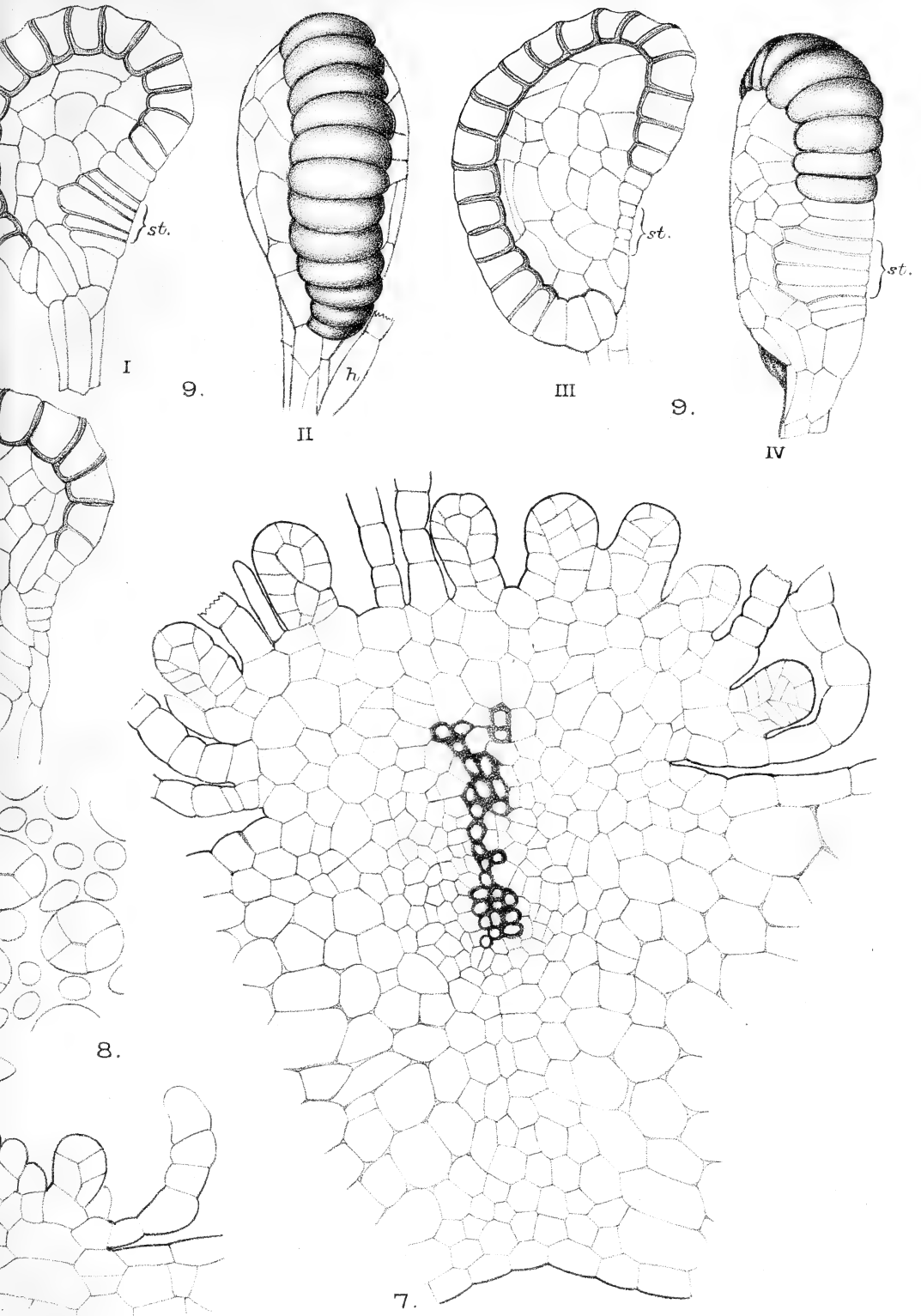





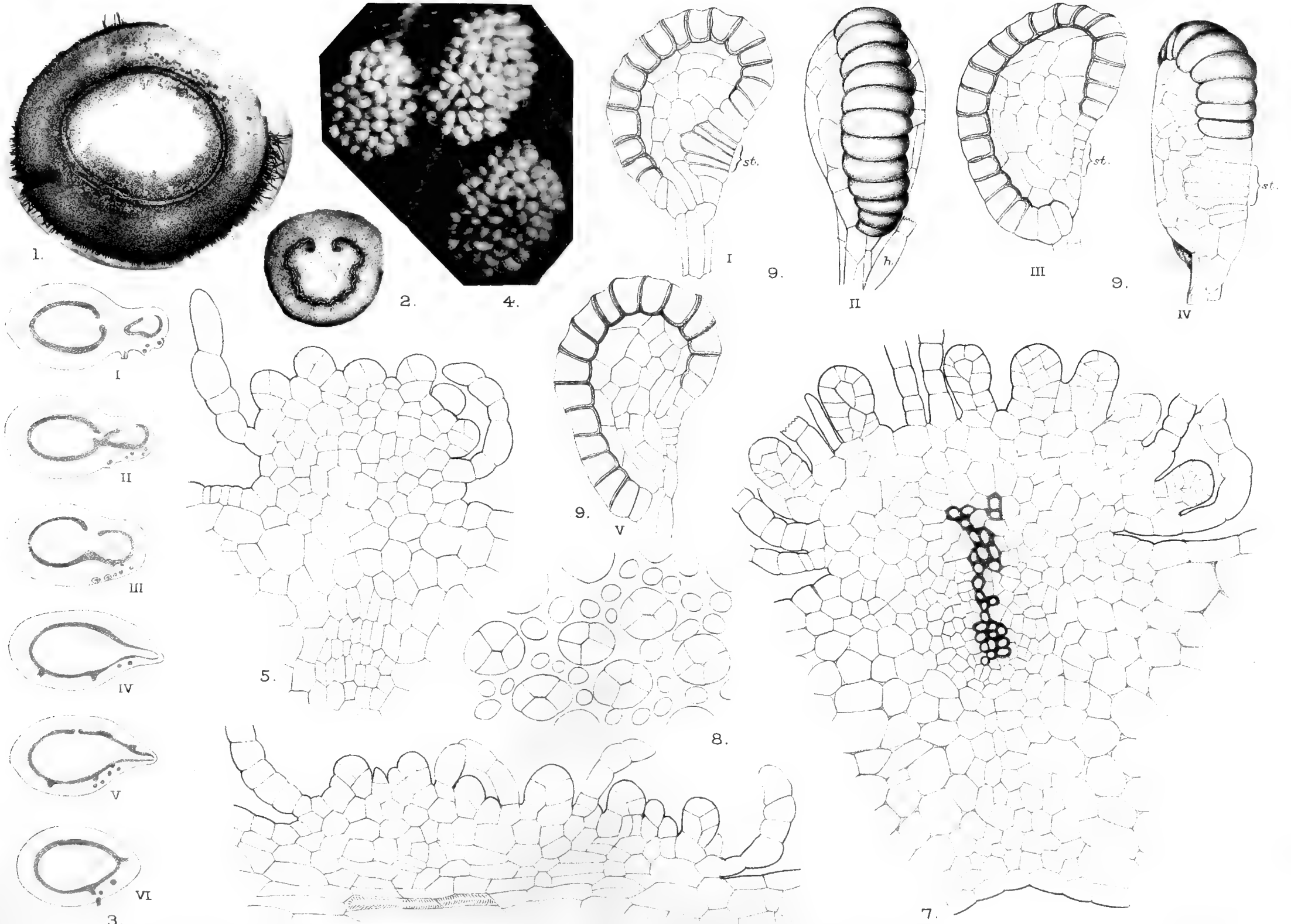

F.O.B. del.





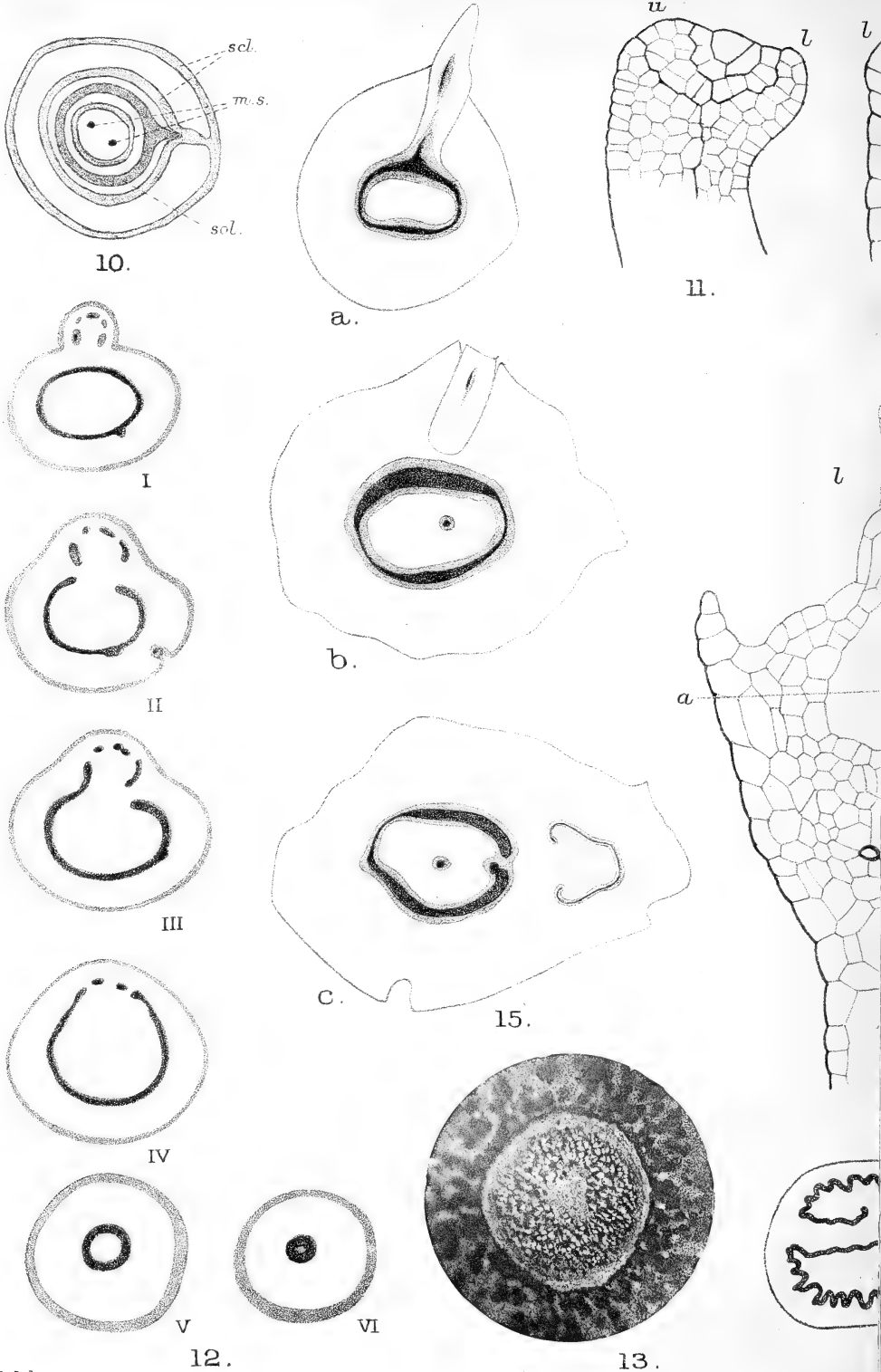

F. O. B. del.

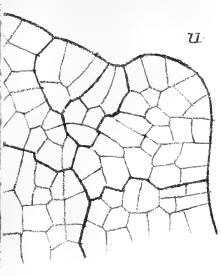

16b

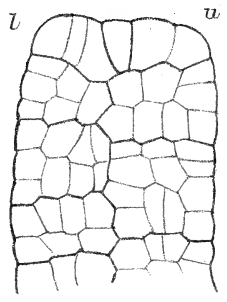

17a

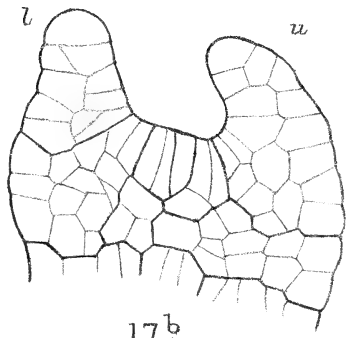

17b

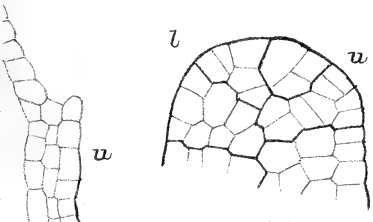

16a

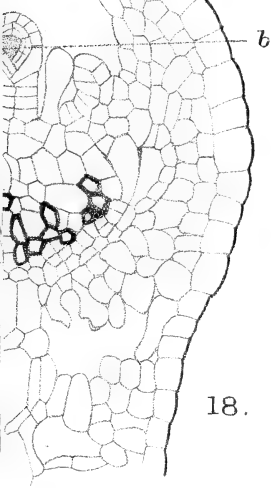

18.

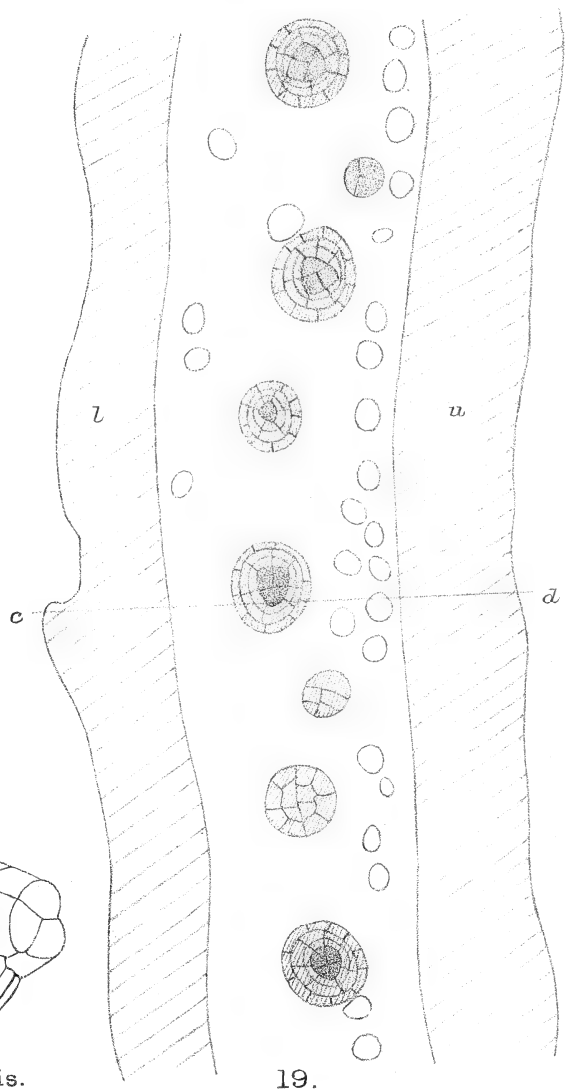

19.



14.

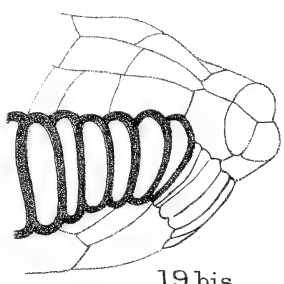

19 bis.



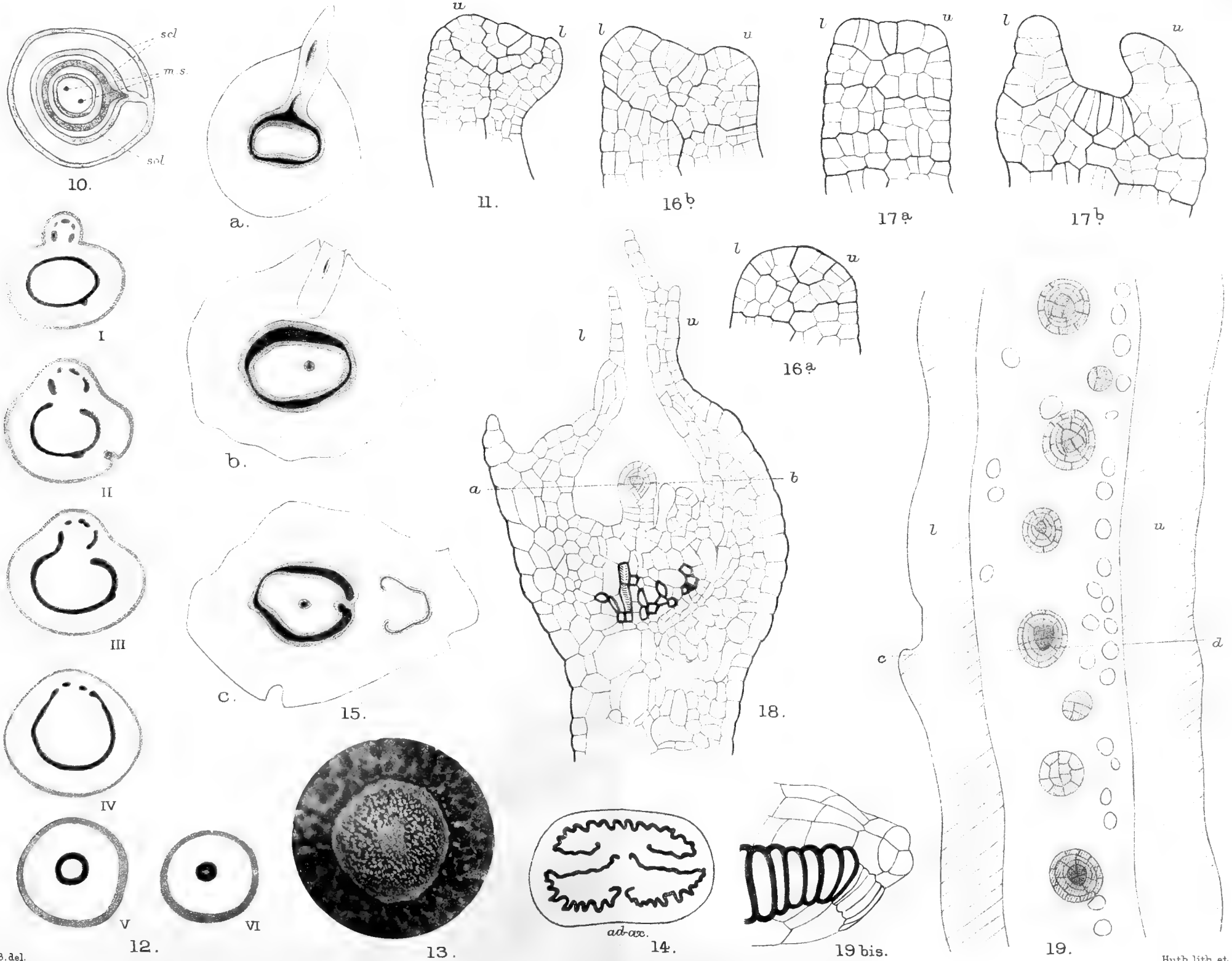

F.O.B. del.

BOWER-METAXYA AND OTHER FERNS.

Huth lith. et imp.

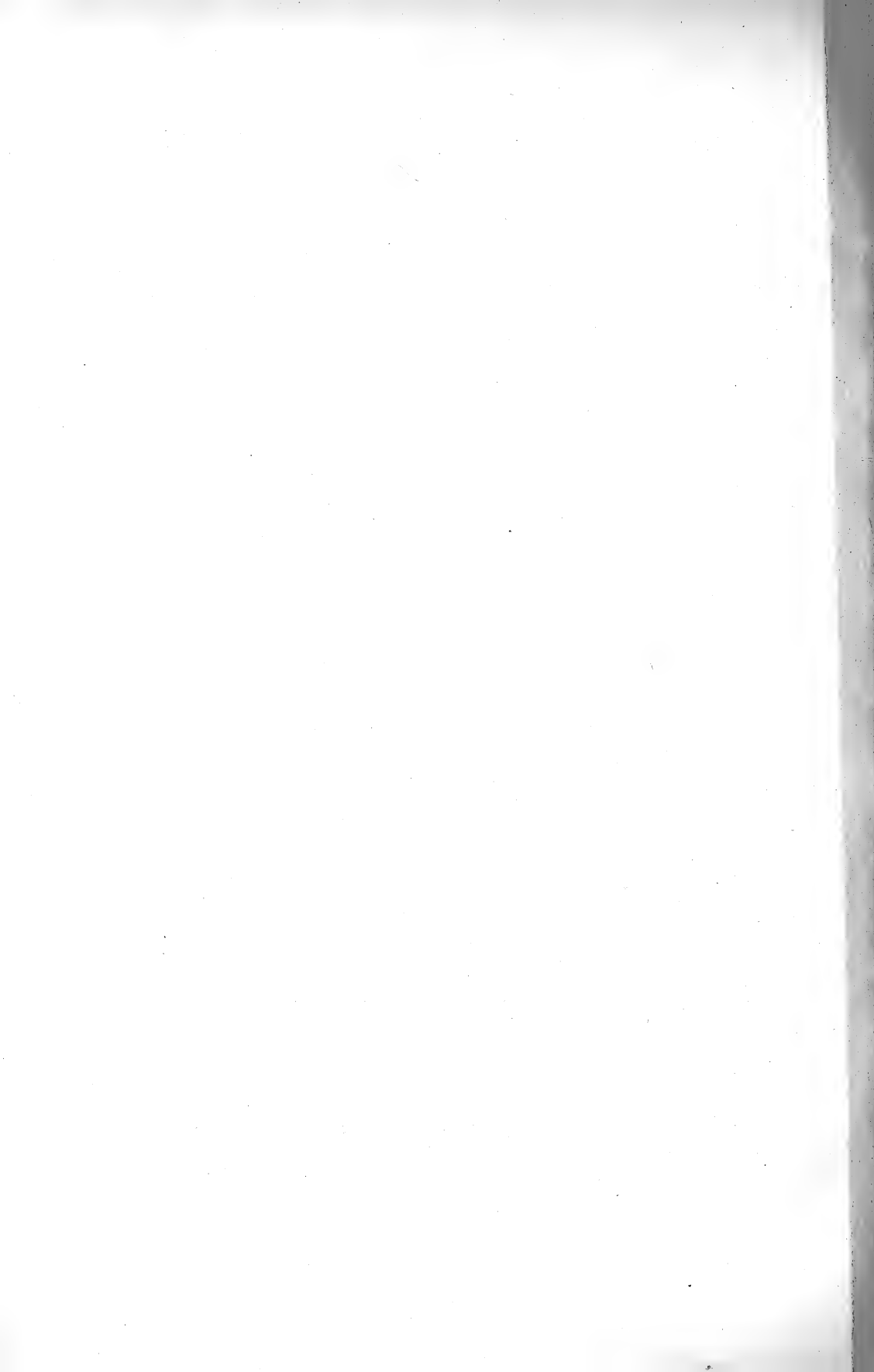





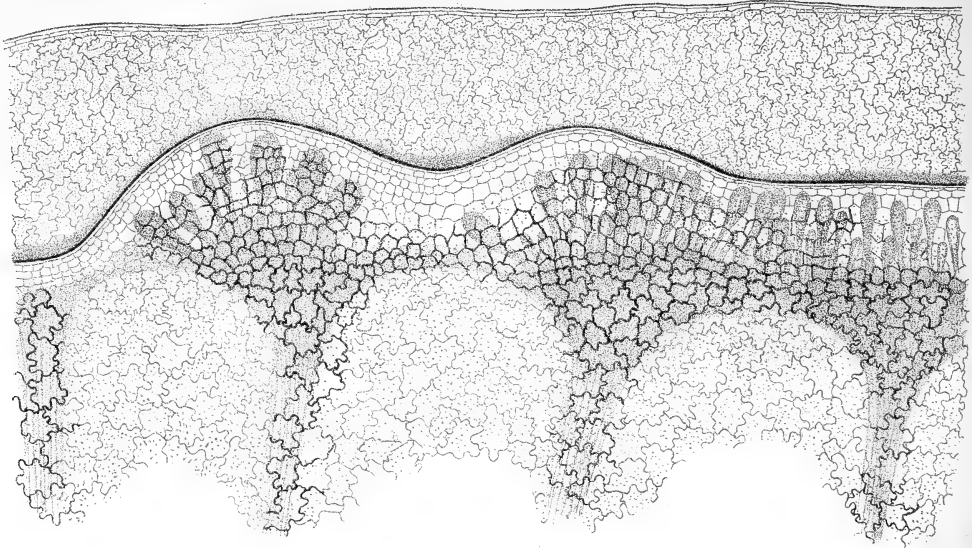

21.

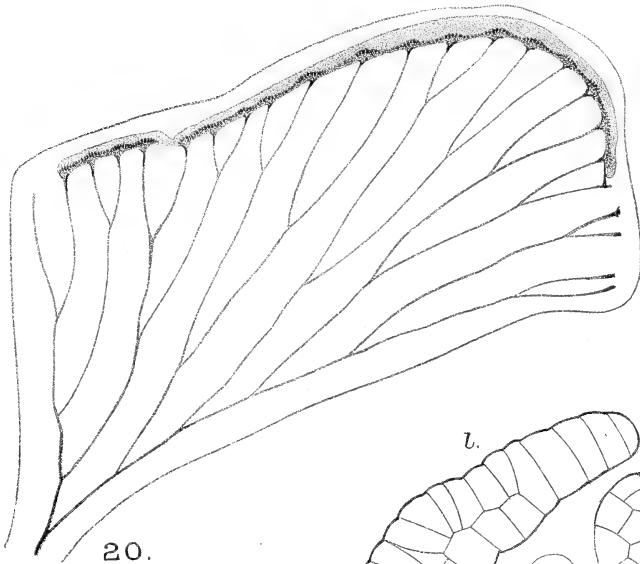

20.

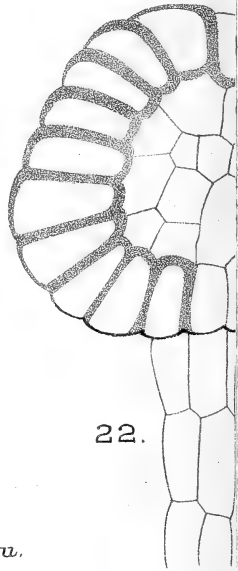

22.

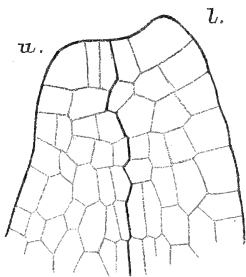

u.

l.

23.

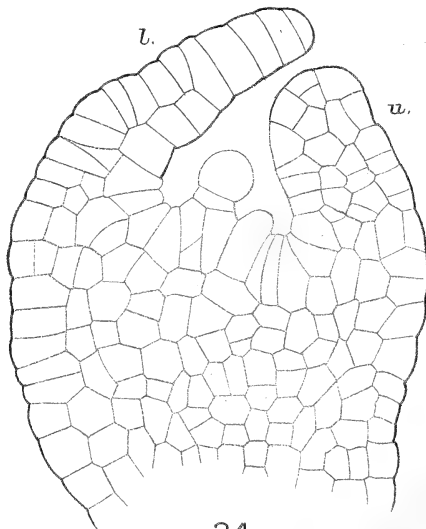

l.

u.

24.

pl.

I

F.O.B. del.

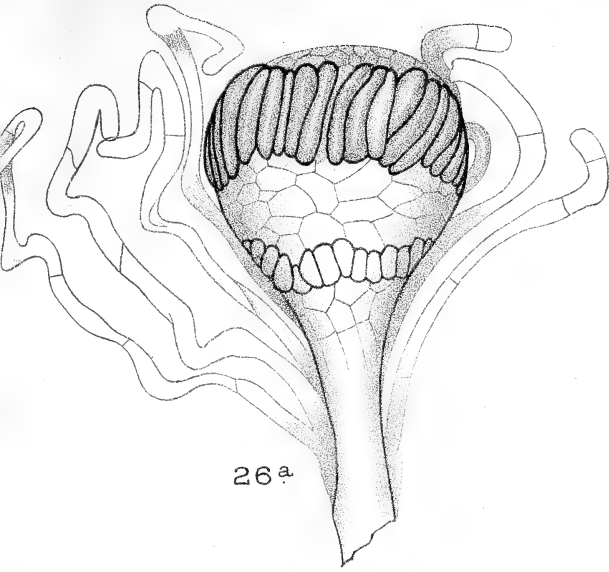

26 a

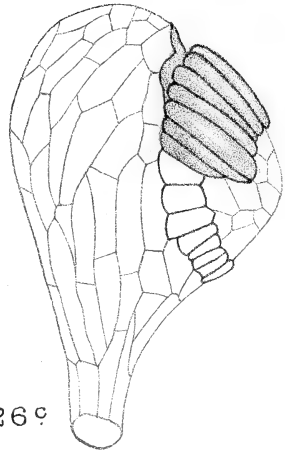

26 c

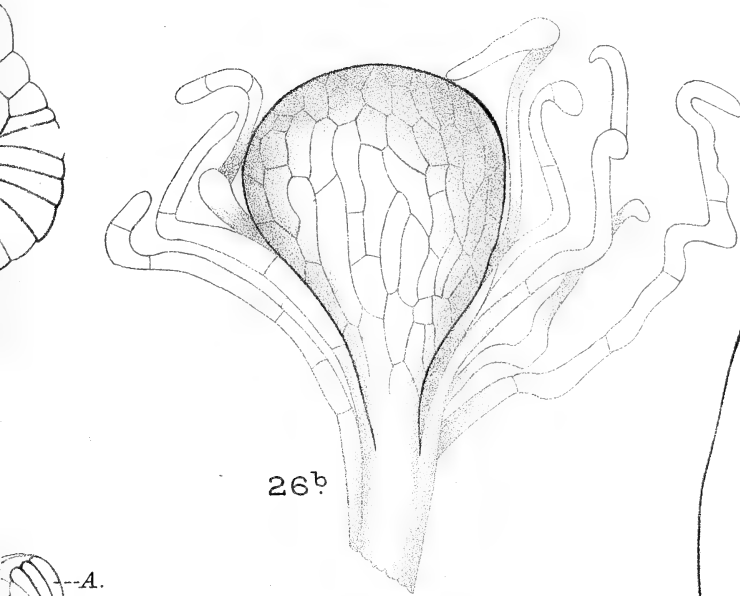

26 b

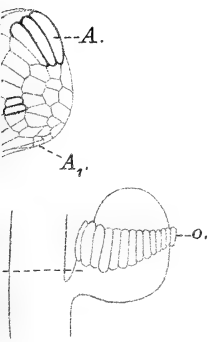

II

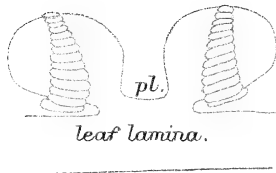

27 bis.



25.

Huth lith. et imp.



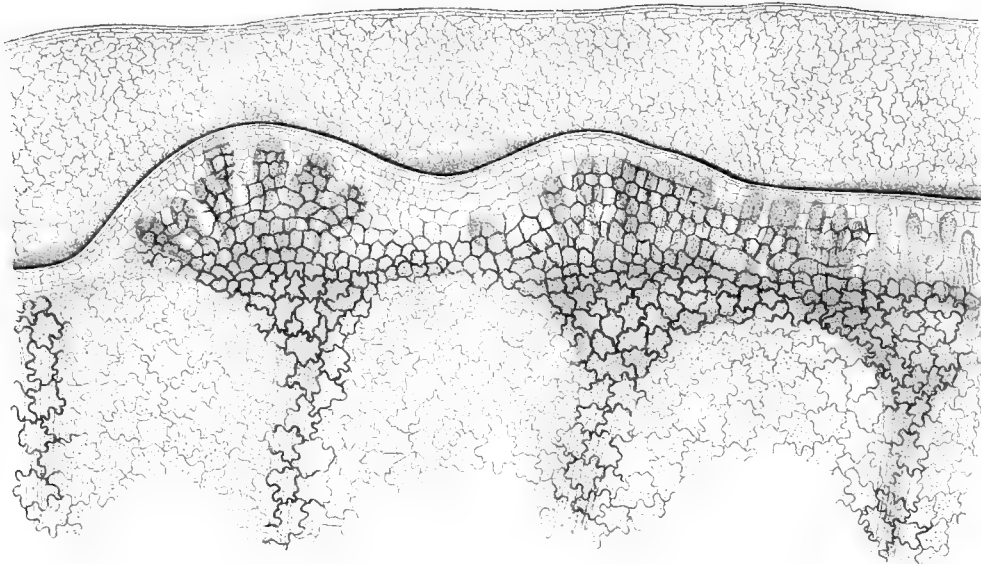

21.

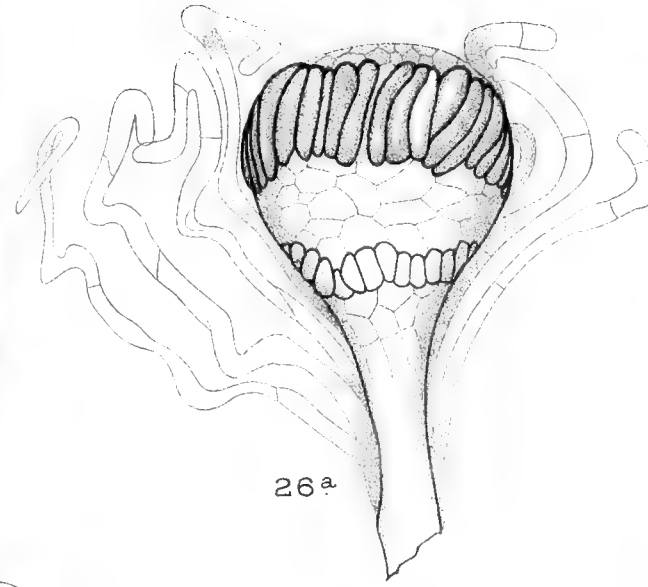

26a

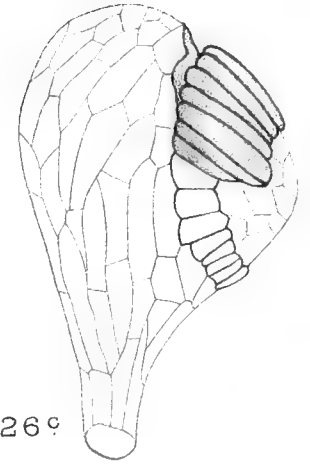

26c

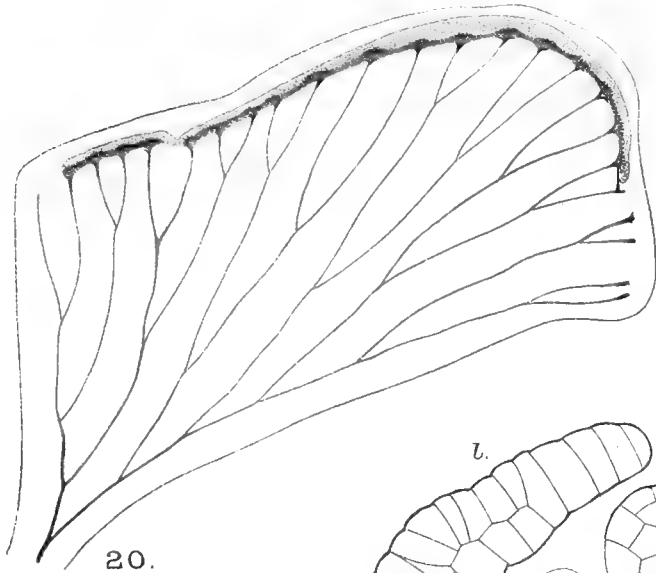

20.

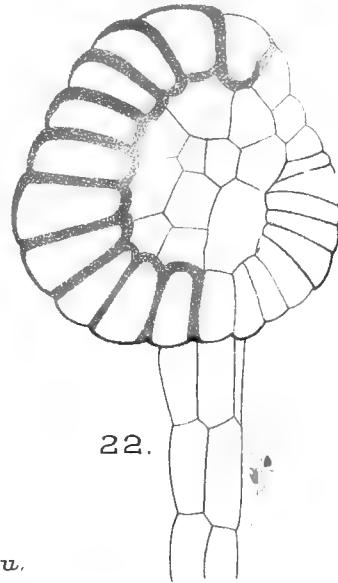

22.

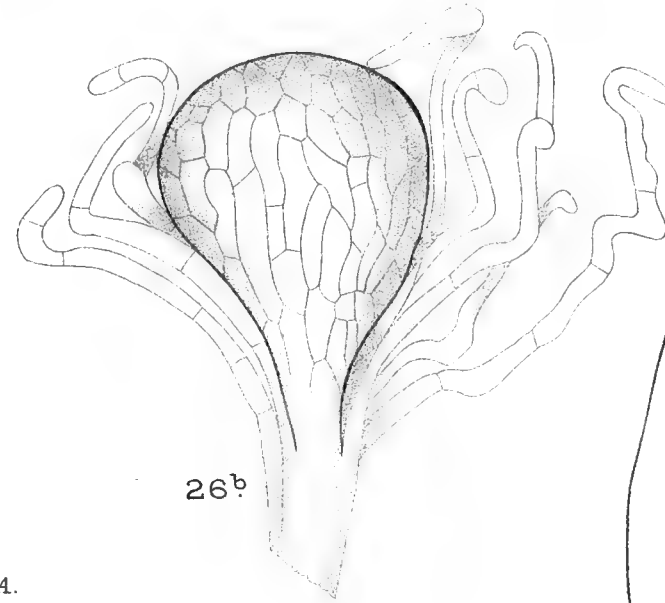

26b

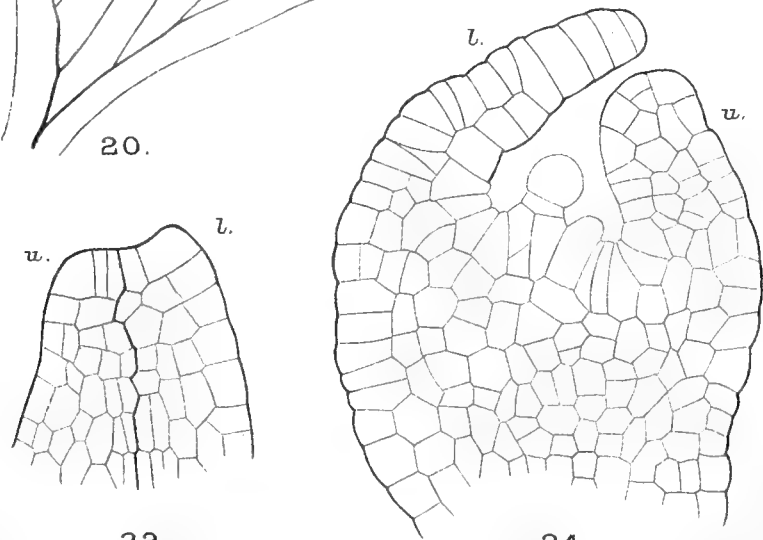

u.

l.

23.

l.

u.

24.

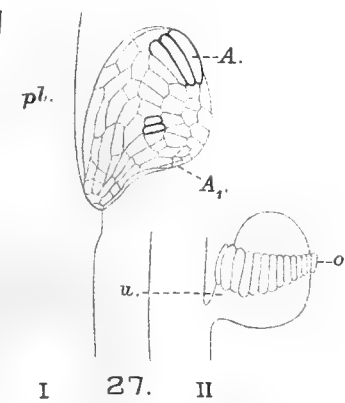

I

27.

II

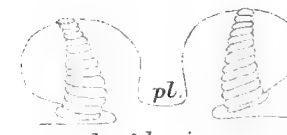

leaf lamina.

27 bis.

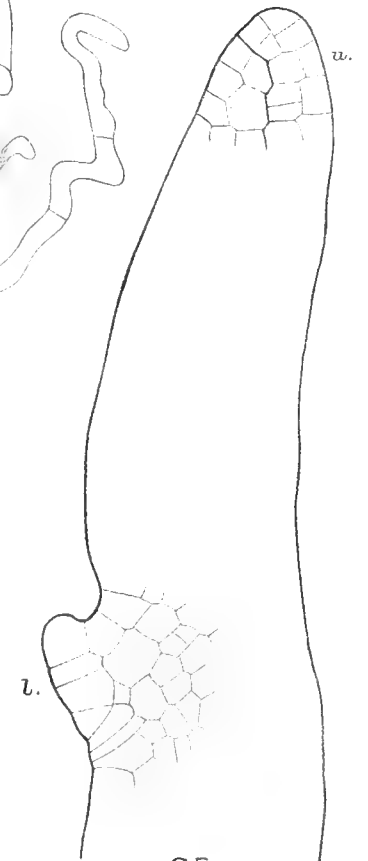

l.

25.

F.O.B. del.

Huth lith. et imp.



# The Floral Morphology of the Genus *Sebaea*.

BY

ARTHUR W. HILL, M.A., F.L.S.

*Assistant Director, Royal Botanic Gardens, Kew.*

With Plate XXXV and two Figures in the Text.

TOWARDS the close of the year 1907, when commencing work on the South African species of the genus *Sebaea* (Gentianaceae) for the 'Flora Capensis', my attention was very soon drawn to the curious pair of swellings or glands which were usually to be seen on the style, below the level of the anthers. After microscopic examination of herbarium material of a number of flowers of different species, it seemed fairly certain that these two glandular bodies must be stigmatic in character. Pollen-grains were observed closely attached to their surface, and in the case of *S. imbricata* were seen to have germinated, but the material was for the most part too much withered and dried to allow of proper investigation. In order to verify the supposition that *Sebaea* possessed auxiliary stigmatic surfaces, fresh material was essential. Owing to the kindness of Professor H. H. W. Pearson, the late Dr. H. Bolus, Mr. J. Burt Davy, Dr. R. Marloth, and Mr. W. C. Worsdell, seeds of several species of *Sebaea* were sent to Kew in the spring of 1908 and onwards, from which a good supply of plants was raised for experimental purposes.

After the first batch of plants had been raised and several experiments on the secondary stigma had been made,<sup>1</sup> an abstract of a paper was

<sup>1</sup> The possible stigmatic character of the swellings was first raised in a letter from Kew to Mr. Pole Evans, Mycologist to the Transvaal Department of Agriculture, on December 23, 1907. On February 7, 1908, letters were written to Professor Pearson and to Dr. Bolus at the Cape, drawing their attention to these swellings and asking them both to make observations and also to send seeds in order that experiments could be undertaken at Kew. Dr. Bolus very kindly sent seeds of *Sebaea aurea* on March 6, 1908. He wrote: 'Your note of Feb. 7 asking for seeds of *Sebaea* came by last mail. We lost no time in searching, and were fortunate in getting seed of *Sebaea aurea*, R.Br., our commonest species, although it is very late for it'; and on August 26 he wrote again in answer to a further letter written August 1, asking him to carry out experiments in S. Africa with reference to the secondary stigma: 'We shall do what we can in regard to observations on the living plants, as to the parasitism and as to the supposed fertilization by means of a secondary stigma below the apex of the style. But you must not expect much. My walking days are over and I can seldom get so far as where our best plants grow.'

Seeds of other species of *Sebaea* were sown in May, 1908, some of which were received direct

received from Dr. Marloth, which he had read at a meeting of the Royal Society of South Africa on September 16, 1908. In this paper he described the secondary stigma in *Sebaea exacoides*.

On receiving Dr. Marloth's full paper,<sup>1</sup> published in July, 1909, I found that he had reached the same conclusion, with regard to the stigmas of *Sebaea exacoides*, to which I had been led from an examination of the whole genus and by the series of experiments shortly to be described.

Although the results of this work have to some extent been forestalled by the publication of Dr. Marloth's interesting observations made in South Africa, they seem worthy of being placed on record as an independent account of the peculiar floral structure which obtains in the genus. As a further extenuating circumstance, it may be pointed out that the investigation has been carried out on lines different from those followed by Dr. Marloth.

The Natural Order Gentianaceae shows several peculiarities of stigmatic arrangement in the different genera, which appear to be correlated with the structure of the corolla. Examples of dimorphic heterostylism are found in the genera *Exochaenium*,<sup>2</sup> *Hockinia*, and to a slight extent in *Lisianthus*, all genera in which there is a well-marked corolla tube, and it seems possible that this condition may also occur in the genus *Sebaea* itself. Then in *Pleurogyne*,<sup>3</sup> with its widely open and almost polypetalous flowers, the stigmatic surfaces form two bands down the sides of the ovary and the normal apical stigma appears to be more or less functionless (see Figs. 1 and 2, Pl. XXXV).

In *Sebaea*, where there is a distinct and more or less cylindrical corolla tube, the style is usually elongated. The stigma at its apex may be clavate, capitate, or in many cases shortly bilabiate. Except in the two species included in the sub-group *Brevistylae*,<sup>4</sup> *S. spathulata* (Pl. XXXV,

from Mr. Burt Davy, and some collected from the dried material sent over from the Transvaal Herbarium for identification. From the seeds so obtained numerous plants were raised and afforded ample material for experiment.

On October 7 of the same year Dr. Marloth kindly sent seeds of *Sebaea (Belmontia) cordata*, and wrote as follows: 'The box also contains some seeds of *Belmontia cordata*, as I heard from Dr. Bolus that in connexion with the Part on Gentianaceae for the "Flora Capensis" you wished to raise some plants from seed. I take the liberty of enclosing an abstract of a paper on some biological features of *Belmontia*.'

To complete the record of the seeds sown at Kew a packet of seed of *Sebaea ambigua* was received from Mr. Worsdell, from the Cape, in April, 1910, which also yielded some interesting seedlings, and I desire here to acknowledge my indebtedness to all who have kindly assisted me by sending seeds from South Africa.

<sup>1</sup> Marloth, R.: 'A Diplostigmatic Plant,' *Sebaea exacoides*, (L.) Schinz, in Trans. Roy. Soc. of S. Africa, vol. i, pt. 1.

<sup>2</sup> See A. W. Hill in Kew Bull., 1908, pp. 336-40 with Plate.

<sup>3</sup> See Engler und Prantl, iv. 2, p. 87, Figs. D, E, esp. *P. carinthiaca*. Huxley, in his paper on the Gentians in Journ. Linn. Soc., xxiv, pp. 103, &c., refers to the types of corolla, but does not describe the stigmatic arrangements in any of the genera.

<sup>4</sup> A. W. Hill in Kew Bull., 1908, p. 320; Fl. Cap. iv. 1, pp. 1062, 1092. See also p. 487.



Figs. 24, 25) and *S. Thomasii*, and in the Indian species *S. khasiana*, Clarke (Pl. XXXV, Figs. 9–11), the base of the stigma proper is well above the level of the tops of the anthers. In the latter species, however, the stigma and anthers are at the same level, so that self-pollination can easily be effected, and in the *Brevistylae* the short stigma scarcely reaches to the level of the base of the anthers.

Another point which should be noticed in considering the floral morphology of the genus is that almost all the species appear to be markedly protandrous, the anthers opening when the flowers are still in bud. *S. ambigua*, as grown from seed at Kew, appears, however, to be an exception, as the anthers, though mature before the stigma, did not open until the flowers had expanded (Pl. XXXV, Fig. 14).

The flowers throughout the genus are orange-yellow, or white in exceptional cases. The corolla lobes are usually about equal in length to the tube,<sup>1</sup> and they are spread out flat during a bright day. The corolla tube is usually thin-walled and elastic, and is often slightly constricted at the throat. When the ovary begins to swell it is usually closely embraced by the corolla tube.

The anthers are capped in nearly all the species by a small yellow gland, and in some species there are two glands at their base in addition.

In a few species the apical gland is large and nearly black (*S. Thodeana*, &c.).

The anthers, when the flower is open, are conspicuous, and in many species stand clear of the outspread lobes with the style capped by the stigma rising above them. But where the anther filaments are inserted at some distance below the sinuses, or where the corolla lobes do not open so widely, the stamens are more or less included in the corolla tube, and in such a species as *S. Thodeana* (Pl. XXXV, Fig. 25) only the large apical glands of the anther are visible, while in *S. Thomasii* they are included in the tube after the manner of *Exochaenium*. The individual flowers last for two or three days, but they close regularly at dusk, and also when the sky is overcast. With the final withering of the flower there is considerable torsion of the corolla, which may have an important function in self-pollination, as will presently appear.

The peculiar organ or organs of the flowers of *Sebaea* may now be described. It has already been mentioned that, with certain exceptions, the stigma stands well above the tops of the anthers, so that self-pollination is impossible. There are, however, the two swellings on the style below the level of the base of the anthers, and therefore within the corolla tube, which have been found to occur in the large majority of the species of *Sebaea*. Though these swellings have been mentioned by others, their

<sup>1</sup> Huxley (Journ. Linn. Soc., xxiv, p. 109) places the genus in his group *Lissanthe* and the corolla is described as infundibulate.

stigmatic nature does not appear to have been suspected, and it was not until living plants could be examined that these bodies were definitely proved to be efficient stigmas.

In some species the secondary stigmas are much more in evidence than in others, and as a rule they are not well defined in the newly-opened flower. While the flower remains open, however, they become more prominent, and in withered flowers they are often seen to be much enlarged and covered with pollen, which seems to have been brought into contact with the stigmatic surfaces largely by the constriction of the throat of the corolla tube due to torsion. Some pollen, no doubt, is shed on the secondary stigmas when the anthers open in the bud, and may eventually germinate; but it seems probable that the somewhat late development of the lower stigmas may be related to the time of ripening of the terminal stigma, and be so arranged that self-fertilization by way of the lower stigmas shall not take place until the pollination of the terminal stigma has become impossible.

The arrangement of three stigmatic surfaces disposed in this way on the same style is, I believe, unique in the Vegetable Kingdom, and in order to understand their relationship to each other and to the stigmatic arrangements typical of the Gentians, it is necessary in the first place to give a short account of the typical terminal stigma and its modifications. In the simplest cases the terminal stigma would appear to be a bilabiate structure, corresponding to the two carpels, with the stigmatic papillae borne only on the inner surfaces of the lobes. Stigmas of this type are well shown by *S. ambigua* (Pl. XXXV, Fig. 18) and in most specimens of *S. aurea* (Fig. 5). Many species are very variable, and though the bilabiate character is apparent the lips do not as a rule open widely, but are pressed closely together, leaving only a small cleft at the apex. The edges of the stigmatic lobes, however, are often somewhat rolled over, so that there is a fairly large surface exposed over the top of the stigma and down its sides as far as the base of the cleft or primitive lobes.

A further stage is represented by those species in which the stigma is truly clavate and all trace of the bilabiate structure is obliterated, the stigmatic area being more or less disposed in a band passing over the top of the stigma and continued for a certain distance on either side (Pl. XXXV, Figs. 13, 20).

The relation of the primary terminal stigma to the secondary lateral stigmatic areas may now be considered. In most *Sebaeas* the terminal organ is widely separated from the lateral ones, but in a few species the secondary stigmas may be practically confluent with the terminal one, or very close to it. It is the species of the latter type which furnish the clue to the probable origin of the secondary stigmas. The arrangement found in *S. khasiana* is of particular interest, as there is no line of separation between the lobed terminal stigma and the lateral secondary patches, and

it can be seen that the stigmatic tissue is continued down the style from the point of union of the edges of the stigmatic lobes. These two decurrent lines or bands of papillae on opposite sides of the style are thus at right angles to the surfaces of the stigmatic lobes, and undoubtedly represent the first stage in the evolution of the definitely separated secondary stigmas. In this species the apical stigma scarcely projects beyond the anthers, and the decurrent papillate bands merely extend the stigmatic surface to a point slightly below the base of the anthers, being continuous above with the edges of the lobes of the stigma. *S. ovata*, R. Br. (Benth., Fl. Austral., iv,

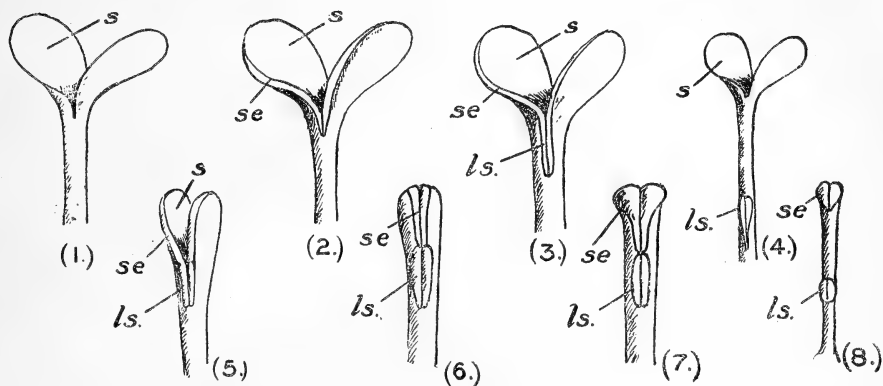

TEXT-FIG. 1. Diagrammatic figures to show the supposed mode of origin of the paired lateral stigmatic patches in *Sebaea*. 1. A simple bilabiate stigma, the inner surfaces of the lobes (*s*) being stigmatic. 2. As Fig. 1, showing the edges of lobes (*se*) recurved and stigmatic. 3. The recurved edges of the terminal stigmatic lobes are continued down the style (*ls.*) as lateral stigmatic areas. 4. The lateral stigmatic patches, consisting of two ridges, have become separated from the terminal stigma. 5. A stigma tending to become clavate by the fusion of the lobes; the edges are recurved and continued down the style as decurrent stigmatic bands. 6. A clavate stigma, the lobes being folded together, the edges forming the stigmatic band over the top of the style and continued below as the lateral or secondary stigmatic patches (*ls.*). 7. A more typically clavate stigma, the lateral patches slightly detached from the terminal stigma. 8. The lateral secondary stigmas (*ls.*) widely separated from the terminal stigma.

p. 371), shows a similar arrangement to *S. khasiana*, and, although the style in this species overtops the anthers, the stigmatic surface is decurrent from the edges of the lobes to the level of the base of the anthers, and the secondary stigmas take the form of twin ridges bearing papillae on each side of the style (Pl. XXXV, Fig. 3). *Sebaea membranacea* (Figs. 22 and 23) and *S. ecarinata*<sup>1</sup> (Figs. 19 and 20), two species found by Professor H. H. W. Pearson during the Percy Sladen Expedition to the Orange River, show the secondary stigmas in close juxtaposition to the apical one, but definitely separated from it as distinct organs. The separation of these patches of stigmatic papillae may thus be regarded as having been effected by the

<sup>1</sup> Gentianaceae in Annals of the S. Afr. Mus., ix, pt. 11, pp. 57, 58. The lateral stigmas in *S. acutiloba*, *S. Zeyheri*, *S. micrantha*, and *S. intermedia* are also nearly confluent with the terminal stigma. See Fl. Cap., iv. 1.

intercalation of a portion of non-papillate stylar tissue in the midst of a stigmatic region, or as being due to the loss of function of a certain amount of stigmatic tissue. In these two species the decussate arrangement of the terminal and lateral stigmatic surfaces can be clearly seen, but in others, where the secondary stigmas are situated about midway between the apex of the style and the ovary, their relation to the primary stigma is not always apparent owing to the torsion of the slender style. As far as can be seen, however, the secondary stigmas are in all cases arranged at right angles to the lobes of the primary one (Pl. XXXV, Figs. 10, 11, 13, 21). The greatest separation in space of the stigmatic surfaces is seen in *S. macrophylla*, where the secondary organs are placed almost at the base of the style. The shape of the paired secondary stigmatic patches varies considerably from elongated pyriform bodies, as in *S. aurea* or *S. ambigua* (Pl. XXXV, Figs. 5–8 and 15, 16, 18), to globular patches, as in *S. imbricata* and *S. compacta* (Pl. XXXV, Figs. 12, 13, and 25).

Whether secondary lateral organs are to be found in every species of the genus is somewhat doubtful, and it is not possible to make a definite pronouncement from the examination of dried material. They could not be detected in either *S. capitata*, *S. sclerosepala*, *S. minutiflora*, or *S. Burckellii*, and in some other species their presence was not always obvious. The difficulty in demonstrating them in these species may perhaps be due to the age of the flowers, since these stigmas tend to develop somewhat late. In the species included in the group *Lageniades*, however, no trace of the secondary stigmas could be found, and it seems probable that they are absent in this group, which, moreover, shows several marked differences from the rest of the genus.<sup>1</sup>

When young the lateral stigmatic patches are narrow simple ridges, formed by the protuberance of larger cells, but by gradual development they enlarge at the edges. They thus become broader, and each patch tends to form two prominent ridges which apparently represent the edges of the two lobes of the primary stigma. In transverse sections, therefore, each lateral patch tends to show a fairly deep median groove (Pl. XXXV, Figs. 3, 11, 17), though in some species, such as *S. imbricata*, the groove can scarcely be noticed.

The stigmatic character of these papillose swellings was further confirmed by the following experiments with the flowers of *S. aurea*, *S. ambigua*, *S. imbricata*, and *S. confertiflora*, which were carried out at the Royal Botanic Gardens. The flower buds were opened before the anthers had burst and shed their pollen, and the apical stigma was removed by a sharp scalpel (Pl. XXXV, Figs. 6–8, 12, 15, 16). In some cases the anthers were also removed, and the flower was left with only the ovary

<sup>1</sup> Marloth, in *Trans. Roy. Soc. S. Afr.*, vol. i, pt. i, pp. 311–14, puts forward the suggestion that all species of *Sebaea* may possess secondary stigmas.

and the lower part of the style bearing the two secondary stigmatic patches.

After the removal of the apical stigma, the secondary stigmas increase very markedly in size, and in *S. aurea* and *S. ambigua* in particular they become so much enlarged that they almost block the throat of the corolla tube.

These organs in flowers so mutilated were then pollinated, when in a receptive condition, with pollen from other flowers. The subsequent increase in size was very marked, and in *S. aurea* they measured 0.75 mm. in length when fully developed after fertilization had taken place, while in *S. ambigua* the development of papillae down the style may take place to such an extent that in several cases the secondary stigmas were found to be as much as 2.5 mm. long (Fig. 16). In almost every instance where the apical stigma was removed and the secondary ones were pollinated, ovules were formed and seeds were eventually ripened. These seeds were found to be capable of germination, and gave rise to a fresh crop of vigorous plants. As the portion of style above the secondary stigmas, left after the removal of the apical stigma, withered up before the secondary stigmas were pollinated, it seems clear that the development of ovules can only be attributed to the pollination of these lateral patches of stigmatic papillae. Good sections of the secondary stigmas are very difficult to obtain, owing to their somewhat spongy nature when well developed, and also to the very slender nature of the style, but in several instances pollen-tubes have been seen not only growing out of the pollen-grain adhering to the papillae, but also penetrating between them into the tissues of the style (Text-fig. 2).

The first experiments in removing the apical stigma were performed with *Sebaea aurea* in July, 1908, and further experiments were made on the other species in the two following years. Control experiments consisted in removing the unburst anthers from flower-buds, to prevent self-fertilization, and in pollinating the upper stigma only, care being taken that no pollen reached the lower secondary stigmas. In these cases the amount of seed produced was small and poor, and was in marked contrast to the quality and amount of that yielded by the ovaries of the flowers mutilated by decapitation of the style. No seed was formed in flowers from which pollen was excluded. It was very noticeable that in flowers in which the anthers were not removed the lower stigmas were covered in due course with their pollen, and the amount is probably augmented, owing to the twisting of the corolla as the flower withers. The function of these secondary stigmatic patches appears, therefore, to be a direct aid to self-fertilization. It is also evident that from their position at the throat of the corolla tube they could quite easily be cross-pollinated by insects who might visit the flower charged with pollen from another source.

The stigma proper crowning the slender style seems somewhat out of the path of the visiting insect, if it be a small one, except in the few species with a relatively short style. As far as can be seen from an

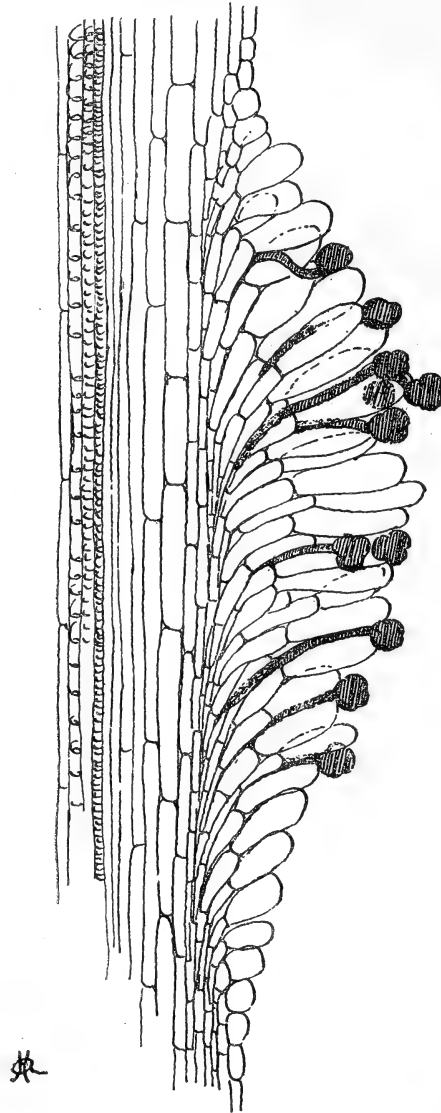

TEXT-FIG. 2. Longitudinal section through one of the secondary patches of *Sebacia aurea*. The terminal stigma had been removed. Pollen-grains are germinating and the tubes growing between the papillae. (Slightly diagrammatic.)

examination of a large number of herbarium specimens the terminal stigma is but rarely pollinated.

Dr. Marloth<sup>1</sup> states that the flowers of *S. exacoides* are visited and

<sup>1</sup> Marloth in Trans. Roy. Soc. S. Africa, vol. i, pt. i, p. 313.

pollinated by a minute thrips, but beyond his observations we know nothing of the insects which may visit the attractive flowers of *Sebaea*s under natural conditions. Should his observations be found to hold good throughout the genus, it would seem probable that the insect adapted to fertilize these flowers may have ceased to visit them, since one assumes that flowers so constructed and so conspicuous should be pollinated by fairly large insects and not by microscopic thrips. The suggestion may also be hazarded that the 'short-circuiting' of the pollination process rendered possible by the development of the secondary stigmas may be regarded in the nature of a response by the plant to its changed biological conditions. It is no doubt the case that these creeping thrips serve as excellent pollen carriers to the secondary stigmas, and that in their winged condition they may take pollen from one flower to another, but it seems very doubtful whether they would pollinate the terminal stigma except under fortuitous circumstances. The genus *Pleurogyne* appears to afford the only comparable case to *Sebaea*. Here the apical stigma is functionless, and self-fertilization is no doubt rendered particularly easy by the stigmatic bands which occur on the sides of the ovary itself (Pl. XXXV, Figs. 1 and 2).

The floral arrangements in *Sebaea* might be described as an illegitimate and condensed form of heterostylism, since, though stigmas are provided at two different levels, there is no corresponding arrangement of anthers differing in length; self- rather than cross-fertilization would thus appear to be the object in view. Whether a case of true heterostylism exists in *Sebaea* is somewhat uncertain with our present knowledge, but it seems not improbable that *S. Thodeana*, Gilg.,<sup>1</sup> and *S. spathulata*, Steud., may represent the long and short styled forms respectively of one and the same species (Pl. XXXV, Figs. 24 and 25).

The specimens are very similar in general appearance, and the anthers, with their large black apical glands, are identical in structure; moreover, they have been gathered in the same localities. Should this supposition prove to be correct, *S. spathulata* will stand as the name for the dimorphic species.

The only other aberrant species of the genus, with a style shorter than the anthers, is *S. Thomasii*,<sup>2</sup> a very distinct species. It may conceivably be conspecific with *S. Marlothii*, though this supposition is open to grave doubt because the two species are somewhat dissimilar as regards their vegetative characters. There is also, on the other hand, the possibility that the long-styled form of *S. Thomasii* may not yet have been discovered.

The genus *Exochaenium*,<sup>3</sup> which is closely related to *Sebaea*, is of interest in this connexion, since in *E. grande* long-styled, short-styled, and

<sup>1</sup> Fl. Capensis, iv, 1, pp. 1091, 1092, and Kew Bull., 1908, p. 334.

<sup>2</sup> l. c., p. 1902, and Kew Bull., 1908, p. 335.

<sup>3</sup> See Kew Bull., 1908, pp. 336-41 with plate.

homo-styled flowers are to be found, whereas in other species the flowers may be either dimorphic or of only one type.

#### SUMMARY.

The genus *Sebaea*, which contains about 100 species, is diplostigmatic, that is to say, in addition to the apical stigma, secondary stigmatic patches are borne on the style below the level of the anthers in nearly all the species examined.

The secondary stigmas, which are placed at right angles to the lobes of the apical stigma, appear to represent the lower part of the edges of these lobes, which have become separated from the apical stigma by the intercalation of a non-papillated portion of stylar tissue.

The flowers of *Sebaea* are protandrous and the anthers open in the bud; the pollen is thus shed on the secondary stigmas which are situated about the level of the throat of the corolla. Self-fertilization can thus be effected without difficulty, though cross-fertilization is not precluded.

As a result of the artificial pollination of these secondary stigmas, after removal of the apical stigma in the bud, seeds were formed from which plants have been raised. Fewer and poorer seeds were formed as a result of pollinating the terminal stigma alone.

It is suggested that the peculiar condition of these flowers may be compared to an abbreviated type of heterostylism modified to ensure self-rather than cross-pollination. Cases of peculiar types of stigmatic arrangement in other genera of this Family are mentioned, and in particular the normally heterostyled genus *Exochaenium*. It seems not unlikely that heterostylism may be proved to exist in at least one species of *Sebaea*.

---

#### EXPLANATION OF PLATE XXXV.

Illustrating Mr. A. W. Hill's paper on the genus *Sebaea*.

The figures, with the exception of Figs. 3-8 and 16-17 have been drawn by Miss M. Smith.

The names and numbers in brackets refer to the specimens preserved in the herbarium of the Royal Botanic Gardens, Kew, from which the drawings were made.

Fig. 1. *Pleurogyne carinthiaca*, G. Don (Ellis, 357), showing one of the stigmatic bands. There is no stigma proper.  $\times 3$ .

Fig. 2. The same (Aitchison, 33), showing the two stigmatic bands on the ovary walls.  $\times 6$ .

Fig. 3. *Sebaea ovata*, R.Br. The terminal stigma is bilabiate, and there are two decurrent bands of stigmatic papillae continued down the style from the edges of the terminal stigma.



Fig. 4. *S. leiostyla*, Gilg. The median portion of a style taken from a bud, showing the undeveloped lateral stigmatic patches.

Figs. 5-8. *S. aurea*, R.Br.

Fig. 5. The style and ovary. The terminal stigma is bilabiate, and a pair of lateral stigmatic patches occur halfway down the style.

Fig. 6. One of the pyriform lateral stigmas.

Fig. 7. A style from which the terminal stigma has been removed. The lateral stigmas are 0.75 mm. in length.

Fig. 8. The lateral stigmas after pollination, much enlarged with conspicuous papillae.

Figs. 9-11. *S. khasiana*, C. B. Clarke (Ducloux, 316).

Fig. 9. The flower dissected, showing the relative positions of anthers and stigmas.  $\times 3$ .

Figs. 10 and 11. The apex of the style. The terminal stigma (*s.*) and lateral stigmatic patches (*ls.*) are almost confluent.

Figs. 12 and 13. *S. imbricata*, A. W. Hill (Burt Davy, 7747 c).

Fig. 12. The terminal stigma has been removed and the lateral patches, which have been pollinated, have increased largely in size.

Fig. 13. The complete style, showing the terminal capitate-clavate stigma and secondary lateral stigmas.

Figs. 14-18. *S. ambigua*, Cham.

Fig. 14. A complete flower, showing the terminal bilabiate stigma standing well above the anthers. The secondary stigmas are situated at the throat of the tube just below the base of the anthers.

Fig. 15. The secondary stigmas made up of three much developed bands of papillae spirally twisted. The terminal stigma has been removed.

Fig. 16. Elongated secondary stigmas 2.5 mm. long.

Fig. 17. A cross-section of Fig. 16, showing that each secondary stigmatic patch is made up of two ridges of stigmatic papillae.

Fig. 18. A complete style with bilabiate terminal stigma and enlarged secondary patches.

Figs. 19 and 20. *S. ecarinata*, A. W. Hill (Pearson, 5229).

Fig. 19. The flower dissected, showing the relative positions of stigmas and anthers.  $\times 5$ .

Fig. 20. The style and ovary. The secondary stigmas are only slightly separated from the terminal stigma.

Fig. 21. *S. compacta*, A. W. Hill (Bolus, 12,992). The style and ovary in different positions, showing clearly that the secondary stigmas are at right angles to the terminal stigma.

Figs. 22 and 23. *S. membranacea*, A. W. Hill (Pearson, 5881).

Fig. 22. The style and ovary; the secondary stigmas are almost confluent with the terminal stigma.

Fig. 23. The flower dissected to show the relative positions of the stigmas and anthers.  $\times 5$ .

Fig. 24. *S. spathulata*, Steud. (Flanagan, 2080). A flower dissected to show the long corolla tube, the anthers with their large apical glands, and the short style.  $\times 2$ .

In some specimens (e. g. Guthrie, 4881) there is a much longer corolla tube, and the style seems to show lateral stigmatic patches confluent with the terminal stigma.

Fig. 25. *S. Thodeana*, Gilg (Bolus, 8216), a flower dissected. The style is crowned by a terminal stigma above the level of the tops of the anthers. The anthers are capped by large glands.  $\times 2$ .



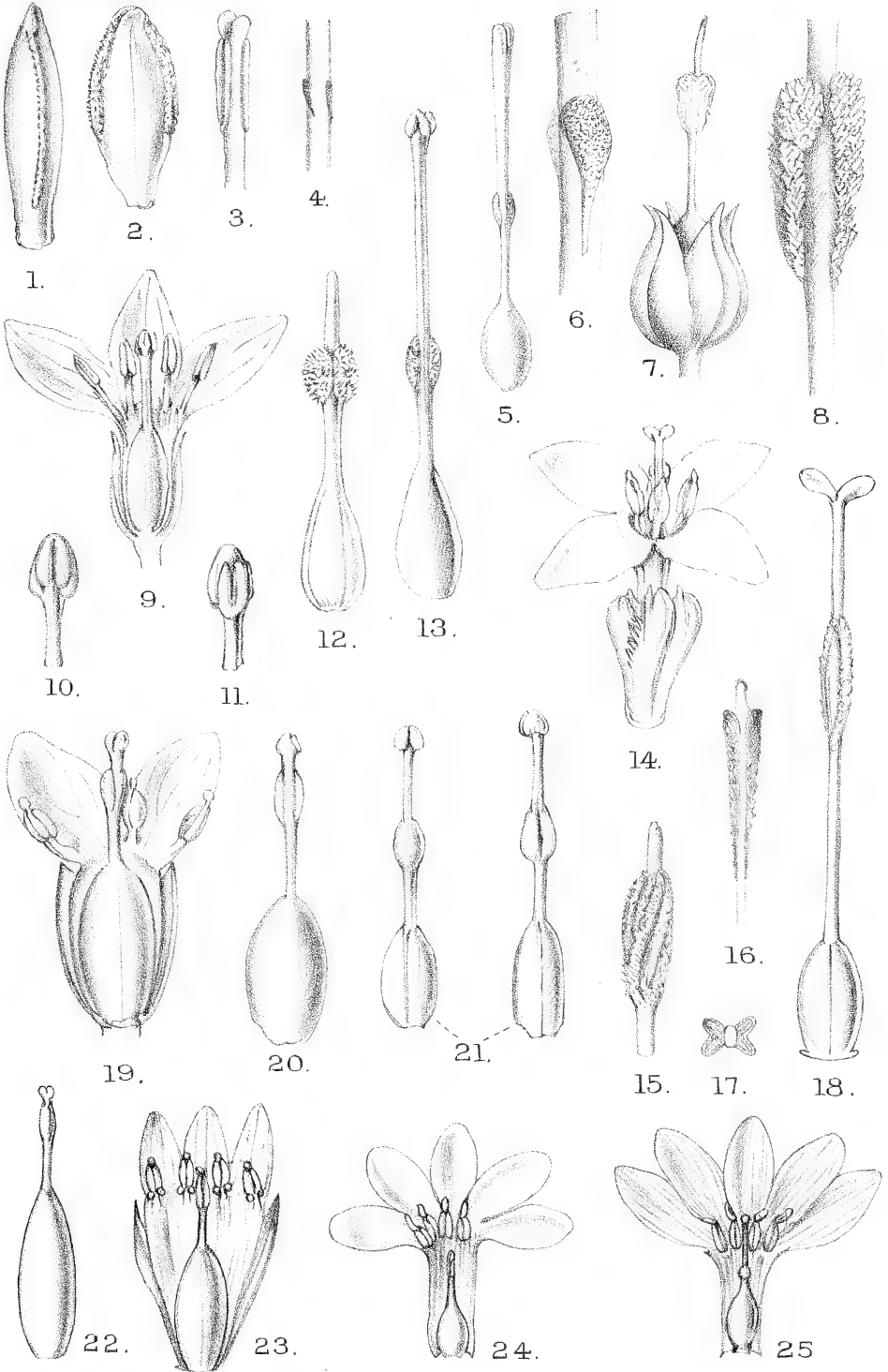

M. Smith del.

Huth lith et imp.



# On the Structure of the Androecium in *Parnassia* and its bearing on the Affinities of the Genus.

BY

AGNES ARBER, D.Sc., F.L.S.

*Fellow of Newnham College, Cambridge.*

With Plate XXXVI and four Figures in the Text.

## CONTENTS.

	PAGE
I. Introduction . . . . .	491
II. The Anatomy of the Androecium in <i>Parnassia</i> . . . . .	492
(i) The Anatomical Relation of the Androecium to the other Whorls of the Flower in <i>Parnassia palustris</i> , L. . . . .	492
(ii) The Anatomy of the Stamens in <i>Parnassia palustris</i> , L., and other species . . . . .	494
(iii) The Anatomy of the Nectaries in <i>Parnassia palustris</i> , L. . . . .	497
III. A Suggested Interpretation of the Mesarch Structure in the Stamen-filaments of <i>Parnassia</i> . . . . .	497
IV. Discussion of the Affinities of <i>Parnassia</i> . . . . .	500
V. Summary . . . . .	509
Explanation of Plate XXXVI . . . . .	510

## I. INTRODUCTION.

FIVE years ago, in the course of an examination of the anatomy of the stamens of various Dicotyledons, I cut some serial sections of flowers of *Parnassia palustris*, L., which had been collected in Middleton Dale, Derbyshire. I was immediately struck by a curious feature in the anatomy of the filament, namely, the occurrence of centripetal xylem in connexion with the single xylem strand which traverses it. At the time I was unable to arrive at any explanation of this peculiarity, so I laid the subject aside. More recently, however, a possible interpretation of this structure has suggested itself to me, and, since this interpretation appears to have some bearing on the vexed question of the systematic position of the genus *Parnassia*, I have thought it worth while to describe my observations in the present paper, and to discuss certain theoretical views connected with them.

I have much pleasure in expressing my gratitude to Mrs. Henshaw for her great kindness in collecting, on my behalf, a large number of specimens of three species of *Parnassia* in the Canadian Rocky Mountains.

I have also to thank Mr. George Goode, Miss Ida Roper, F.L.S. and Dr. Vigurs, to whom I am indebted for supplies of *Hypericum Elodes*.

In examining the anatomy of flowers, in cases where herbarium material alone is available, I have obtained good results by boiling, treating with medium chromacetic acid for 48 hours, and then washing and dehydrating in the usual way. When such material is to be microtomed, it seems important to make the passage from xylol into paraffin a very gradual one. When whole flowers are used, it is an advantage to keep them immersed in paraffin for an unusually long period—even as much as three weeks—in order to ensure good penetration. Material treated in this way stains well with the Bismarck brown, gentian violet, and orange combination.

This investigation, which was originally begun at University College, London, has been completed at the Balfour Laboratory, Cambridge. I am indebted to the Balfour Laboratory Committee for giving me all facilities for my work.

## II. THE ANATOMY OF THE ANDROECIUM IN PARNASSIA.

### (i) *The Anatomical Relation of the Androecium to the other Whorls of the Flower in PARNASSIA PALUSTRIS, L.*

The structure of the androecium of *Parnassia* is more easily followed when the general vascular symmetry of the flower is understood, and it may hence be well to begin with an outline of the anatomy as a whole. So far as I am aware, the only contribution to this subject, up to the present, is Eichinger's<sup>1</sup> observation that in *P. palustris* the staminode bundles are connected with the petal bundles. I can confirm this statement, as will be seen from the following account.

In the four species which I have examined (*P. palustris*, L.; *P. fimbriata*, Banks; *P. montanensis*, Fern. et Rydb.; and *P. parviflora*, DC.) there are generally three arcs of vascular tissue in the pedicel below the base of the flower (Text-fig. 1, A), although, especially in *P. fimbriata*, it is not unusual to find a closed ring instead of three detached arcs. The mode of origin of the bundles destined for the different whorls is naturally somewhat complicated, since none of these whorls are trimerous, and yet they are all supplied from the *three* pedicel strands. The process, which I have followed in detail in the case of three flowers of *Parnassia palustris*, is represented diagrammatically in Text-fig. 1, in which the strands destined for the gynaecium are omitted. Slight variations occur, due, apparently, to the fact that one of the three pedicel strands may be smaller than the others, and hence may take less part in providing for the flower, but in all essentials the scheme proved to be identical in each of the cases examined. The

<sup>1</sup> Eichinger, A.: Beitrag zur Kenntnis und systematischen Stellung der Gattung *Parnassia*. Beihefte zum Bot. Centralblatt, Bd. xxiii, Abth. ii, 1908, p. 303.

three arcs fuse and branch in such a way as to form a five-pointed hollow star (Text-fig. 1, B). Each of the three arcs is responsible for one entire arm of the star—two of them each give rise, in addition, to half an arm—while the third produces two half-arms which fuse with those derived from the neighbouring arcs. Each arm of the star gives rise to two bundles, lying on the same radius of the axis (Text-fig. 1, C). The inner strand is destined for a stamen, while the outer, which branches into three as it nears the surface, will supply a sepal (Text-fig. 3, H). Another set of five bundles is given off from between the arms of the star. Each of these bundles, at a slightly higher level, also divides into two strands on the same radius, of which the outer enters a petal and the inner a nectary. In Text-fig. 3, G, the separation of petal and staminode (nectary) bundles is seen occurring in the

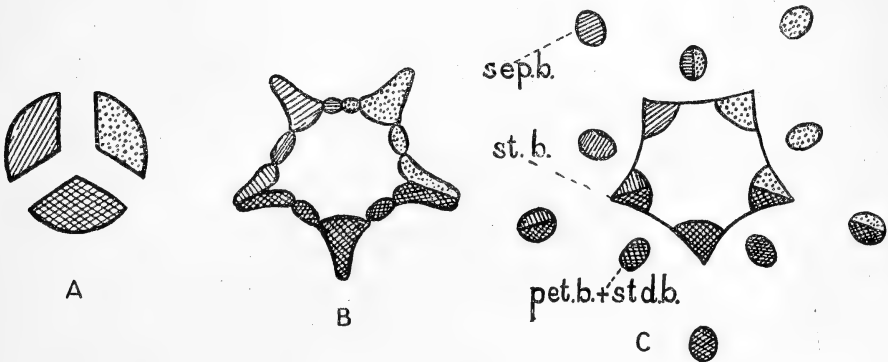

TEXT-FIG. 1. Diagrams to show the origin of the vascular bundles of the androecium in *Parnassia palustris*, L. A. Transverse section of the vascular system in the pedicel below the flower. The three arcs of vascular tissue are shaded differently, so that the part which they play may be followed in the succeeding diagrams. B. Transverse section of the vascular system at the extreme base of the flower, showing the three arcs uniting and branching to supply the strands for the different whorls. C. Transverse section of the vascular system at a slightly higher level than B. (*sepal bundle* = sepal bundle; *stamen bundle* = stamen bundle; *petal bundle + staminode bundle* = the bundle which, at a slightly higher level, will divide into a petal bundle externally and a staminode bundle internally.) In B and C the strands which supply the gynaecium are omitted.

case of the N. and N.E. petals. The remaining three petals have already become entirely detached from the axis, and their vascular system has undergone its primary division into three, followed, in the case of the S.W. petal, by further branching.

It will be noticed that the stamen bundles become free from the sepal bundles at a level below that at which the staminode bundles separate from the petal bundles. We are thus able to confirm, on anatomical grounds, the conclusion reached by Drude from a study of the development of the flower—namely, that the staminodes (or nectaries) are to be regarded as representing the internal whorl of the androecium, although, in the mature flower, there is no outward indication of this fact.

In Text-fig. 1 the strands which supply the carpels are not represented, since it is only the androecium with which we are particularly concerned.

For the sake of completeness, however, we will now briefly indicate how the vascular bundles for the gynaecium arise. It will be simplest, in the first place, to describe an individual case, since there is some variation in detail. At about the level represented in Text-fig. 1, B, or a little higher, two or three branches arose on the inner side of the vascular star, and, by their fusion, supplied the ovary with a small central group of vascular tissue. This group eventually branched, and the branches distributed themselves among the four placentas, where they formed *lateral* bundles. Then, at about the level of Text-fig. 1, C, or a little higher, the four bundles, which enter the septa and eventually form the *main* placental bundles, were given off internally from four of the five stamen bundles, while the fifth stamen bundle and three of the staminode bundles produced, as internal branches, the four strands which occupy a median position outside each loculus. In a second flower, on the other hand, these four bundles were all produced from staminode bundles, instead of one being derived from a stamen strand. In the third example, one of these loculus bundles was derived from a stamen bundle, two from staminode bundles, while the fourth arose between a stamen and a staminode strand before they had separated from the central vascular star. In this flower, also, one of the main placental bundles arose from a staminode strand, though the remaining three were connected, as in other cases, with stamen strands.

There is thus considerably more irregularity in the origin of the vascular supply of the gynaecium than in that of the other whorls. This is probably connected with the fact that there are only four carpels, and, consequently, the bundles which supply them cannot be symmetrically related to those of the remaining whorls of the flower, which are all pentamerous.

(ii) *The Anatomy of the Stamens in PARNASSIA PALUSTRIS, L., and other Species.*

Even before the stamen bundles leave the axis they show a highly anomalous structure. Their xylem, instead of consisting of a single group of elements, takes the form, as seen in transverse section, of a more or less completely closed ring. I have detected this anomaly, in more than one case, immediately after the stamen bundle had given off its branch to the gynaecium: in other words, this peculiarity arises at the very level at which the stamen bundle becomes a completely independent unit. The exact details of the structure of the strand cannot be made out while it is still in the receptacle, owing to the oblique course which it follows, but when it enters the filament it can be studied with ease.

As shown in Pl. XXXVI, Fig. 1, the xylem is ring-like in section and encloses a patch of thin-walled parenchymatous tissue. Small elements, which have the characteristic appearance of protoxylem, are attached internally to the dorsal side of the ring. That they are, in fact, protoxylem



tracheides is proved by radial longitudinal sections, in which they are easily distinguished by their spiral thickenings, which have undergone great stretching (Pl. XXXVI, Fig. 2, *px*). In this longitudinal section also, as in the transverse section, the protoxylem is seen to be attached to the normal centrifugal xylem and separated from the centripetal elements by parenchyma.

Returning to the transverse section (Pl. XXXVI, Fig. 1), we notice that the xylem is surrounded at a little distance by a number (about ten) of small groups of elements which appear to represent phloem.

We do not find the ring-structure completely developed in the xylem of every filament of *Parnassia palustris*, nor is it continuous throughout every individual filament in which it occurs. Typical deviations are shown in Pl. XXXVI, Figs. 3 and 4, which represent the variations in structure in different regions of a filament which, for a short distance near the base, possessed a continuous ring of xylem resembling that shown in Pl. XXXVI, Fig. 1. In Pl. XXXVI, Fig. 3, we have an incomplete ring broken on the ventral side, while in Pl. XXXVI, Fig. 4, it is broken laterally, so that the centripetal and centrifugal xylem are entirely separated. In other cases the ring is broken both dorsally and ventrally.

The mesarch structure, which we have been discussing, is retained to the top of the filament. When the bundle enters the connective, however, its organization undergoes a change. The xylem increases in amount and begins to branch. The branches remain attached to one another for a short time, but ultimately separate into a number of distinct strands, so that, in the middle region of the connective, there is a considerable xylem complex (Pl. XXXVI, Fig. 5). It is difficult to count the exact number of strands, since there is often no definite limit between them, but there are certainly sometimes as many as ten. The xylem is embedded in and surrounded by cells rich in contents, among which a certain number of elements which suggest phloem can be distinguished. Higher up in the connective the branches gradually die out, and the dwindling vascular complex is eventually reduced until it consists only of a single small xylem group, which disappears before the extreme tip of the anther is reached.

The description so far given applies to young flowers in which the anthers are still retained. When we examine the filaments of old stamens, which have shed their pollen and lost their anthers, we find that the xylem-ring in the filament has become more massive by the outward spread of lignification, and that the internal tissue, parenchyma, and protoxylem have been torn, presumably in the course of the elongation which the filament undergoes when the pollen is about to be shed.

I have found the mesarch structure, which I have described, in the filaments of *Parnassia palustris* from more than one locality. I have also examined the flowers of three other species—*P. fimbriata*, Banks; *P. monta-*

*nensis*, Fern. et Rydb.; and *P. parviflora*, DC. These species all belong, according to Drude's<sup>1</sup> classification, to the same Section (*Nectarodrosion*) of the genus as our native *P. palustris*. I have been unable to obtain material of representatives of Drude's other Sections. It is possible, however, that *P. fimbriata* is not very closely related to *P. palustris*; Eichinger<sup>2</sup> has suggested that, on account of the anomalous form of its nectaries (see Text-fig. 2, B, C), it should be removed from the Section *Nectarodrosion*.

In *Parnassia fimbriata* the vascular tissue is more highly developed than in *P. palustris*. There is a tendency to the formation of a closed ring of xylem and phloem in the peduncle below the flower, instead of three detached arcs. In one flower which I examined, the branch of vascular tissue, formed to supply each sepal and stamen, also arranged itself into a hollow ring almost as soon as it became free from the main vascular ring.

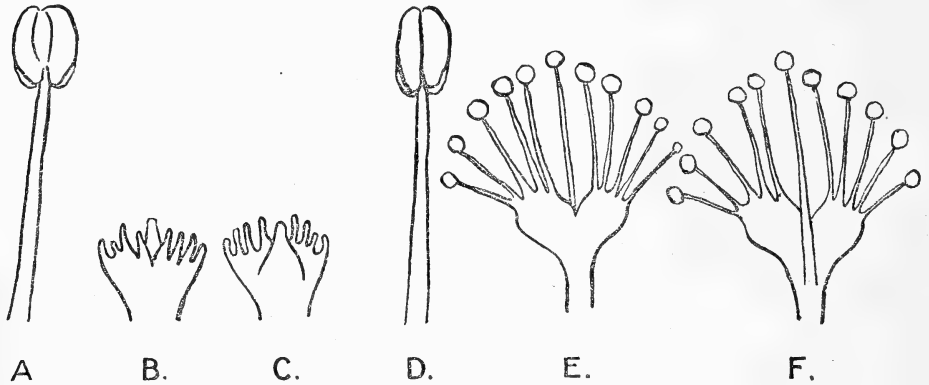

TEXT-FIG. 2. A, B, C. *Parnassia fimbriata*, Banks. A, stamen (outer side); B, nectary (outer side); C, nectary (inner side). D, E, F. *Parnassia palustris*, L. D, stamen (outer side); E, nectary (outer side); F, nectary (inner side).

It consisted of internal xylem and external phloem surrounding a patch of parenchyma. As it passed outwards it divided into two rings, a small one on the axial side, destined for a stamen, and a much larger one, on the outer side, destined for a sepal. This large ring entered the midrib of the sepal, but, as the lateral veins were given off, it became gradually reduced to a single bundle. The ring-structure of the stamen bundle was retained throughout the filament as far as the base of the anther. In the connective there was a xylem complex, not, however, consisting of so many groups of xylem as in *P. palustris*. We thus see that *Parnassia fimbriata* shows similar peculiarities to *P. palustris* in the anatomy of the stamen.

*Parnassia montanensis* has a slenderer stamen than either of the two species just discussed. In accordance with this we find that the vascular

<sup>1</sup> Drude, O.: Ueber die Blüthengestaltung und die Verwandtschaftsverhältnisse des Genus *Parnassia*. *Linnaea*, Bd. xxxix, 1875, p. 301.

<sup>2</sup> Eichinger, A.: l. c., p. 307.

tissue of the filament is relatively reduced. The small bundle contains, as a rule, about a dozen xylem elements arranged in a compact circular group. There is no ring-structure, but we can sometimes detect the occurrence of smaller elements in the centre of the group. If, as seems probable, these elements are protoxylem, the bundle may be regarded as mesarch—corresponding, that is, to that of *P. palustris*, but in a reduced form.

*Parnassia parviflora* is still further reduced. The small filament contains a little group of xylem elements (sometimes about eight), but the protoxylem cannot be distinguished.

(iii) *The Structure of the Nectaries in PARNASSIA PALUSTRIS, L.*

Drude<sup>1</sup> has shown that, if a section be cut across the leaf-like expansion of a nectary of *Parnassia palustris*, it is seen to be traversed by a number of separate bundles, each of which is destined to pass into one of the glandular branches. I have found that these bundles retain their distinctness down to the level at which the staminode fuses with the receptacle (Text-fig. 3, F). As they pass inwards they unite into a single bundle, whose origin has been already discussed. Little detail can be made out in the vascular structure of the nectary in this species, since the bundles are practically unligified. Eichinger<sup>2</sup> has shown, however, that these unligified strands may safely be interpreted as vascular bundles, since, in *P. viridiflora*, Batal., vessels occur in the strands which are directed towards the lobes of the nectary.

III. A SUGGESTED INTERPRETATION OF THE MESARCH STRUCTURE IN THE STAMEN-FILAMENTS OF PARNASSIA.

The occurrence of centripetal xylem in connexion with the single vascular bundle which traverses each filament in *Parnassia palustris* and *P. fimbriata* is a peculiarity which seems to call for some explanation, since it diverges remarkably from the simple collateral structure which is usually to be found in stamen bundles. In general, centripetal wood may be regarded as an essentially cryptogamic character,<sup>3</sup> which has scarcely survived at all among the Phanerogams. It seems manifestly absurd, however, to regard the isolated case of its occurrence in *Parnassia* as a vestigial trait, recalling some remote cryptogamic or gymnospermous ancestor.

The occurrence of mesarch vascular strands is extremely rare among the Higher Plants, and it is probable that there is no general explanation for the phenomenon, but that each case must be dealt with separately, on its own merits. E. M. Berridge has shown,<sup>4</sup> for instance, that certain curious,

<sup>1</sup> Drude, O. : l. c., p. 260.

<sup>2</sup> Eichinger, A. : l. c., pp. 308 and 309.

<sup>3</sup> Scott, D. H. : The Old Wood and the New. New Phyt., vol. i, 1902, p. 25.

<sup>4</sup> Berridge, E. M. : Note on the Mesarch Structure of certain Vascular Bundles in the Cotyledons of some Scitamineae. Ann. Bot., vol. xxiv, 1910, p. 485.

mesarch strands in the sucking cotyledons of the Scitamineae can be fully explained when their relation to the cortical vascular system is understood. The mid-rib bundle of the cotyledon of *Persoonia lanceolata*, described by T. G. Hill and E. de Fraine,<sup>1</sup> furnishes another example. Here the bundle is normally formed, but is accompanied by extra xylem elements, which sometimes give it almost a mesarch appearance. The authors, however, interpret these elements as transfusion tracheides, and regard them as adaptations to supply the physiological needs of a xerophytic seedling.

Turning again to the case of *Parnassia*, we find ourselves confronted with the question whether the mesarch structure in this case is merely adaptive as in *Persoonia*. I am inclined to think that this alternative may be dismissed, since there seems, in this instance, to be no sufficient reason for the development *de novo* of such an anomaly.

We have rejected the idea that the mesarch xylem of *Parnassia* is reminiscent of a pre-Angiospermic ancestor. Nevertheless, it is not improbable, on general grounds, that this structure possesses some phylogenetic significance in connexion with the more modern ancestry of the genus. Vascular strands have a strong tendency to form, as it were, an internal record of ancestral features, even when these have become almost entirely obliterated as far as external form is concerned. When evolution proceeds in the direction of reduction, vascular structure generally, though not always, lags behind the outward form, and becomes diminished to vanishing point at a less rapid rate than the surface features. In other words, when an organ is becoming rudimentary and is on the point of disappearing, the branches of vascular tissue which formerly supplied it are generally still traceable, though they may be reduced to mere stumps. This idea is present, though it is not definitely formulated, in the writings of Robert Brown<sup>2</sup> as early as 1833. Brown observed vessels in the 'auriculae' of certain Orchids, which were regarded on other grounds as representing abortive members of the androecium. These members were no longer recognizable as stamens externally, but the vascular bundles, which were intended to supply them, retained their original course, although their function was a thing of the past.

A particularly interesting instance of the survival of vestigial bundles, when the organ, which they are intended to supply, has become almost entirely obliterated, has been described by E. M. Berridge<sup>3</sup> in the case of

<sup>1</sup> Hill, T. G., and de Fraine, E.: On the Influence of the Structure of the Adult Plant upon the Seedling. *New Phyt.*, vol. xi, 1912, p. 319.

<sup>2</sup> Brown, R.: On the Organs and Mode of Fecundation in Orchideae and Asclepiadeae. *Trans. Linn. Soc. Lond.*, vol. xvi, 1833, pp. 697, 698.

<sup>3</sup> Berridge, E. M.: The Structure of the Female Strobilus in *Gnetum Gnemon*. *Ann. Bot.*, vol. xxvi, 1912, p. 990. (It should be noted that Miss Berridge does not herself accept the generalization that, in the process of reduction of an organ, traces of its vascular system survive, even at the stage at which its external features are practically obliterated. She writes, 'In the process of reduction the vascular bundles seem usually to dwindle and disappear before the organ itself is lost,

the female flower of the Oak. In this author's words: 'In some cross-sections of a young flower the stamens were found to be represented by small outgrowths alternating with the stigmatic lobes. Just below these minute outgrowths, small branches from the vascular bundles supplying the perianth end in little irregular masses of reticulately thickened cells. In another flower of about the same age, the outgrowths are absent, but the small branch bundles persist.'

From a consideration of the cases just quoted, it may, I think, be conceded that there is at least a possibility that the anomalous vascular structure of the *Parnassia* stamen may be explicable on phylogenetic grounds. The peculiarities of the bundle appear to suggest that the vascular system of the filament may have had a compound origin. The numerous strands in the connective, the centripetal xylem in the filament, with the accompanying indications of numerous phloem groups, point to the existence of vestigial vascular strands, now closely associated with the main bundle, but perhaps, ancestrally, totally distinct from it.

The suggestion I wish to put forward, in order to account for these facts, is that the structure of the stamen of *Parnassia* is best interpreted as a reduction-stage from a phalange of stamens, such as that which is found in *Hypericum* among the Hypericineae.<sup>1</sup> The staminode of *Parnassia* has already been explained on these lines,<sup>2</sup> but, since the fertile stamens show no external sign of being compound structures, the theory has not, so far as I am aware, ever before been extended so as to include them. In certain species of *Hypericum* the number of stamens in each fascicle is very small; in *H. virginicum*, L.,<sup>3</sup> for instance, there are only three. *H. Elodes*, Huds., has the smallest number of stamens of any British St. John's Wort, and, as the filaments are also united for a considerable part of their length, it is the most suitable species with which to compare *Parnassia*.

Text-fig. 4 (B-E) shows transverse sections of the essential organs of a flower of *Hypericum Elodes*, in which the stamen-phalanges consisted of five, five, and three members respectively. It will be noticed that most of the vascular bundles in the common filaments preserve their identity to the extreme base (Text-fig. 4, E and F, *c.f.*). Both in *H. Elodes*, and in two species of *Hypericum* with numerous stamens in the phalange, I have found that the bundles intended for each individual stamen pass, as a rule, separately from the receptacle into the common filament. This strengthens the analogy with the *Parnassia* stamen, since here the centripetal xylem is

as in the case of the perianth of the male flower of *Ephedra* or the abortive ovule of that or *Welwitschia*?)

<sup>1</sup> The question whether the stamen-fascicles of *Hypericum* are due to chorisis of single stamens, or to the fusion of originally free and numerous stamens, does not affect the present argument, and will not be discussed here.

<sup>2</sup> Lindley, J.: The Vegetable Kingdom, London, 1846, p. 405.

<sup>3</sup> Gray, Asa: Genera Florae Americae Boreali-Orientalis, vol. i, Boston, 1848, Pl. 94.

recognizable long before the bundle leaves the axis. This centripetal xylem I regard as representing vascular strands originally destined for super-numerary anthers, which have now entirely vanished. The numerous bundles of the staminode, also, remain free to the base and enter the axis separately, agreeing in this point with the stamen bundles of *Hypericum*.

It may be asked why it should be supposed that vestigial vascular strands have been retained in the *Parnassia* stamens, instead of being entirely obliterated. I think the answer may possibly be that they owe their survival to their conversion to a secondary use—an occurrence that is not uncommon in the case of vestigial structures.<sup>1</sup>

The stamens of *Parnassia* execute remarkable movements, each in turn elongating, so as to bring the anther into a position above the immature stigmas, and then bending outwards and downwards after shedding its pollen.<sup>2</sup> The addition of the internal xylem helps to convert the wood of the main bundle into a slender hollow cylinder, which may have proved of some value in giving the filament certain additional qualities of strength and elasticity.

#### IV. DISCUSSION OF THE AFFINITIES OF PARNASSIA.

The structure and affinities of the genus *Parnassia* have been admirably discussed by Drude<sup>3</sup> in an exhaustive monograph published in 1875. The conclusion at which he arrived was that *Parnassia* was best placed in the special family Parnassieae, included in the large and complex 'Nexus Saxifraginae', but forming a transition between this nexus and the Droseraceae, on the one hand, and the Hypericineae, on the other. He regarded the affinity with the Hypericineae as less close than that with either the Saxifragaceae or the Droseraceae. Since I find myself in general agreement with this conclusion, and with the majority of the arguments on which it is based, I do not propose to attempt an exhaustive discussion of the whole question of the affinities of *Parnassia*.

The relation between *Parnassia* and the Droseraceae was dealt with very fully by Drude from the standpoint of external morphology. More recently the subject has been reopened by Eichinger<sup>4</sup> and by Pace.<sup>5</sup> The latter author has obtained fresh evidence by the use of modern cytological methods. From a detailed study of the embryo-sac and

<sup>1</sup> As Darwin points out, the style of the male florets of some Compositae remains well developed although the ovary and stigmas are abortive. This is supposed to be due to the fact that it has retained its secondary function of brushing the pollen out of the anther-tube, though it has lost its primary function of conducting the pollen-tube to the ovule. The Origin of Species, sixth ed., London, 1894, p. 373.

<sup>2</sup> Gris, A.: Sur le mouvement des étamines dans la Parnassie des marais. Comptes rendus, vol. lxxvii, 1868, p. 913.

<sup>3</sup> Drude, O.: Ueber die Blüthengestaltung und die Verwandtschaftsverhältnisse des Genus *Parnassia*. Linnaea, Bd. xxxix, 1875, p. 239.

<sup>4</sup> Eichinger, A.: l. c.

<sup>5</sup> Pace, L.: *Parnassia* and some Allied Genera. Bot. Gaz., vol. liv, 1912, p. 306.

embryo in *Parnassia*, *Saxifraga*, and *Drosera*, she concludes that *Parnassia* is much more closely related to the Droseraceae than to the Saxifragaceae. Eichinger, however, who deals with the subject on broader grounds, recommends that *Parnassia* shall not be removed to the Droseraceae, but shall be retained in the Saxifragaceae, an order which, as at present constituted, can claim little unity. The conclusion to be drawn from previous work on this point seems to be that there is an undeniable affinity between *Parnassia* and the Droseraceae. As the subject has been so fully dealt with by other writers, I shall not enter upon it here, and in the following discussion, which is merely supplementary to Drude's memoir, I shall confine myself to the subject of the connexion between *Parnassia* and the Saxifragaceae and Hypericineae respectively.

I am inclined to think that too much stress has often been laid by systematists upon the affinity of *Parnassia* with the Saxifragaceae, with the result that the other relationships of the genus are apt to be overlooked. Both Bentham and Hooker in the 'Genera Plantarum', and Engler in the 'Pflanzenfamilien', place *Parnassia* in the Saxifragaceae, so that these botanists do not convey, by means of its systematic position, the idea that the genus is an isolated one with affinities with several families. I am far from wishing to deny that *Parnassia* is related to the Saxifragaceae, but at the same time I think it should be realized that certain of the arguments, which appear to have been most powerful in convincing botanists of the validity of this relationship, are rather plausible than sound.

Hooker and Thomson,<sup>1</sup> in 1858, described several new species of *Parnassia* from India, and after discussing various reasons for relating them to the Saxifragaceae, they add that certain alpine species of these two genera have 'a habit so similar, that when in the Himalaya, their close affinity appeared to us self-evident'. This argument from agreement of habit is a somewhat dangerous one; the similarity in form might perhaps equally well be regarded as due to similar modifications in vegetative structure brought about in response to alpine conditions. There are analogous cases in the European Alps; for example, certain 'cushion plants' belonging to widely different families (such as *Draba pyrenaica*, L., of the Cruciferae and *Androsace glacialis*, Hopp., of the Primulaceae) resemble one another so closely as to be easily confused at first sight. It is a mere commonplace to point out that there are many other cases of deceptive resemblance in vegetative structure between plants of unrelated orders, such as between certain Cactaceae and the succulent Euphorbias of South Africa, and again, between the shoots of *Veronica cupressoides*, Hook. f., and the twigs of Cypress.

The abbreviated stem of the Parnassias bears petiolate 'radical' leaves;

<sup>1</sup> Hooker, J. D., and Thomson, T. : Praecursores ad Floram Indicam. Journ. Linn. Soc. Bot., vol. ii, 1858, p. 54.

which are not infrequently ovate, often with a cordate or reniform base. It is true that this type of 'radical' leaf can be closely paralleled in certain Saxifrages, e. g. *S. diversifolia*, Wall., a Himalayan species, but it is no less true that this particular leaf-form is one which is markedly characteristic of geophytes in general. If we classify the terrestrial Dicotyledons of the British Flora, according to their leaf-form, we find that the great majority of the leaves, which approach those of *Parnassia* in shape, are borne by herbaceous plants perenniating underground, and producing a large proportion of their leaves 'radically'. It seems a reasonable deduction that there is some correlation between a perennial geophytic habit and this particular type of leaf. Hence, it may fairly be argued that the close resemblance in habit and general appearance between certain *Parnassias* and Saxifrages growing in mountainous regions is more probably a sign of similarity of response to the special conditions of the environment than an indication of near relationship. It is a well-known fact that perennial geophytic types are markedly prevalent among the plants of the High Alps.

To regard the case for the affinity of *Parnassia* with *Saxifraga* as being greatly strengthened by the resemblance in habit and leaf-form between certain members of these genera, seems to be a reversion to the ideas on taxonomy current in the latter part of the sixteenth century. Mathias de l'Obel, in his various works (e. g. 'Kruydtboeck', 1581), classifies plants almost entirely according to their leaf-form and habit. It is thus scarcely surprising that he should describe in succession the following plants, which we now regard as belonging to a number of different families: *Soldanella*, *Convolutulus Soldanella*, *Parnassia palustris*, 'Pthora' (? *Ranunculus Thora*, L.), *Cyclamen*, and *Aristolochia*. Modern systems of classification, on the other hand, are based upon the well-tested hypothesis that it is in the reproductive organs, rather than the vegetative parts, that indications as to affinities are to be sought. It is true that the vegetative structure sometimes gives valuable clues to relationship, but these should always be subsidiary to those derived from a study of the reproductive organs.

The leaf-form and habit are not the only vegetative features on which stress has been laid in discussions of the affinities of *Parnassia*; attention has also been drawn to the presence of tanniferous cells in the leaf-epidermis of this genus,<sup>1</sup> and the occurrence of similar cells in members of the Saxifragaceae, e. g. *Saxifraga cymbalaria* and *Chrysosplenium*, as described by Engler<sup>2</sup> and Thouvenin.<sup>3</sup> Now, in *Saxifraga cymbalaria* and its allies,

<sup>1</sup> E. g. Hallier, H.: Über die Verwandtschaftsverhältnisse bei Engler's Rosalen, Parietalen, Myrtifloren und in anderen Ordnungen der Dikotylen. Abhandl. aus dem Gebiete der Naturwissenschaften, Bd. xviii, Hamburg, 1903 (see footnote to p. 58 of reprint); and Eichinger, A.: l. c., p. 300.

<sup>2</sup> Engler, A.: Monographie der Gattung *Saxifraga*, L., Breslau, 1872, p. 12.

<sup>3</sup> Thouvenin, M.: Recherches sur la structure des Saxifragacées. Annales des Sci. Nat., sér. 7, t. xii, 1890, p. 33.



the tanniferous cells are elongated and vermiform, and originate, according to Engler, by the fusion of a row of elements. They are thus scarcely comparable with those in *Parnassia*<sup>1</sup> and *Chrysosplenium*, which consist of individual epidermal cells, placed either singly or in groups. In these two genera we are not dealing with the occurrence of a definite secretory organ, but merely with the presence of tannin in certain epidermal cells which are otherwise normal. This is not a morphological character, but probably an expression of some peculiarity of metabolism, perhaps correlated with the habitat. It seems highly unlikely that such a character would be a trustworthy clue to relationship. This doubt is strengthened by the fact that the leaf-epidermis of *Chrysosplenium* is markedly different in its general features from that of *Parnassia*. In the former, hairs are present, and the small stomata are placed in groups in connexion with subsidiary cells which are absent in *Parnassia*.

We are thus brought to the conclusion that the case for the Saxifragaceous affinity of *Parnassia* gains little support from a consideration of the tanniferous cells.

Having considered one or two points in which the value of the arguments for the relationship of *Parnassia* to the Saxifragaceae appears to have been over-estimated, we may now turn to the theory that this genus has an affinity with the Hypericineae. Here, on the contrary, the weight of favourable evidence seems to have been unduly minimized by many writers. For this reason it may be well to compare the essential organs of the flower in *Parnassia* and in *Hypericum* in some detail (cf. Text-figs. 3 and 4).

In *Hypericum* there are either five or three carpels and in *Parnassia* generally four, though in more than one species flowers with five carpels are quite common.<sup>2</sup> The main difference in structure between the gynaecea of the two genera is that the stigmas of *Parnassia* are continuous with the placentas, whereas the styles and stigmas of *Hypericum* are placed between the placentas or septa (cf. Text-fig. 3, A and C, and Text-fig. 4, B and D). The dehiscence also differs, being loculicidal in *Parnassia* and septicidal in *Hypericum*.

The placentation of *Parnassia* was described by Lindley,<sup>3</sup> in 1846, as 'truly axile'. Hooker and Thomson,<sup>4</sup> on the other hand, wrote: 'The placentation in all the species is decidedly parietal, as in *Droseraceae*; nor have I, in the earliest-examined stages, detected any evidence of this being a deviation from the axile type.' It will be seen from the accompanying diagrams (Text-fig. 3), which represent a set of serial sections through the

<sup>1</sup> Thouvenin, M.: l. c., p. 39, Pl. 10, Fig. 2.

<sup>2</sup> Seemann, B.: The Botany of the Voyage of H.M.S. *Heralda*, 1852-7, p. 25, and Pace, L. l. c., p. 306.

<sup>3</sup> Lindley, J.: The Vegetable Kingdom, p. 406, London, 1846.

<sup>4</sup> Hooker, J. D., and Thomson, T.: l. c., p. 78.

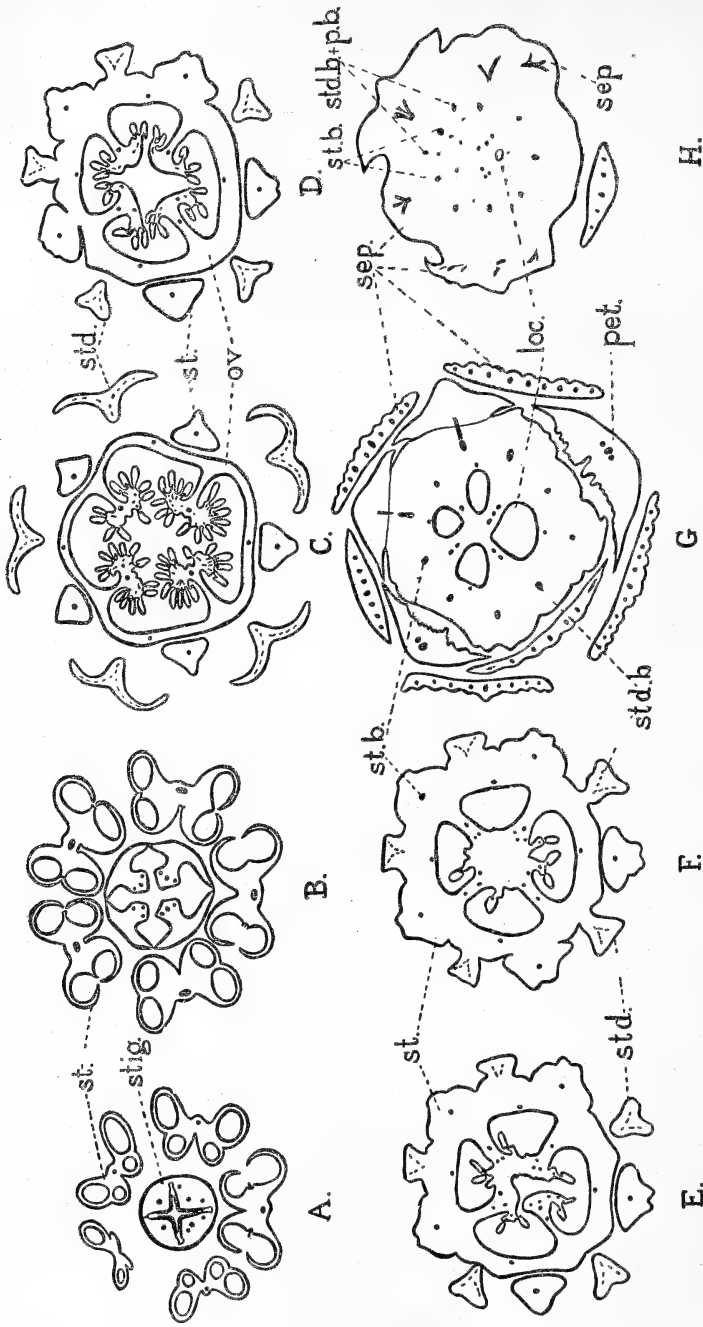

TEXT-FIG. 3. Series of transverse sections (semi-diagrammatic) through the essential organs of a flower of *Parmastia palustris* (x 9). A is cut near the apex of the flower and H at the base. The sepals (*sep.*) and petals (*pet.*) are not indicated, except in G and H. *st.* = stamen; *std.* = stamen bundle or nectary; *std.b.* = staminode or nectary; *std.b.* = staminode bundle; *pb.* = petal bundle; *ov.* = ovary; *loc.* = loculus.

essential organs of a flower of *Parnassia palustris*, that Lindley's view is undoubtedly correct. The placentation for an extremely short distance close to the base is definitely axile, the ovary possessing four loculi (Text-fig. 3, F). A little higher up the tissue connecting the septa breaks down (Text-fig. 3, E), but the septa themselves persist, terminating in T-shaped placentas (Text-fig. 3, D). The latter are at first almost in contact, but higher in the ovary, by the gradual shortening of the partial septa, they are brought closer to the ovary wall, so that the placentation, as seen in transverse section, appears more decidedly parietal (Text-fig. 3, C).

The particular kind of parietal placentation found in *Parnassia* is thus easily seen to be a mere variant of the axile type. Further, if we examine the ovary of *Hypericum Elodes* (Text-fig. 4, B-E) for comparison, we find that the structure is essentially the same as in *Parnassia*. At the base, the ovary is divided into three loculi (Text-fig. 4, E), while, higher up, the septa become disconnected and give rise to parietal placentas (Text-fig. 4, D). In various other *Hypericum*s the ovary is multilocular throughout, so that in this genus we can follow the transition between axile placentation and that form of parietal placentation characteristic of *Parnassia*.

The resemblance between the seeds of *Hypericum* and *Parnassia* is generally recognized. Both are anatropous, and certain species of each genus have no endosperm in the ripe seed, while others are supplied with a single thin layer.

When we attempt to compare the androecium in these two genera, we find one feature in which they differ very noticeably. The androecium of *Hypericum* consists of either three or five 'fascicles' or 'phalanges' of fertile stamens, which may or may not alternate with an outer whorl of staminodes. In the cases where there are five of these fascicles they are placed opposite to the petals. In *Parnassia*, on the other hand, the fertile stamens alternate with the petals, and it is the staminodes which occupy a position corresponding to that of the stamens in *Hypericum*. When we turn, however, from the question of the relative positions of the sterile and fertile whorls to the form and structure of the individual members of which they are composed, we can scarcely fail to be struck by the analogy between the stamen-phalanges of *Hypericum* and the branched staminodes of *Parnassia*. This point is one of great interest, and it appears to have played a considerable part in suggesting the possibility of an affinity between these genera. Payer<sup>1</sup> has shown that, in ontogeny, the lateral stalked glands of the nectaries of *Parnassia palustris* are developed basipetally, and that they thus correspond to the stamen bundles of *Hypericum*, where the order of development is centrifugal.

If this correspondence is to be regarded as complete, we must assume

<sup>1</sup> Payer, J. B. : *Traité d'organogénie comparée de la fleur*, Paris, 1857, p. 184 and Pl. 9, Figs. 26-9.

that each terminal gland in the staminode of *Parnassia palustris* is equivalent to an anther. Drude has indicated a possible process whereby a staminode, such as that of *Parnassia palustris*, might be imagined to arise from a stamen-phalange such as that of a *Hypericum*. He points out that, in certain species of St. John's Wort, a large gland occupies the upper part of

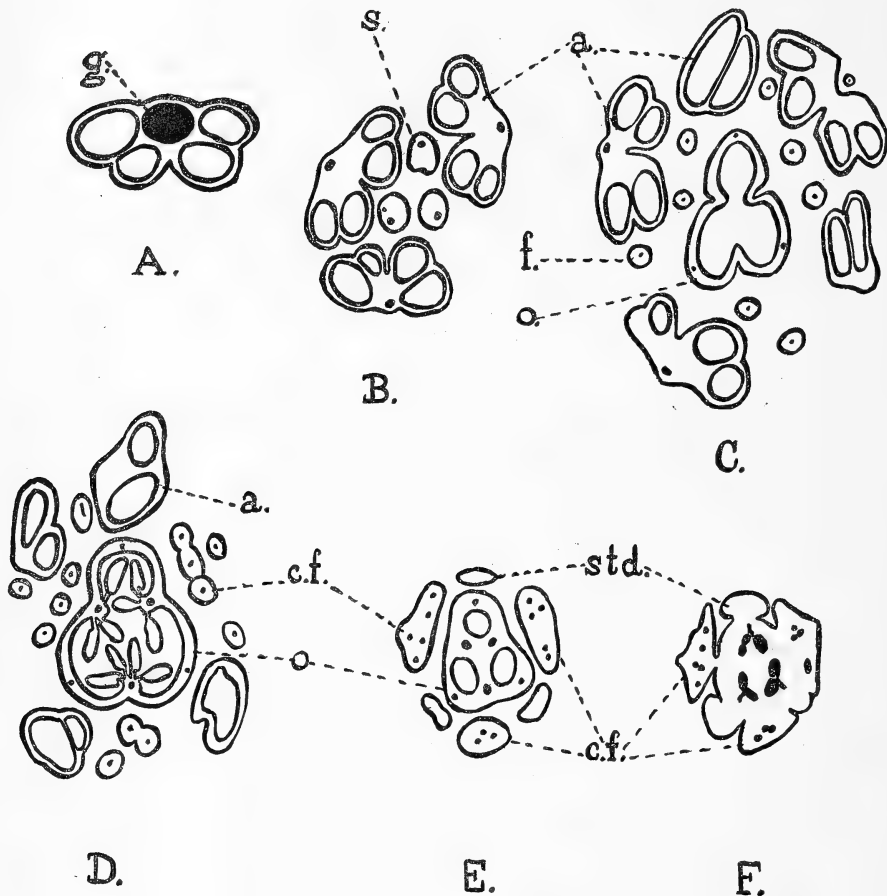

TEXT-FIG. 4. A. Transverse section of the upper part of the anther of *Hypericum* sp. (? *olympicum*) to show a gland (*g*) occupying the greater part of the connective ( $\times 34$ ). B-F. Series of transverse sections through the essential organs of a flower of *Hypericum Elodes*, Huds. ( $\times 34$ ); *s* = style; *a*. = anther; *f*. = filament; *c.f.* = common filament; *std.* = staminode; *o.* = ovary. Owing to the oblique position of the lateral stamens of each phalange, their anthers are not completely seen in any one transverse section.

the connective in each anther (Text-fig. 4, A) of the stamen-fascicle. If these stamens became abortive by the loss of their pollen-sacs, we should be left with a bundle of filaments each terminating in a gland. Drude has also called attention to another curious analogy between the androecia of *Hypericum* and *Parnassia palustris*, namely, that the stamen-fascicles and the staminodes respectively tend to persist during the ripening of the fruit.

As we have shown in Section II (iii) of the present paper, not only the form but also the anatomy of the staminodes of *Parnassia* is favourable to the comparison with *Hypericum*.

So far, we have been dealing with evidence supporting the view that the staminodes of *Parnassia* represent phalanges of sterile stamens. This theory has been disputed, however, by several writers, and we must now consider the chief criticisms which have been levelled against it.

Wettstein<sup>1</sup> took the view that if each nectary of *Parnassia* corresponded to a fascicle of stamens, the number of stalked glands in each nectary would be closely similar throughout the genus. However, as he pointed out, the number of glands varies widely from species to species. He regarded this fact as destructive of the analogy with *Hypericum*, but it appears to me that this variation within the genus does not really render it impossible to homologize the nectaries with fascicles of stamens. Among the St. John's Worts the number of stamens in a phalange varies in different species from as few as three up to a number too large to be easily counted. In *Hypericum Elodes* we find great variation even within a single flower. This species is usually described as having fifteen stamens connate into three bundles. I have found, however, that in six flowers taken as random, which had been collected in three different localities in two different years, the number of stamens in the three phalanges were respectively—5, 4, 3; 5, 4, 3; 6, 4, 3; 5, 4, 3; 5, 5, 3; 5, 4, 3.

In considering the variability of the nectaries within the genus *Parnassia*, it must also be remembered that these structures are essentially 'rudimentary organs', although now modified for the purpose of insect attraction, and, as Darwin<sup>2</sup> pointed out in discussing the subject of rudimentary organs: 'In closely allied species, also, the extent to which the same organ has been reduced occasionally differs much.'

I have attempted to show that, from the standpoint of comparative morphology, Wettstein's objection to the view that the nectary of *Parnassia* is equivalent to a phalange of stamens is not a conclusive one. There is also another objection to be met, namely that brought forward by the same author on teratological grounds.<sup>3</sup> He described two flowers of *Parnassia palustris* which were abnormal as regards the androecium. In one of these the stamens bore outgrowths resembling the glandular processes of the staminodes, and in the other the fertile stamens were normal, but the staminodes showed transitions between their usual form and the form of a normal fertile stamen. From these observations, Wettstein drew the conclusion that the staminode is the equivalent of a single stamen, not of

<sup>1</sup> Wettstein, R. von: Zur Morphologie der Staminodien von *Parnassia palustris*. Ber. d. deutsch. bot. Gesellsch., Bd. viii, 1890, p. 308.

<sup>2</sup> Darwin, C.: The Origin of Species, sixth ed., London, 1894, p. 374.

<sup>3</sup> Wettstein, R. von: l. c., p. 305.

a fascicle. In reply to this argument it may be urged that, while all evidence from abnormalities requires cautious handling, this is more than ever the case when the abnormality in question is of rare occurrence. When the same deviations from the normal occur in a large percentage of the flowers borne by any species, they may perhaps be regarded as the outcome of some definite tendency inherent in that species. For instance, the fact that five carpels instead of four are very frequently found in *Parnassia palustris*<sup>1, 2</sup> and *P. Kotzebuei*<sup>1</sup> may well have some significance, especially since, in these pentamerous forms, the carpels alternate in normal fashion with the inner whorl of the androecium. But it is dangerous to draw any phylogenetic conclusions from the structure of two isolated, abnormal flowers. It must also be remembered that, many years ago, Buchenau<sup>3</sup> described an abnormal flower of *Parnassia palustris*, in which one of the nectaries was partially transformed into a carpellary leaf, bearing both ovules and typical stalked glands. If we are prepared to attach phylogenetic significance to such abnormalities, and to conclude from Wettstein's work that the nectary is equivalent to a single stamen, we are also logically compelled to conclude from Buchenau's observations that the nectary is equivalent to a carpel—a result which appears to be a *reductio ad absurdum*.

When we leave the subject of the staminodes of *Parnassia* and turn to the comparison of the fertile stamens of this genus with those of the Hypericineae, we find that the anthers differ in a point upon which stress has sometimes been laid by systematists—namely, the dehiscence. In the Hypericineae this is introrse, while in *Parnassia* it is commonly described as extrorse. However, the distinction has lost some of its force since Gris<sup>4</sup> showed that the anthers of *Parnassia palustris* are introrse in the young flower and only become secondarily extrorse at a later stage of development. Another and much more important difference between the fertile members of the androecium in *Parnassia* and the St. John's Worts is the fact that we have to deal with individual stamens on the one hand, and fascicles of stamens on the other. At first sight it may seem that, even if the homology of the nectaries of *Parnassia* with the stamen phalanges of *Hypericum* were accepted, it would be impossible to imagine that the fertile stamens of *Parnassia* could come into the same category. Externally, these stamens are perfectly simple structures (Text-fig. 2, A and D), each consisting of an undivided filament and a single anther. But, as we have shown in Section II (ii) of this paper, the vascular system of the filament and connective

<sup>1</sup> Seemann, B.: The Botany of the Voyage of H.M.S. *Herald*, London, 1852-7, p. 25.

<sup>2</sup> Pace, L.: l. c., p. 306.

<sup>3</sup> Buchenau, F.: Einige Beobachtungen aus dem Gebiete der Pflanzen-Teratologie. Bot. Zeit., xx, p. 307, 1862.

<sup>4</sup> Gris, A.: l. c., p. 915.

differs from that of most flowering plants in such a way as to suggest that the stamen has been derived by reduction from a 'stamen-fascicle', the only traces of ancestral complexity being retained vestigially in the vascular system. The stamen of *Parnassia* would, on this view, hold the same relation to any ordinary stamen that a 'unifoliolate compound leaf'<sup>1</sup> bears to an ordinary simple leaf.

In conclusion, we may put in a plea for the reinstatement of *Parnassia* in the separate Order Parnassieae. That it should be included in the tribe Saxifragoideae of the Order Saxifragaceae seems most unsatisfactory, since this arrangement tends to obscure its relationships in other directions.

I entirely agree with Drude's conclusion that *Parnassia* shows undoubted affinities with Saxifragaceae, Droseraceae, and Hypericineae, but, bearing in mind the new evidence adduced in the present paper, I am inclined to think that Drude somewhat under-estimated the closeness of the relationship between *Parnassia* and the Hypericineae.

#### V. SUMMARY.

The chief points regarding the androecium of *Parnassia* brought forward in the present paper are as follows:

1. In the course of a description of the general vascular symmetry of the flower of *Parnassia palustris*, L., it is shown that the strands destined for the stamens arise as independent bundles at a lower level in the receptacle than those destined for the staminodes.

We are thus able, on anatomical grounds, to confirm Drude's view, based on developmental evidence, that the nectaries or staminodes of *Parnassia* form the *inner* whorl of the androecium.

2. In *Parnassia palustris*, L., the bundle which traverses the filament is found to be accompanied by centripetal xylem, and there are indications of numerous phloem groups arranged round the xylem. A similar structure has also been found in the filaments of *P. fimbriata*, Banks.

It is suggested that these peculiarities of the stamen anatomy are due to the presence of vestigial vascular strands which indicate that each individual stamen of *Parnassia* is reduced from an ancestral stamen-fascicle, comparable with that occurring in *Hypericum*.

---

On the general question of the affinities of *Parnassia*, Drude's view is accepted, namely, that this genus should be placed in the Order Parnassieae, related to the Saxifragaceae, Droseraceae, and Hypericineae.

<sup>1</sup> i. e. a leaf such as that of *Berberis* § *Euberberis*, which is regarded as derived by reduction from a compound leaf such as that of the related genus *Berberis* § *Mahonia*.

The present writer holds that the relationship with the Hypericineae is closer than was supposed by Drude, and considers that the affinity between *Parnassia* and the Saxifragaceae has, in recent years, been somewhat over-estimated.

BALFOUR LABORATORY,  
CAMBRIDGE.

December 22, 1912.

---

## EXPLANATION OF PLATE XXXVI.

Illustrating Mrs. Arber's paper on *Parnassia*.

All the figures represent sections through the vascular tissue of the stamen of *Parnassia palustris* magnified 450 diameters. The sections are so placed that the centre of the flower would lie to the right of the diagram in each case. *xy.* = xylem; *px.* = protoxylem; *cp<sub>x</sub>.* = centripetal xylem; *cf<sub>x</sub>.* = centrifugal xylem; *ph.* = phloem.

Fig. 1. Transverse section of filament showing ring-like xylem, with protoxylem attached to the inner face of the ring on the dorsal side. The numerous small groups of phloem are arranged round the xylem and at some little distance from it.

Fig. 2. Radial longitudinal section through a bundle such as that shown in Fig. 1.

Figs. 3, 4, and 5. Transverse sections at different levels of the filament and connective of the same stamen.

Fig. 3. Section to show discontinuous xylem ring. Xylem only represented.

Fig. 4. Section at a higher level to show centripetal xylem entirely detached from centrifugal xylem.

Fig. 5. Section through the connective to show the xylem complex.



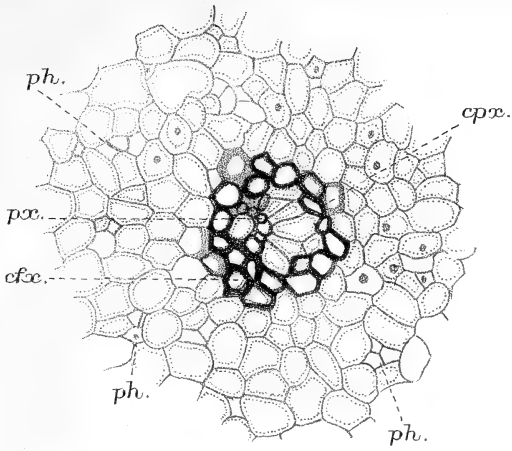

1.

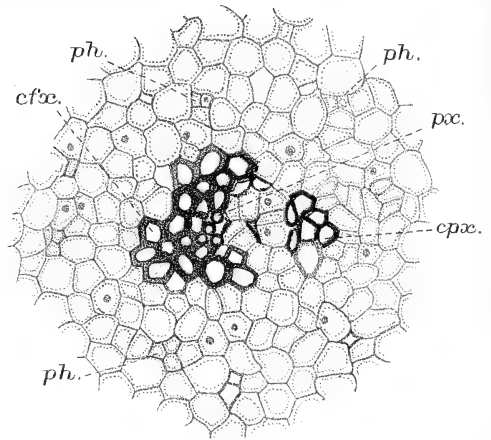

4.

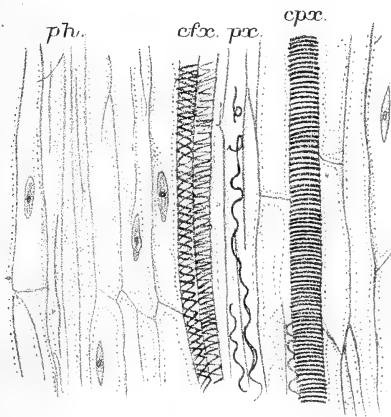

2.

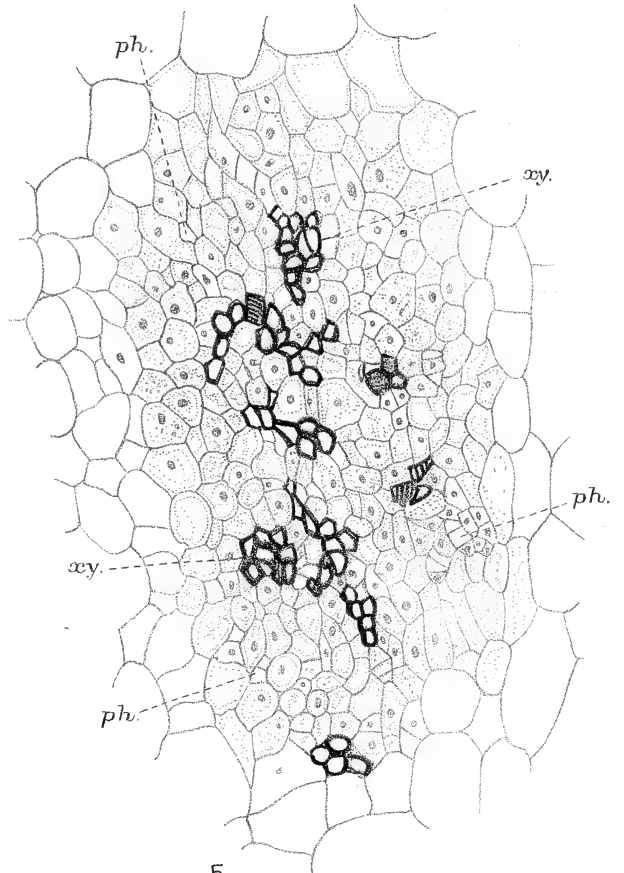

5.

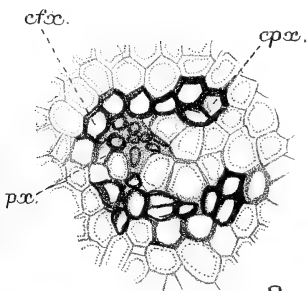

3.

A.A. ad nat. del.

Huth lith. et imp.



# The Morphology of *Riccia Frostii*, Aust.

BY

CAROLINE A. BLACK.

With Plates XXXVII and XXXVIII.

## GENERAL CHARACTERS.

THE summer and autumn of 1908 were characterized by an exceedingly long drought in Bloomington, Indiana. During the autumn, as the water in the reservoir which supplied the town gradually diminished, the basin of the reservoir was covered with patches of *Riccia Frostii*, Aust.<sup>1</sup> The ground in its moist condition, roughened by cracks as a crust gradually formed, provided an ideal habitat for the Liverwort, as evidenced by its luxuriant growth. Tracks made by workmen, horses, &c., furnished further protection and conservation of water, and on the border of these the plants were also numerous. The Liverwort was found in patches several metres square, or in solitary rosettes, and in colour appeared dull green to reddish. The following years, 1909-10 and 1910-11, although dry, never exhausted the water in the reservoir. Comparatively little *Riccia* was found, and this only on the banks of the reservoir. *Riccia Frostii* was described as a new species by C. F. Austin (2) in 1875. Underwood (42) includes *Riccia Frostii* in his Hepaticae, and describes it fully.

*Riccia Frostii*, Aust., when grown uncrowded develops a thallus, in form a typical rosette, varying in diameter from 5 to 12 mm., attached to the ground by simple rhizoids. Young plants are irregularly and more deeply lobed than older, fully developed ones. This is well shown in Pl. XXXVII, Figs. 1-5, which are photographs of plants, enlarged four times. The central portion sometimes decays as the plant grows, and results in unsymmetrical rosettes. There is present a dichotomous branching which gives rise to a circular plant, with a number of growing points situated in depressions at the edge of the rosette (Figs. 1 and 2). As a whole the thallus is compact (Figs. 1 and 2). When the plants are found growing under crowded conditions, the typical rosette form is lost in the overlapping of the different plants, which pile up and grow irregularly as they encroach upon each other. The

<sup>1</sup> Acknowledgement is due to Mr. Marshall A. Howe, who kindly determined the species as *Riccia Frostii*, Aust.

surface of the thallus is characterized by minute depressions or pits corresponding to the air-spaces beneath. Underwood describes the thallus of *Riccia Frostii* as probably dioecious. It was found to be strictly dioecious. It begins to fruit when very young, and a succession of sexual organs is maintained as the thallus develops. Plants only 3 or 4 mm. in diameter were found with mature sporophytes. The globular sporophytes were seen readily with the naked eye, the older ones appearing black.

The abundance of material found in all stages of development, together with the interest in recent years in various phases of the life-history of different Liverworts, suggested the desirability of making a study of this plant. Material was fixed in chromacetic acid, and in the chrom-osmic-acetic acid mixture prepared according to the formula of Mottier (36), washed, dehydrated, and embedded in paraffin. Sections were cut from 2 to 7  $\mu$ , the majority being 2  $\mu$  thick. A number of different stains were used. Satisfactory results were obtained with anilin, safranin, and gentian violet, with or without the orange G, with Heidenhain's iron-alum-haematoxylin, and with Bismarck brown and gentian violet.

Bischoff (8) in 1835 described and figured a number of species of *Riccia*, emphasizing the method of reproduction, and proposing the terms 'antheridia' and 'archegonia' for the male and female organs respectively. In 1836 a monograph on the Ricciaceae by Lindenberg (33) appeared. The earliest detailed account of the morphology of *Riccia* is by Hofmeister (25), who described the development of the thallus, the origin and position of the archegonia and antheridia, and the formation of the sporophyte. He remarks that the earlier investigators have described exclusively the organs of fructification, assuming that 'the low state of development of fruit must be accompanied by an equally low state of development of the vegetative organs'.<sup>1</sup> Kny (30) investigated the structure of the thallus of various Ricciaceae and established its development by means of apical growth, showing the origin of the ventral scales, the sexual organs, and the nature of the air cavities. Fellner (20) is the first to record the development of a thallus of *Riccia glauca* from the spore. In a complete investigation by Leitgeb (32) of the following species of *Riccia*, *R. glauca*, *R. bifurcata*, *R. crystallina*, *R. fluitans*, *R. Bischoffii*, and *Ricciocarpus natans*, the development of the thallus and the origin and nature of the air-spaces are minutely described, together with some phases of the reproductive organs and sporophyte.

#### STRUCTURE OF THE THALLUS.

The development of the thallus of *R. Frostii*, Aust., is in the main in accordance with that of other Ricciaceae as outlined by Campbell (9, p. 24). Growth takes place from one or more apical cells situated in a depression

<sup>1</sup> Hofmeister: On the Higher Cryptogamia, p. 97.

at the apex of the thallus. Like *Riccia crystallina*, Leitgeb (l. c., p. 13), the segments on the ventral side are limited and do not form ventral scales or lamellae, as they do in *R. glauca* (Campbell, l. c., p. 25). Fig. 6 represents a longitudinal vertical section cut through the growing point. It ends in a large wedge-shaped apical cell, from which cell-rows are cut off. On the dorsal side, segments are cut off which eventually become the upright filaments. A transverse section cut through the growing end of a thallus (Fig. 7) illustrates the dichotomous branching. The cell-rows cut off on either side arch over the growing point and are in an inclined or an almost horizontal position. In older parts of the thallus these cell-rows are erect. The growing points are distinguished by their dense contents and large nuclei.

Recent investigations of the air-chambers of the Marchantiales have brought into question the account of Leitgeb, who attributes the air-chamber and the sex-organ pit to the same origin in the Ricciaceae. His summary of the formation of the air-chambers and the stomata states that the origin of the air-spaces is caused by the growth of cells surrounding a depression which first appears on the surface. The continued upward growth of these cells forms the air-space, and the origin, therefore, is not due to a splitting from the outside inward, nor to a separation of cells. Goebel (23) states that the air cavities in the Ricciaceae do not arise schizogenetically like the intercellular spaces of higher plants, but in a manner as shown by Leitgeb, beginning in a depression at the junction of four cells, and originating as a natural consequence of the upward growth of the adjacent cells. Barnes and Land (4) studied the origin and nature of the air-chambers in the following forms: *Fimbriaria*, *Marchantia*, *Lunularia*, *Conocephalus*, *Dumortiera*, *Plagiochasma*, and *Ricciocarpus natans* and *Riccia fluitans*, and concluded that 'the air-chambers of the Marchantiales arise invariably by the splitting of internal cell-walls usually at the junction of the outermost and first internal layer of cells. Thence, in one type, splitting proceeds outwardly and inwardly more extensively than laterally, and lateral enlargement of the chamber follows by growth; while in the other type expansion of the chamber is due to extensive inward splitting accompanied by growth. The origin of the air-chamber is in all respects like that of the intercellular spaces in the vascular plants.' It is significant that Barnes and Land described only two forms of the Ricciaceae, and the two examined had the character of air-chamber of the other forms described by them.

Miss Hirsh (24), in a study of the air-chambers in the Ricciaceae based primarily upon *Riccia Frostii*, included the examination of fresh material of *Ricciocarpus natans* and herbarium material of *Riccia nigrella*, *R. glauca*, *R. Miyakeana*, *R. crystallina*, *R. arvensis hirta*, *R. fluitans*, and *R. Donnellii*. Her examination of *Ricciocarpus natans* confirms the statement of Barnes and Land that the air-spaces in this plant arise through internal cleavage

and have no relation with the sex-organ pit, but in four of the other forms examined, *R. nigrella*, *R. glauca*, *R. Miyakeana*, and *R. Frostii*, a different type of air-chamber was found from that of *Ricciocarpus natans* and *R. fluitans*. Miss Hirsh, in describing the origin of the air-spaces in *Riccia Frostii*, Aust., says (l. c., p. 203), 'Immediately back of the apical cell the superficial cells arch outward in a papillate manner, as a result of the cessation of growth at the lines of their junction. As they elongate they are divided by transverse walls, so that filaments or rows of cells are formed, which are separate and distinct from one another. The intervening spaces in this species are formed, therefore, not by the cleavage or the separation of mature tissues, but in a manner exactly indicated by the diagrammatic scheme given by Barnes and Land in their Fig. 1.' Miss Hirsh concludes that there are two methods of the origin of the air-spaces in the Ricciaceae: one, by internal cleavage resulting in irregular air-spaces separated by plates of cells one layer thick, as in *Ricciocarpus natans*; the other by the upward growth of filaments at right angles to the surface of the thallus, forming narrow chambers or canals, as in *Riccia Frostii*, Aust. It will be seen that Miss Hirsh supports the theory of Leitgeb, and her work is also in harmony with the description given by Campbell (l. c., p. 25). The writer's observations of *Riccia Frostii* are in agreement with those of Miss Hirsh.

Fig. 6 is a stage similar to Figs. 4, 5, and 6 of Miss Hirsh. The apical cell is seen at the apex, and back of this are depressions which become the air-spaces by the upward growth of the adjacent cells. The cell-row is seen to have become more than one cell thick in certain cells, initiating the widening of the air-spaces. The transverse section (Fig. 7) shows almost the same condition as the longitudinal in the papillate surface of the growing point, and at either side are the cell-rows with the canal-like air-spaces between them. The fully developed air-chamber is a canal of irregular polygonal shape, separated by plates of chlorophyll-bearing tissue, one cell in thickness, as seen in Fig. 8, a section cut parallel to the surface in a mature thallus. The number of cells bounding an air-space may therefore vary considerably in different parts of the thallus. This has been pointed out by Juel (28) in an article<sup>1</sup> on *Riccia Bischoffii*. The small depressions or pits on the surface of the thallus are the openings of the air-spaces which lead in an indefinite manner to the surface cells. The thallus of *R. Frostii* is similar to that of *R. glauca* described by Campbell (l. c., p. 28), and consists of the ventral part, a compact tissue with no air-spaces, from which the rhizoids spring. From this compact tissue the upright filaments arise, forming the elongated air-chambers. The terminal cells of the filaments are somewhat swollen and have scanty contents. Goebel (l. c., p. 72) refers to the lack of chlorophyll in the outermost layer of cells, and considers

<sup>1</sup> From current literature in the Bot. Gaz., li, p. 479, 1911.

it a primitive form of epidermis. The upright filaments and the tissue beneath contain chlorophyll. The air-chambers in *Riccia Frostii*, Aust., are open their entire width, i. e. they are not overgrown by the surface development of the epidermis. An examination of *Ricciocarpus natans*<sup>1</sup> and other Marchantiales (*Marchantia polymorpha*, *Fegatella conica*, and *Asterella*) showed the origin of the air-spaces to be similar to that described by Barnes and Land. If the splitting occurs within the thallus in *Riccia Frostii*, Aust., it would seem reasonable to find stages that have not yet reached the surface, such as are found with no difficulty in *Ricciocarpus natans* and other forms. But in all the material examined the cell relations are unmistakably clear, and no stage was found with an internal space not yet broken out to the surface.

As before stated, the thallus of *Riccia Frostii*, Aust., is strictly dioecious. The sexual organs are scattered irregularly in acropetal succession in the thallus. Goebel (l. c., p. 80) speaks of the disposition of the sexual organs in *Riccia* as diffuse, and considers it a primitive type.

#### DEVELOPMENT OF THE SEXUAL ORGANS.

Although several hundred slides were made of as many plants of *Riccia Frostii*, no sterile plants were found. No thallus was found, young or old, bearing both antheridia and archegonia. The sexual organs are produced continuously as long as the thallus lives. There is thus no definite fruiting period.

The development of the archegonia and antheridia conforms to the hepatic type, and has been fully described by other writers. The antheridium initial is distinguished by its dense contents from the adjacent cells before it projects above the surface of the thallus. The initial cell in *Riccia Frostii* divides transversely before it has projected much above the other cells. The antheridium scarcely projects above the surface of the thallus, for, as it elongates, the tissue immediately surrounding the antheridium develops, sometimes level with it (Fig. 10), sometimes a little lower than it (Fig. 9a), and eventually surpasses it (Figs. 9b and 11), leaving the antheridium an embedded or sunken structure. The antheridial wall is cut off early (Figs. 12 and 13). The end cells of the filaments adjacent to the antheridium are distinguished from the first by dense contents (Figs. 9b and 11). These cells form the canal, or opening, leading to the antheridium, through which the sperms are discharged (Fig. 13). Cell-division in the antheridium soon overtakes cell growth, and many cells eventually occupy the place of a few. As the antheridium matures, the cells of one group divide simultaneously. Usually several groups of cells are active, so that in one antheridium many stages of division may be found. The cells are

<sup>1</sup> Slides belonging to Mr. Fermen L. Pickett.

more or less cubical until the last division, which is a diagonal one, forming two triangular cells. Kny in *Marchantia* and Campbell in *Fimbriaria* report this final division without a cell-wall, as does Lewis (31) for *Ricciocarpus natans*. Durand (14) states that in slides stained with Delafield's haematoxylin the diagonal walls in *Marchantia* show distinctly in some cells, but seem to disappear early. The diagonal cell-walls were not found in *Riccia Frostii*, but at this stage in the antheridium the cell-walls appear to undergo a change, so that their detection may be a question of stage in development. The mature antheridium of *Riccia Frostii* has a short stalk, and is oval, with a flat base and rounded apex. The apex may be conical in young antheridia (Fig. 12). The size of the mature antheridium was found to vary; comparatively small antheridia were found with mature spermatozooids.

Before the sperms have been discharged from an antheridium they all eventually reach the same state of maturity and lie in a common cavity. All cell-walls in the antheridium disappear, and probably add to the semi-fluid contents of the antheridium. Several writers have observed the explosive discharge of sperms in various Liverworts. In *Fegatella conica* this was first observed by Thuret (40). King (29) and Cavers (10) have also studied the explosive discharge of sperms in *Fegatella*, and Peirce (38) in *Asterella*. While the discharge of the spermatozooids was not observed in *Riccia Frostii*, the following conditions point to their discharge as probably of an explosive nature. Antheridia when mature are filled with sperms, lying free in the cavity surrounded by the semi-fluid substance. The antheridium wall appears normal. In antheridia, where the sperms have been partly discharged, the cells in the wall of the antheridium are greatly distended inward. It would seem as if the pressure exerted by these cells would be sufficient to forcibly expel the spermatozooids. Antheridia are found emptied of their contents without any disturbance to surrounding cells, showing that the release of the spermatozooids is not due to a breaking down of tissue.

The complete account of the development of the archegonium in *Riccia Bischoffii*, by Janczewski (27), has been little modified by later investigators. The development of the archegonium is in general like that of the Liverwort archegonium described by Campbell, and by Garber (22) and Lewis for *Ricciocarpus natans*. In the paper by Durand (14) on *Marchantia polymorpha*, the steps in the development of the archegonium are so clearly presented and in such sequence that it is unnecessary to repeat them here. Various stages are seen in Figs. 14, 15, and 16.

Actual fertilization was not observed. However, the sperm nucleus was observed in the egg-cell and in juxtaposition to the egg nucleus (Fig. 17). The fertilized egg probably undergoes a period of rest, as innumerable archegonia were found with the egg in the condition shown in



Fig. 18. The nucleus is large, and the chromatin is collected in a cord or short segments. A fine network is seen in the nucleus besides the densely staining material. After fertilization, the venter of the archegonium, which is one cell thick, undergoes division, the cells at the base usually dividing first.

#### THE SPOROPHYTE.

The first division-wall in the fertilized egg is usually oblique, although inclined to be at right angles to the axis of the archegonium. Campbell, Garber, and Lewis report this division as usually horizontal, although sometimes oblique. The second division may be parallel to the first, resulting in a three-celled embryo, as in Fig. 19, or it may be at right angles, resulting in a globular embryo. Later divisions do not always follow the order described by Campbell, but the embryo gradually develops by irregular cell-division. The embryo, even when consisting of thirty or forty cells, may be oval (Fig. 21), but is usually globular (Fig. 20). The amphithecium is developed according to Campbell; sometimes this tabular row will be cut off early, or it may not be differentiated until quite late. In a growing embryo, several cells may be found in different stages of division, as seen in Figs. 24 and 25, which are from the same sporophyte. One is a late telophase with the chromatin in an apparent cord (Fig. 25). The other is a polar view showing sixteen chromosomes (Fig. 24).

By the time the spore mother-cells are formed, the amphithecium is partly disorganized. The inner layer of the sporangium wall is beginning to collapse, while the outer one appears comparatively firm. Many chloroplasts are seen in this layer (Fig. 23). The spore mother-cells round up, not entirely filling their cell cavities. The spore mother-cells do not completely fill the sporangium again until the spore tetrads are formed. The mucilaginous substance with which the spore mother-cells are surrounded stains homogeneously with various stains, having great affinity for gentian violet and Bismarck brown. The nucleus of the spore mother-cell possesses a definite nucleolus. Lewis reports no definite nucleolus for *Ricciocarpus natans*, unless the mass of chromatin found in dividing nuclei be interpreted as such, but in *Riccia Frostii* these two stages seem to be differentiated. In material fixed with chrom-osmic-acetic acid mixture, oil drops are abundant in the spore mother-cell as black granules varying in size. Besides these, a dense network of lighter staining material fills the cell. The cell membrane is delicate. All the cells from the fertilized egg become spores except the amphithecium.

#### ANOMALY.

The only abnormality observed is that in Fig. 22, in which the sporophyte has been affected by a bacterial organism. The neck of the archegonium is plugged by its mucilaginous contents. Below this the mass of

Bacteria is seen. In the preparation this mass had stained brilliantly with the safranin, whereas the mucilaginous content of the neck had taken up the gentian violet. That the Bacteria were developing at the expense of the sporophyte is seen in the crushed cells beneath the developing colony. The cells of the sporophyte or of the surrounding gametophytic tissue are not invaded, but the Bacteria as a mass have pushed down or crowded the cells of the sporophyte. While it was difficult to distinguish individual Bacteria, the colony appeared to be composed of small, short rods. The entrance of the Bacteria may have been accomplished at the time of fertilization.

#### SPOROGENESIS.

Sporogenesis has been a favoured subject for investigation in many Liverworts. Farmer (16), studying the sporogenesis of *Pallavicinia decipiens*, describes a quadripolar spindle in the spore mother-cell, with each of the four rays projecting into a lobe of the cell. A note is included on *Aneura multifida*, in which the same condition is observed. In the latter plant a centrosphere, but no centrosome, was observed at the extremity of each ray. Farmer and Reeves (19), in *Pellia epiphylla*, Nees, found in dividing spores two centrospheres occurring on opposite poles of the nucleus, and apparently becoming a factor in the formation of the spindle. No centrosome could be demonstrated in the centrosphere. Farmer (17), in 1895, published a note on spore formation and karyokinesis in the Hepaticae, followed in the same year by a complete report of his results. In the later paper (18) various Hepaticae are studied. Farmer found two centrospheres in the archesporial divisions of *Fossombronia* at either end of the nucleus which was about to divide. A central body was sometimes distinguished. The centrospheres were not apparent in the newly-formed daughter nuclei until their walls had been formed. The spore mother-cells become somewhat four-lobed, but not as strikingly so as in some of the other Jungermanniaceae. Centrospheres appear simultaneously at four points on the periphery of the spore mother nucleus. The centrospheres become approximated in pairs and the first spindle is bipolar. In *Pellia epiphylla*, Farmer records that the centrosphere appears at four points on the periphery of the nucleus, and that each contains a small centrosome. *Aneura multifida* exhibits the same type of quadripolar spindle as that found in *Fossombronia*. The quadripolar spindle was not found in *Fegatella conica*. In germinating spores, centrospheres were distinguished. Davis (12), in studying *Anthoceros*, gives a complete history of the divisions in the spore mother-cell, emphasizing particularly the ontogeny of the chloroplast. He describes the appearance of threads around the nucleus, which later become the spindle fibres. No centrospheres were present. The poles of the spindle were flat, slightly convex, but never pointed. Van Hook (43) confirms the absence

of centrospheres in *Anthoceros* spore mother-cells. In a later paper on *Pellia*, Davis (13) finds no centrospheres in the spore mother-cell, but in the germinating spore a centrosphere and an aster are observed. Chamberlain (11) finds centrospheres in the first mitosis of the germinating spore of *Pellia*. Moore (35) finds in *Pallavicinia*, that while the prophase resembles the four-poled spindle of Farmer, it cannot be interpreted as such, because it is followed by a well-organized bipolar spindle without centrospheres. Garber describes the sporophyte spindle of *Ricciocarpus natans* with prominent asters, but no centrosomes. Lewis for the same form finds neither centrosome nor centrosphere in the spore mother-cell divisions. Beer (5), in *Riccia glauca*, finds the resting nucleus of the spore mother-cell with a large, deeply staining nucleolus and a number of more faintly staining linin fibres. He describes the nucleolus as a compound structure made up of a number of deeply staining chromatic masses or granules embedded in a more faintly staining matrix. In the prophase, a long spireme thread develops in contrast to the short thread described by Lewis for *Ricciocarpus natans*. The reduced number of chromosomes is seven or eight.

The spore mother-cells in *Riccia Frostii* afford only fair material for study. Although the cells and the nuclei are large, the spindle is small and the chromatin scanty. Almost all stages of division can be found in a sporophyte containing active spore mother-cells. The spore mother-cell in Fig. 26 presents the characteristic resting-stage of the nucleus, with a large nucleolus containing a few vacuoles. The rest of the nuclear content is distributed in a fine network around the nucleolus, not entirely filling the nuclear cavity. The exact nature of this is difficult to determine, as it stains very faintly. The cytoplasm, like that described by Lewis for *Ricciocarpus natans*, consists of a fine reticulum thickly embedded with granules. The black globules are especially prominent around the nucleus.

The spore mother-cells are spherical, lying free in the cavity of the sporophyte, surrounded by a semi-fluid substance. In all sporophytes found at this stage, the spore mother-cells were not crowded, there often being the width of a cell between one and its neighbours. The next stage observed (Fig. 27) shows the nucleus somewhat enlarged and elongated. Fibres are seen around the nucleus, and in a section showing the surface of this nucleus fibres extend across it. The chromatin is in the form of irregular lumps. Little is seen in the nucleus besides these lumps of densely staining chromatin. The formation of the spindle, from the stage seen in Fig. 27, was not observed. Some of the spindles found had decidedly pointed poles, but there was no indication of a centrosome or a centrosphere. The metaphase is seen in Fig. 28. The chromosomes appear as irregular dots, but are very short, curved rods. The cytoplasm in this and succeeding divisions remains the same. The spindle fibres are very distinct, some

reaching from pole to pole, others ending at the equator, or diverging there into the cytoplasm. Fig. 29 shows the chromatin in irregular lumps at the poles. The spindle fibres are definite only to the equator, which appears granular. In Fig. 30 the daughter nuclei are formed with a definite nuclear membrane. They occupy a position very near the wall of the spore mother-cell. Spindle fibres still connect the nuclei, some extend into the cytoplasm. There is a suggestion of cell-plate formation. The chromatin is in one or more irregular clumps, which are embedded in a faintly staining reticulum. The next figure (Pl. XXXVIII, Fig. 31) shows the nuclei in practically the same condition as in Fig. 30, and still very near the periphery of the spore mother-cell. An indefinite cell-plate is observed. A few spindle fibres extend from the daughter nuclei to the cell-plate. The cell-plate does not take in the complete diameter of the cell. In Fig. 32 the daughter nuclei have moved from the wall of the mother-cell, and now occupy an almost median position in either half of the cell. The cell-plate is distinctly granular, and extends only partly across the cell.

The second division in the spore mother-cell was found to be simultaneous in the two daughter nuclei. The spindles may lie in the same plane or at right angles to each other (Figs. 33 and 34). The spindle fibres are plainly seen, especially those apparently attached to the chromosomes. The spindle tapers to a point at the poles. The chromosome appears as a small, irregular-shaped lump, with a suggestion of a curve. In the polar views in Figs. 33 and 34, eight chromosomes are counted. No definite cell membrane was seen dividing the cell, although there is a suggestion of cleavage in the contents of the mother-cell between the dividing nuclei, indicating that a persistent cell-wall may or may not be formed in the first mitosis. Fig. 35 shows the formation of two of the daughter nuclei from the second division. The spindle fibres are distinct, but there is no indication of a cell-plate, although the cell contents appear divided. The daughter nuclei are small, with a very definite nuclear membrane. The chromatin is scanty, in several irregular lumps. There has been a gradual decrease in the size of the nucleus from spore mother-cell to spore. No centrospheres or centrosomes were seen in any stage in the division of the spore mother-cell.

#### DEVELOPMENT OF THE SPORE.

The development of the protective coverings of spores and pollen-grains has received attention by numerous investigators since the publication of Strasburger's work (39) in 1882. A paper by Fitting (21) gave an impetus to further research, by his conclusion that the spore coats in *Isoetes* and *Selaginella* were formed independently of any direct connexion with the protoplasm of the spore. Miss Lyon (34), in studying the spore coats of

*Selaginella apus* and *S. rupestris*, finds the protoplasm is in contact with the membrane-forming coats at every point. Beer (6), in the same year ('05), supports Fitting's theory, observing the same condition in *Oenothera* as does Tischler (41) for *Mirabilis Jalapa*. Beer (7) believes that the spines and rodlets of pollen-grains of *Ipomoea purpurea*, Roth., develop independently of any direct protoplasmic influence. Beer (5) describes the development of the spores of *Riccia glauca* as follows: Upon the primary spore mother-cell walls secondary and later tertiary thickening layers are deposited. The secondary thickening layer is more or less mucilaginous. It sometimes separates completely from the primary wall. A plug of mucilage was observed just within the first spore wall at the equatorial rim. It has no direct relation to the developing layers. The second spore wall has three well-defined regions: an external, loosely laminated region, within this a dark layer, and an internal, densely laminated region. The endospore is formed later. Separating it and the second spore wall, there is often present a thin band of material. The protoplast of the spore is directly concerned in the development of the spore membrane.

Whatever the nature of the beginning of the walls in spore tetrads of *Riccia Frostii* may be, later development of the spore coat is accompanied by a close protoplasmic connexion. In general the development of the spore coats is similar to that described by Beer for *Riccia glauca*. The immature spore tetrad is shown in Fig. 36, with definite walls separating the spores. Inside this wall, which is a thin membrane and may be designated according to Miss Lyon as the 'mother-cell membrane', a second layer is formed. This is thicker, stains faintly with gentian violet, and appears of a gelatinous nature. It is connected by homogeneous strands, which appear to be of the same nature as the cytoplasm collected around the nucleus. The nuclei are small and contain usually one large and one or more smaller nucleoli embedded in a delicate reticulum. In Fig. 37 the cytoplasm appears more granular, and is seen extending in strands to all parts of the spore wall. Inside of the homogeneous gelatinous layer, and projecting into it in numerous small points, a layer develops which ultimately becomes the rough outer coat of the spore. The beginning of another layer is also distinguished inside of it. In the next figure (Fig. 38) the projections have become more pronounced. The layer inside this appears striated. This layer corresponds to the second spore wall in *R. glauca* described by Beer. Eventually the endospore is formed. The developing exospore is yellow, then orange, and finally black. The sculpturing of this outer coat is shown in Fig. 39 in a surface view of a spore, and the projections correspond to cross-sections of an irregular system of ridges. No spores were observed except in the tetrad form, and the triangular appearance may not be characteristic of the individual spore. The plug of mucilage described by Beer for *R. glauca* was not observed in

*Riccia Frostii*. The spore contains scanty cytoplasm, but is filled with food material, largely in the form of oil.

#### THE SPERMOGENOUS CELL.

Numerous writers have observed that all of the cells in a given segment of an antheridium descended from one cell divide at the same time. In a large antheridium many stages may be found, and particularly successive stages. Inasmuch as the sperms are mature about the same time, the divisions in different parts of the antheridium follow one another closely. The nuclei in all of the spermo-genous cells are comparatively large, almost filling the cell.

The spermatogenesis of *Riccia Frostii*, Aust., is difficult to follow, owing to the extreme smallness of the cells and their consequent blurred aspect when examined under high powers. A typical resting-stage similar to that in sporogenous cells was not observed in the cells in spermo-genous tissue, nor was any stage found where a definite nucleolus could be distinguished. The most common condition is that shown in Fig. 40. The chromatin, which is abundant, is grouped in the centre of the nucleus in a number of irregular lumps. The rest of the nucleus, which is, on the whole, denser than the cytoplasm, is finely granular, or may have a definite reticulum. It appears homogeneous, and nothing could be seen distinctly in nuclei at this stage, except the mass of chromatin, which stains deeply. The cytoplasm is uniformly granular. Two cells in early prophase are shown in Fig. 41. The chromatin is seen in a network of irregular lumps, evenly distributed in the nucleus; in one of them (*a*) a central lump is present which resembles a nucleolus, but as the cells are small and some of the lumps quite large, it is possible that this body is a mass of chromatin which appears more globular than the others.

In Fig. 42 the chromatin has formed a definite thread or spireme. By focusing, this thread could be distinguished towards the periphery of the nuclear membrane, and is evidently the hollow spireme stage. The next observed stage is seen in Fig. 43. The spireme has evidently shortened and thickened, then segmented. The chromosomes are collected in the centre of the nucleus. The cytoplasm is uniformly granular. In Fig. 44 the nucleus is slightly elongated, and fibres extend beyond it, resembling polar caps. These fibres eventually replace the nuclear membrane (Figs. 45 and 46), and presumably are attached to the chromosomes. In Fig. 46 the separate chromosomes are distinguished a little more plainly than in Fig. 45. The chromosomes, which appear as round, irregular lumps, are grouped at the equator (Figs. 47 and 48); the daughter chromosomes are always opposite. The spindle is pointed. Frequently a broad-poled spindle is seen, as in Figs. 52-54. The chromosomes appear as short, curved rods, as seen in the polar view (Figs. 49-51), and are eight in number. An interesting

characteristic of the chromosome is that in larger cells the chromosomes are longer and comparatively slender, while in smaller cells they are short, thick rods, with a slight curve, as shown in Pl. XXXVII, Fig. 24, and Pl. XXXVIII, Figs. 49 and 51. Fig. 48 shows two adjacent cells in metaphase. No stage was found showing the chromosomes on their way to the poles. Figs. 55 and 56 show stages in late telophase.

The cells, previous to the diagonal division, were examined with particular reference to centrosome-like bodies. Frequently a spindle would be found with rather significant bodies at either pole, as represented in Fig. 48. Other granules, however, were found scattered through the cytoplasm, and, since optical phenomena would naturally make granules in a polar position appear more distinct, the presence of a definite body at the poles was considered doubtful in prediagonal mitoses.

#### THE DIAGONAL DIVISION.

The spermatogenous cell previous to the last division is extremely small. With successive divisions in the spermatogenous tissue the cells become smaller, and finally the oblique division is initiated. The nucleus (Fig. 57) is so small and stains so deeply, that little chromatin can be distinguished in it. No bodies at the poles could be demonstrated. But in Figs. 58 and 59 the nucleus is found to be elongated in the direction of the diagonal axis of the cell, and at either pole is a definite body. Frequently more than one granule was found at or near the poles. These granules are apparently of kinoplasmic origin, and are no doubt a response to the same stimulus that is later realized in the blepharoplast, although not necessarily a definite phase in the development of the blepharoplast. The chromatin consists of a few scattered lumps, the forming chromosomes. The spindle is eventually formed, with a body at each pole (Fig. 60). The chromatin is collected at the equator, and in Figs. 61 and 62 the complete spindle is diagonally placed in the cell with the bodies terminating the axes. Polar views in Figs. 63 and 64 show the short curved chromosome.

Many spindles were seen in which it was impossible to distinguish a body at the poles, even with repeated staining. No stage was found showing the telophase or construction of the daughter nuclei. If a cell plate is suggested it does not persist, as the triangular cells resulting from the last division are found enclosed in the wall of the sperm mother-cell, with no wall separating them (Fig. 66). The polar granules disappear with the completion of the mitosis (Fig. 65). No evidence was found that they persist in the final oblique division, becoming the blepharoplasts.

There appears in these triangular cells a definite body, much more definite than the one discussed previously (Fig. 67). This body may occur in opposite angles of the two cells or in the same angle (Figs. 66 and 68). About this time the cell-walls break down and the triangular cells are free.

They may lose their triangular shape, as seen in Figs. 69 and 70, and eventually become somewhat rounded. Meantime, the body at the poles begins to elongate slightly, as shown in the same figures and in Fig. 66. This body is the origin of the blepharoplast.

#### THE DEVELOPMENT OF THE SPERM.

The development of the sperm in *Riccia Frostii* adds little that is new. The blepharoplast grows from an end which may be called the head or anterior end, and which is slightly larger than the posterior portion. It develops as an irregular cord, appearing somewhat granular (Figs. 71 and 72). Figs. 73-75 show the blepharoplast in different positions. In Fig. 73 it is seen on the edge of the plasma membrane; in Fig. 74 a different angle is obtained, and the cord-like nature of the blepharoplast is observed. This figure is just reversed in Fig. 75, and the two ends of the blepharoplast are seen coming up from under the cell. The developing cell may be a somewhat elongated narrow cell, as seen in Figs. 71-75, or it may become spherical, as in Figs. 76-78. About this time a vacuole usually appears in the cytoplasm opposite the nucleus (Figs. 72, 76, and 77). This vacuole finally reaches the periphery of the cell (Figs. 79 and 80). The blepharoplast is now a cord extending about three-fourths of the way around the cell. The next step is the elongation of the nucleus, which becomes homogeneous, stains brilliantly with anilin safranin, and assumes the shape of a crescent (Fig. 80). The position of the nucleus also changes. In Fig. 80 the nucleus occupies the edge of the cell and is in contact with the blepharoplast. In Fig. 81 two cilia are seen developing from the blepharoplast, which is a narrow band connecting the head with the nucleus. The nucleus is a slender crescent and stains homogeneously. No distinction can be seen between the nucleus and blepharoplast, and it is impossible to tell how far the blepharoplast extends along the nucleus in this and succeeding figures. The crescent shape of the entire cell may be aided by the vacuole (Figs. 79-81).

Figs. 82 and 83, of a somewhat similar stage as Fig. 81, show two cilia grown out from the blepharoplast just back of the head. The head is a prominent part of the sperm, always staining more intensely than other parts. The cilia extend a little more than the circle of the sperm. In Fig. 84 the crescent-shaped nucleus is seen with the blepharoplast extending from the anterior end as a slender cord terminating in the darkly-staining head. Two cilia are attached at the base of the head and circle around the nucleus. In the curve of the nucleus is the somewhat granular cytoplasm. No extension of the blepharoplast is distinguished at the other extremity of the nucleus. The remaining cytoplasm or vesicle sometimes persists in a coil of the nucleus (Figs. 87 and 88), or it may disappear early (Fig. 86). As the sperm matures the blepharoplast becomes long, extending as a fine



cord some little distance beyond the nucleus (Figs. 85–90). Both nucleus and blepharoplast elongate considerably, the nucleus thins and has about one and one-half coils, the cilia elongate, and the head persists as a distinct part of the sperm. Figs. 89 and 90 show the oldest sperms found in the antheridia. They may become more slender and more or less coiled just before they are discharged. The mature sperm then consists of the following parts: a homogeneous nuclear portion, the transformed nucleus of the sperm cell, and the cytoplasm, represented by a blepharoplast terminating in a head and bearing two cilia. A small amount of cytoplasm may persist as a vesicle.

In animal cells, the centrosome has been well established. The centrosome or the modified centrosome becomes an essential part of the mature animal spermatozoon (Wilson (47)). Chamberlain, in 'Mitosis in *Pellia*', concludes that centrosomes, centrospheres, and blepharoplasts are historically related, and with their radiations, spindle fibres, and cilia are only different manifestations of kinoplasmic activity—movement in all cases being the principal function. Webber (44, 45, 46) does not consider the origin of the blepharoplast in *Zamia* a centrosome. Ikeno (26) considers the bodies found at the poles in *Marchantia* centrosomes, and that the centrosomes persist in the last division, becoming the blepharoplasts. Lewis does not believe the presence of the polar granules in spermatogenous tissue in *Riccio-carpus natans* sufficient to warrant considering them true centrosomes. Woodburn (48) does not believe that the bodies occurring at the poles in the last division of *Marchantia* and *Fegatella* are true centrosomes, inasmuch as they have no genetic continuity, and in appearance and behaviour are not characteristic of centrosomes. Escoyez (15), in *Marchantia*, finds only in the last division the bodies which by their form and position resemble centrosomes. He adds that they are not true centrosomes, but organs *sui generis*, the blepharoplasts. Mottier (37), in discussing the homology of the blepharoplast and the centrosome, maintains that organs, to be homologous, must be organs in a morphological sense.

In a paper by Allen (1) on *Polytrichum Juniperinum*, Willd., the name 'androcyte' is suggested for the cell which will become the antherozoid. The cells of the penultimate generation are then the 'androcyte' mother-cells, while a member of any other cell-generation within the antheridium is termed an 'androgone'. The last division is not diagonal. Kinoplasmic bodies appear in the cytoplasm of the 'androgones' as irregular plates or membranes. They are designated as 'polar plates', and are distinguished before there is any visible preparation for mitosis in the nucleus. The polar plate is divided transversely, and the daughter plates occupy positions on opposite sides of the nucleus. The spindle fibres grow out from them. These kinetosomes are considered by Allen to be unorganized masses of material used in the formation of the spindle fibres and cell plate. They remain during mitosis and are transferred from mother to daughter cell.

The mitoses in the antheridial cells are further distinct from ordinary nuclear divisions by a swelling of the nucleus during a certain stage in the prophase and its final shrinkage. A definite body, from which fibres radiate, appears in the 'androcyte' mother-cell, and is referred to as a 'central body'. The 'central body' gives rise to two, which move apart and lie at opposite sides of the nucleus. They eventually occupy the poles of the spindle rudiment. As the nucleus swells and its membrane comes in contact with the central bodies, the further definition of these bodies becomes somewhat difficult. A definite body is found in each daughter cell, usually in the position of the former spindle-pole. This body is the blepharoplast. On p. 155 Allen says, 'This position of the blepharoplasts, together with the other evidence already presented, seems to place beyond reasonable doubt the persistence during mitosis of the central bodies of the androcyte mother-cell and their identity with the blepharoplasts'; and, again, on p. 176: 'Whatever its homologies, the blepharoplast of *Polytrichum* is plainly a kinoplasmic body, manufactured out of materials already present in the "androcyte" mother-cell, perhaps from some of the very substance which in the "androgones" took the form of kinetosomes. But the blepharoplast is a definitely individualized cell organ, which the kinetosomes apparently are not; and although it is newly formed at a particular stage in ontogeny, there can be little doubt that it is an ancient structure phylogenetically.'

In this connexion it may be of interest to mention a paper by Balls (3) on the cytology of Egyptian Cotton. The separation of the chromosomes is affected by a conspicuous 'thread ring', to which the chromosomes are attached by means of spindle fibres. The insertions of the spindle fibres in the 'thread ring' appear as dots. The contraction of the dotted portion of the 'thread ring' gives rise to the bipolar spindle. In the telophase the chromosomes are retracted into the ring and the second division follows. In this way the continuity of the 'thread ring' is established. Balls 'hopes that the results obtained by the study of the fate of achromatic structures in higher plants will ultimately be translated into terms of the specialized centrosome of the lower plants and animals'.

The polar granules in *Riccia Frostii* have not been demonstrated as a constant factor in mitosis, and even where found they do not have genetic continuity. They have been observed only in the final spermatogenous division. No definite origin could be determined for them. While the polar granule appears to play the part of a centrosome in cell division, in its behaviour and history it lacks many of the points which have been considered essential in a true centrosome. Until the qualities which are essential to a proper terminology of such bodies have been sufficiently demonstrated, it seems a little premature to designate the bodies in *Riccia Frostii*, Aust., as anything more definite than simply polar granules. The

granule could not be shown to be the *Anlage* of the blepharoplast except for its position, for with the completion of the diagonal division it seems to disappear, and in an angle of the sperm cell there arises a more definite body which becomes the blepharoplast.

#### SUMMARY.

1. The thallus of *Riccia Frostii*, Aust., is dioecious. Growth by means of apical cells results in a circular thallus or rosette attached to the ground by simple rhizoids.

2. The air-chambers originate by the upward growth of adjacent filaments surrounding a depression at their junction. They are of various sizes. The mature air-chamber consists of a long, canal-like space separated by plates of chlorophyll-bearing tissue, one cell in thickness.

3. Sexual organs are produced early, and continue to be produced with the development of the thallus. There is no definite grouping of the reproductive organs. The development of the reproductive organs is similar to that of other species of *Riccia*.

4. The resting nucleus of the spore mother-cell contains a large nucleolus surrounded by a very fine network. The nucleus in the successive mitoses gradually decreases in size. No centrosomes or centrospheres are found in dividing spore mother-cells.

5. The spore contains a very small nucleus, surrounded by food material, largely in the form of oil. Two protective coverings are developed, due to the activity of the protoplast. The endospore is formed later. The sculpturing of the outer coat consists of an irregular system of ridges.

6. The last division in spermogenous tissue is placed diagonally in the cell, and is sometimes accompanied by granules at the poles. No cell-wall was found between the resulting triangular walls.

7. The blepharoplast is first distinguished in an angle of the cell as a sharply differentiated part of the cytoplasm. No evidence was found that showed the origin of the blepharoplast to be the polar granule in the preceding mitosis.

8. In the developing sperm the blepharoplast elongates as a cord. The nucleus assumes a crescent shape and becomes homogeneous. The cord-like blepharoplast becomes closely applied to the nucleus, extending from it as a narrow thread, terminating in a conspicuously thickened part or head from which two cilia are produced.

9. The mature sperm consists of a homogeneous nuclear portion, the transformed nucleus of the sperm cell, and the cytoplasm represented by a blepharoplast terminating in a head and bearing two cilia. A small amount of cytoplasm may persist as a vesicle.

10. The number of chromosomes is eight for the gametophyte, and sixteen for the sporophyte.

11. An abnormal sporophyte was observed, caused by bacterial invasion.

The writer wishes to express her heartiest appreciation to Dr. David M. Mottier, at whose suggestion this study was carried on, for his assistance and kindly advice throughout its progress.

INDIANA UNIVERSITY,  
BLOOMINGTON, INDIANA.

#### LITERATURE.

1. ALLEN, CHARLES E.: Cell Structure, Growth, and Division in the Antheridia of *Polytrichum juniperium*. *Archiv für Zellforschung*, viii, Heft 1, 1912, pp. 121-88.
2. AUSTIN, C. F.: *Bull. Torr. Bot. Club*, vi, No. 3, 1875, p. 17.
3. BALLS, W. LAWRENCE: The Mechanism of Nuclear Division. *Ann. Bot.*, xxiv, 1910, pp. 653-65.
4. BARNES, C. R., and LAND, W. J. G.: In *Bryological Papers, The Origin of Air-chambers*. *Bot. Gaz.*, xlv, 1907, p. 213.
5. BEER, RUDOLF: On the Development of Spores of *Riccia glauca*. *Ann. Bot.*, xx, 1906, pp. 275-91.
6. ———: On the Development of the Pollen Grain and Anther of some Onagraceae. *Beih. z. Bot. Centralbl.*, Abt. 19, i, Heft 2, 1905, pp. 286-313.
7. ———: Studies in Spore-Development. *Ann. Bot.*, xxv, 1911, pp. 199-214.
8. BISCHOFF, G. W.: Bemerkungen über die Lebermoose, vorzüglich aus den Gruppen der Marchantien und Riccien. *Acad. Caes. Leop., Nova Acta*, xvii, 1835, pp. 909-1088.
9. CAMPBELL, D. H.: *Mosses and Ferns*. Macmillan & Co., 1905.
10. CAVERS, F.: Explosive Discharge of Antherozoids in *Fegatella conica*. *Ann. Bot.*, xvii, 1903, pp. 270-4.
11. CHAMBERLAIN, C. J.: Mitosis in *Pellia*. *Bot. Gaz.*, xxxv, 1903, pp. 28-51, Pl. XII-XIV.
12. DAVIS, B. M.: The Spore Mother-Cell of *Anthoceros*. *Bot. Gaz.*, xxviii, 1899, p. 89.
13. ———: Nuclear Studies on *Pellia*. *Ann. Bot.*, xv, 1901, pp. 147-180.
14. DURAND, E. J.: The Development of the Sexual Organs and Sporogonium of *Marchantia polymorpha*. *Bull. Torr. Bot. Club*, xxxv, 1908, pp. 321-36, Pl. XXI-XXV.
15. ESCOYEZ, EUD.: Blépharoplaste et centrosome dans le *Marchantia polymorpha*. *La Cellule*, xxiv, 2<sup>e</sup> fas., 1907, pp. 247-56.
16. FARMER, J. B.: Studies in Hepaticae: On *Pallavicinia decipiens*, Mitten. *Ann. Bot.*, viii, 1894, pp. 35-52.
17. ———: Spore-Formation and Karyokinensis in Hepaticae. *Ann. Bot.*, ix, 1895, pp. 363-4.
18. ———: On Spore-Formation and Nuclear Division in Hepaticae. *Ann. Bot.*, ix, 1895, pp. 469-524.
19. ——— and REEVES, J.: On the Occurrence of Centrospheres in *Pellia epiphylla*, Nees. *Ann. Bot.*, viii, 1894, pp. 219-24.
20. FELLNER: Über die Keimung der Sporen von *Riccia glauca*. *Jahresber. d. Acad. d. Naturw. Vereines in Graz*, 1875.
21. FITTING, HANS: Bau und Entwicklungsgeschichte der Makrosporen von *Isoetes* und *Selaginella*, &c. *Bot. Zeit.*, lviii, 1900, pp. 107-64.

22. GARBER, J. F. : The Life-history of *Ricciocarpus natans*. Bot. Gaz., xxxvii, 1904, pp. 161-77.
23. GOEBEL, K. : Organography of Plants, Part II. English Edition, 1905.
24. HIRSH, PAULINE E. : The Development of Air Chambers in the Ricciaceae. Bull. Torr. Bot. Club, xxxvii, 1910, p. 73.
25. HOFMEISTER, W. : Vergleichende Untersuchungen der höheren Kryptogamen. English translation. The Higher Cryptogamia, Ray Society, 1862.
26. IKENO, S. : Die Spermatogenese von *Marchantia polymorpha*. Beihefte zum Botanischen Centralblatt, xv, 1903, pp. 65-88.
27. JANCZEWSKI, E. VON : Vergleichende Untersuchungen über die Entwicklungsgeschichte des Archegoniums. Bot. Zeit., 1873, xxx.
28. JUEL, O. : Ueber den anatomischen Bau von *Riccia Bischoffii*, Hub. Svensk. Bot. Tidsk., iv, 1910, pp. 160-6.
29. KING, C. A. : Explosive Discharge of Antherozoids in *Conocephalum*. Torrya, iii, 1903, pp. 60-1.
30. KNY : Über Bau und Entwicklung der Riccieen. Jahrb. f. wiss. Bot., v, 1866-67, pp. 364-86.
31. LEWIS, C. E. : The Embryology and Development of *Riccia lutescens* and *Riccia crystallina*. Bot. Gaz., xli, 1906, pp. 109-38.
32. LEITGE, H. : Untersuchungen über die Lebermoose. 4. Die Riccieen, 1879, pp. 1-101.
33. LINDENBERG, J. B. W. : Monographie der Riccieen. Acad. Caes. Leop., Nova Acta, xviii, 1836, pp. 361-504.
34. LYON, FLORENCE : The Spore Coats of *Selaginella*. Bot. Gaz., xl, 1905, pp. 285-95.
35. MOORE, A. C. : The Mitosis in the Spore Mother-Cell of *Pallavicinia*. Bot. Gaz., xxxvi, 1903, pp. 384-8.
36. MOTTIER, D. M. : Beiträge zur Kenntniss der Kerntheilung in den Pollen-Mutterzellen einiger Dikotylen und Monokotylen. Jahrb. wiss. Bot., xxx, 1897, pp. 169-204.
37. ————— : The Development of the Spermatozoid in *Chara*. Ann. Bot., xviii, 1904, pp. 245-54.
38. PEIRCE, G. J. : Forcible Discharge of Antherozoids in *Asterella Californica*. Bull. Torr. Bot. Club, xxix, 1902, pp. 374-82.
39. STRASBURGER, E. : Ueber den Bau und das Wachsthum der Zellhäute. Jena, 1882.
40. THURET, G. : Discharge of Antherozoids in *Fegatella*. Mém. de la Soc. des Sciences nat. de Cherbourg, iv, 1856, p. 216.
41. TISCHLER, G. : Zellstudien an sterilen Bastardpflanzen. Archiv f. Zellforschung, i, Heft 1, 1908, pp. 33-151.
42. UNDERWOOD, L. M. : Systematic Botany of North America : Hepaticae, ix, Part 1, 1895.
43. VAN HOOK, J. M. : Notes on the Division of the Cell and Nucleus in Liverworts. Bot. Gaz., xxx, 1900, p. 394.
44. WEBBER, H. J. : Peculiar Structures occurring in the Pollen-tube of *Zamia*. Bot. Gaz., xxiii, 1897, pp. 453-59.
45. ————— : The Development of the Antherozoids of *Zamia*. Bot. Gaz., xxiv, 1897, pp. 16-22.
46. ————— : Notes on the Fecundation of *Zamia* and the Pollen-tube-Apparatus of *Ginkgo*. Bot. Gaz., xxiv, 1897, pp. 225-36.
47. WILSON, E. B. : The Cell in Development and Inheritance. Macmillan & Co., 1906.
48. WOODBURN, WM. L. : Spermatogenesis in certain Hepaticae. Ann. Bot., xxv, 1911, pp. 299-313.

## EXPLANATION OF FIGURES IN PLATES XXXVII AND XXXVIII.

Illustrating Miss Black's paper on *Riccia Frostii*.

Fig. 1-5 were photographed by Miss C. F. Kephart. Magnification 4 diameters.

All drawings were made with the aid of a camera-lucida. A Zeiss microscope was used with apochromatic objectives 16, 8, 4 and 2 mm. n. A 1.30, and compensating oculars 4, 8, 12, and 18. The drawings were made on a drawing-board, except those of spermatogenesis, which were drawn at table level.

## PLATE XXXVII.

- Fig. 1. Complete thallus, illustrating the typical compact rosette.  
 Fig. 2. A thallus, showing irregular growth.  
 Fig. 3. A portion of a young thallus, illustrating the prominence or individual lobes of the plant.  
 Fig. 4. Part of a complete rosette, showing how the thallus separates along the original divisions.  
 Fig. 5. A young thallus, showing irregular growth.  
 Fig. 6. Longitudinal section through the growing end of the thallus, showing the wedge-shaped apical cell. The origin of the air-chambers is shown in the depressions between the cells.  $\times 500$ .  
 Fig. 7. A transverse section cut through the growing end of the thallus, showing the two growing points. The young cell rows are in an inclined, almost horizontal, position.  $\times 250$ .  
 Fig. 8. Cross-section of the mature air-chambers, showing irregular polygonal shape and varying size.  $\times 250$ .  
 Fig. 9 *a*. The stalk mother-cell and the mother-cell of the antheridium proper. Antheridium initial projects slightly.  $\times 500$ .  
 Fig. 9 *b*. Young antheridium, becoming embedded in sex-organ pit.  $\times 500$ .  
 Fig. 10. Young antheridium scarcely projecting above the surface.  $\times 500$ .  
 Fig. 11. Antheridium, showing characteristic tip cells of surrounding filaments.  $\times 500$ .  
 Fig. 12. Cutting off of the antheridial wall.  $\times 500$ .  
 Fig. 13. End cells of filaments adjacent to antheridium have formed a canal leading to the antheridium.  $\times 250$ .  
 Fig. 14. First division of primary cell of archegonium.  $\times 500$ .  
 Fig. 15. Two-celled archegonium.  $\times 500$ .  
 Fig. 16. Three-celled archegonium.  $\times 500$ .  
 Fig. 17. Fertilization.  $\times 500$ .  
 Fig. 18. Resting condition of the fertilized egg.  $\times 500$ .  
 Fig. 19. Three-celled embryo.  $\times 500$ .  
 Fig. 20. Small globular embryo.  $\times 250$ .  
 Fig. 21. Oval embryo.  $\times 250$ .  
 Fig. 22. Abnormal sporophyte affected by bacterial invasion.  $\times 500$ .  
 Fig. 23. Sporophyte with spore mother-cells. The amphithecium is partly disorganized.  $\times 250$ .  
 Fig. 24. Polar views of the metaphase in a dividing sporophyte cell, showing sixteen long curved chromosomes.  $\times 2250$ .  
 Fig. 25. Telophase of a dividing sporophyte cell.  $\times 2250$ .  
 Fig. 26. Resting-stage of the spore mother-cell, showing the prominent nucleolus and the delicate network around it.  $\times 1,500$ .  
 Fig. 27. Nucleus of spore mother-cell somewhat elongated, with fibres around the nuclear membrane. The chromatin is in irregular lumps.  $\times 1,500$ .

Fig. 28. Metaphase in the spore mother-cell. The chromosomes are seen as densely staining granules. The poles of the spindles are well defined.  $\times 1,500$ .

Fig. 29. Telophase. Spindle fibres are distinct only to the equator, which is somewhat granular.  $\times 1,500$ .

Fig. 30. Formation of the daughter nuclei. Indication of cell plate shown. Spindle fibres very distinctly seen.  $\times 1,500$ .

PLATE XXXVIII.

Fig. 31. The cell plate is more distinct than in Fig. 30.  $\times 1,500$ .

Fig. 32. The daughter nuclei have moved from the periphery of the spore mother-cell wall, and occupy a median position between it and the cell plate. The cell plate appears as a granular line, and does not extend entirely across the cell.  $\times 1,500$ .

Fig. 33. Metaphase of the daughter nuclei. Spindles are in the same plane. Polar view of chromosomes shows the reduced number to be eight.  $\times 1,500$ .

Fig. 34. Similar stage to Fig. 33, showing one spindle. The spindle is small and tapers to a point at the poles.  $\times 1,500$ .

Fig. 35. Formation of the daughter nuclei.  $\times 1,500$ .

Fig. 36. Spore tetrad. Nuclei are very small, with the chromatin in one or more lumps.  $\times 1,000$ .

Fig. 37. A heavy line is formed inside of the gelatinous layer. This becomes eventually the outer spore wall.  $\times 1,000$ .

Fig. 38. Inside of the rough spore wall another layer is added. This layer appears striated. Contents of cell becoming more granular.  $\times 1,000$ .

Fig. 39. Surface view of almost mature spore, showing sculpturing of outer spore coat.  $\times 1,000$ .

*Spermatogenesis.*

The following drawings were made at table level with a magnification of about 3,000 times :

Fig. 40. Spermogenous cell with the chromatin clumped together irregularly in the nucleus. The nucleus on the whole is denser than the cytoplasm.

Fig. 41. Two cells in early prophase. The chromatin is seen in a network of irregular lumps.

Fig. 42. Hollow spireme. The nucleus almost fills the cell.

Fig. 43. The spireme is segmented and the chromosomes occupy the central part of the nucleus.

Fig. 44. The nucleus is slightly elongated.

Fig. 45. The spindles are replacing the nuclear membrane.

Fig. 46. Similar to Fig. 45. Chromosomes are more distinct.

Fig. 47. Metaphase. Well-defined spindle with pointed poles. The chromosomes are opposite each other at the equator.

Fig. 48. Stages similar to Fig. 47.

Figs. 49-51. Polar views of metaphases, showing eight chromosomes, the reduced number. The chromosomes are short, curved rods.

Figs. 52-54. Broad-poled spindles.

Fig. 55. Telophase. No polar granules observed.

Fig. 56. Formation of the daughter nuclei. Cell plate is being laid down.

Fig. 57. The spermogenous cell previous to the last division.

Fig. 58. The nucleus has elongated, and in the corners of the cells at opposite sides of the nucleus are two granules.

Fig. 59. Similar to Fig. 58.

Fig. 60. Formation of the spindle fibres. The chromatin is collected in a lump.

Fig. 61. The oblique spindle, with the chromosomes in the equatorial plate and the spindle fibres terminating in the polar granules.

Fig. 62. Similar to Fig. 61.

Figs. 63 and 64. Polar views of the oblique division, showing eight short, curved chromosomes.

Fig. 65. Two diagonal cells with no indication of the polar granules.

Fig. 66. The diagonal division completed. Sperm cells lying free within the wall of the sperm mother-cell.

Fig. 67. Diagonal cell showing definite body in one of the angles of the cell.

Fig. 68. Two sperm cells resulting from the oblique division, with the blepharoplasts in the same angle of the cell.

Figs. 69, 70. The sperm cell rounds up somewhat. The blepharoplast is elongating as a narrow cord.

Fig. 71. Sperm cells showing the elongation of the blepharoplast.

Fig. 72. Vacuole appearing in cytoplasm.

Fig. 73. Blepharoplast seen as a cord on the periphery of the plasma membrane.

Fig. 74. View of blepharoplast.

Fig. 75. View as in Fig. 74 reversed, showing the two ends of the blepharoplast.

Fig. 76. Vacuole appearing in the cytoplasm. Blepharoplast somewhat extended.

Fig. 77. Definite vacuole in the cytoplasm. Blepharoplast consists of a cord on the periphery of the cell, extending a little more than half-way round.

Fig. 78. Showing round form of developing sperm. Blepharoplast as in Fig. 77.

Fig. 79. Sperm assuming crescent shape.

Fig. 80. Nucleus becoming homogeneous, and sperm is more crescent-shaped than in Fig. 79.

Fig. 81. Nucleus homogeneous and crescent-shaped. Blepharoplast extending from it and terminating in a head from which two cilia arise. Cytoplasm caught in the curve of the nucleus.

Figs. 82, 83. Two sperms of the same stage, one with cytoplasm in the curve of the nucleus. The head is very definite and the cilia have elongated.

Fig. 84. Similar to Figs. 82 and 83. Head of sperm very definite.

Fig. 85. Sperm has elongated somewhat. Very little cytoplasm in the coil of the nucleus.

Fig. 86. Little later development. Blepharoplast, nucleus, and cilia elongated.

Fig. 87. About the same as Fig. 86, sperm with cytoplasmic vesicle.

Figs. 88, 89. Definite head, which stains deeper than any other part of sperm. In Fig. 89 nucleus and blepharoplast somewhat separated.

Fig. 90. Mature sperm, showing head, long slender blepharoplast to which nucleus is applied, and the two slender cilia.





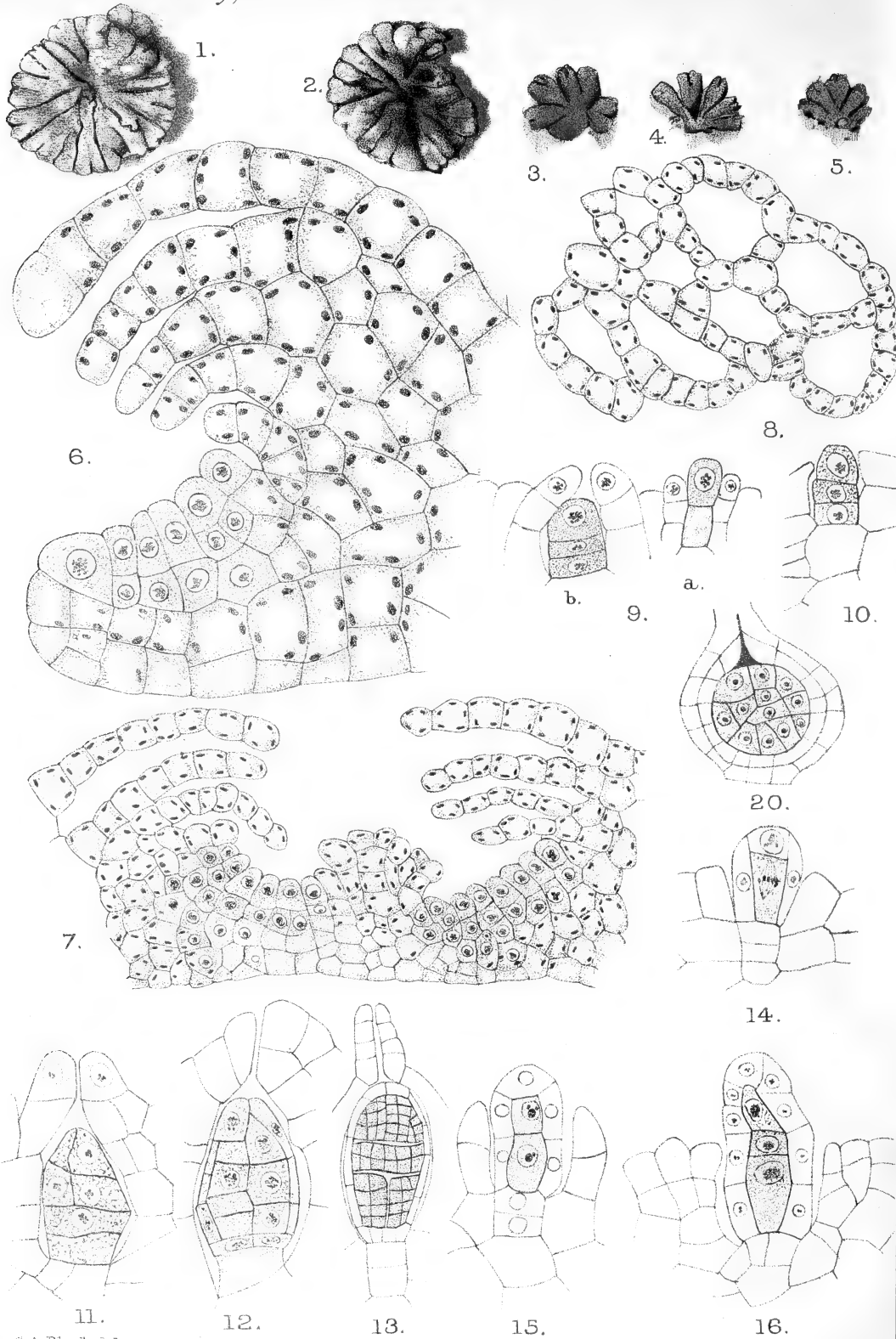

C.A. Black, del.

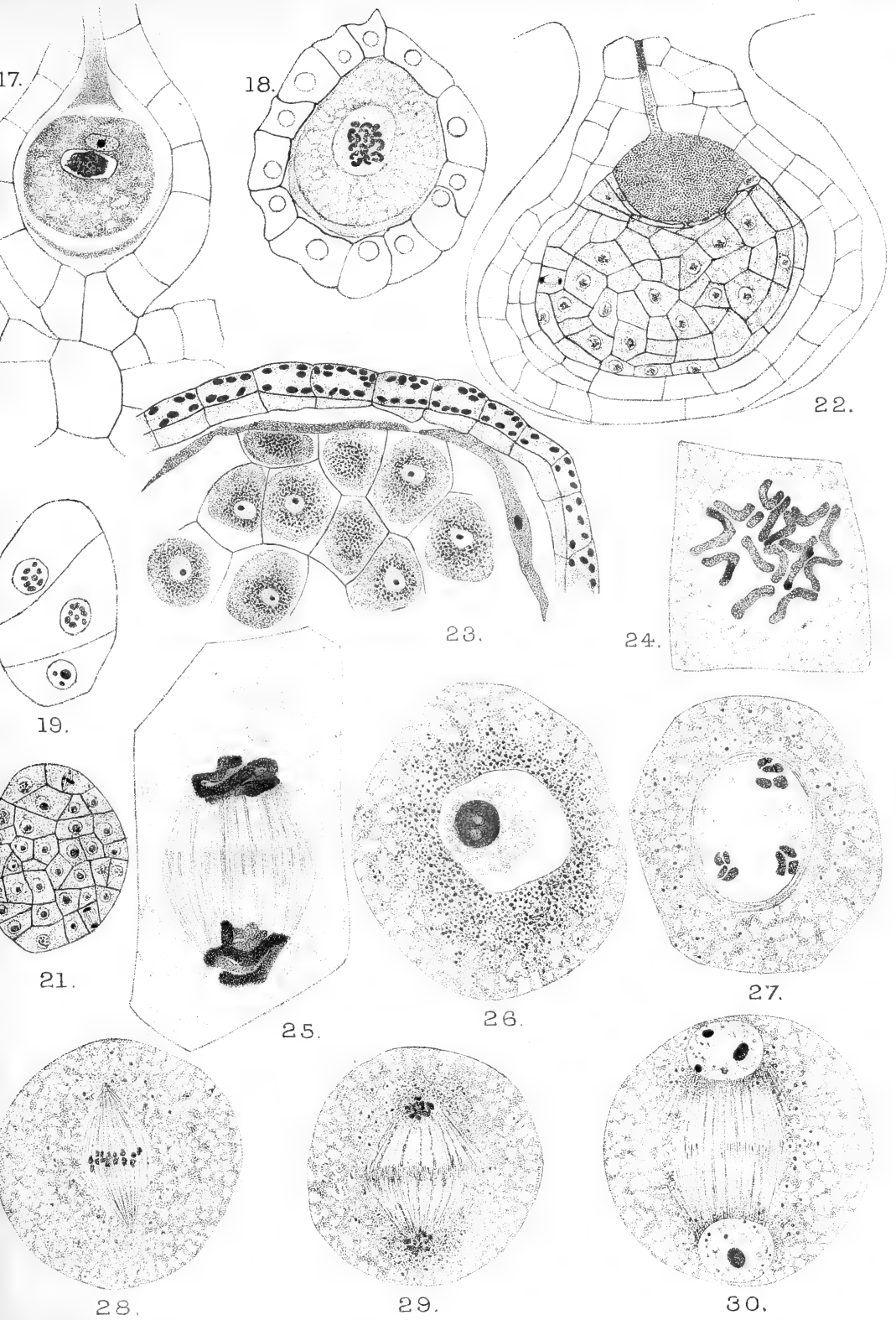



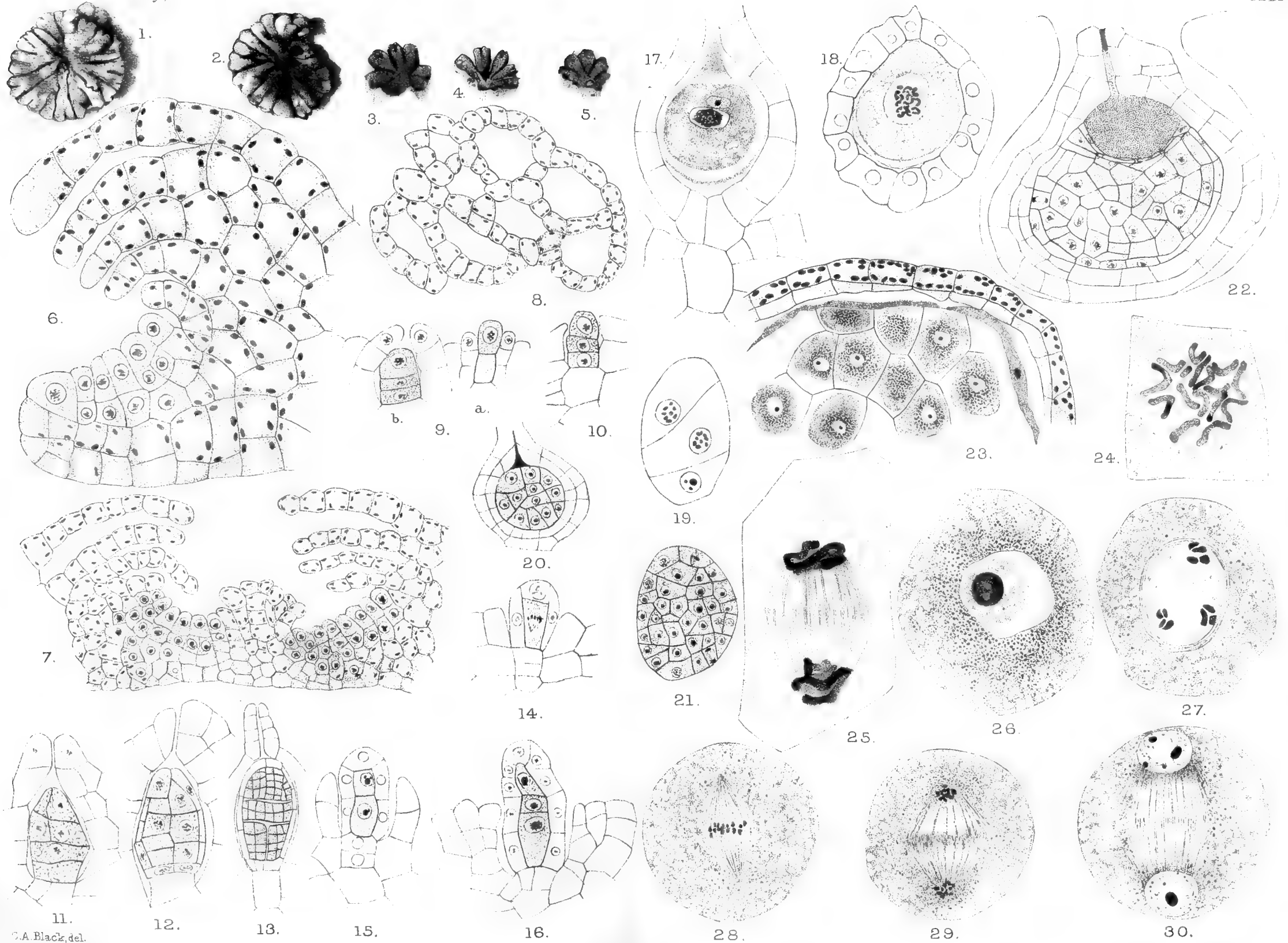

C.A. Black, del.

BLACK — RICCIA FROSTII.

Hutb, Lith London.





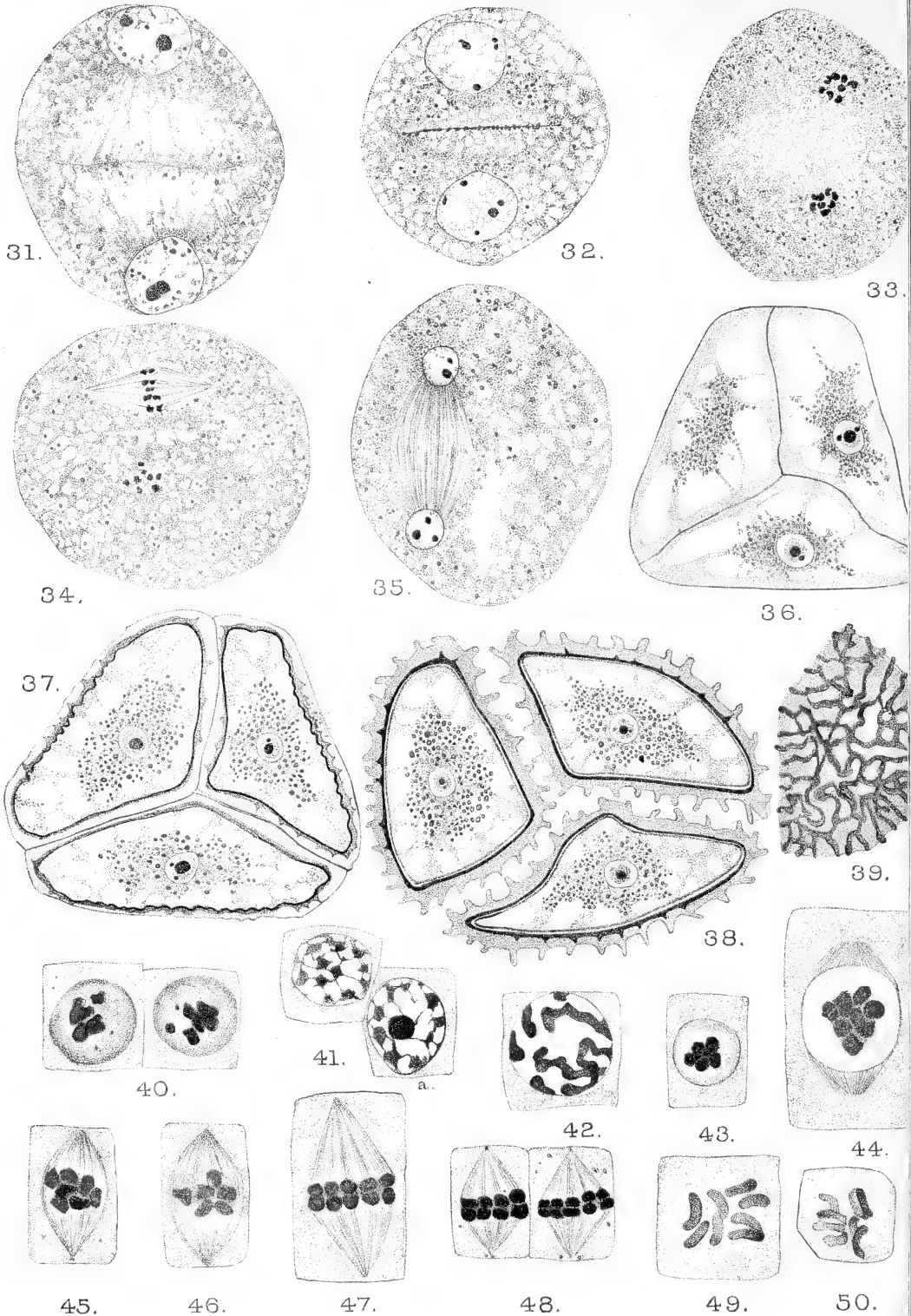

G.A. Black del.



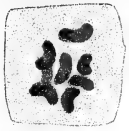

51.

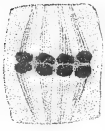

52.



53.



54.



55.



56.



57.



58.



59.



60.



61.

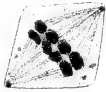

62.



63.



64.

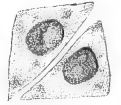

65.

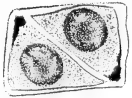

66.



67.



68.



69.



70.

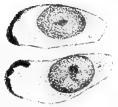

71.

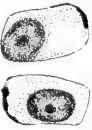

72.



73.



74.



75.



76.



77.



78.



79.



80.



81.



82.



83.



84.



85.



86.



87.



88.



89.



90.



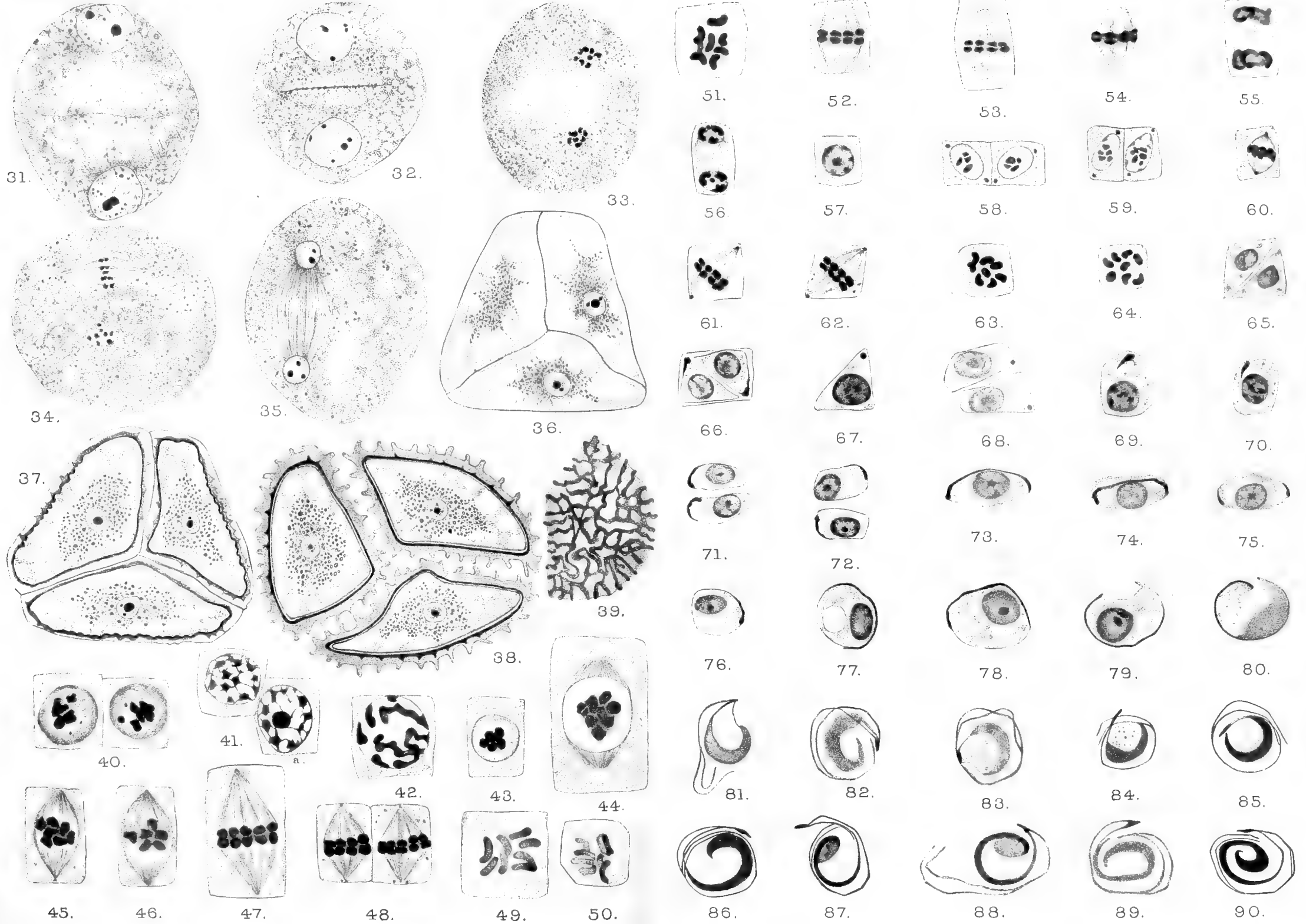

C.A. Black del.

BLACK — RICCIA FROSTII

Huth, Lith<sup>r</sup> London.



# Contributions to the Anatomy of Mesozoic Conifers.

## No. I. Jurassic Coniferous Woods from Yorkshire.<sup>1</sup>

BY

RUTH HOLDEN,

*Wilby Prize Student of Radcliffe College.*

With Plates XXXIX and XL.

**D**URING the last few years, a large number of Cretaceous woods have been investigated anatomically, and found to throw considerable light on the inter-relationships of the various families of Conifers. Structurally preserved material from the Jurassic is comparatively rarer and less known, but seems to be of even greater value than the Cretaceous from this standpoint. Especially interesting are those specimens described by Professor Seward from Yorkshire, England (1), by Gothan from King Karl's Land (2) and the island of Spitzbergen (3), and by Lignier from Normandy (4). The woods to be described in this article are all from the Jurassic of Yorkshire. They are in two conditions of preservation—petrified and lignitic. With a few exceptions, the petrified material was sent by Mr. James Lomax to Professor Jeffrey, to whom the writer is indebted for an opportunity to study it. All the lignite, on the other hand, and a small number of petrified specimens, were obtained by the writer from various localities on the Yorkshire coast. All the sections from Mr. Lomax, and representative ones of the lignitic material, are now at the University Museum, Harvard College, Cambridge, Massachusetts.

Before entering on the descriptive part, it will be apposite to consider briefly those features which have been found to be of greatest significance in diagnosing woods, especially in differentiating between the two great groups of Conifers—Araucarian and non-Araucarian, or Abietineous. The earliest classification, that of Kraus (5), was based entirely on the character of the radial pitting of the tracheides—the pits being alternating and compressed in the Araucarineae, and opposite and separated in the Abietineae and other tribes. This is the criterion used by both Seward and Lignier. Jeffrey (6), however, has shown that in the Cretaceous there were woods which combined the Araucarian type of pitting with that characteristic of

<sup>1</sup> Contributions from the Phanerogamic Laboratories of Harvard University, No. 61.

[*Annals of Botany*, Vol. XXVII, No. CVII, July, 1913.]

the Abietineae. In this type, which he called *Brachyoxyton*, some of the pits are closely compressed and flattened, while others are scattered and circular. Further (7), he has shown that in the seedling of both living Araucarian genera—*Araucaria* and *Agathis*—this *Brachyoxyton* type persists. Since there is this marked departure from the so-called Araucarian pitting even in living forms, it seems to follow that this type of pitting will be even less constant in forms which are now extinct. Accordingly it appears to be unsafe to employ this criterion exclusively in diagnosing fossil woods.

Gothan also considers of little importance the character of the tracheary pitting, for he describes as Abietineous a number of fossils with typical Araucarian pitting. His criterion is the nature of the medullary ray cells—any Conifer whose rays have thick, heavily pitted walls is Abietineous, no matter what its other structural peculiarities may be. Neither Lignier nor Jeffrey follows him here, for both have described as Araucarian specimens with pitted rays—*Cormaraucarioxyton crasseradiatum*, Lignier (op. cit.), and *Araucariopitys americana*, Jeffrey (8). Moreover, the last-mentioned writer has shown that in the cone axis of *Agathis australis*, and in traumatic wood of both *Araucaria* and *Agathis*, there are typical Abietineous rays. It seems evident that in living forms the character of the rays is as inconstant as that of the pitting of the tracheides, and is accordingly as little to be relied on in fossil forms.

The only feature which holds absolutely is the occurrence of certain cellulose<sup>1</sup> thickenings, embedded between the pits in the substance of the cell wall itself. These are the so-called 'bars of Sanio', which are present in all woods of Abietineous affinities—Abietineae, Cupressineae, Taxodineae, Podocarpaceae, and Taxineae (9)—but are invariably absent in those of Araucarian affinities, *except in the first few secondary tracheides of the cone axis of Araucaria and Agathis* (7). Since this is the only character which is perfectly constant in those Conifers existing at the present day, it appears to be the safest to choose in diagnosing fossil forms. The most striking case where this feature alone has been considered sufficient to decide the affinities of a wood is that of *Paracedroxylon*, Sinnott (10), which its founder calls Araucarian in spite of scattered pits, resin canals, and thick, pitted rays (both these last two features, however, are traumatic). It has been suggested that 'bars of Sanio' are structures too delicate to be preserved in petrified material. Such is not the case, for in many silicified specimens they are as unmistakable as in living forms. Owing to the fact that they are composed of cellulose, which speedily disappears in the course of fossilization,

<sup>1</sup> By cellulose is meant giving the ordinary cellulose reactions, e.g. a dark blue stain with iodine and sulphuric acid. Whether they are called 'bars of Sanio', or, as Professor Groom prefers, 'rims of Sanio,' is a matter of absolutely no importance as long as it is understood that they contain cellulose, and that they are embedded in the cell wall.

they appear as white lines between the pits. It is this feature which has been used in the following descriptions to differentiate between Araucarian and Abietineous woods.

ARAUCARINEAE.

*Xenoxylon phyllocladoides*, Gothan (Pl. XXXIX, Figs. 1-4).

Wood of this type composed the greater part of the lignite from Scarborough, and is, as a whole, in a perfect state of preservation. Its general character may be observed in Fig. 1; the annual rings are well marked, with but a small amount of summer wood, there is an abundance of ray parenchyma, but no wood parenchyma. The nature of the rays is shown in Fig. 2, or better, in the more highly magnified view of Fig. 4. The horizontal and end walls are thin and unpitted, while on the vertical wall communicating with the tracheides there are large 'Eiporen'. Usually there is but one, rarely two, to each cross-field. The character of the tracheary pitting is evident from Figs. 2 and 3. The pits are large, usually remote (though rarely compressed and flattened), and, instead of being circular, are elongated in a horizontal direction. When in more than a single row, they are usually opposite, but sometimes alternate. In Fig. 3 a dark spot may be seen in the centre of the mouth of each pit. In radial section it looks like a small torus, but tangential sections show that this appearance is due to a particle of dirt having become lodged there. The exceedingly large 'Eiporen' indicate that this wood is a species of *Xenoxylon* and the character of the tracheary pitting exactly resembles *Xenoxylon phyllocladoides*, Gothan. The only difference between the two consists in the shape of the ray. According to Gothan, the rays of *Xenoxylon phyllocladoides* are much higher than wide, so that in tangential section they appear oval. Such is distinctly not the case here. Figs. 1 and 2, both photographed at the same magnification, show them to be of approximately the same dimensions in the two planes, and their circular outline in tangential section proves the point. This wood seems also to be identical with *Cupressinoxylon Barberi*, Seward, from the Jurassic of Whitby, though lacking the resiniferous tracheides of that specimen. In regard to the affinities of *Xenoxylon phyllocladoides*, Gothan (2, p. 38) states that it is 'without analogy in living or fossil gymnospermous woods'. The absence of bars of Sanio, however, shows that it belongs among the Araucarian Conifers, a conclusion borne out by the occasional compressed and flattened condition of the pits, though among living Araucarian forms there are none with similar pitting of the rays.

Locality: Scarborough.

Horizon: Oolite.

*Xenoxylon latiporosum*, Gothan (Figs. 5 and 6).

Sections of this type were cut from a block of petrified wood found on the Yorkshire coast, a short distance north of Robin Hood's Bay. Fig. 5 shows a typical radial section. Like *Xenoxylon phyllocladoides*, the wood consists entirely of tracheides and rays, and the rays have one large pit which covers the entire cross-field. Unlike the former, the tracheary pits are invariably flattened and closely compressed. The extreme compression has resulted in the appearance of pits which are fully twice as wide as high (Fig. 6). When two-ranked, the pits are always alternating (Fig. 6). In every respect this specimen is identical with *Xenoxylon latiporosum*, Gothan, and must be included among the Araucarineae, both on account of the absence of bars of Sanio and the presence of alternating pitting.

Locality: Robin Hood's Bay.      Horizon: Lias.

*Paraphyllocladoxylon eboracense* (Figs. 7-9).

Figs. 7-9 show the character of this lignite. The radial pits of the tracheides are usually scattered and circular (Fig. 7), but are never separated by cellulose bars of Sanio. Tangential pitting is abundant (Fig. 9). The rays are smooth-walled, with one, rarely two, large pits to each cross-field (Fig. 8). These pits are, however, conspicuously smaller than those of *Xenoxylon* (cf. Fig. 4). In Fig. 9 several of the tracheides have dark cross-walls which give the appearance of wood parenchyma. The character of the partition shows that it is a resin plate, due to the fact that certain tracheides become filled with resin. That this resinous substance is derived from the rays is shown by the dark content of one tracheide in the centre of the field, which lies immediately next the ray. Jeffrey (7, p. 538) has referred to similar resinous exudations in the wood of living and fossil Araucarians, and suggested that this is the explanation of the apparently thick-walled tracheides situated next the rays in some of Lignier's specimens. This wood closely resembles the *Phyllocladoxylon* described by Gothan from King Karl's Land. It would seem better, however, to reserve the generic name *Phyllocladoxylon* for podocarpineous forms with these large 'Eiporen', and to use the name *Paraphyllocladoxylon* for similarly characterized Araucarians. Since this specimen is from Yorkshire, it is proposed to call it *Paraphyllocladoxylon eboracense*.

Locality: Scarborough.      Horizon: Oolite.

*Paraphyllocladoxylon araucarioides* (Fig. 10).

This material was among the specimens sent by Mr. Lomax to Professor Jeffrey. As shown in Fig. 10 the rays closely resemble those of the last-described wood. The tracheary pits, on the other hand, are



quite different, being always closely compressed and flattened. On that character it is proposed to call this specimen *Paraphyllocladoxylon araucarioides*.

*Paracupressinoxylon cedroides* (Figs. 11-14).

The sections included under this head were sent by Mr. Lomax. Fortunately, a considerable amount of material was available, so that it is possible to present a fairly complete account of this interesting wood. The pith is homogeneously parenchymatous, without any sclerotic cells or diaphragms such as occur very commonly in Mesozoic forms, both Abietineous and Araucarian (Literature 4, 6, 7, 8, and 12). The wood consists of tracheides, rays, and resiniferous elements. The tracheides are small, and rarely have more than one row of pits on the radial wall. In such cases they are alternate and compressed. When uniseriate, the pits are usually scattered and circular, though often flattened (Fig. 13). In no case was there any indication of cellulose bars of Sanio. There are also abundant tangential pits. The rays are highly resinous, and—an unusual feature in Araucarian woods—thick-walled and heavily pitted. Fig. 14 shows this character clearly. On the wall next the tracheide the pits are small and piciform, ranging from two to several to each cross-field. The resiniferous elements are of two sorts—true wood parenchyma, which is scattered throughout the year's growth, and resin-filled tracheides. The phloem is less well preserved, but there seem to be no alternately recurring zones of hard and soft bast, such as occur in the Cupressineae, for example. In the outer bark there are clusters of stone cells, and on the outside a layer of periderm.

It is evident from a study of the normal tissues that we are dealing with an Araucarian Conifer presenting a new combination of Araucarian and Abietineous features. Under these circumstances it is extremely fortunate that it is possible to investigate its traumatic reaction. One of the sections shows, at a short distance from the pith, a distinct wound-cap, from which rows of resin canals extend on each side (Fig. 11). These canals persist for some distance around the stem and then die out. The nature of this abnormal tissue may be ascertained from Figs. 11 and 12. Each duct is very wide tangentially, communicates freely with its neighbours, is constricted at short intervals, and is surrounded by a jacket of thick-walled parenchyma cells. The structure of these canals is paralleled exactly by those formed after wounding in the genera *Abies* or *Tsuga*, and indicate beyond doubt that their appearance here is an instance of traumatic reversion. It is in the vicinity of the wound that the rays are most highly resinous, and the resiniferous elements most abundant.

The affinities of this wood are not difficult to infer. The absence of cellulose bars of Sanio vouches for its Araucarian nature, and its Abietineous features show it to be another of those transitional forms so abundant

in the Mesozoic. In the formation of traumatic resin canals, it resembles *Brachyoxylon* (6), *Paracedroxylon* (10), *Araucariopitys* (8), and *Araucarioxylon Lindleii* (1). Its resemblance to *Araucariopitys* is indeed very close, since, in addition to wound resin canals, both have heavily pitted rays. *Araucariopitys*, however, lacks the wood parenchyma of this specimen, and also contains sclerotic diaphragms in the pith. With some of Lignier's specimens, also, it has much in common, but those, like *Araucariopitys*, have sclerites in the pith. *Araucarioxylon Lindleii* seems to be the nearest, but differs in that Professor Seward's specimen has exclusively terminal wood parenchyma. To denote an Araucarian *Cedroxylon* Mr. Sinnott founded the genus *Paracedroxylon*. Since this wood bears almost the same relation to *Cupressinoxylon* as his to *Cedroxylon*, it is proposed to call this type *Paracupressinoxylon*. To emphasize the fact that this wood differs from most *Cupressinoxyla* in the possession of thick-walled heavily pitted rays, such as occur in the cedars, it may be called *Paracupressinoxylon cedroides*.

*Paracupressinoxylon cupressoides* (Figs. 15 and 16).

The sections photographed for Figs. 15 and 16 are also from Mr. Lomax. This wood has *Brachyoxylon* tracheary pitting, with no cellulose bars of Sanio, thin-walled highly resinous rays, and abundant wood parenchyma scattered throughout the year's growth. Though its wound reaction is unknown, it is evident that it belongs to the genus *Paracupressinoxylon*. Since it differs from the last-described wood in the possession of thin and unpitted, rather than thick and pitted rays, it may be called *Paracupressinoxylon cupressoides*.

*Metacedroxylon araucarioides* (Pl. XL, Figs. 17-21).

This type of wood seems to be comparatively abundant in the Jurassic of Yorkshire, Mr. Lomax having sent several specimens, and the writer having procured a considerable amount of lignite of this variety from the Oölite of both Whitby and Scarborough, and some petrified material from the Lias of Robin Hood's Bay. The sections used for Figs. 17 and 18 are from Mr. Lomax, and have already been figured by Professor Jeffrey (7). There is a great deal of variety in the pitting of the tracheides. When uniserial the pits are often widely scattered and circular in outline, but equally often they are compressed and flattened. When more than one row occurs in a tracheide, they are at times typically Araucarian—alternate and angular, while at others they are in distinctly opposite pairs, or in groups of three or four (Fig. 17). It is often noticeable that the pits, however Araucarian in arrangement, are not so in outline,—the close approximation and consequent compression are absent, and instead, the pits are free and circular. The ray structure is shown in Fig. 18. It is obvious that the ray

cells, where in contact with each other, are heavily pitted, precisely as in the Abietineae. The pits from ray to tracheide are piciform, usually one or two to each cross-field. There is never any wood parenchyma. Figs. 19, 20, and 21 are of a lignite from Scarborough, showing similar structure. It differs in that the tracheides are smaller, the radial pits are uniserial, and always closely approximated, and usually the rays have but one pit to each cross-field. The most striking feature of this specimen is the large number of tyloses in the tracheides (Figs. 20 and 21). Several lots of this material were found, and in all the tyloses are present.

From the absence of cellulose bars of Sanio in all the specimens of this type, it is evident that we are dealing here with another Araucarian Conifer, which in view of the ray pitting must be transitional between that group and the Abietineae. The wood is indeed identical with that described by Jeffrey as *Araucariopitys*, and by Gothan as *Protocedroxylon araucarioides*, even to the tyloses in the tracheides. Jeffrey considers this an Araucarian type, while Gothan, from the structure of the rays, considers it Abietineous. As pointed out above, such thick-walled pitted rays are present in the cone axis of the living genus *Agathis* and may be recalled as a result of wounding in both *Araucaria* and *Agathis*. Since the cone axis has been shown repeatedly to retain ancestral conditions, and traumatic tissue to recall them, it seems entirely logical to conclude that the living Araucarineae are derived from ancestors which had thick-walled pitted rays. If so, there can be no doubt that this Jurassic wood under consideration is one of these ancestors. Since the term *Protocedroxylon* implies Abietineous affinities, it seems better to change it to *Metacedroxylon*, though retaining the original specific name of Gothan, and to call this wood *Metacedroxylon araucarioides*. It is interesting to note that Lignier (op. cit.) has described as Araucarian several similar specimens, with Abietineous pitting of the rays. His diagnosis depends on the character of the tracheary pitting. As mentioned above, approximated and flattened pitting are not invariably characteristic of the living *Araucaria* and *Agathis*, being replaced in the seedling by the scattered and circular pits which constitute the *Brachyoxylon* type. Since the seedling, like the cone axis, has in numerous instances been shown to perpetuate ancestral conditions, it seems justifiable to assume that flattened pitting is not the primitive condition for the Araucarineae, and will be less and less reliable as a diagnostic feature in progressively older geological horizons. Thus by a process of elimination, we are led to adopt the cellulose bars of Sanio as the only sure criterion for diagnosing coniferous woods. Accordingly, *Metacedroxylon araucarioides* cannot be other than an Araucarian Conifer.

Locality: Whitby and Scarborough.

„ Robin Hood's Bay.

Horizon: Oolite.

„ Lias.

*Metacedroxylon latiporosum* (Figs. 22-24).

Another closely allied species is shown in Figs. 22-24. The lack of wood parenchyma, presence of thick-walled, heavily pitted rays, and Araucarian pitting of the tracheides clearly affiliate it with *Metacedroxylon*. In many places the ordinary compressed tracheary pitting becomes accentuated, until a condition is reached like that shown in Fig. 24. This type is similar to that of *Xenoxylon latiporosum*, and on that account it is proposed to call this wood *Metacedroxylon latiporosum*. In *Xenoxylon* it seems evident that the large pits of the tracheides are formed by the extreme compression of a single row of approximated pits. In this specimen, however, the not infrequent substitution of a pair of small opposite pits for a single large one indicates another mode of origin. In fact, there seems to be no reason why such pits could not have been formed in two ways—either by the horizontal enlargement of a single pit, or the fusion of a pair of opposite pits.

*Brachyoxylon* sp. (Figs. 25 and 26).

Among both the lignites and petrified material, there were numerous specimens conforming more or less closely to the *Brachyoxylon* type. Figs. 25 and 26 show the structure of one of the lignites. A noticeable peculiarity of this wood is the angle at which the rays cross the tracheides (Fig. 25). This feature seems to be constant, since it was found in several specimens. It is evident that the rays are smooth and unpitted on horizontal and end walls, with one or two piciform pits on each radial wall. The tracheary pits are either circular and scattered or flattened and compressed (Fig. 26). Not infrequently they occur in sub-opposite pairs, but in no instance is there any indication of cellulose bars of Sanio.

Another variety of *Brachyoxylon* is shown in Fig. 27. This specimen has scattered pits and thin-walled rays, but is unique in the possession of large numbers of septate tracheides at the beginning of each annual ring. The significance of these cells it is difficult to infer. Whether they represent incipient parenchyma, or are related to an injury, it is impossible to say, but the latter supposition is rendered improbable by their appearance in several successive years, and the lack of any twist in the grain which would indicate proximity to a wound.

Of the other specimens of *Brachyoxylon* none presented any especial features of interest, beyond the fact that in one there were medullary stone cells.

*Araucarioxylon* sp. (Fig. 28).

Among the lignites was one clearly defined *Araucarioxylon*. This is shown in Fig. 28. The tracheides have one or two rows of closely compressed, flattened pits, the rays are low, thin-walled, and highly resinous,

with two to five small piciform pits to each cross-field. Whether this *Araucarioxylon* represents the wood of the Araucarineae or not, it is impossible to say. If so, it must be almost the oldest fully developed specimen of that family. It seems much more probable that it belongs to *Cordaites*, whose presence in the Lias is vouched for by Lignier's description of *Artisia* from that horizon (op. cit., ii, p. 135).

Locality: Scarborough.

Horizon: Oolite.

#### ABIETINEAE.

##### *Protobrachyoxylon eboracense* (Figs. 29 and 30).

This specimen is among the most interesting lignites from Scarborough. The general features of the wood—small tracheides with predominately uniserial pits, thin-walled ray cells, and absence of wood parenchyma—may be seen in Fig. 29. When examined carefully, the radial pits of the tracheides are found to present certain peculiarities of structure quite unique in Coniferous woods. As stated above, the pits are usually in one row; when two-ranked, as is not uncommon in the larger tracheides formed in the spring, they are always opposite. The uniserial pits are often scattered and circular, but equally often approximated and compressed. An example of the latter condition is shown in Fig. 30. Between the uppermost pit of the series and the one immediately below it may be seen on each side, but especially well on the left, a small white knob-like structure. Similar structures, though less well marked, may be observed below the next pit, and below the third they are quite evident again. Such appearances, which are exceedingly common in the best-preserved tracheides, can be interpreted as only one thing—degenerate bars of Sanio. To those who believe that the Abietineae are the ancestors of the Araucarineae, it is easy to see how these structures arose. As the pits of a Conifer like *Pinus*—remote, circular, and separated by bars of Sanio—become approximated, the bar is necessarily eliminated. It naturally disappears first in the centre, where the pits first come into contact with each other. As the pits become more crowded, only the ends of the bar persist. Such a condition is shown in Fig. 30. Occasionally, when the pits are not as closely approximated as usual, it is possible to make out a faint white line, connecting the knobs on the end. Such dumb-bell-like bars are very rare. In other places the centre of the bar is completely gone, but the ends, instead of being knob-like, are long and narrow. It is remarkable that these bars should persist when the pits are closely compressed, and not when they are scattered, but such is the case. In view of the fact that all transitional Araucarians, such as *Brachyoxylon*, &c., are descended from such a form as this, it is appropriate that it be called *Protobrachyoxylon eboracense*—the specific name to mark the place where it was found.

The presence of these degenerate bars has a not unimportant bearing on the diagnostic significance of bars of *Sanio* in general. As pointed out above, their extreme constancy in living forms has led to their adoption as the *sine qua non* of an Abietineous Conifer. Such has been the assumption of Sinnott in the case of *Paracedroxylon*, of Jeffrey in *Brachyoxylon* and *Araucariopitys*, and of the writer in these Jurassic woods. Gothan (op. cit., p. 32) has questioned the cogency of such reasoning. He denies that there is a phylogenetic principle involved in their distribution, and inclines to the opinion that their appearance is correlated with the amount of available space,—i. e. when the pits are remote, the bar is present; and when they are crowded, the bar is absent. There are two facts militating against the soundness of this view. In the first place, as Jeffrey has pointed out (7), the pits in the seedling of *Araucaria* and *Agathis* are as remote as in *Pinus*, and yet the bars are always absent; in the second, the pits in the specimen now under consideration are as crowded as those of any Araucarian, and yet the bars are clearly present. From these considerations it seems evident that Gothan's explanation is inadequate, and that, on the other hand, the diagnostic significance of cellulose bars of *Sanio* cannot be over-emphasized.

Locality: Scarborough.

Horizon: Oolite.

*Podocarpoxylon* sp. (Figs. 31 and 32).

This lignite is also from the vicinity of Scarborough. The rays are thin-walled, with one or two piciform pits to each cross-field. Usually the tracheary pits are uniserial, but double rows are not infrequent, in which case the pits are opposite. Between several of the pits shown in Fig. 31 may be seen white lines. These are bars of *Sanio*. They are very common, and show all the variations present in living genera, such as Pine. Frequently they are double, in places they fork at the ends, occasionally they are curved, following the contour of the pit, and when the pairs of pits are not strictly opposite the bars are at a distinct angle, until rarely they become almost vertical. The thin-walled rays exclude this specimen from the genus *Cedroxylon*, and the absence of parenchyma from *Cupressinoxylon*; the best place for it seems to be in the genus *Podocarpoxylon*, Gothan.

The wood of Fig. 32 came from Mr. Lomax. It is less well preserved than that last described, but its Abietineous affinities are unquestionable. The rays are thin-walled, there is well-marked wood parenchyma at the end of the annual ring, and the radial pits of the tracheides are scattered, or, when two-ranked, opposite. Bars of *Sanio* may often be observed. Like the last-described wood, this is probably an ancestral *Podocarp*, and should be placed in the genus *Podocarpoxylon*, Gothan.

## CONCLUSIONS.

There are several interesting conclusions to be drawn from these Jurassic woods of Yorkshire. The most important is the bearing of such transitional forms on the relative antiquity of the Abietineae and Araucariineae. From a study of the comparative anatomy of living representatives, Jeffrey (7) seems to have demonstrated beyond logical doubt that the Araucariineae are descended from ancestral forms which had, in the mature wood, resin canals, heavily pitted rays, wood parenchyma, and Brachyoxylon pitting. Such hypothetical ancestors are materialized in *Metacedroxylon*, *Paracupressinoxylon*, *Paracedroxylon*, &c. Fossil evidence is not of course always perfectly clear, for in many cases the Abietineous features of an Araucarian Conifer may, with equal reason, be interpreted either as persisting from a typical Abietineous form which is on the reduction path to the Araucariineae, or as incipient in an Araucarian which is on the upward way to the Abietineae. On the other hand, whenever experimental evidence is available for the study of extinct forms, such ambiguity is not possible. Thus, when these fossil Araucarian Conifers, on wounding, give rise to traumatic resin canals it seems evident that in its primitive condition the Araucarian stock had resin canals normally, and that the series is a reduction one from Abietineae to Araucariineae. There is, however, no possibility of a double interpretation in the evidence furnished by those Conifers existing at the present day. Under these circumstances the explanation which is universally applicable—both to living and extinct forms—appears beyond doubt the correct one.

Another fact leading to the same conclusion may be obtained by comparing the transitional forms of different geological horizons. In the Cretaceous the majority of these intermediate forms were of the *Brachyoxylon* type, with thin-walled rays, and a mixture of Araucarian and Abietineous pitting. In the Jurassic, on the other hand, as shown by the investigations of Gothan, Seward, Lignier, and others, the majority had thick-walled pitted rays, with a distinctly less Araucarian type of tracheary pitting. In other words, the farther back geologically we go, the more like the Abietineae do the transitional forms become.

If it be granted that the Araucariineae were derived from the Abietineous Conifers which were characterized by the possession of resin canals, wood parenchyma, and thick-walled rays, it is easy to understand how, in the course of reduction, different combinations of these features should be found in early Araucarians. Thus *Protopiceoxylon*, Gothan, is probably an Araucarian Conifer which has not yet lost its resin canals; while *Paracupressinoxylon* retains its wood parenchyma, and *Metacedroxylon* its pitted rays. Whether *Paraphyllocladoxylon* should be interpreted as a *Phyllo-*

*cladoxylon* in which the 'Eiporen' persist, is doubtful. There are many features in which the Araucarians and Podocarps are alike, but it still seems unlikely that it is from forms like *Phyllocladus* that the Araucarians have been derived. It seems more probable that large 'Eiporen' are in the nature of sports, without diagnostic significance. Their occurrence in forms as widely separated phylogenetically as *Pinus*, *Sciadopitys*, and *Phyllocladus* indicates such to be the case.

#### SUMMARY.

1. There were present in the Jurassic of Yorkshire a few typically Abietineous woods, a few typically Araucarian, and a large number intermediate between the two.

2. The character of these transitional woods corroborates other evidence—both palaeobotanical and comparative anatomical—pointing to the conclusion that the Abietineae are the oldest Conifers, and ancestral to the Araucarineae.

3. Comparative examination of living and fossil forms leads to the rejection of all criteria except cellulose bars of Sanio as an infallible test for tribal affinities. That these bars are of real diagnostic significance, and not simply incidental to the spacing of the pits, is indicated by their absence in the seedling stem of *Araucaria* and *Agathis*, where the pits are as remote as in *Pinus*, and their presence in *Protobrachyoxylon*, where the pits are as crowded as in *Araucaria* or *Cordaites*.

In conclusion, I wish to express my thanks to Professor Jeffrey for material and advice in connexion with this investigation.

---

#### LITERATURE CITED.

1. SEWARD, A. C.: Catalogue of Mesozoic Plants, British Museum, Jurassic Flora, Part 2, 1904, pp. 56, 57, Pls. VI, VII. London.
2. GOTHAN, W.: Die fossilen Hölzer von König Karls-Land. Kung. Svensk. Vetenskap. Handlingar, xlii, No. 10.
3. ———: Die fossilen Holzreste von Spitzbergen. Kung. Svensk. Vetenskap. Handlingar, xlv, No. 8.
4. LIGNIER, O.: Végétaux fossiles de Normandie, II and IV (1<sup>re</sup> Série). Caen, 1907.
5. KRAUS, G.: in Schimper's *Traité de Paléontologie végétale*, v, pp. 363–85.
6. JEFFREY, E. C., and HOLLICK, A.: Cretaceous Coniferous Remains, Staten Island. Mem. New York Bot. Garden, iii, Pl. XXI.
7. ———: The Araucarioxylon Type. Proc. Am. Acad. Arts and Sciences, xlviii, No. 13, Nov. 1912.



8. JEFFREY, E. C.: *Araucariopitys*, a New Genus of Araucarians. Bot. Gaz., xlv, 1907, pp. 435-44
9. GERRY, E.: Bars of Sanio in the Coniferales. Ann. Bot., xxiv, p. 231.
10. SINNOTT, E. W.: *Paracedroxylon*, Rhodora, II.
11. GOTHAN, W.: Zur Anat. leb. u. foss. Gymnospermen Hölzer. Abhandl. d. Königl. Preuss. Geol. Landesanstalt, Neue Folge, Heft 44, Berlin, 1905.
12. STOPES, M. C., and FUJII, K.: Structure and Affinities of Cretaceous Plants. Phil. Trans. Royal Soc., London, Ser. B, vol. cci, pp. 1-90.

## DESCRIPTION OF PLATES XXXIX AND XL.

Illustrating Miss Holden's paper on Jurassic Coniferous Woods from Yorkshire.

### PLATE XXXIX.

- Fig. 1. *Xenoxylon phyllocladoides*, transverse section.  $\times 60$ .
- Fig. 2. Same, radial longitudinal section.  $\times 60$ .
- Fig. 3. Same, to show tracheary pitting.  $\times 250$ .
- Fig. 4. Same, to show ray structure.  $\times 250$ .
- Fig. 5. *Xenoxylon latiporosum*, radial section.  $\times 40$ .
- Fig. 6. Same, to show tracheary pitting.  $\times 250$ .
- Fig. 7. *Paraphyllocladoxylon eboracense*, radial section.  $\times 60$ .
- Fig. 8. Same, to show pitting of rays.  $\times 250$ .
- Fig. 9. Same, tangential section.  $\times 60$ .
- Fig. 10. *Paraphyllocladoxylon araucarioides*, radial section.  $\times 60$ .
- Fig. 11. *Paracupressinoxylon cedroides*, transverse section to show traumatic resin canals.  $\times 40$ .
- Fig. 12. Same, radial section, showing resin canal.  $\times 40$ .
- Fig. 13. Same, radial section, showing tracheary pitting.  $\times 60$ .
- Fig. 14. Same, showing ray pitting.  $\times 325$ .
- Fig. 15. *Paracupressinoxylon cupressoides*, transverse section.  $\times 60$ .
- Fig. 16. Same, longitudinal section, showing wood parenchyma.  $\times 60$ .

### PLATE XL.

- Fig. 17. *Metacedroxylon araucarioides*, radial section to show radial pitting of tracheides.  $\times 125$ .
- Fig. 18. Same, to show pitted rays.  $\times 250$ .
- Fig. 19. Similar wood from Scarboro, transverse section.  $\times 60$ .
- Fig. 20. Same, radial section, showing compressed pits and tyloses.  $\times 60$ .
- Fig. 21. Same, tangential section.  $\times 60$ .
- Fig. 22. *Metacedroxylon latiporosum*, transverse section.  $\times 40$ .
- Fig. 23. Same, radial section.  $\times 40$ .
- Fig. 24. Same, radial section, showing large pits.  $\times 125$ .
- Fig. 25. *Brachyoxylon* sp., showing ray pitting.  $\times 80$ .
- Fig. 26. Same, showing Araucarian tracheary pitting.  $\times 325$ .
- Fig. 27. *Brachyoxylon* sp., showing septate tracheides.  $\times 60$ .
- Fig. 28. *Araucarioxylon* sp., showing tracheary pitting.  $\times 60$ .
- Fig. 29. *Protobrachyoxylon eboracense*, showing thin rays.  $\times 60$ .
- Fig. 30. Same, showing degenerate bars of Sanio.  $\times 325$ .
- Fig. 31. *Podocarpoxylon* sp., showing bars of Sanio.  $\times 325$ .
- Fig. 32. *Podocarpoxylon* sp., radial section, showing terminal parenchyma.  $\times 60$ .

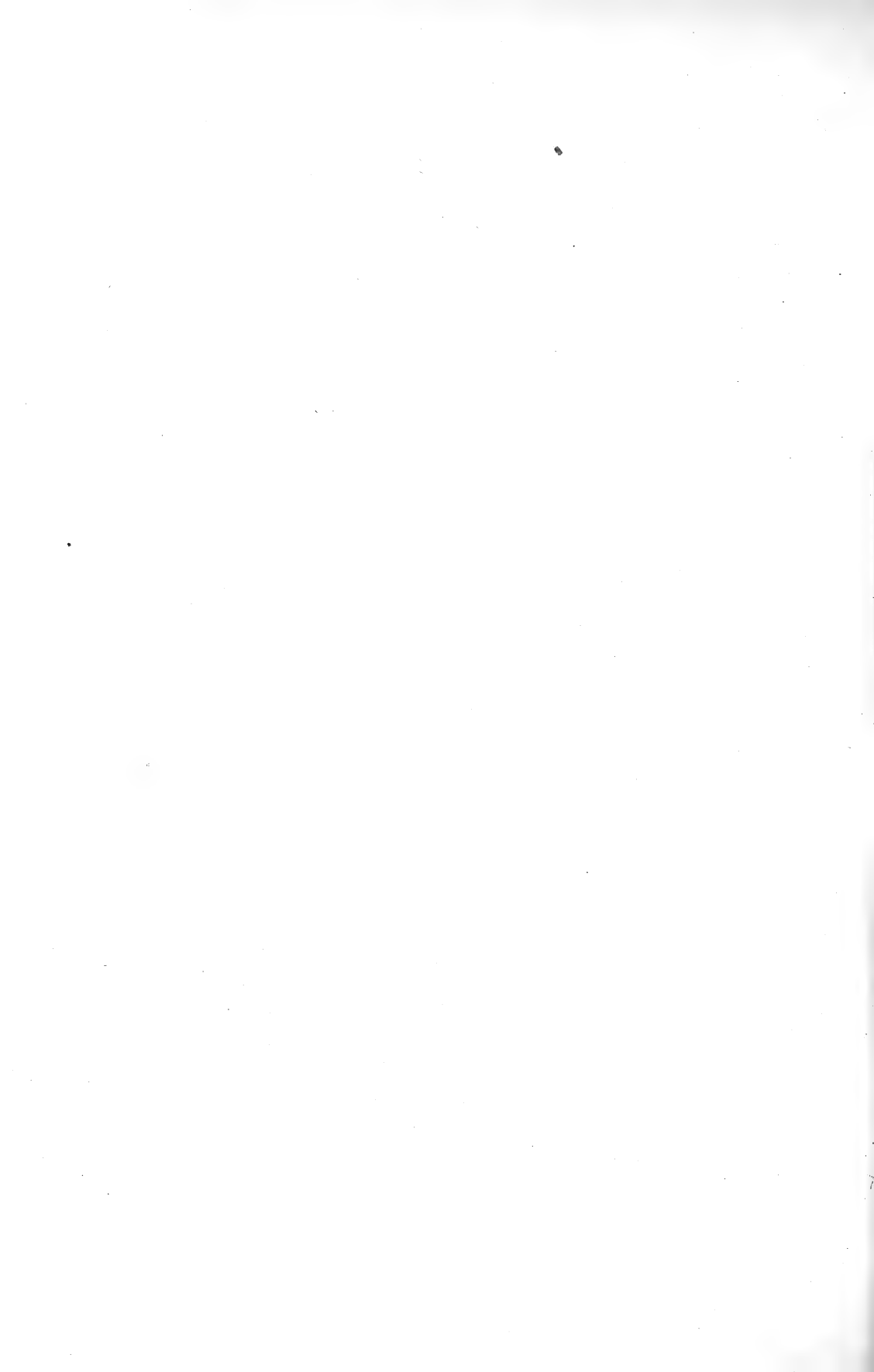



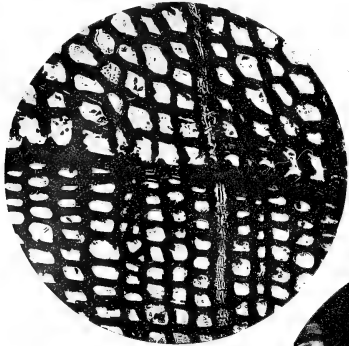

1



2

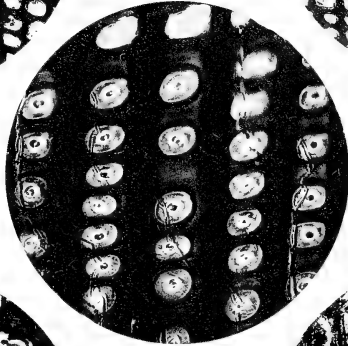

3

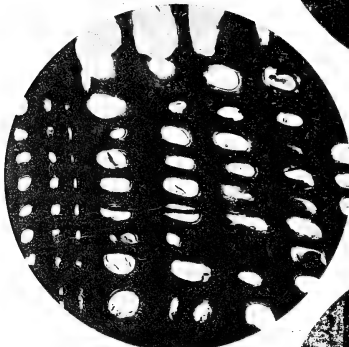

4

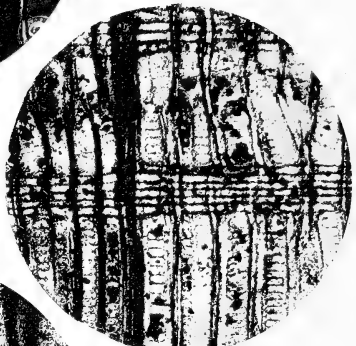

5

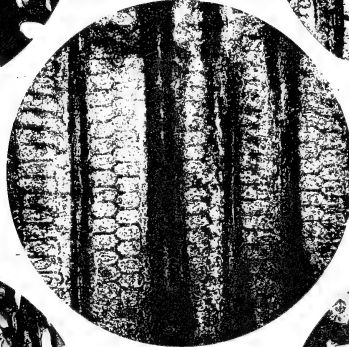

6



7



8



9



10

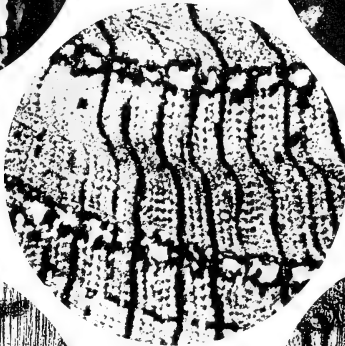

11



12

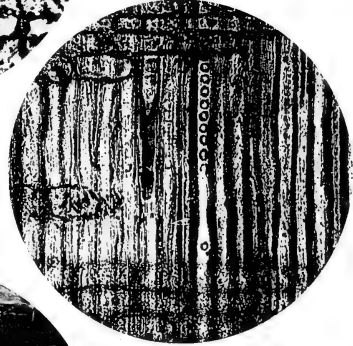

13



14

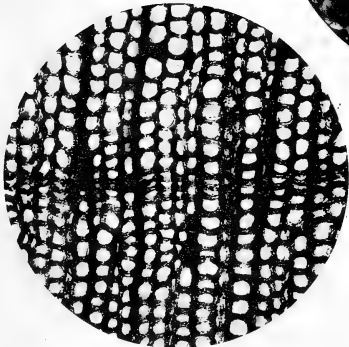

15



16





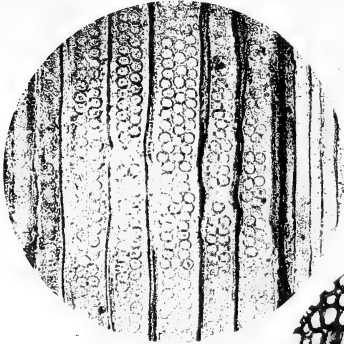

17

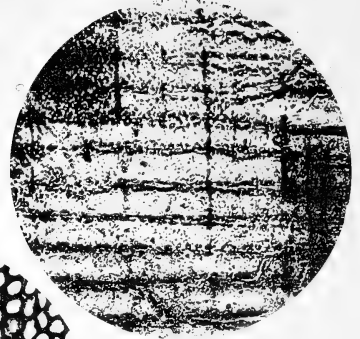

18

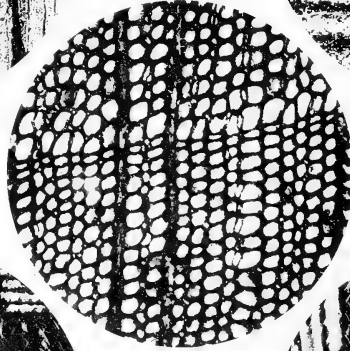

19

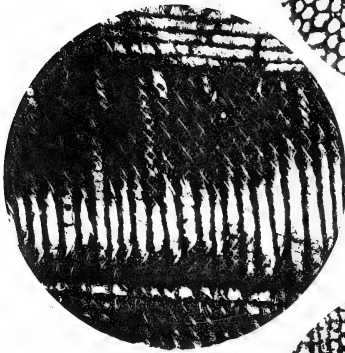

20



21

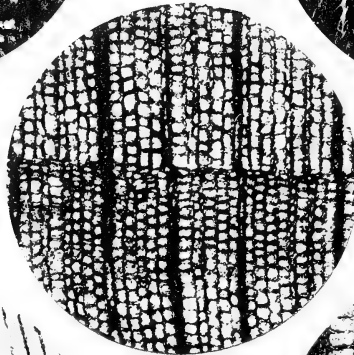

22

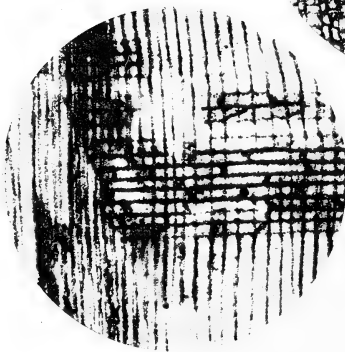

23



24





25

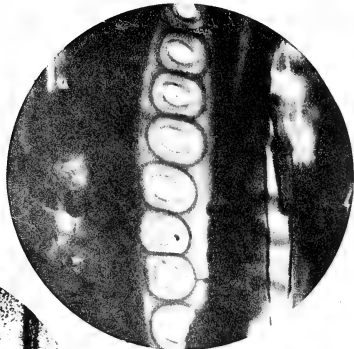

26



27

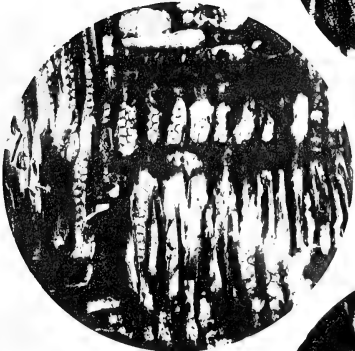

28



29



30



31



32

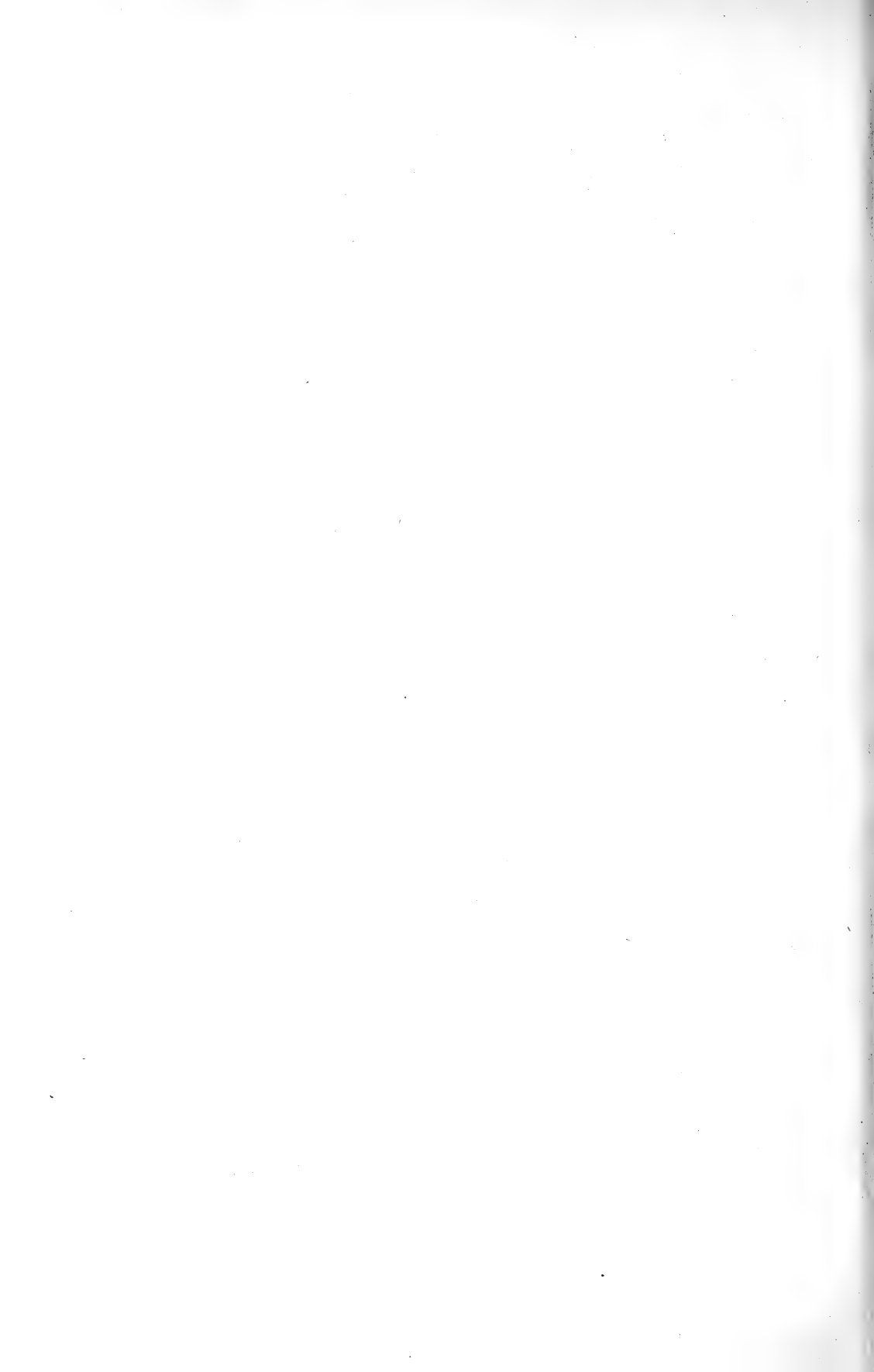

# Morphology of the Bracts in *Welwitschia mirabilis*.

BY

H. TAKEDA.

With Plate XLI and two Figures in the Text.

THE morphology of the bracts in the inflorescence of *Welwitschia* has been studied by not a few botanists, and there seems to be very little to add to our previous knowledge in regard to the external configuration, whereas several interesting points on the internal structure will be described in the following pages.

The material used for my investigation was chiefly from that collected by Professor Pearson in Damaraland in January, 1904, and was preserved in methylated spirit. There were bracts in different stages of development from various parts of inflorescence. There are two kinds of bracts: (1) those at the forking of the inflorescence-axis, in the axil of which a branch with cones is inserted; (2) those in the cone itself, and usually subtending a flower in each axil. For the present study attention was chiefly concentrated on the latter, although the former were also investigated for comparison.

**External Morphology.** This has already been described and figured in many publications,<sup>1</sup> so that it is quite unnecessary to describe it in detail.

The bracts are broadly ovate. In the female cone the basal two or three pairs of bracts are connate, while all others are free, as has already been pointed out by the previous workers. In the male cone, on the other hand, all the bracts are connate throughout the cone. This character has never been correctly described or figured before, although it is an interesting and important point. In all the genera of the Gnetales the bracts are

<sup>1</sup> J. D. Hooker: On *Welwitschia*: a New Genus of Gnetaceae, in Trans. Linn. Soc., London, xxiv, 1863. E. Strasburger: Die Coniferen und die Gnetaceen, 1872; Die Angiospermen und die Gymnospermen, 1879. Eichler, in Engler u. Prantl: Die natürlichen Pflanzenfamilien, ii, 1887. A. B. Rendle: The Classification of Flowering Plants, i, 1904. H. H. W. Pearson: Some Observations on *Welwitschia mirabilis*, in Phil. Trans. Roy. Soc., London, B, 198, 1906; Further Observations on *Welwitschia mirabilis*, *ibid.*, 201, 1909. J. M. Coulter and C. J. Chamberlain: Morphology of Gymnosperms, 1910. M. G. Sykes: On the Anatomy and Morphology of the Leaves and Inflorescences of *Welwitschia mirabilis*, in Phil. Trans. Roy. Soc., London, B, 201, 1910. Gardeners Chronicle, July 23, 1898.

invariably decussate and connate at the base, as are their leaves also. But this character does not occur in any other group of the Gymnosperms, except that opposite cone-scales are found in certain members of Cupressineae.

**The Nervation.** The vascular supply in the bracts strikingly differs from the nervation of the leaf, inasmuch as the shape of these two organs differs, yet there exists a feature of homology between them. The leaf and cotyledon receive the paired bundles, and so does the bract. In the case of the leaf, the primary design of the nervation is subsequently altered by the formation of the new additional bundles, whereas in the cotyledon the primitive character is retained.<sup>1</sup> Supposing the main bundles in the cotyledon were telescoped and the transverse veins were to end blindly, then the nervation of the bract would be produced.

The bract at the node of the inflorescence is very thick in texture, short, and broadly connate. It has a nervation quite similar to that of the other bracts, except that this is less freely branched.

**The Epidermis.** The epidermal cells of the adaxial side of the bract are flat and smooth (Pl. XLI, Fig. 3). The outer wall of the cell is fairly thick and chiefly consists of cellulose, and is uniformly covered with thin cuticle. The epidermal cells of the abaxial side are not flat, but are rather uneven owing to the vault-like shape of each cell (Fig. 2). The outer wall is comparatively thin. That of the female cone chiefly consists of cellulose covered with a thin layer of cuticle, while that of the male cone shows two layers; they are the inner cellulose and the outer cuticularized layer. Minute granules of calcium oxalate are present in the outer epidermal cells. In the female cone-bract they are deposited in the cellulose layers of the outer wall, whilst in the male cone-bract they are impregnated in the cuticularized layer of the outer wall as well as in the inner wall, which is chiefly composed of cellulose (Figs. 2, 3). In the case of the bract subtending the cone-stalk the epidermal cells of both sides are practically flat (Fig. 4). The nature of the cell-wall and that of the deposit of calcium oxalate of this kind of bract entirely correspond to those of the cone-bract of its own inflorescence, namely the bract of the male inflorescence has the cuticularized layer, and the calcium oxalate deposited in both the outer and inner cell-walls, while in that of the female inflorescence the cuticularized layer and the crystals of calcium oxalate in the inner epidermal wall are absent.

Each epidermal cell is generally quadrangular in the surface view, and is elongated longitudinally resembling that of the cotyledon.<sup>2</sup>

In the outer epidermal cells, especially of the cone-bracts, chloroplasts

<sup>1</sup> Takeda, H.: Some Points in the Anatomy of the Leaf in *Welwitschia mirabilis*, in *Ann. Bot.*, xxvii, 1913, p. 348.

<sup>2</sup> Takeda, H., l. c., p. 349.

are present, and starch is produced in these, as in the case of the epidermal cells of the leaf and stem in *Ephedra*.

**The Stoma.** The presence of stomata in the bracts has been noted by Hooker,<sup>1</sup> Strasburger,<sup>2</sup> and Sykes.<sup>3</sup> Stomata occur in all kinds of bract. They are not so deeply sunken as in the adult leaf, but not so superficial as delineated by Sykes (Figs. 2-4). The guard-cells are much the same as those of the cotyledon in shape and structure. The ventral wall consists of cellulose, and the upper portion of the dorsal wall is thickened and slightly lignified, not giving a strong reaction to phloroglucin or aniline sulphate.

Stomata are distributed in the exposed parts of the bracts, except near the margin, and are generally longitudinally and only rarely obliquely

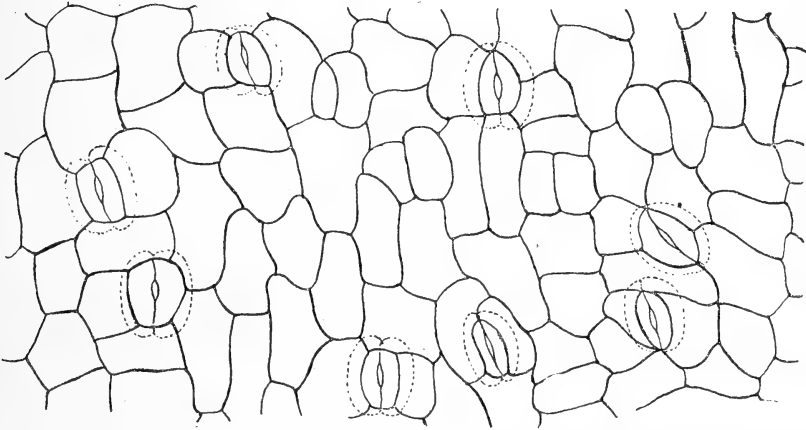

TEXT-FIG. 1. A portion of the epidermal cell from the exposed part of the male cone-scale in surface view.  $\times 285$ .

orientated. The mode of their development is exactly the same as in the case of the leaf and cotyledon<sup>4</sup> (Text-fig. 1).

**The Mesophyll.** The exposed portion of the bract is considerably thickened, and consists, in the case of the male cone, of about six cells, and in the case of the female cone, of more than ten cells in thickness.<sup>5</sup> In the fully developed bracts of all kinds, palisade tissue is present under the outer epidermis. This tissue is perhaps best developed in the male cone-bract and consists of one or sometimes two layers of cells. In the female cone-bract this tissue is greatly interrupted by the presence of spicular cells. Sykes<sup>6</sup> did not observe any palisade; she appears to have not recognized that she was dealing with immature structures. The spongy parenchyma cells are roundish and contain chloroplasts. In the wall of these cells of full-

<sup>1</sup> l. c., p. 25.

<sup>2</sup> l. c. (1), p. 94.

<sup>3</sup> l. c., p. 185.

<sup>4</sup> Cf. Takeda, H., l. c., p. 351.

<sup>5</sup> Strasburger, E., l. c. (1), p. 94.

<sup>6</sup> l. c., p. 185.

grown bracts crystals or granules of calcium oxalate are deposited as in the case of the leaf.

The unligified sclerenchymatous fibres are present in large quantity, and they are, in the cone-bracts, usually disposed under the inner epidermis, and in the other kind of bract are scattered in the mesophyll. These are the sole strengthening cells in the connate portion of the bract, which is not traversed by the vascular bundles. The fibres are not always straight, but are often curved or wavy.

**The Spicular Cell.** The spicular cells occur copiously in different parts of the mesophyll. They are straight in the thinner portions of the bract, but are bent and irregularly branched in the thicker portion.

Crystals or granules of calcium oxalate are found in the outer lignified layer of the spicular cell. They are often very minute, and may easily be overlooked.<sup>1</sup>

The spicular cell and the sclerenchymatous fibres make their appearance before much differentiation of the mesophyll-tissue takes place, and as early as the primordia of the stamens in the flower invested by the bract have just appeared as small protuberances.

**The Mucilage Canal.** Mucilage canals of the same nature as those in the leaf are in abundance in the bracts. They are especially well developed in the thicker portion of the bract, and are very irregularly branched.<sup>2</sup>

**The Vascular Bundle.** The bundles are collateral and normally orientated. The xylem consists of loose spiral and annular elements of protoxylem and of dense spiral tracheides of metaxylem. No secondary xylem is present, consequently no tracheae are found. All these elements possess bordered pits at intervals on their radial and tangential walls. The pits are not formed in perfection. They are of oval or circular shape and have rather elongated orifice; a torus has not been observed. The phloem consists of narrow sieve-tubes and phloem-parenchyma. The sclerenchymatous fibres have been observed only in the bract at the node of the inflorescence axis, and there are only a few elements present on the phloem side (Fig. 5).

**The Water-storing Tracheides.** The vascular bundle of the bract is accompanied by water-storing tracheides on its whole course. The tracheides

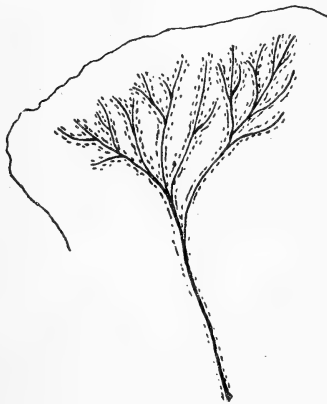

TEXT-FIG. 2. Vascular course with water-storing tracheides in the male cone-bract.  $\times 12$ . Prepared from material cleared with eau de Javelle. (Only half of the bract is shown.)

<sup>1</sup> Cf. Sykes, l. c., p. 185.

<sup>2</sup> Sykes, l. c.

are comparatively few in the lower part of the bract, and are scattered here and there along the bundle. Higher up in position they increase in amount, and are better developed on the phloem side. In these cases the tracheides are generally elongated in the longitudinal direction. Towards the apex of the bract, where the bundles ramify freely, the tracheides reach their maximum development. They surround the bundles nearly completely. They often even extend in lateral directions, and sometimes they occupy the space between bundles, thus replacing a large part of the mesophyll. The elements are not always connected with each other, but occasionally occur isolated among the mesophyll-parenchyma. The general disposition of the tracheides can be very well seen in a preparation cleared with eau de Javelle (Text-fig. 2).

The first-formed elements arise usually on the lateral side of the bundle, just as in the case of the leaf and cotyledon.<sup>1</sup> The later-formed elements are derived from mesophyll-parenchyma, which can be traced by comparison with adjacent cells.

The same structure occurs in the bracts of *Gnetum* and of *Ephedra* (not in the male inflorescence), as well as in the female cone-scales of the Conifers, which have been fully investigated by Bernard.<sup>2</sup>

#### SUMMARY AND CONCLUSIONS.

It has been pointed out above that there occur two kinds of bracts in the inflorescence, viz. those at the node of the inflorescence axis, and those in the cone. There is no morphological and anatomical difference between them, and they are perfectly homologous. All the bracts are broadly ovate and are, except those in the upper portion of the female cone, connate at the base.

Each bract receives a pair of bundles which branch copiously towards the apex of the bract. The nervation is closely comparable with that of the cotyledon, which possesses the phylogenetically primary arrangement of vascular supply.

In the outer epidermis stomata are found abundantly, and in their structure they are identical with those of the leaf. Chloroplasts are present in the epidermal cells of the cone-scale.

The mesophyll is differentiated into palisade tissue and roundish parenchyma cells. These are full of chloroplasts and form chlorenchyma. Spicular cells with crystals of calcium oxalate and sclerenchymatous fibres with unlignified walls are present in the mesophyll. Irregularly branched mucilage canals are also found in abundance.

<sup>1</sup> Cf. Takeda, H., l. c., p. 354.

<sup>2</sup> Bernard, Ch.: Le bois centripète dans les bractées et dans les écailles des Conifères, in Beihefte z. Bot. Centralbl., xvii, 1904.

The vascular bundles are collateral and normally orientated. They are, particularly in the exposed portion of the bract, completely surrounded by a mass of water-storing tracheides, as in the leaf.

From the facts above mentioned it is to be seen that the bracts are perfectly homologous with the vegetative leaf. It is also to be seen that the cone-bracts are bracts in the strict sense, in the axil of which the 'flower' is borne. Sykes<sup>1</sup> is inclined to regard the bract as a sporophyll. This hypothesis is, however, open to the objection that the structure is too highly differentiated for a sporophyll of such an advanced member of the Gymnosperms. Moreover, the 'flower' is, without doubt, cauline. Each cone is therefore a compound one.

I may perhaps emphasize here the connate character of the bract, which is one of the important diagnostic features of the Gnetales. The connate leaf-base so universal in the Gnetales has already been pointed out in my former paper.<sup>2</sup> The homology of the inflorescences of the three genera of the Gnetales becomes easily intelligible, if this character is taken into consideration. Hooker<sup>3</sup> has already noticed the resemblance of the female cones of *Welwitschia* and of *Ephedra*, particularly in the bracts, on account of the paired bundles, the presence of stomata, and so forth. He, however, seems to have failed in finding connate bracts in *Welwitschia*. This difficulty is easily overcome, if one examines the male cone closely. Even in the female cone the few basal pairs are connate.

The connate character would probably help us to interpret the peculiar tubular structure of the stamens in *Welwitschia* as a fused base of two groups of male sporophylls.

In conclusion, I tender my sincere thanks to Professor Farmer for his kindly criticism.

## EXPLANATIONS OF PLATE XLI.

Illustrating Mr. Takeda's paper on the Bracts in *Welwitschia*.

All figures were drawn faithfully by the aid of Abbé's drawing apparatus.

Fig. 1. Transverse section of a vascular bundle of the male cone-bract, taken from the middle portion of the latter.  $\times 285$ . *cj.* = conjunctive parenchyma; *w.t.* = water-storing tracheides.

Fig. 2. Epidermis with stomata and a portion of chlorenchyma (from a transverse section of a male cone-bract).  $\times 285$ . Cell contents are not shown.

Fig. 3. A portion of a longitudinal section of the male cone-bract (near the apex).  $\times 285$ . Cell contents are not represented. *St.* = stoma; *Sp.* = spicular cell.

Fig. 4. Epidermis and chlorenchyma of the bract at the node of the male inflorescence.  $\times 285$ . *Sc.* = spicular cell.

Fig. 5. Transverse section of a vascular bundle of the same bract (taken from the middle portion of the bract).  $\times 285$ . *f* = sclerenchymatous fibres with unglified walls.

Fig. 6. A portion of a longitudinal section of two protoxylem elements of the female cone-bract.  $\times 950$ . Spiral vessel on the right, and annular vessel on the left.

<sup>1</sup> l. c., pp. 219, 221.

<sup>2</sup> l. c.

<sup>3</sup> l. c., p. 25.



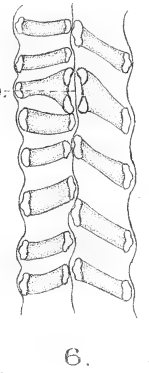
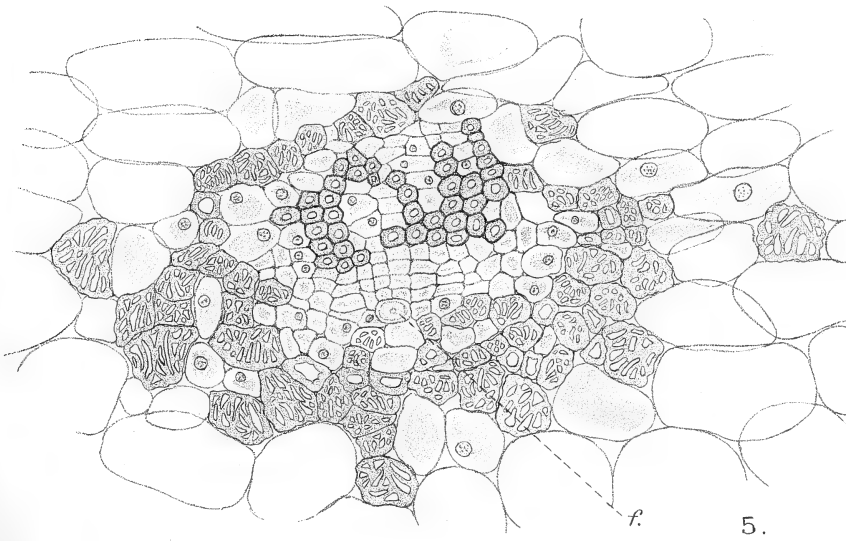
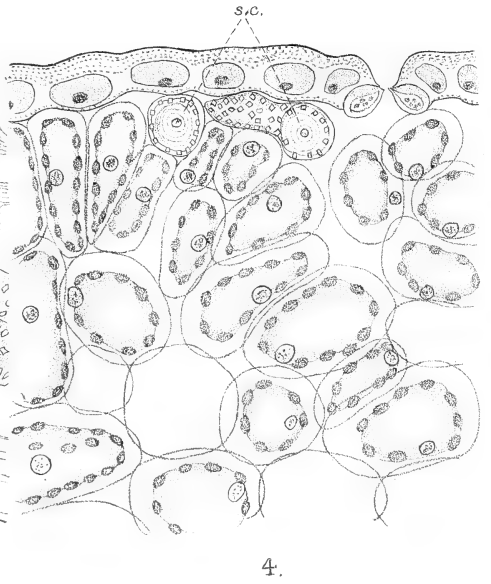
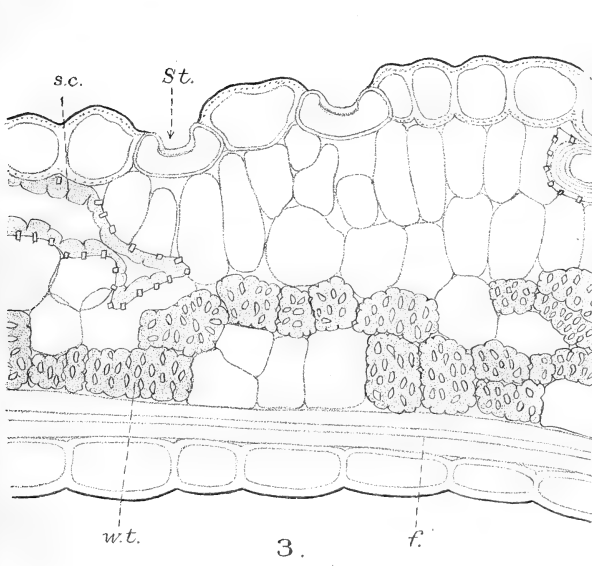
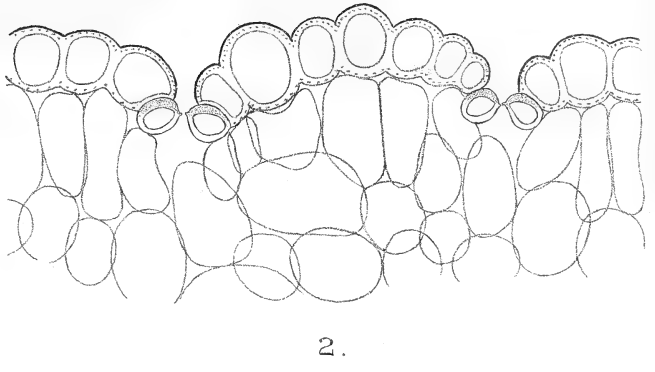
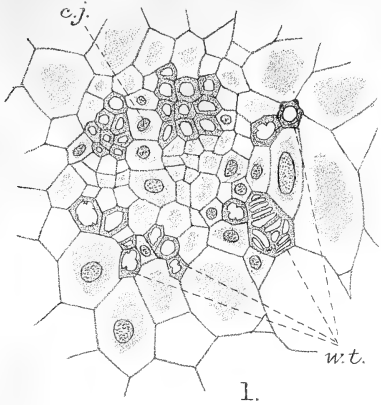

TAKEDA-WELWITSCHIA.



# The Development of the Ascocarp in *Lachnea cretea*.

BY

H. C. I. FRASER, D.Sc. (Lond.), F.L.S.

(MRS. D. T. GWYNNE-VAUGHAN.)

*Head of the Department of Botany, Birkbeck College, London.*

With Plates XLII and XLIII.

*LACHNEA CRETEA*, Phil., is a small, pale, buff Discomycete, beset with numerous darker hairs and described as occurring on plaster ceilings. It appeared in this laboratory in the Spring of 1912, in the course of an attempt to obtain material of *Pyronema confluens*. In January, 1912, a Petri dish of 3% agar was sprinkled while still fluid with finely powdered charcoal, and on it were placed fragments of charred stick known to have borne *Pyronema confluens* in the previous autumn. Various mycelia developed, and some were transferred to the double medium recommended by Claussen ('12).<sup>1</sup> *Pyronema* was not found, but a few ascocarps of *Ascophanus carneus* developed, together with various Hyphomycetes, Bacteria, and Moulds, and the cultures were put aside.

In March one of them showed a single specimen of *Lachnea cretea*. New cultures were started and an abundant supply was obtained. The fungus was grown on Claussen's medium, and subsequently on 3% agar made up with decoction of plaster both with and without mineral salts.

Material was fixed, without removal from the agar, in various strengths of Flemming's fluid and in 1% solution of iodine in 1.5% lithium iodide. Sections were stained chiefly with Heidenhain's haematoxylin followed by solution of erythrosin in clove oil. Uncut material was stained in a mixture of strong aqueous erythrosin and glycerine, and was mounted in glycerine jelly. Owing to the transparency of the agar it was possible to examine the archicarps in their natural position.

Unfortunately, the nuclei of this fungus are small, and cytological detail did not prove available. The archicarp, however, differs so much from that known in other members of the Pezizaceae that some account of its morphological characters seems to be desirable.

<sup>1</sup> Outer dish, 0.05%  $\text{KH}_2\text{PO}_4$ , 0.05%  $\text{NH}_4\text{NO}_3$ , 0.02%  $\text{MgSO}_4$ , 0.001%  $\text{Fe}_2(\text{PO}_4)_3$ ; inner dish, as above plus 2% inulin; in each case 3% agar was used, instead of the 2% recommended by Claussen, as it sets with greater certainty.

## MYCELIUM.

The mycelial hyphae vary very much in thickness. They branch freely, often in a dichotomous manner. In some cases they are richly septate, in others, especially in the rooting hyphae, the septa are far apart. Conspicuous granules, the so-called metachromatic granules commonly observed in *Discomycetes*, are present on the cross-walls. H-pieces and other anastomoses between neighbouring hyphae are of frequent occurrence (Pl. XLII, Figs. 3, 4). The cells contain a network of finely granular cytoplasm, and are multinucleate.

## FORMATION OF ARCHICARP AND SHEATH.

Usually, but not invariably, the archicarp is produced on one of the larger filaments. It forms two or three close coils and undergoes septation (Figs. 2, 7).

At this time the hypha which bears the archicarp and others in the immediate neighbourhood give rise to numerous stout, curved branches. These are the beginnings of the sheath. They grow up and invest the archicarp and the hypha which bears it, till a more or less spherical mass is produced (Figs. 4, 5, 6). Branches from increasingly remote hyphae are added as development proceeds, and rooting filaments grow downwards to form a secondary mycelium (Fig. 4).

At this stage the fruit is remarkably like the young perithecium of the simpler *Pyrenomycetes* or of such a mould as *Aspergillus*, and it is only later, when the development of the paraphyses takes place, that the distinctively *discomycetous* character is established.

In the meantime the archicarp has undergone further development. It grows out beyond the coiled portion as a long, sinuous, multicellular filament (Fig. 8), which grows among the cells of the sheath and ultimately protrudes far beyond them (Pl. XLII, Fig. 11, Pl. XLIII, Fig. 12).

At first, all the cells of the archicarp contain scattered nuclei similar to those of the vegetative hyphae (Fig. 7); a little later the nuclei in the central and terminal cells have become more numerous (Fig. 8), and still later three regions are clearly differentiated. The cells of the stalk differ little from those of the vegetative mycelium. The coiled central region is made up of three or four cells; these enlarge and their nuclei increase both in size and number. The terminal portion constitutes the trichogyne.

## TRICHOGYNE.

This terminal part consists of some eight or nine cells; it becomes more or less emptied of contents, and a peculiar change takes place in the character of the transverse septa. They show a large, clear, central area (Figs. 5, 11, 12), resembling in appearance the callus-pad of a sieve-tube, and staining readily with erythrosin.

In one or two cases—as, for example, that shown in Fig. 11—it is possible to make out that the callus pad is preceded by the formation of an open pore, and that a mass of granular substance is continuous from one side of the wall to the other. This stage was not often seen and represents no doubt a temporary condition.

These changes in the wall render the terminal portion of the archicarp readily recognizable in older specimens, since the pads are in marked contrast to the septa of an ordinary hypha, with their double row of 'metachromatic' granules.

By these means the terminal portion of the archicarp has been traced in its older stages, outside the young fruit, both in cut specimens (Figs. 11, 12) and in uncut material (Figs. 5, 6). Frequently it is found to branch near the apex (Figs. 5, 6, 11), characteristic septa being found beyond the point of branching (Fig. 5). In no case were the apices fused with any other hypha, but whenever the filament could be traced to its termination, the ends were quite free.

Nevertheless, it seems inevitable to conclude that this prolongation of the archicarp is morphologically a trichogyne, and one, moreover, which has not long ceased to be functional. For in it the cross-walls become broken down, so that a free passage through wide pores is established from cell to cell. It is not out of the question that the contents of the trichogyne may empty themselves into the central part of the archicarp, and that in this way a form of pseudapogamy may replace fertilization; but no evidence of this process has been obtained.

#### ASCOGONIAL REGION.

In the central portion of the archicarp, the septa between the cells break down, so that a very wide passage is formed (Fig. 14) and nuclei pass readily from cell to cell (Fig. 13). All the cells may give rise to ascogenous hyphae.

In this region of the archicarp the nuclei are crowded together, and here, no doubt, they unite in pairs. But they are too small to yield really satisfactory data on this critical point, and any attempt to study their behaviour was abandoned. In the part of the ascogenous hyphae nearest the ascogonial cells the nuclei lie irregularly; in the upper parts they are arranged in single file (Fig. 15); sometimes two, sometimes three, lie close together; sometimes a single nucleus is separated from the others. There is no evidence either when the ascogenous hyphae are first formed, or, at a later stage, of an arrangement in regular pairs. By the time that the development of the ascogenous hyphae has begun, the inner cells of the sheath have grown up to form a wedge-shaped group of paraphyses, and by means of these the peridium is ultimately broken open, so that the fruit

assumes the characteristically discomycetous form. The development of the inner layers of the sheath—the nutritive layers of the Aspergillaceae—on one side of the fruit as paraphyses, and the regular unilateral growth of the ascogenous hyphae, are the salient points of difference between the ascocarp of the Discomycetes and that of the more primitive Aspergillaceae.

At the base of the group of paraphyses the ascogenous hyphae give rise to asci in the usual way—by the bending over of the hypha and the growth of its penultimate cell (Fig. 14). The first division in the ascus is fairly clear and shows about eight chromosomes (Figs. 16, 17), but the small size of the later divisions makes critical work unsatisfactory, for it seems useless to study in a minute form processes which have been already observed on a larger scale. The spores are eight in number; they are uniseriate, elliptical, and unicellular.

From the outer cells of the sheath the thick-walled septate hairs characteristic of the genus *Lachnea* arise. The base of the hair is bulbous (Fig. 1), but it was not observed to fork.

#### DISCUSSION.

In the genus *Lachnea* two other species have been investigated. In *Lachnea stercorea* (Fraser, '07) the archicarp shows a multicellular stalk and a multicellular trichogyne. The ascogonial region consists of a single large, more or less spherical cell, from which alone the ascogenous hyphae arise. The trichogyne is much shorter than in *Lachnea cretea* and consists of shorter cells; it was not seen to protrude far beyond the sheath, and in some cases its terminal cell fused with a large oblong antheridium. The male nuclei were observed to enter the terminal cell of the trichogyne, but did not travel further. In contrast to that of *Lachnea cretea*, the trichogyne of *Lachnea stercorea* retains its contents, and the transverse septa undergo no recognizable modification.

In *Lachnea scutellata* (Brown, '11) there is a single ascogonial cell or ascogonium borne on a multicellular stalk. Brown describes only one cell beyond the ascogonium, but since, in his youngest specimens, the archicarp was already covered by the sheath and was examined in section, it remains possible that a longer terminal region is really present.

As far, then, as our present knowledge goes, there are among the species grouped together in the genus *Lachnea* three distinct types of female organ, and *Lachnea cretea* differs from both the others in possessing several ascogonial cells.

In this particular it differs also, among neighbouring forms, from *Ascodesmis* (Boudiera) *nigricans* (Claussen, '05), *Pyronema confluens* (Harper, '00; Claussen, '12), and *Humaria granulata* (Blackman and Fraser, '06), and it approximates several members of the Ascobolaceae,

including species of *Ascobolus* and *Ascophanus* (Cutting, '09; Dodge, '12), where a series of ascogonial cells has been reported. *Ascobolus furfuraceus* (Welsford, '07) may possibly be regarded as an intermediate form; here several cells in the central region of the archicarp are united by pores, but ascogenous hyphae arise from only one.

The trichogyne of *Lachnea cretea* shows several points in common with those described by Dodge for various species of *Ascobolus* and *Ascophanus*. It differs from these in its branched extremity and in the changes which take place in its transverse septa.

Branched trichogynes are well known among the Laboulbeniales (Thaxter, '96, '08), but they have not been described elsewhere among the Ascomycetes. The arrangement in *Lachnea cretea* may represent, so to speak, a last effort to come into contact with an antheridium, or it may indicate the transformation of the trichogyne into a vegetative hypha. On the other hand, branching may very well have occurred when normal fertilization still took place.

*Lachnea cretea* adds another to the series of discomycetous forms, the investigation of which in recent years has served to break down the distinction previously drawn (Fraser and Chambers, '07) between the archicarp of the Discomycetes on the one hand and that of the Pyrenomycetes and Lichens on the other. It is now clear that, whereas *Pyronema confluens*, *Humaria granulata*, and sundry other Discomycetes possess a spherical ascogonium which does not undergo septation, yet a number of forms as typically discomycetous show a septate ascogonial region.

Moreover, in view of the very large pores found between the ascogonial cells, there seems no longer any reason to assume that, in normally fertilized forms, the ascogonial region was necessarily unicellular at the time of union of the male and female nuclei. For all practical purposes, the multicellular ascogonial region in *Lachnea cretea* is a single cell, and male nuclei could readily have passed from one end of it to the other.

We have thus at present three types of discomycetous ascogonium: the single spherical cell which does not become septate (*Pyronema*), the single narrow cell which undergoes septation after fertilization or its equivalent (*Ascodesmis*), and the multicellular ascogonial region (*Lachnea cretea*). There is evidence of relationship between the first two forms (Claussen, '12), the second being probably the more primitive and showing a closer resemblance to the presumably primitive Aspergillaceae (Fraser and Chambers, '07). The third is more difficult to place.

Nevertheless, the morphology of *Lachnea cretea* does something to suggest a relationship between this type and the Plectascineae. When young, the archicarp of *Lachnea cretea* closely resembles that of *Aspergillus herbariorum*, but it becomes differentiated by the development of the long, septate trichogyne, and of the septate ascogonial region. Further, the struc-

ture of the fruit in its early stages differs little from that of a young perithecium. In both we find an outer protective sheath and a series of inner layers which are differentiated by their inner walls and denser contents. In *Lachnea cretea*, as in other Discomycetes, the thinner layers grow upwards to form paraphyses, thrusting the outer sheath wide open; but it seems probable that this arrangement is secondary, and that in *Aspergillus* and its allies more primitive.

It remains for further investigation to determine whether all the forms in which a widely open fruit is produced—that is to say, the typical Discomycetes—are monophyletic, or whether they have arisen along diverse lines. For the moment, the value of the archicarp as a criterion is not quite clear.

Possibly the most useful piece of information derived from the study of *Lachnea cretea* is the fact that the septa of the trichogyne break down. Pores amply large for the passage of male nuclei are formed, and thus the multicellular character of this organ no longer appears to impose a barrier in the way of normal fertilization. It is much to be regretted that this process was not found to occur in the material under investigation.

In the last few years a considerable mass of literature has accumulated around the question of the behaviour of the sexual nuclei in the Ascomycetes and the related problem of the divisions in the ascus.

Fusion of male and female nuclei in pairs in the ascogonium has been described and figured in various Mildews (Harper, '95, '96, '05), and, among Discomycetes, in *Pyronema confluens* (Harper, '00) and *Ascodesmia nigricans* (Claussen, '05). Pseudapogamous fusion of female nuclei in pairs has been recorded in *Aspergillus repens* (Dale, '09), in *Humaria granulata* (Blackman and Fraser, '06), in *Lachnea stercorea* (Fraser, '07), in *Ascobolus furfuraceus* (Welsford, '07), and in *Ascophanus carneus* (Cutting, '09), and a corresponding fusion of vegetative nuclei, in the absence of a functional ascogonium, has been seen in *Humaria rutilans* (Fraser, '08) and in *Helvella crispa* (Carruthers, '11), and evidence of the same process has been found in *Polystigma rubra* (Blackman and Welsford, '12).

On the other hand, Claussen in *Pyronema confluens* ('07, '12) and Schikorra in *Monascus* spp. ('09) have observed the association of the sexual nuclei in pairs in the ascogonium, but have described their fusion as delayed till, travelling and dividing side by side, they at last reach the ascus and there unite. Faull ('12) in an apogamous species of *Laboulbenia* has described a comparable state of affairs. The fusion in the ascus is regarded by these authors as the completion of the sexual act.

It must be recognized that the fusion in the ascogonium may be readily overlooked even in fairly large forms, but some other criteria are of assistance in determining whether it has occurred.



Harper ('10) calls attention to the marked increase in size of the nuclei in the ascogonium in connexion with fertilization. In his opinion, judging from the size of the nuclei in Claussen's figures of young ascogenous hyphae, their fusion has already taken place. To a certain extent, changes in bulk may be accounted for by growth, but growth alone does not explain such differences between neighbouring nuclei as are shown by Blackman and Fraser ('06) in the ascogonium of *Humaria granulata* (Figs. 14, 16, &c.) or by Cutting ('09) in that of *Ascophanus carneus* (Fig. 9).

Both Claussen and Faull have attached importance to the conjugate arrangement of the nuclei in the ascogenous hyphae as indicating that each pair represents an associated male and female nucleus. There is no doubt that a conjugate arrangement is common in the most diverse parts of certain Ascomycetes. It has been described in the last few cells of the ascogenous hyphae in a large variety of forms by many authors (Maire, '03, '05; Brown, '10, &c., &c.), by McCubbin ('10) in the vegetative hyphae of *Helvella elastica*, by Carruthers ('11) in the paraphyses of *Helvella crispa*, by Nichols ('96) in the germ tubes of the ascospores of *Ceratostoma brevirostre*, and by Masee ('05) in the conidial mycelium of *Hypomyces perniciosum*, and in some other forms.

But there is nothing to show that it depends on a previous association of sexual nuclei or of their representatives, and in the upper reaches of ascogenous hyphae it may well be explained by the prospective fusion in the ascus—whatever the significance of that curious process.

A more critical question is the arrangement in the ascogenous hyphae at their first formation. Claussen figures these hyphae in *Pyronema* as multinucleate, the nuclei being arranged more or less regularly in pairs. It is very difficult to think of an attraction which, while not strong enough to bring about fusion, yet holds a pair of sexual nuclei together in a multinucleate organ, where, to judge from Claussen's figures, they may be not even in contact and where they may be equally near to members of another pair. Such an arrangement seems to the writer to require overwhelming proof. It is not at all comparable to that of the Uredineae, where each pair of conjugate nuclei is isolated in a separate cell (Maire, '11, &c., &c.). In the Mildews, where normal fertilization takes place and where the ordinary cells are uninucleate, thus making a paired arrangement much easier to detect than in coenocytic species, the conjugate condition has not been observed (cf. Harper, '05, p. 19).

It may be noted in this connexion that vegetative nuclear fusions, among which that in the developing ascus might well be grouped, have been recorded in the cells which give rise to the paraphyses in *Leotia* (Brown, '10), in the young hairs of *Lachnea albo-spadicea* (Masee, '97), in the quadri-nucleate ascus of *Humaria rutilans* (Fraser, '08), and in the conidia of *Hypomyces* (Masee, '05). The phenomenon of conjugate division is probably

but a special example of the very general fact that nuclei present in the same cell usually divide simultaneously.

A third criterion in relation to the behaviour of the sexual nuclei lies in the reduction-processes in the ascus. It is now recognized that the first and second divisions constitute a meiotic phase compensating the sexual fusion. A second reduction, called brachymeiotic, has been described in the third division for several species, and must, where it occurs, obviously correspond to a second fusion, that in the ascus.

In its simplest form, as in *Humaria rutilans* (Fraser, '08), *Lachnea stercorea* (Fraser and Brooks, '09), and *Helvella crispa* (Carruthers, '11), this process consists in the appearance at the poles of the third spindle of a number of chromosomes half that seen in the first and second divisions in the ascus and in the prophase of the third. It is thus essential that the third telophase should be studied. Claussen ('12), though he denies the occurrence of brachymeiosis, omits to figure this critical stage in such a way that the chromosomes can be counted.

Faull ('12), who also opposes the idea of a second reduction, seems to have misunderstood the position. 'Fraser and her co-workers', he says (p. 347), 'state that they have detected in certain forms indications of the theoretical second reduction.' Now these authors, rightly or wrongly, have quite definitely recorded and figured the occurrence of a brachymeiotic reduction of the chromosomes, the 'indication' in question being that the chromosomes are half as numerous in the third telephase as in that of the first division in the ascus.

They have suggested an explanation (Fraser and Welsford, '08) of the forms in which, as in *Phyllactinea*, an evident change in the chromosome number does not occur.

It is not proposed to enter here into details which have already been discussed, but it is perhaps worth while to place on record that a re-examination of the preparations in question has confirmed the writer in the view that an actual numerical change, whatever its significance, takes place in connexion with the third division in the ascus.

Faull adds (p. 347) that 'Guillermond, Dangeard, Maire, Brooks', himself, 'Claussen, as also Harper, have found no second reduction in the many forms examined by them.'

This statement is open to misconception. Dangeard in *Ascobolus furfuraceus* (Botaniste, vii, 1907, pp. 316-17) and in *Pyronema confluens* (Botaniste, vii, 1907, p. 284), and Maire in *Morchella esculenta* (Annales Mycologici, iii, 1905, pp. 135-6), in *Peziza vesiculosa* (Annales Mycologici, iii, 1905, p. 134), and in *Galactinia succosa* (Annales Mycologici, iii, 1905, pp. 130-2), both found a condition corresponding to that later described as brachymeiosis. Brooks (Annals of Botany, xxiv, 1910, p. 598) affirms that he was unable to determine whether the reduction he observed in *Gnomonia*

*erythrostroma* was meiotic or brachymeiotic, and Harper (Publ. Carnegie Inst. of Washington, No. 37, pp. 82-4) states clearly that he regards the divisions in the ascus of *Phyllactinea corylea* as bringing about two reductions.

The study of the first and third divisions, *and especially of the third telophase*, in forms with large nuclei, is essential for the satisfactory determination of this question.

#### SUMMARY.

1. The archicarp of *Lachnea cretea* arises as a branch from one of the main hyphæ and forms a coil of two or three turns.

2. From the hypha bearing the archicarp and from neighbouring hyphæ, branches grow out to form a sheath.

3. The archicarp becomes differentiated into three regions, the multicellular stalk, the coiled, multicellular ascogonial portion, and the septate trichogyne. The latter elongates considerably, and ultimately branches. No antheridium was observed.

4. The trichogyne becomes emptied, its transverse septa break down, and the pores are closed by homogeneous pads. It suggests itself that the trichogyne has only recently ceased to function.

5. The ascogonial region contains numerous nuclei. Very large pores are found between its constituent cells, and the nuclei pass freely from one cell to another. Ascogenous hyphæ arise from the several cells.

6. Asci are formed in the usual way. The nuclei show about eight chromosomes in the first division.

7. The nuclei were too small to allow a satisfactory study of their behaviour either in the ascogonium or in the later divisions in the ascus, the significance of which is discussed.

8. In the structure of its archicarp *Lachnea cretea* differs markedly from the other investigated species of *Lachnea*. It resembles several of the Ascobolaceæ, and shows some points in common with *Aspergillus*.

---

#### LIST OF PAPERS.

1. BLACKMAN, V. H., and FRASER, H. C. I. ('06): On the Sexuality and Development of the Ascocarp in *Humaria granulata*. Proc. Roy. Soc., London, B., lxxvii, p. 354.
2. ——— and WELSFORD, E. J. ('12): The Development of the Perithecium of *Polystigma rubrum*. Ann. Bot., xxvi, p. 761.
3. BROOKS, F. T. ('10): The Development of *Gnomonia erythrostroma*, Pers. The Cherry Leaf Scorch-disease. Ann. Bot., xxiv, p. 585.
4. BROWN, W. H. ('10): The Development of *Leotia*. Bot. Gaz., 1, p. 443.

5. CARRUTHERS, D. ('11): Contributions to the Cytology of *Helvella crispa*. Ann. Bot., xxv, p. 243.
6. CLAUSSEN, P. ('05): Zur Entwicklungsgeschichte der Ascomyceten, *Boudiera*. Bot. Zeit., lxxviii, p. 1.
7. ——— ('12): Zur Entwicklungsgeschichte der Ascomyceten, *Pyronema confluens*. Zeitschr. für Bot., iv, p. 1.
8. CUTTING, E. M. ('09): On the Sexuality and Development of the Ascocarp in *Ascophanus carneus*. Ann. Bot., xxiii, p. 399.
9. DALE, E. ('09): On the Morphology and Cytology of *Aspergillus repens*. Ann. Myc., vii, p. 215.
10. DANGEARD, P. A. ('07): Recherches sur le développement du périthèce chez les Ascomycètes. Botaniste, x, p. 1.
11. DODGE, B. O. ('12): Methods of Culture and the Morphology of the Archicarp in certain Species of the Ascobolaceae. Bull. Torrey Bot. Club, xxxix, p. 139.
12. FAULL, J. H. ('12): The Cytology of *Laboulbenia chaetophora* and *L. Gyrinidarum*. Ann. Bot., xxvi, p. 325.
13. FRASER, H. C. I. ('07): On the Sexuality and Development of the Ascocarp in *Lachnea stercorea*. Ann. Bot., xxi, p. 349.
14. ——— ('08): Contributions to the Cytology of *Humaria rutilans*. Ann. Bot., xxii, p. 35.
15. ——— and CHAMBERS, H. S. ('07): The Morphology of *Aspergillus herbariorum*. Ann. Myc., v, p. 419.
16. ——— and WELSFORD, E. J. ('08): Further Contributions to the Cytology of the Ascomycetes. Ann. Bot., xxii, p. 465.
17. ——— and BROOKS, W. E. ST. J. ('09): Further Studies on the Cytology of the Ascus. Ann. Bot., xxiii, p. 537.
18. HARPER, R. A. ('95): Die Entwicklung des Peritheciums bei *Sphaerotheca castagnei*. Ber. d. Deutsch. Bot. Ges., xiii, p. 475.
19. ——— ('96): Über das Verhalten der Kerne bei der Fruchtentwicklung einiger Ascomyceten. Jahrb. für wiss. Bot., xxix, p. 656.
20. ——— ('90): Sexual Reproduction in *Pyronema confluens*, &c. Ann. Bot., xiv, p. 321.
21. ——— ('05): Sexual Reproduction and the Organization of the Nucleus in certain Mildews. Publ. Carnegie Inst. of Washington, No. 37, p. 1.
22. ——— ('10): Nuclear Phenomena of Sexual Reproduction in Fungi. Am. Naturalist xlv, p. 533.
23. MAIRE, R. ('03): Recherches cytologiques sur le *Galactinia succosa*. Comptes rendus, cxxxvi, p. 769.
24. ——— ('05): Recherches cytologiques sur quelques Ascomycètes. Ann. Myc., iii, p. 123.
25. ——— ('11): La Biologie des Urédinales. Prog. Rei Bot., iv, p. 109.
26. MASSEE, G. ('97): A Monograph of the Geoglossaceae. Ann. Bot., xi, p. 225.
27. ——— ('05): On the Presence of Binucleate Cells in the Ascomycetes. Ann. Bot., xix, p. 325.
28. McCUBBIN, ('10): Development of the Helvellineae. Bot. Gaz., xl, p. 195.
29. NICHOLS, M. A. ('96): The Morphology and Development of Certain Pyrenomycetous Fungi. Bot. Gaz., xxii, p. 301.
30. SCHIKORRA, W. ('09): Über die Entwicklungsgeschichte von *Monascus*. Zeitschr. für Bot., i, p. 379.
31. THAXTER, R. ('96): Contributions towards a Monograph of the Laboulbeniaceae, Pt. I. Mem. Am. Acad. Arts and Sciences, xii, No. iii, p. 195.
32. ——— ('08): Contributions towards a Monograph of the Laboulbeniaceae, Pt. II. Mem. Am. Acad. Arts and Sciences, xiii, No. vi, p. 219.
33. WELSFORD, E. J. ('07): Fertilization in *Ascobolus furfuraceus*. New Phyt., vi, p. 136.

EXPLANATION OF PLATES XLII AND XLIII.

Illustrating Dr. H. C. I. Gwynne-Vaughan's paper on *Lachnea cretea*.

PLATE XLII.

- Fig. 1. Mature ascocarp.  $\times 100$ .  
Fig. 2. Very early stage in development of archicarp and of investing hyphae. Uncut.  $\times 500$ .  
Fig. 3. Rather older; the tip of the archicarp is growing out to form a trichogyne. Uncut.  $\times 500$ .  
Fig. 4. Later stage of same; development of rooting hyphae. Uncut.  $\times 500$ .  
Fig. 5. Young fruit; the ascogonial region of the archicarp is enclosed in the sheath and the branched trichogyne protects; the latter is almost empty and the pads have appeared on its cross-walls. Uncut.  $\times 500$ .  
Fig. 6. A rather older fruit, showing the elaborately branched trichogyne. Uncut.  $\times 500$ .  
Fig. 7. Section showing a very young archicarp.  $\times 666$ .  
\*Fig. 8. Older stage in section; the coil appears foreshortened, being seen from one end. The trichogyne is developing; the nuclei are crowded.  $\times 666$ .  
Fig. 9. Somewhat older archicarp; trichogyne becoming emptied.  $\times 666$ .  
Fig. 10. Section through a young fruit to show development of sheath and its relation to the hypha bearing the archicarp.  $\times 666$ .  
\*Fig. 11. Coiled archicarp, showing stalk, coiled ascogonial region with numerous nuclei, and long, branched trichogyne. Pads have developed on most of the septa of the trichogyne, but through a septum near the ascogonial region a mass of granular substance is continuous from cell to cell.  $\times 666$ .

PLATE XLIII.

- \*Fig. 12. Part of an older fruit, showing an ascogonial cell with numerous nuclei and a long, empty trichogyne.  $\times 666$ .  
Fig. 13. Two ascogonial cells in continuity. Nuclei passing from one to the other.  $\times 1,000$ .  
\*Fig. 14. Three ascogonial cells united by very large pores and almost empty. Above, asci are developing.  $\times 666$ .  
Fig. 15. Group of ascogenous hyphae.  $\times 2,000$ .  
Fig. 16. Prophase of first division in ascus, showing about eight chromosomes.  $\times 2,000$ .  
Fig. 17. Metaphase of first division in ascus.  $\times 2,000$ .

\* *Figures marked thus have been drawn from two or more consecutive sections.*

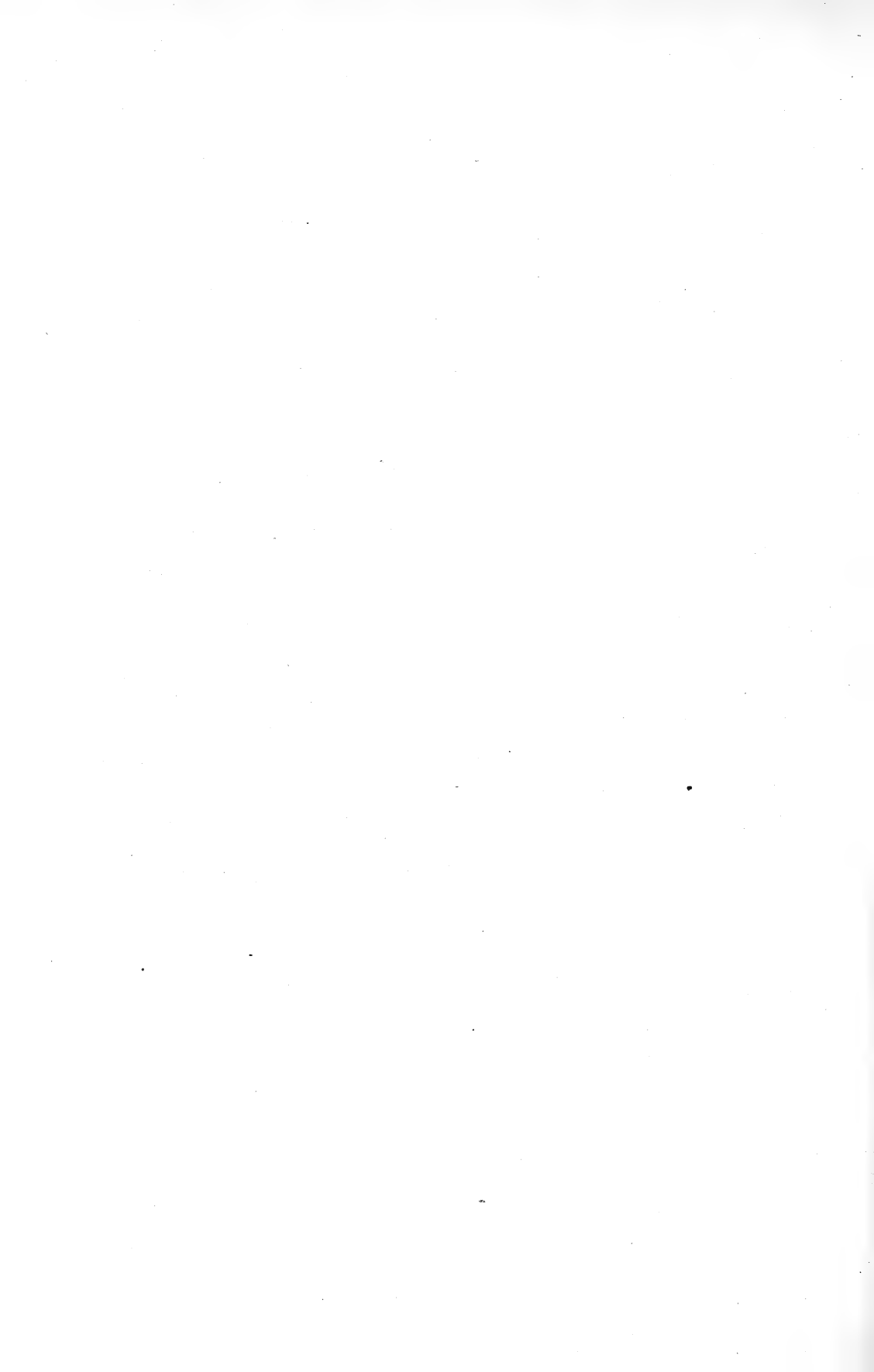



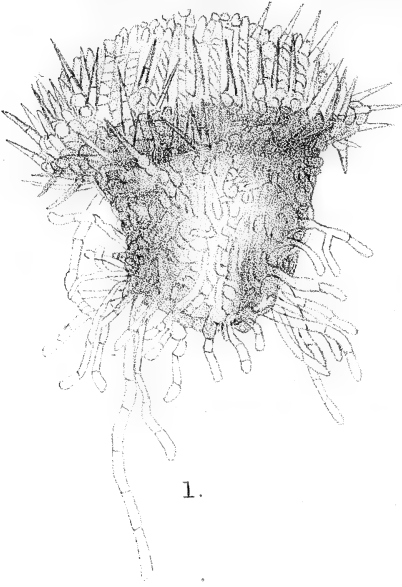

1.

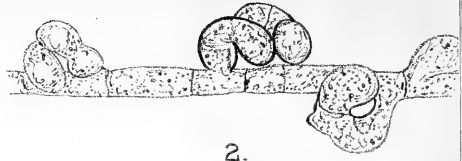

2.

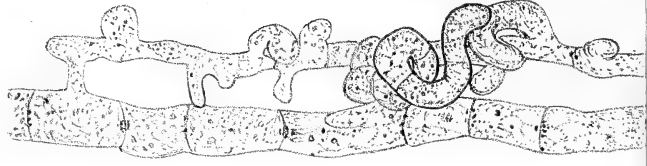

3.

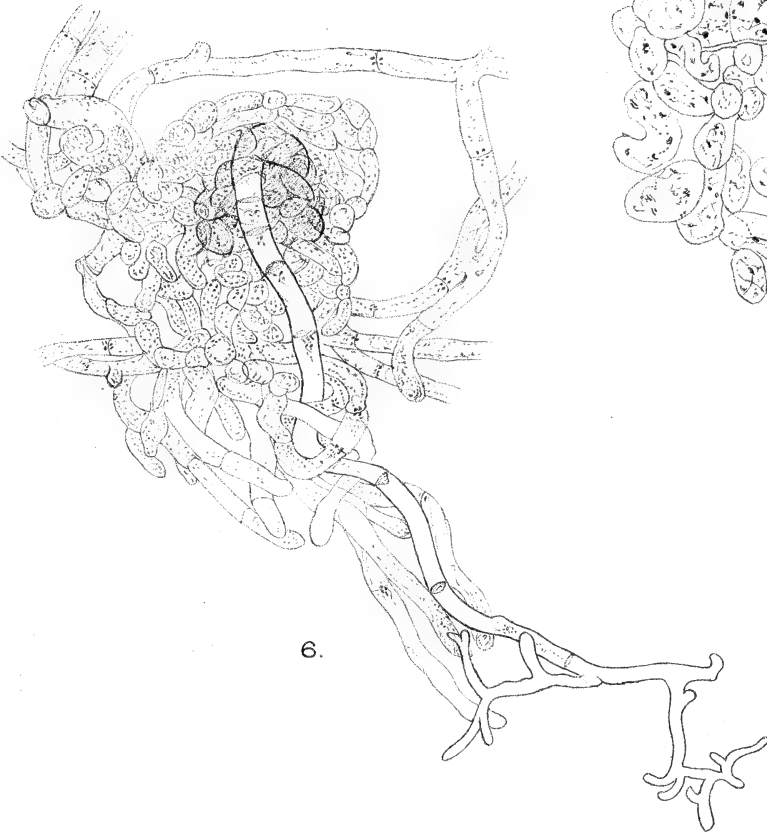

6.



10.





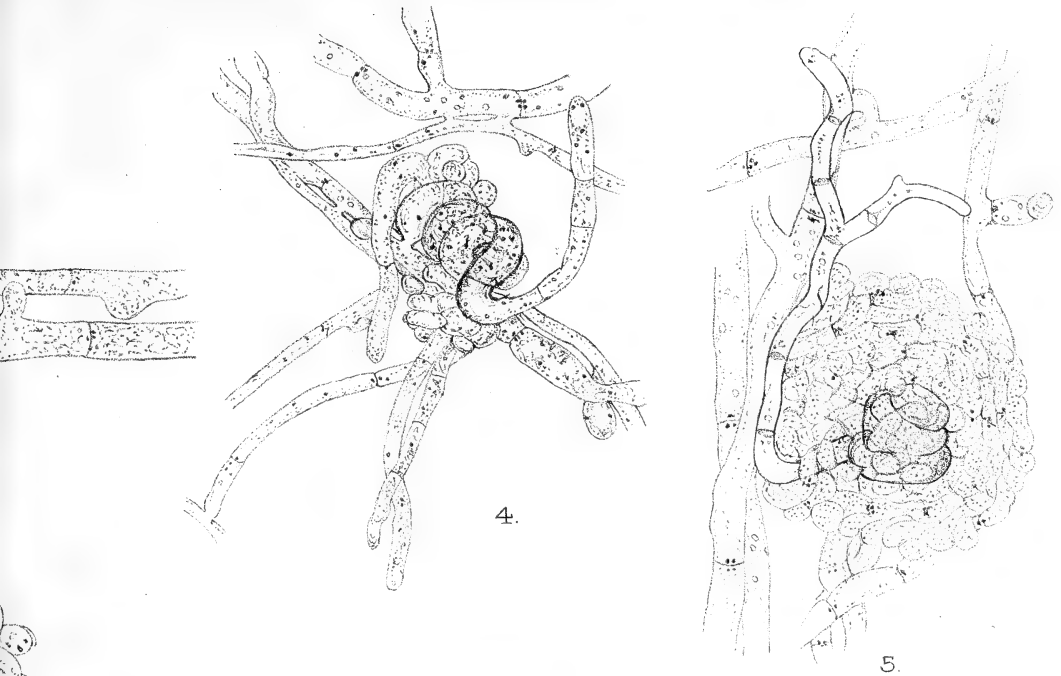

4.

5.

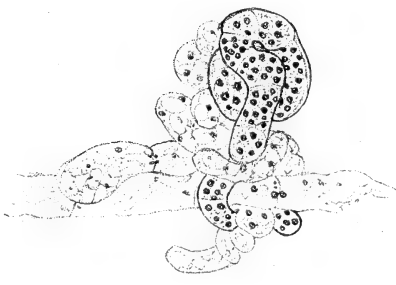

8.

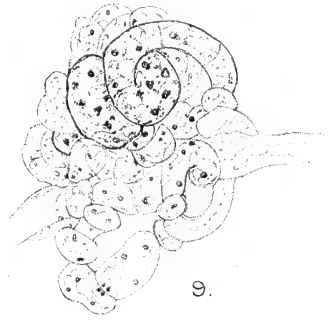

9.



7.

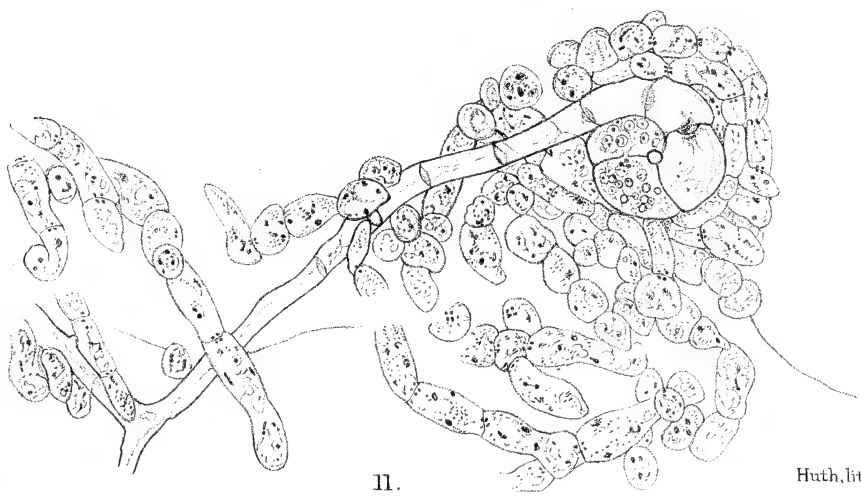

11.





1.

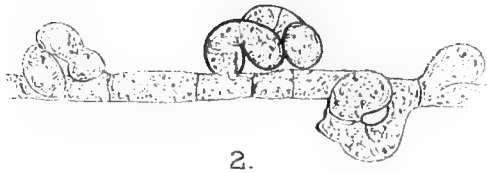

2.

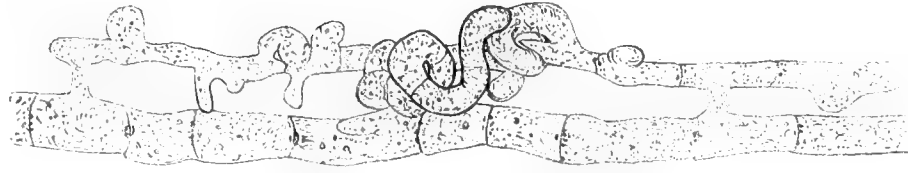

3.

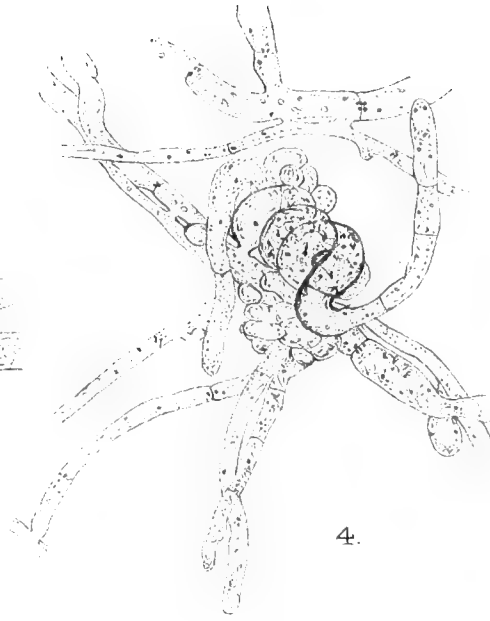

4.

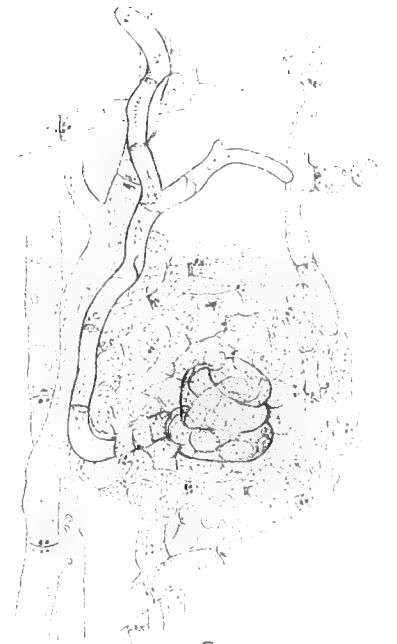

5.



6.

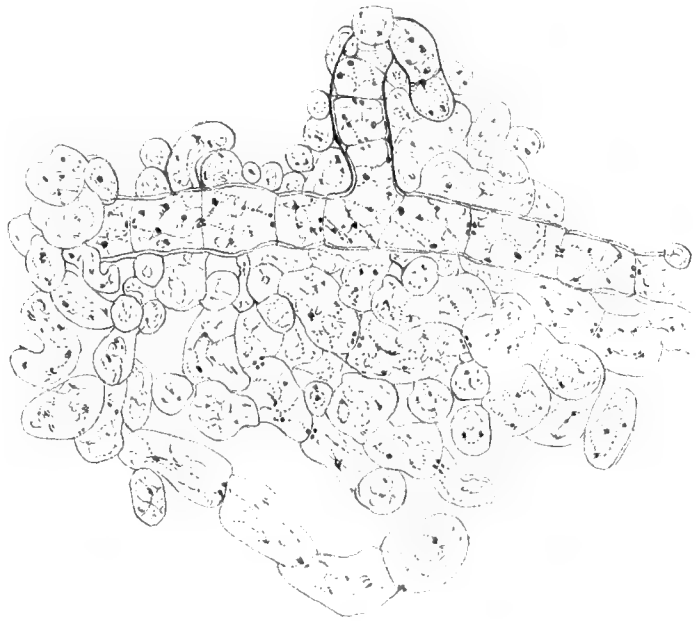

10.



8.

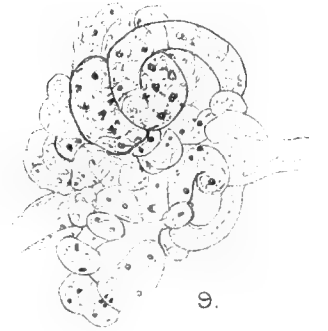

9.

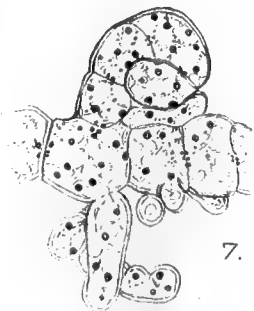

7.

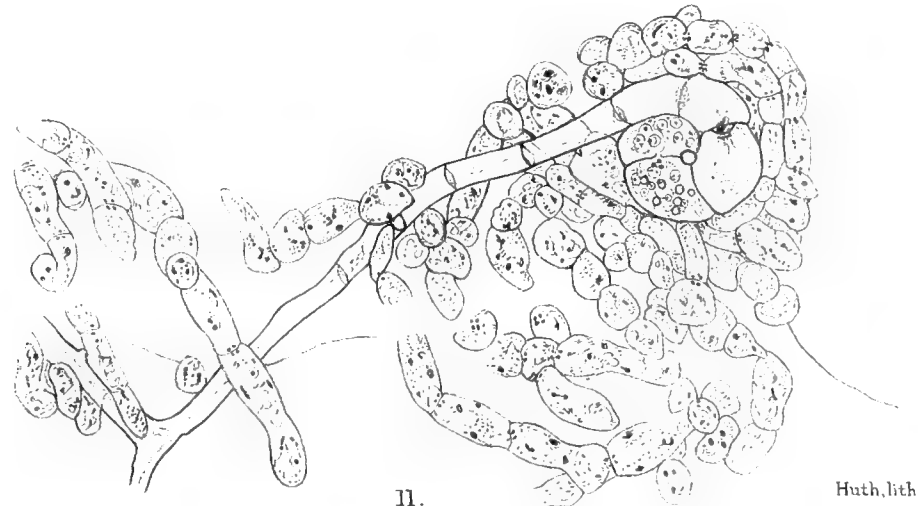

11.



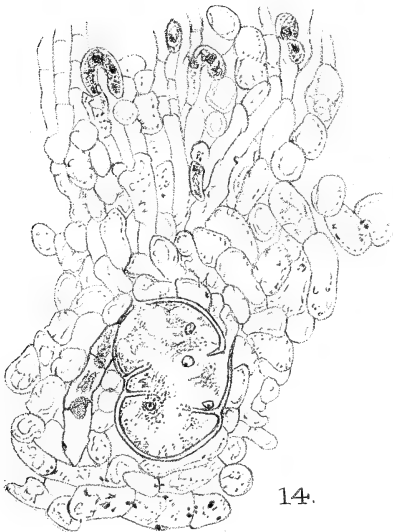
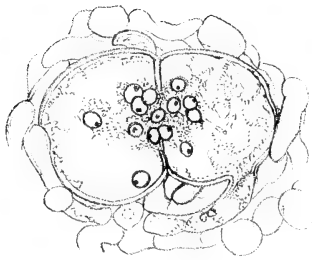
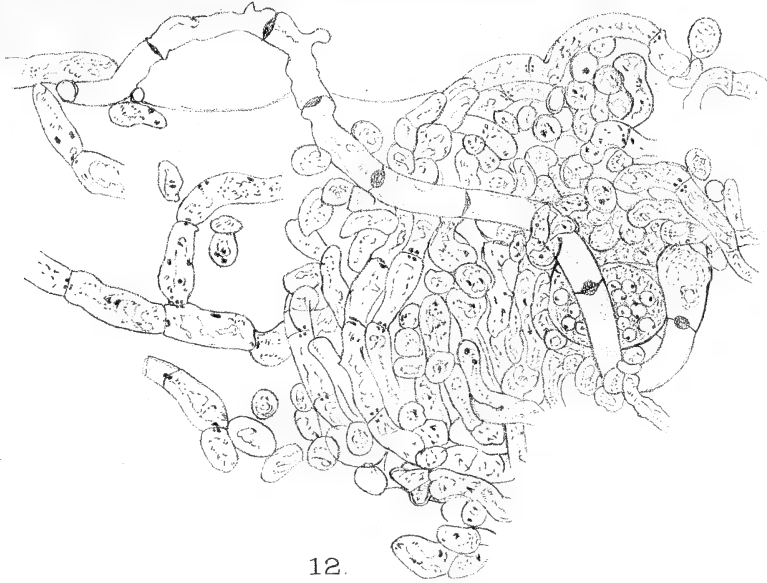

Huth, lith. et imp.



# On the Capillary Eudiometric Apparatus of Bonnier and Mangin for the Analysis of Air in investigating the Gaseous Exchanges of Plants.

BY

D. THODAY, M.A. (Camb.),

*Lecturer in the Physiology of Plants in the University of Manchester.*

With two Figures in the Text.

THE apparatus devised by Bonnier and Mangin for the analysis of air as described by Aubert<sup>1</sup> and made by M. Golaz, of Paris, has advantages which are especially valuable in investigations of the gaseous exchanges of plants in which determinations of the rate of absorption of oxygen as well as of production of carbon dioxide are desired. The volume of gas required for analysis is only about 0.3 c.c., so that, for instance, small plant organs may be enclosed in a volume of air small enough to ensure that the composition of the air will become measurably altered within a reasonable time. The other principal advantage of the apparatus is the rapidity with which analyses can be made with it; an analysis and the subsequent washing of the apparatus need occupy less than twenty minutes.

This apparatus has found favour in many quarters, and those who have used it have generally expressed themselves well satisfied with the degree of accuracy which they have obtained with it.<sup>2</sup> On close scrutiny, however, their results hardly justify complete satisfaction.

All the results of analyses of atmospheric air show a deficiency of oxygen amounting to 0.1-0.4 or more below the correct 20.9%. Bonnier and Mangin themselves<sup>3</sup> found 20.8%, which agreed with Dumas's determination, the one then current. Curtel, using the new apparatus,<sup>4</sup> found, however, 0.00% CO<sub>2</sub> and 20.59% O<sub>2</sub>, and apparently assumed this throughout

<sup>1</sup> Rev. gén. de Bot., iii, 1891. Earlier forms of the apparatus are described and precautions discussed by Bonnier and Mangin in Ann. d. sc. nat., Bot., vi, 17, 18, 19; vii, 2, 3.

<sup>2</sup> Richards: Annals of Bot., x, 1896, p. 536; Palladin: Rev. gén. de Bot., v, 1893; Maige: Rev. gén. de Bot., xxi, 1909, p. 32; Aubert: Rev. gén. de Bot., iv, 1892, p. 281; Nicolas: Ann. d. sc. nat., Bot., ix, 10, 1909, p. 25; &c.

<sup>3</sup> Ann. d. sc. nat., Bot., vi, 17, 1884, p. 210.

<sup>4</sup> Rev. gén. de Bot., ii, 1890, p. 7.

his experiments to be the initial composition of the air. Lamarlière,<sup>1</sup> working in Bonnier's laboratory, found 0.04 % CO<sub>2</sub> and 20.60 % O<sub>2</sub>. Puriewitsch, using Baranetzky's modification of the apparatus,<sup>2</sup> determined the initial composition of the air in all his experiments, and in these analyses the percentage of oxygen is in no case higher than 20.6. Moreover, Stich<sup>3</sup> says that numerous analyses of atmospheric air (with an older form of the apparatus) differed from Dumas's by 0.2–0.3 %.

Some time ago I required such a method of analysis for work on respiration, and Dr. F. F. Blackman suggested this apparatus as possibly a suitable and convenient one if it would give sufficiently accurate results. Earlier trials with it in the Cambridge Botany School had not been altogether successful.<sup>4</sup> My experience was also unfavourable at first. The directions given by Aubert were closely followed, but a number of difficulties were encountered. These were only overcome by modifying the procedure. Recently, however, I have succeeded in obtaining results, the degree of accuracy of which approaches very nearly to the highest to be expected; I hope, therefore, that this account of the technique adopted may prove of service.

Fig. 1 illustrates the essential features of the apparatus. By turning the handle A, the piston B is moved in the cylinder C, which is filled with mercury. In this way an air-thread may be propelled from the graduated part, EF, of the capillary tube into the bent ungraduated part, FG, where absorption takes place, or drawn back into the graduated part again for measurement. The end of the capillary tube opens under mercury in the reservoir H.

The measuring and absorbing regions of the capillary tube correspond to the distinct measuring and absorbing tubes of the earlier forms of the apparatus. The absorbing liquid is drawn into the capillary, from a test-tube which is pressed down over the end of the capillary in the reservoir H, and is then expelled, the air being brought into contact with the film of liquid left wetting the walls of the absorbing region. The bulb D acts as a trap for the gas under analysis to prevent it being inadvertently drawn down into the metal cylinder and there partially lost. It is not to be used for absorption, as stated by Macdougall.<sup>5</sup> The absorbing solutions should never reach the graduated part of the tube, which is used solely for measurement.<sup>6</sup>

<sup>1</sup> Rev. gén. de Bot., iv, 1892, p. 481.

<sup>2</sup> Jahrb. f. wiss. Bot., xxxv, 1900, p. 578.

<sup>3</sup> Flora, N.S., xlix, 1891, p. 7.

<sup>4</sup> Cf. Darwin and Acton: Physiology of Plants, 1901, p. 10.

<sup>5</sup> Textbook of Plant Physiology, 1901, p. 259.

<sup>6</sup> Stoward (Ann. of Bot., 1908) found a constant error of –0.86 per cent. in the amount of CO<sub>2</sub>, and attributes this to potash persistently retained in the bulb! Unless Stoward followed Macdougall's directions it is difficult to understand either how potash got into the bulb at all, or how such a large error could have resulted if the tube and bulb were thoroughly washed out with acid.



Analyses are carried out rapidly enough for ordinary changes of barometric pressure to be negligible, and the apparatus is so constructed that all the readings for one analysis are taken under appreciably the same pressure of mercury. This is ensured by the horizontal placing of the measuring-tube and by the relatively large surface of the mercury in the reservoir H.

It is, of course, necessary for accurate results that the mercury should move perfectly freely in the tube, and the first difficulty lay in attaining this condition. Even after the mercury had been carefully cleaned, by dropping through dilute nitric acid and finally by distillation *in vacuo*, a scum appeared when the tube was washed with water after hydrochloric acid, as recommended by Aubert, and this scum it was almost impossible to remove completely. I infer it to be calomel produced by the action of

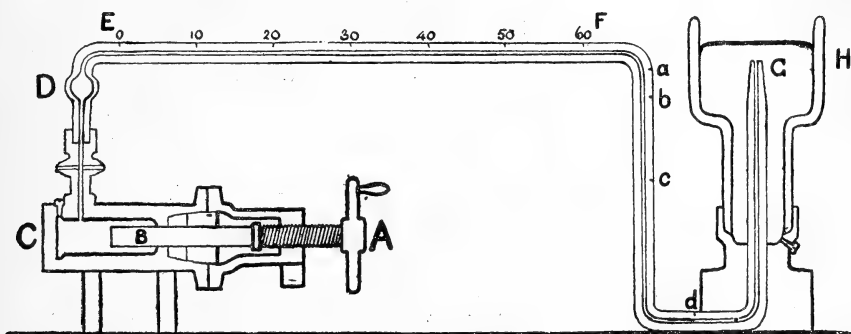

FIG. 1.

hydrochloric acid on traces of oxide in the mercury,<sup>1</sup> and precipitated when the film of hydrochloric acid is diluted with water. When dilute sulphuric acid was used instead of hydrochloric acid this difficulty disappeared, and the washing of the tube was greatly facilitated.<sup>2</sup>

When next the tube is thoroughly washed out with distilled water and the excess of water is carefully driven out by a series of short mercury threads, the residual film breaks up into drops, and a mercury meniscus no longer moves smoothly, but with a series of jerks. This is avoided if the water used for the final washing contains some sulphuric acid; I have therefore used latterly a 5% solution of sulphuric acid as the sole washing liquid. The film then left on the walls of the capillary remains unbroken, and a mercury meniscus moves perfectly freely in the tube, vibrating about its position of rest before becoming stationary. The film also serves the purpose of ensuring a constant vapour tension.

<sup>1</sup> Berthelot : Comptes Rend., xci, p. 871 ; Barfoed : Journ. f. prakt. Chem. (2), xxxviii, 1888, p. 459.

<sup>2</sup> It is, of course, necessary to protect the open surface of mercury when the apparatus is not in use, and especially to keep the small amount of dust and oxide which collects on the surface from getting into the capillary.

Notwithstanding the thickness of the walls of the capillary, the volume of air in the apparatus was observed many times to change in a direction corresponding to fluctuations in the temperature of the laboratory; and when the temperature was low an increase of volume was noticed, which might be attributable to the proximity of the observer. The graduated tube was therefore enclosed in a case made of long strips of glass to protect it from draughts, and a cardboard screen interposed between it and the observer. More recently I have surrounded the tube with a trough of water, in order to gain as complete control as possible of any change of temperature which may occur during analysis. Even then changes of  $0.1-0.2^{\circ}$  C. were often observed, for which corrections were necessary of  $\pm 0.03$  to  $0.07$  in the percentage of oxygen, or  $\text{CO}_2$ . Over the trough a long strip of glass is placed, which serves to screen the trough from the breath of the observer, and also as a rest for the lens or other device used to avoid errors of parallax.

Meanwhile, the effect of varying the composition of the pyrogallate solution was tried. The solution first employed was that recommended by Hempel in earlier editions of his 'Gas Analysis', and the percentage of oxygen obtained varied between 20.5 and 20.7. This solution had the disadvantage that a single film is not powerful enough to absorb all the oxygen even during prolonged contact.<sup>1</sup> It was necessary to renew the film several times before absorption was complete. It is probable that the conditions were especially favourable to the production of CO, for at the first contact practically the whole length of the film was exhausted; and after it was renewed the portion which the air first met again was exhausted.<sup>2</sup> Thus it is probable that the production of CO accounts in part for the large deficit of oxygen obtained with this solution.

In more recent editions Hempel recommends a solution made up with much stronger potash (120 grm. in 80 c.c. water instead of 60 %), and with this a series of analyses of atmospheric air gave an average of 20.89 as the combined percentage of  $\text{CO}_2$  and oxygen. This close approximation to the correct 20.96 % ( $\text{CO}_2 + \text{O}_2$ ) I failed, however, to repeat, getting usually about 20.8 %.

Similar results were obtained with Haldane's solution,<sup>3</sup> which is much more powerful and is stated to produce no CO. A single film of this solution nearly suffices for complete absorption, and only requires to be once renewed. It seemed improbable, therefore, that the error was due to the production of CO.

<sup>1</sup> Bonnier and Mangin remark on the necessity for repeated contact. *Ann. d. sc. nat., Bot.*, vi, 18, 1884, p. 291.

<sup>2</sup> Cf. Müller, on the necessity of slowing down absorption when much oxygen is present, in *Abderhalden's Handbuch der biochem. Arbeitsmethoden*, iii, p. 624.

<sup>3</sup> *Methods of Air Analysis*, 1912, p. 13. Difficulty was found in making a solution of potash of the strength mentioned by Haldane, and the solution used was made up with potash of specific gravity 1.5 instead of 1.55. Cf. below, p. 570, and see also F. G. Benedict, *The Composition of the Atmosphere*, Carnegie Institute of Washington, 1912, pp. 80 and 111-13.

Careful callibration of the tube showed that the error from slight inequalities of bore was between + 0.01 and + 0.02 in the percentage of oxygen, and therefore practically negligible.

The error did not appear to be due to incomplete absorption. In fact the volume of the residual nitrogen was observed frequently to increase after repeated contact with the absorbing film of pyrogallate of potash. This observation led me to investigate the effect of various purely physical changes, and particularly of the mechanical operations involved in the ordinary procedure. It was found that air introduced into the apparatus and brought repeatedly into the absorbing region of the tube soon began apparently to increase slightly in volume. This change was reversed, on the other hand, if the air was drawn back into the bulb. This empirical result is difficult to explain satisfactorily. There can be little doubt, however, that the apparent changes of volume are caused by movements of the film of moisture which wets the walls of the whole capillary. This film probably tends to accumulate in the horizontal graduated part of the tube, especially as this is at the highest level, a movement which would be accelerated by the encroaching films of absorbing solution. For some reason the transfer of air to the absorbing region tends to favour this accumulation, whereas withdrawal into the bulb tends to hinder it—indeed, to counteract it. Whether this be the true explanation or not, readings taken after withdrawal into the bulb are more constant than readings taken immediately after transfer to and from the absorbing region.

Taking advantage of this observation and always reading the volume after withdrawing the air into the bulb, repeating the process a few times to make sure that the readings were constant, the following results were obtained, after correcting for temperature and introducing the slight callibration correction.

ANALYSES OF A SAMPLE OF ATMOSPHERIC AIR.

	(1)	(2)	(3)	(4)	Average.
% CO <sub>2</sub>	0.04	0.03	0.07	0.03	0.04
% O <sub>2</sub>	20.89	20.89	20.86	20.88	20.88
<hr/>					
%(CO <sub>2</sub> +O <sub>2</sub> )	20.93	20.92	20.93	20.92	20.92

These results agree with one another as closely as can be expected. The maximum difference from the mean percentages is 0.03, which corresponds to an error of little more than one-tenth of a small graduation less than a millimetre in length.

The average percentage of oxygen, 20.88, is still somewhat lower than the 20.93 found by Hempel and by Haldane with more elaborate apparatus. In a recent paper Benedict<sup>1</sup> has given the results of analyses of atmospheric

<sup>1</sup> Loc. cit., p. 113.

air with a new and apparently still more accurate form of apparatus. Results obtained with the same absorbing solution were remarkably concordant, but he found constant differences in the percentage of oxygen according to the particular solution used. With Hempel's solution he obtained 20.85 %, with a solution made with rather weaker potash than in Haldane's solution 20.938 %, while with Haldane's solution he obtained 20.956 % oxygen. He infers that a small trace of CO is produced with even slightly weaker solutions as compared with Haldane's solution.

Thus it appears probable that the small deficit which my analyses still show is due, at any rate in part, to the evolution of traces of CO, for the pyrogallate solution was not made up quite according to Haldane's instructions.<sup>1</sup> The error is small, however, and relatively constant with the solution used in these analyses. Being constant it is for all practical purposes negligible, for it enters into all analyses to appreciably the same extent, and is eliminated when changes of composition are determined by difference. At the same time it appears advisable to use a potassium pyrogallate solution made up accurately according to Haldane's instructions.

The following series of seven analyses of a sample of expired air (which had been retained in the lungs for some seconds) is a further illustration of the degree of concordance obtainable with Bonnier and Mangin's apparatus when used in the way described.

## ANALYSES OF SAMPLE OF EXPIRED AIR.

Analysis	(1)	(2)	(3)	(4)	(5)	(6)	(7)	Average.
% CO <sub>2</sub>	1.44	1.41	1.43	1.38	1.38	1.42	1.44	1.41
% O <sub>2</sub>	19.55	19.61	19.55	19.61	19.61	19.58	19.54	19.58
% (CO <sub>2</sub> + O <sub>2</sub> )	20.99	21.02	20.98	20.99	20.99	21.00	20.98	20.99

The maximum difference from the mean percentages is  $\pm 0.04$  %, so that a single analysis may be taken to be correct at least to the nearest 0.1 %.

In the following *résumé* of the procedure finally adopted a number of details are given which have not yet been referred to, but which are nevertheless important, as they greatly facilitate the use of the apparatus.

## ACCESSORY APPARATUS.

The *reagent tubes* are fitted with short lengths of glass-rod as handles (Fig. 2). Three are necessary for the reagents, and another (empty) for drying the capillary. Tubes of the same form are convenient for holding the samples of air to be analysed. They can be supported conveniently over small dishes of mercury in small stands of the form shown in Fig. 2,

<sup>1</sup> See footnote 3, p. 568, and references there given.

which can easily be constructed from copper wire and wood. The wire is bent in such a way that the handles of the tubes are readily removed or pressed into position.

The tubes for the absorbing liquids should have their edges fused in a flame till they just will not go right down over the capillary tube, but stop at the base of the tapering end of it. The acid-tube, on the other hand, as also the air-tubes, should be wide enough to go right down over the capillary so that a thorough neutralization of the absorbing liquid is ensured.

The reagent tubes are most readily filled by first pouring in the reagent to about a centimetre from the open end, and then filling up with clean mercury. On inverting over mercury, the slight escape of liquid is removed with soft tissue or filter paper.

As the absorbing liquids tend to creep out of their respective tubes, the pyrogallate tube should be kept by itself in a separate dish of mercury.

The tubes are transferred to the apparatus closed below by the finger, and pressed down over the end of the capillary tube. On now turning the handle A (Fig. 1) in the required direction the liquid or air is drawn into the tube.

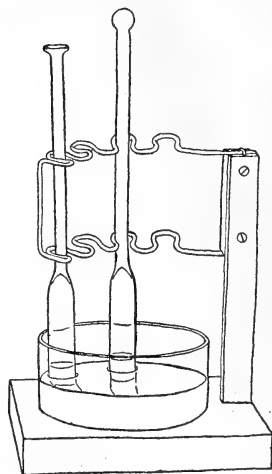

FIG. 2.

#### REAGENTS.

Washing liquid: 5 % sulphuric acid. If dilution of the concentrated acid results in the formation of a slight precipitate this should be allowed to settle before use.

Solutions for absorption: (1) A 10 % solution of caustic potash; (2) a solution of potassium pyrogallate, made<sup>1</sup> by adding 10 grammes of pyrogallol to 100 c.c. of a nearly saturated solution (sp. gr. 1.55) of caustic potash (not purified by alcohol<sup>2</sup>).

#### PROCEDURE.

To clean the apparatus before an analysis a bubble of air is introduced, then clean acid rapidly drawn in as far as zero on the graduated tube. The air-bubble traps any drops of mercury which are left behind where the tube is dirty. The acid is slowly expelled, and again rapidly drawn in, the process being repeated, if necessary with a change of acid, until the mercury

<sup>1</sup> See Haldane: Methods of Air Analysis, 1912, p. 13; and for further details, Benedict, l. c., pp. 80 and 112.

<sup>2</sup> Hempel: Gas Analysis, 1911, p. 115.

no longer tails off. The tube of acid is then removed, and the acid is blotted from the end of the capillary tube and from the surface of the mercury.

After an analysis acid is drawn in as far as the pyrogallate film has reached, and the contaminated acid washed out a few times. Finally, with clean acid the whole tube is washed out as already described.

A strip of paper is now inserted round the edge of the free mercury surface in the reservoir (H), and, by drawing this across, a clean surface is left, over which an empty tube is inverted. By rapidly moving the test-tube up and down over the end of the capillary tube, short threads of mercury are drawn in, separated by bubbles of air. When the chain reaches about two-thirds of the way along the graduated tube the test-tube is removed and the chain drawn rapidly back nearly to the bulb; in this way the excess of moisture in the tube is passed by the mercury threads. These are now slowly moved to the right and they drive the water in front of them. When the end of the chain has moved over a portion of the graduated tube it is drawn rapidly back again; most of the water is left where it was. This rapid backward and slow forward movement of the chain is repeated, the forward movement carrying the chain farther, after the first few times, so that gradually the whole of the chain is expelled. Finally the end of the capillary tube and the mercury surface are blotted.

Should the mercury still not move freely in the tube,<sup>1</sup> acid may be left in it for some time, or better still a strong solution of potassium cyanide.<sup>2</sup> The latter should be carefully washed out afterwards with distilled water. Finally the tube is washed as described. If this does not suffice the tube probably needs removing and thoroughly cleaning with nitric acid, &c., or the mercury itself requires purification.

*To make an analysis* the air is drawn in to a mark (Fig. 1, *c*) made half-way up the vertical part of the tube. The sample-tube is removed and the air drawn back till nearly the whole of it is in the bulb. It is now pushed back again, the right-hand end is adjusted accurately to the graduation marked 50 and the position of the other end read; or the adjustment may be approximate and the position of both menisci read. The air is now drawn again into the bulb, again adjusted, and its volume read, and in this way several readings of the volume are made to test their agreement.

The initial volume of the air having been obtained in this way, it is moved along till the right meniscus reaches point *d* (Fig. 1). Potash solution is drawn in to point *a*, and very slowly expelled, till the air comes in contact with the film of potash left on the walls of the tube, the left meniscus being at *a*. If a high percentage of CO<sub>2</sub> is expected, the potash is drawn in fairly quickly a second or third time and again very slowly

<sup>1</sup> To test this, watch for the vibration of the right-hand meniscus, or compare the readings obtained for the volume of air in the tube when drawn to the left and when pushed to the right.

<sup>2</sup> I am indebted to Dr. A. Lapworth, F.R.S., for suggesting the use of this solution.

expelled, finally until a drop of mercury is seen to emerge from the end of the capillary tube in the potash solution. The potash is now blotted carefully from the end of the capillary tube under the mercury, the air being driven slightly farther along at the end of the process to make sure that no potash is left in the tube. Now the air is drawn back into the bulb as before, the right meniscus again adjusted to the same point and the volume read; as before, this is repeated a few times or until the readings are constant.<sup>1</sup>

The solution of pyrogallate of potash is drawn in fairly quickly in the same way as the potash solution. The air is brought, not too slowly, into contact with the film of solution. Fresh solution is drawn in and this time very slowly expelled. If much coloration is observed the film may be renewed a second time. Finally the left meniscus is moved to *c*, the tube blotted, and readings of the remaining volume obtained,<sup>1</sup> as before.

<sup>1</sup> N.B. A sudden alteration in the length of the air-thread during measurement means that the absorbing solution has been too quickly expelled; too much has thus been left on the walls of the tube and has gradually collected at one point till it has broken the mercury thread there and altered the pressure of the air. This bubble of liquid must be expelled, and the end of the tube again blotted carefully before the reading of the volume is continued.





## NOTE.

**NOTE ON THE OCCURRENCE OF AN ABNORMAL BISPORANGIATE STROBILUS OF *LARIX EUROPAEA*, DC.**—In April, 1912, a specimen of an abnormal cone of *Larix europaea* bearing both mega- and microsporangia was gathered from a tree at Kiveton Park, Yorks. A careful search failed to discover any other similar specimens on the branches of the same tree within reach. The cone was thrown into methylated spirit soon after gathering, and later it was embedded in paraffin and completely sectioned in the vertical direction by microtome.

The strobilus was of about the same size as the ordinary female cones of Larch at the time of the year when it was obtained. The upper half of the cone was composed of normally developed megasporophylls, and the lower part of microsporophylls. The intermediate region between the two kinds of sporophylls was occupied by a narrow zone of small, sterile scales exhibiting no definite form or structure.

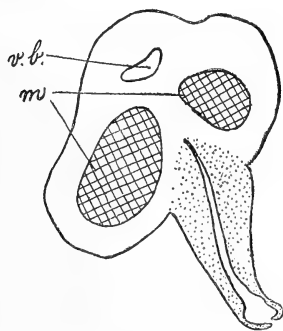

FIG. 1. Somewhat oblique tangential section of abnormal microsporophyll. *m.*, microsporangia; *v.b.*, vascular bundle.

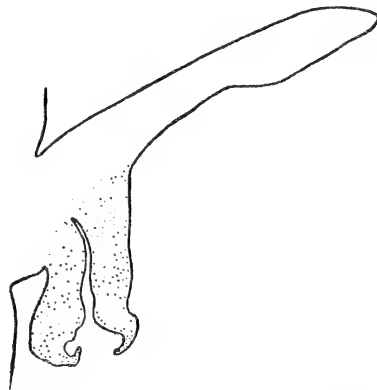

FIG. 2. Median radial vertical section of abnormal microsporophyll.

While most of the microsporophylls were normally developed, those next to the zone of indeterminate scales showed various abnormalities. The microsporangia were reduced in size, and sometimes one was smaller than the other. Nevertheless, the development of the pollen-grains was scarcely affected, and some of them were sufficiently far advanced to show the two flattened and disorganized prothallial cells, the generative cell and tube cell.

The most abnormal feature, however, in several of the microsporophylls adjoining the abortive sporophylls, was the possession of a peculiar downwardly directed process, growing from between the two microsporangia. The form and position of this structure are shown in the two accompanying figures, where it

is indicated by shading with dots. Fig. 1 is a somewhat oblique tangential section of a microsporophyll, and Fig. 2 represents a median radial vertical section of a microsporophyll passing between the two microsporangia. This abnormal structure usually arises in the median position, but its apex is often somewhat obliquely directed on account of the mutual pressure of the neighbouring microsporophylls. It is traversed by a tubular cavity, which is widest at the mouth and gradually narrows upwards to a blind ending. The cells of which the principal part of the structure is composed are rather small, with relatively large nuclei which stain deeply with Delafield's haematoxylin, suggesting glandular tissue.

I am unable to draw any conclusions as to the nature of these peculiar processes.

According to Coulter and Chamberlain<sup>1</sup> the occasional occurrence of bisporangiate strobili has been reported for *Picea excelsa*, *Pinus maritima*, *Abies* sp., *Pseudotsuga Douglasii*, *Sequoia*, and *Juniperus communis*, and to this list *Larix europaea* must now be added. Coulter and Chamberlain state that they are evidently of very rare occurrence among Pinaceae.

A. W. BARTLETT.

UNIVERSITY OF SHEFFIELD.

<sup>1</sup> Morphology of Gymnosperms, 1910, p. 238.

# FLORAL MECHANISM

BY A. H. CHURCH, M.A., D.Sc.  
LECTURER IN BOTANY IN THE UNIVERSITY OF OXFORD

The following statement has been drawn up by  
Professor Sydney H. Vines

THE object of this work is to provide the botanical student with a complete description of the development, morphology and mechanism of the principal types of flowers. Whilst giving the kind of information that is to be found in Payer's *Organogénie de la Fleur*, and in the late Professor Eichler's well-known *Blüthendiagramme*, it supplements this with an account of the ecology of the flower, including pollination and the formation of fruit and seed. Hence, when complete, it will be the most comprehensive treatise on the flower that has yet been published.

The general plan of the work may be gathered from Part I, which was published in 1908 as a royal 4to volume of 211 pages. In it are described the following twelve types of floral structure, selected from familiar garden flowers that bloom in the early part of the year (January–April):—

<i>Helleborus niger</i>	Christmas Rose.	<i>Viola odorata</i>	Sweet Violet.
<i>Galanthus nivalis</i>	Snowdrop.	<i>Narcissus Pseudo-Narcissus</i>	Daffodil.
<i>Jasminum nudiflorum</i>	White Jasmine.	<i>Erica carnea</i>	Heath.
<i>Crocus vernus</i>	Blue Crocus.	<i>Ribes sanguineum</i>	Flowering Currant.
<i>Richardia africana</i>	White Arum Lily.	<i>Cydonia japonica</i>	Scarlet Cydonia.
<i>Daphne Mezereum</i>	Mezereon.	<i>Vinca major</i>	Greater Periwinkle.

In connexion with each type, two or three allied species are described for purposes of comparison.

The description of each type is illustrated by a full-page coloured plate, giving an accurate longitudinal section of the flower, and by a black-and-white plate giving the inflorescence, the floral diagram, and other structural details. As each subsidiary species has also a coloured plate allotted to it, the volume contains no less than forty coloured and fourteen uncoloured plates, in addition to a large number of figures, chiefly developmental, included in the text. It can be obtained at the original price of £1 1s. net by subscribers to Part II.

It was hoped that the reception of so striking a volume as Part I would have been such as to justify the Delegates of the Press in proceeding forthwith to publish Part II, the material for which is in readiness. Inasmuch as this anticipation has unfortunately not been realized so far, the Delegates are not disposed to undertake the publication of Part II without some assurance that the necessarily large expenditure involved will meet with the general support of those who, in one way or another, are interested in flowers. But the University Press has received such warm commendations of the work from Botanists who desire to push on the study of Botany in the English-speaking countries that they desire, if possible, to continue publication. They propose, therefore, to ask for subscriptions for copies of Part II at One Guinea each, on the understanding that Part II will, like Part I, consist of descriptions of twelve types of flowers, with allied forms, and be similarly illustrated, though it may be found necessary to reduce somewhat the number of coloured plates. Any copies not subscribed for will not be sold at less than thirty shillings each.

*Science Progress*:—‘Without doubt one of the most interesting botanical books of recent years, and one which in its turn should become a classic.’

*Journal of Botany*:—‘In noticing this very beautiful and elaborate work, one remark seems obvious—there is nothing else like it.’

*Nature*:—‘A valuable contribution to botanical literature, excellent alike in the text and in the illustrations, and the execution is worthy of the Clarendon Press. . . . No botanical school can afford to neglect so valuable and suggestive a storehouse of information.’

Order Forms may be had on application.

# THE JOURNAL OF ECOLOGY

EDITED FOR THE  
BRITISH ECOLOGICAL SOCIETY

BY  
FRANK CAVERS

THE objects of *The Journal of Ecology* are (1) to foster and promote in all ways the study of Ecology in the British Isles, serving as the organ of the BRITISH ECOLOGICAL SOCIETY; (2) to present a record of and commentary upon the progress of Ecology throughout the world. Each quarterly issue contains original articles and notes on ecological topics of current importance, including methods of ecological study and research; notes on current work in the British Isles; reviews and notices of publications of general ecological bearing, of work upon British vegetation, and of work upon foreign vegetation; answers to questions from members of the British Ecological Society, so far as these are of general interest; general correspondence; reports and notices of meetings of the British Ecological Society; progress of the Nature Protection movement and of ecological work in Nature Reserves; list of current literature.

*The Journal of Ecology*, being largely a Review, is indispensable to those desiring to keep abreast of the extensive and widely scattered literature of Ecology, of which it will take a comprehensive view, including in its scope not only work dealing with general principles, methods, surveys, and other ecological studies, but also publications dealing with Geography, Geology, Meteorology, Climatology, Plant Physiology and Anatomy, the science of soils (soil physics, chemistry, and the investigation of soil floras and faunas), and other branches of Natural Science, so far as these have a direct bearing upon Ecology—the relationships of plants to their environment in the widest sense, including the inter-relationships between plants and animals. In brief, it aims at furnishing a comprehensive review of progress in the entire field of Ecology, touching, as this field does, kindred branches of science on various sides.

*The Journal of Ecology* is published quarterly—in March, June, September, and December. The annual subscription price, including postage to any part of the world, for a single copy of each of the four issues making up the annual volume, is Fifteen Shillings (15s.) net; single copies, Five Shillings (5s.) net each. Subscriptions for the *Journal* are payable in advance and should be sent to Mr. C. F. CLAY, Cambridge University Press, Fetter Lane, London, E.C., either direct or through any bookseller.

Members of the British Ecological Society should send their annual subscription to the Society, One Guinea (£1 1s.), which includes the supply of one copy of each of the four issues of the *Journal*, to the Secretary, Dr. F. CAVERS, Goldsmiths' College, New Cross, London, S.E., to whom all Editorial communications should also be addressed.

## *Contents of Vol. I, No. 1. March 1913*

THE AIMS OF THE NEW JOURNAL. By A. G. TANSLEY.

EDITORIAL NOTICE.

SOME REMARKS ON BLAKENEY POINT, NORFOLK. By F. W. OLIVER.

RAUNKIAER'S 'LIFE-FORMS' AND STATISTICAL METHODS. By

WILLIAM G. SMITH.

REVIEW. A UNIVERSAL CLASSIFICATION OF PLANT-COMMUNITIES.

By A. G. TANSLEY.

BRIEFER ARTICLES:—

The Relation of the Present Plant Population of the British Isles to the Glacial Period. By CLEMENT REID.

The Nature Reserve Movement in Great Britain. By WILFRED MARK WEBB.

NOTICES OF PUBLICATIONS OF GENERAL BEARING.

NOTICES OF WORKS ON BRITISH VEGETATION.

NOTICES OF WORKS ON FOREIGN VEGETATION.

RECENT LITERATURE.

---

A prospectus giving further particulars as to the *British Ecological Society* and *The Journal of Ecology* will be sent on application to Mr. C. F. CLAY, Manager, Cambridge University Press, Fetter Lane, E.C.

Vol. XXVII. No. CVIII. October, 1913. Price 14s.

# ANNALS OF BOTANY

EDITED BY

DUKINFIELD HENRY SCOTT, M.A., LL.D., D.Sc., FOR. SEC. R.S.

LATELY HONORARY KEEPER OF THE JODRELL LABORATORY, ROYAL BOTANIC GARDENS, KEW

JOHN BRETLAND FARMER, D.Sc., M.A., F.R.S.

PROFESSOR OF BOTANY, ROYAL COLLEGE OF SCIENCE, LONDON

FRANCIS WALL OLIVER, M.A., D.Sc., F.R.S.

QUAIN PROFESSOR OF BOTANY, UNIVERSITY COLLEGE, LONDON

AND

ROLAND THAXTER, M.A., Ph.D.

PROFESSOR OF CRYPTO GAMIC BOTANY IN HARVARD UNIVERSITY, CAMBRIDGE, MASS., U.S.A.

*ASSISTED BY OTHER BOTANISTS*

LONDON

HUMPHREY MILFORD, OXFORD UNIVERSITY PRESS  
AMEN CORNER, E.C.

EDINBURGH, GLASGOW, NEW YORK, TORONTO, MELBOURNE, AND BOMBAY

1913

# CONTENTS.

	PAGE
SAXTON, W. T.—Contributions to the Life-history of <i>Tetraclinis articulata</i> , Masters, with some Notes on the Phylogeny of the Cupressoideae and Callitroideae. With Plates XLIV–XLVI and nine Figures in the Text . . . . .	577
GLÜCK, H.—Contributions to our Knowledge of the Species of <i>Utricularia</i> of Great Britain with Special Regard to the Morphology and Geographical Distribution of <i>Utricularia ochroleuca</i> . With Plates XLVII and XLVIII and seven Figures in the Text . . . . .	607
HARPER, ALAN G.—Defoliation: its Effects upon the Growth and Structure of the Wood of <i>Larix</i> . With Plates XLIX and L and two Figures in the Text . . . . .	621
BEEB, RUDOLF.—Studies in Spore Development. III. The Premeiotic and Meiotic Nuclear Divisions of <i>Equisetum arvense</i> . With Plates LI–LIII . . . . .	643
GRAHAM, MARGARET.—Studies in Nuclear Division of <i>Preissia commutata</i> . With Plates LIV and LV . . . . .	661
MCALLISTER, F.—Nuclear Division in <i>Tetraspora lubrica</i> . With Plate LVI . . . . .	681
THODAY, D.—On the Effect of Chloroform on the Respiratory Exchanges of Leaves. With fifteen Figures in the Text . . . . .	697
HILEY, W. E.—On the Value of Different Degrees of Centrifugal Force as Geotropic Stimuli. With Plates LVII and LVIII and three Figures in the Text . . . . .	719
BOSE, J. C.—On Diurnal Variation of Moto-excitability in <i>Mimosa</i> . With seventeen Figures in the Text . . . . .	759
THOMAS, N.—Notes on Cephaleuros. With Plate LIX . . . . .	781
COMPTON, R. H.—An Anatomical Study of Syncotyly and Schizocotyly. With forty-one Figures in the Text . . . . .	793

---

## NOTICE TO SUBSCRIBERS.

The subscription-price of each volume is thirty shillings, payable in advance: the Parts, four in number, are supplied as they appear, post free to subscribers in the United Kingdom, and with a charge of 1s. 6d. per annum for postage to subscribers residing abroad. The price of individual Parts is fixed at a higher rate. Intending subscribers should send their names, with subscription, to HUMPHREY MILFORD, Oxford University Press, Amen Corner, London, E.C.

As the earlier volumes of the *Annals of Botany* are becoming scarce, Vol. I will only be sold as part of a complete set; and Parts will not as a rule be sold separately, after the publication of the volume to which they belong. A few extra copies of particular Parts at present remain on hand, for which special application must be made to the Editors, Clarendon Press, Oxford.

---

## NOTICE TO CONTRIBUTORS.

In future, English contributors should address their papers to Professor F. W. OLIVER, F.R.S., University College, Gower Street, London, W.C.; and contributors in America to Professor R. THAXTER, Harvard University, Cambridge, Mass.

Papers sent in with a view to publication *must be type-written* and *must conclude with a summary of the contents*. The illustrative figures should be planned so as to fill properly a 4to or an 8vo plate. The maximum space available for figures in a 4to plate is  $8\frac{1}{4} \times 11\frac{1}{4}$  inches, in an 8vo plate  $8\frac{1}{4} \times 5\frac{1}{4}$  inches. Attention to this will conduce to the rapid publication of papers if accepted.

Each contributor to the *Annals of Botany* is entitled to receive gratis one hundred separate copies of his paper, and may purchase additional copies if he informs the Editors of his wishes in this respect when he returns corrected proofs. The price of these additional copies will depend upon the amount of text and the number of plates in the paper.

# Contributions to the Life-history of *Tetraclinis articulata*, Masters, with some Notes on the Phylogeny of the Cupressoideae and Callitroideae.

BY

W. T. SAXTON, M.A., F.L.S.,

*Professor of Botany at the Ahmedabad Institute of Science, India.*

With Plates XLIV-XLVI and nine Figures in the Text.

## INTRODUCTION.

THE Gum Sandarach tree of Morocco and Algeria has been well known to botanists from very early times. Some account of it is given by Hooker and Ball (20), who speak of the beauty and durability of the wood, and state that they consider the tree to be probably correctly identified with the *θύλλον* of the Odyssey (v. 60),<sup>1</sup> and with the *θύλλον* and *θύλα* of Theophrastus ('Hist. Pl.' v. 3, 7),<sup>1</sup> as well as, undoubtedly, with the Citrus wood of the Romans. The largest trees met with by them, growing in an uncultivated state, were about 30 feet high. The resin, known as sandarach, is stated to be collected by the Moors and exported to Europe, where it is used as a varnish. They quote Shaw (49 *a* and *b*) as having described and figured the tree under the name of *Thuja articulata*, in his 'Travels in Barbary'; this statement, however, is not accurate. In both editions of the work cited the plant is figured and described as 'Cupressus fructu quadrivalvi, foliis Equiseti instar articulatis'.

Some interesting particulars of the use of the timber are given by Hansen (19), who also implies that the embryo has from three to six cotyledons.

Both Hooker and Ball, and Hansen, followed by almost all others who have studied the plant, speak of it as *Callitris quadrivalvis*.

Masters (31) first distinguished it generically in 1893, on account of the well-marked differences which it presents, in the external characters of the foliage and branches, from all the species of *Callitris*. The name *Tetraclinis*

<sup>1</sup> The two references quoted have been corrected from those given by Hooker and Ball, which are inaccurate in both cases.

has, however, not been taken up (with two or three exceptions) by later investigators, although in external features it resembles *Widdringtonia* far more closely than *Callitris*, and if external characters were alone to be used as the criterion, it ought rather to be placed in the former genus than the latter. Dr. C. E. Moss informs me that the plant is known to the Forestry officials in Algeria as *Tetraclinis*.

Several investigators have studied some points in the morphology. Strasburger (52) describes and figures immature archegonia as being precisely like those of all other Cupressoideae, the number of archegonia being given as 'fifteen or more'. Eichler (14) figures the external features of strobili and foliage. Goebel (18) gives figures of the young female strobilus and of a longitudinal section of the ovule.

More interesting, though less precise, are the observations recorded by Juel (21), who unfortunately, however, gives no figures. He reports that the ovules were rather large, and that most of them were empty and shrivelled; others were found to contain a normal endosperm, but no trace of archegonia, nor even of any space or disorganized part; even when archegonia were present, they were never normal, but sometimes had the typical terminal group as well as a smaller similar group at the side of the endosperm. It is not entirely clear what is here meant by 'normal'; if it means the typical archegonial complex of the Cupressoideae, as would seem probable, my own results are in direct conflict with those of Juel, but the chief point of interest is that lateral archegonia are stated to occur, either with or without the ordinary terminal group.

Norén (37, p. 31), in a footnote, makes a similar observation: 'In den Präparaten von *Callitris quadrivalvis*, die ich zu untersuchen Gelegenheit hatte, waren oft mehrere Archegoniengruppen vorhanden. Dies ist aber wahrscheinlich eine abnorme Erscheinung, vielleicht hervorgerufen durch die Kultur im Gewächshause, wo sich der Baum befand, der das Material geliefert hat.' It is doubtful, however, whether the abnormality is wholly due to the effect of cultural conditions; reference will be made to this point later.

The idea was prevalent at one time that this plant was the type species of the genus *Callitris*; Baker and Smith (3), however, consider that the type was one of the Australian plants included in the genus *Callitris*, though they were not able to express any very firm opinion as to which species was the first to be so named (probably *C. rhomboidea*). They follow Masters in excluding *Tetraclinis* (and *Widdringtonia*) from the genus, and even if it should prove that this plant was the original type of *Callitris*, the international rules require that the latter name shall be kept for the greater number of species, in the event of the genus being split. By the same code of rules it is clear that the correct specific name of the plant would be *articulata*, so that Masters's name, *Tetraclinis articulata*, is entirely valid.



*Tetraclinis articulata* is a tree forming forests of considerable extent in the mountains of Northern Africa, especially in Algeria and Morocco.

The maximum height is given by Hooker and Ball (loc. cit.) as 30 feet, and by Engler (15) as 10 metres, but Dr. Moss informs me that the tree reaches a height of about 40 feet, half that height being typical of average trees.

The material used in the present investigation was obtained from a single tree about 20 feet high, growing in the grounds of the South African Museum, Cape Town. I am glad to take this opportunity of thanking Dr. L. Péringuey, Director of the Museum, for his permission to collect the cones at frequent intervals. The origin of the tree in the South African Museum grounds is not certainly known, but it is believed to have been introduced there about 1840, along with a number of other exotic trees of similar age.

The fixing fluids employed have been (i) Chromosmaccetic acid, and (ii) Picric-corrosive sublimate-acetic. For certain stages the former proved most satisfactory, while in other cases the latter was decidedly superior. The methods employed in embedding, &c., have been the same as those used in the study of *Actinostrobus* (47). The triple stain has been used throughout, but for the cytological details of the meiotic divisions a duplicate series has been prepared with Heidenhain's haematoxylin.

#### THE MICROSPORANGIATE STROBILUS AND MICROSPOROGENESIS.

The male cones, before the final elongation which separates the sporophylls, are 5-6 mm. long. The sporophylls, as in *Widdringtonia* (Saxton (44 and 45)), are more or less peltate and bear four microsporangia on the proximal side of the stalk. They are arranged in decussate pairs. The final elongation results in an increase of about 65 per cent. in length. The following are averages of measurements of well-grown cones:

Length of cones before extension, 5.72 mm.

Length of cones after extension, 9.43 mm.

The microsporangia are exactly similar to those of other Cupressoideae. In the young sporangium there are three layers of cells outside the spore mother-cells, of which the outermost is the epidermis and persists as the mature wall, while the two inner are derived by the division of a single hypodermal layer which is part of the sporogenous tissue and which functions as a tapetum.

In some ways the male cones of *Tetraclinis* have proved very well suited to a cytological investigation. A good range of stages is found in a single cone, and some variation in a single sporangium; cones of the right age are very easily collected for a number of days, as they do not all develop simultaneously; and cones of such an age are moderately easy to

fix and embed satisfactorily. On the other hand, the nuclei are somewhat small (though slightly larger than in the Callitroideae); and the large amount of starch present in the later stages of the meiotic divisions is apt sometimes to obscure the cytological details.

The resting nucleus (Pl. XLIV, Fig. 1) appears practically identical in structure with that figured by various investigators in other pollen mother-cells. There is a network of anastomosing linin threads with numerous rather conspicuous chromatin granules, and a large nucleolus which can usually be seen in optical section to be hollow. No starch is visible. As the nucleus prepares for synapsis, the linin thread thickens to form a deeply staining slender spireme (Fig. 2). This spireme is not one single coiled continuous thread without anastomoses, but can be clearly seen to branch at certain points. Isolated starch grains now appear in the cytoplasm. Then the mesh begins to contract to one side of the nuclear cavity (Fig. 3), this being quickly followed by complete synapsis (Fig. 4). In *Tetraclinis*, as these figures demonstrate, there is no approach whatever to the condition claimed by Lawson (28) to be characteristic of synapsis. According to that author synapsis consists in an expansion of the nuclear cavity, and not in a contraction of the contents, but even his own figures, as mentioned in a criticism by Professor Farmer, do not support his contention. It may be mentioned, however, that an enlargement of the whole nucleus does occur in *Tetraclinis* about the time of recovery from synapsis.

As far as can be estimated the nuclei remain for some time in this contracted condition, practically no structure being visible. As recovery begins to set in, loops may sometimes be seen projecting from the periphery of the contracted mass (Fig. 5). Very soon recovery is complete, a very slender spireme being formed (Fig. 6), in which fewer anastomoses can be seen than before contraction. This spireme gradually thickens and shortens (Fig. 7), and at the same time the number of anastomoses becomes less, though it does not appear as though the thread ever becomes entirely free from branching. Up to this time no trace whatever has been seen of any splitting of the thread, such as occurs regularly in some angiospermous pollen mother-cells at this time. Traces of the same splitting have been claimed by Lewis (29) in *Pinus* and *Thuja*, and by Miss Ferguson in *Pinus*.

The stage following (Fig. 8) is that sometimes called the second contraction figure (Farmer and Moore (16), Mottier (33)), but in *Tetraclinis* no real contraction occurs so far as can be seen. This figure is of interest as showing the only phenomenon which could be interpreted as splitting of the thread, though such an appearance is probably due merely to the approximation of the two sides of a loop.

Next the thread breaks up to form about a dozen bivalent chromosomes, and these soon shorten and thicken to form the curved bodies seen in Fig. 9. The earliest stages of spindle formation have not been seen distinctly in

*Tetraclinis*, but a spindle becomes obvious about the time when the spireme segments, and on it the chromosomes arrange themselves, and, breaking up, begin to move towards the poles (Figs. 10, 11, 12). The chromosomes apparently become split at this time, since more than twelve may be counted in polar view (Figs. 13 and 15) passing to the pole, at about the stage of Figs. 12 and 14. This point will be discussed below. The chromosomes on arrival at the pole first form a rather ragged and deeply staining lump (Fig. 16), which soon opens out to form a well-defined daughter nucleus (Figs. 17 and 18). No trace of a cell-wall, either permanent or transitory, is seen at any time between the two daughter nuclei. The next figure (Fig. 19) shows a stage which does not appear to agree with that described for other plants. A spireme is organized and at once splits up, before any spindle is recognizable, into about twenty-four chromosomes (i. e. the  $2x$  number) and these become oriented on the spindle, when the latter becomes visible, and, without any division or split in individual chromosomes, separate into two groups of about twelve V-shaped rods, which pass to the poles in the usual way (Figs. 20 and 21). It is worthy of mention that the two spindles of the 'homotype' division are invariably at right angles to one another, never parallel, as is said to be the case sometimes in other genera.

As the four resulting nuclei reorganize, the spindles of the homotype division disappear entirely, giving the structure shown in Fig. 22. From this stage to the formation of the spores has been followed very carefully, in view of conflicting statements in other genera as to whether or not the mother-cell becomes chambered, and the stages obtained here suggest a possible explanation of those statements. In *Tetraclinis* no trace whatever of spindle fibres is found between the stages shown in Figs. 22 and 23 respectively, but the cytoplasm cleaves into four equal parts, leaving between them a trace of residual cytoplasm. This residual cytoplasm is not always seen, but would probably be very quickly absorbed in the formation of the wall which is now laid down on each of the four microspores.

In *Juniperus*, Norén (37) states that the four spores are formed in an unpartitioned mother-cell, but does not mention seeing any residual protoplasm. Nichols (36), working on the same genus, maintains that the mother-cell becomes partitioned, as in *Pinus*, though the partition walls are not easy to demonstrate satisfactorily. It appears possible that what was seen by Nichols was the residual protoplasm. In preparations showing less contraction from the mother-cell wall than that seen in Fig. 23, it would be quite possible to interpret the appearance as due to very faintly staining partition walls, but if these were really walls one would certainly expect the cytoplasm to contract away from them, which is obviously not the case here. It is perhaps worth stating that although the phenomena just described can be successfully demonstrated in a good triple-stained Canada-balsam mount, yet they can be seen much more readily after the violet and

before the orange, with the sections mounted in *water*. Under these conditions what can otherwise only be seen with difficulty becomes entirely obvious. I have on several occasions (in fact each time cones have been fixed for stages of microsporogenesis) teased out fresh material in acetic methyl green; in this way it can be most clearly shown that the spores lie freely inside the thin wall of the mother-cell. Fig. 24 is drawn from such fresh material (to a smaller scale than the other figures). I think there can be no doubt whatever that in *Tetraclinis* the mother-cell does not at any time become partitioned.

It may be of interest to review the situation in other Gymnosperms in regard to this point. In the Cycads investigated (Juranyi (22), Treub (56), and Smith (50)), and in *Ginkgo* (Sprecher (51)), the mother-cell is chambered, the partition walls being thick and persistent. In regard to *Ginkgo* Sprecher remarks: 'Chaque cellule fille ou grain de pollen (microspore) aura sa propre membrane, puisque si on écrase un tétrasporange, les microspores s'en échappent et laissent la membrane de la cellule mère (Fig. 182, *g* et *h*).' The figures to which he refers show the partitioned mother-cell with thick walls, very similar to those of Cycads.

In *Pinus*, according to Miss Ferguson (17), the mother-cell is partitioned in a somewhat similar manner. In *Araucaria*, Burlingame (5) leads one to suppose that the cell is not partitioned, but neither his description nor his figures are explicit on this point. In *Thuja*, Land's (24) figures imply an unpartitioned mother-cell, as is also claimed for *Juniperus*, as mentioned above, by Norén (37), with whose results Nichols (36) is not in agreement. In *Cunninghamia*, Miyake (32) reports a chambered mother-cell, but his account appears to suggest a slightly different type to that found in other genera. In *Torreya*, Robertson's (42) figures imply an absence of chambering. The writer has examined three other genera of Conifers in regard to this point, of which two, *Actinostrobus* (47) and *Cupressus*, showed the spores free in the mother-cell, while the third, *Callitris*, showed thick partition walls, more like those figured in *Gnetum africanum* (see below) than the figures of any other genus of Conifers.

In the Gnetales, *Ephedra* (Land (25)) and *Welwitschia* (Pearson (39)) are not chambered, while *Gnetum africanum* and *G. scandens* (Pearson (41)) show thick partition walls, probably of a mucilaginous nature, though in other species of the genus the mother-cells are said not to be chambered.

It is obvious that if all, or even the large majority, of these observations are accepted as correct, then the character is one which cannot, on any scheme of Gymnosperm classification, be of any phylogenetic importance.

Shortly after the formation of the microspores, the mother-cell wall degenerates and disappears entirely, and the wall of the young microspore begins to thicken. Very soon two layers can be recognized in the wall

(Fig. 25), of which the outer (exospore) possesses some small and inconspicuous projections. This point is of some interest in comparison with the megaspore membrane, as described below.

A nearly mature pollen-grain is shown in Fig. 26. The nucleus always occupies a position to one side of the spore (that next the periphery of the old mother-cell wall) and is always surrounded by a single layer of large and conspicuous starch grains.

No further nuclear change takes place till after pollination, the pollen-grain being uninucleate when first seen on the nucellus, as in *Juniperus*, *Cupressus*, and *Taxus* (Coker (10), Nichols (36)), and the Callitroideae (Saxton (44-47)). When the ripe fresh pollen is mounted in water and at once examined, it is seen that the wall is comparatively thin, but after a few minutes the exospore usually bursts, owing to the considerable swelling which takes place in the endospore, the latter becoming very much thicker than it was before. It was found that fixing agents had somewhat the same effect on the wall, though to a less extent. Thus an examination of fixed material alone leads to erroneous ideas of the thickness of the wall: the very thick wall described by the writer in *Widdringtonia* and *Callitris* was undoubtedly caused partly in this way, though a comparison with similarly fixed material of *Tetraclinis* indicates that the wall is somewhat thicker in the former genera, which would probably imply its greater thickness in an unswollen condition also.

Some points may here be discussed in connexion with the meiotic divisions. One difficulty, which commonly occurs in the investigation of microsporogenesis, was almost absent in the present case, namely, the *sequence* of the different stages. There were here three separate characters, which, taken together, made it clear which of any two stages preceded the other, at least in the earlier phases, in which alone difficulties of this sort arise. (i) The position in the cone. In *Tetraclinis* the youngest sporangia are found always at the *apex* of the cone, successively older ones appearing below until about the last whorl of sporophylls (or sometimes the last two whorls), which bear somewhat younger sporangia than those immediately above them, but still older than those at the apex. In *Juniperus*, according to Nichols (36), the sporangia at the apex are *more* developed than those at the base, contrary to the condition in *Tetraclinis*. Within a single sporangium some variation occurs, so that the development from the apex to near the base of the cone is not always reliable, without supplementary evidence, in fixing the sequence, though it does make it possible to distinguish, e. g., stages immediately preceding synapsis from those immediately following it. (ii) The degree of separation of the mother-cells. In the stage shown in Fig. 1 the spore mother-cells form a compact tissue; shortly after this they begin to show signs of separation, the actual separation and rounding out being completed during synapsis.

This provides a reliable means of distinguishing nuclei just beginning to contract from those recovering from synapsis, and makes it impossible to confuse pre-synaptic with post-synaptic phases. (iii) In addition to the two points noted above there is a progressive increase in starch content throughout the prophases of the heterotypic division. In the figures no attempt has been made to show with absolute accuracy the position of every starch grain in the section figured, but a few grains have been accurately drawn in with the camera lucida in each case, and, the distribution being very uniform, the rest added free-hand.

Careful search was made, both before and after synapsis, for any indication of such a 'pairing of the spiremes' as is claimed by Overton (38) for various Angiosperms, and by Nichols (36) for *Funiperus*, but no trace of such a thing was seen. Nor was any distinct evidence forthcoming for the longitudinal splitting of the post-synaptic spireme which appears certainly to occur in many plants, especially Monocotyledons (Farmer and Moore (16), Mottier (33, 34), &c.), and has been described by Lewis (29) in *Pinus* and *Thuja*. Miss Ferguson (17) gives a somewhat different explanation of the phenomena in *Pinus*, maintaining that the splitting, which she also describes in the spireme stage, culminates in the longitudinal splitting of the chromosomes in the first (heterotype) division; the other authors quoted believe that it does not reappear until the splitting of the chromosomes which they describe in the second (homotype) division.

Repeated search was made in *Tetraclinis* for any signs of transient splitting in the prophases of the heterotype division, and the only stage which could possibly be interpreted as such was that shown in Fig. 8, while even here it seems far more likely that the appearance is caused by the close approximation of the sides of a number of loops.

There does not seem to be any especial reason why splitting should occur at this time, only to disappear again later, and to the writer it seems reasonable to suppose that the differences reported in this respect may be due to real differences between one plant and another, and not, as is often thought, to differences in methods of investigation.

Repeated counts of chromosomes, chiefly in polar views of telophases of the homotype division, gave twelve or thirteen as the  $x$  number of chromosomes. Less conclusive evidence was obtained as to the  $2x$  number, owing to the difficulty of counting the larger number of chromosomes in nuclei as small as those of *Tetraclinis*, but the few counts which were made indicated twenty-four as the probable figure. The case shown in Fig. 13 is difficult to interpret; it is a very clear polar view, showing the ends of the chromosomes passing to the poles at the heterotype division. Thirty-two of these ends can be counted quite clearly; if the chromosomes are all V-shaped this would correspond to sixteen whole chromosomes; comparison with Fig. 11, however, suggests a quite possible explanation,

namely, that some are straight and some bent into a V-shape. If we assume, as would appear to be the case, that the chromosomes have split after passing away from the equator, as in many other plants, then the twenty-four would be accounted for if sixteen of them were straight and the other eight V-shaped. I can suggest no other explanation which appears in any way satisfactory, and which is at the same time not contrary to all accepted views in regard to chromosome numbers as seen during the meiotic phase.

Nichols (36) maintains that after synapsis there are no parts of the spireme which meet and fuse, that is, no anastomosing; the spireme is one continuous thread. Norén, on the contrary, considers that anastomoses do occur, as is also said to be the case in *Pinus* (Ferguson (17)). In *Tetraclinis* there is no doubt whatever that anastomoses do occur in the post-synaptic spireme. They are most clearly seen where only a small part of the nucleus is cut off in a section; in thicker sections it is difficult to distinguish clearly between a real branching (anastomosing) of the thread, and the case where one part of the thread crosses just below or above another part. At the same time it is evident that there is much less anastomosing after synapsis than there was before.

The only other point worthy of special mention is the complete absence of any trace of fibres prior to the cleavage of the contents of the mother-cell into spores. In *Juniperus*, Nichols (36) gives a figure showing more conspicuous fibres at this time than at any other stage of the meiotic divisions, and they have been described and figured in most other cases where this phase has been investigated. As their absence here appears a distinctly unusual feature, it may be worth mentioning that the regular arrangement of the starch grains almost entirely precludes the possibility of such fibres being present, even on the supposition that the methods of fixing and staining were not sufficiently good to demonstrate them visibly in any one of the numerous preparations showing this stage; as a matter of fact the fixing and staining appeared entirely satisfactory in many cases. A comparison of Fig. 17 with Figs. 22 and 23 will explain what is meant in regard to the starch grains. In Fig. 17 these are arranged in rather definite rows, and are somewhat elongated in the direction of the fibres, as though compressed by the latter, while nothing of the kind is visible in any of the hundreds of cells examined in stages similar to Figs. 22 and 23.

#### THE MALE GAMETOPHYTE.

When pollination takes place the grains usually lodge on the edge of the crater-like apex of the nucellus, and the tube grows into the central collapsed area, and then turns downwards. The earliest stage seen after

the pollen-tube has begun to penetrate the apex of the nucellus (Fig. 27) shows the tube nucleus and the generative cell still enclosed in the spore cavity, the generative cell being still attached to the spore wall. A somewhat later stage (Fig. 28) shows the tube nucleus some way down the tube, and the generative cell lying free in the spore cavity. Shortly after, the upper part of the tube is found to be empty, while three nuclei, embedded in a common mass of cytoplasm, are found close to its tip. The sterile nuclei (tube and stalk nuclei) are exactly alike, and lie, as usual, side by side, and in advance of the body nucleus (Fig. 29). The body nucleus gradually increases in size, and a part of the cytoplasm soon becomes differentiated around it to form a definite body-cell (Fig. 30). Finally, the body-cell divides to form two hemispherical male cells. Whether these were enclosed in a mother-cell wall could not be determined. Some aspects of the mature pollen-tube are shown in Pl. XLV, Figs. 41, 42, and Pl. XLVI, Fig. 64. It is worth noting that the two male cells may be placed either side by side or one vertically above the other (Figs. 41 and 64), the former being the usual arrangement in the Cupressoidae. There is some evidence that the male cells do not always become spherical when mature, as they usually do in Cupressoidae; at any rate a male cell which is still hemispherical has been seen inside an archegonium, and no case has been seen where it could be stated with any certainty that the male cells were spherical in the pollen-tube.<sup>1</sup>

#### THE MEGASPORANGIATE STROBILUS AND THE FEMALE GAMETOPHYTE.

The young female cones of *Tetraclinis* are very similar to those of *Widdringtonia*, especially *W. juniperoides*, as shown in Text-fig. 1. They are borne singly on very short lateral branches, and each consists of two pairs of widely spreading cone scales. In the centre of the cone are seen six (rarely four or eight) erect ovules, with rather long tubular micropyles. The insertion of one pair of scales is slightly below that of the other, and the scales of the upper pair are usually sterile, all the ovules being attached to the two lower scales; when, however, eight ovules are present, two of them are inserted on the upper pair.

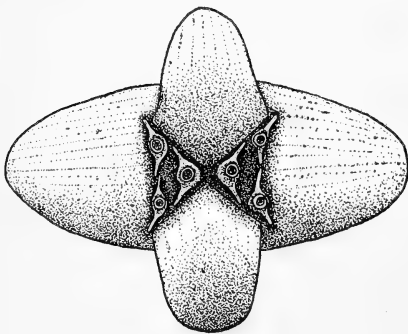

TEXT-FIG. 1.—Drawing of a young cone of *Tetraclinis* as seen from above.  $\times 15$ .  
April 24.

A median longitudinal section of

<sup>1</sup> Some cases of male cells circular in section have been seen, where the two were cut successively in serial sections, but such an appearance is also characteristic of hemispherical cells, when cut more or less parallel to the flat side.



the ovule when nearly ready for pollination (Figs. 31 and 59) bears a considerable resemblance to that of other Cupressoideae. There is a long and widely open micropyle, of which the inner cells are quite distinct from the rest as the micropyle closing cells. At the apex of the nucellus a few cells have begun to collapse, a phenomenon which becomes more noticeable after pollination, and which apparently facilitates the penetration of the pollen-tube. According to Tison (55), however, the destruction of the apical cells is primarily brought about in the formation of the 'pollination drop'. He remarks: 'Cette production de la gouttelette est accompagnée de la destruction des cellules nucellaires productrices'; this, it may be pointed out, is not the case in the Callitroideae, where the 'gouttelettes' have been seen in *Actinostrobus* and *Widdringtonia* (Saxton (47)), since in that sub-family the cells at the apex of the nucellus remain intact (except where broken down by an advancing pollen-tube). This would appear to constitute another distinction, though probably not one of any great importance, between Callitroideae and Cupressoideae; the observations relative to this point in the Cupressoideae (Tison (55), Miyake (32), Nichols (36)) suggest a probability that the formation of a saucer-shaped depression at the apex of the nucellus will be found to be characteristic of all the genera.

At the base of the nucellus is a group of sporogenous cells (shown on a larger scale in Fig. 32), of which about eight to twelve may be seen in median section (either longitudinal or transverse). At this time there is not a very sharp boundary line between sporogenous and non-sporogenous tissue, but at a somewhat later stage the differentiation is more marked (see Fig. 36). The cells of this sporogenous tissue are those figured as such by Goebel (18), and it is quite clear that one of their number is the functional megaspore mother-cell, while the remainder are also morphologically spore mother-cells, which function as a tapetum (spongy tissue).

Fig. 33 shows the apex of the nucellus, in an average ovule, at about the time of pollination. The apical depression is evidently formed by the breaking down of certain cells, and is similar to, but perhaps a trifle deeper than, that usually found in Cupressoideae. Fig. 34 shows in outline the apex of another nucellus with a very similar depression, and, above, the micropyle completely closed by the ingrowth of the innermost cells of the integument in that region. Thus a sub-spherical and completely enclosed cavity is formed in which conditions are doubtless very suitable for the germination of the pollen-grain. A transverse section of the closed micropyle is shown in Fig. 35.

For a short time before dividing the functional mother-cell becomes distinguishable from its neighbours, as shown in Fig. 36, by the greater size of both cell and nucleus. A few starch grains can also be seen in the rather

scanty cytoplasm of the cell. At a slightly later stage a single functional megaspore is found (Fig. 37) lying just below two deeply staining and abortive nuclei. These three have evidently been derived from the mother-cell. The microphotograph (Fig. 60) shows one of the two sections from which Fig. 37 was drawn. The second abortive nucleus appears in the next section. It will be noticed that the megaspore nuclei are much smaller than those of the surrounding tapetal cells. No stages between Figs. 36 and 37 were secured; they would not be likely to show any marked divergences from the sequence of megasporogenesis as described by Norén (37) and Nichols (36) for *Juniperus*, by Knischewsky (23) for *Thuja*, by Coker (9) for *Taxodium*, and by Miyake (32) for *Cunninghamia*. Lawson (26 and 27) seems to have obtained only scattered stages in *Cryptomeria* and *Libocedrus*, and it is not clear in either case from his figures that the cells named megaspores are really such. It seems just as likely that they may represent a group of megaspore mother-cells similar to that figured in other Cupressoidae.

If Lawson's explanation of his figures is correct, it is clear that *Cryptomeria* and *Libocedrus* differ widely from all other investigated Cupressoidae in this respect; since, however, the figures as published would bear another interpretation, namely, that the earlier stage was archesporium and the later one a group of megaspore mother-cells precisely similar to that found in the other genera, which agree very closely with one another, one is tempted to believe that Lawson has fallen into the error of mistaking mother-cells for spores. A re-examination of *Libocedrus* and *Cryptomeria* is certainly desirable in order to settle this point.

The free nuclear divisions in the young prothallus are at first simultaneous (Fig. 38 shows one of the thirty-two dividing nuclei met with at the sixth mitosis), but whether these strictly simultaneous divisions occur later has not been determined.

Late stages of the hollow embryo-sac, shortly before the commencement of cell-formation, reveal an important difference between *Tetraclinis* and the Callitroideae; in the latter the prothallus is narrow and pointed at the apex, and the pollen-tube more or less overlaps its tip some time before cell-formation begins; in *Tetraclinis*, on the other hand, the apex of the young prothallus is quite truncate, just as in *Thuja* (Land (24)) and other Cupressoidae, while the pollen-tube has not penetrated more than half-way from the apex of the nucellus to the apex of the prothallus.

A number of preparations have been obtained showing the formation of alveoli in various stages and the subsequent formation of closed cells. The first alveoli are seen growing in from the sides of the prothallus, while scarcely any trace of them can be seen growing down from the truncate apex (Pl. XLVI, Fig. 61). From a comparison with later stages it seems fairly certain that the alveoli, usually about nine or ten in number, destined to form

archegonium initials, lag very slightly behind the others. The result of this is that the central apical alveoli, instead of growing in simultaneously with those immediately surrounding them, grow down on to their walls. In this way the apical archegonium initials are from the first distinct from all the other alveoli (Figs. 39 and 62). Land's (24) figure of archegonium initials in *Thuja* rather suggests that a similar lagging of the alveoli which will form archegonium initials may take place in that genus (and, doubtless, in other Cupressoidae). In contrast with the Callitroideae, the alveoli remain unsegmented until they almost meet in the central axis of the prothallus, and then (except the archegonium initials) divide up more or less evenly into several cells; in the Callitroideae a small tabular cell is cut off from the base of each primary cell before it extends more than about half-way inwards. In *Libocedrus*, Lawson (27) describes the alveoli as forming several transverse divisions while they grow inwards, but this does not occur in *Tetraclinis*; it is likely that there may be differences in this respect between closely related plants, as shown by Arnoldi (1 and 2) in the two species of *Sequoia*.

The first division of the archegonium initials occurs soon after the beginning of segmentation of the primary prothallus cells, and results in the formation of the central cell of the archegonium and a primary neck-cell (Fig. 40). The neck-cell soon divides again in a vertical plane, and each daughter-cell again in the other vertical plane, forming a single tier of four cells in the neck. At the same time the central cell rapidly enlarges, while the surrounding prothallus cells go on growing and dividing to keep pace with it. The archegonia (Figs. 41, 42, and 63-5) form an apical complex exactly similar to that met with in other Cupressoidae;<sup>1</sup> the cells immediately surrounding the complex form a fairly well-defined jacket layer, as in *Thuja*, *Funiperus*, and other genera. The nucleus of the central cell at first lies in a small mass of cytoplasm just below the neck. The cytoplasm also extends as a thin parietal layer round the inside of the wall, but the whole of the central part of the archegonium is occupied by one large vacuole (Fig. 63). As the archegonium matures, a small mass of protoplasm is also seen at the base of the archegonium, and this gradually enlarges so that the vacuole is completely obliterated before the archegonium is ready for fertilization (Figs. 41, 64).

The number of neck-cells also increases during the development of the archegonium, there being finally two tiers of neck-cells, sometimes with more than four cells in a tier. The arrangement varies somewhat, but the commonest type of neck appears to consist of two tiers of four cells each. (See Figs. 41, 42, 45, and 46.)

<sup>1</sup> *Cunninghamia* (Miyake (32)) has a somewhat different arrangement of the archegonia, with a patch of sterile cells in the centre of the complex.

Shortly before the ventral canal nucleus is cut off, the bodies appear which are referred to by Nichols (36) in *Juniperus* as asteroids, and by Norén (37) in the same genus as 'Strahlungscentren'. These structures bear some resemblance to blepharoplasts, and it is not without interest to find such bodies occurring just prior to the division which gives rise to the egg in Conifers, although no trace of a blepharoplast has ever been demonstrated in the division to form male cells in any Conifer. The asteroids seem of general occurrence amongst Cupressoideae, having been reported by Land (24) in *Thuja* and by Coker (9) in *Taxodium*, as well as in *Juniperus*, as mentioned above. They were seen by Norén (37) in *Tetraclinis* also. In archegonia which are not fertilized the asteroids become both more conspicuous and more numerous, but they have not been noticed after fertilization has been effected. They may be seen in some of the archegonia of Fig. 65.

The last change in the archegonium before fertilization is the cutting off of a ventral canal nucleus (Figs. 43 and 44). The fate of this nucleus seems to vary; in some cases no trace of it can be found at a somewhat later stage, while in others it may easily be seen associated with proembryos of various ages.

The number of archegonia in a prothallus is usually nine or ten in my material (Fig. 65), but higher numbers are sometimes met with; Strasburger (52) gives the number as fifteen or more, so that the number probably varies somewhat widely. Since my material was all collected from a single tree, it is not improbable that the number of archegonia in a prothallus may have been below the average.

One of the most interesting features of the female gametophyte is the somewhat rare occurrence of lateral groups of archegonia. These are mentioned by Juel (21) and Norén (37) as an occasional abnormality in the genus. In a literal sense it is certain that such lateral groups are abnormal for this plant, but in the sense in which 'abnormal' is generally used, as indicating something of the nature of a freak, it does not seem clear that a phenomenon which is thus known to occur with some regularity in a proportion (though only a small proportion) of cases should be looked upon as entirely 'abnormal'—at least, it must be regarded as a factor which cannot be overlooked in considering the phylogenetic relationships of the plant in which it occurs. Of those prothalli sectioned by me, about 130 were of an age sufficient to show the archegonia; of these, three (from separate cones collected on three different dates) had lateral archegonia. Of these three, one (Text-fig. 2) shows a perfectly normal group of archegonia at the apex, and, in addition, a similar group of ten archegonia placed laterally a short distance below the apex. The second (Text-fig. 3) has no archegonia at, or anywhere near, the apex. There are two lateral groups, one about half-way down the prothallus, consisting of six archegonia, and another about two-

thirds of the way down, which was unfortunately cut through when the prothallus was fixed, so that the number of archegonia cannot be counted; two, at least, can be clearly seen, and in the sketch the group has been hypothetically restored. The third preparation (Text-fig. 4) resembles the

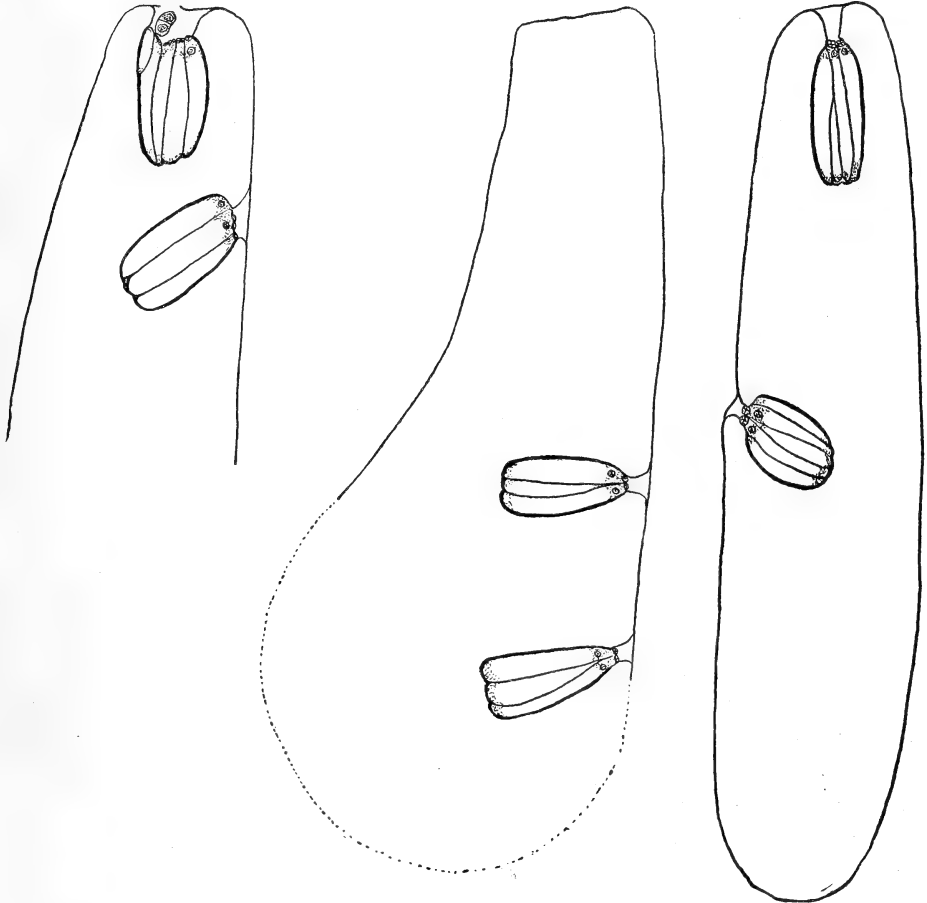

TEXT-FIG. 2.—Median longitudinal section of apical part of a prothallus of *Tetraclinis*, containing both apical and lateral groups of archegonia.  $\times 35$ . Sept. 2.

TEXT-FIGS. 3 AND 4.—Median longitudinal sections of two prothalli of *Tetraclinis*, containing lateral groups of archegonia. Both  $\times 35$ . Fig. 3, Sept. 23. Fig. 4, Oct. 3.

first in having one apical and one lateral group of archegonia, but in this case the lateral group lies about half-way down the prothallus.

It is noteworthy that each prothallus which shows lateral archegonia is very healthy and well developed. In each case pollen-tubes are developing quite normally through the nucellus, and the archegonia themselves appear normal in other respects, and healthy. There is not the slightest indication

in any of the three that failure to develop in the usual way is due to injury. As mentioned above, the suggestion has been made that cultural conditions are responsible for this peculiarity, but the tree from which my collections were made was growing in the open in a climate not very dissimilar to that of its native land, and such a suggestion does not seem adequate in this case.

It is also interesting that where no apical archegonia occur, the apex of the prothallus remains truncate, and never becomes pointed as it does in the Callitroideae.

Several prothalli were also sectioned which contained no archegonia at all, though otherwise they appeared perfectly healthy. Juel (21) also mentions the entire absence of archegonia in some of the material examined by him. In *Widdringtonia* sterile prothalli are also fairly common, and they have been found occasionally in other genera. It is not unlikely that this fact may be of some significance as indicating a certain degree of instability in the development of the gametophyte.

The archegonia of *Tetraclinis*, whether apical or lateral, are never deep-seated in the sense of being derived from cells which are not superficial, but, as in related genera, become rather deeply sunk through the upgrowth of the surrounding tissue. This surrounding tissue impinges on the pollen-tube or tubes, and after fertilization, when the tubes break down, or at a corresponding time if no pollen-tube is present, the overarching cells meet over the archegonial complex. It seems certain that there can be no direct phylogenetic connexion between archegonia thus cut off from the exterior of the prothallus and those which are deep-seated from the first, any more than between a gymnospermous cone in which the scales meet and enclose the ovules and an angiospermous ovary which is enclosed *ab initio*. Nevertheless it would be very difficult, if late stages only were available, to distinguish between the two, and it seems probable to the writer that certain cases where deep-seated archegonia have been reported on rather inadequate evidence might be explained in this way.

The dates given in the description of figures, corresponding to the dates of collection of different stages, do not suffice to fix the time which elapses between pollination and fertilization. Pollination occurred in the oldest ovules seen about April 20, but the majority were certainly pollinated later, probably up to June 1 or a little after. At each collection the largest and oldest cones available were gathered, so that those ovules in which post-fertilization stages were first found (on September 2) were not pollinated at the same time as those of the earlier collections, but probably about a month later. Consequently the actual time which elapses between pollination and fertilization is from 3 to 3½ months.

## FERTILIZATION AND DEVELOPMENT OF THE PROEMBRYO.

As in other Cupressoidae, it is customary for both the male cells to be functional, passing into and fertilizing two adjacent archegonia. One case has been seen, however, where all four nuclei were discharged from the pollen-tube into a single archegonium; a very similar case is figured by Knischewsky (23, Fig. 45) in *Thuja*.

Post-fertilization stages are readily recognized by the starch sheath which invariably surrounds the fusing nuclei. Although no very conclusive evidence of the origin of the sheath was obtained in the present case, there can be little doubt that it is simply the cytoplasm of the male cell. It is curious, however, that starch is not noticeable in the mature, or nearly mature, male cell, while it is always a conspicuous feature of the sheath. The same peculiarity was remarked by Strasburger (53) in *Funiperus*, but Nichols (36) succeeded in demonstrating the starch in the male cells of this genus, and it has also been seen by Coker (9) in *Taxodium*; it seems, therefore, very probable that starch is commonly present in the cytoplasm of the male cells, but in rather an obscure form in some cases, becoming much more conspicuous after fertilization.

Fig. 47 shows the conjugation of the male and female nuclei. This case is typical of four out of five similar stages seen. The male nucleus is considerably smaller than the female, and in the latter the nuclear contents are somewhat more scanty than in the former. A large reticulate nucleolus is seen in the female nucleus. Fig. 48 shows an exceptional case where the male nucleus is below the female. It is quite clear, both from the structure and the relative size, that the lower nucleus is the male, and it may be mentioned that the actual difference in size is greater than is apparent from the section, since the female nucleus extends considerably further than the male in the sections both above and below that figured. I should doubt whether the volume of the male nucleus is ever more than one-third of that of the female. Fig. 49 shows one of two cases seen where fusion is quite complete, no trace whatever remaining of the line of junction of the two nuclei. The structure, however, is simply that of a resting nucleus, so that here fusion is entirely complete before any preparations are made for the first sporophyte division. In *Pinus* (Blackman (4), Chamberlain (6), Ferguson (17)) preparation is made for this division by both nuclei before the membrane between them breaks down, and no mingling of the nuclear contents takes place until after chromosomes are organized, and although no other genus has been investigated so completely, it appears probable that the same is true for other Pinaceae. The records for other families are so scanty that it is not possible to generalize; in *Funiperus*, however, both Norén (37) and Nichols (36) record complete fusion of the two nuclei in the resting stage.

In *Pinus* the two groups of chromosomes remain distinct during the formation of the spindle, a phenomenon also occurring in *Larix* (Woycicki, as quoted by Coulter and Chamberlain (12)), *Tsuga* (Murrill (35)), *Juniperus* (Noren (37), Nichols (36)), and *Cunninghamia* (Miyake (32)), and doubtless true for most, if not all, other Conifers. In *Tetraclinis* two distinct groups of chromosomes are formed, which can be made out quite plainly at the time when spindle fibres begin to appear.

Figs. 50 and 51 are drawn from two adjacent sections of the same series. The sections did not pass medianly through both groups of chromosomes in the same section, but Fig. 50 is the one which includes the point of junction of the two groups. Fig. 51 has passed through practically the centre of the male group, while only outlying parts of three or four female chromosomes are shown. The next section on the other side shows female chromosomes almost solely, a few fragments only of the male being visible above. In all three sections, also, the spindles are distinct as well as the chromosomes.

*Juniperus* is the only other genus of plants where such a segregation of chromosomes has been clearly proved to follow complete fusion of the male and female nuclei—complete, that is, as far as revealed by the highest powers of the microscope—and these two cases, which are probably duplicated in other Cupressoïdeae, appear to the writer to constitute the most important cytological evidence we at present possess in plants in regard to the continued individuality of male and female chromosomes. To these should be added Miss Ferguson's (17) demonstration of segregation in *Pinus* at the *second* division in the proembryo, a record which has not been repeated for any other genus of plants, but which is duplicated in the cleavage of the fertilized egg of *Cyclops* (Rückert (43)) amongst animals.

A rough count of the chromosomes in these sections indicated a considerably higher number than was expected, but this was proved to be due to the length and very irregular shape of the chromosomes, so that not only does one chromosome certainly appear in more than one section in some cases, but almost certainly two separate parts of the same chromosome may appear in the same section. As it is quite impossible to trace out the whole length of each individual chromosome, it was assumed that the longest whole thread of chromatin which could be demonstrated was a whole chromosome, an assumption which may be considered reasonably probable; this was carefully drawn and measured, making some allowance for the change of focus required to bring successive parts of the thread into view; each piece of thread appearing in the same half (female) of the three sections was drawn and measured in a similar manner, and the total length of thread obtained in this way was divided by the length of one chromosome. The probable error in such an estimate might be taken at about 10 per cent., and the fact that the actual figure obtained was almost exactly 12 makes



it practically certain that no splitting of the chromosomes had occurred at this time.

In the next figure (Fig. 52) the chromosomes have become arranged at the equator of a multipolar spindle, but apparently no splitting has as yet taken place. Fig. 53 shows the daughter chromosomes approaching the poles of the spindle.

It may be noted that each of these three stages (Figs. 50-3) is found near the centre of the archegonium, a position which appears to be normal for Cupressoideae, having been observed by Lawson (26) in *Cryptomeria* and by Miyake (32) in *Cunninghamia*. In *Thuja*, according to Land (24), the division takes place below the centre, but not quite at the base. In *Taxodium*, however, Coker (9) reports that the fusion nucleus passes to the base of the egg before dividing.

Figs. 54 and 66, which represent the next stage seen in *Tetraclinis*, show the two daughter nuclei one above the other at the base of the egg, evidently shortly after division is completed. Whether the daughter nuclei pass down before or after the completion of the first mitosis cannot be stated. The next division results in the formation of a tetrad of free nuclei (Figs. 55, 56, and 67), the tetrad being oriented, in different cases, in every conceivable manner; it seems likely that the variation met with at this time may explain the still greater variation met with in the proembryo after walls have appeared.

Figs. 56, 66, and 67 show how small a proportion of the egg is occupied by the young proembryo, and Fig. 56 also shows the ventral canal nucleus. It may be mentioned that in *Tetraclinis* the ventral canal nucleus has never been seen to divide after fertilization has occurred, contrary to the case of *Thuja* (Land (24)) and *Juniperus* (Nichols (36)), where division quite often occurs. The next stage seen shows a proembryo, in which walls have been formed, containing eight cells; it seems probable that the walls appear, as is usual, in the transition from the 4-nucleate to the 8-nucleate stage, though a different method of wall formation has been described in *Thuja* (Land (24)). No detailed drawings have been made of these later stages of the proembryo. That no simultaneous divisions occur after wall formation may be inferred from the fact that counts of the cells (including the upper tier of free nuclei, where such was present, which was usually not the case) in serial sections of fourteen walled proembryos (before they extend into the prothallus below the base of the archegonium) gave the following numbers of cells: 8, 9 (two examples), 10, 11, 12 (two examples), 13, 15, 16 (two examples), 17, 18 (two examples). Five of the least irregular of these have been used as the basis of Diagrams 1 to 5 in Text-fig. 5. These, however, are in each case slightly more regular than the originals, though the general arrangement of tiers appears to be essentially accurate. The number of cells (or nuclei) in each tier is indicated on the

left of each diagram, and the total number below these. The ventral nucleus is also indicated in Diagram 5. It may be noted that it is usual, but not invariable, for the lowest tier to consist of only a single cell.

Only scattered stages were examined beyond this, the chief point of interest being that two or three tiers of cells contribute to the suspensor. This has been found to be the case also in *Thuja* (Land (24)) and *Torreya* (Coulter and Land (11)), and is said (Coulter and Chamberlain (12)) to be usual amongst 'Taxaceae' (Taxads and Podocarps).

As recorded by Hansen (19), the number of cotyledons in the embryo ranges from three to six. Text-fig. 6 shows a transverse section of an embryo with three cotyledons, while Text-fig. 7 is from a drawing of an embryo with five. The only other embryo dissected had four cotyledons. It may be worth

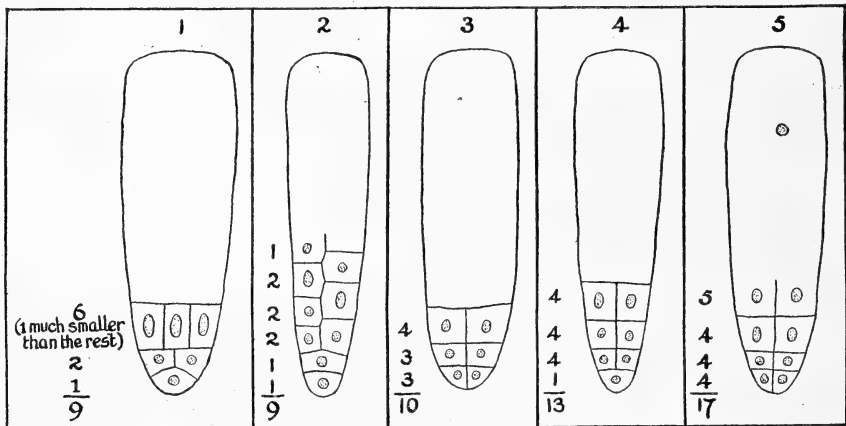

TEXT-FIG. 5.—Series of diagrams to illustrate some of the arrangements of cells met with in walled proembryos of *Tetraclinis*.

noting that two to five cotyledons are found in *Juniperus* (Coulter and Chamberlain (12)), while among Callitroideae, *Widdringtonia* occasionally has three, but usually agrees with the other two genera, which invariably possess only two.<sup>1</sup>

There is one peculiarity in the mature seed which has apparently not been recorded before, namely, that the testa is soft, thin, and membranous. There could be no doubt that the seeds examined were mature. They were collected at the same time as the youngest cones of the succeeding crop, and the cones in which they were found were wide open and had already shed most of their seeds (all, except in a few cases). The embryos of Text-figs. 6 and 7 were dissected out from two of these seeds, and the remainder (about three or four) were planted but did not germinate.

Certain other points, best seen in, or confined to, prothalli containing proembryos may now be discussed.

<sup>1</sup> Lubbock (30) states, incorrectly, that *Actinostrobus pyramidalis* has three cotyledons. No single case has been seen by me, out of a large number of seedlings (certainly more than one hundred), where more than two cotyledons were present.

Appearances, difficult to interpret, seen in the megaspore membrane at this time, led to a very careful examination of that structure. According to Thomson (54) this membrane consists, in the Cupressoideae, of an endospore and exospore, represented in his figures as of approximately equal thickness. The endospore is more or less homogeneous, while the exospore consists of numerous slender radiating rods. He also mentions that material derived from nucellar tissue may increase the apparent thickness of the exospore. As to the last point, the deeply staining deposit on the outside of the exospore does, in many cases, obscure its structure, but here and there parts may be found which are free from it. In order to see the structure clearly it is also necessary not only to select a part which shows no trace of 'dragging' (as Thomson mentions), but also one which is cut almost exactly perpendicular to its own plane, so that a slight change of focus produces no

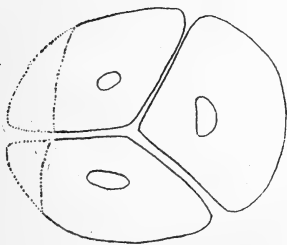

TEXT-FIG. 6. — Transverse section through the cotyledons of a tri-cotyledonous embryo.  $\times 35$ .

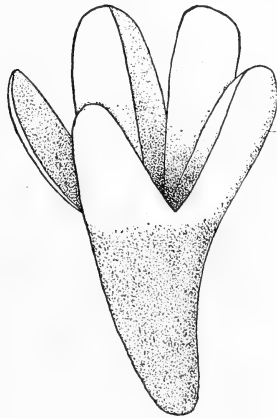

TEXT-FIG. 7.—Sketch of an embryo with five cotyledons.  $\times 16$ .



TEXT-FIG. 8.—A very small part of the megaspore membrane of *Tetraclinis* in longitudinal section. The outer side to the right.  $\times$  circa 3000.

lateral displacement of the image. Having satisfied these conditions, it is possible to distinguish in *Tetraclinis* a very thin homogeneous endospore, which I should estimate at only one-sixth of the total thickness of the membrane, and an exospore which consists of rods thickened in a dumb-bell-like manner at the apex, so that with a lens which does not resolve in an entirely satisfactory manner, the outer layer of the exospore appears continuous, while the inner and thicker layer appears to contain numerous radiating vacuoles. Text-fig. 8 represents a sketch of the structure as seen with a high magnification. It will be seen to be similar to that figured by Chamberlain (7 and 8) for *Dioon* and *Ceratozamia*, except that the terminal swelling of the rods is more abrupt. It would be interesting to know whether a re-examination of other Gymnosperms would show that a similar structure is more widely prevalent. It may be mentioned that a figure of the megaspore membrane of *Juniperus* given by Norén (37) shows a structure quite similar to that seen in *Tetraclinis* when the resolving power of the lens

used is not entirely satisfactory. It differs considerably from Thomson's (54) figures of the membrane in Cupressoideae. The actual thickness of the membrane in *Tetraclinis* is just under  $2\ \mu$ .

In a recent paper the writer (47) has discussed the extent to which multinucleate prothallus cells are found in the Conifers, in connexion with their regular occurrence in the Callitroideae. In *Tetraclinis* such cells occur fairly freely, but frequently show a subsequent fusion of the nuclei within the cell. Such a stage was carefully looked for in the genera of Callitroideae, but was never discovered. Figs. 57 and 58 show various unfused, fusing, and fused nuclei, all drawn from different parts of the same section. There is no difficulty in finding such stages, and it may be taken as certain that such a fusion of nuclei would have been readily found if it did occur in the Callitroideae. This observation explains Juel's (21) remarks as to the great variation in size of the nuclei of the prothallus cells in *Tetraclinis*. It is not easy to see precisely what is the physiological meaning of these nuclear divisions and fusions in the endosperm, but one is tempted to compare them with the situation in the *Welwitschia* endosperm (Pearson (40)). In detail such a comparison reveals obvious and important differences, but yet the same sort of tendency is apparent in both cases, namely, to establish the following sequence: Free nuclear division  $\rightarrow$  nuclear fusion  $\rightarrow$  formation of food material  $\rightarrow$  absorption of food material by developing embryo. The same tendency is seen in the Angiosperms, but whether this justifies a morphological comparison between the endosperm in Gymnosperms and Angiosperms is another question, into the discussion of which it is not proposed to enter.

#### PHYLOGENY.

*Tetraclinis* is evidently quite a typical genus of the Cupressoideae, but nevertheless, there are several points which agree in indicating a high degree of probability that it must have been through some plant closely resembling *Tetraclinis* that the southern sub-family Callitroideae were derived from the essentially northern sub-family Cupressoideae. One of the chief regions of distribution of the Cupressoideae may be said to be Europe and Middle Asia; *Tetraclinis* occurs in Northern Africa (Algeria and Morocco, chiefly), while one species of *Juniperus* (*J. thurifera*) is also found in Algeria, and another species is stated by Drude (13) and Engler (15) to occur in tropical Africa. *Juniperus* appears to be more closely related to *Tetraclinis* than any other genus of Cupressoideae, and it is therefore not surprising to find species of the former geographically associated with the monotypic *Tetraclinis*. The tropical species of *Juniperus* (*J. procera*) and *Widdringtonia Whytei* are both found in the mountains of Central Africa at altitudes of from 5,000 to 10,000 feet, while, passing south, we have successively *Widdringtonia Mahoni*, *W. Schwarzii*, *W. juniperoides*, and

*W. cupressoides*. Among various morphological points indicating a close relationship between *Juniperus* and *Tetraclinis* are the delayed division of the microspore nucleus, the structure of the female cone and ovules, and some other resemblances noted in detail above. It is noteworthy also that occasional development of lateral archegonia, as described in *Tetraclinis*, has also been described and figured by Norén (37) in *Juniperus*, although of a somewhat different type to that met with in *Tetraclinis*.

The early development of the ovule of *Tetraclinis* is very similar to that of *Widdringtonia* (except for the absence of a depression at the apex

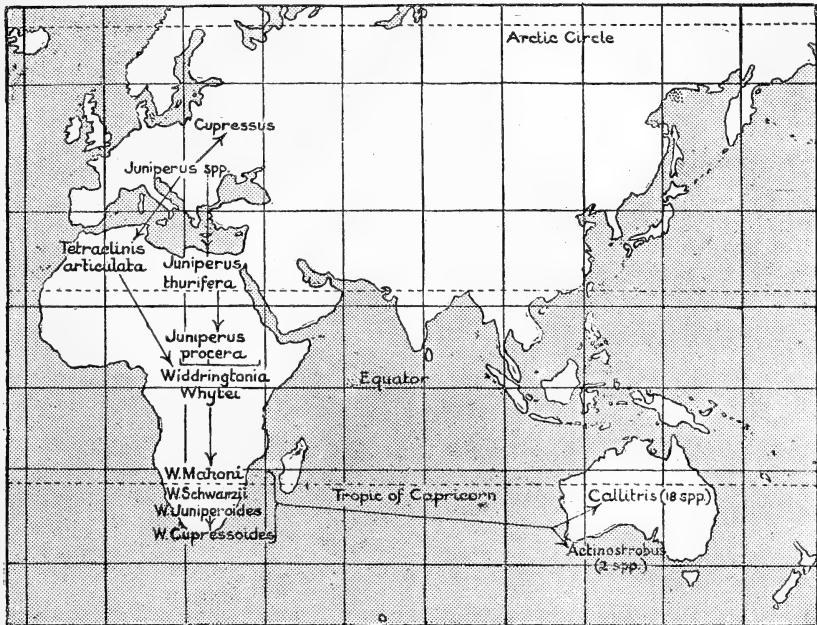

TEXT-FIG. 9.—Part of a map of the world, showing the distribution and suggested phylogeny of the Callitroideae and of certain Cupressoideae.

of the nucellus in the latter), while the development of lateral archegonia in the prothallus has become a fixed character in *Widdringtonia*, no apical archegonia having been ever observed. In *Widdringtonia*, however, the position and extent of the lateral groups is much more variable than in *Callitris* and *Actinostrobus*. It may also be noted that the development of the proembryo, as far as has been seen, while substantially similar in *Widdringtonia*, *Callitris*, and *Actinostrobus*, is less constant in *Widdringtonia* than in the other two genera, and differs somewhat less widely from the Cupressoideae type. The variability of the *Tetraclinis* proembryo has already been pointed out.

Points such as these suggest that the phylogeny of the three genera of the Callitroideae, and of the two genera of Cupressoideae to which they are considered to be most nearly related, is somewhat as shown in Text-fig. 9.

(Since it is considered that in the present case the phylogeny has followed more or less definite geographical lines, the phylogeny and the geographical distribution have been indicated together on a sketch-map.)

The geological and general biological evidence for the former existence of a great antarctic continent, providing a land connexion between Southern Africa and Southern Australia, is very strong; the view that the separation of *Actinostrobus* and *Callitris* from *Widdringtonia* took place during this period would be more or less in agreement with the conclusions reached on general grounds as to the antiquity and relationship of these genera.

#### SUMMARY.

A detailed account is given of microsporogenesis in *Tetraclinis*.

No fusion of two spiresomes occurs at about the time of synapsis.

The mother-cell does not become partitioned during the development of the microspores.

Approximately three months elapse between pollination and fertilization, and development during that time is continuous. From the first appearance of the strobili to the complete ripening of the seeds takes about twelve months.

The mature pollen-grain is uninucleate.

The ovule closely resembles that of other Cupressoideae, and has a single functional megaspore mother-cell, surrounded by tapetal tissue. The possibility is suggested that all the Cupressoideae conform to this type, errors of interpretation accounting for descriptions of a quite different structure in two genera.

The development of both gametophytes is quite like that of other typical Cupressoideae.

The occasional occurrence of lateral archegonia is an interesting feature.

In fertilization the male nucleus is about one-quarter of the size of the female.

Complete fusion of the male and female nuclei occurs while both are in the resting stage.

In the prophases of the first sporophyte division a segregation of the chromosomes into two groups occurs (presumably male and female). This is regarded as important evidence of the continued individuality of male and female chromosomes.

Wall-formation in the proembryo apparently occurs in the transition from the four-nucleate to the eight-nucleate condition.

The mature proembryo is somewhat variable in the number and arrangement of the cells, but is always confined to the lower part of the fertilized archegonium.

More than one tier of cells takes part in the formation of the suspensor.

Three, four, and five cotyledons were found respectively in the three mature embryos examined.

The  $x$  and  $2x$  numbers of chromosomes are 12 and 24 respectively.

Arguments are brought forward to show that the Callitroideae were derived from the Cupressoideae through some plant closely resembling *Tetraclinis*. The general trend of evolution is considered to have followed a line from Northern to Southern Africa, and thence, by means of a former antarctic land connexion, to Australia. Thus *Widdringtonia* is the most primitive of the Callitroideae, and differs least from the Cupressoideae, while *Callitris* and *Actinostrobus* are more specialized.

This investigation was begun in the Botanical Laboratory of the South African College, Cape Town, and completed at the Botany School, Cambridge. My thanks are due to Professor Seward for placing a room and research facilities at my disposal, as well as for the interest he has taken in the progress of the work, and for advice and criticism on certain points. I am also glad to acknowledge criticism on some cytological points from Mr. R. P. Gregory.

May, 1913.

NOTE.—The nomenclature adopted for the families and sub-families has been altered somewhat from that used in the writer's previous papers on Conifer morphology. The classification adopted is discussed in a recent paper on Conifer classification (Saxton (48)). The alterations in nomenclature have been made in order to conform to the international rules. My thanks are due to Dr. C. E. Moss for assistance in the interpretation of these rules.

---

#### LITERATURE CITED.

1. ARNOLDI, W.: Beiträge zur Morphologie einiger Gymnospermen. I: Die Entwicklung des Endosperms bei *Sequoia sempervirens*. Bull. Soc. Imp. Moscou, vol. xiii (N. S.), 1899 (1900), pp. 329-41, Taf. VII, VIII.
2. ———: Beiträge zur Morphologie einiger Gymnospermen. V: Weitere Untersuchungen der Embryogenie in der Familie der Sequoiaceen. Bull. Soc. Imp. Moscou, vol. xiv (N. S.), 1900, pp. 449-76, Taf. VII, VIII.
3. BAKER, R. T., and SMITH, H. G.: A Research on the Pines of Australia. Sydney, 1910.  
BALL, J. (with HOOKER, J. D.). See HOOKER and BALL.
4. BLACKMAN, V. H.: On the Cytological Features of Fertilization and related Phenomena in *Pinus silvestris*, L. Phil. Trans. Roy. Soc., London, B., vol. cxc, 1898, pp. 395-426, Plates XII-XIV.
5. BURLINGAME, L. L.: The Morphology of *Araucaria brasiliensis*. I: The Staminate Cone and Male Gametophyte. Bot. Gazette, vol. lv, 1913, pp. 97-114, Plates IV, V.
6. CHAMBERLAIN, C. J.: Oogenesis in *Pinus Laricio*. Bot. Gazette, vol. xxvii, 1899, pp. 268-80, Plates IV-VI.

7. CHAMBERLAIN, C. J. : The Ovule and Female Gametophyte of *Dioon*. Bot. Gazette, vol. xlii, 1906, pp. 321-58, Plates XIII-XV.
8. ————— : Morphology of *Ceratozamia*. Bot. Gazette, vol. viii, 1912, pp. 1-19, Plate I.  
————— (with COULTER, J. M.). See COULTER and CHAMBERLAIN.
9. COKER, W. C. : On the Gametophytes and Embryo of *Taxodium*. Bot. Gazette, vol. xxxvi, 1903, pp. 1-27 and 114-40, Plates I-XI.
10. ————— : On the Spores of certain Coniferae. Bot. Gazette, vol. xxxviii, 1904, pp. 206-13.
11. COULTER, J. M., and LAND, W. J. G. : Gametophytes and Embryo of *Torreya taxifolia*. Bot. Gazette, vol. xxxix, 1905, pp. 161-78, Plates A, I-III.
12. ————— and CHAMBERLAIN, C. J. : Morphology of Gymnosperms. Chicago, 1910.
13. DRUDE, O. : Handbuch der Pflanzengeographie. Stuttgart, 1890.
14. EICHLER, A. W. : Coniferae. In Engler, A., and Prantl, K. : Die natürlichen Pflanzenfamilien, Teil ii, Leipzig, 1889.
15. ENGLER, A. : Die Pflanzenwelt Afrikas. Band ii, Leipzig, 1908.
16. FARMER, J. B., and MOORE, J. E. S. : On the Meiotic Phase (reduction division) in Animals and Plants. Quart. Journ. Mic. Sci., vol. xlviii, 1905, 489-557, Plates XXXIV-XLI.
17. FERGUSON, M. C. : Contributions to the Life-history of *Pinus*, with special reference to Sporogenesis, the Development of the Gametophytes, and Fertilization. Proc. Wash. Acad. Sci., vol. vi, 1904, pp. 1-102, Plates I-XXIV.
18. GOEBEL, K. : Outlines of Classification and Special Morphology. English translation, 1887.
19. HANSEN, C. : Pinetum Danicum. Journ. Roy. Hort. Soc., vol. xiv, 1892, pp. 257-480.
20. HOOKER, J. D., and BALL, J. : Journal of a Tour in Morocco and the Great Atlas. London, 1878.
21. JUEL, H. O. : Ueber den Pollenschlauch von *Cupressus*. Flora, vol. xciii, 1904, pp. 56-62, Taf. III.
22. JURANYI, L. : Bau und Entwicklung des Pollens bei *Ceratozamia longifolia*, Miq. Jahrb. wiss. Bot., vol. viii, 1872, pp. 382-400, Plates XXXI-XXXIV.
23. KNISCHESKY, O. : Beitrag zur Morphologie von *Thuja occidentalis*, L. Inaugural-Dissertation der Universität Zürich, 1905.
24. LAND, W. J. G. : A Morphological Study of *Thuja*. Bot. Gazette, vol. xxxiv, 1902, pp. 249-59, Plates VI-VIII.
25. ————— : Spermatogenesis and Oogenesis in *Ephedra trifurca*. Bot. Gazette, vol. xxxviii, 1904, pp. 1-18, Plates I-IV.  
————— (with Coulter, G. M.). See COULTER and LAND.
26. LAWSON, A. A. : The Gametophyte, Fertilization, and Embryo of *Cryptomeria japonica*. Ann. Bot., vol. xviii, 1904, pp. 417-44, Plates XXVII-XXX.
27. ————— : The Gametophytes and Embryo of the Cupressineae, with special reference to *Libocedrus decurrens*. Ann. Bot., vol. xxi, 1907, pp. 281-301, Plates XXIV-XXVI.
28. ————— : The Phase of the Nucleus known as Synapsis. Trans. Roy. Soc. Edinburgh, vol. xlvi, 1911, pp. 591-604, Plates I, II.
29. LEWIS, I. M. : The Behaviour of the Chromosomes in *Pinus* and *Thuja*. Ann. Bot., vol. xxii, 1908, pp. 529-56, Plates XXIX, XXX.
30. LUBBOCK, Sir J. : A Contribution to our Knowledge of Seedlings. Vol. ii, London, 1892.
31. MASTERS, M. T. : Notes on the Genera of Taxaceae and Coniferae. Journ. Linn. Soc., vol. xxx, 1893, pp. 1-42.
32. MIYAKE, K. : The Development of the Gametophytes and Embryogeny of *Cunninghamia sinensis*. Beih. Bot. Centrbl., vol. xxvii : i, 1911, pp. 1-25, Plates I-V.  
MOORE, J. E. S. (with FARMER, J. B.). See FARMER and MOORE.
33. MOTTIER, D. M. : The Development of the Heterotypic Chromosomes in Pollen Mother-cells. Ann. Bot., vol. xxi, 1907, pp. 309-47, Plates XXVII, XXVIII.
34. ————— : On the Prophases of the Heterotypic Mitoses in the Embryo-sac Mother-cell of *Lilium*. Ann. Bot., vol. xxiii, 1909, pp. 343-52, Plate XXIII.
35. MURRILL, W. A. : The Development of the Archegonium and Fertilization in the Hemlock Spruce (*Tsuga canadensis*). Ann. Bot., vol. xiv, 1900, pp. 583-607, Plates XXXI, XXXII.



36. NICHOLS, G. E.: A Morphological Study of *Juniperis communis*, var. *depressa*. Beih. Bot. Centralbl., vol. xxv: i, 1910, pp. 201-41, Plates VIII-XVII.
37. NORÉN, C. O.: Zur Entwicklungsgeschichte des *Juniperus communis*. Uppsala Universitets Årsskrift, 1907, pp. 64, Taf. IV.
38. OVERTON, J. B.: On the Organization of the Nuclei in the Pollen Mother-cells of certain Plants, with especial reference to the Permanence of the Chromosomes. Ann. Bot., vol. xxiii, 1909, pp. 19-61, Plates I-III.
39. PEARSON, H. H. W.: Some Observations on *Welwitschia mirabilis*, Hooker, f. Phil. Trans. Roy. Soc. London, B., vol. cxcviii, 1906, pp. 265-304, Plates XVIII-XXII.
40. —————: Further Observations on *Welwitschia*. Phil. Trans. Roy. Soc. London, B., vol. cc, 1909, pp. 331-402, Plates XXII-XXX.
41. —————: On the Microsporangium and Microspore of *Gnetum*, with some notes on the Structure of the Inflorescence. Ann. Bot., vol. xxvi, 1912, pp. 603-20, Plate IX.
42. ROBERTSON, A.: Spore-formation in *Torreya californica*. New Phytologist, vol. iii, 1904, pp. 133-48, Plates III, IV.
43. RÜCKERT, J.: Über das Selbständigbleiben der väterlichen und mütterlichen Kernsubstanz während der ersten Entwicklung des befruchteten *Cyclops*-Eies. Arch. f. mikr. Anat., vol. xlv, 3, 1895, pp. 339-69, Plates XXI, XXII.
44. SAXTON, W. T.: Preliminary Account of the Ovule, Gametophytes, and Embryo of *Widdringtonia cupressoides*. Bot. Gazette, vol. xlviii, 1909, pp. 161-78, Plate XI.
45. —————: Contributions to the Life-history of *Widdringtonia cupressoides*. Bot. Gazette, vol. i, 1910, pp. 31-48, Plates I-III.
46. —————: Contributions to the Life-history of *Callitris*. Ann. Bot., vol. xxiv, 1910, pp. 557-69, Plates XLV, XLVI.
47. —————: Contributions to the Life-history of *Actinostrobus pyramidalis*, Miq. Ann. Bot., vol. xxvii, 1913, pp. 321-45, Plates XXV-XXVIII.
48. —————: The Classification of Conifers. New Phytologist, vol. xii, 1913, pp. 242-62.
- 49 a. SHAW, THOMAS: Travels, or Observations relating to several parts of Barbary and the Levant. 1st ed. Oxford, 1738.
- 49 b. —————: The same. 2nd ed. Oxford, 1757.
50. SMITH, F. G.: Morphology of the Trunk and Development of the Microsporangium of Cycads. Bot. Gazette, vol. xliii, 1907, pp. 187-204, Plate X.  
SMITH, H. G. (with BAKER, R. T.): See BAKER and SMITH.
51. SPRECHER, A.: Le *Ginkgo biloba*, L. Genève, 1907.
52. STRASBURGER, E.: Die Befruchtung bei den Coniferen. Taf. III, Jena, 1869.
53. —————: Neue Untersuchungen über den Befruchtungsvorgang bei den Phanerogamen. Jena, 1884.
54. THOMSON, R. B.: The Megaspore Membrane of the Gymnosperms. Univ. Toronto Biol. Series, No. 4, p. 64, Plate V, 1905.
55. TISON, A.: Remarques sur les gouttelettes collectrices des ovules des Conifères. Mém. Soc. Linn. Normandie, vol. xxiv, 1911, pp. 51-66, Plates III, IV.
56. TREUB, M.: Recherches sur les Cycadées. I: Développement des sacs polliniques du *Zamia uricata*, Willd. Ann. Jard. Bot. Buitenzorg, vol. ii, 1885, pp. 33-41, Plates I-IV.

## EXPLANATION OF FIGURES IN PLATES XLIV-XLVI.

Illustrating Professor Saxton's paper on *Tetraclinis*.

NOTE.—In the Plates all figures of longitudinal sections are oriented with the longer axis of the ovule vertical and the micropylar end upwards.

In all: *a* = archegonium; *b* = body-cell; *c* = micropyle closing cells; *d* = functional megaspore mother-cell; *e* = egg nucleus; *f* = sterile nuclei of the pollen-tube; *g* = generative cell; *h* = tapetal cells; *k* = tube nucleus; *m* = male cells; *n* = neck-cells; *p* = functional megaspore; *q* = non-functional megaspore; *s* = starch sheath; *sp* = sporogenous tissue; *t* = pollen-tube; *v* = ventral canal nucleus;  $\delta$  = male nucleus;  $\varphi$  = female nucleus.

## PLATE XLIV.

Figs. 1-26. Various stages in the development of the microspores from the microspore mother-cell. All except Fig. 24 drawn from sections of fixed material, and  $\times 1300$ ; Fig. 24 drawn from fresh material, and  $\times 600$ . All from material collected April 24-30, 1912.

Fig. 27. Germinating pollen-grain, with generative cell and tube nucleus.  $\times 600$ . May 18.

Fig. 28. Slightly older pollen-tube, with generative cell and tube nucleus; reconstructed from serial sections.  $\times 600$ . May 11.

Fig. 29. Tip of older pollen-tube, with body-cell nucleus and two sterile nuclei; from two adjacent sections.  $\times 600$ . May 18.

Fig. 30. The tip of a pollen-tube shortly before the body-cell divides.  $\times 600$ . June 28.

Fig. 31. Median longitudinal section of young ovule, just before pollination.  $\times 160$ . April 24.

Fig. 32. The sporogenous tissue of the same ovule more highly magnified.  $\times 600$ .

Fig. 33. The tip of the nucellus of a slightly older ovule, showing the characteristic breaking down of the apical cells.  $\times 160$ . April 27.

Fig. 34. Longitudinal section of the tip of an ovule just after pollination, to show the micropyle closing cells.  $\times 160$ . May 11.

Fig. 35. Transverse section of the same.  $\times 160$ . April 27.

Fig. 36. Megaspore mother-cell and surrounding tissue.  $\times 600$ . May 18.

Fig. 37. Functional and non-functional megaspores, and tapetum.  $\times 370$ . Drawn from two adjacent sections. April 29.

Fig. 38. One of the thirty-two dividing nuclei in a young embryo-sac.  $\times 1,100$ . May 18.

## PLATE XLV.

Fig. 39. Apex of a prothallus in longitudinal section, showing the archegonium initials.  $\times 250$ . August 12.

Fig. 40. Very young archegonia, with primary neck-cells; drawn from several serial sections.  $\times 370$ . July 30.

Fig. 41. Longitudinal section of archegonial complex, and two pollen-tubes; reconstructed from several serial sections.  $\times 160$ . Sept. 11.

Fig. 42. Part of a similar section to Fig. 41; drawn from several serial sections.  $\times 370$ . Sept. 11.

Fig. 43. Part of archegonium, showing ventral canal nucleus recently cut off.  $\times 530$ . Sept. 11.

Fig. 44. The same, a little later.  $\times 530$ . Sept. 11.

Fig. 45. The neck of an archegonium from Fig. 41, in longitudinal section.  $\times 530$ .

Fig. 46. Transverse section through the neck of a mature archegonium. One nucleus was present in the next section, which has not been represented in the figure.  $\times 530$ . Sept. 11.

Fig. 47. Fertilization. Male nucleus above.  $\times 530$ . Oct. 3.

Fig. 48. The same. Male nucleus below.  $\times 530$ . Sept. 23.

Fig. 49. The fusion nucleus.  $\times 530$ . Sept. 23.

- Fig. 50. Two groups of chromosomes and two spindles separating out in the prophase of the first sporophyte division.  $\times 530$ . Sept. 2.  
Fig. 51. The next section from the same series as Fig. 50.  $\times 530$ .  
Fig. 52. Slightly later stage of the division of the fusion nucleus.  $\times 530$ . Oct. 3.  
Fig. 53. Later stage of division of the fusion nucleus.  $\times 530$ . Oct. 3.  
Fig. 54. Binucleate proembryo at the base of the archegonium.  $\times 530$ . Sept. 23.  
Fig. 55. Four-nucleate proembryo at the base of the archegonium.  $\times 530$ . Sept. 23.  
Fig. 56. The same stage, but showing the whole archegonium and the ventral canal nucleus.  $\times 225$ . Sept. 23.  
Fig. 57. Various nuclei, unfused, fusing, and fused, from prothallus cells of the same age as Figs. 54-6.  $\times 530$ .  
Fig. 58. Two fusing nuclei in a prothallus cell.  $\times 530$ .

PLATE XLVI. (Microphotographs).

(All  $\times$  circa 100, except Fig. 60, which is  $\times 250$ .)

- Fig. 59. Median longitudinal section of young ovule. (Cf. Fig. 31.)  
Fig. 60. Functional megaspore, one of the two abortive spores, and surrounding tapetal tissue. (Cf. Fig. 37.)  
Fig. 61. Alveoli, showing the lagging in the development of those at the apex, as compared with the others. July 30.  
Fig. 62. Archegonium initials. (Cf. Fig. 39.)  
Fig. 63. Young archegonia, showing very large vacuole filling the greater part of each. August 12.  
Fig. 64. Nearly mature archegonia, and end of pollen-tube showing two male cells. (Cf. Fig. 41.)  
Fig. 65. Transverse section through an archegonial complex, just below the necks. Note the 'asteroids'. Sept. 11.  
Fig. 66. Binucleate proembryo. (Cf. Fig. 54.)  
Fig. 67. Two four-nucleate proembryos in section. (Cf. Figs. 55, 56.)





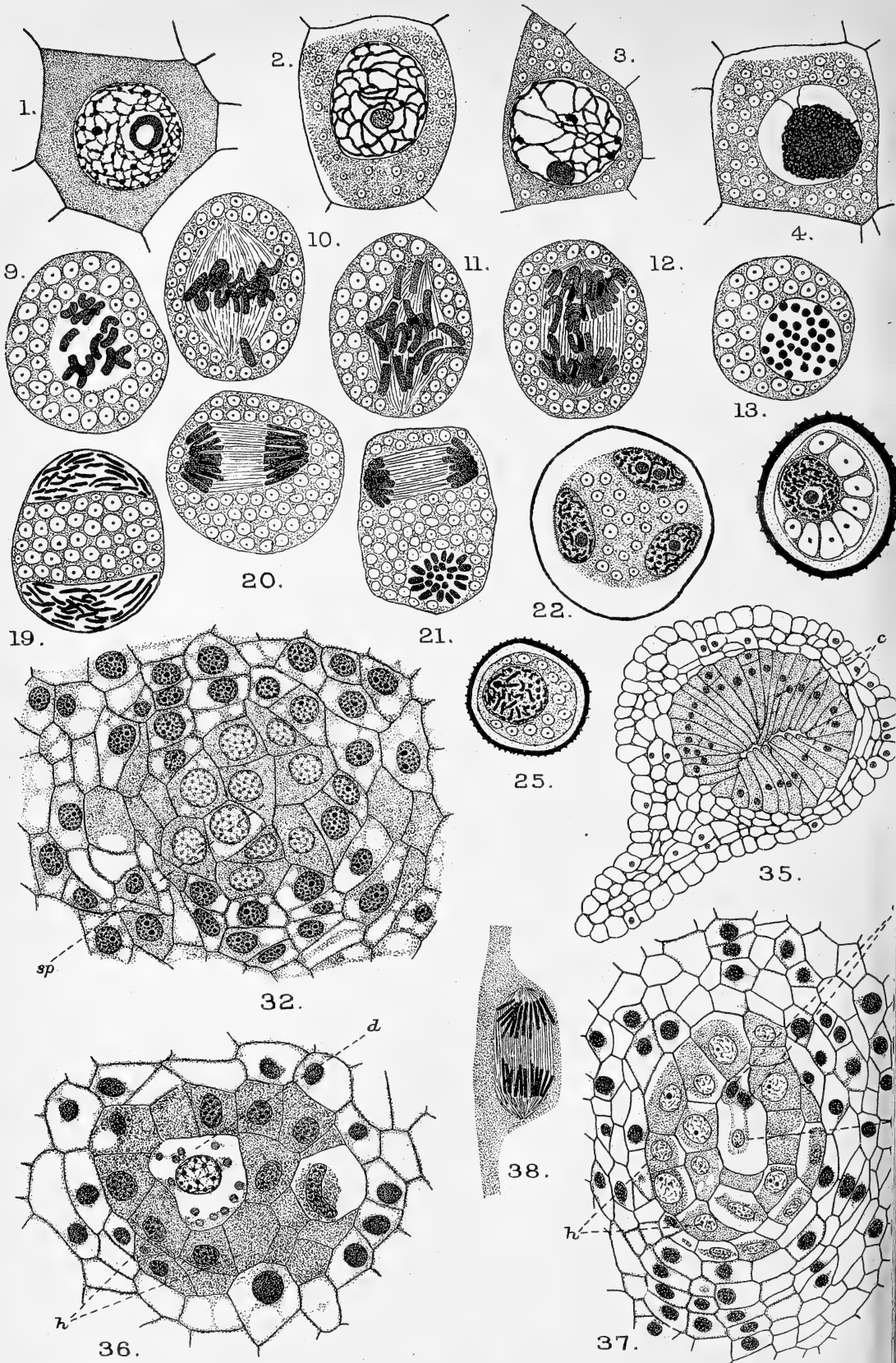

W.T. Saxton del.

SAXTON - TETRACLINIS.

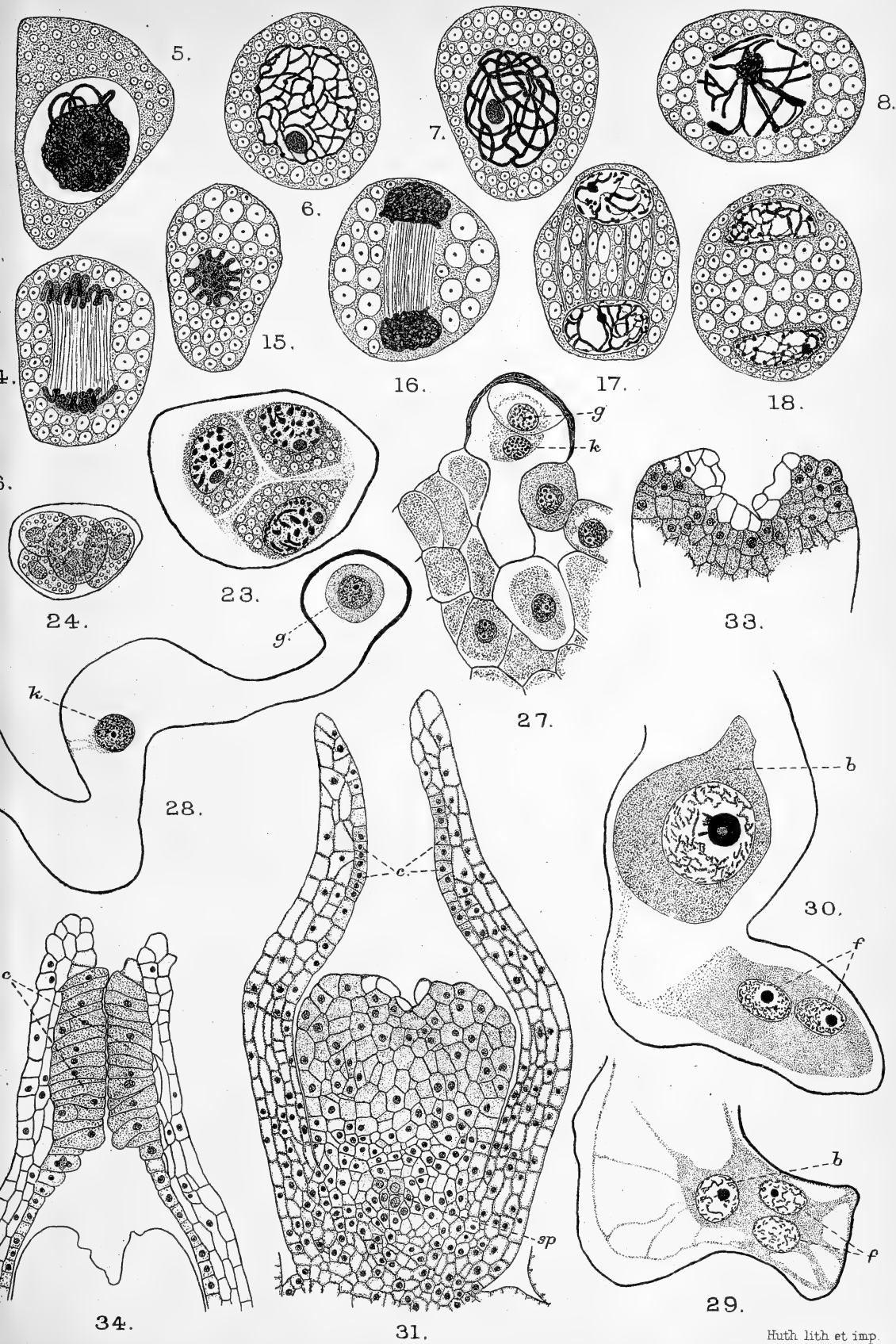





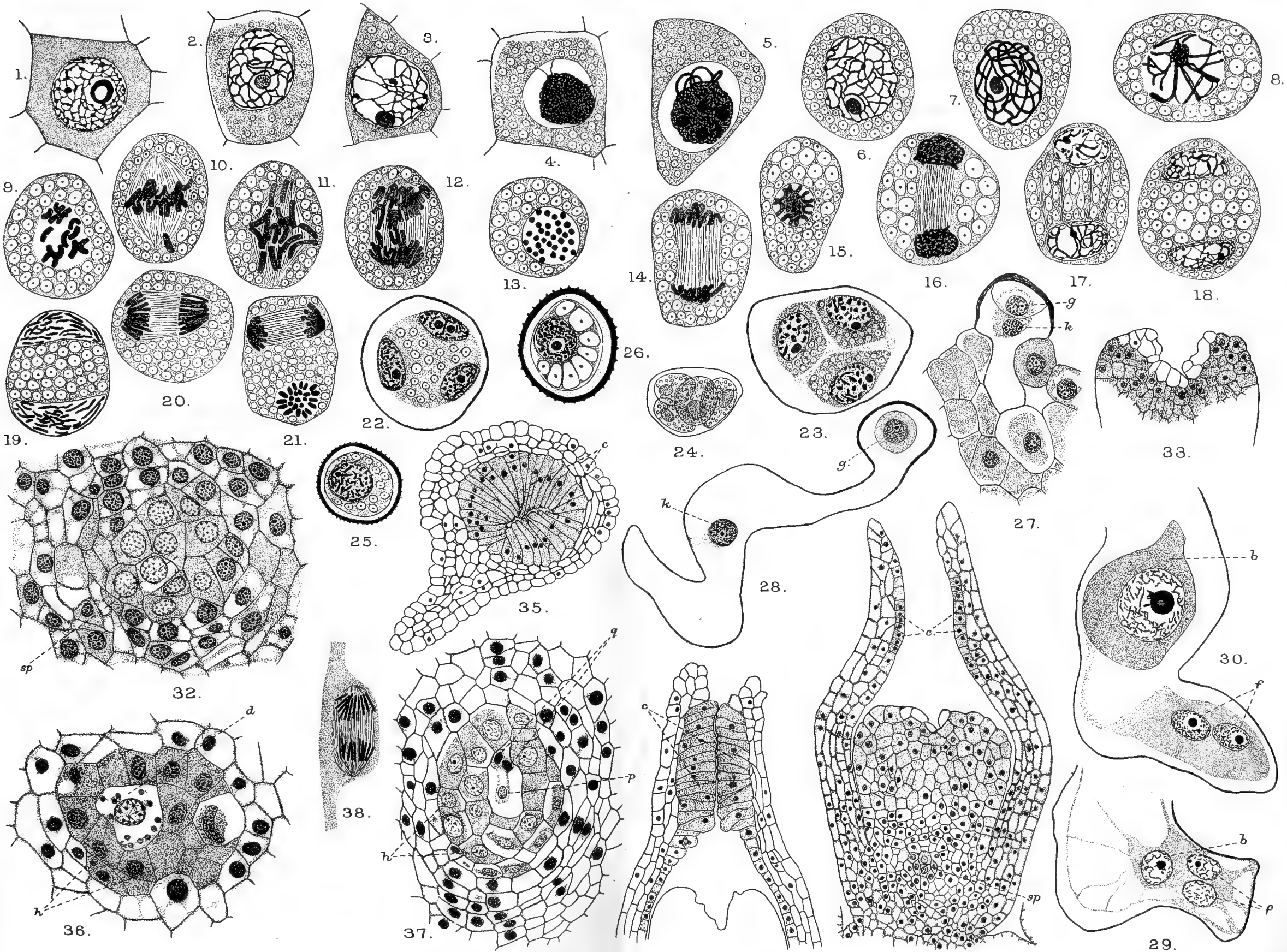

W.T. Saxton del.

SAXTON - TETRACLINIS.

Huth lith et imp

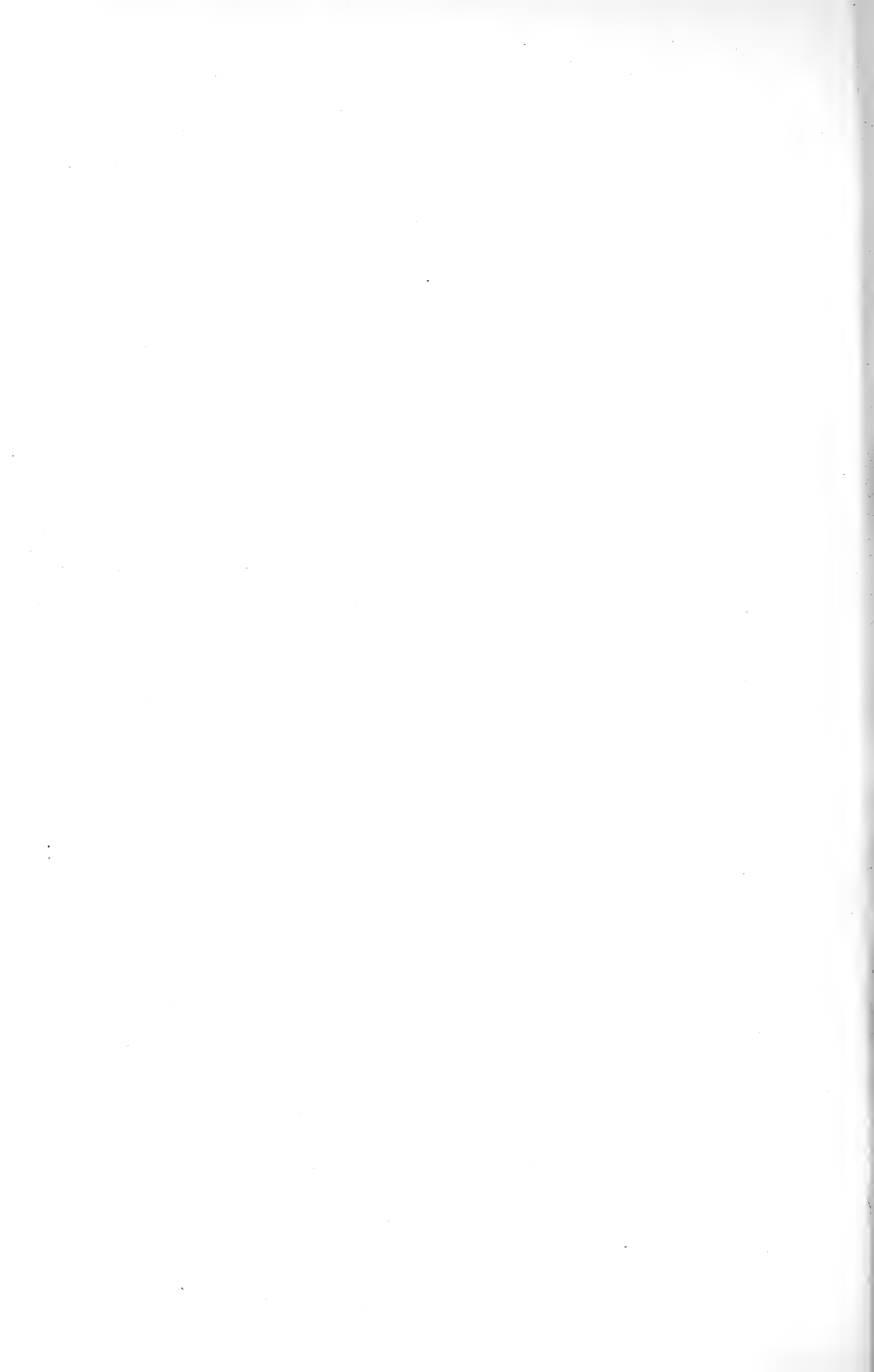



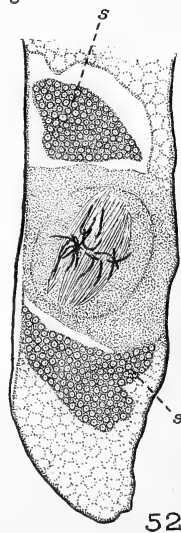
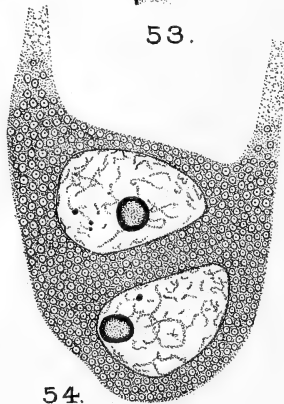
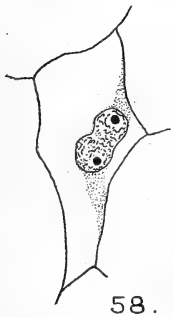
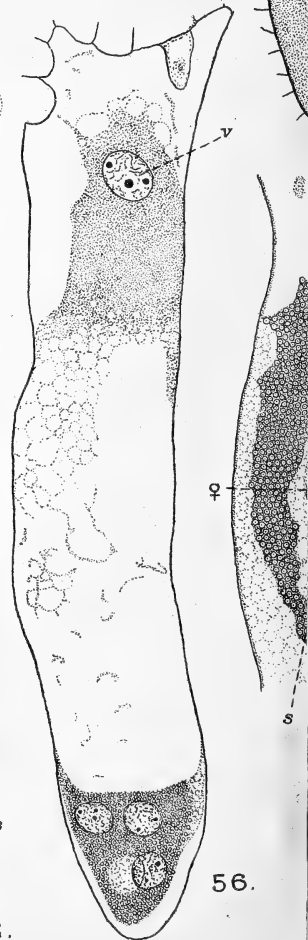
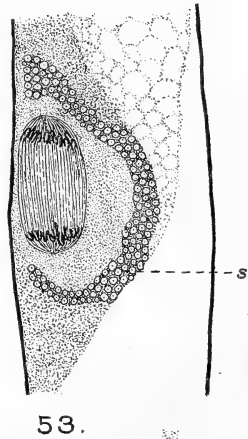
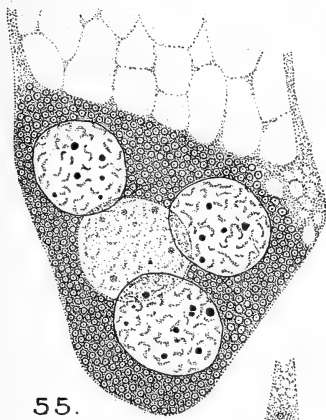
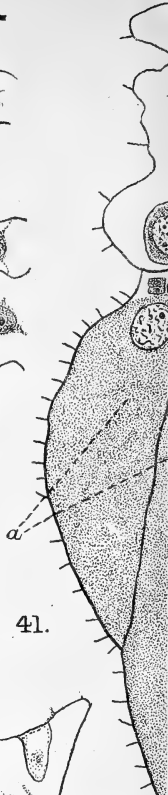
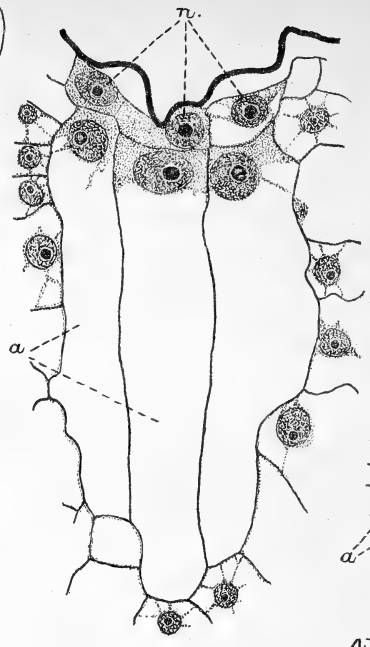
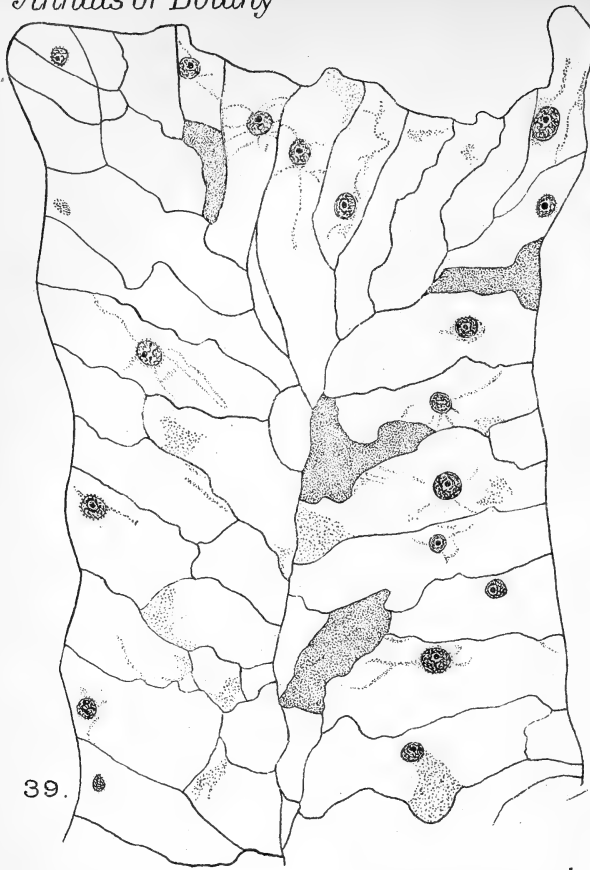

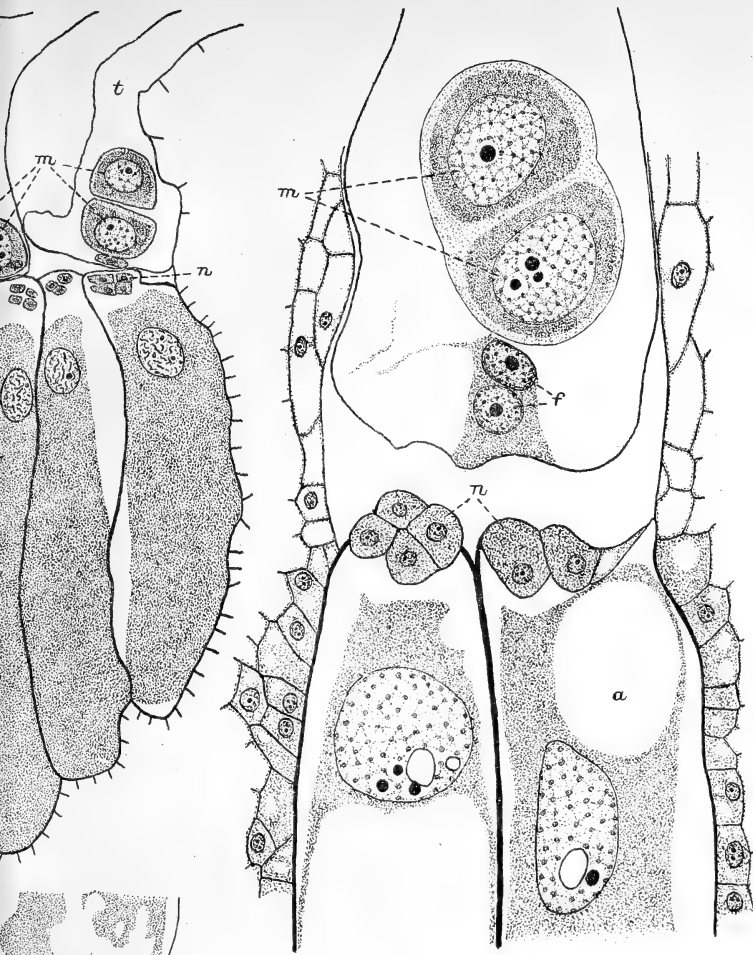

42.

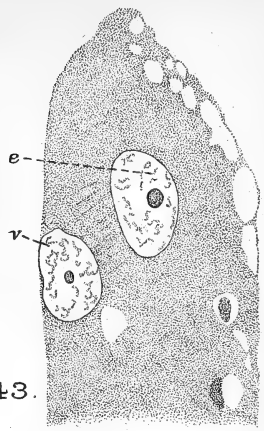

43.

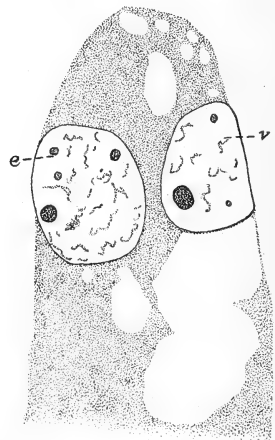

44.

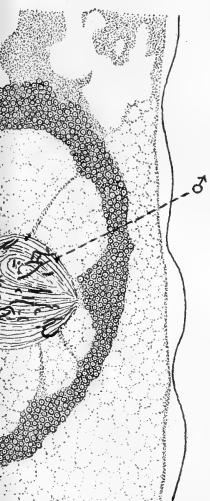

50.



49.

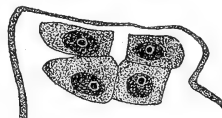

45.

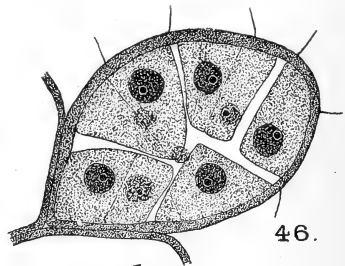

46.

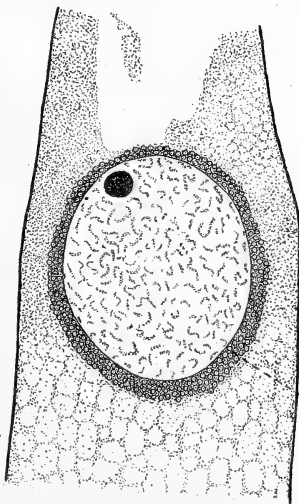

48.

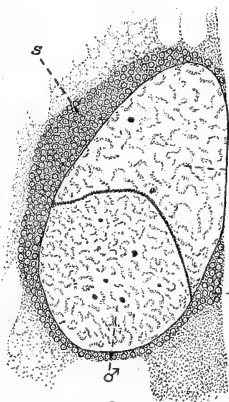

47.

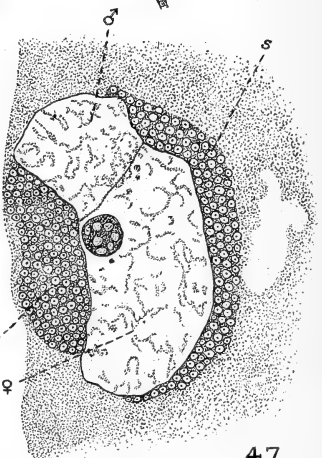



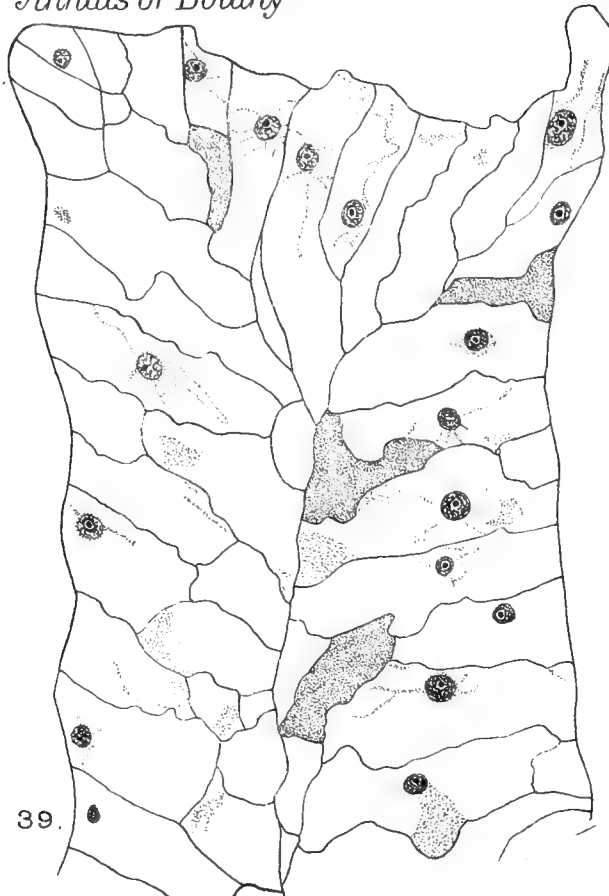

39.

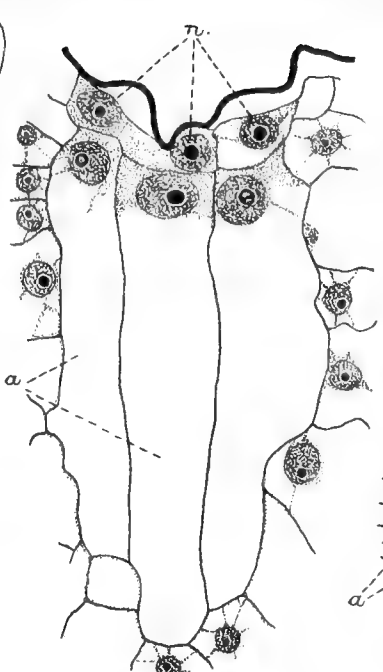

40.

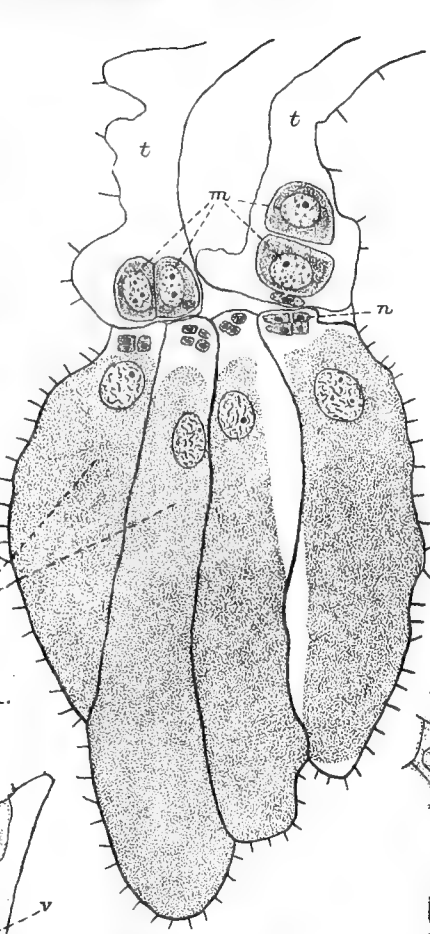

41.

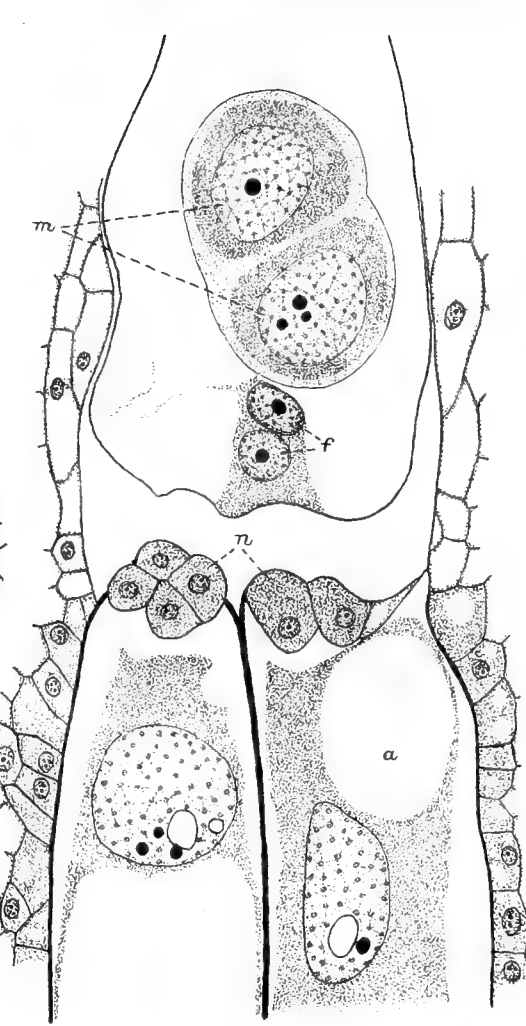

42.

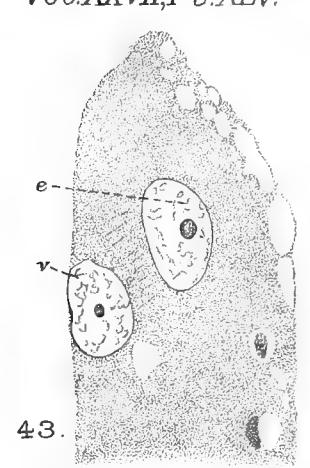

43.

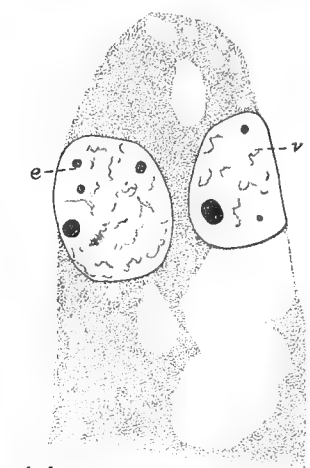

44.

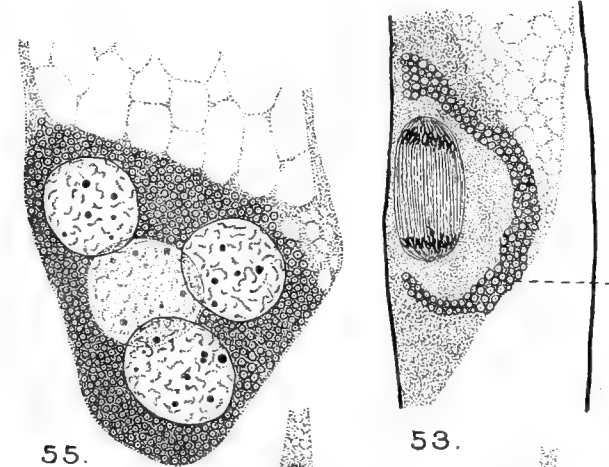

55.

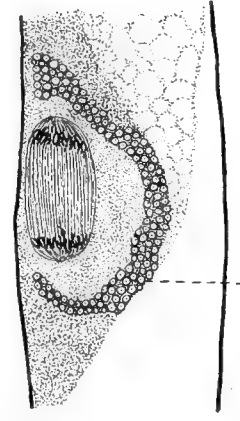

53.



51.



52.

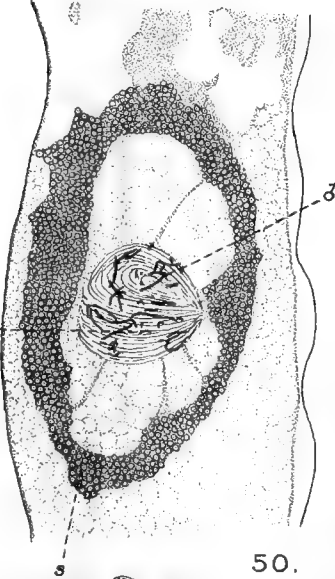

50.



57.

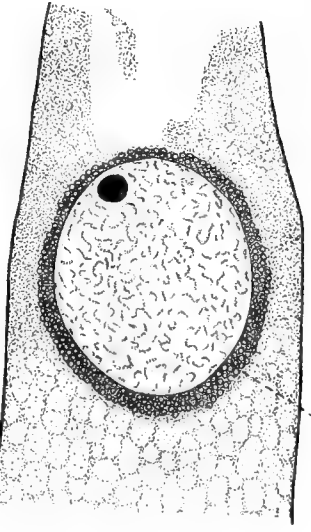

49.

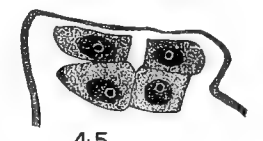

45.

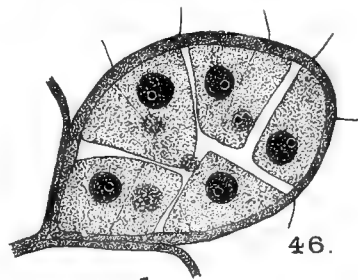

46.

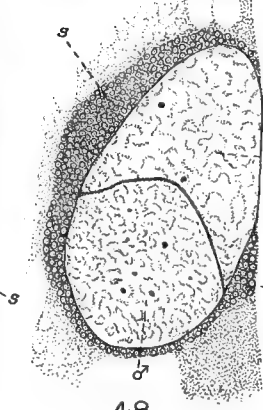

48.

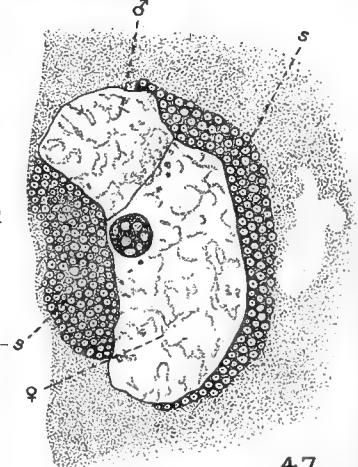

47.

Huth sc. et imp.

W. T. Saxton del.





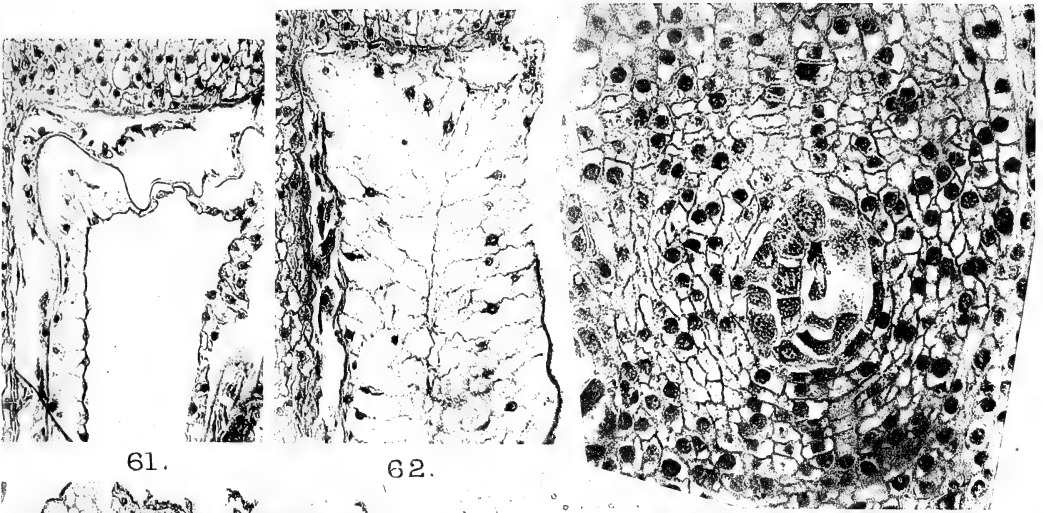

61.

62.

60.

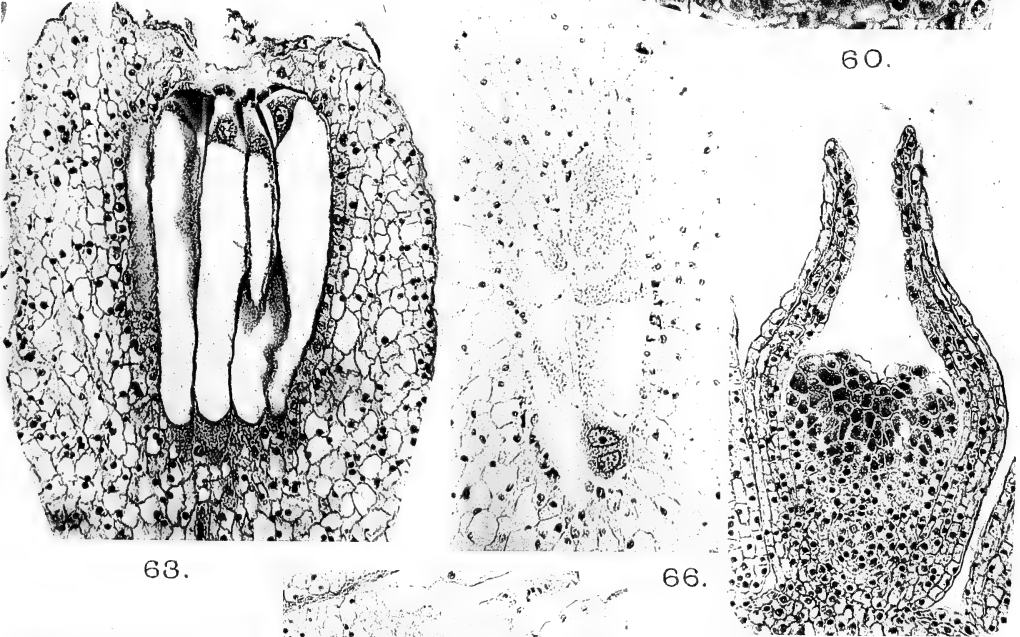

63.

66.

59.

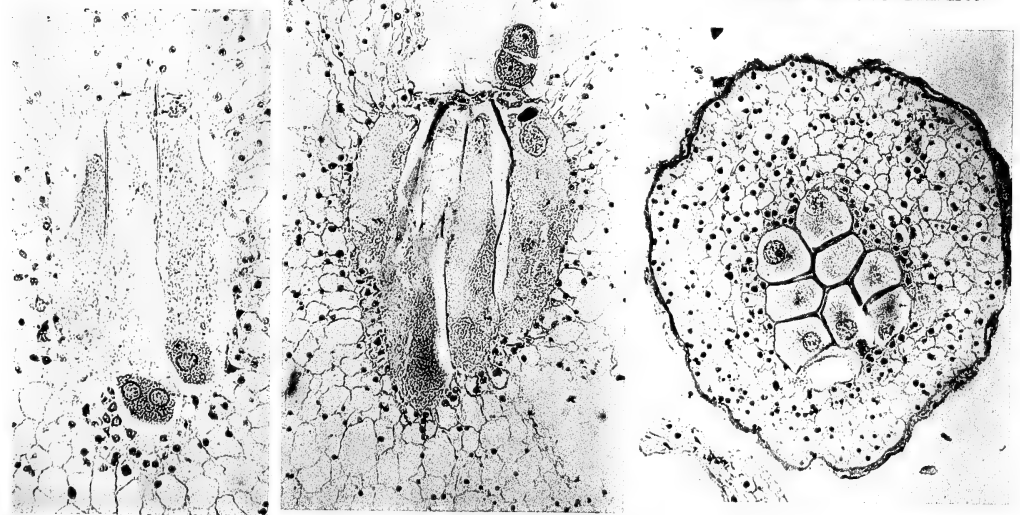

67.

64.

65.

W. Tams Photo.

Huth, coll.



# Contributions to our Knowledge of the Species of Utricularia of Great Britain with Special Regard to the Morphology and Geographical Distribution of *Utricularia ochroleuca*.

BY

PROFESSOR DR. H. GLÜCK (Heidelberg).

With Plates XLVII and XLVIII and seven Figures in the Text.

IN the works<sup>1</sup> which are at my disposal, the following species are noted as certain :

*Utricularia vulgaris*, L.

„ *major* Schmid = *U. neglecta*, Lehmann.

„ *intermedia*, Hayne.

„ *minor*, L.

In continental Europe the following species, with the exception of those above named, are found :

*Utricularia Bremii*.

„ *ochroleuca*.

„ *exoleta*.<sup>2</sup>

*U. Bremii* and *U. ochroleuca* possess a series of stations on the Continent. *U. exoleta* is a tropical type which, however, is only known in one place in Portugal.<sup>2</sup>

*U. Bremii* is mentioned in Babington's 'Manual',<sup>3</sup> but it is placed in parentheses, as this species has not been recorded with certainty for the Flora of Great Britain.

As regards *U. ochroleuca*, certain indications and presumptions as to its occurrence in Great Britain are, it is true, to be found in the literature,<sup>4</sup> but up till now they have received no credence. During the last few years I have visited the British Isles several times to make some special studies

<sup>1</sup> J. D. Hooker, The Student's Flora of the British Islands, London, 1870, pp. 297, 298. Charles Cardale Babington, Manual of British Botany, 9th ed., London, 1904. George West, A Further Contribution to a Comparative Study of the Dominant Phanerogamic and Higher Cryptogamic Flora of Aquatic Habit in Scottish Lakes: Proceedings of the Royal Society of Edinburgh, vol. xxx, pt. ii, p. 79.

<sup>2</sup> P. Ascherson, Verhandlungen der Deutschen Botan. Gesellschaft, vol. iv, 1886, p. 404.

<sup>3</sup> Charles C. Babington, Manual of British Botany, 9th ed., pp. 338 and 339.

<sup>4</sup> Compare W. Trail, Annales of Scottish Natural History, 1904.

touching water-plants. On these occasions I observed, not only that *U. ochroleuca* occurs in Great Britain, but also that in a certain part—namely, in Scotland—it is very widely distributed.

The first clue which led me to *U. ochroleuca* in England was a small and poor example in the herbarium of Oxford University, originating from Loch Mallachi in Scotland.<sup>1</sup> I visited Loch Mallachi myself in the autumn of last year, and, in spite of the greatest pains, I was unable to find the spot; nevertheless I found the plant a short distance away, in little pools at the road-side not far from a farm between Loch Mallachi and Boat of Garten, and later I discovered a few other places in Scotland and Ireland.

In the following paper I should in the first instance like to communicate to my readers the most important points of the history of the discovery of *U. ochroleuca*; in the second place, its morphological and biological characters will be dealt with in detail; and, in the third place, our present knowledge of the geographical distribution of *U. ochroleuca* will be discussed.

#### I. HISTORICAL.

*U. ochroleuca* was recorded for the first time by Hartman<sup>2</sup> in the year 1857 for Sweden.

In 1886 *U. ochroleuca* was recorded on the Flora of North Germany by P. Ascherson, and since that time it has been found in the following North German provinces: Brandenburg, Pommern, Mecklenburg, Oberlausitz, Schlesien.

In 1893 *Utricularia ochroleuca* was recorded for South Germany by K. Goebel<sup>3</sup> (for the Bavarian Highlands), and in 1902 I was myself able to add to this single place a few other South German stations belonging to the heights of the Black Forest.<sup>4</sup>

Besides this, *U. ochroleuca* is mentioned for Galicia by F. Kamienski;<sup>5</sup> for Greenland by Joh. Abromeit.<sup>6</sup> For France it is noted for one place only, viz. for the Vosges Mountains; the plant, originating from a pool near the Lac Longemer and collected by S. Perrin, is identical with the plant of the Black Forest, but as distinguished from this it has copious typical flowers.<sup>7</sup>

<sup>1</sup> The Botanical Exchange Club (Report, 1910, p. 315) has made a communication on this point through G. Claridge Druce, Oxford.

<sup>2</sup> R. Hartman, De Svenska arterna af släktet *Utricularia*. Botaniska Notiser, 1857.

<sup>3</sup> K. Goebel, Systematische Gruppierung der deutschen *Utricularia*-Arten. Mitt. der Bayerischen Botan. Ges., No. 4, München, 1893.

<sup>4</sup> H. Glück, Über die systematische Stellung und geographische Verbreitung der *Utricularia ochroleuca*. Berichte der Deutschen Botan. Ges., 1902, vol. xx.

<sup>5</sup> F. Kamienski, Sur une espèce nouvelle pour la flore du pays (Galicie). Bulletin de l'Académie des Sciences de Cracovie, Déc. 1899, p. 505.

<sup>6</sup> Compare Bibliotheca Botanica, Heft 42, Stuttgart, 1899, p. 141.

<sup>7</sup> The plant is to be found in the Herbarium normale of F. Schultz, No. 297: 'Dans les mares qui avoisinent le Lac de Longemer (Vosges, France) S. Perrin, viii, 1868.'

II. MORPHOLOGY AND BIOLOGY OF *UTRICULARIA* *OCHROLEUCA*.

As *U. ochroleuca* shows the nearest affinity to *U. intermedia*, it will be easily understood that in England *U. ochroleuca* and *U. intermedia* have been until now confused with one another. We must therefore, in the following treatment, also consider *U. intermedia*.

Before entering into the specific differences between *U. ochroleuca* and *U. intermedia*, it is perhaps well to say a few words about the systematic grouping of the European species of *Utricularia*. It is appropriate here to distinguish the three following natural groups:

- (i) *U. vulgaris*.  
*U. major* (= *neglecta*).  
(*U. exoleta*.)
- (ii) *U. intermedia*.  
*U. ochroleuca*.
- (iii) *U. minor*.  
*U. Bremii*.

*U. vulgaris* and *major* (*neglecta*) are the largest indigenous species. The leaves are bipartite and divided into numerous capillary terminal lobes, and bear many bladders. On the base of the flowering stem 'rhizoids' occur; these are small metamorphosed shoots, which serve to anchor the flowering stems and to keep them in a vertical position, but are often rudimentary.<sup>1</sup> Besides, they produce 'air-shoots'; these are metamorphosed threadlike shoots, which grow upwards to the surface of the water, bearing small scales, and are of service for the exchange of gases.<sup>2</sup>

*Utricularia ochroleuca* and *intermedia* are much smaller plants than the two first mentioned. The shoots differentiate in two directions: one kind is covered with green, assimilating floating leaves; the other is colourless and penetrates into the mud. The leaves of the green shoots may be divided into 7-15 terminal lobes, and may bear 0-3 bladders. The 'leaves' of the subterranean shoots are also colourless, and bear on fine filiform branches 3-8 bladders. 'Rhizoids' are also to be found on the base of the flowering stems,<sup>3</sup> but the 'air-shoots' are missing.

*U. minor* and *U. Bremii* are the two smallest species, and indeed the latter exceeds the *U. minor* in its general habitat and in the size of its flowers. The shoots also differentiate into green assimilating and colourless underground shoots; the green floating leaves may be divided into 14-20 terminal lobes and may bear 7-8 bladders. 'Rhizoids' and also 'air-shoots' are missing on the flowering stem.

<sup>1</sup> Compare H. Glück, *Biologische und morphologische Untersuchungen über Wasser- und Sumpfgewächse*, vol. ii, pp. 66-72.

<sup>2</sup> Compare *ibid.*, pp. 78-83.

<sup>3</sup> In respect of the 'rhizoids' see my above-mentioned work, vol. ii, p. 73.

We will now go into the specific differences between *U. ochroleuca* and *U. intermedia*. At first we will consider the vegetative organs.

*U. ochroleuca* usually grows in the shallow water of small pools with a boggy bottom (Pl. XLVII, Figs. 1 and 2, also the forms B, C, D in the table on p. 613). The green water-shoots may grow up to 42 cm. in length. With the exception of the underground shoots, which in the first place serve as bearers of bladders in *U. ochroleuca*, the green water-shoots may produce isolated bladders; one or several bladders may be on one shoot (compare

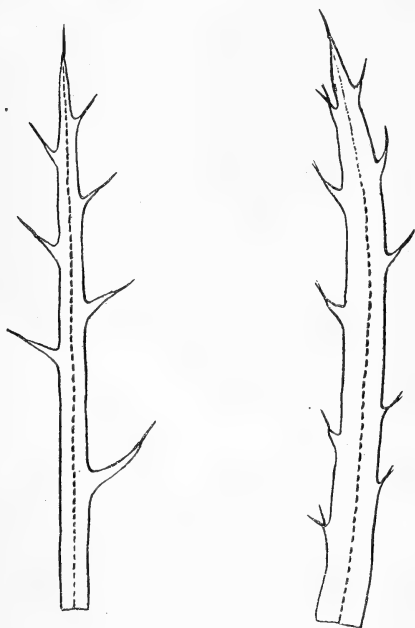

1 a.

1 b.

TEXT-FIGS. 1 a, b. Terminal leaf-segments of *Utricularia ochroleuca*. Fig. 1 a shows a terminal segment belonging to a Scotch example taken from shallow water, from Boat of Garten.  $\times 20$ . Fig. 1 b shows a terminal segment belonging to a Scotch example from deeper water, from the Loch nan Mathair Etive.  $\times 20$ .

Fig. 1). On *U. intermedia* I never found bladders in the specimens of continental Europe; but through the kindness of Mr. W. H. Burrell I recently obtained some dried specimens originating from Norfolk, of which a small number show water-shoots with isolated bladders; and, indeed, in this case 1-4 bladders are to be found on one water-shoot (Pl. LXVIII, Fig. 19). Perhaps we have here the case of a variety, which should be more accurately investigated.

The green assimilating leaves of *U. ochroleuca* are somewhat variable (Pl. XLVIII, Figs. 16-18); they are semicircular to reniform in outline and repeatedly furcated in small linear terminal segments. Sometimes they are divided into a small number of segments (as in the case of the specimens from Boat of Garten in Scotland and also of those from the Black Forest), and are therefore similar to the leaves of *U. intermedia* (Pl. XLVIII, Fig. 16); sometimes they are divided into more

terminal segments (as in the case of the specimens from Loch nan Mathair Etive in Scotland and also of those from Holland), and remind us of the magnificent leaves of *U. minor* (Pl. XLVIII, Figs. 17 and 18). Consequently *U. ochroleuca* is sometimes confused with *U. intermedia* and sometimes interpreted as a hybrid between *U. intermedia* and *U. minor*;<sup>1</sup> which interpretation as hybrid cannot well be defended. We see, on the one hand, that *U. ochroleuca* is normally not associated with *U. intermedia*; on the other hand, we see that in the moors

<sup>1</sup> Compare L. M. Neuman, *Utricularia intermedia*, Hayne,  $\times$  *U. minor*, L. Botaniska Notiser, 1900, p. 65.

of Switzerland *U. intermedia* and *U. minor* are often to be found together and flowering at the same time; but in spite of this *U. ochroleuca* is never found in Switzerland. The most marked differences are illustrated by the terminal lobes of the leaves (Pl. XLVIII, Figs. 16–19). In *U. ochroleuca* the terminal lobes gradually taper into a point and bear a small spine (see Pl. XLVIII, Figs. 16–18, and Text-figs. 1 *a*, *b*); but in *U. intermedia* the terminal lobes are more or less obtuse and bear also a small spine (see Pl. XLVIII, Fig. 19, and Text-figs. 2 *a*–*c*). In *U. ochroleuca* the

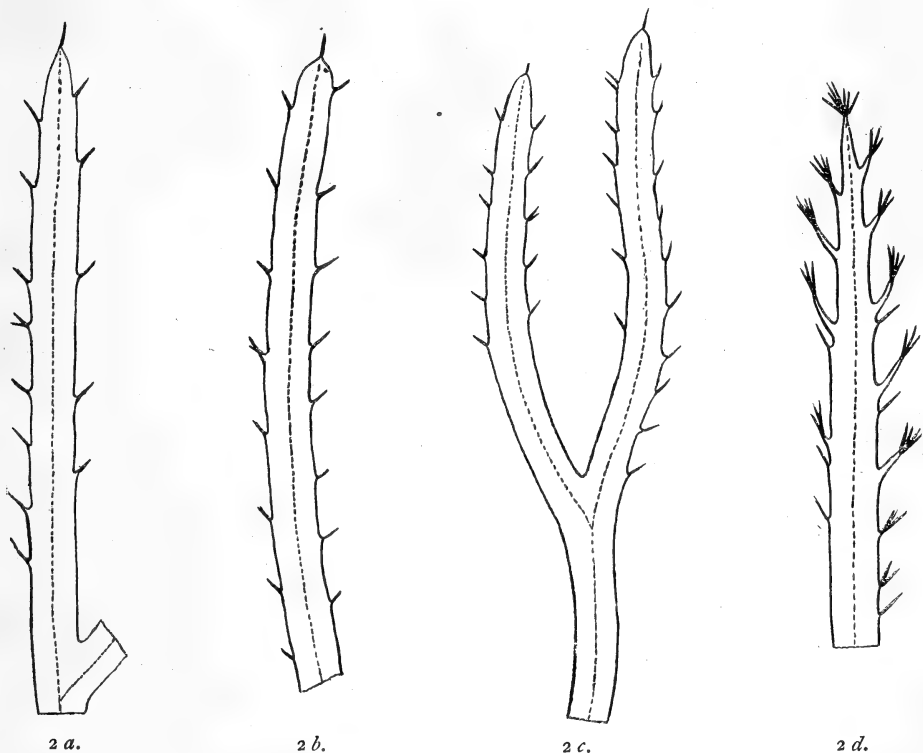

TEXT-FIGS. 2 *a*–*d*. Terminal leaf-segments of *Utricularia intermedia*. Fig. 2 *a* shows a terminal segment belonging to an example from Switzerland (Wallisellen near Zürich), which was growing in shallow water.  $\times 10$ . Fig. 2 *b* shows a terminal segment belonging to an example from Norfolk. The leaf-apex is more acute than in Fig. 2 *a*.  $\times 20$ . Fig. 2 *c* shows a terminal segment belonging to an example from Scotland (Perthshire). Fig. 2 *d* shows a terminal segment belonging to an intermediate leaf originating from Norfolk (Barton Turf).  $\times 20$ .

terminal lobes on each side are furnished with 1–6 little spines. In *U. intermedia* the terminal lobes on each side are furnished with from 2–10 spines. In *U. ochroleuca* the little spines are placed in very little and small teeth, but in *U. intermedia* the little spines are placed almost directly on the leaf-edges. In *U. ochroleuca* the little spines are often in pairs, but in *U. intermedia* they are mostly isolated.

It is also not well possible to confuse the typical water-leaves of *U. ochroleuca* with those of *U. intermedia*; they exist through the whole

summer and autumn in the specimens from continental Europe; but I observed several times in the British specimens of *U. intermedia*,<sup>1</sup> that in autumn, often before developing the winter bud, a long series of intermediate leaves is formed, which may occupy a length of 10–15 cm. of the axis (Pl. XLVII, Fig. 5). Such examples may show a great similarity to *U. ochroleuca*; but on microscopic investigation they can be recognized as belonging to *U. intermedia*. The terminal segments of such leaves are acute, whilst the leaf-edges are denticulate (Text-fig. 2 *d*). The teeth are furnished with 2–8 small spines, which never occur on the typical water-leaves of *U. ochroleuca*; besides this, small and isolated spines, otherwise existing only in *U. intermedia*, are directly set on the leaf-margin and are mostly mixed together with the little teeth.

The subterranean shoots of *U. ochroleuca* are scarcely different from those of *U. intermedia*. These shoots may be up to 27 cm. in length, are sometimes not branched, and bear sometimes 1–3 lateral branches. The peculiar limb of the subterranean leaves is much reduced, and each leaf may bear 2–4 bladders.

Besides this also the bladders of *U. ochroleuca* and *U. intermedia* are a little different, as von Lützelburg has recorded.<sup>2</sup> In both the bladders and antennae are strongly curved, acute, and covered with hairs on the back. In *U. intermedia* many double hairs are attached to the valve, and also tufts of such hairs are in the angles of the valves; in *U. ochroleuca* few double hairs are found on the valve, and the tufts of hairs in the angles are nearly missing.

In the deeper water to about a depth of 100 cm. all vegetative parts as well as the leaves become longer and more tender (Pl. XLVII, Figs. 3 and 4). The colourless and bladder-bearing shoots of such examples are often floating in the water, and show therefore many transitions into green and assimilating water-shoots (Fig. 4). Such examples I observed in different places (see the forms F, G, and H in the table on p. 613).

*U. ochroleuca* under certain circumstances produces in dry stations *land forms* which are greatly reduced in all parts, and reach a length of only a few centimetres. I found this only in Germany<sup>3</sup> (see the form A in the table on p. 613).

After having stated the difference of the vegetative region between *U. ochroleuca* and *U. intermedia*, I should like to draw the reader's attention to the fact that *U. ochroleuca* by superficial investigation (viz. without

<sup>1</sup> Specimens of such a kind I found myself in pools between Recess Hotel and Recess Station in Ireland; besides this Mr. W. H. Burrell (of Norwich) sent me recently specimens, quite similar, originating from Norfolk, which had been collected in the end of September and in the beginning of October.

<sup>2</sup> Compare Ph. von Lützelburg, Beiträge zur Kenntnis der Utricularfen. Flora, 1909, pp. 63–66, and Figs. 46–48.

<sup>3</sup> Compare H. Glück, Biologische und morphologische Untersuchungen, &c., vol. ii, pp. 64, 65.



TABLE ILLUSTRATING THE VARIABILITY OF *UTRICULARIA OCHROLEUCA*.

Land form	Origin.	Quality of the station.	Green or leaf-bearing shoots.			Colourless and bladder-bearing shoots.			Other remarks.	Flowering formation.
			Length of the water-shoots.	Magnitude of the water-leaves.	Number of the terminal segments.	Length of the shoots.	Length of the under-ground leaves.	Magnitude of the bladder-bearing shoots.		
A	Black Forest	Damp and boggy mud	3-4-6 cm.	1.5-3.5 mm.	3-10	2-4 cm.	1 mm.	2-3 mm. long 1.3-2 mm. high	The shoots are fixed below the soil	Absent
B	Holland : Konigsveen near Nym- wegen viii, 1912	Very shallow water of few centimetres	18-42 cm.	4-9 mm.	18-19	3-27 cm.	5-11 mm.	1.5-3 mm. l. 1-2 mm. h.	"	Copiously present
			13-23 cm.	6-11 mm.	12-25 (29)	7-14 cm.	5-14 mm.	1.6-3.2 mm. l. 1-2.5 mm. h.	"	Absent
C	Scotland : Rannoch Moor, Loch nan Mathair Eive viii, 1912	"	8-15 cm.	4-10 mm.	9-15	4-13 cm.	5-12 mm.	1.6-3 (4) mm. l. 1.2-2, 8 mm. h.	"	"
			—	6-15 (17) mm.	7-12	4.5-13 cm.	—	3-3.5 mm. l. 2-2.8 mm. h.	Fixed in the ground or floating in the water and then changing into water-shoots	"
D	Black Forest : From different places	"	—	10-18 mm.	7-16	10-25 cm.	6-12 mm.	2-4 mm. l. 1.8-3 mm. h.	Mostly floating in the water with many transitions into water-shoots	"
			25-50 cm.	7-15 mm.	10-16	9-16 cm.	—	3-4.5 mm. l. 1.8-2.8 mm. h.	Fixed in the ground or floating and then changing into water-shoots	"
E	Scotland : Pools near Boat of Garten viii, 1912	Ca. 10-20 cm. deep water	—	8-15 mm.	7-8	4-14 cm.	—	—	Floating in the water with transitions into water-shoots	"
			25-50 cm.	7-15 mm.	7-8	4-14 cm.	—	—	—	"
F	Black Forest : Hinterzarten near Titi-See	Deep water, 50-70 cm.	—	8-15 mm.	7-8	4-14 cm.	—	—	Floating in the water with transitions into water-shoots	"
			25-50 cm.	7-15 mm.	7-8	4-14 cm.	—	—	—	"
G	Scotland : Rannoch Moor, Loch nan Mathair Eive viii, 1912	"	—	8-15 mm.	7-8	4-14 cm.	—	—	Floating in the water with transitions into water-shoots	"
			25-50 cm.	7-15 mm.	7-8	4-14 cm.	—	—	—	"
H	Ireland : In the Glendalough near Recess Station	Deep water, 100 cm.	—	8-15 mm.	7-8	4-14 cm.	—	—	Floating in the water with transitions into water-shoots	"
			25-50 cm.	7-15 mm.	7-8	4-14 cm.	—	—	—	"

microscope) may be easily mixed up with a form of *U. minor*. *U. minor* produces, like *U. vulgaris*, *neglecta*, and *Bremii*, a platyloba-form (Text-fig. 3). Probably it is a form which results from unfavourable nutrition; it dis-

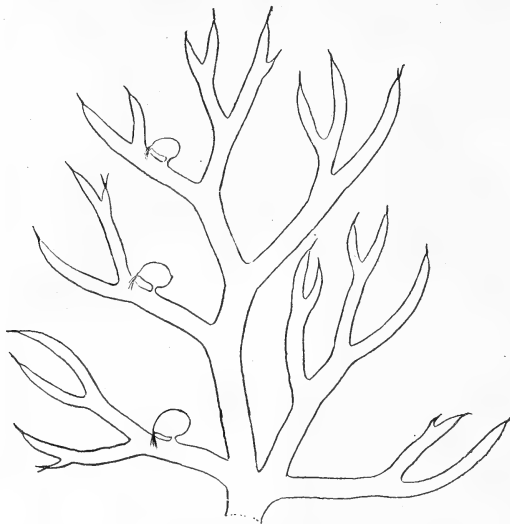

TEXT-FIG. 3. An isolated leaf of *Utricularia minor forma platyloba* from Scotland.

tinguishes itself from the type by enlarged leaf-segments as well as by reduced bladders. By the pointed end-segments this form approaches *U. ochroleuca*, but by microscopic investigation it differs from *U. ochroleuca* by the absence of the marginal and prickly denticles. I have seen myself *U. minor f. platyloba* in dried state from different Scotch localities.<sup>1</sup>

#### *Flowering Stems.*

Evidently the flowering stems are very rarely developed in *U. ochroleuca*. I have seen *U. ochroleuca* from about fifty stations in Great Britain; amongst these are no more than two stations on which there are observed flowers. There is one in Scotland (Hillbog, near Garve) where flowers were very scarce, and the other in England (Morden Decoy), where the flowers were more copious. Also in the Black Forest I found *U. ochroleuca* always barren. But evidently in Scotland the other species of *Utricularia* very seldom bear flowers. *U. vulgaris*, which is widely distributed in Scotland, I have seen from about twenty-five stations (herbaceous material), and, in fact, only sterile. Mr. George West agrees with my own observation, as he says: 'I have never seen any *Utricularia* flowering in a loch; they appear to be continually reproduced by hybernacula' (l. c., p. 79).

The cause that flowers appear so very scarce may partly be the con-

<sup>1</sup> For instance: Ardblair Loch (Ratray), Moss of Dalbruzon (Glenshee), and Happlin Loch (Perthshire). Nat. Hist. Mus. of Perth.

sequence of the cold stations, partly the strong vegetative propagation with winter-buds, which suppresses the flowering region in consequence of correlation.

The only one station where I found *U. ochroleuca*, and, indeed, with plenty of flowers, is situated in Holland in the so-called 'Konigsveen', not very far from Nymwegen. Mr. H. Höppner, who has occupied himself for many years with the Flora of the Lower Rhine, had the kindness to show me the above-mentioned locality. The following description only refers to the place in Holland.

At the beginning of August we both found *U. ochroleuca* flowering in some ditches of standing and shallow water in which, *U. ochroleuca* excepted, *U. neglecta* and *U. minor* are copiously to be found with flowers. The flowering stems have a height of 10–17½ cm. (Pl. XLVII, Fig. 1). They produce 2–3 small and sterile scales; at the top stalked flowers emerge from the axil of similar scales, which are very similar to those of *U. intermedia* in size and yellow colour (Pl. XLVIII, Figs. 9–12). The calyx is two-lipped; the corolla also differentiated into upper lip, lower lip, palate, and spur. The upper lip is ovate and the top obtuse and a little scalloped (height 6.5–7 mm.; width 6–7.8 mm.). The lower lip is rounded, sometimes flat and a little undulated; sometimes the two flank edges are slightly turned down. It is 7–9 mm. long and 12–13 mm. broad when extended in one plane. The palate is globose, depressed, and shorter than the upper lip; it is furnished with several brownish-red parallel stripes. The spur is conical, about half as long as the lower lip, and almost vertical to the latter; it is about 4–5 mm. long, and tapering towards the top. Fruits are not known to me up till now.

The flowers of *U. intermedia* (Pl. XLVIII, Figs. 13–15) are similar to those of *U. ochroleuca*, but are easily to be distinguished; they are, on the average, larger than those of *U. ochroleuca*. The lower lip is longer in proportion to the palate, which is a little scalloped and bears some dark-brown and irregular stripes. The best distinguishing mark is with reference to the spur: it is narrow, cylindrical, and runs parallel to the lower lip; it is sometimes nearly of the same length as the lower lip, sometimes shorter than the latter. The spur of *U. ochroleuca*, on the contrary, is more conical, about half as long as the lower lip, and nearly vertical to the latter (compare Fig. 9 with Fig. 13, and Fig. 12 with Fig. 15).

'Rhizoids' occur also here, but I could not find more than one on the base of the flowering stem (Pl. XLVII, Figs. 6–8). They can be isolated or exist together with an underground shoot (as in Fig. 6), arising from the base. In many examples the 'rhizoids' seem to be absent, but they existed originally and were later metamorphosed into underground shoots (compare the underground shoot  $s_1$  in Fig. 1, Pl. XLVII). The 'rhizoids' may have a length of 5–8.5 cm. and bear several (up to seventeen) small lateral

organs, which become 0.5–2.5 mm. long; the latter are identical with metamorphic leaves (Pl. XLVII, Figs. 7 and 8); they are pinnatifid in 3–12 large and linear segments, which are twisted in a claw-like manner, their surface nearly vertical to the rhizoid axis. The apices of the lobes are obtuse, furnished with a little spine and densely covered with globose papillae. I observed a great many intermediate forms between the ‘rhizoids’ and the underground shoots. The underground shoot  $S_1$  in Fig. 1 (Pl. XLVII) is originating from a former rhizoid, and the two little segments (*l, l*) are former rhizoid segments.

The rhizoids of *U. intermedia* are not very different from those of *U. ochroleuca*, but they have mostly more delicate lateral segments, which are without little spines on the apex of the segments.<sup>1</sup>

#### *Propagation and Hibernation.*

Similarly to the other *Utricularia* species, *U. ochroleuca* produces also in autumn winter-buds, which serve for the vegetative propagation and hibernation. I found these in August, but only scantily, in two Scotch localities (near Boat of Garten and in the Loch nan Mathair Etive of the Rannoch Moor). On the other hand, formerly I was able to study it minutely with German specimens.<sup>2</sup> I will only mention the most important points here.

The formation of the buds takes place chiefly in September and October, and can occur as well on the green floating shoots as on the underground shoots. Some intermediate leaves lead over to the development of the winter-bud. In comparison to the vegetative leaves the intermediate leaves grow smaller and smaller, and the edges show a numerous formation of little teeth covered with fasciculated spines.

The buds themselves are globose, 3–5 mm. thick;<sup>3</sup> they are similar to those of *U. intermedia*, with a covering of hair, which, however, is not so dense as that of *U. intermedia*.

In the germination,<sup>4</sup> which commences in May or at the beginning of June, the axis-bud expands three to five times its original length, whilst with *U. intermedia* the axis-bud does not experience a secondary prolongation. The typical bud-leaves are in the outline semicircular to reniform, and are divided similarly to the vegetative leaves, but they have terminal lobes greatly shortened and enlarged, of which there may be 7–20. The edge of

<sup>1</sup> Compare H. Glück, l.c., vol. ii, pp. 73 and 74.

<sup>2</sup> Compare *ibid.*, pp. 125–127.

<sup>3</sup> In land forms the winter-buds are only 1.2–2 mm. thick.

<sup>4</sup> The germinating winter-buds are not very rare among the herbarium material. I have seen them in Mr. Bennett's herbarium, originating from the following places: from Ben Lawers; from Moidart (Senn Bowald); from Inverness (Loch an Feidh a Maadaith); in the herbarium of the British Museum from W. Sutherland (Sennie) and from Perthshire (Coninish Valley); in the herbarium of the Nat. Hist. Museum of Perth from the Loch na Craige.

the terminal leaves bears 2-7 little teeth, each of which has a tuft of spines. The bud-leaves of *U. intermedia* are similar, but they have broader and more ovate terminal lobes. With *U. ochroleuca* the bud-leaves are followed by several intermediate leaves, which are a transitory form, leading to the typical leaves; out of the axil of the bud-leaves and intermediate leaves underground shoots may come out, which immediately anchor the plant.

I have always found *U. ochroleuca* sterile in the German stations of the Black Forest, in spite of observations extending over several years. The propagation and hibernation is consequently founded, in the first place, on winter-buds. The conditions apparently are the same in Great Britain. In August I found only sterile specimens, when the plant should have flowered. We can assume that not only with *U. ochroleuca*, but also with many other water-plants, the fructificative region is suppressed in consequence of the bud-formation.

### III. GEOGRAPHICAL DISTRIBUTION OF UTRICULARIA OCHROLEUCA IN GREAT BRITAIN.

Up to the present I have found *U. ochroleuca* living in the following stations :

In *Scotland*: In small pools on a roadside between Boat of Garten and Loch Mallachi.

In different places in the Rannoch Moor (Argyle): (a) Loch nan Dubh, (b) Loch nan Mathair Etive, (c) in little pools between the Kings-house Inn and the farm Tighe Craighe-duible.

In *Ireland* I found them very isolated in deep water (about 100 cm.) of the Glendalough (near Recess) mixed with *Eriocaulon*, *Isoetes lacustris* and *echinospora*, *Pilularia*, and *Lobelia*.

As *U. ochroleuca* is also easily to be recognized in a dry condition, I have made a microscopic examination of the material of four English herbaria :

1. From the private herbarium of Mr. Edward S. Marshall at West Monkton near Taunton (Somerset).
2. From the private herbarium of Mr. Arthur Bennett at Croydon (London).
3. From the herbarium of the British Museum.
4. From the herbarium of the Natural History Museum at Perth.

By far the most copious material I found in Mr. Bennett's herbarium and in that of the Natural History Museum at Perth.

On the basis of this investigation the geographical distribution of *U. ochroleuca* takes the following form :

*Scotland.*

*Sutherland*: Near Sennie, W.S. (British Mus.); near Inch-na-damph, W.S.; Badcall, W.S.; pools, moorland of Loch Hope, W.S.; below the east side of Inisay at about 1,000 feet (Marshall's Herb.); Loch an Arni-boll (Bennett's Herb.).

*Ross and Cromarty*: Hillbog, near Garve, at about 900 feet, flowering very sparingly (Marshall's and Bennett's Herb.; British Mus.); Loch Kinellan near Strathpeffer, E.R. (Bennett's Herb.).

*Inverness*: Heath pool at 1,000 feet, Senn Bowald in Moidart (Bennett's Herb.; British Mus.); pool near Dalwhinnie, NW. side of Loch Ericht, E.I.; pond near Dorlin in Moidart (Bennett's Herb.); Loch an Feidh a Maadaith and Loch Aline, near Kincaig (Bennett's Herb.).

*Perth*: Moorland above Crianlarich (Marshall's Herb.); watershed of Coninish Valley (British Mus.); Ben Lawers at 3,200 feet (Bennett's Herb.); Loch Broom; Loch of the Lowes (Dunkeld); Loch Lubnaig; near Loch Skiach (Breadalbane); Dalnaspidal; loch near Meall Cuachlar (Killin); Loch na Craige (Nat. Hist. Mus. at Perth).

*Argyll*: Pools and lochs of Rannoch Moor near Kingshouse (Marshall's and Bennett's Herb.; British Mus.); in a peaty pool near Kingshouse at foot of Stab Dearg (British Mus.); Loch Laidon, Rannoch Moor (Nat. Hist. Mus. at Perth).

*Dumbarton*: Loch Sloy, Glensloy base of Benvoiloch (Bennett's Herb.).

*Wigton*: Near Port Patrick (Bennett's Herb.).

*Kirkcudbright*: Loch Un and Caldoch Moor (Bennett's Herb.).

*Dumfries*: Loch Urr and Glencairn parish (Bennett's Herb.); Glencairn (Girrharrow) (British Mus.).

*England.*

*North Lancashire*: Coniston Lake, growing in water 6–10 feet deep (Marshall's and Bennett's Herb.; British Mus.).

*Dorset*: Talbot Heath, Bournemouth (Marshall's Herb.); Morden Decoy, with flowers (Marshall's and Bennett's Herb.).

*Westmorland*: In a small pool on the watershed between Easdale and Langdale (Bennett's Herb.).

*Ireland.*

*Kerry*: Shallow peat-pools in the Cumm-een-duffim, in several places, but never with flowers (British Mus.).

*Donegal*: Pool Doocharry Bridge (Bennett's Herb.).

*Shetland Isles.*

*Dunrossness*: Pools by Loch of Spiggie (Marshall's Herb.); Loch Brue (Bennett's Herb.).

*Hebrides Isles.*

*Outer Hebrides*: North Uist (British Mus.).

*Inner Hebrides*: Pool near Broadford on Skye; Isle of Islay; east of Loch Fada on the Isle of Colonsay; Isle of Coll; Isle of Tiree (Bennett's Herb.).

As final result the following emerges from the above compilation:

*U. ochroleuca* is a plant widely distributed in Great Britain and the islands about it. *The centre of distribution is in Scotland*; no territory of Europe can show so many stations for *U. ochroleuca* as Scotland. And if from its geographical distribution we consider the conditions of its station the following results: *U. ochroleuca* is a plant adapted to a cold climate, as the Scotch Highlands typically yield, and for that reason *U. ochroleuca* has its chief distribution in Scotland, for which I have indicated about forty localities. On the other hand, *U. intermedia* is a plant adapted to a much warmer climate, and is wont to inhabit low-lying swampy land. *U. intermedia* is therefore not a very rare plant in warm or temperate West Ireland<sup>1</sup> and in the lowlands of England, and there takes the place of *U. ochroleuca*, but in Scotland it is a very rare plant. In fact I could cite *U. intermedia* only for four Scotch places, belonging to Forfarshire and Perthshire: (1) for Rescobie, near Forfar (British Mus.); (2) for Kinclaren (Devonian Perth); (3) for the curling pond, Meurton Wood (Ratray); (4) for a marsh on the east side of Alyth (Nat. Hist. Mus. at Perth).

May this small essay be the means of directing the interest of the English botanists to this up to now neglected water-plant.

To all those who have helped me in the preparation of this article I wish to render here my special thanks; above all to Mr. Edward S. Marshall (Taunton), to Mr. Arthur Bennett (London), to Dr. A. B. Rendle, Keeper of the Herbarium of the British Museum, and to Mr. M. Rodger (Perth).

---

EXPLANATION OF THE FIGURES IN PLATES  
XLVII AND XLVIII.

Illustrating Professor Glück's paper on *Utricularia*.

PLATE XLVII. Figs. 1-8.

Fig. 1. A form of the shallow water from the Konigsveen in Holland. The horizontal green water-shoot bears water-leaves on which here and there isolated bladders occur; besides which two colourless underground shoots ( $s_1$  and  $s_2$ ) are present, the 'leaves' of which all bear bladders. Shoot  $s_1$  is originating from a former rhizoid; the little segments  $l, l$  are former rhizoid segments. The flowering stem is furnished with two flowers and three barren scales (=  $s$ ). Nat. size.

<sup>1</sup> I myself found the true *U. intermedia* in pools between Recess Hotel and Recess Station, near Ballynahinch, and in the Craigga Moor near Roundstown (Connemara).

Fig. 2. Another form of shallow water from the Loch nan Mathair Etive on the Rannoch Moor in Scotland. This form is very similar to that of Fig. 1. Nat. size.

Fig. 3. A floating form growing in deeper water. The internodes of the green water-shoots are elongated and the leaves are longer and more tender than in Figs. 1 and 2. Two isolated bladders are visible on the water-shoot. The two colourless shoots show the tendency to change into water-shoots. From the Loch nan Mathair Etive in Scotland. Nat. size.

Fig. 4. A magnificent form, which floated in moderately deep water; the horizontal water-shoot bears three isolated bladders. The two vertical shoots represent, as they are not fixed in the mud, a transition to water-shoots. From little pools near Boat of Garten. Nat. size.

Fig. 5. A water-shoot of *U. intermedia* bearing a winter-bud at the top, whilst its axis is covered with many intermediate leaves, the terminal segments of which are distinctly denticulated. From Norfolk (Barton Turf). Nat. size.

Figs. 6-8. Rhizoid formations.

Fig. 6. Base of the flowering stem with a very long rhizoid of *U. ochroleuca*, originating from the Konigsveen in Holland. R = rhizoid; s = dissected subterranean shoot; w = water-shoot; F = flowering stem.

Fig. 7. A lateral segment of the middle region of the same rhizoid; it is repeatedly furcate and terminates in eight bent and papillous terminal segments.  $\times 20$ .

Fig. 8. A very little segment coming from the highest region of the rhizoid, and which terminates in three papillous segments.  $\times 20$ .

PLATE XLVIII. Figs. 9-19.

Fig. 9-12. Flower-forms of *U. ochroleuca*.

Fig. 9. Illustrates a flower, side-view; the spur (*s*) is to be seen conspicuously; the lower lip is rather flat.  $\times 4$ .

Fig. 10. Also illustrates a side-view; the lower lip is slightly curved in saddle-form, the spur therefore being covered.  $\times 4$ .

Fig. 11. A front-view of the flower; before the upper lip the globose palate is visible; the lower lip is rather flat, and below this the spur can be seen.  $\times 4$ .

Fig. 12. Gives a view of the flower from underneath. The spur appears as a prolongation of the upper lip and overlaps the entrance to the palate; the two-lipped calyx is visible from below.  $\times 4$ .

In all figures *k* = calyx; *o* = upper lip; *u* = lower lip; *p* = palate; *s* = spur.

Figs. 13-15. Flowers of *U. intermedia*.

Fig. 13. Illustrates a lateral view of the flower. The lower lip is slightly curved in saddle-form and therefore covers the spur, the point of which, however, penetrates below.

Fig. 14. Front side of the flower. Through the tender—and in consequence of the action of the alcohol—now transparent lower lip the spur can be faintly seen; the palate is scalloped a little at the top; the two anthers are visible in the form of two little dark spots.

Fig. 15. Demonstrates a flower from below. The long spur appears also here as a continuation of the upper lip, and projects over the entrance to the palate; the lower lip is slightly curved downwards.

Figs. 13-15 are  $\times 4$ . The flowers originate from Wallisellen near Zürich (Switzerland); *k* = calyx; *o* = upper lip; *u* = lower lip; *p* = palate; *s* = spur.

Fig. 16. A leaf of *U. ochroleuca*, furnished with a bladder. From shallow water near Boat of Garten (Scotland).  $\times 4$ .

Fig. 17. A bladderless and very richly branched water-leaf of *U. ochroleuca*, originating from shallow water. From the Loch nan Mathair Etive.  $\times 4$ .

Fig. 18. A leaf furnished with a bladder, originating from a floating form of deeper water. From the Loch nan Mathair Etive.  $\times 4$ .

Fig. 19. A water-leaf of *U. intermedia* bearing a bladder on the lower right side. From Norfolk (Honing, East Norfolk).  $\times 4$ .





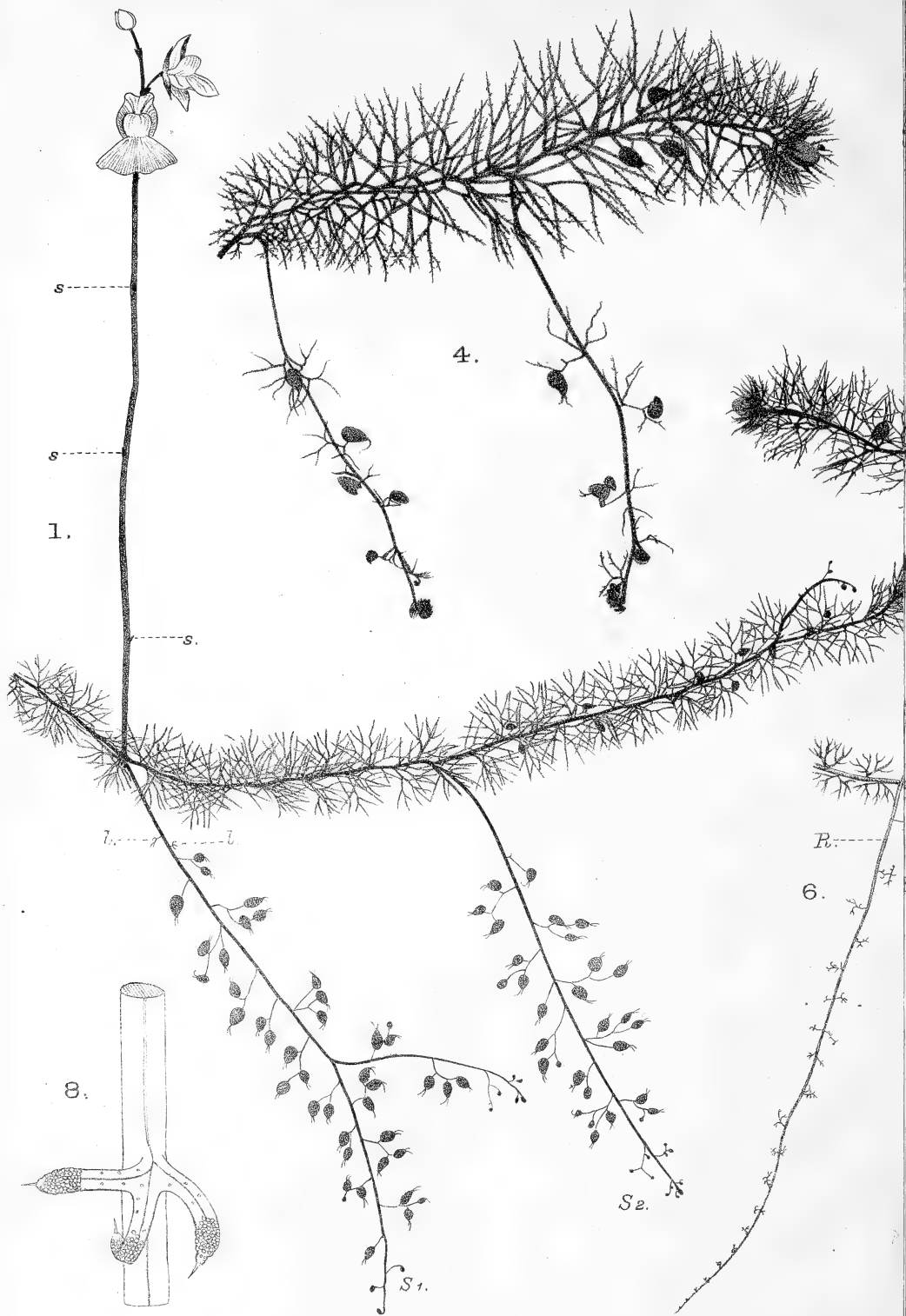

GLÜCK — UTRICULARIA.

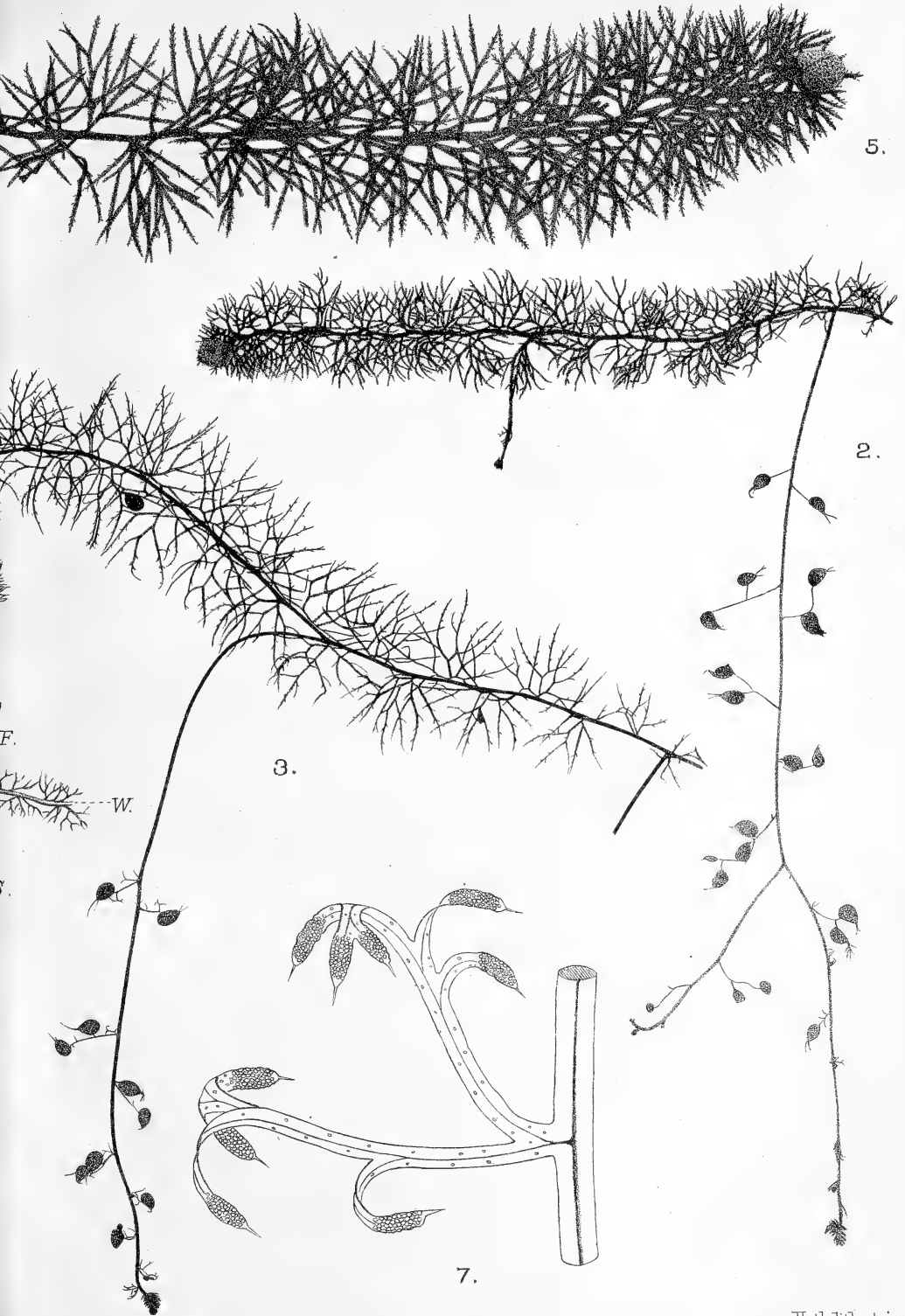



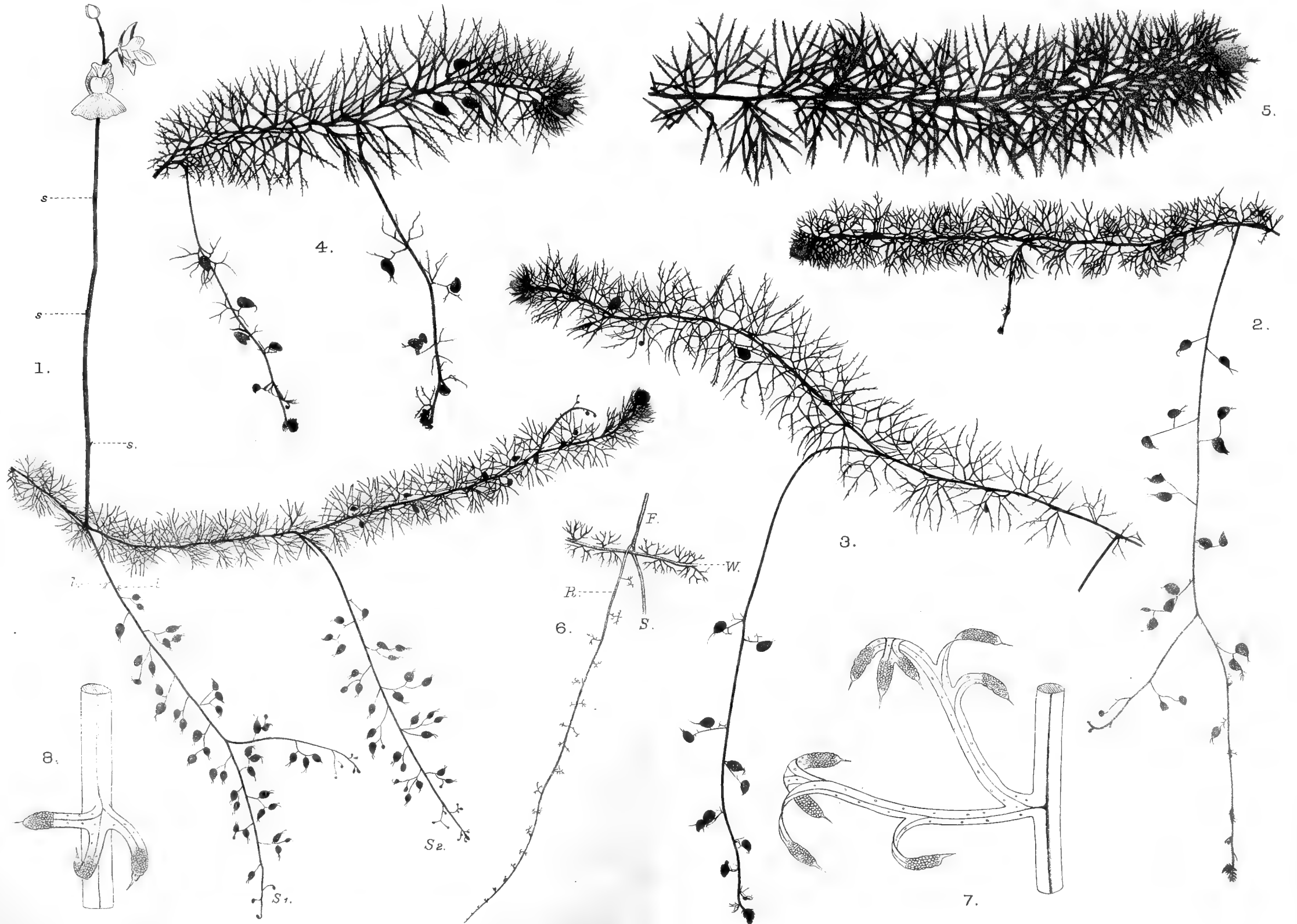

GLÜCK — UTRICULARIA.





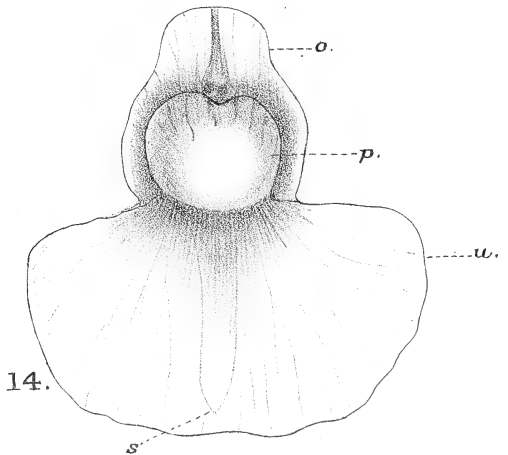
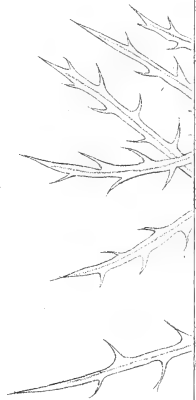
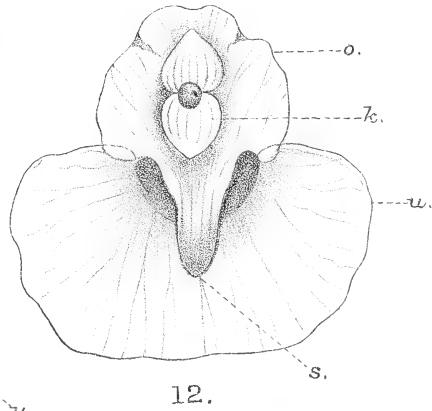
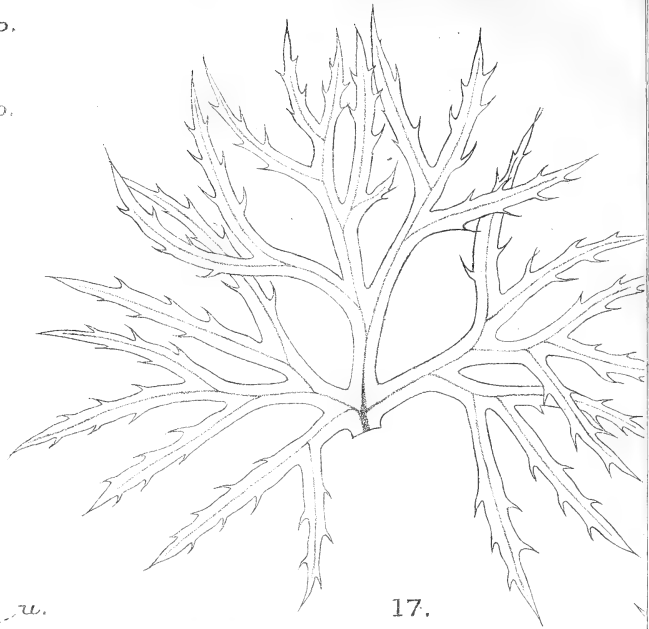
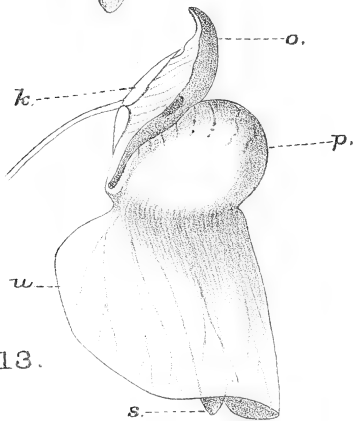
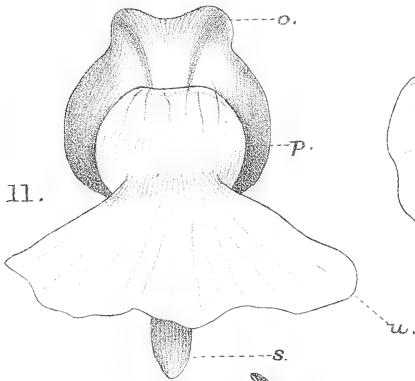
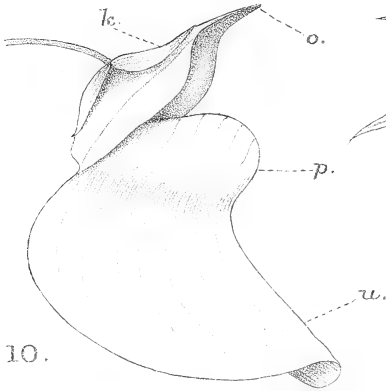
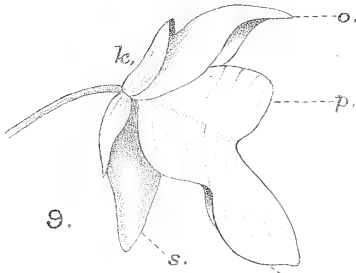



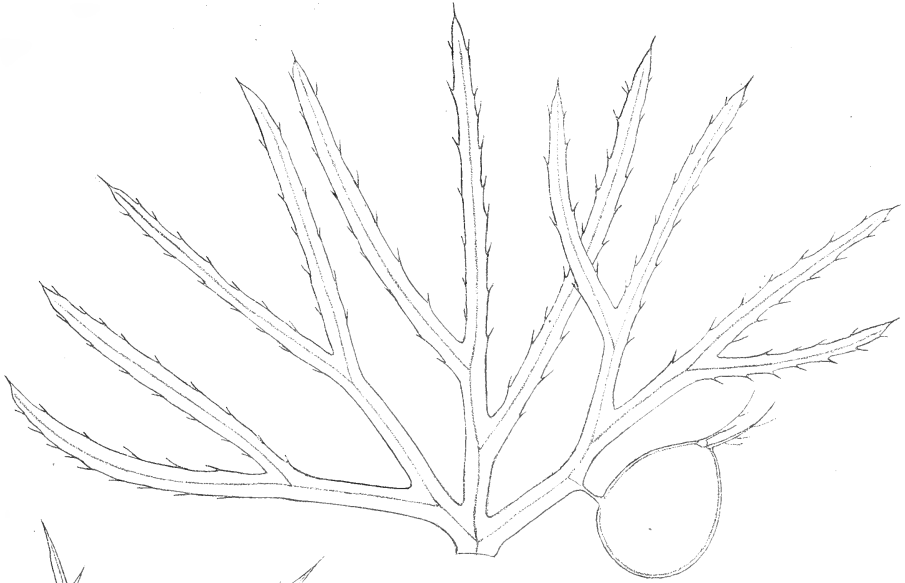

19.

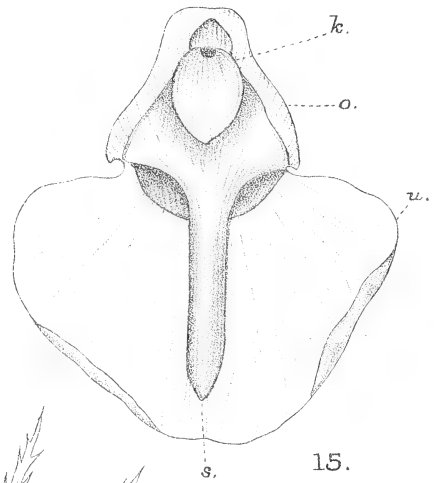
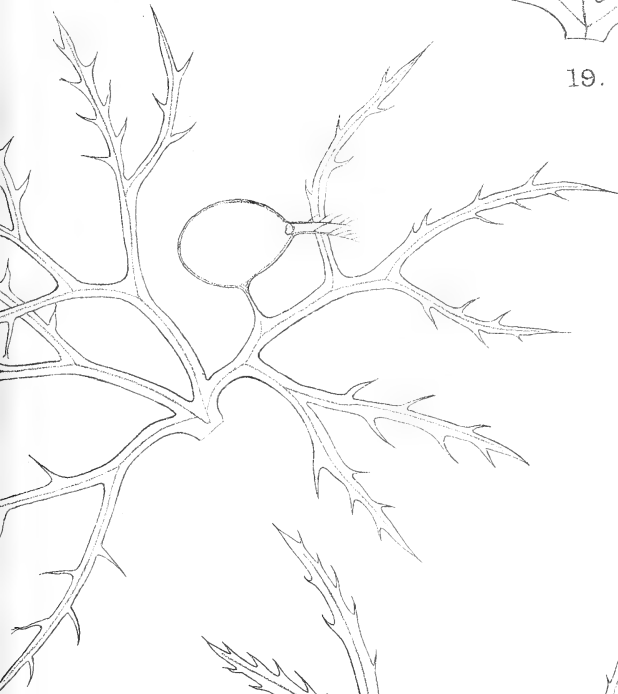

15.

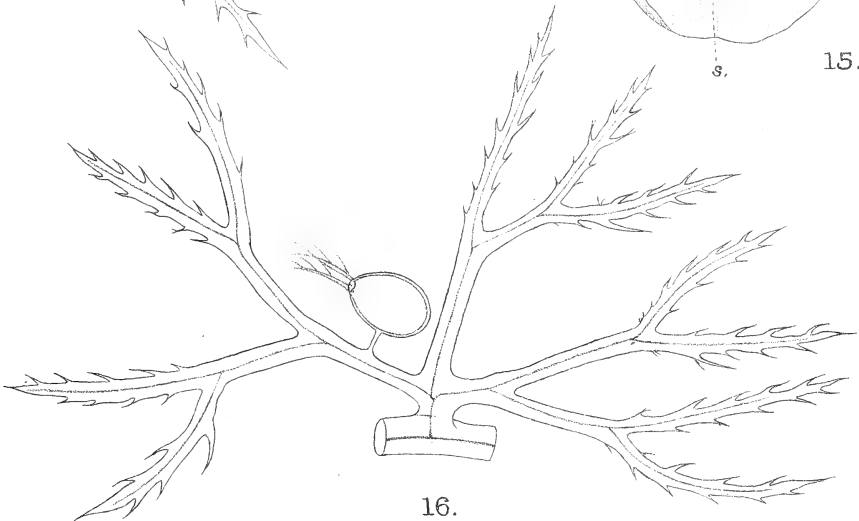

16.



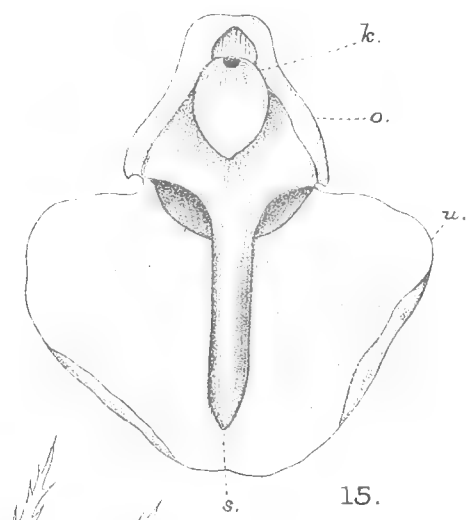
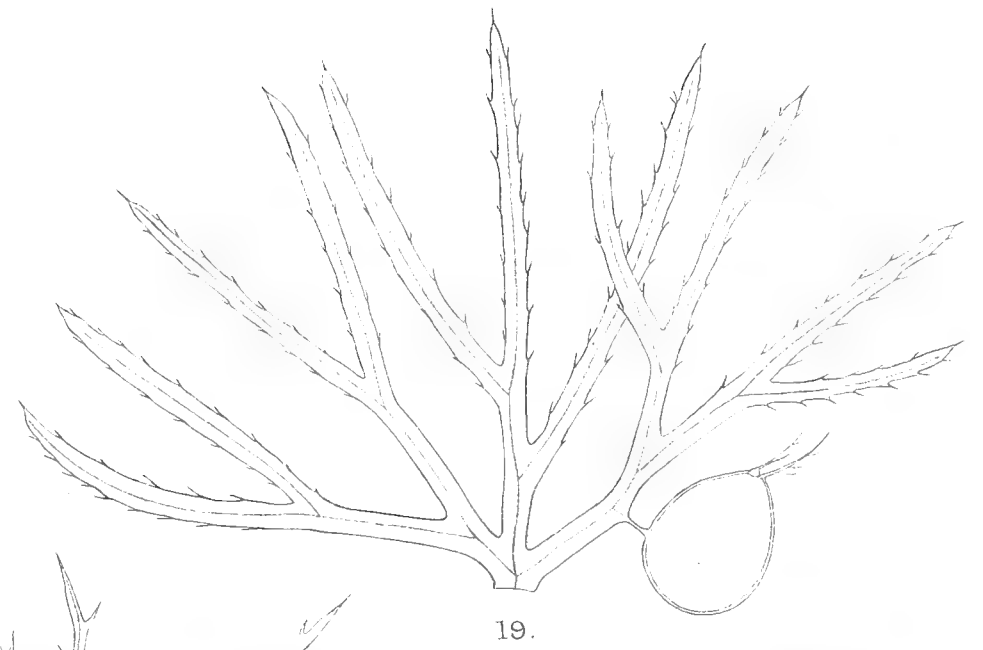
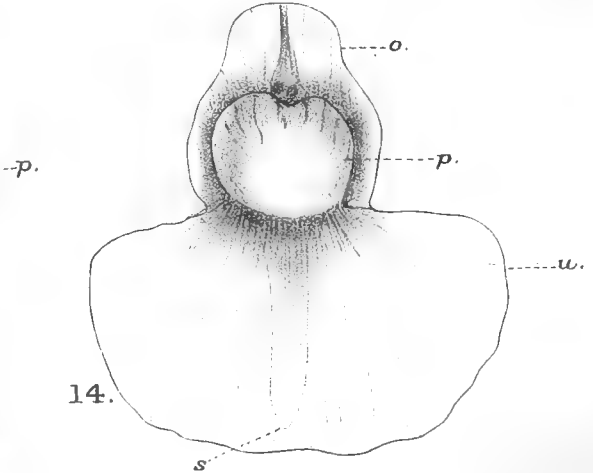
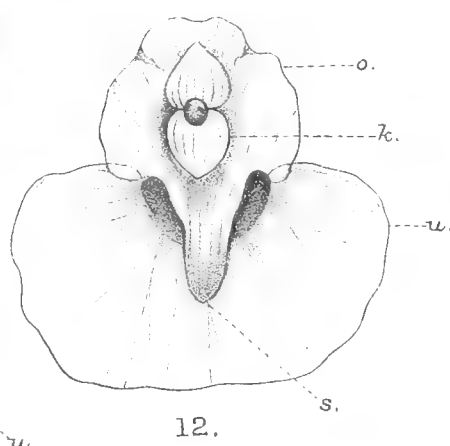
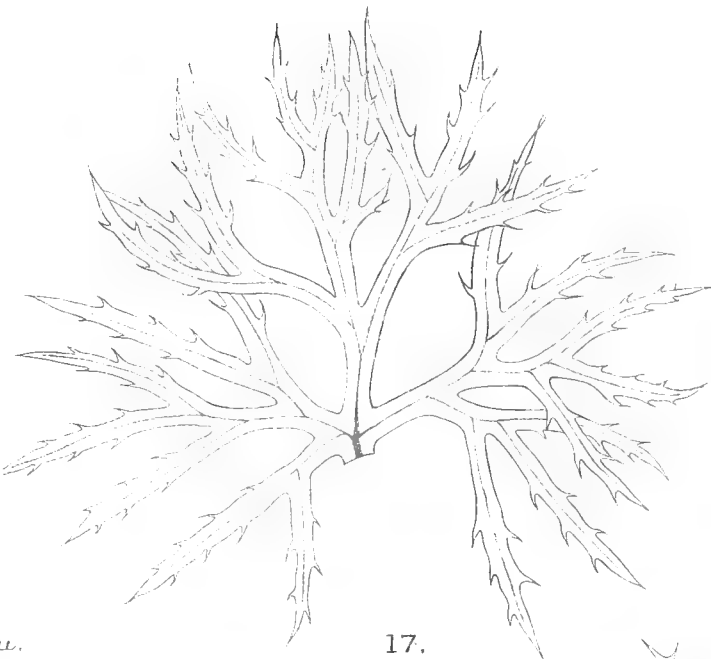
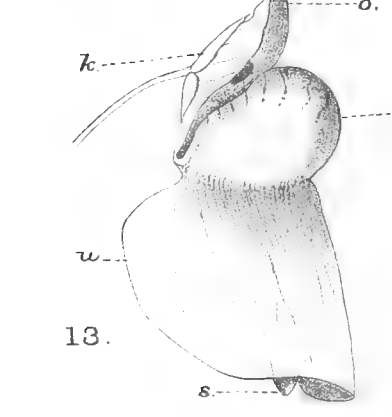
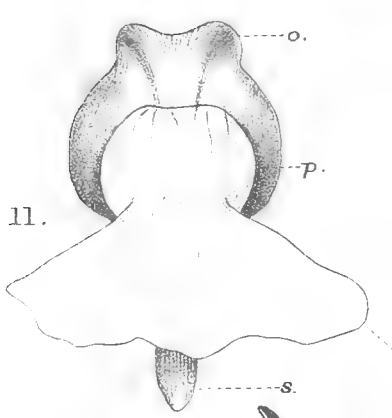
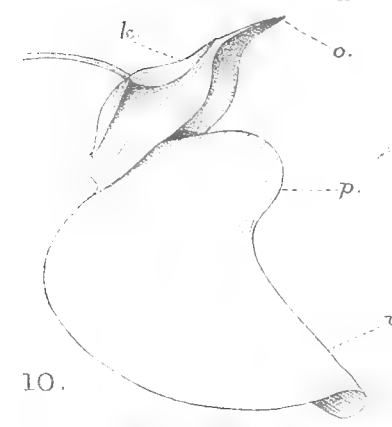
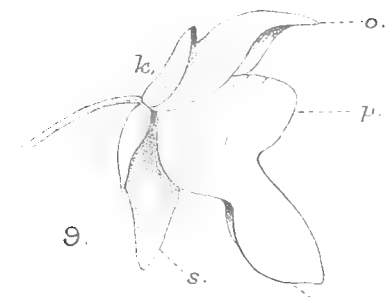

GLÜCK — UTRICULARIA.



# Defoliation: its Effects upon the Growth and Structure of the Wood of Larix.

BY

ALAN G. HARPER, B.A.,

*Demonstrator in the School of Rural Economy, Oxford.*

With Plates **XLIX** and **L** and two Figures in the Text.

## INTRODUCTION.

THE larch trees investigated had been defoliated for several years in succession by larvae of the large larch Sawfly (*Nematus erichsoni*). This pest, which since 1882 has killed nearly every larch in the Adirondacks, was suddenly reported from the English Lake District. The first mention of its presence was in September, 1906, in a memorandum of the Board of Agriculture reporting damage done by it there during that summer. It had begun its ravages there, however, as early as 1904,<sup>1</sup> and was reported from Wales and Ayrshire in 1907. Since then it has done an enormous amount of damage to larch plantations in the Lake District and in Wales, and in 1910 it was scheduled under the Destructive Insects and Pests Order of the Board of Agriculture and Fisheries. Not only the European Larch, but also the more recently introduced Japanese species (*Larix leptolepis*) is attacked. The nature of the damage is as follows: the larvae, emerging in early June from eggs laid a week earlier in the cortical tissues of the terminal shoots of the branches, work their way down towards the main trunk, eating every leaf as they proceed. In three or four weeks' time they drop to the ground to spin cocoons in the moss, leaving the tree completely or in part defoliated and with the terminal shoots in which the eggs were laid withered. Sometimes, however, a second flush of leaves is produced upon the spur shoots towards the end of the summer, but these are liable to injury from early frosts. The cocoons hatch out next May, and the process may be repeated year after year until the tree becomes weaker and weaker and ultimately dies for lack of nourishment.<sup>2</sup>

In so far as its green leaves are the seat of photosynthesis their untimely removal must affect the food supply of a plant. In spring, when the winter buds of trees unfold, the plastic reserves, stored up during the preceding summer, are drawn upon not only for the material of the leaf tissues itself, but also to keep up the active metabolism necessary for supplying sufficient energy or osmotic substances necessary for the actual expansion of the growing cells. That the source of this growth-energy is

<sup>1</sup> MacDougall.

<sup>2</sup> For further details cp. the papers of MacDougall, Hewitt, and Annand.

the consumption of a considerable quantity of material has been shown clearly by the fact that growing trees actually lose in dry weight while their leaves are expanding from the winter buds, especially in the case of deciduous trees like the larch.<sup>1</sup> The unfolding of the leaves, therefore, represents the expenditure of capital, and if they are lost early in the season, before an adequate interest may have accumulated, the resources of the plant are diminished. The primary physiological effect of an early defoliation is a more or less severe degree of starvation.

Accordingly, most of the facts recorded in this paper are purely starvation phenomena. Slow starvation of a growing tree is met by economy in expending the formative materials, and in the woody cylinder this may be expressed in two distinct ways: firstly, by a reduction in the *amount* of growth; secondly, by a decrease in the proportion of 'mechanical tissues'; for thick-walled fibrous cells require in their formation more material than an equivalent development of thin-walled, water-conducting tracheides, and are of less immediate importance to the tree. The amount of growth is indicated by the breadth of the annual ring, and in timber so simple in structure as that of the larch, the thick-walled tissue is, generally speaking, identical with the zone of so-called autumn wood.<sup>2</sup> Therefore both the ring-breadth and the development of autumn wood must be considered in dealing with the effects of defoliation.

The trees to be investigated were felled in October and November, 1911, after growth for that year had ceased. Complete cross-sections of the trunk were sawn out at equal distances apart, every four or five feet as the case might be. (In the tables these sections are numbered successively from the base of the tree upwards.) From each section a small rectangular block from 8 to 12 mm. broad was cut out at the circumference opposite to each of the four points of the compass, N., S., E., and W., the north side of the tree having been marked before felling and shown by an arrow on the surface of each section as it was cut out of the trunk. From the surface of each block was cut a thin, transparent shaving for microscopic examination and measurement, and the breadth of each annual ring as a whole and of its zone of autumn wood taken separately was measured along three different radii separated tangentially by a mean distance of 2-5 mm. Thus three sets of measurements were made for each little block, making twelve in all for each complete cross-section of the trunk, and the average of the twelve is taken as the mean radial increment for the tree at any particular height from the ground at which a cross-section may have been made.

<sup>1</sup> Ramann and Bauer, p. 67.

<sup>2</sup> It need scarcely be remarked that this so-called 'autumn wood' is not formed in the autumn, and on the other hand the 'spring wood' is being made during the first half of the summer. There is therefore little to be gained by changing the term 'Herbstholz' into 'Sommerholz', as has been done by Hartig, and since a translation of Strasburger's still more suggestive expression 'Spätholz' is not yet generally used in this country, the terms 'spring wood' and 'autumn wood' are employed throughout this paper (cp. Hartig (1), p. 13, and (3) p. 276; Strasburger, p. 501).

The tables I-VII show the results of some of these measurements, expressed in millimetres. Originally they were carried to two or even three places of decimals, like Schwarz's measurements for *Pinus sylvestris*.<sup>1</sup> It was found, however, that the three parallel measurements of each little block varied so much among themselves, owing to the wavy character of the annual rings, that figures beyond the first place of decimals were valueless, a point which Schwarz seems to have missed through taking only a single measurement in each of the four directions of the compass, instead of three in each direction, as has been done for the purpose of these tables.<sup>2</sup> Even in a normally grown tree like the forty-five year old larch of Table I, which had never been attacked by the Sawfly, the 'limit of error' was found to be so great as to exclude quantities smaller than one-tenth of a millimetre. This is shown by Table II, from the same tree, where the numbers are expressed as fiftieths of millimetres, reaching consequently to the second place of decimals. It has been mentioned that three parallel measurements were made in each of the four directions of the compass, making a total of twelve for each complete section of the trunk. Series 1 of Table II shows the greatest difference of any measurement from the mean of all the three taken in that same direction. The mean of these differences for the thirteen separate sections of the trunk and averaged over a period of six years is 0.15 mm. for the ring-breadth and 0.16 mm. for the autumn wood. Perhaps Series 2 of the same table gives a truer idea of the exact degree of irregularity of the rings. It shows the greatest difference between any one of the twelve measurements and the mean of them all, and the 'limit of error' so obtained and averaged, as in Series 1, for the whole tree during six years is about half as much as before—0.09 mm. for the ring-breadth and 0.08 mm. for the autumn wood.

TABLE I. SPECIMEN TREE A.  
Height of tree, 68 feet. Sections taken every 5 feet from the base.

(a) RING-BREADTH IN MILLIMETRES.

	1911.	1910.	1909.	1908.	1907.	1906.	<i>Average of six years.</i>
Section 13	2.0	2.2	1.8	1.8	1.9	1.1	1.8
„ 12	1.7	2.2	2.5	2.3	2.5	1.9	2.2
„ 11	1.9	2.0	1.9	2.1	2.5	2.1	2.1
„ 10	1.5	2.0	1.8	1.9	2.1	1.8	1.9
„ 9	1.2	1.4	1.6	1.7	1.9	1.6	1.6
„ 8	0.9	1.1	1.2	1.4	1.6	1.5	1.3
„ 7	0.8	0.8	1.1	1.2	1.2	1.4	1.1
„ 6	0.7	0.9	0.9	0.9	1.0	1.1	0.9
„ 5	0.6	0.7	0.7	0.8	0.9	1.3	0.8
„ 4	0.6	0.5	0.5	0.6	0.8	1.2	0.7
„ 3	0.5	0.6	0.8	0.6	0.8	1.1	0.7
„ 2	0.6	0.6	0.8	0.4	0.9	1.1	0.7
„ 1	0.6	0.7	0.8	1.0	1.1	1.4	0.9
<i>Average of thirteen sections.</i>	1.0	1.2	1.2	1.3	1.5	1.4	1.3

<sup>1</sup> Schwarz.

<sup>2</sup> Schwarz, p. 5.

## (b) AUTUMN WOOD %.

	1911.	1910.	1909.	1908.	1907.	1906.	Average of six years.
Section 13	60	50	50	60	30	40	50
„ 12	60	50	50	50	60	50	50
„ 11	70	60	60	60	60	60	60
„ 10	60	60	50	50	50	40	50
„ 9	50	40	40	40	40	40	40
„ 8	60	50	50	40	40	40	50
„ 7	60	50	50	50	50	40	50
„ 6	50	40	60	70	60	50	50
„ 5	70	60	60	60	60	60	60
„ 4	50	60	60	70	50	50	60
„ 3	60	70	60	70	60	50	60
„ 2	70	70	60	70	60	50	60
„ 1	50	60	50	60	50	50	60
Average of thirteen sections.	60	60	50	50	50	50	50

TABLE II a. VARIABILITY OF RING-BREADTH, IN MILLIMETRES.

Series 1. Greatest difference of any one reading from the mean of the three taken close together at that point.

	1911.	1910.	1909.	1908.	1907.	1906.	Mean.
Section 13	0.24	0.14	0.14	0.16	0.20	0.06	0.16
„ 12	0.14	0.20	0.38	0.18	0.40	0.10	0.23
„ 11	0.46	0.26	0.30	0.34	0.22	0.46	0.34
„ 10	0.12	0.24	0.12	0.24	0.26	0.08	0.18
„ 9	0.14	0.18	0.08	0.08	0.12	0.10	0.12
„ 8	0.02	0.10	0.08	0.16	0.10	0.06	0.09
„ 7	0.08	0.06	0.06	0.08	0.08	0.06	0.07
„ 6	0.06	0.08	0.10	0.06	0.22	0.12	0.11
„ 5	0.08	0.10	0.08	0.06	0.08	0.08	0.08
„ 4	0.12	0.12	0.06	0.12	0.12	0.06	0.10
„ 3	0.06	0.16	0.04	0.12	0.28	0.10	0.13
„ 2	0.06	0.20	0.14	0.22	0.14	0.20	0.16
„ 1	0.10	0.06	0.08	0.06	0.18	0.18	0.11
Average of thirteen sections.	0.13	0.15	0.13	0.14	0.19	0.13	0.15

Series 2. Greatest difference of any single reading from the mean of the twelve taken all round the tree.

	1911.	1910.	1909.	1908.	1907.	1906.	Mean.
Section 13	0.15	0.08	0.10	0.10	0.13	0.06	0.10
„ 12	0.12	0.14	0.19	0.10	0.17	0.10	0.14
„ 11	0.26	0.16	0.13	0.17	0.16	0.19	0.18
„ 10	0.10	0.10	0.05	0.11	0.11	0.05	0.09
„ 9	0.06	0.08	0.06	0.06	0.08	0.05	0.07
„ 8	0.02	0.07	0.07	0.09	0.07	0.05	0.06
„ 7	0.06	0.04	0.04	0.05	0.06	0.04	0.05
„ 6	0.04	0.05	0.05	0.05	0.09	0.06	0.06
„ 5	0.06	0.06	0.06	0.05	0.05	0.05	0.06
„ 4	0.06	0.10	0.05	0.05	0.07	0.05	0.06
„ 3	0.04	0.09	0.03	0.10	0.11	0.09	0.08
„ 2	0.06	0.10	0.10	0.10	0.10	0.10	0.09
„ 1	0.04	0.04	0.05	0.05	0.11	0.13	0.07
Average of thirteen sections.	0.08	0.09	0.08	0.08	0.10	0.08	0.09



TABLE II*b*. VARIABILITY IN BREADTH OF AUTUMN WOOD.

Series 1. Greatest difference of any one reading from the mean of the three taken close together at that point.

	1911.	1910.	1909.	1908.	1907.	1906.	Mean.
Section 13	0.32	0.30	0.16	0.26	0.56	0.14	0.29
" 12	0.28	0.18	0.42	0.24	0.68	0.04	0.31
" 11	0.56	0.32	0.20	0.24	0.20	0.48	0.33
" 10	0.28	0.36	0.28	0.16	0.34	0.08	0.25
" 9	0.14	0.14	0.18	0.10	0.12	0.04	0.12
" 8	0.06	0.06	0.08	0.12	0.08	0.06	0.08
" 7	0.08	0.06	0.08	0.10	0.06	0.08	0.08
" 6	0.14	0.12	0.02	0.06	0.14	0.16	0.11
" 5	0.08	0.08	0.04	0.08	0.10	0.12	0.08
" 4	0.10	0.08	0.02	0.08	0.10	0.26	0.11
" 3	0.02	0.12	0.06	0.10	0.04	0.12	0.08
" 2	0.04	0.20	0.12	0.20	0.06	0.04	0.11
" 1	0.06	0.08	0.08	0.10	0.08	0.16	0.09
<i>Average of thirteen sections.</i>	0.17	0.16	0.13	0.14	0.20	0.14	0.16

Series 2. Greatest difference of any single reading from the mean of the twelve taken all round the tree.

	1911.	1910.	1909.	1908.	1907.	1906.	Mean.
Section 13	0.15	0.12	0.07	0.16	0.25	0.08	0.14
" 12	0.12	0.08	0.27	0.18	0.25	0.04	0.16
" 11	0.25	0.16	0.12	0.12	0.13	0.19	0.16
" 10	0.14	0.18	0.15	0.09	0.14	0.06	0.13
" 9	0.09	0.06	0.10	0.06	0.11	0.04	0.08
" 8	0.02	0.04	0.05	0.06	0.03	0.04	0.04
" 7	0.06	0.03	0.05	0.06	0.04	0.05	0.05
" 6	0.07	0.05	0.02	0.03	0.05	0.09	0.05
" 5	0.06	0.05	0.03	0.04	0.05	0.10	0.05
" 4	0.05	0.07	0.02	0.04	0.05	0.11	0.06
" 3	0.02	0.08	0.05	0.07	0.04	0.07	0.05
" 2	0.03	0.07	0.07	0.08	0.04	0.04	0.06
" 1	0.03	0.05	0.05	0.05	0.07	0.09	0.06
<i>Average of thirteen sections.</i>	0.08	0.08	0.08	0.08	0.10	0.08	0.08

TABLE III. TREE B.

Height of tree, 69 feet. Sections every 5 feet from the base up.

(a) RING-BREADTH IN MILLIMETRES.

	1911.	1910.	1909.	1908.	1907.	1906.	<i>Average of six years.</i>
Section 13	1.4	1.1	0.9	1.4	1.8	1.9	1.4
" 12	1.9	1.7	1.2	1.2	2.2	2.3	1.8
" 11	1.5	1.4	1.1	0.9	2.3	2.4	1.6
" 10	1.6	1.5	1.2	0.9	2.1	1.8	1.5
" 9	1.4	1.0	0.6	0.6	1.8	1.2	0.9
" 8	0.8	0.6	0.5	0.6	1.7	1.4	0.9
" 7	0.6	0.4	0.4	0.5	1.4	1.6	0.8
" 6	0.4	0.3	0.3	0.4	1.5	1.5	0.7
" 5	0.4	0.4	0.3	0.5	1.5	1.7	0.8
" 4	0.5	0.2	0.3	0.4	1.6	1.8	0.8
" 3	0.4	0.1	0.2	0.3	1.6	1.8	0.7
" 2	0.3	0.1	0.2	0.3	1.4	1.7	0.7
" 1	0.6	0.5	0.2	0.4	1.4	2.1	0.9
<i>Average of thirteen sections.</i>	0.9	0.7	0.6	0.6	1.7	1.8	1.0

## (b) AUTUMN WOOD %.

	1911.	1910.	1909.	1908.	1907.	1906.
Section 13	50	60	70	40	a <sup>2</sup>	40
" 12	60	60	60	40	a	50
" 11	50	50	50	30	a	40
" 10	40	50	50	30	a	50
" 9	50	60	50	30	a	30
" 8	50	50	40	30	a	40
" 7	30	30	30	20	a	40
" 6	50	40	30	30	a	40
" 5	50	30	30	20	a	40
" 4	40	50	30	30	a	40
" 3	50	50 <sup>1</sup>	50	30	a	50
" 2	70	50 <sup>1</sup>	50	30	a	50
" 1	50	60	50	50	a	50
<i>Average of thirteen sections.</i>	50	50	50	30	a	40

TABLE IV. TREE C.

Height of tree, 35 feet. Sections every 4 feet from the base up.

## (a) RING-BREADTH IN MILLIMETRES.

	1911.	1910.	1909.	1908.	1907.	1906.
Section 8	0.1	0.9	1.6	1.2	3.2	4.1
" 7	0.2	0.9	0.9	0.7	3.2	4.6
" 6	0.3	0.7	0.6	0.6	3.6	5.7
" 5	0.5	0.4	0.3	0.5	3.7	5.3
" 4	—	0.2	0.2	0.5	3.5	5.4
" 3	—	0.1	0.1	0.4	3.2	4.5
" 2	—	0.1	0.1	0.3	2.8	4.2
" 1	—	0.1	0.1	0.3	2.5	4.8
<i>Average of eight sections.</i>	0.1	0.4	0.5	0.6	3.2	4.8

## (b) AUTUMN WOOD %.

	1911.	1910.	1909.	1908.	1907.	1906.
Section 8	50	60	80	a	a	10
" 7	100	70	80	a	a	20
" 6	30	70	70	a	a	30
" 5	100	80	30	a	a	30
" 4	—	100	50	a	a	30
" 3	—	50	50	a	a	50
" 2	—	—	—	a	a	40
" 1	—	—	—	a	a	40
<i>Average of eight sections.</i>	30	50	50	a	a	30

<sup>1</sup> As these measurements are approximated to the first place of decimals (p. 623), the autumn wood is not expressed at all when it is less than 0.05 mm. in breadth. When more than 0.05 mm. broad the autumn wood would be expressed as 0.1 mm., so that when the whole ring-breadth sinks to 0.1 mm. (as in the cases marked thus <sup>1</sup>) these tables can no longer express the percentage of autumn wood. An assumption of 50 per cent. has been made in such cases, and the error so caused is a slight one when averaged for the whole tree.

<sup>2</sup> The letter 'a' is used in these tables to signify that the autumn wood is abnormal in that its cell-walls are not properly thickened, at least towards the boundary of the ring. In such cases measurements would be misleading.

TABLE V. TREE D.

Height of tree, 38 feet. Sections every  $5\frac{1}{2}$  feet from the base upwards.

## (a) RING-BREADTH IN MILLIMETRES.

	1911.	1910.	1909.	1908.	1907.	1906.	1905.	1904.
Section 7	2.4	1.3	1.6	3.0	3.5	4.2	4.7	3.8
„ 6	2.9	1.0	1.6	3.4	4.2	4.7	5.0	4.7
„ 5	3.9	1.2	1.5	4.5	3.9	4.7	5.3	5.4
„ 4	1.9	0.6	0.8	2.0	3.1	4.0	4.6	4.8
„ 3	0.9	0.3	1.0	1.8	2.6	3.2	4.1	4.9
„ 2	0.5	0.2	0.7	2.1	2.5	2.8	4.2	4.8
„ 1	0.4	0.1	0.7	2.7	3.1	3.0	6.0	6.1
<i>Average of seven sections.</i>	1.8	0.7	1.0	2.8	3.3	3.8	4.8	4.9

## (b) AUTUMN WOOD %.

Section 7	30	50	—	—	20	20	30	40
„ 6	40	50	—	—	30	30	30	20
„ 5	30	50	—	—	30	40	30	30
„ 4	50	30	—	—	40	40	30	30
„ 3	60	30	—	—	40	50	30	30
„ 2	40	50	—	—	30	40	30	30
„ 1	50	50	—	—	20	30	30	20
<i>Average of seven sections.</i>	40	40	—	—	30	40	30	30

TABLE VI. TREE E.

Height of tree, 37 feet. Sections every  $5\frac{1}{2}$  feet from the base up.

## (a) RING-BREADTH IN MILLIMETRES.

	1911.	1910.	1909.	1908.	1907.	1906.
Section 6	0.3	0.3	0.7	3.1	4.2	4.8
„ 5	—	0.1	0.6	3.2	3.6	4.1
„ 4	—	—	0.5	2.7	2.7	3.8
„ 3	—	—	0.4	2.1	2.3	2.9
„ 2	—	—	0.2	2.1	2.2	2.6
„ 1	—	—	—	1.5	1.7	3.2
<i>Average of six sections.</i>	—	—	0.4	2.5	2.8	3.6

## (b) AUTUMN WOOD %.

Section 6	30	30	a	a	40	40
„ 5	—	—	a	a	40	50
„ 4	—	—	a	a	40	50
„ 3	—	—	a	a	40	50
„ 2	—	—	a	a	50	50
„ 1	—	—	a	a	50	60
<i>Average of six sections.</i>	—	—	a	a	40	50

TABLE VII. TREE F.

Height of tree, 45 feet. Sections every  $5\frac{1}{2}$  feet from the base up.

## (a) RING-BREADTH IN MILLIMETRES.

	1911.	1910.	1909.	1908.	1907.	1906.	1905.	1904.
Sections 8	0.6	0.3	0.5	1.1	1.4	1.8	2.2	2.5
" 7	—	0.2	0.4	0.5	0.9	2.1	2.8	2.8
" 6	—	—	0.2	0.2	0.6	1.7	2.5	2.8
" 5	—	—	0.2	0.2	0.6	1.6	2.5	2.7
" 4	—	—	—	0.1	0.6	1.8	2.2	2.2
" 3	—	—	—	0.1	0.6	1.5	2.3	2.2
" 2	—	—	—	0.1	0.6	1.8	2.6	2.6
" 1	—	—	—	0.2	1.1	2.9	4.0	3.6
<i>Average of eight sections.</i>	—	—	0.1	0.3	0.8	1.9	2.6	2.7

## (b) AUTUMN WOOD %.

Section 8	70	30	a	a	a	a	60	50
" 7	—	—	a	a	a	a	40	50
" 6	—	—	—	—	a	a	30	30
" 5	—	—	—	—	a	a	40	40
" 4	—	—	—	—	a	a	30	40
" 3	—	—	—	—	a	a	40	40
" 2	—	—	—	—	a	a	30	40
" 1	—	—	—	—	a	a	30	40
<i>Average of eight sections.</i>	—	—	—	—	a	a	40	40

TABLE VIII. TREE C (TABLE IV).

RING-BREADTH (given to the nearest 0.05 mm.).

		1911.	1910.	1909.	1908.	1907.	1906.
Section 8.	N. <sup>1</sup>						
	S.	0.05	0.80	1.70	1.25	3.40	4.50
	E.	0.20	0.60	1.25	1.00	3.15	3.60
	W.	0.10	1.15	1.95	1.35	3.05	— <sup>2</sup>
Section 7.	N.	0.10	1.00	0.09	0.55	2.30	3.20
	S.	0.05	1.15	1.00	0.85	4.20	5.85
	E.	0.00	0.50	0.90	0.60	3.50	5.02
	W.	0.60	0.75	0.90	0.60	2.85	4.15
		AUTUMN WOOD %.					
		1911.	1910.	1909.	1908.	1907.	1906.
Section 8.	N. <sup>1</sup>						
	S.	30	70	90	a	a	10
	E.	80	70	80	a	a	10
	W.	0.00	50	50	a	a	— <sup>2</sup>
Section 7.	N.	20	70	80	a	a	30
	S.	0.00	70	70	a	a	20
	E.	0.00	40	70	a	a	20
	W.	90	70	70	a	a	20

## I. EFFECT ON THE ANNUAL INCREMENT.

Looking back into the history of the trees as recorded in the annual growth-rings of the woody cylinder, the first indication of defoliation by the

<sup>1</sup> This section was damaged, so that no measurements could be taken on the north side.

<sup>2</sup> No measurement made at this point.

Sawfly larvae is the striking absence of the strongly thickened tracheides that usually occur as the zone of 'autumn wood' at the close of the year's growth (Pl. XLIX, Figs. 1, 2, and 3). At first, perhaps, there is no significant decrease in the ring-breadth itself, but subsequent years show much narrower rings, with, however, in some cases a fair proportion of normally thickened autumn wood (Figs. 1, 2, and 4). It is this absence of thickened cells from the first ring to show the attack that gives the date of subsequent rings in those parts of a tree where the cambium has ceased to function a year or two before the trees were felled. For, as will be mentioned later, some of the trees ceased growth at the base of the trunk while they still formed rings year after year in the crown. In the crown there is a ring formed every year till the death of the tree, so, counting from the first ring to show no autumn wood at the top of the tree, it is possible to compare any subsequent ring with the corresponding growth for the same period lower down the trunk.

As might be expected, these starvation effects are most in evidence towards the base of the tree, for there the growth is normally less energetic than up in the crown. But the ring-breadth itself cannot be taken as a measure of comparison of the growth intensity at different heights up the trunk, since the circumference is of greater or less extent according as the section is taken close to or far from the ground. The ring-breadths in these tables are given for a comparison of the growth in different years at the same height, not that of the same year at different heights. For comparing the amount of growth at different heights the superficial *area* of the whole ring in cross-section of the trunk would be required, the 'Flächenzuwachs' of German foresters. This 'Flächenzuwachs' varies in different parts of a normal tree according to definite rules.<sup>1</sup> In the crown, for instance, the 'Flächenzuwachs' increases the farther down one gets from the top, but in the branchless part of the trunk it usually decreases steadily towards the base, where it suddenly increases again to form the so-called 'root-stock'. If the tree grows alone in the open its lower branches do not drop off, and the tree is consequently all crown. Physiologically, at least, it is in a similar condition if through the felling of its neighbours it is relieved of competition and placed in circumstances exceptionally favourable to energetic assimilation. In either case the growth-intensity, as measured by the actual growth-increment or 'Flächenzuwachs', steadily increases from the top right down to the base of the tree. The larches investigated, however, all came from dense plantations, but those from which Tables V, VI, and VII were derived had been left somewhat isolated by a severe thinning in the years 1909 and 1910. The apparent recovery shown in 1911 in tree D and the upper parts of trees E and F (Tables V, VI, and VII) is probably due to the increased illumination to which they were thereby exposed (cp. the outermost ring in Fig. 1 with that which immediately precedes it).

<sup>1</sup> Cp. Hartig (2), and Nördlinger.

Owing to the denseness of the plantations the crowns of these larches would be restricted in development, and down the bare trunk below the lowest of the branches the growth-intensity, and with it the 'Flächenzuwachs', would steadily decrease towards the base of the tree. Now if as one gets nearer and nearer to the base the whole sectional area of the annual ring is becoming less, while at the same time the circumference is steadily increasing as the thicker parts of the trunk are reached, it is clear that the *breadth* of the ring must decrease in a very striking manner, as is shown by Table I for a larch that had never been attacked by the Sawfly, and which may therefore be taken as a standard of comparison for the others. In the column showing the average ring-breadth for the last six years there is a regular gradient from section to section except at two points only. One of these is at the very base of the tree (section 1), at the root-stock in fact, where, as has been said, exceptional growth is to be expected. The other is in the topmost section, from the uppermost part of the crown, where the annual increment falls off again very rapidly according to the rules already mentioned.

The reasons why growth varies in different parts of the tree cannot be dealt with at length in this paper. Various explanations have been put forward. Schwarz<sup>1</sup> would refer the matter to differences in the longitudinal pressures acting on the cambium, these varying inversely with the strength of the wind's leverage at any part of the trunk and the capacity of resisting this bending force. Hartig<sup>2</sup> seeks a sufficient cause in supposed differences in the distribution of carbonaceous food-materials, mineral salts, of soil and air temperatures, &c. The facts themselves are enough for the present, and indeed a single satisfactory explanation of them has not yet been suggested.

These facts of distribution and localization of growth-intensity in normal trees have an important bearing on cases where the vitality has been lowered through defoliation or other causes. For when growth is reduced it will naturally cease first where it is normally least. In stunted trees, for instance, rings which fail close to the base may reappear in the root-stock, the growth there being normally greater than immediately above it.<sup>3</sup> The narrower rings, therefore, may be altogether absent from the base of the tree, though at the top it is still possible to count back ring by ring to the year of the commencement of the attack or depression of growth (see Tables IV, VI, and VII). Or at the base, again, a ring that is feebly developed may only reach part of the way round the tree (Fig. 6), though it may be complete higher up. 'Partial rings,' in fact, may arise over very small arcs of the circumference, only small circumscribed patches of the cambium mantle being active (A in Fig. 7). These partial rings are quite distinct from the 'multiple rings' that are occasionally found in larch and other trees, where at first sight several rings appear to have been

<sup>1</sup> Schwarz, pp. 2 and 160.

<sup>2</sup> Hartig (3), p. 271.

<sup>3</sup> Cp. Schwarz, p. 213.

formed in one year. For though in a multiple ring the successive bands of autumn wood often run together in places (as in Pl. L, Fig. 13), and so unite to form a single ring round the rest of the circle, in a partial ring the circuit is completely interrupted for a greater or lesser extent. Now even in undefoliated trees rings may be partially or wholly absent from the base of the trunk if growth becomes stunted through overshadowing or unsuitable soil.<sup>1</sup> When therefore a similar result is observed to follow on defoliation it can only be referred to the same cause—lowered vitality brought about by starvation.

*A priori* it might be objected that annual differences of temperature or rainfall might minimize the value of comparisons between the growths of successive years. Table I, however, for a tree that had never been attacked, shows that the influence of such climatic variations has been quite insignificant during the last six years. Of the other examples for which measurements are given two more came from this same area in Central Wales, while three are from the neighbourhood of Thirlmere. And since all the trees examined were of much the same age (from thirty to forty-five years) and were all planted at much the same altitude (500 to 650 feet), there remain no good reasons for supposing that the defoliations have not been the chief or even the sole factor in causing the reduction both of the breadth of the whole ring and the proportion of autumn wood.

Of course the effects of defoliation vary in intensity according both to the severity of the attack and to the vigour of the tree at the time. Despite repeated defoliations the trees B, C, and D were reported to be still flourishing when they were felled, and only in one of these, C, were rings at all absent, and then only in the lower parts. Table VI, on the other hand, represents a tree that was dead at the time of felling, like two others for which measurements are not given, and in all three of these dead trees growth had ceased entirely at the base one or more years before they were felled, though the upper parts still formed a ring each year. Between the upper parts, where the cambium still remained active, and the lower parts, where it had become quiescent, the partial rings already described were of frequent occurrence. The tree F (Table VII) was said by a competent authority<sup>2</sup> to be dying when it was felled, and certainly it shows at its base the same absence of rings as the three dead trees just mentioned. It would seem from these examples that where vitality has reached so low an ebb that growth quite ceases at the base, the tree is not likely to be able to withstand another defoliation, even though it is still growing at the top, as in Table VII. But as long as it is still growing at the base it would seem to have sufficient reserve food-materials left to enable it to put forth further crops of leaves season by season until it may ultimately outlive the present infestation by the Sawfly. Nevertheless, in all the cases investigated the attack has

<sup>1</sup> Cp. Hartig (2), p. 4, and Nördlinger, p. 9.

<sup>2</sup> Mr. R. L. Robinson,

seriously interfered with the growth-increment upon which the forester naturally bases his expectation of financial returns.

## 2. EFFECTS ON THE STRUCTURE OF THE WOOD.

The effects of defoliation upon the amount of growth and the consequent breadth of the annual growth-ring having now been described, there remain to be considered some modifications which have been brought about in the structure of the timber. Essentially these changes consist in a decrease in the ratio which the thick-walled 'mechanical' elements bear to the porous water-conducting tissue, and since in a tree like the larch the spring wood consists entirely of thin-walled tracheides, while the thick-walled cells are massed together towards the outside of the ring as the zone of autumn wood, it is in this outer region that the histological effects of defoliation become apparent. There are two distinct ways in which the autumn wood may be affected. Firstly, its breadth relatively to the breadth of the whole ring may decrease, but without any accompanying diminution in the characteristic thickening of the cell-walls. Secondly, this normal thickening may be poorly developed or even wholly lacking for part, especially the outer part, or even the whole of the breadth of the autumn zone, so that it is only from the smaller size of its outer cells and their flattened shape at the very limit that the ring can be demarked from the one that succeeds it (Fig. 3), and in extreme cases the boundary is no longer to be traced with any accuracy (Fig. 9, between A and B).

Now the autumn wood of the first year to show evidence of the attack of the Sawfly is never normal; it is affected in the second of the two ways just mentioned, being deficient in the thickening of its cell-walls. In subsequent years, however, in spite of continued repetition of the defoliations, it may consist once more of normally thickened tracheides, in narrow zones commensurate with the decreased breadth of the whole ring (cp. Figs. 1, 2, 4, 6, 9, and Tables III, V, VII). But such a return to normally thickened autumn wood never occurred in such trees as ultimately succumbed before they were felled for the purposes of this investigation. Fig. 8 shows a typical example of the appearance of the last-formed ring of one of these, and may be contrasted with Fig. 4, taken from the tree C, which was still vigorous at the time. On the other hand, examples D and F formed in the last two years before felling even an increasing percentage of quite normally thickened autumn wood (Fig. 1). They were said to have been only partially defoliated in those two years, but the betterment seen in the development of their autumn wood is probably referable rather to the fact already mentioned, that the plantations from which they came were thinned at that time; for even tree E, from the same plantations, made at the top an increased proportion of autumn wood, though not properly thickened, in the very year in which it succumbed (Table VI).



## (a) Breadth of Zone of Autumn Wood.

But the importance that might otherwise be attached to the breadth of the zone of autumn wood is perhaps increased by the consideration of the uppermost section of tree C. This section was taken seven feet below the tip of a well-grown tree with an exceptionally well-developed crown that extended, in fact, more than half-way towards the ground. Fig. 11 shows the east side of the section, where the outermost ring is composed almost entirely of autumn wood; Fig. 12, from the west side of the same section, shows the same ring consisting of nothing but spring wood; while on the south side of the section the ring disappears altogether (Text-fig. 1). Only four feet lower down (Text-fig. 2) it is the west side that shows the more striking development of autumn wood for this particular year, and the east side has about the normal proportion (about 50 per cent.), while the ring is very narrow and of unthickened tracheides on the north side and practically disappears again on the south.

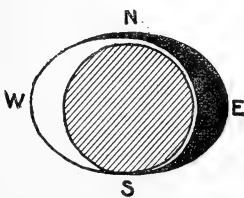

TEXT-FIG. 1.

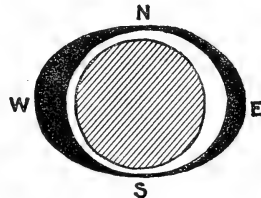

TEXT-FIG. 2.

Diagrammatic representations of the last year's growth of the two uppermost sections of the same tree, the autumn wood being shaded (cp. Table VIII).

The correct interpretation of these two sections requires some adequate understanding of the physiological causes of autumn wood formation. Clearly the difference between the east and west sides of the uppermost section could not be explained on Sachs's<sup>1</sup> hypothesis that the characteristics of autumn wood tracheides are due to constriction of the cambial region by the encircling bark; moreover, Krabbe<sup>2</sup> has proved that this supposed periodically recurrent compression of the expanding cells does not exist. Schwarz<sup>3</sup> refers the formation of thick-walled tracheides to the stimulus of longitudinal stress during bending by the wind. Wieler<sup>4</sup> and Hartig<sup>5</sup> suppose it to be largely a question of nutrition, but whereas the former concludes that autumn wood is produced because conditions of growth are becoming less favourable, the latter considers that thick-walled cells are due to the extra nutriment that has been accumulating during the summer. Strasburger<sup>6</sup> and Haberlandt,<sup>7</sup> on the other hand, considering the *function*

<sup>1</sup> Sachs (1), p. 409.

<sup>2</sup> Krabbe, p. 1125.

<sup>3</sup> Schwarz, p. 365.

<sup>4</sup> Wieler, p. 129.

<sup>5</sup> Hartig (1), pp. 34 and 103.

<sup>6</sup> Strasburger, p. 949.

<sup>7</sup> Haberlandt, p. 371.

of the thin-walled spring wood, suppose that its formation is regulated by the requirements of the transpiring crown; when these needs are adequately provided for only thick-walled autumn wood cells are formed until growth ceases for the year. Pfeffer<sup>1</sup> cautiously admits that nothing definite is known of the causes of the seasonal change in structure of the woody ring.

In the particular case of the uppermost of these two sections it is especially noteworthy that the ring fails altogether on the south side instead of being intermediate in condition between the east and west, as it should have been if differences of temperature or wind-pressure had been the cause of the inequality shown by Figs. 11 and 12. It is hard to suppose that the transpiration of the symmetrically developed uppermost few feet of the crown above the section should have been so negligible on the east side if it were responsible for all the spring wood on the west; but there might have been a difference in the nutrition of the opposite sides of the section at that point. Now the distribution of growth in a thriving and well-nourished tree lends weight to the view taken by Sachs<sup>2</sup> and Pfeffer<sup>3</sup> that growth in the different parts of a plant is not governed in the first place by the quantity of food available in each, but rather that food-materials are translocated especially to those parts where cell-division is proceeding most energetically. But after several defoliations have reduced the reserves the quantity of food at hand in any part might conceivably become a limiting factor to the growth there, and, indeed, in the particular tree in which this remarkable ring occurred growth had quite failed at the base a year or two before, which suggests that the upper parts even might have become by this time very sensitive to slight local variations in food supply. Numerous 'ringing' experiments seem to show that the elaborated food-materials tend to pass vertically down the trunk without diffusing around in all directions, so that in a very impoverished tree growth of the main stem might be taking place only just below the point of junction of each branch.<sup>4</sup> Supposing in such a case that just above the section there were a branch on the east side, but that on the west the nearest considerable branch were a little higher up, it is easy to see that the east side of the section would get the more food, while on the west the descending nutriment, having farther to go, might not last out so far down as the point where the section was taken. A similar result would follow if the west side of the crown were more severely defoliated than the east.

It is unlikely that the formation of autumn wood in general can be the result of a single cause, but in this particular case differences in the amount of food-material available on either side of the section seem to afford the explanation most fitting to the facts described. This matter cannot be settled until the whole of the upper part of a starving tree has been

<sup>1</sup> Pfeffer (1), p. 215.

<sup>2</sup> Sachs (2), p. 439.

<sup>3</sup> Pfeffer (2), pp. 584, 592, 600, 601.

<sup>4</sup> Cp. Nördlinger, p. 3; Hartig (2), p. 23.

sectioned at every few inches, the position of the principal branches being carefully noted at the same time. Such a method was precluded from the present investigation because sections had only been obtained at every fourth foot. On a future occasion I hope to throw some light on this interesting matter.

(b) **Anomalous Formation of Autumn Wood.**

In certain rings the defoliations have produced a striking anomaly in the autumn wood formation, traceable in every section from the top of the tree to the bottom. Such rings are denoted in the tables by the letter 'a', and show as it were a tentative formation of autumn wood. There is first a zone of the rounded thickened cells that ordinarily occur in Coniferous timber as a transition between the thin-walled spring tracheides and the tangentially flattened, thick-walled 'Grenztracheiden'<sup>1</sup> that limit a normal annual ring, but then, instead of the typical 'Grenztracheiden', these abnormal rings pass on to a renewed production of thin-walled cells to form their outer limit (Fig. 4, innermost ring). It is as though the tree had begun to make its autumn wood but the food supply ran short, and consequently the thickening of the cell-walls could not be continued right up to the boundary of the ring. The actual appearance of this thick-walled zone recalls somewhat the isolated bands of 'mechanical' tissue commonly found in the spring wood of the young shoots of many Conifers.<sup>2</sup> These bands have been referred to the effect of supposed alterations of pressures acting upon the cambium, and Schwarz,<sup>3</sup> as has been said, goes even so far as to regard the longitudinal stresses occasioned by bending as the main stimulus to the thickening of the cell-walls of normal autumn wood. If this view is correct, it is possible to account for the want of thickening in the walls of the outermost cells of these abnormal rings on the theory that after defoliation the wind could not sway the tree so much as before, and consequently the bending forces would be less.

Besides these two suggestions, viz. that the increased proportion of autumn wood is due to lack of food, or to reduced pressure, or perhaps to a combination of both, there is a third possible factor to be considered. It has been mentioned that Strasburger, with Haberlandt and others, held that spring wood was formed just so long as the shooting of the young leaves required fresh provision of water-conducting tissue. According to this view a second flush of leaves would mean a renewed formation of spring wood, and the reason why 'Lammas' shoots do not always cause a 'double ring' is that the second crop of leaves may burst out before autumn wood formation has begun. Strasburger<sup>4</sup> mentions the case of a twenty-year-old larch which once at least had formed a double ring after

<sup>1</sup> Cp. Hartig (1), Fig. 3, p. 12.

<sup>3</sup> Schwarz, pp. 2 and 160.

<sup>2</sup> Cp. Sanio, p. 101.

<sup>4</sup> Strasburger, p. 949.

a second leafing due to an especially favourable autumn. But in this same tree a second crop of leaves did not always mean a double ring, especially in the lower parts of the trunk, for there autumn wood formation generally begins a little later than in the upper parts. Now after defoliation by the Sawfly larvae the larches sometimes put out fresh leaves towards the close of the summer, possibly after the formation of autumn wood has already begun. Spring wood is generally formed between the middle of April, when growth begins, and the end of June, after which month autumn wood is produced, until growth ceases about the end of August or beginning of September.<sup>1</sup> The defoliation of the larches, beginning in June, is usually over by the end of July, and a second crop of leaves may appear about the middle of August, i. e. before the end of the year's growth. According to Strasburger's view, these new leaves would stimulate the cambium to a renewed formation of spring wood outside the first few autumn tracheides, while the lateness of the season or scarcity of food might preclude a second development of autumn wood to finish off the ring.

Another explanation of the abnormal formation of thin-walled cells at the outer limit of a ring may be put forward on the grounds of experiments by Lutz, who found that artificial defoliation and prevention of a second leafing led to the production of spring wood at a time of year when autumn wood was to be expected.<sup>2</sup> He supposes that the decreased transpiration of the defoliated branches had resulted in the tree filling with water, and that the presence of much water determines the formation of spring wood. This view, in opposition to that held by Strasburger and by Haberlandt, already mentioned, is supported by the fact that on wet ground *Pinus sylvestris* makes very poor autumn wood,<sup>3</sup> and it would seem to be applicable to those defoliated larches where a second leafing has not occurred or is only partial.

To determine, if possible, how far altered conditions of nutrition or a second growth of leaves might affect the formation of autumn wood, certain larches were investigated in districts free from the Sawfly, but where the abnormal summer of 1911 had destroyed some of the shoots of that year, thus prematurely cutting short the normal elaboration of food materials. For instance, in some young Japanese Larches growing near Oxford, all the shoots of 1911 had been dried up at the tips, so that all the leaves of the following summer were of necessity those of spur shoots. When one of these trees was examined it was found that in the ring of 1911 the zone of thick-walled autumn wood passed quite suddenly into a very narrow zone of thin-walled cells quite distinct from the spring wood of 1912 by reason of smaller size and tangential flattening. This unthickened zone was found throughout the whole tree; its cells seemed to have been

<sup>1</sup> Cp. Hartig (1).

<sup>2</sup> Lutz, 1895. I am at present investigating this matter.

<sup>3</sup> Cp. Ramann and Bauer.

somewhat crushed by the next year's growth, and their general appearance was of cells just cut off from the cambium, and which consequently had not yet lost their prismatic form or gained a thicker cell-wall. A few yards off from this tree was another Japanese Larch of the same age, but which showed no external traces of injury from the drought of 1911. It showed, however, outside the normal autumn wood for that year, a thin-walled zone of flattened cells similar to that just described in the other tree, but with rather thicker walls and not at all crushed.

It seems, then, that in both these trees there had been a check to the autumn wood formation, followed by renewed growth. In the case of the first tree, which had lost the help of its terminal shoots, there was perhaps not enough food-material for a proper thickening of the cells then formed. But in the second example the shoots were all still able to function, and so the cells could be better thickened and might have been almost normal if the approach of the winter had not checked their further development.

Investigations were also made in Kent upon a twenty-year-old larch tree which in September, 1912, was bearing a second flush of leaves on some of its spur shoots while other parts of the tree were still dark green, having retained the needles put forth in the spring. This second flush was especially noticeable on the spur shoots of the branches whose terminal bud had been killed in the preceding year. In none of the branches investigated, whether bearing a second flush or not, was there anything abnormal in the ring of 1912. But as the formation of autumn wood had set in before this second flush of leaves was fully grown, there should have been already induced by them some beginnings of a second thin-walled zone if such, as Strasburger suggested, were the natural consequence of a second leafing. Traces of such a zone, however, were found in the ring of 1911, both in branches whose terminations had been injured that same year and also in those which were continued on unharmed into the shoot of 1912. The inference is that a zone of thin-walled cells outside the autumn wood is not caused by a second flush of leaves, but rather by inferior nutrition consequent upon unfavourable conditions of growth, such as were of common occurrence during the drought of 1911. The Japanese Larches from Oxford support the same general conclusion.

It must be admitted that the extreme youth of the only branches of this Kentish tree that were in fit condition for such comparisons detracts somewhat from the value of the conclusions obtained from them, and a similar reason lessens the importance of the two seven-year-old Japanese Larches. For in young trees and branches the formation of autumn wood frequently tends to be abnormal and deficient in thickening of its cell-walls,<sup>1</sup> or marked by the bands of mechanical tissue already referred to, the so-called 'Druckzonen'<sup>2</sup> which may appear in the spring wood. But

<sup>1</sup> Cp. foot-note on next page.

<sup>2</sup> Cp. Schwarz, p. 237.

so constant a difference as was found between the thick-walled autumn wood of the Japanese Larches and the abnormal thin-walled zone outside it is not easily explained merely by the youth of the trees. Whatever inferences can be drawn from these cases are all in favour of the view that diminished nutrition may be a cause of the occurrence of unthickened cells at the boundary of the autumn wood.

For the view that in the autumn wood of the defoliated larches such an abnormal formation of thin-walled cells outside the thickened ones is really a starved attempt at autumn wood, there is yet a further argument in the steadily decreasing size of the cells from the beginning of the thickened zone right outwards to the limit of the ring. There are no published figures of the 'double-ring' described by Strasburger in a larch to which reference has already been made, but Fig. 14, from a section taken at random from a species of *Abies*, shows that the thinner-walled cells between the first and second thick-walled zones are actually larger than those on either side of them. S. J. Record's illustration of *Juniperus virginiana* shows more clearly a similar state of things, which would appear to be the normal result of a renewal of cambial activity towards the end of the growing season. But in the abnormal rings of the defoliated larches, as Figs. 4 and 13 show, the cells become ever smaller up to the end of the year's growth, even though they are without any characteristic autumn thickening. In the two Japanese Larches from Oxford the ring of 1911 was bounded by cells that appeared as if checked in development before they had properly outgrown the flattened prismatic form and thin-walled condition of the cambial cells from which they were derived. But almost to the last the cells of the abnormal rings in Figs. 4 and 13 are *rounded* though unthickened, showing that they had been growing since they were cut off from the cambium. Their relatively small size corresponds to that of the outermost cells of normally thickened autumn wood (which are not always markedly flattened), and it may be supposed that they are not thick-walled for the simple reason that there was not sufficient food-material at hand, although the cambial cells still retained their normal capacity for repeated division. The mere formation of new cells and the thickening of their membranes must be regarded as two distinct phenomena, governed independently of each other by stimuli at present insufficiently understood.<sup>1</sup> A case like that of Fig. 3 seems to represent a genuine attempt at forming autumn wood, in which, however, the extra deposits of thickening upon the wall had to be omitted. Only in the extreme case shown in Fig. 9, between A and B, where the cells at the boundary are no smaller than those of the succeeding

<sup>1</sup> The thickening and lignification of the elements often proceeds very slowly in young normal larches, so that in August there may be found a zone of thin-walled cells between the cambium and the completed tracheides, which last may still give the cellulose reaction in the thick secondary layers of their walls.

spring zone, may it be supposed that growth had ceased for the year before the due time had come for the seasonal peculiarity of autumn wood formation with its attendant reduction in the size of the cells.

It has been remarked that the first year to show the effects of defoliation has no thick-walled autumn wood, at least at its ultimate boundary, but as a rule the cells here are of much smaller size than those formed in the spring or early summer (Figs. 1 and 3). We have, as it were, unthickened autumn wood, at the close of a fairly broad ring. Subsequent years, however, show much narrower rings, with or without a few rows of cells with more or less strongly thickened walls and flattened shape, and exhibiting that sharp demarcation from the spring wood that is general in the narrower rings of Coniferous timber (Figs. 1, 2, 4, 7, and cp. Fig. 13 from a part of a tree dating back to before the commencement of the attack). Possibly this recovery means that defoliations were less severe after the first two years of the attack; the only records available were found to be inaccurate with regard to individual trees, however they may apply to whole plantations. The exceptionally strong development of autumn wood in the outermost two rings of the whole of tree D and of the lower parts of trees E and F has already been referred to the thinning out of the Thirlmere plantations from which these three trees came, but even here it is not very clear why a tree can once more begin to produce well-thickened autumn wood before its rings have been able to regain their former breadth. Probably the spring wood is formed out of the reserves stored up over winter, while the autumn wood is supplied from the assimilated products of the current year. Consequently the defoliation endured in any particular year would have a greater effect on the autumn wood,—indeed, the spring wood is largely formed before the defoliations begin in June. It may be pointed out also that, other things being equal, decreasing breadth of ring up to a certain point means an increasing proportion of well-formed autumn wood, so that slow grown trees often yield the harder timber.<sup>1</sup> But that the hardness absolutely depends on the percentage of autumn wood would be an erroneous conclusion.<sup>2</sup> Even in different parts of the same tree great variations of hardness are to be met with that cannot be referred to differences in the ratio of thick-walled to unthickened cells. As a rule it was remarked that in the larches investigated the hardest sections, judging from the wear of the razor used to cut them, were those where the autumn wood was very sharply demarcated.<sup>3</sup>

### (c) Resin Duct Formation.

Finally, attention may be drawn to the presence of abnormal resin-cavities in some of the rings that are deficient in autumn wood. Fig. 15

<sup>1</sup> Cp. Schwarz, p. 350 and the foot-note on p. 348.

<sup>2</sup> Cp. Hartig (1), p. 40.

<sup>3</sup> Cp. Record, p. 40.

shows the ordinary zones of traumatic ducts that are formed year after year in the neighbourhood of injuries, such as the cankers caused by *Peziza Wilkommii*, and Fig. 16 shows a similar zone more highly magnified.<sup>1</sup> These ducts are very different from the irregular cavities shown in Fig. 17, which seem traceable in a more elementary stage of development in Fig. 18, from another part of the same tree. It may be pointed out that the phyllophagous larvae of the Sawfly can hardly cause any traumatic effect down in the trunk, and the ovipositor of the mature insect can only harm the tender shoots. Whether these abnormal resin-cavities are the result of an attempt to make normal ducts, in traumatic zones or otherwise, which has become abortive through declining growth-energy and lack of food, has not been decided.

In conclusion, I wish to express my warmest thanks to Professor Somerville for the very ready way in which he put the resources of his laboratory at my disposal, and for helpful suggestions. I am indebted also to Professor Vines for facilities that were of great assistance in expediting the work, and to Professor R. W. Phillips, University College of North Wales, Bangor, for kindly criticism. The photographs were made from my own preparations and under my direction by Mr. Alfred Robinson of the University Museum.

#### SUMMARY.

1. The material investigated was for the most part furnished by trees that had been repeatedly defoliated by larvae of the Large Larch Sawfly.
2. Premature defoliation means a greater or lesser degree of starvation.
3. Starvation affects both the quantity of the growth-increment and the structure of the wood formed.
4. If starvation is severe, growth may quite cease over certain parts of the cambium-mantle while other regions of it are still active. Growth is especially reduced in the lower parts of the tree, where the rings are normally narrower than higher up. Consequent on this regional inactivity of the cambium some rings may run only part of the way round a section of the trunk, or may even be wholly lacking. In larches killed by the defoliations growth ceased entirely at the base a year or more before the death of the tree.
5. The effects of climatic variation have been negligible during the last few years, as far, at least, as some plantations are concerned.
6. The first visible effects of defoliation in the structure of the wood is the reduction of the proper thickening of the walls of the cells of part or all of the zone of autumn wood, without much decrease in the breadth of the whole ring. Subsequent years may show quite normal autumn wood before the rings have recovered their former breadth.

<sup>1</sup> Cp. Tschirch, p. 1190; also Thomson, Figs. 1 and 2.



7. The same ring may show remarkable differences in the autumn wood formation on opposite sides of the tree, and in such a way as must be referred to the positions of the different branches, pending further investigations.

8. The outermost cells of the autumn wood may have their walls unthickened, though those farther inside may be normal in this respect. The lack of thickening in the outermost cells might be referred to changes in the rate of the transpiration current during the development of the autumn wood. For defoliation would cause stagnation in the tracheides; whereas on the other hand the new growth of leaves that often follows after defoliation might make renewed demands on the water supply and stimulate the cambium to the production of thin-walled conducting cells.

9. Other examples give evidence rather that the outermost cells are unthickened merely because food ran short at the close of the year. The small size of the cells concerned supports this view, namely, that they are not a new formation of conducting tissue, but merely the 'mechanical' cells of typical 'autumn wood' starved in development.

10. Abnormally formed resin ducts have been remarked in the defoliated larches; possibly they are causally connected with the starvation, as a pathological effect.

Magdalen College, Oxford,  
Dec., 1912.

---

#### REFERENCES TO PREVIOUS PUBLICATIONS.

1. ANNAND : Quarterly Journal of Forestry. 1910.
2. HABERLANDT, G. : Physiologische Pflanzenanatomie. 1884.
3. HARTIG, R. (1) : Holz der deutschen Nadelwaldbäume. 1885.
4. ——— (2) : Holzuntersuchungen. 1901.
5. ——— (3) : Lehrbuch der Anatomie und Physiologie der Pflanzen. 1891.
6. HEWITT : Journal of the Board of Agriculture. 1908.
7. KRABBE, G. : Sitzungen der Berliner Akademie. 1882.
8. LUTZ, K. G. : Beiträge zur wiss. Botanik, herausgegeben von Fünfstick, i. 1. 1895.
9. MACDOUGALL : Journal of the Board of Agriculture. 1906.
10. NÖRDLINGER : Der Holzring. Stuttgart, 1872.
11. PFEFFER, W. (1) : Physiology of Plants, vol. ii, 2nd Eng. ed. 1903.
12. ——— (2) : Pflanzenphysiologie, Bd. i, Aufl. 2. 1897.
13. RAMANN, E., und BAUER : Jahrbuch für wiss. Botanik. 1911.
14. RECORD, S. J. : Economic Woods of the United States. 1912.
15. SACHS, J. (1) : Lehrbuch der Botanik, Aufl. 1. 1868.
16. ——— (2) : Vorlesungen über Pflanzenphysiologie. 1882.
17. SANIO : Pringsheim's Jahrbücher für wiss. Botanik. 1872.
18. SCHWARZ, F. : Dickenwachstum und Holzqualität von *Pinus sylvestris*. 1899.
19. STRASBURGER, E. : Leitungsbahnen. Histologische Beiträge, iii. 1891.
20. THOMSON, W. P. : Botanical Gazette. April, 1912.
21. TSCHIRCH, A. : Harz und Harzbehälter. 1906.
22. WIELER, A. : Jahrbuch für wiss. Botanik. 1887.

## EXPLANATION OF FIGURES IN PLATES XLIX AND L.

Illustrating Mr. Harper's paper on Defoliation.

All are photomicrographs of transverse sections of the trunk of *Larix europaea*, with a magnification of 37 diameters except in the case of Figs. 1 and 15, which are magnified only 13 diameters.

$x$  indicates the autumnal boundary of the first ring to be affected by defoliation.  $y_1 y_2 y_3$ , &c., denote the number of years that have passed since the formation of any particular ring. When comparison with other parts of the tree shows that certain rings are absent from a section (see p. 629) it is always assumed that these are the most recent rings of all (Figs. 16, 17, 18), unless there is positive evidence to the contrary (as in Figs. 6 and 7). M = multiple ring.

## PLATE XLIX.

Fig. 1. Tree D. Westmorland. Thriving. Showing the first effects of defoliation four rings from the outside.  $16\frac{1}{2}$  feet from ground.  $\times 13$ .

Fig. 2. As above. 11 feet from ground.

Fig. 3. As above. 33 feet from ground, showing the third ring from outside broader than in the foregoing lower section, Fig. 2.

Fig. 4. Tree B. Merioneth. Thriving. Showing first effects five rings from outside. 10 feet from ground.

Fig. 5. Tree C. Merioneth. Thriving. Showing partial disappearance of second ring from outside. Base of tree.

Fig. 6. As above. 12 feet from ground.

Fig. 7. Tree B. Merioneth. Thriving. Cp. with Fig. 4. The third ring from the outside is only shown at A. Base of tree.

Fig. 8. Tree E. Westmorland. Dead. Two outermost rings have completely failed.  $16\frac{1}{2}$  feet from ground.

## PLATE L.

Fig. 9. Tree D. Base of tree. Cp. with Figs. 1 and 2 at  $16\frac{1}{2}$  and 11 feet from ground respectively. Boundary of fourth ring scarcely visible, between A and B.

Fig. 10. Tree F. Westmorland. Dying.  $27\frac{1}{2}$  feet from ground.

Fig. 11. Tree C. 32 feet from ground. Cp. with Fig. 12 and Figs. 5 and 6, and with Table VIII.

Fig. 12. The opposite side of the same section to that shown in Fig. 11.

Fig. 13. Showing the fusing up of 'multiple rings' in a larch-tree before the Sawfly attack commenced.

Fig. 14. Section of *Abies* timber, showing a 'double ring'.

Fig. 15. Tree F. Section near a wound (canker), showing traumatic zones of resin ducts, especially in the spring wood.  $\times 13$ .

Fig. 16. Tree E. Cp. Fig. 8. Zone of resin ducts, probably traumatic. Base of tree.

Fig. 17. As above. 11 feet from ground. Ducts abnormally formed.

Fig. 18. As above.  $16\frac{1}{2}$  feet from ground. Cp. with Fig. 17 the weakly formed cells between A and B.



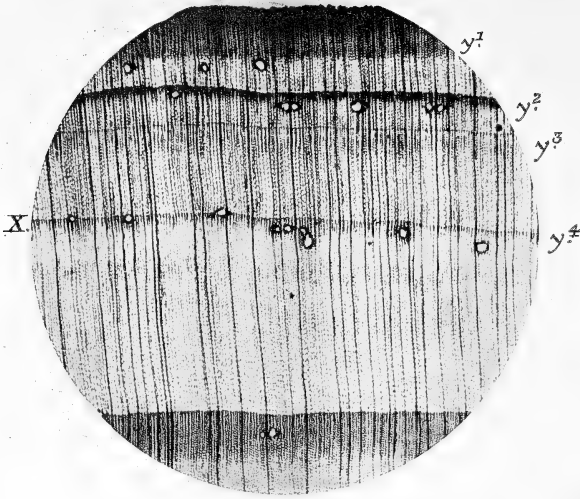

1.

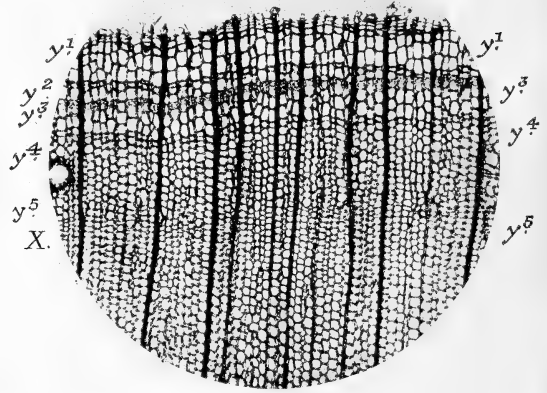
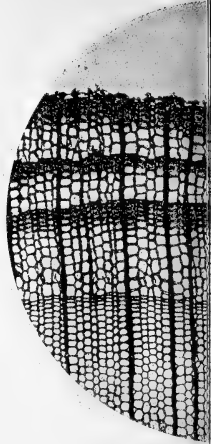

5.

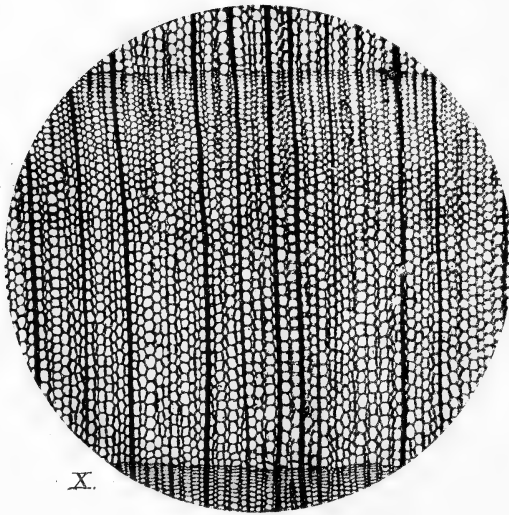

X.

3.

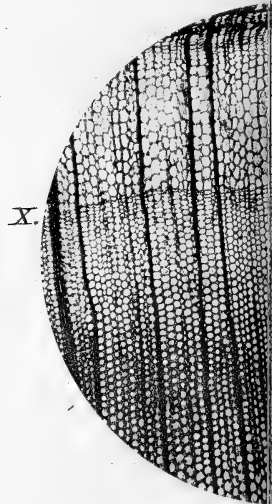

8.

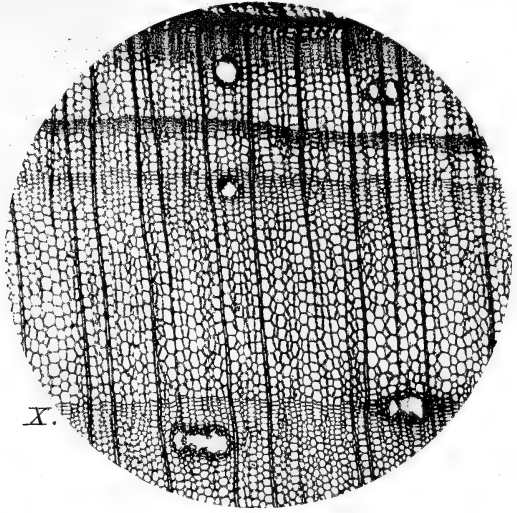
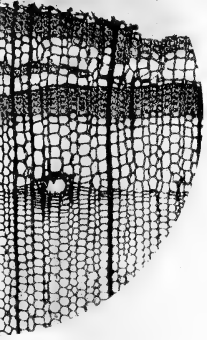

2.

X.

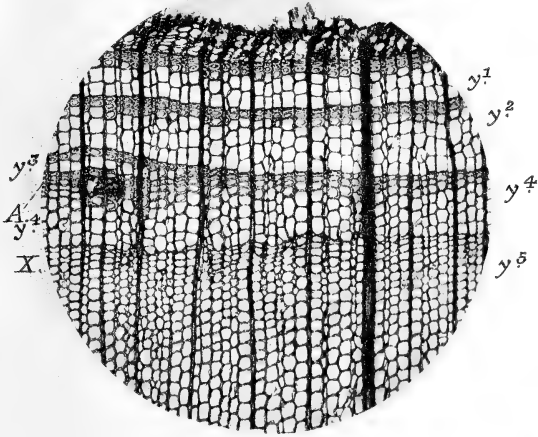

7.

X.

y<sup>1</sup>  
y<sup>2</sup>  
y<sup>3</sup>  
y<sup>4</sup>  
y<sup>5</sup>

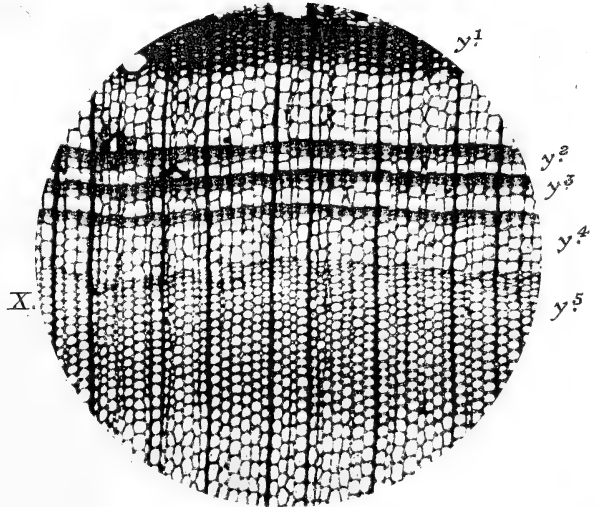
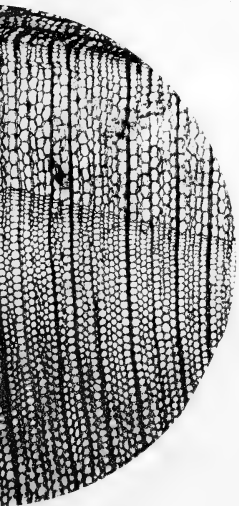

4.

X.

y<sup>1</sup>  
y<sup>2</sup>  
y<sup>3</sup>  
y<sup>4</sup>  
y<sup>5</sup>



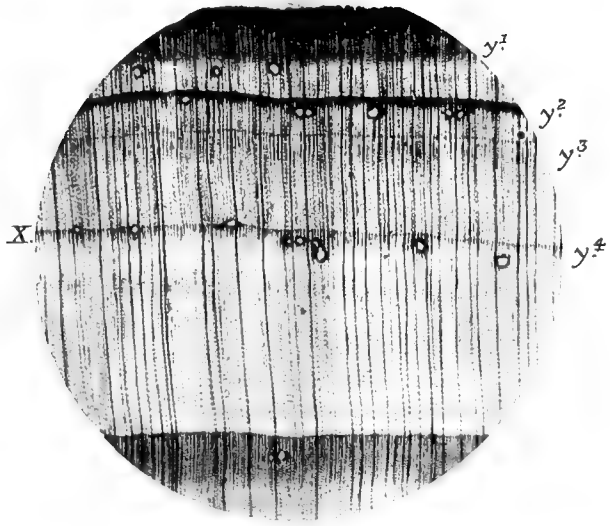

1.

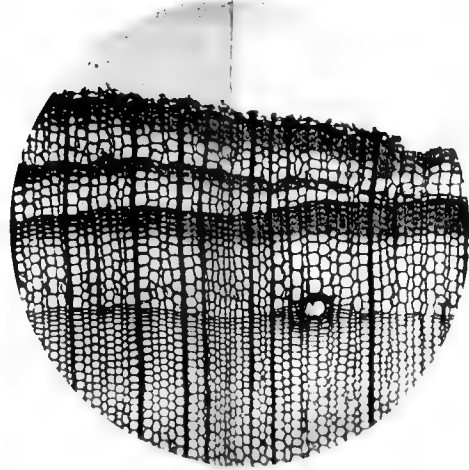

6.

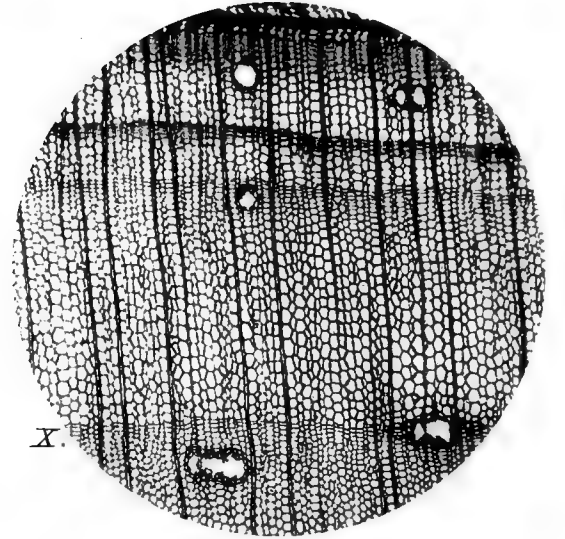

2.

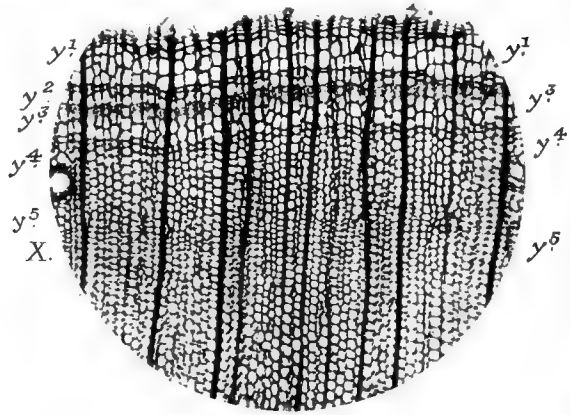

5.

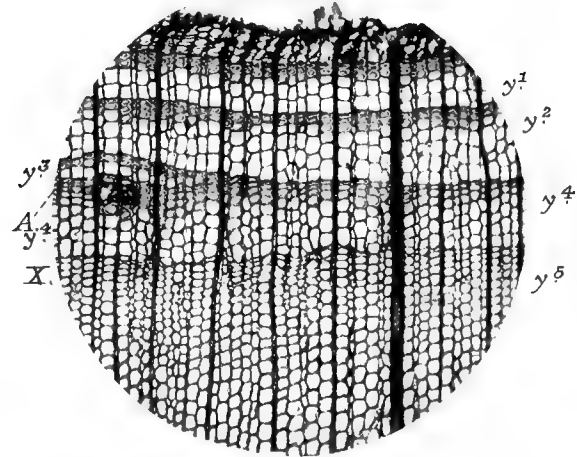

7.

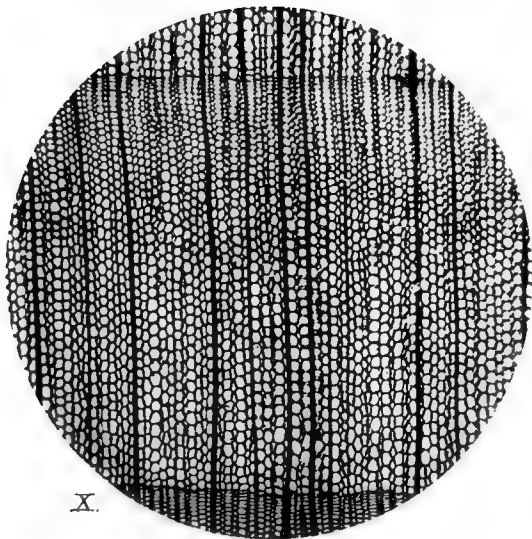

3.

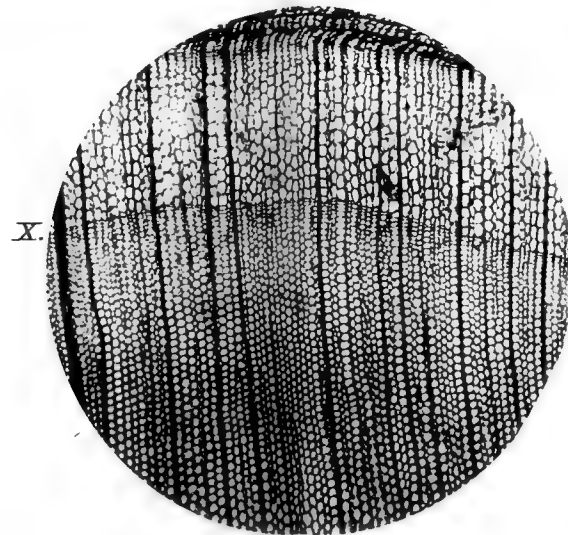

8.

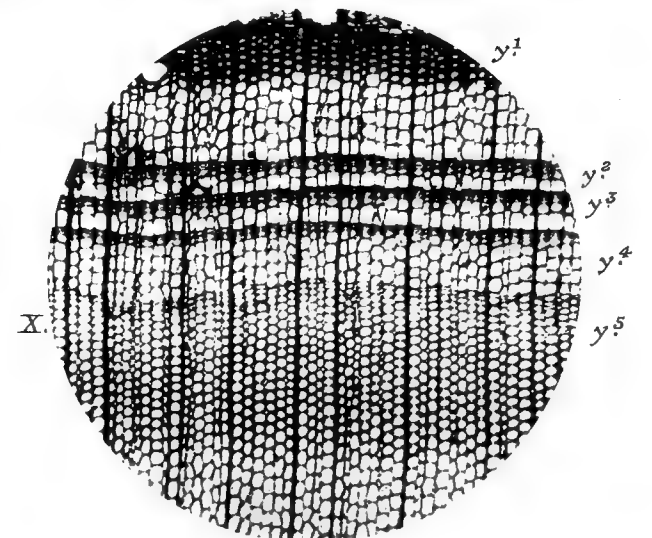

4.

HARPER — DEFOLIATION







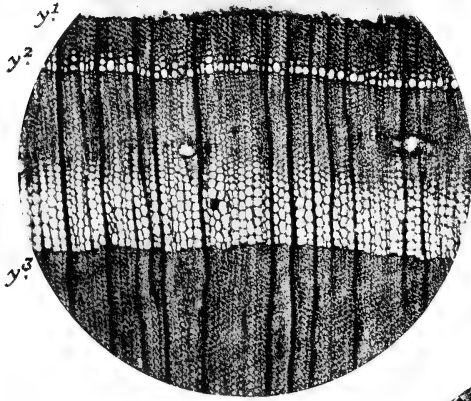

11.

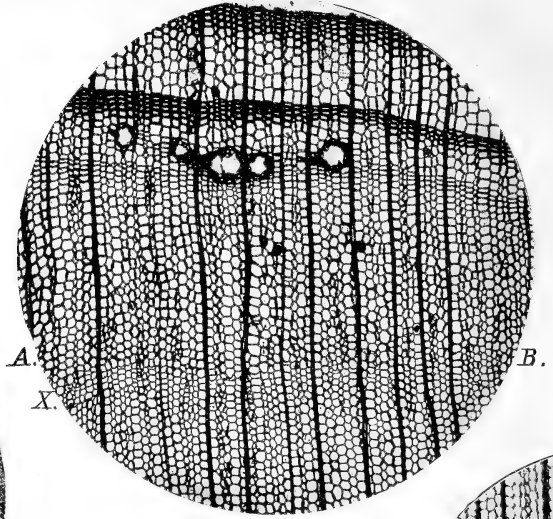

9.

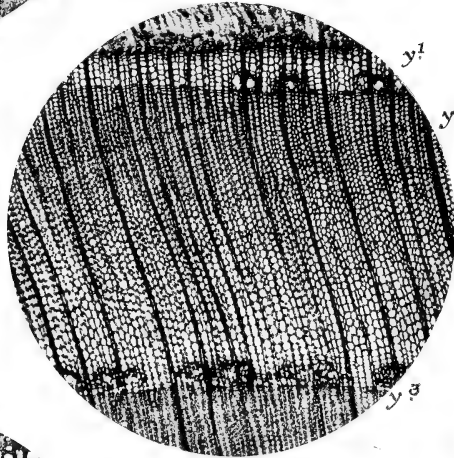

12.

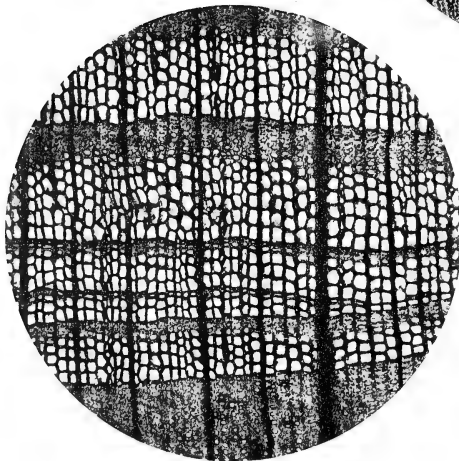
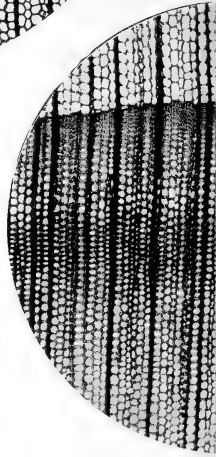

13.

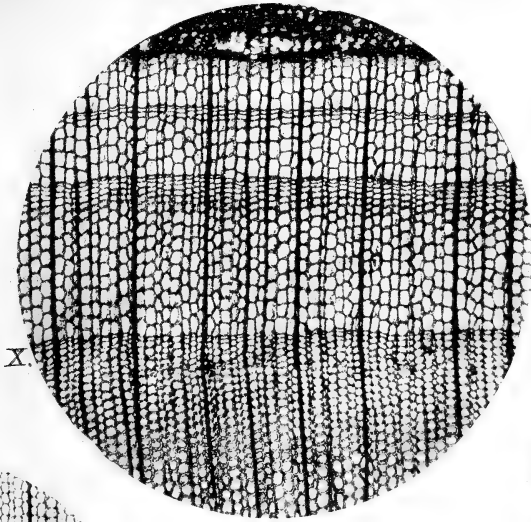

10.

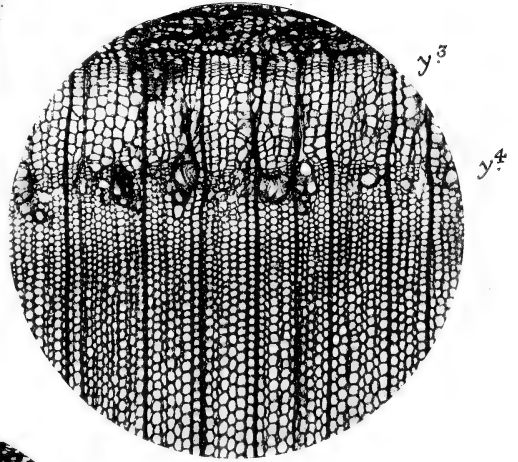

17.

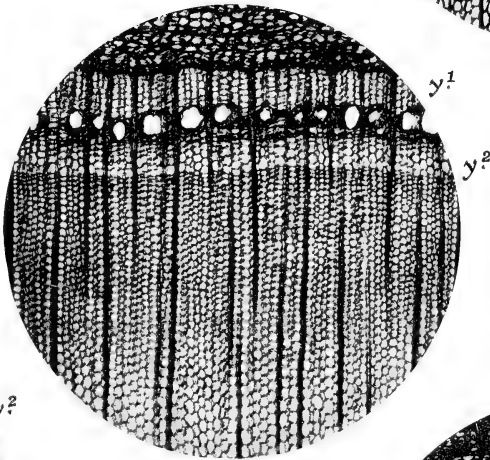

16.

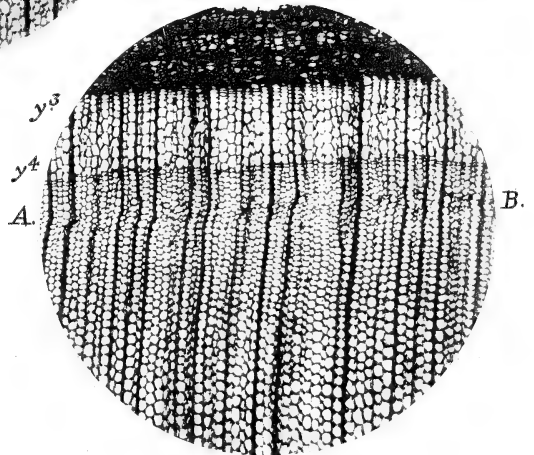
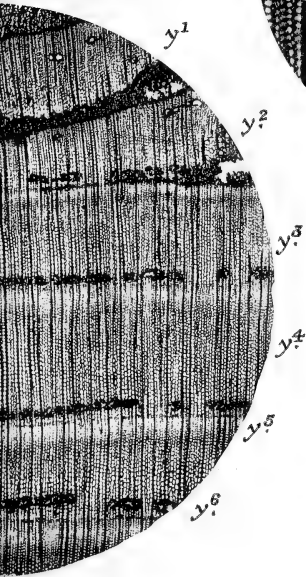
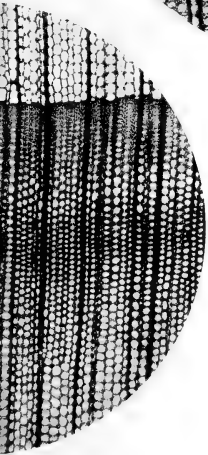

18.



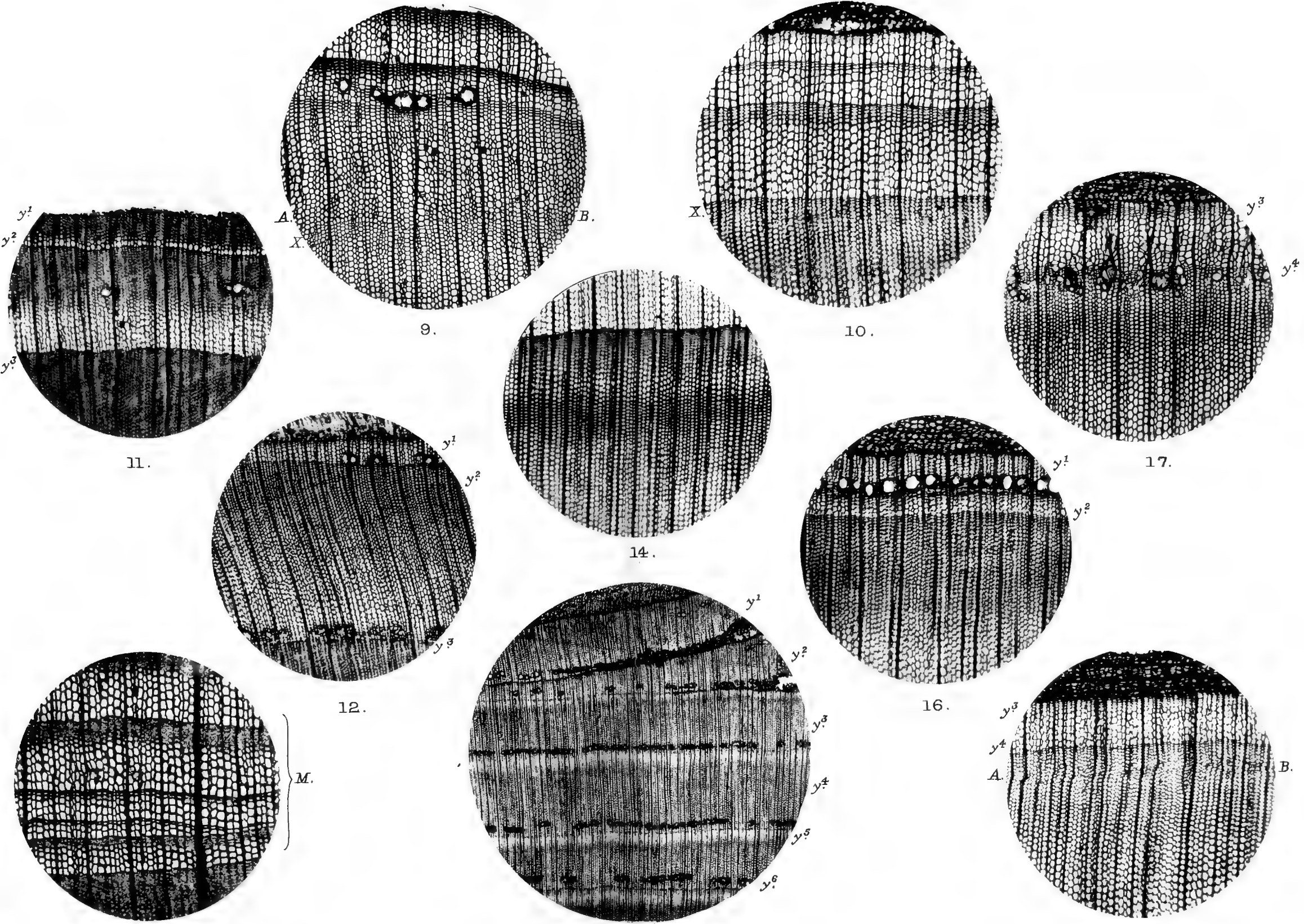

11.

9.

10.

17.

12.

14.

16.

13.

15.

18.

HARPER — DEFOLIATION.

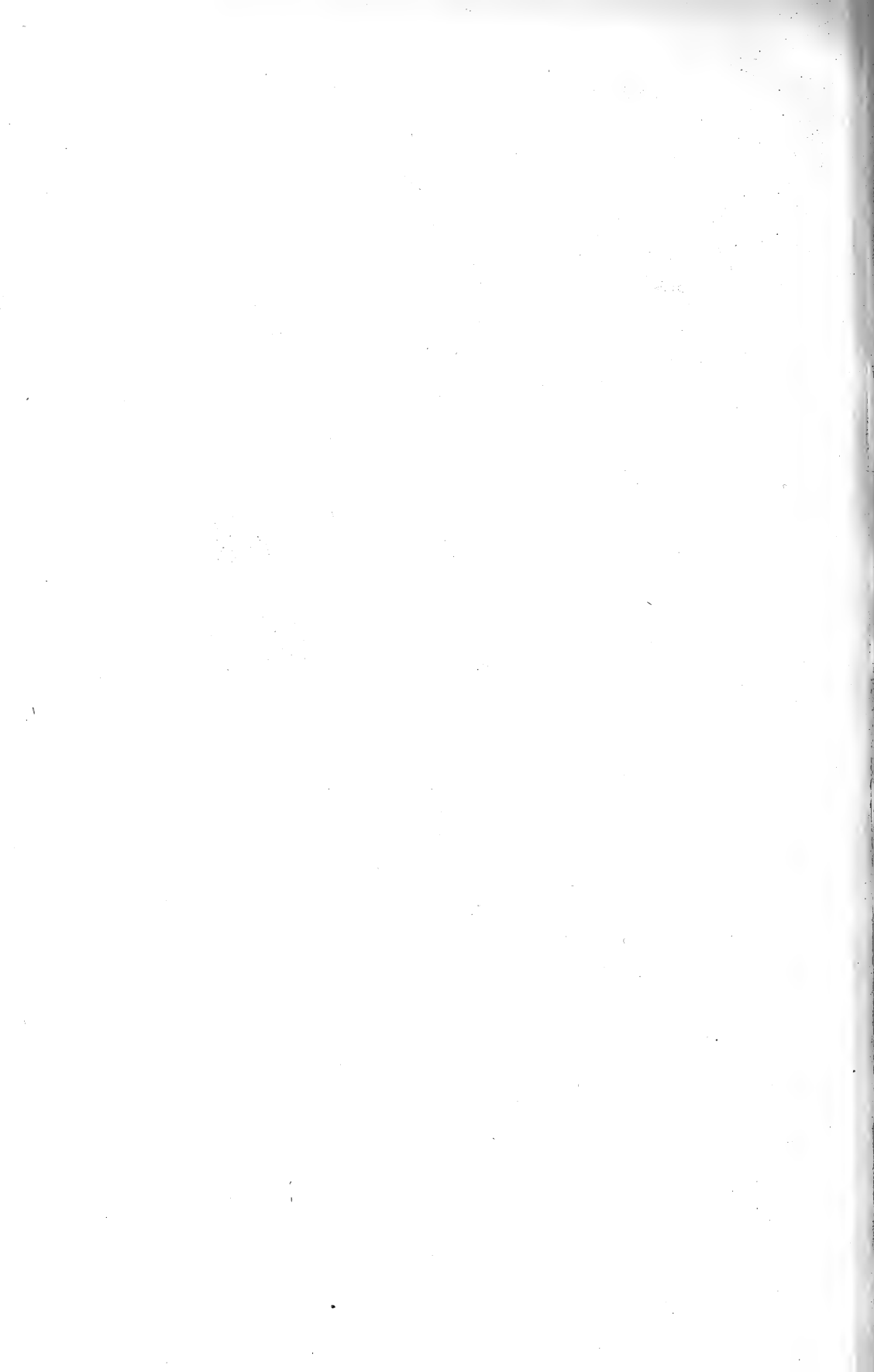

## Studies in Spore Development.

### III. The Premeiotic and Meiotic Nuclear Divisions of *Equisetum arvense*.

BY

RUDOLF BEER, B.Sc., F.L.S.

With Plates LI-LIII.

IN 1909 I published (1) a short account of the spore development of *Equisetum* with the principal object of recording the result of my observations upon the origin of the much disputed 'middle coat' of the spore-wall. In contradiction to those who had written on this subject before, I found that this layer of the spore-membrane was derived from the secretory activity of the tapetal plasmodium which surrounds the developing spores.

It had been my intention to publish a more detailed account of the spore development of this plant, but the appearance of a careful and thorough study of this subject by E. Hannig in 1911 (3) has rendered this unnecessary. Hannig, in his much more extensive memoir, has reached similar conclusions regarding the 'middle coat' (as well as in several other respects) to those to which I gave expression in my short note of 1909.

The nuclear divisions associated with the spore development of *Equisetum* were, however, not dealt with by Hannig, and I thought that it might be of interest to describe these at greater length in the present communication. This seemed the more desirable since a fresh study of many new preparations has caused me to modify some of the views which I expressed upon this subject in my previous note.

The material of *Equisetum arvense* (which was the only species used in this research) was collected in the autumn of 1908. A collection made on September 3 yielded sporangia, showing the various phases of the arche-sporial divisions. On September 8 and 9 the majority of the sporangia contained spore mother-cells in all stages of meiosis. On September 13 the meiotic divisions had been completed in almost all the sporangia and were only occasionally met with, but the strobili showed all stages of spore development from the naked, membraneless spore to the spores of  $38\mu$  diameter furnished with elaters. Later gatherings were made to complete

the series of spore development. The different sporangia upon a strobilus are usually found to differ considerably from one another with regard to the stage of development which they have reached. In a single transverse section of a cone it is quite usual to find a sporangium containing mother-cells with nuclei in diakinesis (of the first division) lying side by side with another sporangium enclosing the spore-tetrads already formed. Besides this difference between the sporangia of a strobilus a good deal of variety can also, not infrequently, be seen amongst the spore mother-cells of one and the same sporangium. For example, a sporangium containing in one part tetrads in which the young, membraneless spores were just commencing to separate from one another, enclosed at another spot spore mother-cells still in the metaphase of the homotype division.

Hofmeister (4) found a very similar variation to exist among the mother-cells of the sporangia of *E. palustre*. He wrote (pp. 283-4): 'In the same sporangium of *Eg. palustre* there may be found mother-cells with the primary nucleus in the act of dissolution, others with two flattened nuclei, and others with four globular daughter nuclei; there may also be found sets of four tetrahedral cells, individual daughter cells of a globular form, and lastly, others which already exhibit the transparent halo slightly developed.'

My material was fixed in absolute alcohol, alcohol and acetic acid mixture, and in Flemming's solutions. Of these the stronger solution of Flemming gave the best results and was chiefly employed for this study of the nuclear phenomena. For staining the sections I used Heidenhain's iron-alum-haematoxylin, either alone or in conjunction with Bismarck brown; Flemming's triple stain; and gentian violet and orange G without safranin. As I obtained excellent results with the gentian violet and orange G without safranin, I used either this combination or the Heidenhain's haematoxylin method for the majority of my preparations.

#### PREMEIOTIC DIVISIONS.

The resting nuclei of the archesporial cells of *Equisetum arvense* enclose a chromatic reticulum which varies somewhat in the degree of its fineness. In what are probably nuclei in a condition of complete rest this reticulum is very delicate and shows comparatively few and small chromatic aggregates. Pl. LI, Fig. 1 gives a good idea of a nucleus in this condition. In other archesporial nuclei the reticulum is coarser and contains here and there somewhat more obvious chromatic aggregates. These small collections of chromatin most often occur singly upon the reticulum, but occasionally two such lumps may lie side by side. This paired arrangement of the chromatin bodies, where such occurs, is without doubt a chance phenomenon depending upon natural or artificial tensions in the nucleus which stretch



the meshes of the network, here and there, so as to bring the two sides of the mesh closer together. When these two sides of the stretched mesh happen to contain chromatic thickenings upon them these will naturally form, in such cases, a parallel pair.

The degree of coarseness of the nuclear reticulum is also, no doubt, to some extent influenced by the penetration and action of the fixative.

At the same time, in the majority of cases, the coarser reticulum evidently denotes a nucleus which has not passed into such a complete condition of rest as the one enclosing the finer and more even network. It is possible that the coarser reticulum may always become more evenly distributed before the next division is entered upon, but it appears more probable that the nuclear condition in rest depends upon the rapidity with which the divisions are following one another.

The nucleoli are numerous in these resting nuclei. Three to six—or even more—nucleoli occur in each nucleus, and several of these can often be seen to be elongated, vermiform, or hour-glass shaped (Pl. LII, Fig. 16). The reticulum is usually contracted away from the nucleoli so as to leave a clear space round each of them. The nucleoli do not stain deeply, but colour as plasmosomes.

When a resting nucleus, such as that described above, is about to enter upon a mitotic division we find that certain of the arms and anastomoses of the network are withdrawn so that the meshes of the reticulum become larger and more open. This withdrawal of the cross connexions takes place along certain lines, so that there is a tendency manifested for lengths of filament, uninterrupted by anastomotic communications, to differentiate out of the network. At the same time the filaments of this looser and more open reticulum become thicker and more deeply stained with dyes. The nucleoli still continue to be large, numerous, and plasmatic in their standing reactions (Fig. 2).

The continued retraction of the branches and anastomotic connexions gradually leads to the formation of a spireme in which the filaments are smooth and stain fairly deeply in haematoxylin, gentian violet, &c. Quite early in its differentiation the spireme often shows a distinction of more darkly stained (chromatin) granules embedded in a lighter (linin) thread, but in my preparations of older stages I have failed to see this appearance.

The filaments which have arisen from a stage such as I have drawn in Fig. 2 by the further withdrawal of the branches of the reticulum, are still comparatively straight and show a certain amount of polarization (Fig. 3). This polarization of the filaments as they become differentiated out of the reticulum recalls the arrangement of the chromosomes during the telophase of the preceding division. It is not improbable, therefore, that the chromosomes which emerge at the prophase of a division may roughly occupy the

same relative positions as they did during the telophase of the previous division, when their outlines became lost to view owing to the development of numerous branches and cross connexions with one another.

It is especially to be noted that the spireme which develops from the reticulum forms at no time a continuous thread. From the beginning it is segmented into separate lengths which at first are long and slender, but which become thicker, shorter, more deeply staining, and more curved as mitosis advances. These facts are shown in Figs. 3, 4, and 5. The last of these figures shows that the definite polarization of the chromosomes has eventually become entirely lost, and that the curved filaments composing the segmented spireme coil in every direction through the nuclear cavity. Several conspicuous plasmosomes still remain enclosed within the coils of the spireme.

It will be seen that in the development of this spireme there is no concentration of the filaments by the approximation of longitudinal halves of previously alveolized chromosomes such as has been described in a number of other plants by several writers.

Indeed, the spireme, both when fully formed and during its development, appears in *Equisetum* to be quite unsplit longitudinally. Each chromosome appears in this plant to develop during the prophase solely by the drawing in of the anastomoses which had been formed at the close of the preceding division and by the concentration of the long, slender, but homogeneous filament, which first appears, into a shorter and thicker structure.

The nuclear membrane then disappears and the coil of chromosomes, together with the nucleoli, lies free in the cytoplasm. The chromosomes next become drawn upon the equator of the spindle which has developed in the usual manner. The chromosomes appear at this time as rather long and not very thick bodies which are bent into a longer arm directed towards the pole of the spindle and a shorter arm arranged upon the equator of this structure.

Soon after the chromosomes have become regularly arranged upon the spindle-equator they can be seen to be longitudinally divided (Fig. 6). As the longitudinal halves begin to separate from one another they not infrequently remain adherent or closer together at their distal ends whilst they are already quite widely apart at their proximal extremities. In these cases loop-like structures are formed such as I have represented in Fig. 7. The nucleoli can for some time be seen lying in the cytoplasm in the neighbourhood of the chromosomes, either among the spindle fibres or free from the mitotic figure, but as the daughter chromosomes begin to move apart the nucleoli are lost sight of.

In Fig. 8 I have represented a stage of the anaphase. It will be seen from this that the premeiotic spindle forms a blunt<sup>1</sup> structure, which differs

<sup>1</sup> It is of course possible that the blunt spindle may be due to the removal of the actual spindle

markedly in appearance from the sharply defined heterotype spindle, with its acute polar extremities.

The daughter chromosomes continue to move apart until they reach the ends of the spindle, where they become closely massed and intertangled in two groups corresponding to the two daughter nuclei (Fig. 9). After a time the tangle of chromosomes begins to open a little in each daughter nucleus, and a new nuclear wall is developed. At this stage of the telophase the chromosomes are still seen to be arranged for the most part with their long axes parallel with the longitudinal axis of the spindle. That is to say, they still roughly occupy the positions in which they reached the spindle extremities at the conclusion of the metaphase. No vacuolation, such as occurs in some other plants, is to be seen in the chromosomes of *Equisetum*. Their substance remains adherent at certain spots where they had come into contact when closely massed together at the conclusion of the metaphase, and these points of junction become drawn out into connecting threads when the chromosomes again separate from one another during the telophase. The chromosome substance becomes distributed along these anastomotic junctions and new lines of connexion appear to develop between the chromosomes, so that gradually the outlines of the chromosomes become obscured and the young nucleus is seen to contain a chromatic reticulum (Figs. 10, 11). This condition endures until the prophase of the succeeding division, when the anastomoses are again withdrawn and the chromosomes once more become recognizable as distinct entities, occupying, roughly, the same relative positions which they held at the conclusion of the telophase.

The activities performed by the so-called 'resting' nucleus can evidently be most satisfactorily performed when the chromatic contents are diffused more or less evenly through the nuclear cavity, whilst for the mitotic division concentration of this material is essential. It appears to be of relatively small importance how the diffusion of the chromatin is effected. In some cases it is attained chiefly through the vacuolization of the chromosome bodies; in others the chromosomes break up into shorter lengths and eventually into granules, whilst in such cases as *Equisetum* the development of anastomotic connexions between the chromosomes and the distribution of their substance along these branches are the most important factors in obtaining a diffusion of the chromatin through the nucleus. In any case, however this diffusion of the chromosome substance is brought about in the telophase, the same steps usually appear to be retraced during the prophase of the succeeding division.

In *Equisetum*, therefore, the telophase finally leads to the development of a typical resting reticulum such as the one with which we started this

apex by the microtome knife, but the occurrence of obtuse ends was so constant and invariable a phenomenon in my preparations that I felt obliged to reject this interpretation.

account. It depends upon the degree to which the chromosome substance becomes diffused whether a coarse or a fine network results.

Soon after the new nuclear membranes have developed round the daughter nuclei, and therefore at an early stage of the telophase, one or more nucleoli can be observed lying among the chromatin contents (Figs. 10, 11).

#### FIRST MEIOTIC DIVISION.

At the conclusion of the last premeiotic division the nucleus passes into a complete condition of rest indistinguishable from that separating one premeiotic division from another. Such a nucleus I have already illustrated in Fig. 1. At the commencement of meiosis there is a small but distinct growth in size of the nuclei, the average nuclear diameter of the resting cell being  $14\ \mu$ , whilst that of the nuclei shortly before synapsis is  $17\ \mu$ . During this growth many of the anastomoses of the chromatic reticulum become withdrawn, so that the close network of the resting nucleus is converted into a much looser one with wider meshes (Fig. 12). The nucleoli still remain in about the same number (usually from three to eight), and with the same appearance, as in the resting nuclei.

The next step in the progress of meiosis is the contraction of the chromatin network. In Fig. 13 we see that this contraction has commenced on one side of the nucleus, whilst in Fig. 15 the synaptic contraction has been completed. The nucleoli, which not infrequently appear vacuolated at this period, are partly enclosed among the contracted meshes of the chromatin reticulum, whilst others may lie free from the tangle.

During synapsis the chromatin network becomes finally transformed into an unbranched spireme free from all anastomotic connexions. This is already clear at the stage represented in Fig. 17 *a*, in which the coil of chromatin is becoming loosened and redistributed through the nuclear cavity. Another fact is apparent in the same drawing, and this is the clear demonstration of the existence of a longitudinal split in the filaments which are uncoiling. The short length of spireme depicted in Fig. 17 *b* shows this particularly well.

Gradually the spireme, free from all cross connexions or anastomoses, unfolds entirely and winds freely through the nuclear cavity (Figs. 18, 19). The longitudinal division of the threads, which could be clearly seen as the synaptic tangle loosened, is usually again lost sight of when the spireme has completely developed. As a rule the filaments are smooth, slender, and homogeneous in appearance. Occasionally, when the differentiation of the stain has been brought to a particular point, the appearance of lighter and darker coloured areas, corresponding to a differentiation of linin and chromatin, can be seen, but usually the thread is stained uniformly. There is a good deal of difference between the arrangement of the coils of the

spireme to be seen according as we examine a median or a peripheral section of the nucleus.

In Fig. 18 I have represented a median section of a nucleus, where it will be seen that the filaments appear to be arranged without order. In Fig. 19 is shown a peripheral section through a neighbouring nucleus at precisely the same stage. Here it will be observed that there is a very definite order in which the threads are grouped, and that they exhibit a certain amount of parallelism with one another.

Another feature of some importance is very evident in the spireme of this plant, and that is the discontinuity of the thread. It is only necessary to glance at any of the figures which I have given (Figs. 18, 19, 20, 27) to see at once that free ends of the filaments are of frequent occurrence, and that the spireme is segmented up into comparatively short lengths. Up to this time the cells of the sporogenous tissue have remained united as a single block of tissue surrounded by the tapetum. Each spore mother-cell is bounded by a thin wall, which gives the reactions characteristic of pectic bodies.

During the stage of the spireme, however, the membranes separating the spore mother-cells become split and the cells begin to separate from one another. Each mother-cell is at this time still covered by a delicate film of membrane which is the remains of the septum which formerly separated one cell from another.

Each spore mother-cell rounds itself off as it becomes isolated from its neighbours. In the meanwhile the tapetal cells have also lost the membranes which separated them from one another, and have flowed together to form a richly nucleated plasmodium. This tapetal plasmodium now begins to penetrate into the interior of the sporangium and to surround the sporogenous cells as these become isolated. As I pointed out in my previous note, and as Hannig (3) has confirmed, the tapetal cytoplasm first makes its way between the sporogenous cells, and the tapetal nuclei follow suit slightly later.

In somewhat older spore mother-cells the nuclear spireme has increased a little in thickness and become more retentive of chromatic dyes. In such nuclei the longitudinal division of the spireme can usually be again seen (Fig. 20). This stage immediately precedes a period during which the nuclear contents lose their regularity of outline and become drawn together. During this phase, which may be called that of the 'second contraction' (although there is not such a profound massing of the nuclear contents as is the case in some other plants),<sup>1</sup> it often becomes very difficult to correctly interpret the changes which are taking place within the nucleus. It is only when the almost fully developed bivalent chromosomes emerge from the confusion that it again becomes easy to follow the course of events.

<sup>1</sup> Cf. Miss Digby's figure of *Primula verticillata*, for example, (2) Plate XLII, Fig. 46.

One is at first tempted to conclude that each half of a longitudinally divided spireme segment condenses to form one of the two members of a bivalent chromosome, and therefore to consider that the heterotype chromosomes develop by a process of parasynapsis.

This was the conclusion to which I first came and to which I gave expression in my former note. Since that article was written, however, I have had the opportunity of subjecting the phase of 'second contraction' to a much closer scrutiny, and I have been successful in finding cases in which the entire course of events could be uninterruptedly followed from the stage of the longitudinally divided spireme segments (previous to the second contraction) up to the appearance of the fully developed heterotype chromosomes.

The study of these unusually clear examples has shown that my former conclusions were erroneous, and that, instead of having an example of the parasynaptic origin of the heterotype chromosomes in *Equisetum*, this plant really furnishes a rather striking instance of their origin end to end.

Before dealing further with the second contraction, it is first necessary to consider the appearance of the nucleoli in these nuclei during the preceding stages of meiosis, as the peculiar behaviour of these bodies during the contraction adds no little to the confusion of that stage. In the resting nucleus, following the telophase of the last premeiotic division, a large number of medium-sized plasmatic nucleoli occur. It is not uncommon to find as many as eight nucleoli in a single such nucleus. Many of the nucleoli are spherical, whilst others are elongated, vermiform, or hour-glass shaped. Several forms are represented in Fig. 16. Some of these constricted nucleoli may possibly be undergoing division, but, in the light of what occurs a little later in their history, I believe that the majority of these hour-glass-shaped bodies are instances of nucleolar fusion rather than of their division. The outlines of these nucleoli are usually perfectly smooth, and it is only very rarely that any budding of material from their surface can be seen at this period. In older nuclei which are just about to pass into the synaptic contraction it can often be seen that the nucleoli, six to eight in number, approach one another and unmistakably fuse into a few larger bodies.

In Fig. 14 it will be seen that on the left five nucleoli are grouped together but have not yet fused, whilst on the right of the nucleus three nucleoli have merged together into a single vermiform structure which still clearly shows the points of fusion. Fig. 27 shows further nucleolar fusions at this stage. During synapsis the fusion of nucleoli is completed, and by the time the spireme has unfolded the nucleoli have been reduced to one or two comparatively large bodies (about 3 or 3.5  $\mu$  in diameter). That the single (or few) large nucleolus of the spireme is derived from the fusion and not from the partial absorption of the numerous nucleoli of the pre-

ceding stages is clearly shown by the comparison of the amount of nucleolar matter which occurs in the two cases.

Up to the time of the establishment of the spireme the nucleoli are smooth in outline and show no evidence of budding. During the stage of the spireme, and especially a little later when the second contraction is taking place, we find the nucleolus actively extruding material from its surface in the form of droplets or buds (Figs. 20, 21).

It is noteworthy that this active extrusion of nucleolar material into the nuclear cavity is synchronous with the commencement of a period during which there is growth in thickness of the spireme segments and a great increase in their staining power.

Droplets of nucleolar material, varying from very minute globules to quite large bodies, are rapidly given off from the surface of the nucleolus. These pass into the nuclear cavity and become distributed along the spireme threads, to which they adhere (Fig. 21). At the same time the spireme segments are drawn more closely together, and often appear to be centred in the neighbourhood of the nucleolus (Fig. 22).

This tendency for the spireme filaments to become drawn together at one or more points, together with the presence of deeply staining nucleolar matter on and between them, leads to the obscuration of detail which marks this stage of meiosis. We may probably conclude that during this period chromatic material, elaborated by the nucleolus, is leaving that body and passing into the spireme segments, which in consequence grow in size and exhibit a greatly heightened affinity for dyes. At first the droplets of nucleolar substance merely adhere to the surface of the developing chromosomes and give these an irregular outline (sp. Figs. 21, 22, 23), but gradually the material becomes absorbed into the interior of these bodies.

It has already been mentioned that the spireme is segmented into a number of parts from a very early period in its history, and it now remains to be seen what relation these segments bear to the bivalent chromosomes of the heterotype division. Even in the early spireme many of these segments are more or less curved or bent. During the later stages, and especially during the second contraction, this curvature of some of the spireme segments becomes more marked, and in many instances leads to the formation of definite loops (Fig. 22). In the case of some other segments the curvatures may be only very slight or they may remain almost straight. Many of these loops and bent or straight spireme segments still show, at places, the existence of the longitudinal split, which was very obvious just before the commencement of the second contraction (Figs. 22, 24). Some of the loops are seen to be breaking across transversely at the point of curvature (see the loop on the left of Fig. 22), and by this means two completely separate, longitudinally divided elements, derived from the bending over of a single spireme segment, come to lie side

by side in the nucleus. Other segments maintain their integrity as unbroken loops or more or less bent filaments for some time longer.

In Fig. 24 it can be seen that there has been a great increase in the thickness and staining power of the segments, partly due to the condensation of their substance and partly owing to the absorption of chromatic material derived from the nucleolus.

In Fig. 25 the condensation of the segments has proceeded further, and we now see that these structures form unquestionable bivalent chromosomes in diakinesis. The passage of one structure to the other has, however, been so gradual and continuous that it is impossible to mistake the true relation existing between them. Many of the bivalent chromosomes at diakinesis are still in the form of unbroken loops, like the longer and more slender spireme segments which preceded them; others have separated across the loop, so that their two constituent elements are free from one another and lie side by side or in the shape of a cross or in some other similar position. No one with an unbiased mind who closely studies the series of steps which intervene between the first unfolding of the segmented spireme from the synaptic coil and the appearance of the fully formed heterotype chromosomes in diakinesis can be in doubt regarding the manner of origin of these chromosomes.

The facts show in an unmistakable manner that each segment of the spireme is composed of two elements (somatic chromosomes) joined end to end. These somatic chromosomes are at first long and slender, but they gradually become shorter and very much thicker, partly by the condensation of their substance and partly by the addition of fresh chromatic material derived from the nucleolus. At the same time each pair of somatic chromosomes usually becomes more or less sharply bent across into the form of a loop, so that the two chromosomes come to lie side by side or, at any rate (in the majority of cases), to approach one another laterally. Sooner or later the loops become ruptured at the bend so that the two members of each heterotype chromosome are finally independent of one another. For a long time during their development these chromosomes can be seen to be longitudinally divided, but when their condensation has been completed this split again becomes lost to sight (Fig. 25).

In Fig. 26 I have represented a few of the typical forms which these heterotype chromosomes may assume in *Equisetum*. In *a* we have a short, thick loop formed by the two constituents of the bivalent chromosome; in *g* and *e* the form is also that of a loop—but of a much more shallow character. In *b* the two somatic chromosomes have developed end to end in a straight line without any signs of curvature. In *f* the pair of chromosomes are arranged in the form of a cross; in *c* they lie side by side, but diverge from one another at one extremity; in *d* the two curved chromosomes also lie side by side, but owing to their curvature both ends



diverge from one another. This last form of chromosome when viewed under unfavourable optical conditions can easily be mistaken for a tetrad of spherical bodies lying close together. This fact no doubt explains the 'tetrads' described and figured by Osterhout (see Osterhout (5), p. 160 and Tafel I, Fig. 1).

Ring-shaped chromosomes (Fig. 26, *h*) are also frequently met with in these nuclei. During diakinesis the chromosomes are mostly arranged peripherally just below the nuclear membrane, but a few chromosomes usually remain closely grouped round the nucleolus as though the concentration of the nuclear contents which is seen at this point during the second contraction had not completely passed away (Fig. 25).

The surface of the chromosomes is, at this time, often somewhat irregular owing to the presence of minute, thorn-like processes upon it. At these points very fine filaments can be seen to be attached, and these join each bivalent chromosome to other neighbouring ones (Fig. 25).

Besides these delicate filaments some flocculent achromatic material occurs in the nuclear cavity between the chromosomes (Fig. 25). Each nucleus contains either one large nucleolus alone or one large one and several smaller ones.

When the spindle is developed and the nuclear membrane has disappeared one or more nucleolar bodies can usually be seen to have been extruded into the cytoplasm. These bodies occupy various positions, sometimes lying free in the cytoplasm and sometimes caught up among the spindle fibres. They usually exhibit no definite relation to the spindle poles, but occasionally one may lie in the neighbourhood of one of the poles of the multipolar spindle.

These nucleolar bodies are still quite distinctly visible during the late anaphase and the early stages of the telophase (Pl. LIII, Fig. 33).

In a few of my preparations of diakinesis in *Equisetum* some of the nucleoli appear to be disintegrating within the nuclear cavity. These cases suggest that at least some of the flocculent achromatic material in the nucleus may be derived from the nucleoli.

Osterhout (5) has already investigated the development of the spindle in great detail, and my observations, so far as they go on this point, entirely confirm his work. A multipolar polyarch spindle is developed in the cytoplasm immediately surrounding the nucleus; the nuclear membrane disappears and spindle fibres develop within the former nuclear cavity. These intranuclear fibres become attached to the chromosomes and place these in connexion with the extranuclear spindle fibres (Pl. LII, Fig. 28). The dissolution of the nuclear membrane is gradual, and it can often be observed that it has disappeared completely at one spot whilst it is still clearly visible at another.

The multipolar polyarch spindle is later converted into a multipolar

diarch structure (Fig. 29), and this subsequently develops into a bipolar structure (Fig. 31). The bipolar spindle is remarkably well defined and is characterized by its very acute and attenuated pole ends. No centrosomes are to be observed at this or any other stage of the division. The chromosomes become arranged upon the equator of this spindle. They are at this time smaller and denser bodies with a more even outline than they previously possessed. At this stage an estimate of their number can be more satisfactorily made than at any other time. Although I have made repeated counts I have found it impossible to do more than arrive at an approximate estimate of the chromosome number in *Equisetum*. Where the chromosomes are so numerous and closely crowded together it is almost inevitable that some should become hidden beneath their neighbours and thus be missed when the count is made.

Moreover, when an equatorial plate of chromosomes appears in more than one section, as is usually the case, the same chromosome may be cut so as to be represented in two (or more) sections, and it then becomes extremely difficult to avoid counting it twice over. In those cases in which the clearest view of the chromosomes could be obtained by counts varied from 94 to 136. Probably the mean of these numbers, viz. 115, is not very far removed from the true number of chromosomes in *Equisetum*.

The form of the chromosomes when arranged upon the equatorial plate of the spindle is shown in Fig. 30. The spindle fibres, which are attached to the chromosomes, are each composed of a bundle of fine filaments, as can be seen from the drawing (Fig. 30). During the metaphase the spindle poles show no trace of polar radiations, but during the anaphase when the chromosomes are approaching the poles radiations extending into the cytoplasm become apparent (Pl. LIII, Figs. 32, 33).

The distribution of the univalent chromosomes to the two poles takes place very irregularly. From Fig. 32, which represents a typical case, it will be seen that whilst some of the chromosomes are already far on their way to the spindle ends, others are as yet only commencing their journey. The majority of the chromosomes become more or less elongated in form during the earlier stages of the anaphase as though stretched longitudinally by the spindle fibres. On reaching the poles of the spindle the chromosomes again become short, dense bodies which are small in comparison to their size at an earlier period (Fig. 33). They become so closely massed together at each pole that it is often difficult to distinguish the outline of the separate chromosomes. Nucleolar bodies, extruded into the cytoplasm, can frequently be still recognized at this stage.

Soon the mass of chromosomes begins to loosen again, and a new nuclear membrane develops round each group. As the chromosomes move apart their soft mucilaginous substance remains adherent at certain spots which become drawn out into connecting branches between the separate

chromosomes (Fig. 36). The chromosome bodies become, to a certain extent, vacuolated (Fig. 36), but this is not so conspicuous a phenomenon as is the case in some other plants. Besides this vacuolation the substance of the chromosomes is distributed along the anastomotic connexions which join them together; new anastomotic junctions develop and the chromosome substance becomes diffused along these in turn. By these means the material composing the chromosomes becomes gradually more or less evenly distributed through the nuclear cavity to form a typical resting nucleus in which the bodies of the chromosomes are only faintly indicated (Fig. 35) and eventually altogether lost to view (Fig. 37). One or more small nucleoli make their appearance in each of the daughter nuclei.

A feature of some interest in the transformation of the chromosomes during the telophase is the gradual elongation of these short, dense bodies and the dispersal of the greater part of their material along certain definite lines. In Fig. 34 the elongation of the chromosome bodies, which are already united with one another by anastomotic junctions, is clearly seen, whilst in Fig. 35, which represents a later stage, the substance of the chromosomes has become much more diffused, but the definite lines along which the chromatic material has principally spread, and which represent the cores (so to speak) of the chromosome bodies, are perfectly distinct.

A little later, when the diffusion of the chromatic contents has proceeded still further and new cross connexions have been developed, the nucleus attains a condition of complete 'rest' in which the elongated remains of the chromosome bodies can no longer be traced (Fig. 37). During the prophase of the succeeding homotype division, however, the chromatic contents of the nuclei again become concentrated along certain definite lines which by further concentration develop into the elongated, slender chromosomes characteristic of the homotype division in this plant (Fig. 38). It would seem, from these facts, to be quite probable that the transformation of the short, thick heterotype chromosomes into the comparatively long, slender chromosomes of the succeeding division is already prepared for during the telophase of the heterotype division. The first manifestation of the homotype division is seen, as I have already mentioned, in the appearance of certain definite lines of concentration into which the strands and cross connexions of the nuclear reticulum become withdrawn (Fig. 38). These lines of concentration map out the bodies of the future chromosomes. There are usually several medium-sized nucleoli present at this stage. As concentration proceeds the chromosomes become more distinctly recognizable, but they are for some time irregular in outline and remain united together by anastomotic junctions. Fig. 39 shows this stage, and it will also be noticed from the figure that the chromosome rudiments have increased considerably in staining power. The nuclear membrane still remains intact, but a mantle of spindle fibres has developed

round the nucleus. In Fig. 39 the nucleus has shrunk slightly, so that the relation between nuclear membrane and extranuclear spindle fibres is seen unusually well.

Very soon, however, the nuclear membrane disappears and the rather confused tangle of chromosomes lies among the spindle fibres, which are now both intranuclear and extranuclear in origin. At first the chromosomes do not appear to be quite free from one another, but soon they free themselves and arrange their long axes parallel with the long axis of the spindle. They are now long, thin, smooth structures (Fig. 40). The spindle in many cases is multipolar diarch in origin (Fig. 40), but in other instances it is clearly multipolar polyarch (Fig. 41). In either case, however, it always becomes bipolar later on (Fig. 43). The nucleoli may remain entangled among the chromosomes or they may pass out at once into the surrounding cytoplasm.

Owing to their close arrangement during the prophase the individual chromosomes are usually rather difficult to study satisfactorily at this stage, but in a few favourable cases it was observed that some at least of the chromosomes were longitudinally divided (Fig. 42). Soon, however, the chromosomes arrange themselves upon the equator of the spindle, and then it is easily possible to repeatedly observe the longitudinal split in their substance (Fig. 43). The daughter chromosomes separate from one another during the anaphase, and in Fig. 44 these chromosomes are seen to have reached the poles of the spindle and are there closely grouped together with their free ends directed towards the equatorial region. A nuclear membrane develops round each group of daughter chromosomes, but certain of the longer chromosomes still protrude for a time beyond the general surface of the nuclei (Fig. 45). A little later the protruding chromosome-extremities are retracted, and the nucleus presents a smooth outline (Fig. 46). The substance of the chromosomes becomes dispersed along the anastomotic connexions which develop between them, so that the outlines of these bodies are gradually lost to view. No distinct vacuolation of the substance of the chromosomes could be seen, but the slender character of these bodies makes observation of this point very difficult.

One or two nucleoli make their appearance in each nucleus at this time. The nuclear division is followed by cell division, and four spores are produced which are at first completely unprotected by a distinct membrane. The nucleus of the young spore soon after cell division has been completed contains one or two distinct nucleoli and a reticulum in which the outlines of the chromosomes have been quite lost to view.

A little later, when the spores of a tetrad are just becoming separated from one another by the intrusion of tapetal cytoplasm, the nuclear reticulum has become slightly coarser and more chromatic than before, but the most striking difference between the nuclei at this stage and those at a somewhat

earlier phase lies in the considerable increase of nucleolar matter which they exhibit. Fig. 47 represents a typical example of a spore at this stage, and it will be noticed that not only has the number of nucleoli increased within the nuclear cavity, but other bodies with all the appearances and staining powers of nucleoli also occur in the cytoplasm.

I have not succeeded in tracing an actual extrusion of nucleolar material from the nucleus, but it appears not unlikely that this does take place and thus accounts for the origin of the nucleolus-like bodies lying in the cytoplasm.

Very probably the increase in nucleolar matter is associated with the active metabolic processes which are taking place within the spore at this time in connexion with the elaboration of an exospore.

#### SUMMARY.

##### A. *Premeiotic divisions.*

1. The resting nucleus of the archesporial cells contains a reticulum which varies in the degree of its fineness. It may be very delicate and even or it may be coarser with small chromatic aggregates upon it. These chromatic aggregates, when they occur, show no constancy either in their arrangement or in their number.

2. A spireme develops from the nuclear reticulum by the gradual withdrawal of branches and anastomotic connexions, so that first a close reticulum is converted into an open one, and then certain lines of concentration become apparent.

3. The spireme is discontinuous from the first.

4. By further concentration the segments of the spireme shorten into the chromosomes, which become arranged upon the equator of the spindle which has in the meanwhile developed. The chromosomes are now seen to be longitudinally divided.

5. The daughter chromosomes next move to the poles of the spindle, where they become closely massed together. Subsequently they open out, and their substance becomes distributed along numerous branches and anastomotic connexions which develop between them. It appears to be entirely by these means, and without any indications of internal vacuolation, that the reticulum of the resting nucleus develops from the chromosomes in *Equisetum*. A nuclear membrane is formed round each daughter nucleus.

6. A period of complete 'rest' intervenes between the last premeiotic division and the heterotype division.

##### B. *Meiotic divisions.*

7. Meiosis commences with the gradual withdrawal of many of the branches and cross connexions of the reticulum.

8. Synaptic contraction then occurs, during which the final conversion

of the reticulum into the spireme takes place. This spireme is seen to be longitudinally divided, and segmented into a number of separate pieces.

9. A period of great nucleolar activity and of partial contraction of the spireme elements ('second contraction') then occurs. During this period the nucleoli are seen to be actively extruding droplets (or 'buds') of material which pass into the nuclear cavity, where they adhere to the spireme filaments. A portion of this nucleolar material appears to be absorbed by the spireme segments and to contribute to their growth and staining power.

10. The spireme segments, which are often bent into the form of loops, become gradually shorter, thicker, and more chromatic, until they can be recognized as unmistakable heterotype chromosomes. The whole process of the transformation of the spireme segments into the heterotype chromosomes can be followed so continuously that there can be but little doubt regarding the relation of one structure to the other.

Each spireme segment consists of two univalent chromosomes arranged end to end, and each such pair develops, by concentration, into one of the bivalent chromosomes of the heterotype division.

11. The number of chromosomes is about 115.

12. By vacuolation and the development of anastomotic connexions the material of the chromosomes becomes dispersed through the nuclear cavity during the telophase and a 'resting' nucleus results during interkinesis.

13. The spindle of the homotype division shows some variation in the mode of its origin. In some cases it is multipolar polyarch during the earlier stages of its development, in others it is multipolar diarch. Eventually it always becomes a bipolar structure.

14. The daughter chromosomes which reach the poles of the homotype spindle develop numerous branches and cross connexions, along which their substance passes, but no distinct vacuolation of their bodies could be seen during the telophase of the division.

---

#### BIBLIOGRAPHY.

1. BEER, RUDOLF: The Development of the Spores of *Equisetum*. New Phytol., vol. viii, No. 7, 1909, p. 261.
2. DIGBY, L.: The Cytology of *Primula kewensis* and of other related *Primula* Hybrids. Ann. Bot., vol. xxvi, April, 1912, p. 357.
3. HANNIG, E.: Ueber die Bedeutung der Periplasmodien. I. Die Bildung des Perisporis bei *Equisetum*. Flora, Bd. cii (Bd. ii, neue Folge), Heft 3, 1911, p. 209.
4. HOFMEISTER, W.: On the Germination, Development, and Fructification of the Higher Cryptogamia, &c. English translation published by the Ray Society, London, 1862, pp. 266-306.
5. OSTERHOUT, W. J. V.: Ueber die Entstehung der karyokinetischen Spindel bei *Equisetum*. Jahrb. f. wiss. Bot., Bd. xxx, Heft 2, 1897, p. 159.

## EXPLANATION OF PLATES LI-LIII.

Illustrating Mr. Beer's paper on Spore Development in *Equisetum*.

All the figures were drawn with the aid of a camera lucida. Zeiss's apochromatic objective 2 mm. (apert. 1.40) and compensating ocular 18 were used for making the drawings. The magnification in all cases is about 2,700 diameters.

## PLATE LI.

- Fig. 1. Archeporsial cell with 'resting' nucleus.
- Fig. 2. Archeporsial cell; prophase of division.
- Figs. 3, 4. Archeporsial cells; later stages of prophase of premeiotic division.
- Fig. 5. Spireme of premeiotic division.
- Fig. 6. Metaphase showing the longitudinal division of the chromosomes.
- Fig. 7. Metaphase showing the separation of the longitudinal halves of the chromosomes.
- Fig. 8. Anaphase of premeiotic division.
- Fig. 9. Daughter chromosomes massed at the two poles of the spindle.
- Figs. 10, 11. Telophase of premeiotic division.
- Fig. 12. Commencement of prophase of first meiotic division. Open reticulum.
- Fig. 13. Beginning of synapsis.
- Fig. 14. Nucleus shortly before synapsis, showing fusion of nucleoli.
- Fig. 15. Synapsis.

## PLATE LII.

- Fig. 16. Nucleoli from 'resting' nuclei of archeporsial cells.
- Fig. 17, *a, b, c*. Spireme emerging from synapsis. The longitudinal split in the spireme is shown.
- Figs. 18, 19. Spireme.
- Fig. 20. Spireme segments with longitudinal division.
- Figs. 21, 22. Second contraction.
- Figs. 23, 24. Stages in the development of the heterotype chromosomes.
- Fig. 25. Heterotype chromosomes in diakinesis.
- Fig. 26, *a-h*. Various forms of heterotype chromosomes.
- Fig. 27. Fusion of nucleoli previous to synapsis.
- Fig. 28. Multipolar polyarch spindle of first meiotic division.
- Fig. 29. Multipolar diarch spindle developed from the multipolar polyarch structure.
- Fig. 30. Chromosomes arranged on the spindle during the metaphase of first meiotic division.

## PLATE LIII.

- Fig. 31. Fully developed bipolar spindle.
- Fig. 32. Anaphase of first meiotic division.
- Fig. 33. Conclusion of anaphase.
- Figs. 34, 35. Telophase of first meiotic division.
- Fig. 36. Details of chromosomes during telophase, showing vacuolation and branching of their substance.
- Fig. 37. Nucleus during interkinesis.
- Figs. 38, 39. Prophase of second meiotic division.
- Figs. 40, 41. Two modes of development of spindle during second meiotic division.
- Fig. 42. Prophase of second meiotic division, showing chromosomes longitudinally divided.
- Fig. 43. Metaphase of second meiotic division.
- Fig. 44. Anaphase of second meiotic division.
- Figs. 45, 46. Telophase of second meiotic division.
- Fig. 47. Spore of *Equisetum* at early stages of its development.







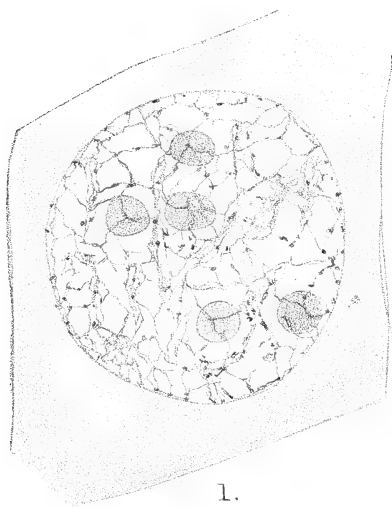

1.

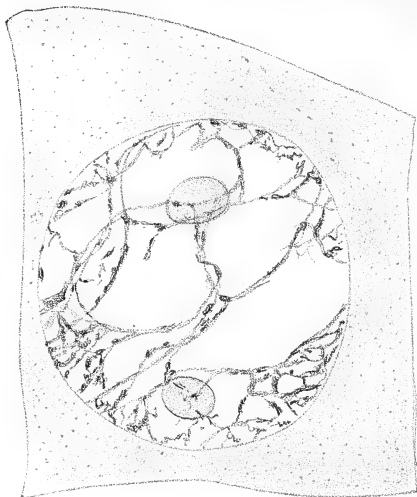

2.

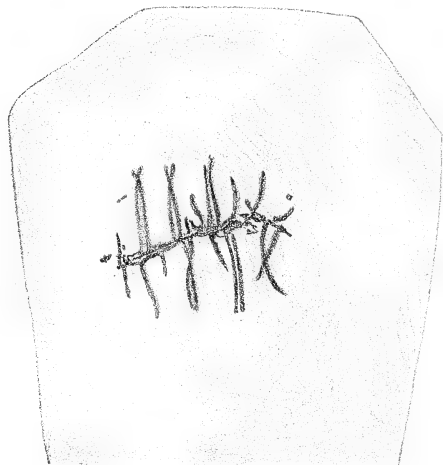

6.

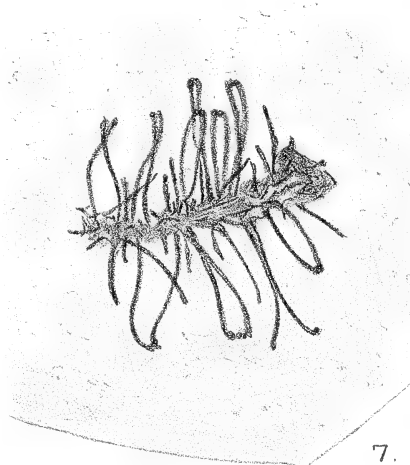

7.

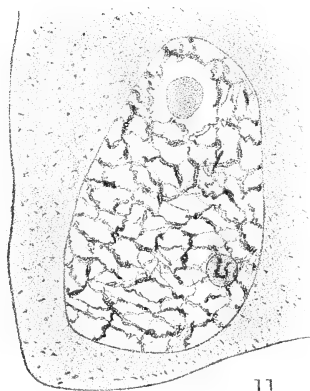

11.

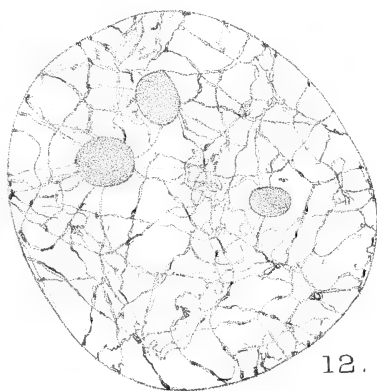

12.



13.

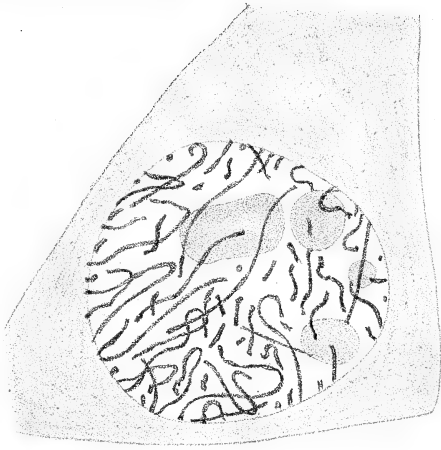

4.

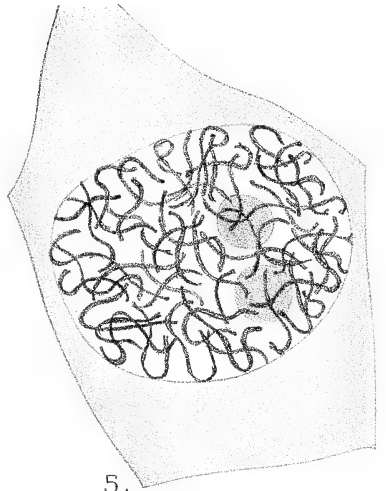

5.

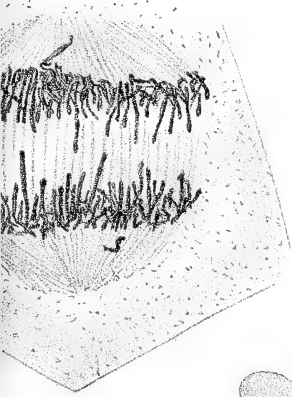

8.

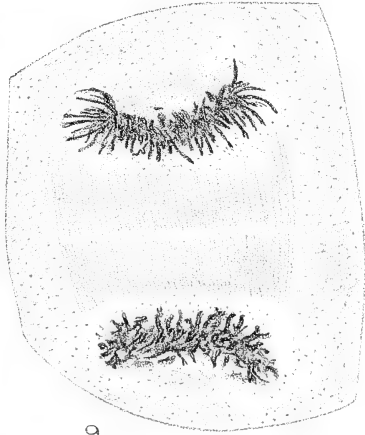

9.

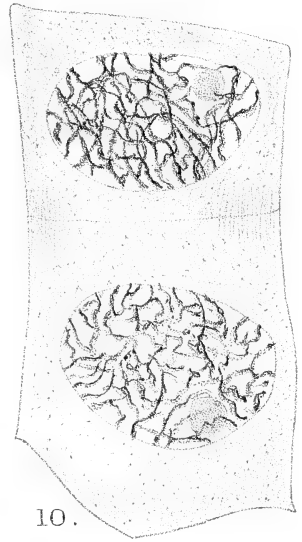

10.

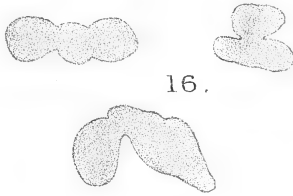

16.

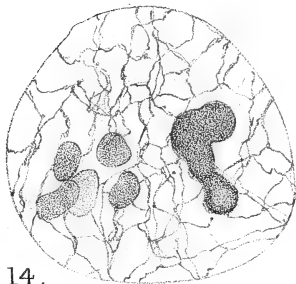

14.

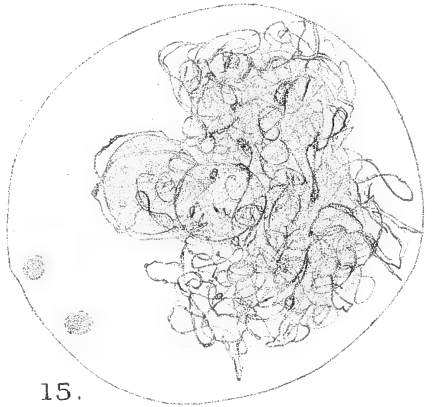

15.



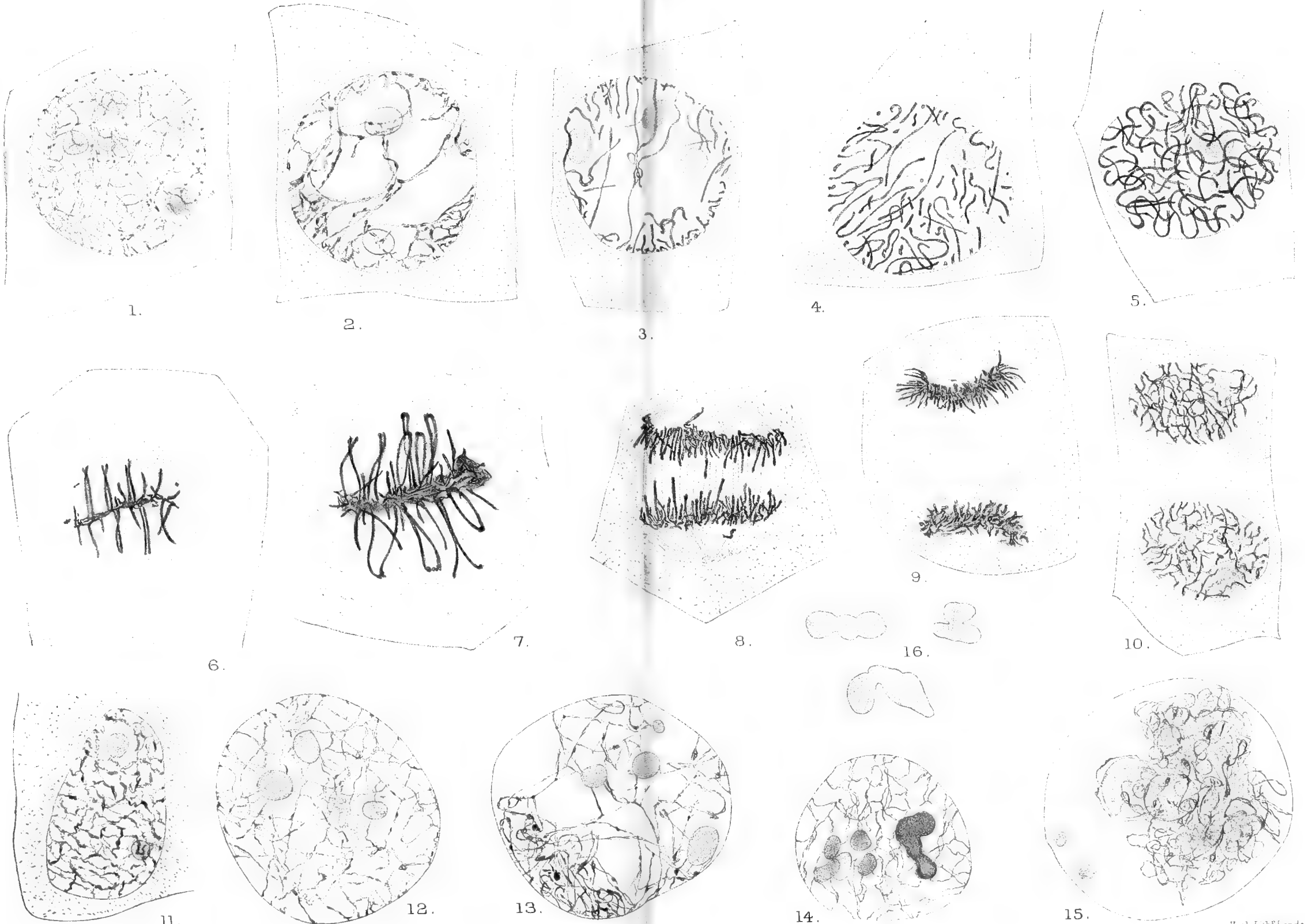

BEER-EQUISETUM.

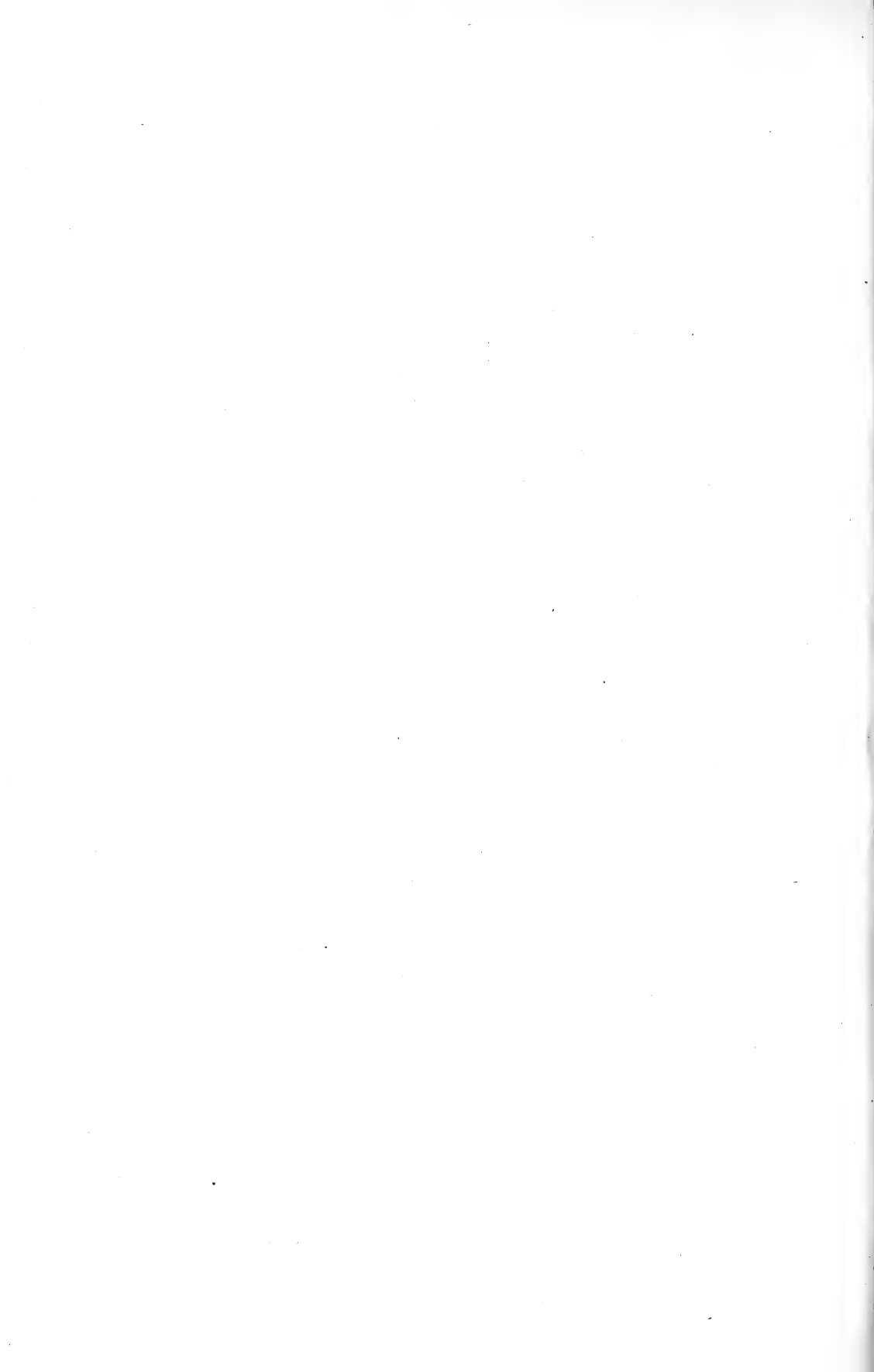



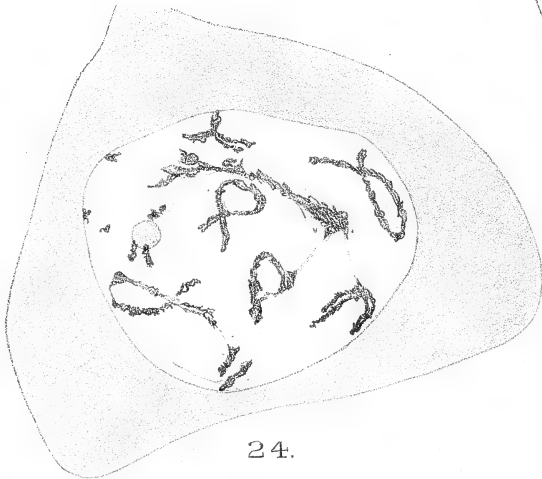
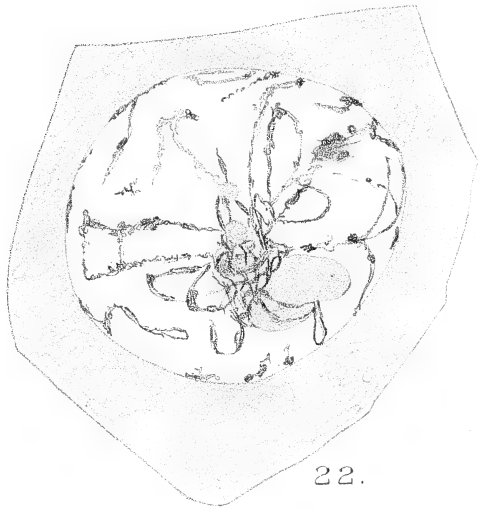
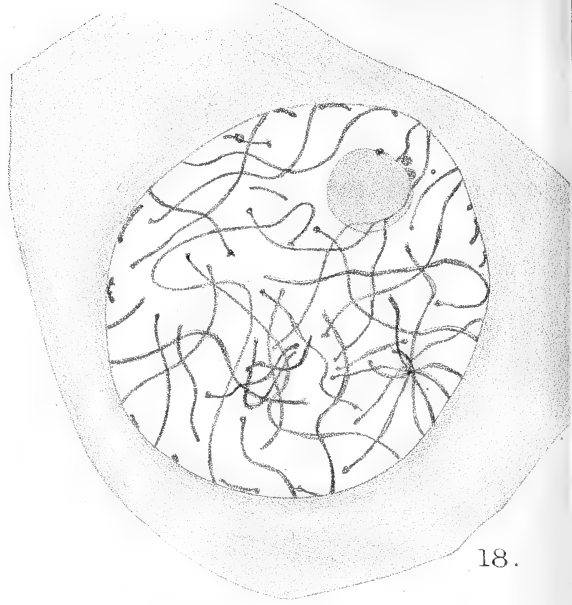
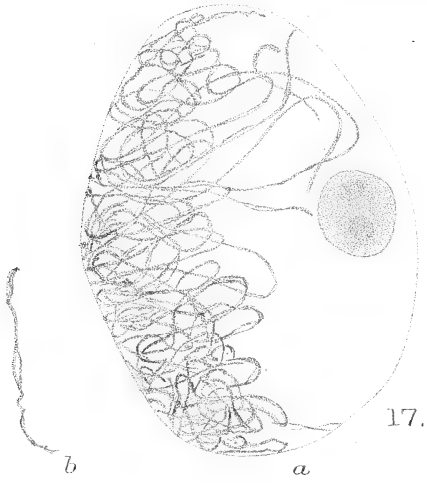





20.

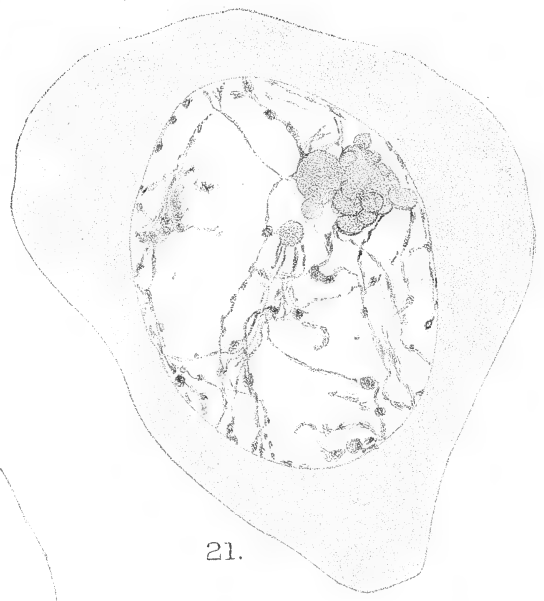

21.

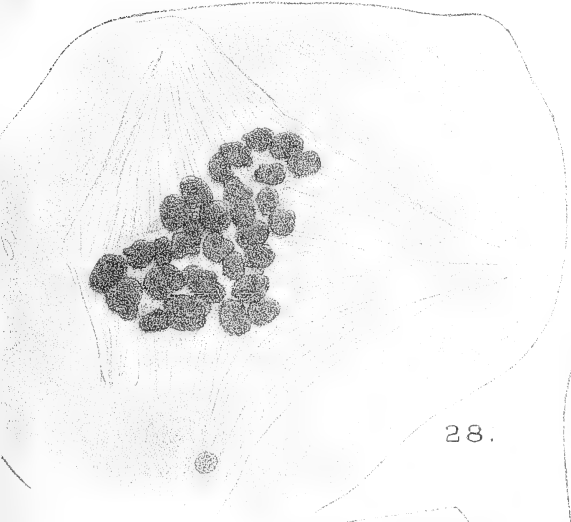

28.

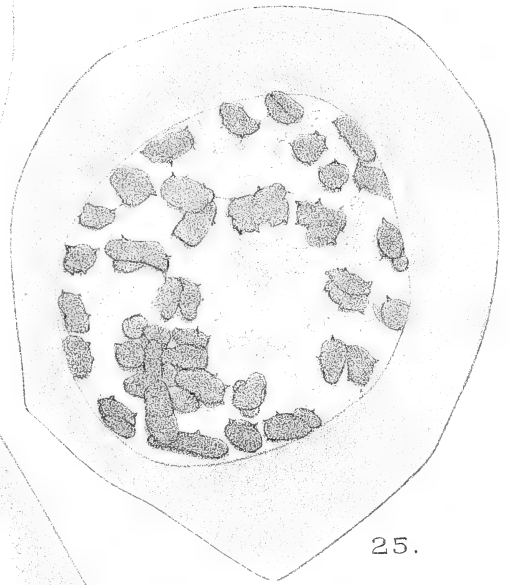

25.



19.



29.

30.

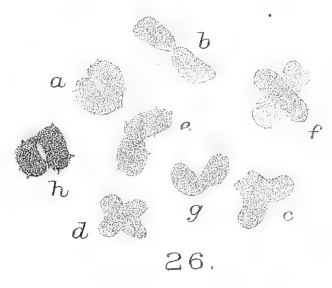

26.



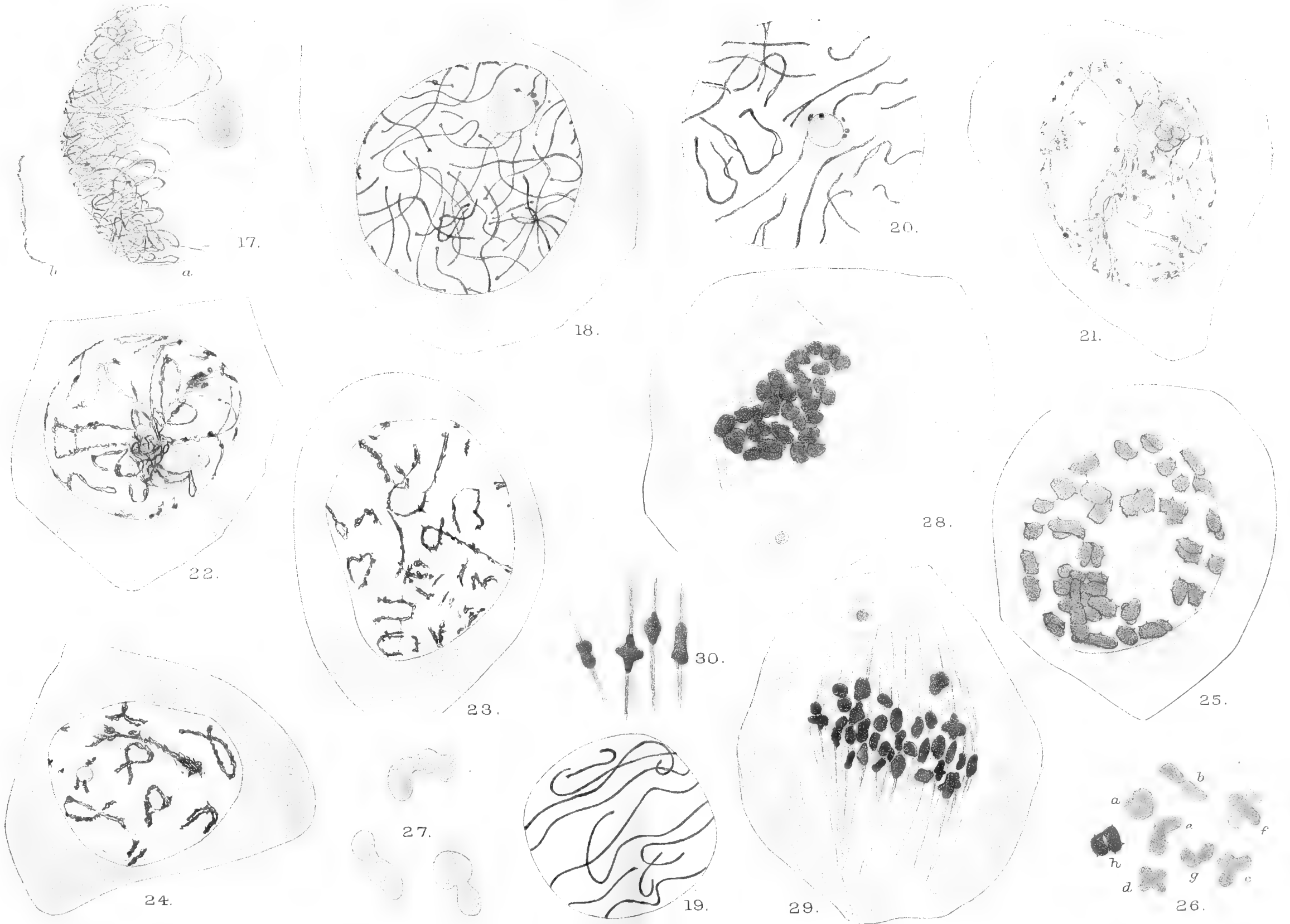

BEER-EQUISETUM.





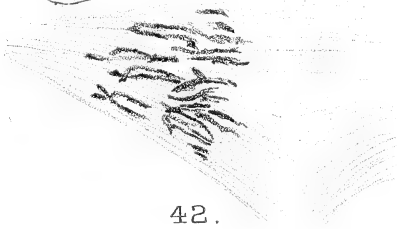
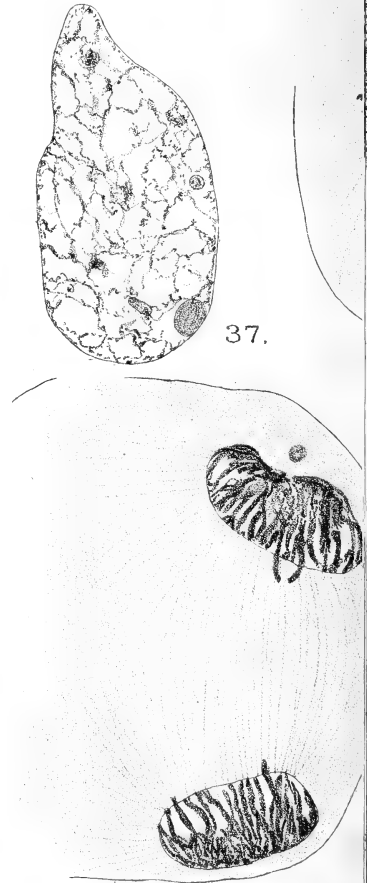
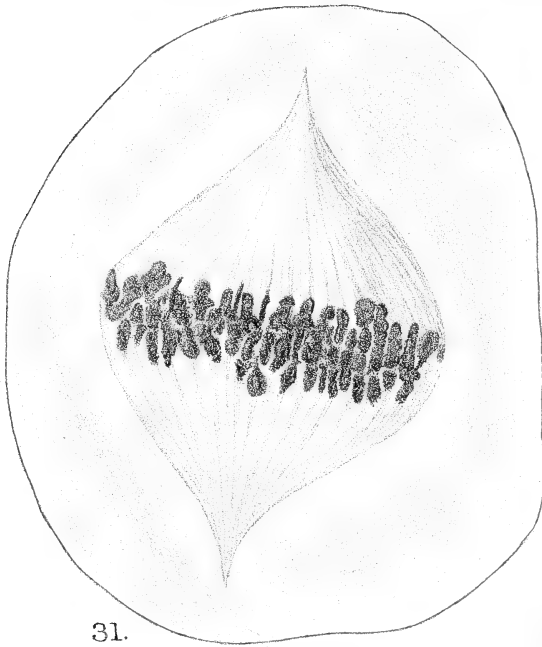

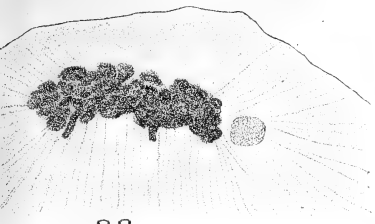

33.

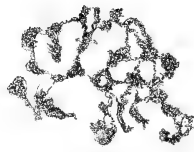

36

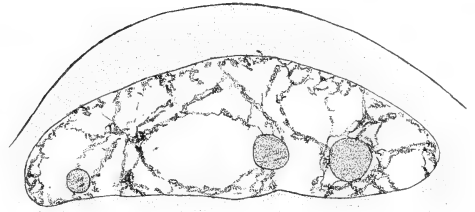

38.

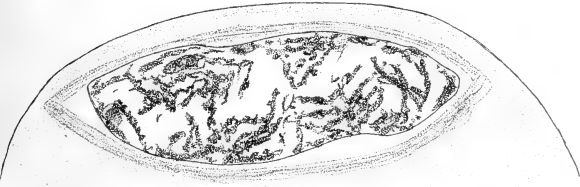

39.



34.

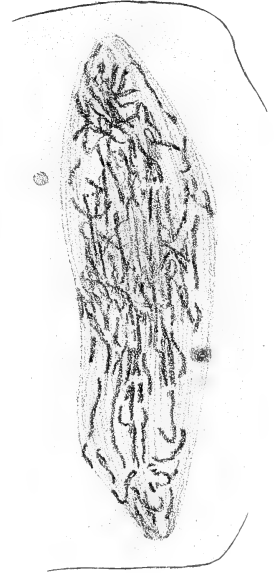

40.

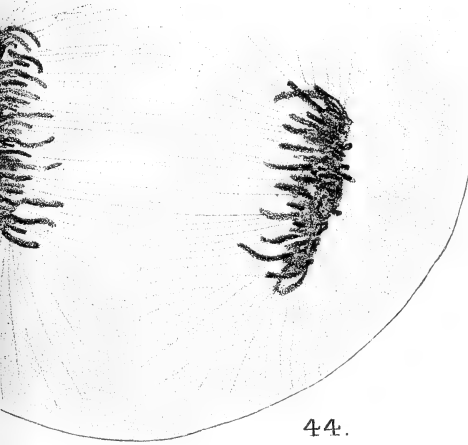

44.

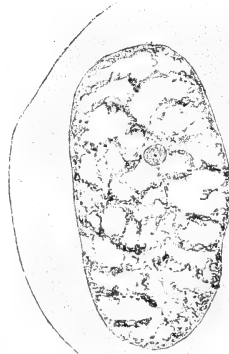

35.

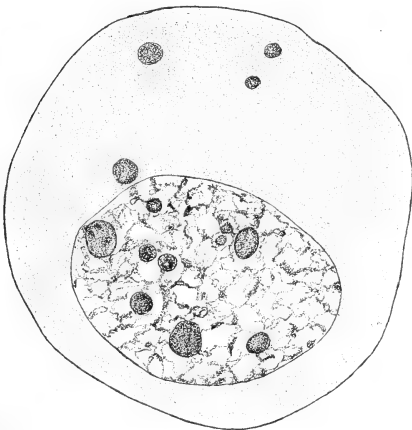

47.

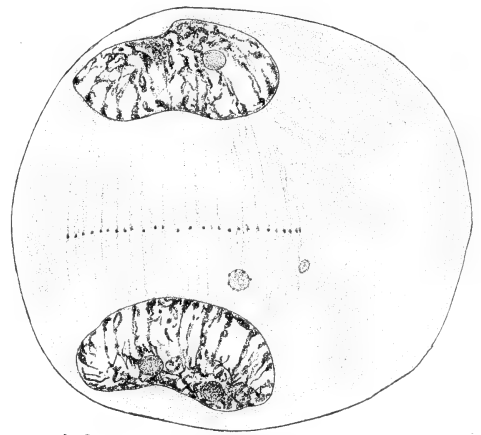

46.

5.





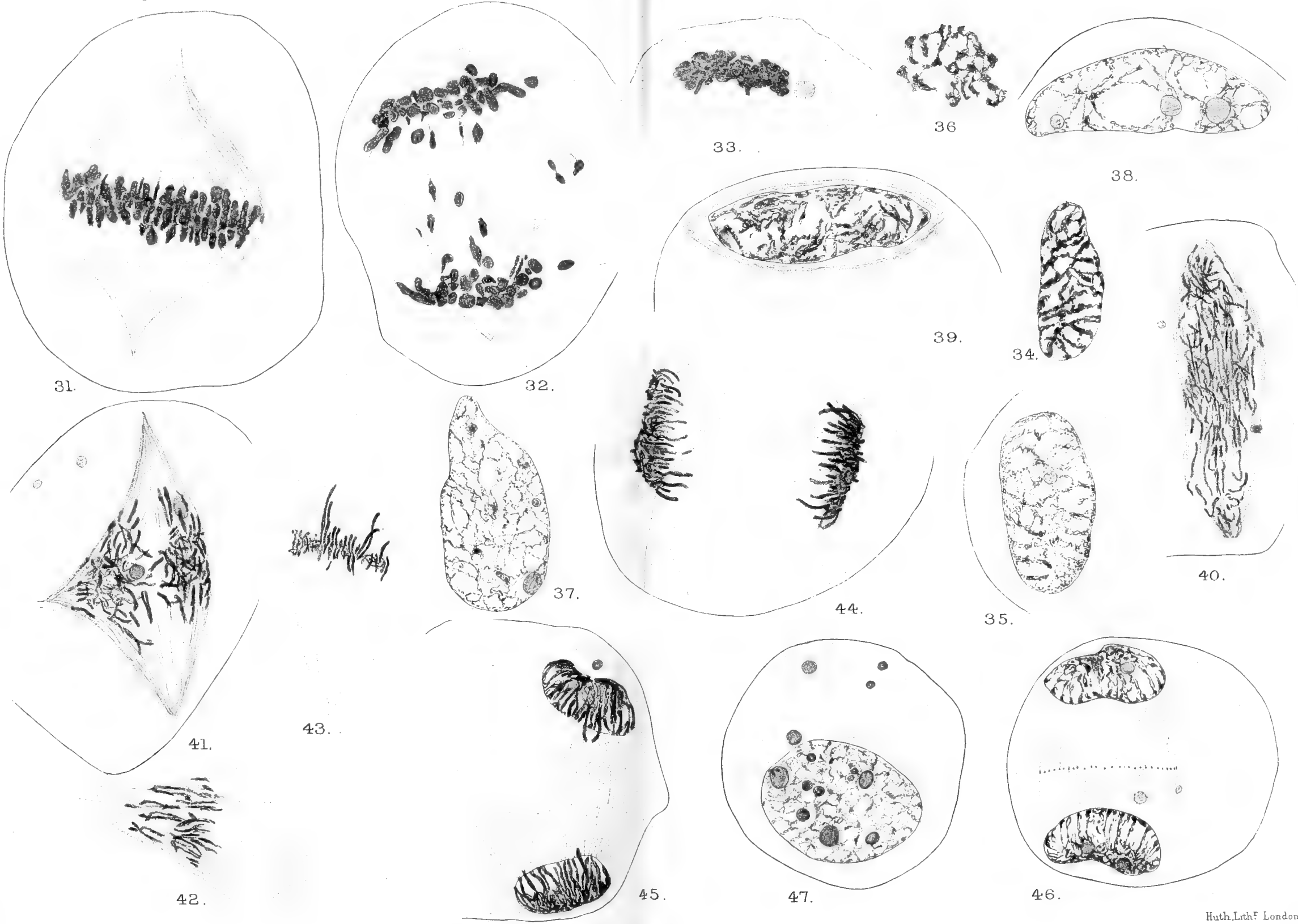

BEER — EQUISETUM.



# Studies in Nuclear Division of *Preissia commutata*.<sup>1</sup>

BY

MARGARET GRAHAM.

With Plates LIV and LV.

IN the gorges and smaller ravines in the vicinity of Ithaca there are many places where the water, dripping almost constantly over the rocks, affords favourable environment for the development of various species of Liverworts. While studying the morphology of the Bryophytes, my interest in the Liverworts that grew here first began. In an effort to learn more about one of them which is very abundant near Ithaca, this piece of work was undertaken.

Material for the study of the vegetative cells was collected from several localities. During July, 1910, plants were sent twice a week from Coy Glen, near Ithaca, and kept in good growing condition on the bank of a brook in Mount Vernon, New York. Other material was collected during July and August, 1911, in Buttermilk Gorge and Enfield Gorge, in the vicinity of Ithaca, and the material fixed in the laboratory. The plants sent to Mount Vernon and those collected in Buttermilk Gorge were equally satisfactory for the study of somatic division.

## I. MITOSIS IN THE VEGETATIVE CELLS.

(Plate LIV.)

Cells on or near the dorsal surface of the thallus of *Preissia commutata*<sup>2</sup> contain so many metaplasmic bodies, such as granules, plastids, starch, &c., that it is difficult to make a careful examination of the cytoplasm and nucleus for the presence of certain structures, especially centrospheres and centrosomes, which have been found in some Liverworts. A region almost free from the above-mentioned bodies was found on the ventral side of the thallus, just behind the turn made by the upward growth of the gametophore.

<sup>1</sup> Contribution from the Department of Botany, Cornell University, No. 154.

<sup>2</sup> Portions of thalli were killed in Flemming's fluids, the stronger, medium, and weaker solutions; in Merkel's fluid, and in chromacetic solution. The Flemming's fluid, weaker solution, gave the best results. Air was pumped out of all tissues after being placed in the killing fluids. Sections were cut  $5\ \mu$  in thickness.

The cytoplasm in the resting cell is finely granular, and in addition there are coarse granules scattered through it which stain more deeply. Several large vacuoles are also present in the cytoplasm. The resting nucleus is rounded and contains a small number of delicate linin strands. These strands stretch across the nuclear cavity, occasionally anastomosing. At low magnification they seem to radiate from the nucleolus. Some of the chromatin granules are distributed on the linin network, either at points where the linin strands meet or here and there on long portions of a strand free from anastomosing ones. Possibly all the linin strands are not differentiated by the stain used. The nucleolus in the resting cell is a large irregularly rounded body lying in the centre of the nucleus. In addition to this large nucleolus, a smaller one of the same general form frequently accompanies it (Fig. 1). Conspicuous nucleoli and a delicate network of linin threads were described in the vegetative cells by Van Hook ('00), who studied cell-division in the stalk of the archegoniophore of *Marchantia polymorpha*.

The first indication of prophase is the elongation of the nucleus, usually in the direction of the long axis of the cell. All of the nuclear contents become more conspicuous. The linin increases in quantity, not only in the number, but also in the increased width of the strands, thus making a more complex and dense reticulum than the open, delicate reticulum of the resting cell. Large irregular chromatin masses appear in this elongated nucleus, either on the linin or lying apparently free in the nuclear cavity. These masses are formed partly by the union of the chromatin granules, partly from another source; for, considering their size and number, it is probable that the union of the granules seen in the nucleus of the resting cell is not the only source through which their bulk has been increased. The size, staining reaction, and surface appearance of the nucleolus remain the same as in the resting nucleus. Therefore it cannot be said to contribute any appreciable amount of chromatic substance to the chromatin masses (Fig. 2). An account of the behaviour of the nucleolus in the vegetative cells of *Preissia commutata* will be given later.

The cytoplasm at this phase of the nucleus shows a differentiation into areas that are finely granular and coarsely granular. The coarseness of the latter areas is due to a grouping of the granules that were scattered throughout the cytoplasm of the resting cell. This condition is shown in Figs. 2, 6, and 7.

Certain of the strands of linin forming the complex network described above thicken and form a more or less continuous spireme, while other strands anastomosing with this remain very delicate. These delicate strands finally disappear, fragments of them remaining for a time as lateral projections from the forming spireme, which thus adds to the irregular outline of the surface of the spireme (Figs. 3, 4, 5). The masses of chromatin

gradually lose their irregular outline and become distributed on the linin in the form of chromomeres. Grégoire and Wygaerts ('03) believe that there is no distinction between linin and chromatin, that it is but one substance. They look upon the smaller dense bodies in the nucleus as chromatin and the network as a thinner part of the dense bodies, that lies between them. The nuclei in *Preissia commutata* are so very small that it is impossible to say whether the reaction of the dense bodies is unlike the reaction of the filaments when triple stain is used. The nuclei in the Liverworts are so small that they are not favourable objects for the study of this question. When the spireme is first formed it is narrow, and the chromomeres, which are very conspicuous at this stage, appear on it at unequal distances (Figs. 3, 4, 5). Later, when the spireme thickens, the chromomeres are not distinct (Figs. 9, 10, 13, 14). This account of the formation of the spireme in *Preissia commutata* agrees, in general, with the account of the formation of the spireme in higher plants, as described by Farmer and Shove ('05) in the vegetative cells of *Tradescantia virginica*, and by Wager ('04) in cells in the root-tip of *Phaseolus* and others. Coincident with its formation, there is a general contraction of the spireme from the periphery of the nucleus towards the nucleolus (Figs. 4, 5). The spireme finally contracts so closely about the nucleolus as to almost hide it (Fig. 6). Finer linin threads extending from the contracted spireme to the periphery of the nuclear membrane may also be seen in this figure. This contraction is a conspicuous stage in the mitosis of the vegetative cells of *Preissia commutata*, and has been observed in the germinating spores of *Pellia epiphylla* by Davis ('01), who calls it synapsis, and in *Carex* by Stout ('11). Later the spireme moves away from the nucleolus. At this time it is very uneven, being slender in some places and thick and jagged in others (Figs. 7, 8). These uneven regions disappear, and a spireme of uniform consistency comparable to that found in the higher plants by many students lies loosely coiled in the nuclear cavity. This spireme appears to be continuous. Chromomeres, so conspicuous in the early stages of the spireme, cannot now be distinguished readily. An unsegmented spireme in the vegetative division of the Liverworts has been mentioned several times, but up to the present time has not been fully described nor illustrated. This may be due to the fact that little work on the cytology of these plants has been done. Van Hook ('00), who studied the vegetative cells of *Marchantia polymorpha* in the stalk of the archegoniophore, says that he did not observe a spireme. Davis ('01) says that the linin and chromatin in the germinating spores of *Pellia epiphylla* form a broad spireme. Chamberlain ('03), who also studied the germinating spores of *Pellia epiphylla*, states that the nuclei elongate after the spireme is formed. Neither of the last two investigators figured the spireme.

That there is a contraction of the spireme may be objected to on the

ground that it is an artifact, due to faulty fixing. Cells in all other phases of division lie near those in which the spireme is contracting about the nucleolus, and no evidence of faulty fixing can be observed. Cells showing a recovery of the spireme from the contracting state lie in the growing region, and cannot be explained on the assumption that this contraction is an artifact.

At early prophase, when the nucleus is elongated, the cytoplasm becomes massed at the ends of the nucleus. These masses are dense and contain numerous granules. They are closely applied to the membrane of the nucleus at its ends (Figs. 2, 3). These granular masses may be found applied to the nuclear membrane at the ends of all nuclei in early prophase (Figs. 4, 5, 6 are not cut parallel with the long axis of the nucleus). Between the granular cap and the nuclear membrane there now appears a cone-shaped hyaline cap that rests on the ends of the nucleus. The boundary of the hyaline polar cap presents a sharp outline which may be pointed or blunt at its apex (Figs. 11, 12). This boundary appears slightly granular in cross-section. The granular areas are not so prominent after the appearance of the hyaline caps (Figs. 11, 12). Whether part of the granular area of cytoplasm is transformed into a hyaline substance that forms the hyaline caps, or the caps are composed of a hyaline fluid that is extruded from the nucleus, was not determined. In cells in the root of *Hyacinthus orientalis*, Rosen ('95) found a layer of hyaline kinoplasm surrounding the nucleus. Later the kinoplasm does not envelop the nucleus, but appears on opposite sides of the nucleus at the elongated ends as polar caps. Their appearance in Rosen's material and in *Preissia commutata* is similar at this later stage. Rosen ('95) believes that the substance of the cap is derived from the cytoplasm. Němec ('99) describes hyaline caps in the vegetative cells of *Vicia Faba* and several other Seed Plants. He also described an enveloping layer of hyaline kinoplasm around the nucleus that later takes the form of polar caps. He believes that this substance surrounding the nucleus, and later forming the caps, is identical in chemical peculiarities with the nuclear sap. Němec's ('99) experiments show that the form of the hyaline polar caps is due to a force pulling them in the direction of the long axis of the nucleus. By chloroforming or plasmolysing the living tissue, the hyaline polar caps return to the form of a hollow sphere surrounding the nucleus. In *Preissia commutata* the spindle fibres are developed in the hyaline polar caps. These fibres have a finely granular appearance. When the spireme is segmenting to form chromosomes, spindle fibres are being formed in the hyaline polar caps (Fig. 13). These fibres converge at the apex of the cap (Fig. 14). The form of the polar cap after the development of the fibres is unchanged. Sections showing the development of the fibres, in which the outline of the cap of granular fibres presents a blunt appearance, such as Rosen ('95) illustrates in his Fig. 3c, were not

found. Rosen ('95) believes that they grow from the nuclear membrane towards a point some distance from it.

Polar caps such as are described above have been observed by many investigators. Many have figured them in the Algae (*Spirogyra*). Hof ('98) describes them in a Fern, a Gymnosperm, and an Angiosperm, and Chamberlain ('03) in the germinating spores of *Pellia epiphylla*.

The nucleus in *Preissia commutata* elongates, as has been said, in the direction of the long axis of the cell, and the polar caps and spindle fibres appear against the nuclear membrane at these elongated ends. These fibres, therefore, appear as portions of the nuclear membrane, against which there is a greater mass of cytoplasm than there is on the sides of the elongated nucleus. The entire cells from which Figs. 13 and 14 are drawn are not represented; some portion at each end is omitted. The long axis of both these cells is parallel with the long axis of the nucleus. These fibres, therefore, appear on portions of the nucleus against which there is the greater amount of cytoplasm. The behaviour of these bipolar caps accords with Němec's ('99) theory, namely, that they appear in vegetative cells on the sides of the nuclei against which the mass of cytoplasm is the greater.

While the spireme is segmenting and while the nuclear membrane is still intact, a considerable number of spindle fibres have developed in the polar caps. Part of the spindle, therefore, is derived from the cytoplasm.

Diligent search was made for a centrosome at the apex of the converging fibres, but none was found; neither were there any cytoplasmic radiations. Many granules are in the cytoplasm at this stage, some of which may happen to lie at the apex of the cone of fibres, as shown in Fig. 13. The poles of the spindle at metaphase, as is shown in Figs. 16, 18, and 19, are sharply pointed, and, arising as they do from bipolar caps, it is at these poles that a centrosphere or centrosome might be expected, if it existed. No structures which could be justly interpreted as centrospheres or centrosomes were observed prior to or during the formation of the spindle. In one instance a multipolar diarch spindle (Fig. 18) was observed. The formation of a spindle of this type was not followed.

At the time the cone of fibres is fully developed at the ends of the nucleus, the spireme begins to break up into segments. Fig. 13 shows the spireme partly segmented. At this stage the segments are very little broader than the continuous spireme. Soon, however, they become broader and the ends of each chromosome curve (Figs. 14, 15). This curving makes it difficult to determine their exact form at metaphase. In longitudinal section of the spindle at metaphase the chromosomes appear as oval bodies. After segmentation of the spireme appears to have been completed, the segments are large and there are probably not more than eight (Fig. 14). In Fig. 15 the segments have shortened somewhat and there are probably not more than eight. In longitudinal section of the spindle at metaphase,

and before any division of the chromosomes has taken place (Figs. 16, 17), not more than eight chromosomes can be found. Fig. 20 probably represents the stage just after the division of the chromosomes. A cross-section at metaphase corresponding to the grouping of the chromosomes seen in Fig. 20 represents sixteen chromosomes in polar view (Fig. 21). Fig. 22 is a polar view of metaphase before division of the chromosomes in which eight are represented. This section is cut in a slightly oblique direction. In the first division of the spore mother-cell in a longitudinal section of the spindle at anaphase, there are seen eight chromosomes. At this division the chromosomes are very much longer than in the somatic division. This number was counted so often that it is probably the correct one for the haploid number. The chromosomes in the vegetative cells are very small bodies. Fig. 19 is a longitudinal section through the mitotic figure. Here the chromosomes appear larger than those in any other section. By far the greater number of sections at metaphase appear as in Figs. 18 and 20.

During anaphase the chromosomes elongate. When they reach the poles (Fig. 23) they are elliptical, but are still distinct from one another. Later, while still grouped at the poles, they become so crowded that it is impossible to distinguish individual chromosomes (Fig. 24). The elements of this crowded mass elongate considerably (Fig. 25) and appear as stout threads with clear spaces between them. Some of these thick threads are curved (Fig. 26). It is probable that all the curved threads represented in Figs. 25 and 26 are chromosomes since their number agrees with the number in late telophase illustrated in Figs. 23 and 24. Clear spaces between the stout threads are enlarged probably by the increase of nuclear sap (Figs. 25, 26).

A nuclear membrane cannot be distinguished until the chromosomes have become more tenuous, longer, and as individual bodies have become lost in their union to form the reticulum of the nucleus. With the appearance of the nuclear membrane a nucleolus appears which is at first very small (Fig. 27). At this time also the chromatin is distributed on the linin reticulum in the form of granules, as has been described above in the resting cell.

The nucleolus in the resting cell is, as has been stated, very large. In the resting condition and during the early stages of mitosis it may be spherical, irregularly rounded, or angular (Figs. 2, 3, 4, 5, 6). When using Flemming's triple stain it stains deeply with the aniline-saffranin during all the early phases of mitosis. In all preparations which I have examined, up to the time of the segmentation of the spireme, the nucleolus was present, and in no case has it presented the appearance of being vacuolate. I have found no evidence that the nucleolus contributes any portion of its material for the formation of the spireme and chromosomes, although during the resting stage of the nucleus and in the early prophases of division strands



of the reticulum are at least in contact with the nucleolus. The actual connexion of the nucleolus with the reticulum and with the chromosomes has often been observed by other students, some of whom believe that it furnishes a portion of the substance<sup>1</sup> for the chromosomes. Wager ('04) says that in the vegetative cells of *Phaseolus* the nucleolus contributes a large part of its substance to the formation of the spireme and the chromosomes. During this process the nucleolus undergoes changes of form, becoming amoeboid, then vacuolate, and finally spongy. After the chromosomes were fully formed, the remainder of the nucleolus divided into unequal portions which moved towards the poles of the spindle. In *Preissia commutata* I have not observed the nucleolus after the dissolution of the nuclear membrane. At metaphase, of which there are many sections, all the chromatin is readily identified as chromosomes. A dividing nucleolus, such as Wager ('04) found in *Phaseolus*, and a dividing nucleolus and fragmented portions of the nucleolus lying in the cytoplasm surrounding the spindle at metaphase, such as Thos. Martins Mano ('04) found in *Phaseolus* and *Solanum*, and as has been described by others, were not observed by me in the vegetative cells of *Preissia commutata*. When the spireme has segmented and the chromosomes begin to shorten and thicken (Figs. 13, 14) the nucleolus is of the same size as it is in the earliest prophase. Nor has its surface appearance and staining capacity changed so far as I could observe. These facts lead me to believe that the nucleolus does not give up its substance to the formation of the chromosomes, or, at any rate, not to any appreciable extent. But the sudden disappearance of the nucleolus coincident with the formation of the central spindle suggests that its substance may be transformed into spindle fibres. That the substance of the nucleolus is concerned with the formation of the spindle fibres is a view held by a number of students. Némec ('99) studied mitosis in the Seed Plants and came to the conclusion that the nucleolus takes part in the formation of the spindle. He describes the reverse process, that is, the mantle fibres become granular and by consolidating form the nucleoli of the daughter nuclei. Strasburger ('05), who worked at both Monocotyledons and Dicotyledons, was convinced that the nucleolus contributes some substance for the formation of spindle fibres. Miyake ('05) is in entire accord with Strasburger's view. A number of Monocotyledons were investigated by Miyake, and he describes and figures fully formed chromosomes while the nucleolus still persists. Many others hold the same view. Chamberlain ('03), who studied the germinating spores of *Pellia epiphylla*, suggests that the substance of the nucleolus is used partly in the formation of the

<sup>1</sup> In the 11th edition of *Lehrbuch der Botanik* (by Strasburger, Jost, Schenk, and Karsten), 1911, in the section 'Morphology', p. 73, Strasburger says that the nucleolus appears to represent reserve stuff which serves for the nourishment of the chromosomes and also furnishes some substance for the spindle threads.

chromosomes and partly in the formation of the central spindle fibres. It is generally accepted that in many Thallophytes the nucleolus often contributes a portion of its substance to the formation of the chromosomes, and it would not be surprising if in some of the Liverworts the nucleolus also contained some of the chromatin.

Indications of a cell plate appear in the earliest telophase observed (Fig. 23). In later telophase the cell plate, in section, appears as a line of granules. These increase in number until a distinct plate is formed (Figs. 24, 25, 26). At first the cell plate lies only between the two daughter nuclei, finally extending its circumference to the periphery of the cell. The formation of the cell plate in *Preissia commutata* agrees with the formation of the cell plate in the vegetative cells of *Pellia epiphylla* described by Farmer and Reeves ('94), and in the vegetative cells of the archegoniophore of *Marchantia polymorpha* described by Van Hook ('00).

#### DISCUSSION.

Although a number of papers on mitosis in the gametophyte of the Liverworts have appeared, many of them were concerned primarily with the centrosphere or centrosome problem. Farmer and Reeves ('94) describe centrospheres in the germinating spores of *Pellia epiphylla*; Farmer ('95) also describes them in the germinating spores of *Fegatella conica* (*Conocephalum conicum*). Van Hook ('00) reports them associated with centrosomes in cells in the archegoniophore of *Marchantia polymorpha*. Chamberlain ('03) describes the presence of asters in the prophase division in the germinating spores of *Pellia epiphylla*, their disappearance at metaphase, reappearance at telophase, and second disappearance with (see p. 33) the formation of the nuclear membrane. Usually they have nearly disappeared at the time of the third division. Davis ('01) describes prominent asters in the first three mitoses of the germinating spores of *Pellia epiphylla*, but they are less plainly shown in the second and third division. He does not find them in the stalk of the sporophyte. There is, therefore, agreement between these investigators as to the presence of centrospheres or asters in cell-division during certain stages of development of the vegetative cells of some Liverworts. The fact that asters are prominent in the first division of the germinating spore of *Pellia epiphylla*, that they become less prominent in the second and third division, finally disappearing, makes it reasonable to expect that they may not be formed during cell-division in the growing thallus of some Liverworts. The same may be said with reference to the presence of centrosomes. Both are surely absent from all phases of mitoses in the cells of the thallus of *Preissia commutata*, as far as my observations are concerned. So many cell generations lie between the mitoses in the germinating spore and the fully formed thallus that, if they are present in

the first mitosis (a division that has not been studied) they disappear entirely by the time the thallus is formed. Farmer and Reeves ('94), in their study of the germinating spores of *Pellia epiphylla*, believe that the elongation of the nucleus in the early prophase is due to the influence of the centrospheres. If there is some controlling force at the poles of the nucleus which causes it to elongate, it is certainly not to be ascribed in all cases to demonstrable centrospheres, for they are not present in the somatic cells of *Preissia commutata*, where the elongation of the nucleus is marked. Van Hook ('00) does not attempt to explain the elongation of the nucleus in cells in the stalk of the archegoniophore of *Marchantia polymorpha*; nor does Chamberlain ('03), who found that the nucleus in *Pellia epiphylla* elongated after the spireme had become segmented into chromosomes. Němec ('99) believes that some force acts on the nuclei of cells in Seed Plants which tends to pull the nuclear wall in the direction of the force. By chloroforming or plasmolysing the living tissue the nuclei become spherical.

The formation of the spindle fibres in *Preissia commutata* follows the method of their formation in many other forms, and shows that the process in this plant is similar to that in the seed plants. Upon the elongation of the nucleus the granular masses of cytoplasm at the ends of the nuclei are conspicuous. When the triple stain is used, the granules take the aniline-saffranin stain. The appearance of the kinoplasmic caps are described in the vegetative cells of a Liverwort (*Pellia epiphylla*) by Davis ('01), and his illustrations show that this cap is composed of granular cytoplasm. Farmer and Reeves ('94) state that the achromatic spindle develops from the cytoplasmic radiations of the centrospheres in the germinating spores of *Pellia epiphylla*. In *Marchantia polymorpha*, according to Van Hook ('00), the radiations from the centrospheres meet to form a spindle, while Chamberlain ('03) believes that the spindle fibres in the germinating spores of *Pellia epiphylla* are formed from hyaline caps that become granular and then fibrous.

The earliest prophase in *Preissia commutata*, in which the nucleus elongates and the chromatin substance increases materially, is similar to the same stage in the higher plants. This stage in higher plants has been described many times by many students. In a Liverwort it has been described by Van Hook ('00), and the results of my investigation agree with his, except that the centrospheres he finds at this stage are absent from the plant now under consideration.

The results of this work show that from the earliest prophase to the reconstruction of the daughter nuclei, mitosis in the vegetative cells of the Liverworts agrees with that in the higher plants, as described by many investigators.

## SUMMARY.

1. In earliest prophase the nucleus elongates. The linin becomes conspicuous and large chromatin masses appear.

2. Strands of linin thicken and form a spireme comparable to the spireme in many seed plants. The masses of chromatin lose their irregular outline and become distributed on the linin in the form of chromomeres.

3. As the spireme is forming, it contracts about the nucleolus. Fine linin threads extend from the contracted spireme to the nuclear membrane.

4. As the spireme recovers from the contraction and moves away from the nucleolus, it is very uneven. Later its width is even.

5. The spireme now segments to form chromosomes, while the nuclear membrane is intact and the nucleolus still persists. The haploid number of chromosomes is probably eight.

6. During late telophase the chromosomes elongate. They then become crowded so closely together that it is difficult to distinguish the individual ones, after which they elongate into slender threads which finally lose their individuality as they unite to form the reticulum of the daughter nuclei.

7. The nucleolus is very large. It persists for some time after the segmentation of the spireme. Its disappearance is very sudden and coincident with the formation of the central spindle fibres. Neither vacuolization nor fragmentation of the nucleolus was observed at any time. This suggests that it may contribute some of its substance to the formation of the central spindle fibres.

8. Granular masses of cytoplasm are applied to the elongated ends of the nucleus at early prophase. Between the granular cap and the nuclear membrane a cone-shaped cap rests on the ends of the nucleus. Fibres appear in these hyaline caps when the spireme is segmenting and the nuclear membrane is intact. The development of fibres in the hyaline cap in *Preissia commutata* is like their development in other groups of plants.

9. Neither centrospheres nor centrosomes were found.

## II. SPOROGENESIS.

(Plate LV.)

The material for the study of the development of the spores of *Preissia commutata* was collected every day, beginning with April 18, until May 17, 1912. In December the young sporogonium is fully formed. The stalk is short and lifts the receptacle but very little above the dorsal surface of the thallus. At this time the cells in the sporogonium form a solid tissue, and they remain in this condition until the following spring. Division in the sporogenous tissue begins early in April, but there is no differentiation of the tissue until May 1. On May 6, 1912, the sporogenous tissue was

differentiated into spore mother-cells and elaters. All the sporogonia are not in the same stage of development, though they are all near the same stage.

When the differentiation in the sporogonia takes place, the spore mother-cells are embedded in a gelatinous substance. There are plastids in all the cells in the sporogonia and those in the elaters develop chlorophyll. There is also chlorophyll in the wall of the sporogonium. When the wall of a sporogonium is cut and its contents are forced out on a slide the chlorophyll bodies in the elaters are conspicuous. The gelatinous substance in which the spore mother-cells and elaters are embedded is colourless, viscid, and holds the contents of the sporogonium together on the slide.

In preparation for fixing, the sporogonia were separated from the gametophore and the pseudoperianth was cut away before they were placed in the killing fluid. Hermann's fluid, Carnoy's fluid, and Juel's fluid were used. Material killed in Hermann's fluid was best. Through experience during the two preceding springs, it was found that any killing solution containing chromic acid tended to harden the mucilaginous substance in which the spore mother-cells are embedded, and the cells were plasmolysed. Sections were cut 4, 5, 6, 7, and 9  $\mu$ . They were stained with Flemming's triple stain, Heidenhain's iron-alum-haematoxylin, and the Flemming's triple stain, substituting pyoktanin for gentian violet.

The spore mother-cell in the resting condition is broadly elliptical. The cytoplasm presents a coarse open or foamy appearance. It has the same appearance in the living condition. Lying in the cytoplasm between the nucleus and the cell wall are groups of plastids. In the centre of the cell there is a spherical nucleus. The reticulum in the resting nucleus is made up of a number of fine anastomosing threads. The chromatin bodies are small, very numerous, and are situated at the angles of the reticulum (Fig. 1). One or more vacuoles appear in the reticulum at this stage. There may be as many as four large nucleoli in the nucleus of the spore mother-cell.

The spherical nucleus of the resting cell enlarges. The fine reticulum changes into a coarse network of threads (Fig. 2). Some of the threads making up the network can be traced for some distance, and it is evident that at this early prophase a long slender thread is being formed. Near the nucleoli in the section represented by Fig. 2 are fine linin threads. The reticulum is of unequal thickness at this phase; the strands near the nucleoli remain in the condition of the linin of the resting nucleus the longest time. The chromatin at this early prophase is more conspicuous than in the resting nucleus, the individual bodies having increased in size. Here, as in the nucleus of the resting cell, the chromatin bodies lie at the angles of the reticulum.

The growth of the nucleus continues. The condition of the reticulum

in which it is possible to trace a continuous thread for some distance (Fig. 2) is replaced by a slender thread, the whole reticulum having been converted into a slender thread (Fig. 3) which is called leptonema by some authors (Winiwarter ('01), Grégoire ('07), and others). From the frequency of its occurrence in sections at this stage of prophase, it is evident that the leptonema spireme is formed a considerable period before synapsis. In this figure many threads may be seen lying side by side. This suggests a pairing of the threads. The threads of many of these pairs are more slender than others which lie singly. It would be interesting to know if these stouter single threads are formed by the side-by-side union of a pair of the slender ones, or by such a close approximation that the line of division between them cannot be seen. The pairing of these threads suggests the condition of the spireme in *Osmunda regalis*, *Allium fistulosum*, &c., described and figured by Grégoire ('07) as 'noyaux zygotènes'. Grégoire ('07) does not find a continuous spireme—the chromosomes or gemini arise as long slender threads; while in *Preissia commutata* my preparations in early prophase have the appearance of the spireme being a continuous thread. Because of the very small size of the nuclei and the great length of the thread it is difficult to speak with certainty. There was no evidence, however, that prochromosomes such as are described by Strasburger ('05) in *Galtonia candicans*, by Miyake ('05) in the same plant, and by Overton ('09) in *Thalictrum purpurascens*, and by others, were present in the spore mother-cell of *Preissia commutata*. The appearance is that of a spireme that persists for a considerable time.

The spireme next enters into synapsis (Fig. 4). In the synaptic knot there is evidence of the persistency of the spireme, as the appearance of the knot in Fig. 4 plainly shows, but it is so tightly drawn together that it cannot be followed throughout its length. In the synaptic knot there are many chromatin bodies of equal size and shape. These bodies are extremely prominent and are always present at this stage of the prophase, but they are arranged in rows or in the form of a spireme. These prominent chromatin bodies of equal size and shape in the synaptic knot are very suggestive of the condition found by Strasburger ('05), Miyake ('05), and Overton ('09) in seed plants. At this phase, according to these investigators, the prochromosomes, or gamosomes, pair. In *Preissia commutata* there is no evidence in the synaptic knot that these chromatin bodies come in contact in pairs. It may be, however, that during synapsis the pairs of threads described above may be brought into closer approximation and actually fuse, thus producing this stout spireme with the chromatin masses situated at quite regular intervals. The nucleolus may be included in the synaptic knot or lie by its side.

As the spireme emerges from synapsis, there is a general loosening of the entire structure (Fig. 5). At this time it is quite slender and the chro-

matin bodies on it are very distinct. The loosening of the synaptic knot and the emergence of the spireme continue until the spireme is uniformly distributed throughout the nuclear cavity (Fig. 6). The spireme is at this stage still quite slender and its appearance is very different from the leptonema spireme. The chromomeres are of the same size and form and are placed at almost equal distances from one another. They become more prominent as the spireme thickens (Fig. 7). A post-synaptic spireme in Liverworts has been described by Davis ('01) in the spore mother-cell of *Pellia epiphylla*, where it appears as a delicate, closely wound spireme. The spireme shown in his illustration is evidently in the same stage as that in Fig. 6 of the present work. The nucleolus in *Preissia commutata*, however, is not vacuolated at this stage, while in *Pellia epiphylla* Davis ('01) found the nucleolus vacuolated.

There is a gradual shortening and thickening of the spireme (Figs. 8, 9) which results in the formation of what is sometimes called the 'pachynema' spireme. At this stage the width of the spireme has increased very much (compare Figs. 6 and 9).

From this time there is another contraction of the spireme. It contracts away from two opposite sides of the nucleus, so that it occupies a rather broad plane, extending entirely across the nucleus. The loops of the spireme do not have any definite arrangement (Figs. 8, 9), but the entire spireme is drawn rather closely together across the diameter of the nucleus. Some of the loops touch the nuclear membrane (Figs. 8, 9). This stage is the second contraction described by Farmer and Moore ('05). However, in *Preissia commutata* it occupies, as has been said, a broad plane extending entirely across the nuclear cavity and does not extend in all directions in the nuclear cavity with large spaces between the contracted portions, as is the case during the second contraction in *Lilium candidum* as described by Farmer and Moore ('05) and in *Lilium speciosum* by Grégoire ('07). Many sections with spiremes in the same general position as those shown in Figs. 8 and 9 were obtained, which indicates that this stage lasts for some time in *Preissia*.

When the spireme is entering upon the second contraction, it begins to split longitudinally throughout its entire length. Some portions of the spireme are so situated that the split is plainly seen (Figs. 8, 9). The chromomeres that are so prominent in the earlier prophases (Figs. 4, 5, 6, 7) are now not recognizable (Figs. 8, 9). Fine short threads project from the margin of the spireme, giving it a somewhat jagged appearance.

The spireme is always contracted about or near the nucleolus. At this stage the centre of the nucleolus stains less deeply than the periphery. This may be due to the method of staining or to the chemical changes that have taken place in the nucleus. It is certain, however, that at this stage the nucleolus is not vacuolate, and its size and shape remain the same as in

the earlier pro phases. After the segmentation of the spireme, the nucleolus disappears, but the manner of its disappearance was not determined. In sections showing the chromosomes in process of formation no fragments of the nucleolus were found. Fragmented nucleoli in some of the Liverworts have been observed. Farmer ('95) describes a fragmented nucleolus while the chromosomes were being formed in the spore mother-cell of *Fossombronina Dumortieri*. He also describes a fragmented nucleolus at the time when the spireme splits longitudinally in *Fegatella conica* (*Conocephalum conicum*). Davis ('99) also found that the nucleolus in *Anthoceros* fragmented after synapsis. In *Pellia epiphylla* vacuolization and fragmentation of the nucleolus take place, according to Farmer ('95), during the formation of the chromosomes, and he thinks that it furnishes some material for the formation of the spireme and chromosomes. The fact that the central portion of the nucleolus stains less deeply in *Preissia commutata* prior to and during the segmentation of the chromosomes possibly indicates that some of its substance goes to the formation of the latter. But, as the greater part of it disappears after the formation of the chromosomes, it would seem that it contributes also to the formation of the spindle, if we accept the view of Strasburger ('05), Miyake ('05), Chamberlain ('03), and others on this point. It is to be regretted, however, that no direct evidence was obtained on this point in *Preissia commutata*, and that the way in which the nucleolus disappears was not observed. It apparently disappears quickly.

After the second contraction, the spireme segments (Fig. 10). The line of the longitudinal splitting observed in sections illustrated by Figs. 8 and 9 persists in the segments of the spireme (Fig. 10). The segments curve somewhat, sometimes throughout their entire length, sometimes at one end, in very much the same manner as was noted for the chromosomes in the somatic cells. The nucleolus shows no further change in its appearance than was noted at the second contraction.

The segments of the spireme next shorten and thicken (Fig. 11). At this stage the chromosomes stain very deeply, and the split shown so clearly in Fig. 10 is now more difficult to see. It may sometimes be seen throughout the length of the segment, but the free ends show it plainly. As the chromosomes shorten and thicken they bend and twist in various directions (Fig. 11). The nucleolus has disappeared completely and the nuclear membrane is still intact. At a late stage of this pro phase the split may be seen only at the free ends of the chromosomes.

The achromatic spindle appears so quickly, its mode of formation was not determined. The results of efforts made to observe its formation will be given later.

At metaphase the chromosomes are arranged on the equator of the spindle (Fig. 13), but their method of splitting was not clearly made out.



The spindle lies in a space almost free from cytoplasm, plastids, &c. The poles of the spindle are broad and blunt, though there may be a multipolar diarch (Fig. 14).

As the chromosomes draw towards the poles (Figs. 14, 16) some are often in advance of the others. At this stage the chromosomes are plainly two-pointed (Fig. 17), a condition described and figured by Overton ('09) and others. As the chromosomes reach the poles (Fig. 18) they are grouped together, but do not, at least at the early telophase, lose their individual outline. In cross-section the cell plate appears as a line across the equator of the spindle at the time the chromosomes have reached the poles (Fig. 18).

The reconstruction of the daughter nuclei of the heterotypic division takes place very quickly. The wall separating the two daughter nuclei of the first division is scarcely formed, when they begin to show signs of early prophase preparatory to the formation of the four spores. No sections showing the steps between the grouped chromosomes at telophase and a daughter nucleus with a reticular content, a nucleolus, and a nuclear membrane (Fig. 19) were found. The reconstruction of the daughter nuclei is evidently passed over very quickly. After a short time the nuclei enlarge (Figs. 20, 21) and the chromatin strands thicken. The nucleolus also enlarges and chromatin bodies appear (Figs. 20, 21).

In the second mitosis of the spore mother-cell the daughter nuclei divide simultaneously. In Fig. 23 three newly formed nuclei are represented; the other one and the first wall laid down in the spore mother-cell are in another section.

Spindle fibres, so difficult to obtain in the first division of the spore mother-cell, are most conspicuous in the early prophase of the daughter nuclei. Whether they are preceded by a cap of hyaline cytoplasm, as is the case in the somatic cells of *Preissia*, was not determined. At the earliest prophases of the spore mother nuclei in the heterotypic division hyaline caps are closely applied to the nuclear membrane (Figs. 22, 24, 25). In an effort to understand the origin and function of these caps, sections were cut  $5\mu$  thick. This is too thin a section to study the nuclear phenomena, but Figs. 22 and 24 are probably both in the reticulum stage. The form of the hyaline cap varies, as a comparison of Figs. 22 and 25 shows. Their position against the nuclear membrane also varies; they may lie on opposite sides of the nucleus, or there may be a greater distance between them on one side of the nucleus than on the other side (Fig. 22). Coarse strands of cytoplasm may extend over the hyaline caps from a group of plastids to the nuclear membrane. Whether the outer spindle fibres are developed from these hyaline caps, as is the case in the somatic cells, or whether the spindle fibres are developed from a zone of fibres circling about the nucleus, as is the case in Seed Plants, the present investigation does not prove.

It has been stated that groups of plastids lie in the cytoplasm around the nucleus (Figs. 1, 7). In many sections four groups were well defined, and it was at first thought that these groups might bear some relation to the number of spores formed; that is, that each group constituted the plastids found in a mature spore. More than four groups were, however, found in sections obtained later. From metaphase to telophase the plastids are almost always divided into two large groups that lie near the poles of the spindle, few or none lying in the cytoplasm near the equator of the spindle (Figs. 13, 14, 15, 18). The coarse strands of cytoplasm extending from the groups of plastids to the nuclear membrane are very prominent (Fig. 26), but whether there is any relation between these strands and the spindle fibres was not determined.

During the earliest prophases a most careful search was made for centrospheres and centrosomes. The membrane of many nuclei in all stages of prophase was closely searched for a body exerting a pull on the membrane. None was found in *Preissia commutata*. Centrospheres with a centrosome have been described by Farmer ('95) in the earliest prophases of the spore mother-cells of *Fossombronia Dumortieri*. He also observed that the nuclear membrane of this plant was pulled out through the influence of the centrospheres, and that the quadripolar spindle is at first a 'nuclear distortion'. Farmer ('95) found that the spindle in *Pellia epiphylla* was also formed through a pull exerted on the nuclear membrane as described above for *Fossombronia Dumortieri*. Not having found spindle fibres while the nuclear membrane was still intact, nor that the nuclear membrane was pulled out, I am unable to say whether *Preissia commutata* agrees with *Fossombronia Dumortieri* and *Pellia epiphylla* or not. In view of the presence of the hyaline kinoplasmic caps described above in *Preissia commutata*, and the work of Némec ('99), Rosen ('95), and others, in which it is shown that spindle fibres are developed in the hyaline kinoplasmic caps, it is probable that at least the outer spindle fibres in the plant now being considered are formed from these caps. Heretofore these hyaline kinoplasmic caps have been reported only in somatic or vegetative cells, and their occurrence in the heterotypic division of *Preissia* is therefore interesting.

#### SUMMARY.

1. In early prophase the nucleus of the mother-cell enlarges. The fine reticulum of the resting cell is changed into a coarse network of threads, some of which can be traced for some distance. The individual chromatin bodies increase in size and number.

2. The nucleus continues to grow. The reticulum is replaced by a leptonema spireme. Many strands lie side by side.

3. The spireme enters synapsis. In the knot there is evidence of the persistency of the spireme. The chromatin bodies are prominent in the knot.

4. As the spireme emerges from synapsis it is quite slender, and the chromomeres are distinct on it.

5. The spireme shortens and thickens. It contracts away from opposite sides of the nucleus, occupying a broad plane, extending entirely across the nucleus. Its loops do not have any definite arrangement. At the time of the second contraction the spireme splits. The nucleolus at this time is not vacuolate nor does it fragment. It, however, does not stain as deeply as in earlier stages. It disappears suddenly when the chromosomes are being formed, and while the nuclear membrane still persists.

6. After the second contraction the spireme segments. At this time the splitting is plainly seen. The segments shorten and thicken.

7. Prominent hyaline caps in polar position are applied against the nuclear membrane in the heterotypic division. Whether spindle fibres are developed in these caps or not was not determined.

8. The poles of the spindle are broad and blunt. The method of the splitting of the chromosomes at metaphase was not observed. At anaphase they are plainly two-parted. When the chromosomes reach the poles, the cell plate appears as a line in cross-section.

9. The reconstruction of the daughter nuclei takes place very quickly. The nuclear contents have a slight reticular appearance and there is a small nucleolus. The nuclei soon elongate preparatory to the second division. Spindle fibres are conspicuous at the elongated ends.

10. Groups of plastids lie in the cytoplasm. There may be four or more of these groups. Coarse strands of cytoplasm extend from the groups to the nuclear membrane.

11. No centrospheres or centrosomes were found.

I am indebted to Prof. G. F. Atkinson for his kind advice and criticism during the progress of the work and the preparation of this paper; and to Dr. Fred McAllister for continued and helpful suggestions.

---

#### LITERATURE CITED.

- CHAMBERLAIN, CHARLES J. : Mitosis in *Pellissia*. Bot. Gaz., xxxvi, 1903, pp. 28-51, Pls. XII-XIV.  
DAVIS, BRADLEY MOORE: The Spore Mother-cell of *Anthoceros*. Bot. Gaz., xxviii, 1899, pp. 89-109, Pls. IX, X.  
——— : Nuclear Studies on *Pellissia*. Ann. Bot., xv, 1901, pp. 147-80, Pls. X, XI.  
FARMER, J. BRETLAND : On Spore Formation and Nuclear Division in the Hepaticae. Ann. Bot., ix, 1895, pp. 469-523, Pls. XVI-XVIII.  
——— and MOORE : On the Meiotic Phase (Reduction Divisions) in Animals and Plants. Quar. Jour. Micr. Sci., xlviii, 1905, pp. 489-557, Pls. XXXIV-XLI.

- FARMER and REEVES: On the Occurrence of Centrospheres in *Pellia epiphylla*. Ann. Bot., viii, 1894, pp. 219-24, Pl. XIV.
- and SHOVE: On the Structure and Development of the Somatic and Heterotypic Chromosomes of *Tradescantia virginica*. Quart. Jour. Micr. Sci., xlviii, 1905, pp. 559-69, Pls. XLII, XLIII.
- GRÉGOIRE, VICTOR: La formation des gemini hétérotypiques dans les végétaux. La Cellule, xxv, 1907, pp. 369-420.
- and WYGAERTS: La reconstitution du noyau et la formation des chromosomes dans les cinèses somatiques. Beih. Bot. Centralbl., xiv, 1903, pp. 11-19.
- HOF, A. C.: Histologische Studien und Vegetationspunktion. Bot. Centralbl., lxxvi, 1898, pp. 65-69, 113-18, 166-71, 221-5, Pls. III, IV.
- MANO, THOMAS MARTINS: Nucléole et chromosomes dans le méristème radicaire de *Solanum tuberosum* et *Phaseolus vulgaris*, La Cellule, xxii, 1904, pp. 57-77, 4 Pls.
- MIYAKE, KÜCHI: Ueber Reductionsteilung in den Pollenmutterzellen einiger Monokotylen. Pringsheim's Jahrb. wiss. Bot., xlii, 1905, pp. 83-120, Pls. III-V.
- NĚMEC, BOHUMIL: Zur Physiologie der Kern- und Zelltheilung. Bot. Centralbl., lxxvii-lxxviii, 1899, pp. 241-51, Text-figs. 1-7.
- OVERTON, JAMES BERTRAM: On the Organization of the Nuclei in the Pollen Mother-cells of Certain Plants, with especial reference to the Permanence of the Chromosomes. Ann. Bot., xxiii, 1909, pp. 19-61, Pls. I-III.
- ROSEN, F. VON: Beiträge zur Kenntnis der Pflanzenzellen. Beitr. Biol. Pflanz., vii, 1895, pp. 225-308, Text-fig. 3, Pls. II, III, IV.
- STRASBURGER, EDUARD: Typische und allotypische Kernteilung. Pringsheim's Jahrb. wiss. Bot., xlii, 1905, pp. 1-70, Pl. I.
- STOUT, A. B.: The Organization of the Chromosomes in *Carex*. Science, N.S., xxxiii, 1911, p. 264.
- VAN HOOK, J. M.: Notes on the Division of the Cell and Nucleus in Liverworts. Bot. Gaz., xxx, 1900, pp. 394-9, Pl. XXIII.
- WAGER, HAROLD: The Nucleolus and Nuclear Division in the Root-apex of *Phaseolus*. Ann. Bot., xviii, 1904, pp. 29-55, Pl. V.
- WINIWARTER, H. VON: Recherches sur l'ovogenèse et l'organogenèse de l'ovaire des Mammifères (Lapin et Homme). Arch. de Biol., xvii, 1900, pp. 33-199.

## EXPLANATION OF PLATES LIV AND LV.

All figures were drawn with the aid of a Zeiss camera lucida.

### PLATE LIV. Mitosis in Vegetative Cells.

(All the figures, except Figs. 1 and 22, were drawn to the same scale, using a Zeiss microscope, compensating ocular 12, and a 2 mm. homogeneous immersion objective, numerical aperture 1.30, magnification 2,040. Fig. 1 was drawn using the same objective but an 18 Zeiss compensating ocular, magnification 3,250. The same objective was also used for Fig. 22, but an 8 Zeiss compensating ocular, magnification 1,430. The images were all drawn at a plane even with the base of the microscope. The figures are reproduced from the drawings without any reduction.)

Fig. 1. A resting cell. The reticulum in the nucleus is delicate and open. Chromatin knots lie on it. Two large nucleoli are in the nucleus. Several vacuoles lie in the cytoplasm. Cell highly magnified.

Fig. 2. Elongated nucleus. Linin strands have thickened and their number increased. There is also an increase in the number and size of the chromatin bodies.

Figs. 3, 4, 5, 6. The chromatin bodies are becoming distributed on the linin in the form of chromomeres. A spireme is being formed, and it is contracting about the nucleolus.

Figs. 7, 8. The spireme moving away from the nucleolus. It is then very uneven in thickness.

Figs. 9, 10. Later ; the spireme is of even thickness.

Figs. 11, 12. Early prophase, showing hyaline kinoplasmic caps at elongated ends of nucleus.

Figs. 13, 14. Segmented spireme. Nuclear membrane intact. Nucleolus shows no sign of vacuolization. Spindle fibres have appeared in the hyaline caps. A granule lies at the apex of the fibres in Fig. 13.

Fig. 15. Segments of the spireme are shortening and thickening.

Figs. 16, 17. Metaphase with the undivided chromosomes.

Figs. 18, 19, 20. Early anaphase. The oval chromosomes moving towards the poles.

Fig. 21. Polar view of early anaphase ; at same stage as shown in Fig. 20.

Fig. 22. Polar view at metaphase, cut slightly obliquely. Eight chromosomes are seen.

Fig. 23. The chromosomes at the poles elongate. The first indication of a cell plate.

Fig. 24. The chromosomes at the poles are crowded. The cell plate is more distinct.

Figs. 25, 26. The chromosomes elongate and their identity is lost in the formation of the reticulum.

Fig. 27. The daughter nuclei in which there is a fine reticulum. Chromatin granules lying on the linin or free from it. There is a well-defined nucleolus and a definite nuclear membrane.

#### PLATE LV. Sporogenesis.

Fig. 23 was drawn using a Zeiss oil-immersion, numerical aperture 1.30, and a 6 Zeiss compensating ocular. Figs. 1, 7, 14, 15, 18, 19, and 25 were drawn using the same objective and an 8 compensating ocular, magnification 1,430. Figs. 2, 3, 4, 5, 6, 8, 9, 10, 11, 12, 13, 16, 17, 20, 21, 22, 24, and 26 were also drawn using the same objective but a 12 Zeiss compensating ocular, magnification 2,040.

Fig. 1. A mature spore mother-cell. The resting spherical nucleus has a close reticulum with chromatin knots at its angles. Groups of plastids lie in the cytoplasm.

Fig. 2. Enlarged nucleus. The masses of chromatin becoming more conspicuous and the reticulum thickening. Parts of the latter may be traced for some distance.

Fig. 3. Leptonema spireme, some portions of which lie parallel to each other. The chromatin bodies larger than in stage represented in Fig. 2.

Fig. 4. Synapsis. The chromatin bodies are of equal size and are very conspicuous in the synaptic knot.

Fig. 5. Recovery from synapsis. The spireme as it emerges from synapsis is very slender.

Fig. 6. The spireme is distributed throughout the nuclear cavity, and the chromomeres lie at equal distances on it.

Fig. 7. The spireme somewhat thickened. The chromomeres present a bead-like appearance.

Figs. 8, 9. The spireme has thickened and is contracted across a broad plane of the nuclear cavity. At this time it shows a split.

Fig. 10. A segmented spireme showing the split formed at the stage represented in Figs. 8, 9.

Fig. 11. The segments of the spireme are shortening and thickening. The split is still evident. The nucleolus has disappeared and the nuclear membrane is intact.

Fig. 12. The chromosomes have become short and thick.

Fig. 13. Metaphase showing broad, blunt spindle.

Figs. 14, 15, 16. Anaphase.

Fig. 17. Late anaphase, showing two parted chromosomes.

Fig. 18. The chromosomes at the poles are as yet distinct.

Fig. 19. Reconstruction of daughter nuclei, showing a slight reticular appearance. The nucleolus formed and the chromatin granules present. Indication of the first wall.

Figs. 20, 21. Daughter nuclei in prophase. Polar caps of spindle fibres very prominent.

Figs. 22, 24, 25. Hyaline polar caps on the spore mother nucleus.

Fig. 23. Section showing three of the spore nuclei ; the fourth nucleus and the first wall laid down is in another section.

Fig. 26. Coarse strands of cytoplasm extend from groups of plastids across the hyaline cap to the nuclear membrane.



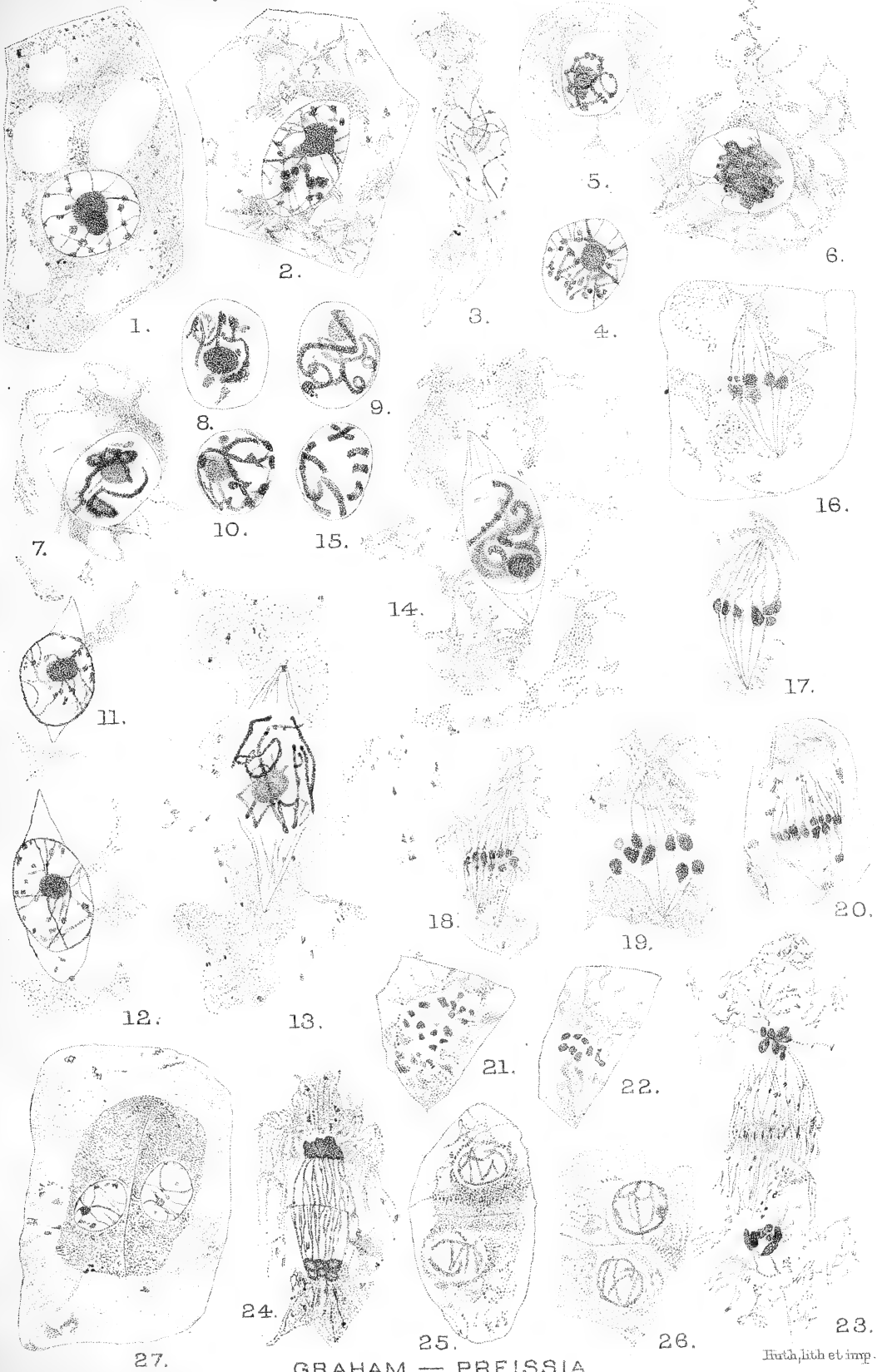









1.

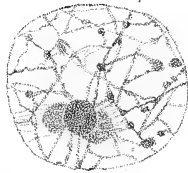

2.

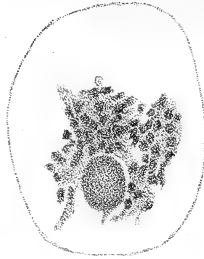

4.

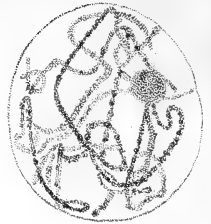

6.

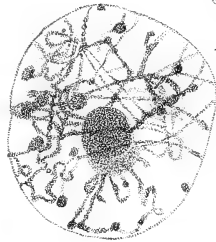

3.

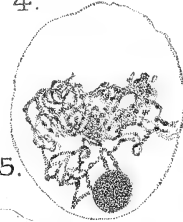

5.

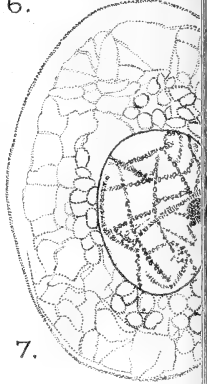

7.

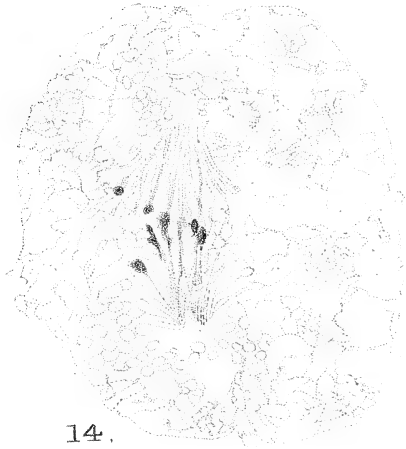

14.

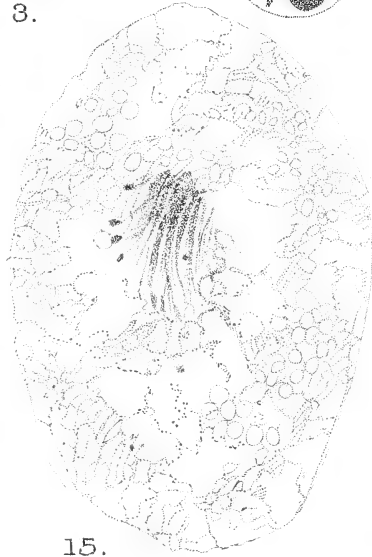

15.

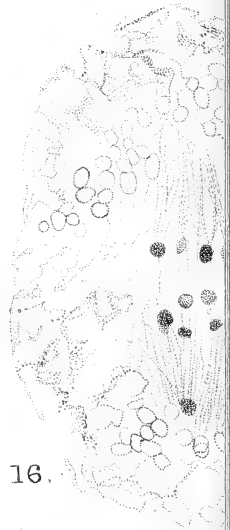

16.



18.

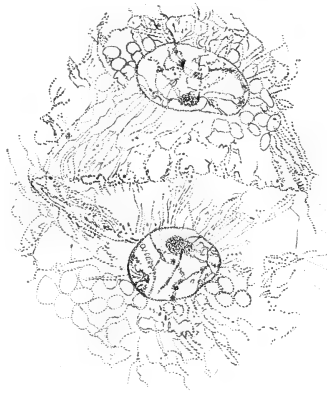

19.

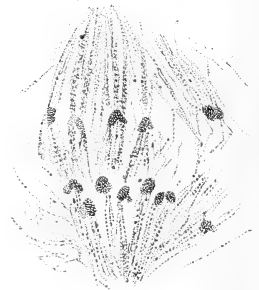

17.

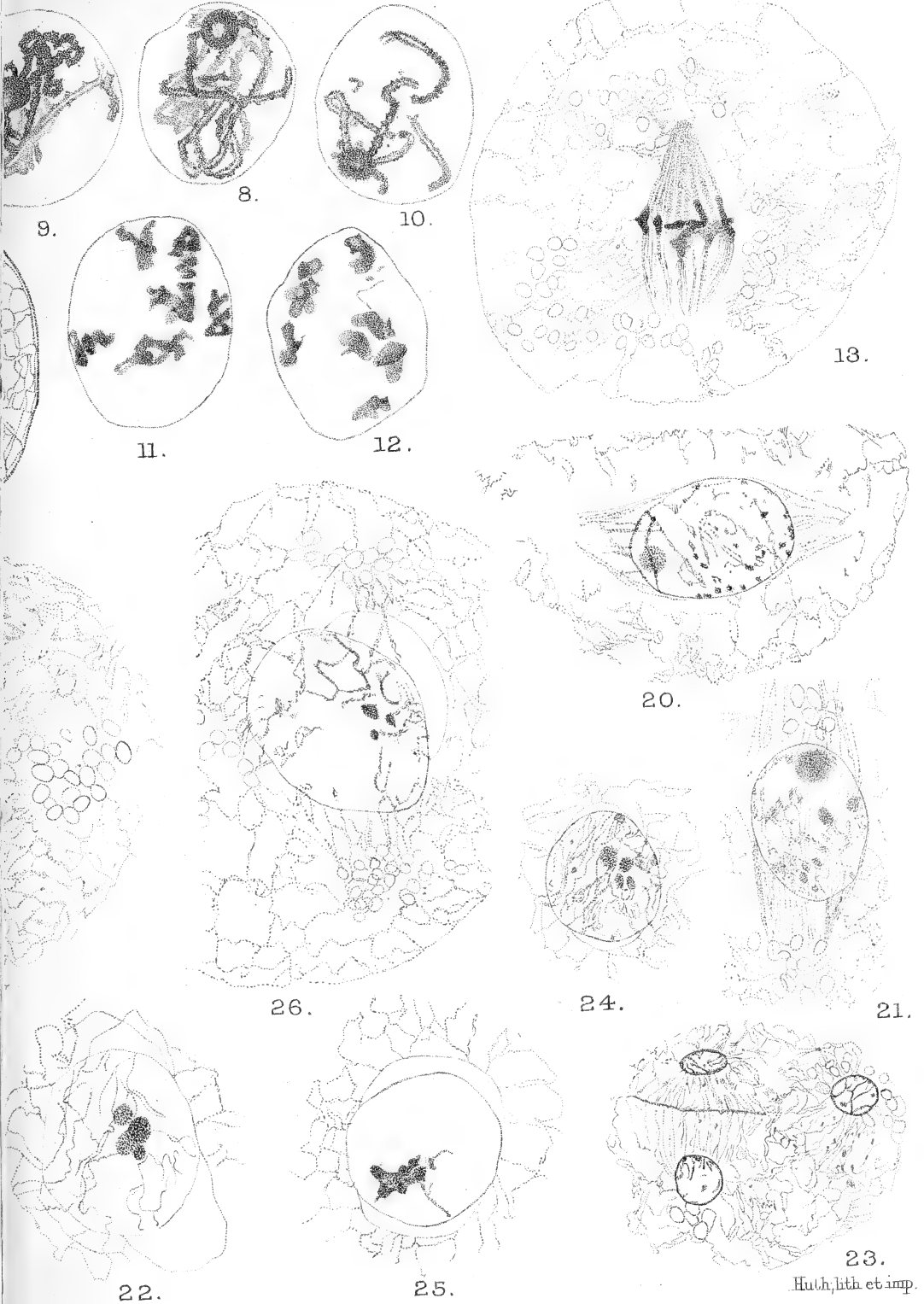



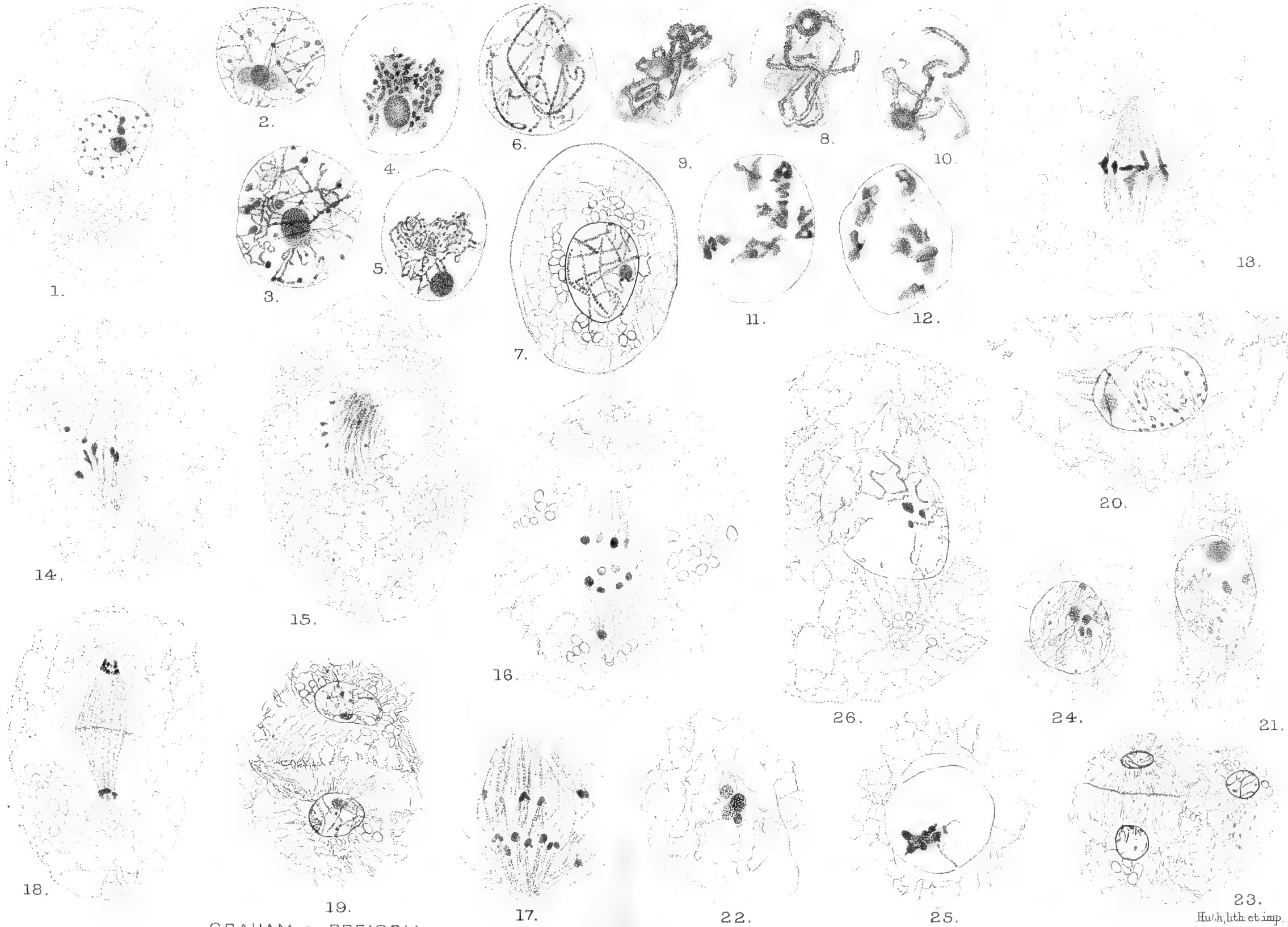

GRAHAM — PREISSIA.

Huth, lith et imp.



# Nuclear Division in *Tetraspora lubrica*.

BY

F. McALLISTER.

*School of Botany, University of Texas.*

With Plate LVI.

IT is principally in those forms of animals and plants in which the nuclei are extremely minute, thus rendering the interpretation of the data uncertain—and in unicellular organisms or in those forms in which the cells are so isolated that great difficulty is experienced in finding numerous stages of nuclear division,—that mitosis is described as departing radically from the firmly established series of changes described for the higher organisms. Probably more different types of nuclear division have been reported for the protozoan cell than all others put together.

To cite a few of the variations in mitosis reported for the protozoan cell—the nuclear material may not be collected in a nucleus, but is distributed throughout the protoplasm of the cell (Bütschli's 'distributed nucleus'), as is the case in *Tetramites* according to Calkins (4), and in *Tracheloceroa* according to Gruber (20); or the chromatic material may be collected in a nucleus but does not aggregate to form chromosomes—a fission of the chromatic granules occurring instead of a fission of chromosomes, as is the case in *Euglena*, according to Keuten (28) and others. In *Noctiluca*, according to Ishikawa (23, 24) and Calkins (5), chromatic bodies aggregate to form chromosomes.

The origin of the spindle or its equivalent is also very variable according to the published accounts. A definite intranuclear spindle, with centrosphere-like bodies at the poles, is described for *Euglypha* (Shewiakoff, 43) as well as for other forms. In *Euglena*, according to Keuten (28), Dangeard (11), and others, an intranuclear body, the 'nucleo-centrosome', is made responsible for the division of the nucleus. This persistent body divides and the resulting halves move apart, though connected by an isthmus of the same material. The chromatic material groups about the two halves, and as they move apart the chromatin bodies pass to the poles with the 'nucleo-centrosome', and there organize new nuclei with the persistent body in the centre.

In *Acanthocystis*, according to Schaudinn (12), the centrosphere lies in the cytoplasm. It divides and its halves separate, moving to the poles of the nucleus. There seems little essential difference between the mitosis here and that in the other animal mitoses, in which asters are involved. In *Paramoeba*, according to the same author, the only important difference lies in the difference in the size of the centrospheres 'Nebenkörper', which are nearly as large as the nucleus. Wilson (54) says: '*Paramoeba* appears to differ from *Euglena* mainly in the fact that at the close of division the sphere is in the former left outside the daughter nucleus, and in the latter enclosed within it.' There seems, however, a greater difference than this, for in *Euglena* no spindle is described or figured, while in the case of *Paramoeba* a very definite spindle figure is reported, with the large centrospheres at the poles.

In the light of these divergent types of nuclear division in the Protozoa, mitosis in the Protophytes, and especially in those forms regarded as most closely related to the Protozoans, is of especial interest. Thus far no results have been obtained in any of the green plants which seem in any way to correspond with the results reported by investigators on the Protozoa.

Mitosis in *Spirogyra* has been the subject of numerous investigations—probably more than in all other Algae combined—but very great variations exist in the accounts of mitosis in this Alga, and the discrepancies are so marked as to arouse the suspicion that the described appearances cannot all be normal. If we accept the reported accounts of mitosis in *Spirogyra* as accurate, we have in this genus greater and more fundamental variations in the phenomena of nuclear division than have been reported in all the remaining green plants from the Algae to the Angiosperms. The chromosomes have been reported as arising entirely from the nucleole (33, 34, 2) or partly from the nucleole and partly from the reticulum (15, 16, 56), or entirely from the reticulum (50, 46). Lutman's work on *Closterium* (31) seems to prove clearly that in this Conjugate nuclear division follows the well-known steps established for the higher plants. Van Wisselingh (57), working independently, came to the same conclusions at about the same time.

In view of the great similarity in the most conspicuous and constant characteristics in the nuclear division in all the green plants outside of *Spirogyra* and the other investigated Conjugatae, Moll's (36) suggestion that we should not expect the same mitotic phenomena in all species of *Spirogyra* must be regarded as based upon an unstable foundation.

The literature on the mitosis in *Spirogyra* has been recently fully reviewed by Berghs (2), Lutman (31), and others, so that a detailed review here seems superfluous.

Strasburger's earlier work on *Cladophora* (45) has recently been substantiated and extended by Nėmec (37). According to these accounts, the



chromosomes—about thirty in number—arise from the reticulum independently of the nucleole. A distinct bipolar spindle, with no traces of a centrosome or centrosphere, appears at metaphase. In one respect only—the persistence of the nucleole—is there any divergence from typical division as known in the higher plants. The nucleole, according to Némec, becomes much elongated, the two resulting parts remaining connected by a slender strand of nucleolar material. Not until the daughter nuclei are partly formed does this connecting strand disappear. The main elements of the nucleus, as well as of the method of nuclear division, are the same in this Alga as in the higher plants.

Tuttle (50) has recently confirmed the earlier work of Strasburger (45), Wille (52), and Mitzkewitsch (35) on nuclear division in *Oedogonium*, and has published a fuller account of mitosis in this Alga than any one of these investigators. His results clearly show the origin of a spireme thread from a reticulum, independently of the nucleole,—the formation of the chromosomes from this spireme, and the splitting of these and the distribution of the split halves to the daughter nuclei, where they become reconverted into the reticulum of the new nucleus. The nucleole forms no morphological part of the chromatic thread or the chromosomes. It is interesting to note that here the spindle is intranuclear.

Timberlake's work (48) on *Hydrodictyon* dealt with very minute nuclei and a small number of phases of division. Nevertheless, as he says, 'enough stages stand out sharply to show that the process is essentially the same as in the higher organisms.' A spireme is formed from the reticulum. This segments to form about ten chromosomes. These pass into the equatorial plate stage. Two groups of chromosomes are formed, probably by the splitting of each of the ten original chromosomes, although this splitting was not observed because of their very small size. Centrosome-like bodies are described and figured at the poles of the spindle figure.

Yamanouchi (59) has recently published a short note upon what he regards as a new species of *Hydrodictyon* from South Africa. A brief reference is made to nuclear division. He is of the opinion that the spindle is intranuclear and has centrosomes,—but his few small, diagrammatic text-figures certainly do not go far toward establishing the presence of centrosomes for this species. He refers to numerous chromatophores which 'have two functions, one to produce characteristic pyrenoids and the other to form reserve starch grains'. Starch formation was not observed in connexion with pyrenoids but it is formed, perhaps by secretion, in the plastids near one margin. If this brief reference is substantiated by more exhaustive investigation, we have in this Alga, plastids which cause starch deposition in a manner apparently identical with that in the seed plants,—the pyrenoid not functioning as a starch-forming cell organ.

Allen's research on *Coleochaete* (1) has shown that the reduction

divisions are here not essentially different from those in higher forms. In early prophase, apparently as the reticulum passes into a spireme, the chromatic material aggregates at one side of the nuclear cavity to form the synaptic knot. As it emerges from synapsis the chromatic material is in the form of a spireme thread. The nucleole retains its identity until about the time of the segmentation of the spireme to form the chromosomes. The further stages of mitosis are also in no essential way dissimilar to those of the higher plants.

Dangeard's work (9, 10) on certain of the Chlamydomonadaceae, while in no way complete or exhaustive in respect to any single species, has nevertheless shown that in this interesting group, regarded by many algologists as having the closest relationship with the Protozoans and even regarded as Protozoans by most zoologists, nuclear division does not vary essentially from that as established for the higher plants.

Working on *Chlamydomonas*, *Phacotus*, *Chlorogonium*, *Carteria*, and *Polytoma* he has described and figured phases of the division of the nucleus in which a definite number of chromosomes arise from a reticulum. The spindle arises from the cytoplasm and lacks centrosomes. There is no 'nucleo-centrosome' or equivalent body such as is reported by the same author, as well as others, for *Euglena*. Dangeard is of the opinion that the type of nuclear division in the Chlamydomonadaceae ('teleomitose') is of a higher type of development than that as determined for the Euglenidae ('haplomitose'),—and he proposes this difference in nuclear division as a character by which to separate the former group from the latter.

Davis in a discussion of spore formation in *Derbesia* (13) has given a few nuclear figures from the germinating spores. According to this brief reference, the spindle is intranuclear with minute granules at times to be seen at the poles. The spireme arises independently of the nucleole.

Fairchild (17) is inclined to believe that in *Valonia*, 'bei einigen Kernen', centrosomes with faintly defined asters are to be identified. He says, however,—'ich bin nicht sicher, ob mir wirklich Centrosomen vorlagen oder nur die convergirenden Enden der Spindelfasern, weil bei den ruhenden Kernen keine solchen Punkte zu finden waren.' The spireme arises from the reticulum and the nucleole contributes no morphological elements to it.

Debski (14) has shown that the nuclear division in *Chara* is more nearly similar in all its phases to mitosis in the higher plants than in any other Alga. The mode of spireme formation, the formation of the spindle and the cell plate seem almost identical with these processes in the nuclei of the higher plants.

Golenkin (19) believes, from evidence obtained from *Hydrodictyon* and *Sphaeroplea*, that in the resting condition of the nuclei of these Algae the chromatin is accumulated in the nucleole. He regards nuclei of this type as primitive, probably occurring in the lower green Algae.

It is of interest here to note that according to the account of Lauterborn (29) the nuclear division in the diatom *Surirella*,—unlike that of any other known plant,—has much in common with the type of mitosis that is reported for *Acanthocystis*, *Paramoeba* and other forms. According to Lauterborn's account, a central spindle is formed from a 'centrosome' lying outside the nucleus. The chromatin forms a spireme which breaks up into long chromosomes. The chromosomes become arranged about the cylindrical central spindle in the form of a ring. The ring-like mass separates into two groups which move to the poles where they organize the daughter nuclei.

The general details as to the formation of the central spindle may be said to be confirmed by Karsten (25) in his recent work on the reduction division in *Surirella saxonica*. Karsten shows clearly that here the spireme thread is organized from the reticulum independently of the nucleole. The relationship of this peculiar group to the Chlorophyceae is undoubtedly very remote.

Though differing somewhat as to the exact location of *Tetraspora* in the classification of the Chlorophyceae, nearly all students of the Algae seem agreed that the relationship of this group to the Chlamydomonadaceae is very close. There seems to be similar agreement in regarding the latter group as being the lowest of the green plants. Gay (18), Wille (53), Oltmanns (39), Chodat (7), and West (51) are practically in accord in placing the Volvocaceae as the lowest family in the order Protococcales with the Tetrasporaceae (or Palmellaceae) as the family next in order. Collins (8) places the Tetrasporaceae between the motile unicellular forms and the motile colonial forms.

Since Reinke's account (41) of the life history of *Tetraspora* in 1878 practically no work has been done upon this interesting genus. Brief references by Gay (18), Chodat (6) and West (51) seem to confirm, however, the details of this life history. Biciliate zoospores are reported and smaller biciliate isogametes. The latter fuse to form a zygote which,—according to Reinke, retains the cilia of the two gametes and swims about for a time evidently entering into a resting stage at a later period. Only very meagre references are made to the details of the structure of the cell.

The *Tetraspora* species which has been used in this study is common in the vicinity of Ithaca, N.Y., growing in shallow running water attached to the rocky bed of the stream. The lamellate, gelatinous colonies are usually buoyed up by entangled bubbles of gas. The length of the gelatinous masses varies from ten to forty millimetres, the diameter being from four to ten millimetres. The cells of the colony are approximately spherical and vary in diameter from seven to thirteen microns, depending of course upon the amount of growth which has taken place since the last division. The material agrees with the description of *Tetraspora lubrica* in many respects, though the characterization is not entirely satisfactory. All three

species given by Collins (8) overlap in regard to the size of the cells,—the specific characters being based to quite an extent upon the form of the thallus.

Colonies brought into the laboratory during afternoons in July and August and kept in small glass dishes were quite sure to form abundant zoospores upon the following morning. If the morning were cloudy the period of maximum zoospore formation might be as late as eleven o'clock. During the afternoon they were produced in much smaller numbers. Often a second crop is produced the second morning and some may even be formed on the third and fourth days.

In many instances, on the second and third mornings after the fresh material has been brought in, the cells in certain areas of the thallus are seen to be in active division. Eight cells are usually formed from one vegetative cell,—though at times but four are formed. These latter cases are probably from the smaller vegetative cells. This cell division goes on rapidly, and in a short time much of the gelatinous thallus has disintegrated.

The new cells formed by this rapid division become biciliated and soon swim away. Later they may be seen in various stages of fusion in pairs. I found no evidence, however, of their retaining their motility after fusion. Neither was there evidence of the formation of thick-walled resting spores.

During this period of rapid nuclear and cell division, leading up to the formation of gametes, many mitotic figures are easily obtained.

The chlorophyll of the cells of *Tetraspora* occupies a cup-shaped area at one side of the spherical cell. A relatively large flattened pyrenoid lies in the thickened base of the cup (Pl. LVI, Fig. 1). This distribution of the chlorophyll can easily be determined in living cells, but in material fixed in Flemming's or Merkel's fixative and stained in Flemming's triple stain or in Heidenhain's iron haematoxylin stain, no difference can be observed in the texture or staining reaction of the protoplasm of the chlorophyll-bearing area and that of the protoplasm surrounding the resting nucleus.

The resting nucleus of *Tetraspora* conforms in its general details of structure with the better known nuclei of the vascular plants. By suitable staining with Flemming's triple stain or with Heidenhain's iron-alum haematoxylin, a very delicate reticulum with numerous net knots can in all cases be demonstrated (Figs. 2, 3 and 26). The reticulum is so delicate, however, in these minute nuclei that with careless staining it may not be visible at all. In such instances the nucleole seems to lie in a clear area which usually shows no evidence even of a nuclear membrane. I have had a similar experience in staining the nuclei of *Ulothrix zonata*. These results are suggestive and may indicate that in those cases in which the nuclei of Fungi and Algae which are cited as lacking a reticulum and having all the chromatin collected in the nucleole,—the staining has been at fault. This

may possibly be the explanation of Golenkin's results with *Hydrodictyon* and *Sphaeroplea*.

In the early prophases the net knots become more conspicuous,—increasing in size until the chromatic granules are conspicuous blue-staining bodies many times the size of the original knots, and apparently of uniform size. Accompanying this increase in size there is an apparent decrease in the number of the net knots. Figs. 4 and 6 show stages in the development of these bodies. Notwithstanding these marked changes in the nuclear contents the reticulate condition persists in nuclei which have relatively large chromatin bodies (Fig. 5).

The nucleole apparently remains unchanged during the period of increase in chromatic material. Fig. 6 shows a nucleus in which the chromatic material is nearly at the stage of spireme formation while the nucleole is still intact. It seems perfectly clear that the nucleole does not here undergo disintegration during the increase of stainable material in the nuclear cavity. It does not disappear until the spireme material is all formed,—therefore any participation by the nucleole in the formation of the spireme thread must be very slight indeed.

The uniform chromatic bodies of this much modified reticulum apparently become arranged side by side or in a row to form the spireme thread, which, although at first appearing to be of irregular diameter, does not seem to be made up of definite 'chromomeres'. If this spireme is ever in a uniformly distributed condition throughout the nuclear cavity, it remains so distributed for but a very short time, for nearly all of the nuclei containing the unsegmented spireme show the thread somewhat contracted to form a loose aggregation occupying the central part of the nuclear cavity (Figs. 7 and 8).

A stage possibly similar to this has been described by Davis (12) as occurring in the prophases of dividing nuclei in germinating spores of *Pellia*. Here the chromatic material becomes more or less grouped around or near the nucleole in a loose aggregation, which does not entirely fill the nuclear cavity.

Stout (44) has also called attention to such an aggregation of the chromosomes in the nuclei of root tips of *Carex*. He says,—“At one stage in the late prophases the chain of chromosomes is tightly coiled about the nucleole.”

It is my opinion that no especial significance is to be attached to this contracted condition. The more or less connected condition of the chromosomes as late as the metaphases suggests that even during the spireme stage somewhat of a reticulate condition still exists. If such were the case, the uniform distribution of the spireme would probably be much restricted.

Upon the segmentation of the spireme, the chromosomes come to be quite widely separated from one another, causing this to be a conspicuous

phase. While not common in my material, this prophase was still frequent enough to be satisfactorily studied. The chromosomes are at first elongated rod-like structures (Figs. 9, 10, and 13). They shorten and thicken until their diameter is probably twice that of the chromosome at the time of the segmentation of the spireme, while their length becomes about twice their final diameter (Figs. 11, 12, 14).

The number of the chromosomes is small. Figs. 10 and 13 of nuclei immediately before metaphase and Fig. 19 of a polar view of a metaphase stage,—all made with no reference to the chromosome number, each show thirteen chromosomes. The chromosome count in other nuclei, not figured, gave twelve and thirteen as the number, and it is quite probable that thirteen is the correct number.

The details of spindle formation could not be followed on account of the minuteness of the nuclei. At the time of the metaphases, when the spindle is most conspicuous it is distinctly bipolar (Figs. 15, 16, and 18). Areas of protoplasm which suggest kinoplasmic caps were in several cases observed (Fig. 13) and it is quite probable that they give rise to the spindle in a manner quite similar to that described for root tip mitosis. An examination of many metaphases failed to reveal anything that could be interpreted as a centrosome or centrosphere. Neither in the first division of the cell nor in the second or the third division was a centrosome to be seen. The appearance of centrosome-like bodies in antheridia of some Bryophytes at the time of the formation of the male gametes suggests that centrosomes are to be expected at the time of the formation of swimming cells. If such bodies are present in *Tetraspora* I have been unable to stain them. Davis (12) has described centrosome-like bodies in *Pellia* which are usually present only in the early prophases and disappear before the metaphases. No such evanescent structure could be identified in *Tetraspora*.

The single group of chromosomes of the metaphases splits to form the two groups of the anaphases (Fig. 19). It is very probable that each chromosome splits to form the chromosomes of the anaphases,—though on account of their minuteness this could not be determined with certainty.

The reconstruction of the daughter nuclei (Figs. 20, 22, 23, and 24) as far as can be determined is the same as in higher plants. The chromatic material is at first densely massed (Fig. 20). This mass becomes looser and a nuclear membrane is formed (Fig. 22). The separation of the chromatic material into smaller and smaller parts goes on till the reticulum is formed (Figs. 23 and 24). Although the second and third nuclear and cell-divisions of the vegetative cell to form the eight gametes followed the first in quick succession, nevertheless the daughter nuclei in each case enter a resting condition similar to that of the vegetative nuclei (Figs. 24 and 28).

The partition walls are formed during the telophases by means of a central spindle not greatly unlike that in dividing cells in the higher plants.

Fig. 20 shows a definite central spindle in a very early telophase. Later, as in Fig. 23, the rudiments of a cell-plate may be seen in the central part of the central spindle as a collection of granules. Whether these granules arise as thickenings of the spindle fibres could not be determined with certainty. Stages such as are shown in Fig. 22, in which the central spindle and the cell-plate do not extend out to the cell-wall show clearly that cell-plate formation is initiated between the daughter nuclei, and the wall extends out to the wall as is the case in the higher plants. This, as above mentioned, is the case in *Oedogonium*, and may be of common occurrence in the green Algae, though in *Spirogyra* and *Cladophora* the cross wall formation is initiated at the wall and extends inward.

The splitting of the cell-plate seems also to be from the centre outward (Figs. 25 and 26). Frequent cases were observed in which there was a widely separated cleft between the two daughter-cells which did not extend to the surface of the cell. The wide separation of the cleft is of course due to plasmolysis. If the cell-plate had been split completely to the wall one could expect that the shrinkage would manifest itself on the outside of the cells, rounding up the newly formed corners and edges. This was not the case in any of the cells observed. It is clear that the cleavage does not begin at the surface and extend inward.

The single disc-shaped pyrenoid remains unchanged through the three nuclear and cell-divisions of the vegetative cell (Figs. 18, 27, and 28), so that at first but one of the eight cells which are to form the gametes has a pyrenoid (Figs. 28 and 29). The gametes at the time that they become motile are all equipped with a pyrenoid, the origin of which was not determined. It is clearly evident, however, that here the pyrenoid does not arise by the division of a pre-existent pyrenoid, but that it is formed anew from the cytoplasm. In the vegetative multiplication of the cells of the Alga the pyrenoid divides to form the pyrenoids of the daughter-cells.

It seems also clear that the pyrenoids do not disappear upon the initiation of the steps leading to gamete formation as is the case in *Hydrodictyon* and in *Chlamydomonas* according to Klebs (26, 27), in *Cladophora* according to Strasburger (45), and in *Volvox* on the authority of Overton (40). Fig. 29 shows the persistent pyrenoid in the eight-celled stage before the differentiation of the gametes.

The pyrenoids commonly appear as flattened disc-like bodies, one flattened surface being toward the nucleus. Usually there is a plane of cleavage extending through the centre of the mass parallel with the flattened surface (Figs. 8 and 9), separating it more or less completely into two parts. This apparent doubleness may be similar to that described by Timberlake (48) for *Cladophora*, in which 'the differentiation of the pyrenoid into two parts takes place in such a way as to divide it by a plane passing through its longer axis. In many cases the pyrenoid is actually split into

halves with a fairly broad cleft between them'. Not uncommonly the pyrenoid seems to be a solid mass with no plane of cleavage. Frequently they appear as rounded bodies (Figs. 13 and 14). These may in part of course be the flattened pyrenoids as seen from the side. Many of these rounded pyrenoids have undergone peripheral cleavage to form a number of smaller irregular starch masses which are perfectly distinct from one another (Fig. 31). They stain a uniform blue colour and show no differentiated central part such as is so well known for *Spirogyra* and has been described as a saffranin staining region by Timberlake (47) for *Hydrodictyon*, and by Lutman (32) for *Closterium*. They are, apparently, more like the pyrenoids of *Cladophora*, *Oedogonium*, or *Rhizoclonium* in which, according to Timberlake, 'in some instances the entire pyrenoid is converted into starch without previous cleavage.' As mentioned above, the protoplasm in which the pyrenoids lie cannot be distinguished in texture and staining reaction from that of other parts of the cell, though a narrow unstained zone is usually present immediately surrounding the pyrenoid.

#### DISCUSSION.

It will be seen from the foregoing that the general details of the nuclear structure and mitosis in *Tetraspora* and in other Chlorophyceae thus far investigated, are essentially the same. As far as can be determined from the minute nuclei of *Tetraspora* the structure of the resting nuclei, and the conduct of the chromatin in spireme formation, the origin and development of the spindle and the mode of the formation of the cell-plate are processes the same as in the Angiosperms. A striking uniformity thus exists throughout the green plants in the phenomena of nuclear division.

Accounts of the presence of centrosomes or centrospheres in certain cells of the Liverworts have encouraged the expectation that such centres should be common in the Chlorophyceae. Reports of great variation in the polar organization in the nuclei of the Protozoa, on the other hand, have contributed to this belief,—based on the view that certain Protozoans and the Chlorophyceae have probably arisen from a common ancestor. Investigations upon the mitosis in the green Algae have not sustained this expectation. The presence of centrosomes or centrospheres has thus far not been satisfactorily demonstrated in cells of this group of plants. It must be admitted, however, that the structures reported for *Valonia* (17), *Derbesia* (13), and *Hydrodictyon* (48, 59) strongly suggest centrosomes, and further investigations may prove them to be such. Nevertheless, they are clearly not such permanent centres as have been described by Harper (21) for *Phyllactinia*, as well as by others for various plant and animal cells.

The presence of intranuclear spindles in *Derbesia*, *Valonia*, and possibly in *Hydrodictyon* is suggestive of a permanent centre. Still, mitosis in



*Oedogonium* takes place without visible centrosomes though the spindle seems clearly intranuclear.

The appearance in the antheridia of certain Liverworts [*Marchantia* (22, 58), *Fegatella* (55), *Riccia* (30) and others] of centrosome-like bodies in the last cell generations before the formation of the motile gametes suggests the possibility of centrosomes appearing at or shortly before the stage at which the blepharoplast is present. While the three nuclear divisions of the vegetative cell of *Tetraspora* lead to gamete formation and should, on the above hypothesis, be especially favourable for the detection of centrosomes, nevertheless they show no such bodies.

According to the literature on mitosis in the Protozoan cell, many low forms have the chromatin of the nucleus concentrated in the nucleole. Such phenomena have been reported for *Hydrodictyon* and *Sphaeroplea* by Golenkin (19) and have been expected by some in other genera of the lower green Algae. Golenkin's results are probably to be explained as due to improper fixation or staining, since both Timberlake and Yamanouchi have demonstrated the presence of a reticulum in *Hydrodictyon*. Further research with *Sphaeroplea* will probably give similar results. It appears then that *Spirogyra* alone among the green plants thus far investigated is still in doubt. If we attempt to explain this divergence of the mitosis in *Spirogyra* on the ground that the Conjugatae probably arose contemporaneously with the Chlorophyceae from a common ancestor, and have developed their mode of mitosis independently of the latter group, we are confronted with the facts that in *Zygnema* and *Closterium* the nuclear division is well proved to be similar to that in the higher plants. The great uniformity in the nuclear phenomena of the line of green plants beginning with the Chlorophyceae leads one to expect a similar uniformity in the Conjugatae. According to the literature on this latter group such uniformity does not exist. Contrary to Moll's suggestion, this lack of uniformity probably is to be found in the investigator and his methods of fixation and staining, &c., rather than in the different species of *Spirogyra*. This conclusion is borne out by the fact that different investigators interpret differently the nuclear phenomena of the same species. For example, Moll believes that all of the chromosomes of *Spirogyra crassa* come from the nucleole, while van Wisselingh reports that but two come from the nucleole of this same species, while ten arise from the reticulum.

Dangeard's suggestion (11) that the groups Chlamydomonadaceae and Euglenidae be separated on the basis of their type of nuclear division was based upon a comparison of a number of genera of both orders. Although objection may be made to the terms 'teleomitose' and 'haplomitose' on the ground that the latter term implies too great simplicity of mitosis, it nevertheless seems clear that two perfectly distinct types of nuclear division exist here. In the Chlamydomonadaceae there are no centrosomes and the

spindle is of the same general type which is found in the cells of the higher plants. In the Euglenidae, on the other hand, no recognizable spindle threads seem to exist, but nuclear division appears to be accomplished by means of a persistent 'nucleo-centrosome' which divides, moves to the poles of the cell—each half with a group of chromatic bodies surrounding it. It is of interest here to note that this latter type of nuclear division, although occurring in the Diatoms and possibly in the Myxomycetes, has not been reported for any of the line of green plants arising with the Chlorophyceae.

In view of the remarkable similarity in nuclear structure and division among all green plants, this wide difference in the character of the mitosis in these two orders makes it clear that no closer relationship exists between them than that due to a possible common origin from a remote ancestor. The *Euglena* type of nuclear division has not been reported for any green plant. It must be admitted, nevertheless, that Olive's figures of mitosis in *Empusa* (38) show a striking similarity to the *Euglena* type of mitosis. This close similarity in the mitosis of such unrelated forms may suggest that data of a mitotic nature has little phylogenetic significance. The type of nuclear division so characteristic of the green plants is, however, so constant that it seems impossible to find an easy transition from it to the type characteristic of the Euglenidae. Thus the origin of the Chlamydomonadaceae from the Euglenidae as suggested by Blackman and others seems excluded.

It seems clear that in *Tetraspora*, although the chlorophyll-bearing protoplasm is definite and constant with regard to the position of the nucleus and pyrenoid, it is, nevertheless, not a highly differentiated protoplasmic body such as is to be seen in the plastids of *Spirogyra*, *Oedogonium*, *Vaucheria*, and the higher green plants. The chlorophyll-bearing area does not differ in texture or staining reaction from the other protoplasm. This is not in accord with Dangeard's observations in *Chlamydomonas* (9) in which he believes that the chlorophyll-bearing protoplasm is alveolar, while that surrounding the nucleus is reticulate. Timberlake (47) believes that the protoplasm in *Hydrodictyon* is not segregated into a 'layer containing chlorophyll and one containing nuclei'. The form of the cells of this Alga prevents, however, positive proof of this point with living material, while with fixed material it is possible that, as is the case with *Tetraspora*, no distinction can be detected. It is not improbable, as Timberlake says, that more careful investigation of a large number of forms of the Chlorophyceae will reveal frequent cases in which highly differentiated chloroplastids are not present.

SUMMARY.

1. The nucleus of *Tetraspora* in the resting condition has a chromatic reticulum, net knots and nucleole distributed in the same manner as in the higher plants.
2. A definite spireme is formed from the reticulum. The spireme segments to form about thirteen chromosomes.
3. The nucleole shows no signs of disintegration until the increase in chromatic material has come to an end.
4. Centrosomes are not to be identified at any stage of the nuclear division.
5. Cell-division is accomplished by the splitting of a granular cell-plate which has been formed by the central spindle. The splitting takes place from the centre outward.
6. The entire pyrenoid segments to form several starch bodies. No differentiated central area is present.

UNIVERSITY OF TEXAS,  
February 15, 1913.

---

LITERATURE CITED.

1. ALLEN, C. E.: Die Keimung der Zygote bei *Coleochaete*. Ber. d. deutsch. bot. Ges., xxiii, 1905, pp. 285-92.
2. BERGHS, J.: Le noyau et la cinèse chez le *Spirogyra*. La Cellule, xxiii, 1906, pp. 53-86.
3. BLACKMAN, F. F.: The Primitive Algae and the Flagellata: an Account of Modern Work bearing on the Evolution of the Algae. Annals of Botany, xiv, 1900, pp. 647-88.
4. CALKINS, G. N.: The Phylogenetic Significance of certain Protozoan Nuclei. Ann. N. Y. Acad. Sci., xi, 1898, pp. 379-400.
5. ———: Mitosis in *Noctiluca*. Ginn & Co., Boston. Also Journal of Morph., xv, 1898, pp. 711-72.
6. CHODAT, R.: Algues vertes de la Suisse: Pleurococcoides—Chroolepoïdes. Beitr. z. Kryptogamenflora der Schweiz, Band i, Heft 3, 1902.
7. ———: Étude critique et expérimentale sur le polymorphisme des Algues. Mém. publ. à l'occasion du Jubilé de l'Université de Genève. 1909.
8. COLLINS, F. S.: The Green Algae of North America. Tufts College Studies, vol. ii, No. iii, Scientific Series.
9. DANGEARD, P. A.: Mémoire sur les Chlamydomonadées, ou histoire d'une cellule et théorie de la sexualité. Le Botaniste, vi, 1898, pp. 65-292.
10. ———: Étude sur la structure de la cellule et ses fonctions. Le *Polytoma uvella*. Le Botaniste, viii, 1901, pp. 1-58.
11. ———: Recherches sur les Eugléniens. Le Botaniste, ix, 1902, pp. 1-261.
12. DAVIS, B. M.: Nuclear studies on *Pellia*. Annals of Botany, xv, 1901, pp. 147-80.
13. ———: Spore-formation in *Derbesia*. Annals of Botany, xxii, 1908, pp. 1-20.
14. DEBSKI, B.: Beobachtungen über Kernteilung bei *Chara fragilis*. Jahrb. wiss. Bot., xxx, 1897, pp. 227-48.

15. DEGAGNY, CH.: Sur les matières formées par le nucléole chez le *Spirogyra setiformis*, &c. Compt. Rend., 1893, pp. 269-72.
16. ———: Sur la concordance des phénomènes de la division du noyau cell. chez les Lis et chez les Spirogyras, etc. Compt. Rend., 1893, pp. 1397-1400.
17. FAIRCHILD, D. G.: Ein Beitrag zur Kenntniss der Kerntheilung bei *Valonia utricularis*. Ber. d. deutsch. bot. Ges., xii, 1894, pp. 331-8.
18. GAY, F.: Recherches sur le développement et la classification de quelques algues vertes. Paris, 1891, 119 pp.
19. GOLENKIN, M.: Ueber die Befruchtung bei *Sphaeroplea annulina*. Bull. Soc. imp. Moscou, 1899, pp. 343-61.
20. GRUBER, A.: Beiträge zur Kenntniss der Physiologie und Biologie der Protozoen. Ber. d. Naturf. Ges. zu Freiburg, 1, 1886, pp. 33-56.
21. HARPER, R. A.: Sexual Reproduction and the Organization of the Nucleus in certain Mildews. Publ. Carnegie Inst., Washington, No. 37, 1905.
22. IKENO, S.: Die Spermatogenese von *Marchantia polymorpha*. Beih. z. Bot. Centralblatt, xv, 1903, pp. 65-88.
23. ISHIKAWA, C.: Studies on Reproductive Elements: II. *Noctiluca miliaris*, Sur., its division and spore formation. Journ. College of Sc. Imp. Univ. Japan, vi, 1894, pp. 297-337.
24. ———: Further Observations on the Nuclear Division of *Noctiluca*. Journ. Coll. Sci. Tokio, xii, 1899, pp. 243-62.
25. KARSTEN, G.: Ueber die Reduktionstheilung bei der Auxosporenbildung von *Surirella saxonica*. Zeitschr. f. Bot., iv, 1912, pp. 417-26.
26. KLEBS, G.: Ueber die Bildung der Fortpflanzungszellen bei *Hydrodictyon*. Bot. Zeitung, xlix, 1891, p. 789.
27. ———: Die Bedingungen der Fortpflanzung bei einigen Algen und Pilzen. Jena, 1896.
28. KEUTEN, J.: Die Kerntheilung von *Euglena viridis*. Zeitschr. f. wiss. Zool., lx, 1895, pp. 215-35.
29. LAUTERBORN, R.: Untersuchungen über Bau, Kerntheilung und Bewegung der Diatomeen. Leipzig, 1896.
30. LEWIS, C. E.: The Embryogeny and Development of *Riccia lutescens* and *R. crystallina*. Bot. Gaz., xli, 1906, pp. 109-38.
31. LUTMAN, B. F.: Cell and Nuclear Division in *Closterium*. Bot. Gaz., li, 1911, pp. 401-30.
32. ———: Cell Structure of *Closterium Ehrenbergii* and *Closterium moniliferum*. Bot. Gaz., xlix, 1910, pp. 241-55.
33. MEUNIER, A.: Le nucléole de *Spirogyra*. La Cellule, iii, 1887, pp. 333-410.
34. MITZKEWITSCH, L.: Ueber die Kerntheilung bei *Spirogyra*. Flora, lxxxv, 1898, pp. 81-124.
35. ———: Zu der Frage nach der Zell- und Kerntheilung von *Oedogonium*. Ref. Strasburger, Hist. Beitr., vi, 1900, p. 191. (In Russian.)
36. MOLL, J. W.: Die Fortschritte der mikroskopischen Technik seit 1870. Prog. Rei Bot., ii, 1908, pp. 227-91.
37. NĚMEC, B.: Ueber die Kerntheilung bei *Cladophora*. Bull. Acad. Internat. d. Sci. de l'Emp. François Joseph, Classe Scient., Math., etc., xv, 1910, pp. 50-55.
38. OLIVE, E. W.: Cytological Studies on the Entomophthorae. II. Nuclear and Cell-division of *Empusa*. Bot. Gaz., xl, 1906, pp. 229-61.
39. OLTMANN, F.: Morphologie und Biologie der Algen. Jena, 1904.
40. OVERTON, E.: Beitrag zur Kenntniss der Gattung *Volvox*. Bot. Centralbl., xxxix, 1889, pp. 145-50.
41. REINKE, J.: Ueber *Monostroma bullosum*, Thur. und *Tetraspora lubrica*, Ktz. Jahrb. wiss. Bot., xi, 1878, pp. 531-47.
42. SCHAUDINN, F.: Ueber das Centrakorn der Heliozoen. Verh. d. zool. Ges., vi, 1896, pp. 113-30.
43. SCHEWIAKOFF, W.: Ueber die karyokinetische Kerntheilung bei *Euglypha alveolata*. Morph. Jahrb., xiii, 1888, pp. 193-258.
44. STOUT, A. B.: The Organization of the Chromosomes in *Carex*. Science, N.S., xxxiii, 1911, pp. 264.
45. STRASBURGER, E.: Zellbildung und Zelltheilung. 3. Aufl., Jena, 1880.
46. ———: Ueber Kern- und Zelltheilung im Pflanzenreich. Jena, 1888.

47. TIMBERLAKE, H. G. : Starch formation in *Hydrodictyon utriculatum*. Ann. Bot., xv, 1901, pp. 619-35.
48. ————— : Development and Structure of the Swarmspores of *Hydrodictyon*. Trans. Wis. Acad. Sci. Arts and Letters, xiii, 1902, pp. 486-522.
49. ————— : The Nature and Function of the Pyrenoid. Science, N.S., xvii, 1903, p. 460.
50. TUTTLE, A. H. : Mitosis in *Oedogonium*. Journ. Exp. Zool., ix, 1910, pp. 143-57.
51. WEST, G. S. : A Treatise on the British Fresh-water Algae. Cambridge, 1904.
52. WILLE, N. : Algolog. Mittheilungen, LV; Ueber die Zelltheilung bei *Oedogonium*. Jahrb. wiss. Bot., xviii, 1887, pp. 426-518.
53. ————— : Nachträge zum I. Teil, Abteilung 2. (Die natürlichen Pflanzenfamilien, Engler und Prantl.) Conjugatae und Chlorophyceae. Leipzig, 1909.
54. WILSON, E. B. : The Cell in Development and Inheritance. New York, 1906.
55. WILSON, M. : Spermatogenesis in the Bryophyta. Ann. Bot., xxv, 1911, pp. 416-57.
56. VAN WISSELINGH, C. : Ueber Kerntheilung bei *Spirogyra*. Flora, lxxxvii, 1900, pp. 353-77.
57. ————— : On the Structure of the Nucleus and Karyokinesis in *Closterium Ehrenbergii*, Men. Koninkl. Akad. Wetens. Amsterdam, xiii, 1910, pp. 365-75.
58. WOODBURN, W. L. : Spermatogenesis in certain Hepaticae. Ann. Bot., xxv, 1911, pp. 299-313.
59. YAMANOUCHI, S. : *Hydrodictyon africanum*, a new species. Bot. Gaz., lv, 1913, 74-9.
60. ZACHARIAS, E. : Ueber den Nucleolus. Bot. Zeit., xliii, 1885, pp. 257, 273, 289.

## EXPLANATION OF FIGURES IN PLATE LVI.

Illustrating Mr. McAllister's paper on *Tetraspora lubrica*.

All figures were drawn with the aid of a camera lucida, a Zeiss apochromatic immersion lens, 1.40 N.A., and an 18 compensating ocular (magnification about 3,000) being used in all cases except for Fig. 1, which has a magnification of about 1,650 diameters.

Fig. 1. Cells drawn from living material showing localized chlorophyll-bearing area.

Fig. 2. Cells showing nucleus in resting condition. The cytoplasm here shows no differentiation into chloroplastid.

Fig. 3. A resting nucleus showing reticulum and nucleole.

Fig. 4. An early prophase showing increase of chromatic material in the nucleus.

Fig. 5. A later prophase.

Fig. 6. Still later prophase with nucleole still intact.

Fig. 7. The chromatic material has contracted to form a knot in the centre of the nuclear cavity.

Fig. 8. A looser knot showing the presence of a spireme. The double nature of the pyrenoid is well shown in this figure.

Fig. 9. The segmented spireme.

Fig. 10. As above.

Fig. 11. The chromosomes shortening and thickening.

Fig. 12. Similar to Fig. 11.

Fig. 13. Immediately before metaphase of the second division. Caps of denser protoplasm are to be seen at the poles of the nucleus. Thirteen chromosomes are to be identified.

Fig. 14. Late prophase of the second division.

Fig. 15. Metaphase of the first division.

Fig. 16. Metaphase of the first division.

Fig. 17. Metaphase of the second division. One a polar view with eleven chromosomes.

Fig. 18. A polar view of the first metaphase showing thirteen chromosomes.

Fig. 19. Anaphase of the first division.

Fig. 20. Late anaphase or early telophase—the central spindle conspicuous.

Fig. 21. Early telophase of the second division.

Fig. 22. Later telophase—the nuclear membrane is now present and the cell-plate partly formed.

Fig. 23. The cell-plate appears as a definite line of granules, more conspicuous in the central region, but to be traced indistinctly nearly to the cell-wall. Part of the central spindle is still easily identified.

Fig. 24. Fully formed daughter nuclei have moved closer together. The kinoplasm of the central spindle area no longer appears fibrous. The cell-plate is clearly most perfectly developed in the central region.

Figs. 25, 26. The cell-plate is split in the middle and widely separated by plasmolysis. The cleavage cannot be traced to the peripheral wall.

Fig. 27. Completely separated daughter-cell of the first division.

Fig. 28. Daughter nuclei of the third division. One single large pyrenoid.

Fig. 29. The eight cells at the close of the third division. A single deeply lying pyrenoid is to be seen in the central cell.

Fig. 30. A gamete rounded up—the eye spot and cilia not yet visible.

Fig. 31. Pyrenoids showing peripheral cleavage to form several starch masses.



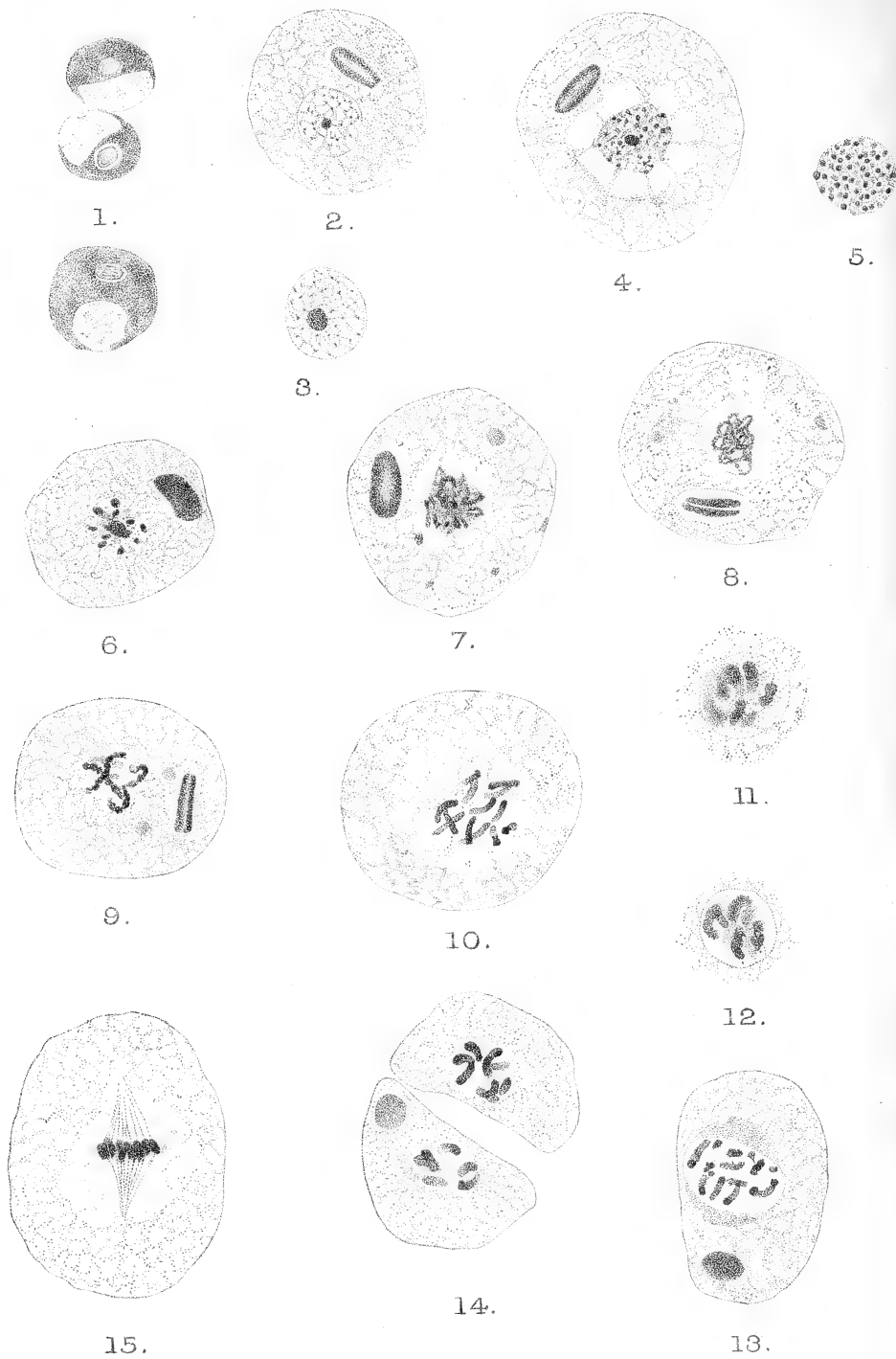



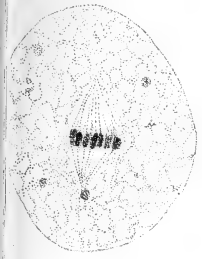

16.

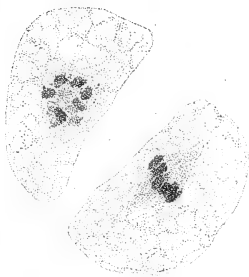

17.

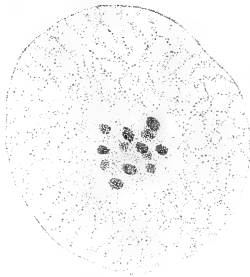

18.



19.



20.

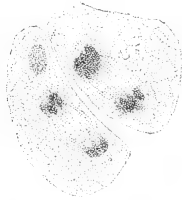

21.

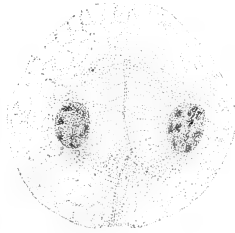

22.

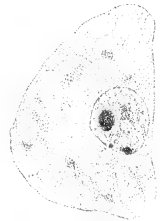

27.

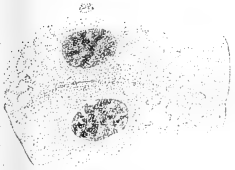

24.

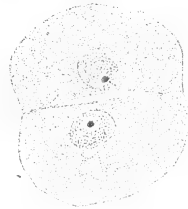

25.



30.



26.



28.

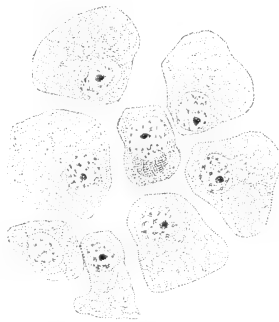

29.



31.





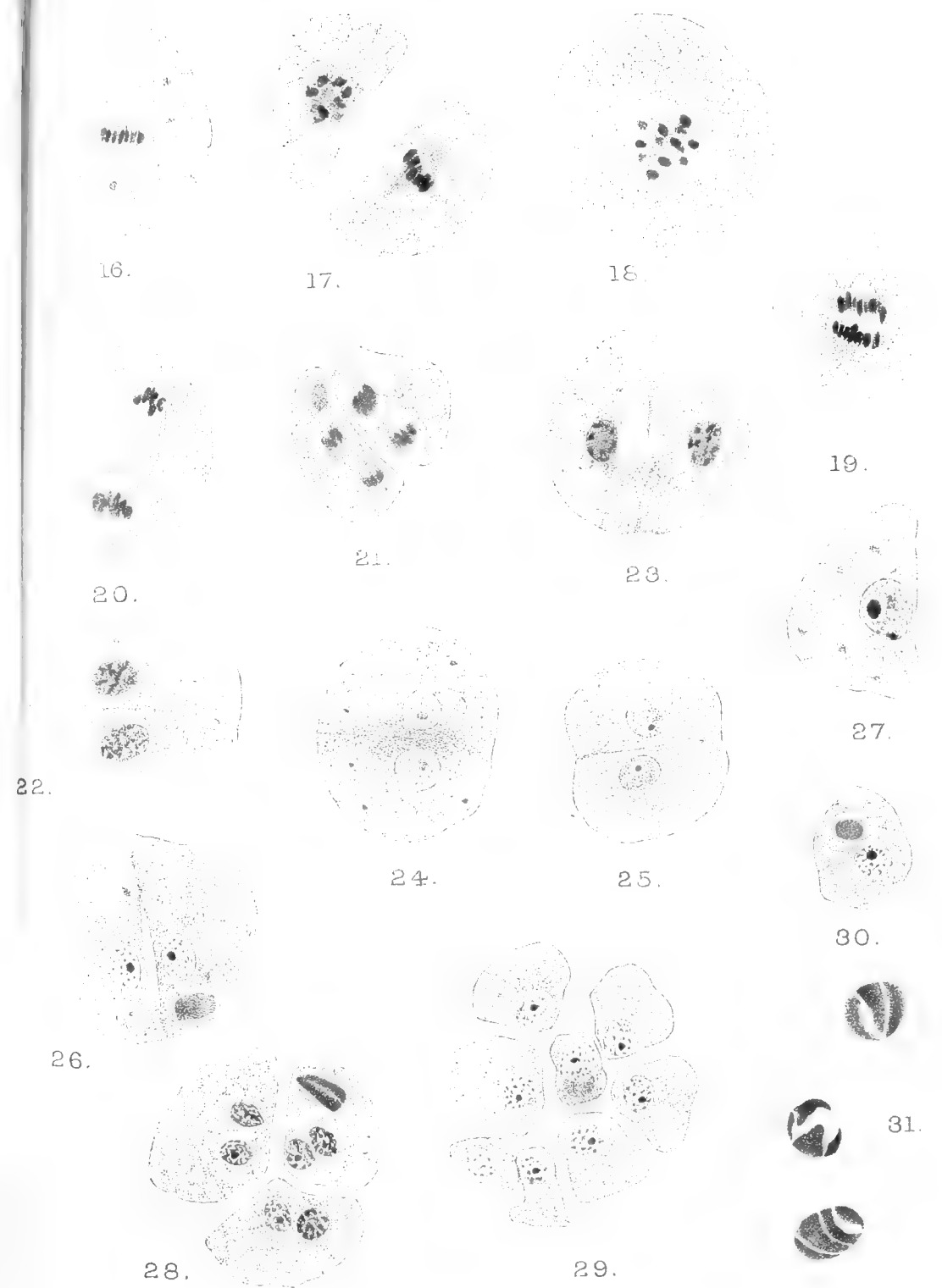
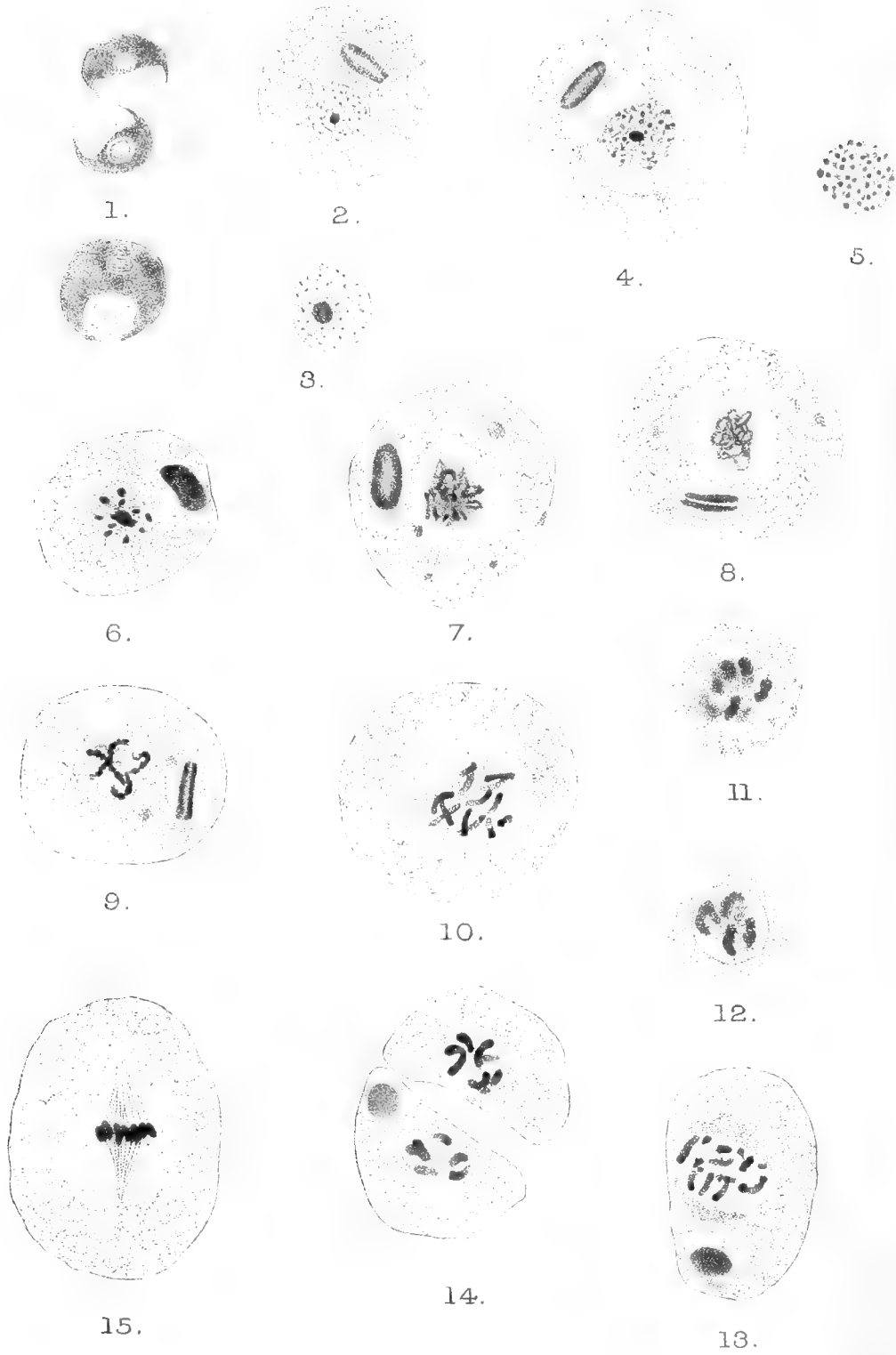

M<sup>c</sup>ALLISTER — TETRASPORA

Huth, lith et imp



# On the Effect of Chloroform on the Respiratory Exchanges of Leaves.<sup>1</sup>

BY

D. THODAY, M.A.

*Lecturer in the Physiology of Plants in the University of Manchester.*

With fifteen Figures in the Text.

THAT the carbon dioxide evolved in the respiration of plants is of complex origin is now a generally accepted view. It is recognized that enzymes play a large part in the processes leading to its evolution and also to the absorption of oxygen, which is normally concurrent with it. The available evidence seems to show that a close correlation is maintained between the rates at which oxygen is absorbed and carbon dioxide produced in normal respiration, but the chain of processes is still incompletely known and the regulating mechanism a matter for conjecture. It is to be expected that a careful quantitative investigation of the temporary increase in the intensity of respiration produced by various chemical and other agencies may throw light upon the factors which are concerned in keeping the balance between the respiratory processes.

One interesting aspect of the problem that has received little attention is whether or how far a close quantitative relation continues to exist between the evolution of carbon dioxide and the absorption of oxygen under the influence of stimulating agencies. The work of which an account is given here was undertaken at Dr. F. F. Blackman's suggestion with this aspect in view.

There is little doubt that the augmentation produced by different agencies is not necessarily of the same nature, even if, as Palladin holds,<sup>2</sup> the primary effect is always protoplasmic. Müller-Thurgau and Schneider-Orelli<sup>3</sup> found that stimulation due to exposure to a high temperature and stimulation following upon injury, in Potato tubers, were antagonistic. In the case of an anaesthetic such as chloroform, it may be inferred with probability from its chemical inactivity and high degree of saturation, that

<sup>1</sup> This paper forms Part XI of 'Experimental Researches upon Vegetable Assimilation and Respiration', carried out in the Botany School, Cambridge. A preliminary account was given at the Sheffield meeting of the British Association in 1910. See Report, p. 765.

<sup>2</sup> *Jahrb. f. wiss. Bot.*, xlvii, 1910.

<sup>3</sup> *Flora*, 1910.

its direct effect will be of a relatively simple physical nature.<sup>1</sup> It is with the changes which follow the exposure of leaves to chloroform vapour that this paper is concerned. Miss Irving<sup>2</sup> has given numerous data for the rate of production of carbon dioxide by Barley shoots, and by leaves of Cherry Laurel under the influence of chloroform. In the experiments described here, in which leaves of Cherry Laurel and certain other plants received similar treatment, the relation which the absorption of oxygen bears to the concurrent evolution of carbon dioxide was investigated. As the chemical nature of the material used in respiration alters the respiratory quotient, some leaves were first starved in the dark and then chloroformed.

The work was begun during my tenure of a Mackinnon Research Studentship of the Royal Society in 1909-10, and carried out at the Cambridge Botany School. I desire to express my thanks to Dr. Blackman for his kind and helpful interest in the work.

#### METHOD.

In order to investigate absorption of oxygen as well as evolution of carbon dioxide, the procedure adopted was to analyse samples of the air of a closed chamber in which leaves were contained. It appeared desirable to be able to examine the initial period of stimulation very closely, and for this purpose to take samples at relatively short intervals. As the change in the composition of the air in the respiration chamber during any given interval is smaller the shorter the interval, but depends also upon the total volume of air and on the quantity of respiring material, these factors had to be adjusted so that the changes could be measured with sufficient accuracy.

The analyses were made with the capillary eudiometric apparatus of Bonnier and Mangin, of the form described by Aubert.<sup>3</sup> This has the two advantages that analyses can be made quickly, a valued feature when samples were to be taken at short intervals, and also that very small volumes can be analysed, and thus the diminution of the total volume of gas can without serious error be ignored. An account of the way in which this apparatus was used (which differed in some respects from Aubert's instructions), with a discussion of the sources of error, has been given separately.<sup>4</sup>

As the limit of error was found to be about 0.1 per cent. of the total volume of air analysed,<sup>5</sup> in determining the percentages of CO<sub>2</sub> and O<sub>2</sub> in

<sup>1</sup> Cf. H. E. and E. F. Armstrong, Roy. Soc. Proc., B, 82, 1910, pp. 588-602; Annals of Botany, xxv, 1911, p. 508; Bechold, Die Kolloide in Biologie u. Medizin, 1912, p. 32.

<sup>2</sup> Annals of Botany, xxv, 1911, p. 1077.

<sup>3</sup> Rev. gén. de Bot., iii, 1891.

<sup>4</sup> Annals of Botany, xxvii, 1913, p. 565.

<sup>5</sup> In addition to a variation from the mean up to about  $\pm 0.1\%$  among a series of analyses of the same sample of air, the percentage of O<sub>2</sub> was on the average 0.2 below the correct value, 20.9. This error has since been traced to its sources; it does not vitiate the results, as it enters into all the analyses equally, and is eliminated when two results are subtracted in calculating the *change* of

a sample, it was necessary to ensure that the changes of composition to be measured should be relatively large. For this reason several leaves were enclosed together in a chamber of minimal volume specially constructed for the purpose. This chamber (shown in plan and sectional elevation in Fig. 1) was designed in collaboration with Dr. F. F. Blackman and made by the Cambridge Scientific Instrument Company. It consisted of two parts, a heavy circular base of brass (A), and the flat chamber itself (B), carried by a brass disc (C) which was accurately ground into the base, and so when greased made an air-tight junction with it. There was a small tubulure (D) at the top of the chamber to which a manometer could be attached, and another (E) at the side of the base, leading into the small space between the disc and the base. This latter tubulure could be connected to an apparatus for withdrawing samples of the enclosed air, which was similar to that used by Aubert.<sup>1</sup> This chamber had the special advantage that it could readily be opened to renew the air or examine the condition of the leaves enclosed in it, and as readily closed again perfectly air-tight, working, when greased, like a well-ground stopper.

No attempt was made to investigate respiratory exchanges *during* exposure to chloroform vapour, as its presence in the air would have introduced errors into the analyses, and there appears to be no satisfactory method of removing it before analysis. Leaves were therefore chloroformed in a separate vessel, with a capacity of about a litre, by adding a measured volume of liquid chloroform on a piece of cotton-wool. The duration of the exposure varied from 2 to 25 minutes in different experiments, and the dose from 0.05 c.c. to 1.0 c.c. (0.075 to 1.5 grm.) of liquid chloroform to the litre of air.

The procedure here outlined has not proved in all cases sufficiently sensitive for the satisfactory investigation of changes in the respiratory

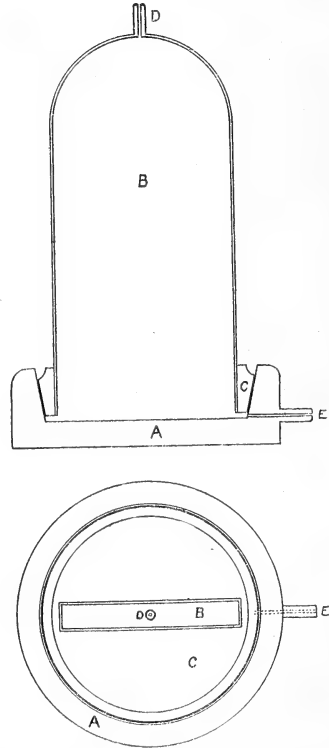

FIG. 1. Plan and sectional elevation of leaf-chamber.

composition which has occurred during a given interval. Improvements have been introduced into the technique by which the range of difference between analyses of the same sample as well as the absolute error are now very much reduced. See loc. cit.

<sup>1</sup> Rev. gén. de Bot., iv, 1892.

quotient when these are small. When a number of leaves are packed together in a small space it is difficult to ensure the uniform distribution of the gases before withdrawing a sample for analysis; and also during a period of several hours' enclosure the large increase in the concentration of carbon dioxide which takes place results in a storage of carbon dioxide in the tissues ready to reappear as an apparent acceleration of the respiration as soon as the air has been renovated. Modifications are in progress by which it is hoped to push the investigation further.

#### EXPERIMENTS WITH CHERRY LAUREL.

Six leaves were enclosed together in the respiration chamber for each experiment. Before treatment with chloroform, determinations of the normal rate of respiration were made.

The results are given, usually in graphic form, in cubic centimetres of oxygen or  $\text{CO}_2$  per hour *per leaf*. The continuous line gives the rate of absorption of oxygen, the broken line the rate of production of  $\text{CO}_2$ .

All the experiments were carried out at the temperature prevailing in the laboratory.

The experiments first given show the effect of exposure to the vapour of chloroform in relatively low concentration, which produced no visible change in the leaves.

EXPERIMENT I. July 14, 1911. Dose, 0.2 c.c. liquid chloroform per litre of air for 15 minutes. Fresh Cherry Laurel leaves.

Six leaves of the current season, weighing 11.0 grammes, were gathered

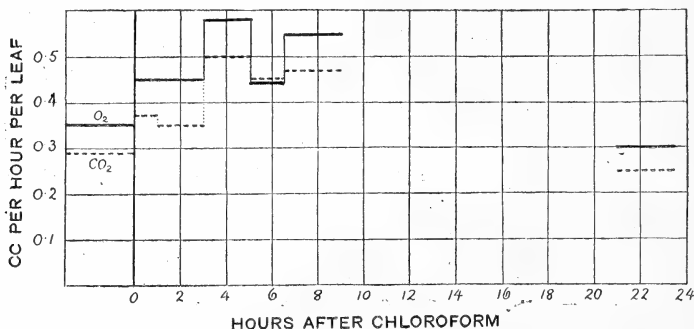

FIG. 2.

the previous evening after a bright sunny day, and left in the dark with their stalks in water under an inverted beaker. Next morning they were enclosed for three hours to determine their normal rate of respiration, and then chloroformed. The rates of absorption of oxygen and evolution of  $\text{CO}_2$  per hour per leaf are shown graphically in Fig. 2. The temperature rose gradually from  $19.4^\circ\text{C}$ . at the beginning of the preliminary three hours to  $22.8^\circ\text{C}$ ., nine hours after the chloroforming.



The  $O_2$  intake and the  $CO_2$  output show a similar increase, the curves for both corresponding with type B of Miss Irving's *schema*,<sup>1</sup> in which, after the initial stimulation, the respiration diminishes as starvation proceeds. Seventy hours after removal from the chloroforming vessel the respiration had still further diminished, the  $O_2$  intake being 0.16 c.c., and the  $CO_2$  output 0.14 c.c. per hour per leaf. The leaves were then still green.

EXPERIMENT II. July 11, 1911. Dose, 0.2 c.c. per litre for 15 minutes. Temperature, 19–22° C. Six leaves of the current season, weighing 9.6 grammes, starved for four days in the dark.

Owing to starvation the leaves used in this experiment were respiring at a very low rate. In Fig. 3 are plotted the results obtained during the first thirty-four hours, after treatment with chloroform exactly as in Experiment I.

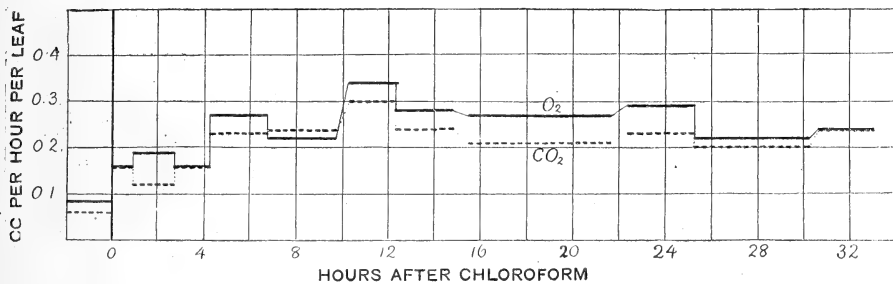

FIG. 3.

The respiration was in this case greatly augmented, and remained at the high level for a considerable time. The leaves were kept under observation for fifteen days, and their rate of respiration determined at intervals. Comparison with results obtained with other lots of leaves of similar age which had been in the dark for the same time but had not been chloroformed, shows that the respiration of the chloroformed leaves had fallen to the normal level on the sixth, but not on the third day. The parallel results *in c.c. per gramme of fresh weight*, and reduced to 22° C., are given in the following table :

Day.	Chloroformed leaves <i>c.c. per hr. per grm. fresh weight.</i>		Leaves not chloroformed <i>c.c. per hr. per grm. fresh weight.</i>	
	$CO_2$	$O_2$	$CO_2$	$O_2$
3	{ 0.083 0.086 }	{ 0.105 0.109 }	0.068	0.082
5			0.049	0.075
6	0.059	0.080		
7			0.066	0.082

In these two experiments the stimulatory effect of chloroform is plainly visible, and the augmentation affects the absorption of oxygen and production of  $CO_2$  nearly equally. The recovery which follows is apparently

<sup>1</sup> Loc. cit., p. 1083.

complete. The fresh leaves soon regained their normal intensity of respiration. In the starved leaves of Experiment II, on the other hand, respiration was maintained at the high level for several days. Other similar experiments with starved leaves, though not all, showed a similar relatively persistent augmentation of the respiration; what the exact conditions may be which determine this interesting effect is not yet clear.

EXPERIMENT III. July 16, 1909. Dose, 0.2 c.c. for sixteen minutes. Temperature, 18–20° C.

The six leaves used had been gathered two days previously. The rate of respiration before chloroforming had fallen a little below that of other similar leaves newly gathered.

In this experiment the dose was the same as in the previous experiments, but more chloroform appears somehow to have penetrated into the leaves during exposure; for, although no change was visible before they were put into the respiration chamber, at the end of six hours small chocolate-coloured spots were found on them, showing that in these places the cells were completely disorganized. As before, the respiration was augmented; it reached a greater maximum intensity than in Experiment I, and remained at a high level

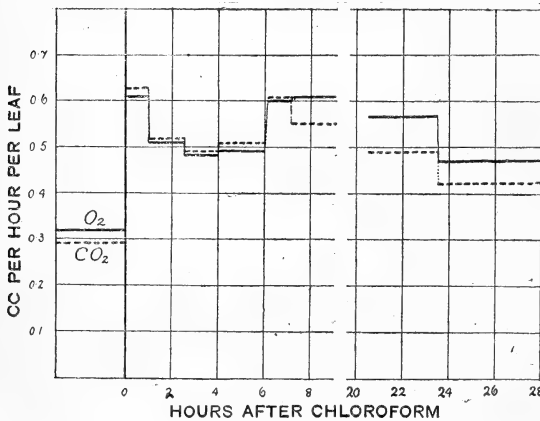

FIG. 4.

much longer, though not so long as in Experiment II. It appears that the rate of production of CO<sub>2</sub> rose slightly above the rate of absorption of oxygen, and was so maintained for about six hours; the respiratory quotient thus rose from about 0.9 to about 1.03. In the subsequent slow fall the O<sub>2</sub> intake fell more slowly than the CO<sub>2</sub> output, so that eventually the original respiratory quotient was reached again.

In the next two experiments the dose of chloroform was large enough to be followed by complete disorganization. The first sign of the change was already visible as a uniform faint brown tinge when the leaves were removed from the chloroforming vessel, and the brown coloration rapidly deepened during the period of enclosure in the respiration chamber to a uniform chocolate brown. The first faint tinge of brown is always, as far as my observations go, a sign that irreversible changes have begun from

which there is no recovery, for it is always quickly followed by the condition of complete disorganization associated with the chocolate colour.<sup>1</sup>

EXPERIMENT IV. July 14, 1909. Dose, 0.5 c.c. for twenty minutes. Temperature, 18.4–18.7° C. Fresh leaves. The leaves were of the current season, and were cut a few hours before they were used.

The absorption of oxygen proceeded much more quickly during the first half-hour after treatment with chloroform, but rapidly diminished to a low level, from which it slowly sank through a period of thirty-six hours. The CO<sub>2</sub> output, on the other hand, had fallen even in the first half-hour to a very low level, and fourteen hours later was inappreciable.

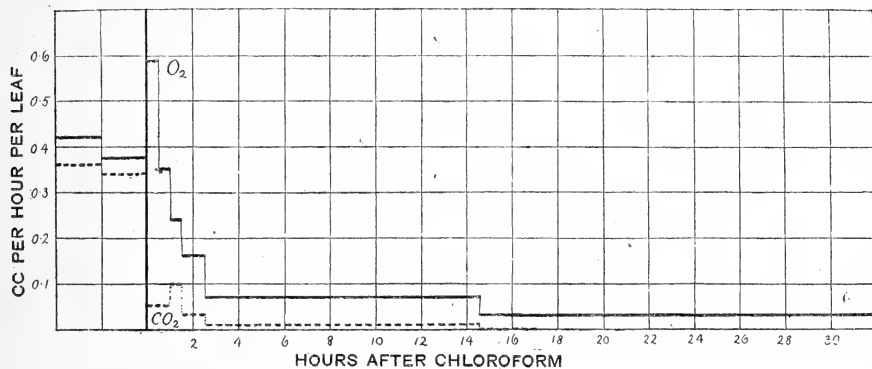

FIG. 5.

EXPERIMENT V. July 10, 1909. Dose, 0.5 c.c. for fifteen minutes. Temperature, 14–15° C. Starved leaves.

The leaves had been in the dark for several weeks, and were yellow to the extent of about a third of their area. Here the O<sub>2</sub> intake was still more markedly increased. In fact, during the first half-hour, the six leaves had absorbed together more than 3 c.c. of oxygen. This rapid absorption of oxygen is still more striking when compared with the low rate of respiration previous to chloroforming. It is to be correlated with the change of colour to chocolate, due to the oxidation of substances of the nature of tannins under the influence of oxidases.

In both these experiments it is probable that much oxygen had already been absorbed in the chloroforming vessel. This applies especially to Experiment IV, where the fresh leaves would still have their stomata open, and so present little resistance to the inrush of oxygen, which is the probable explanation of the lower rate of absorption detected in this experiment. In both, the rate of absorption appeared already to be rapidly diminishing. This point was studied further in the case of *Helianthus*.

<sup>1</sup> If the first symptom appears locally, the rapid complete disorganization is similarly localized, and only spreads slowly to neighbouring parts of the leaf.

There is evidence, however, that starved leaves are more susceptible to the influence of chloroform, and this factor may have contributed to the greater absorption of  $O_2$  observed in Experiment V. Experiments with larger doses of chloroform have not been made using Cherry Laurel leaves; but in a few experiments with fresh leaves of Portugal Laurel, oxygen was absorbed more rapidly after bigger doses.<sup>1</sup>

When leaves of Cherry Laurel were treated with doses intermediate between 0.2 and 0.5 c.c. of liquid chloroform per litre of air, they were in part rapidly disorganized, but in part green; the results were therefore more complex, and need not be considered here as no new point arises from them.<sup>2</sup>

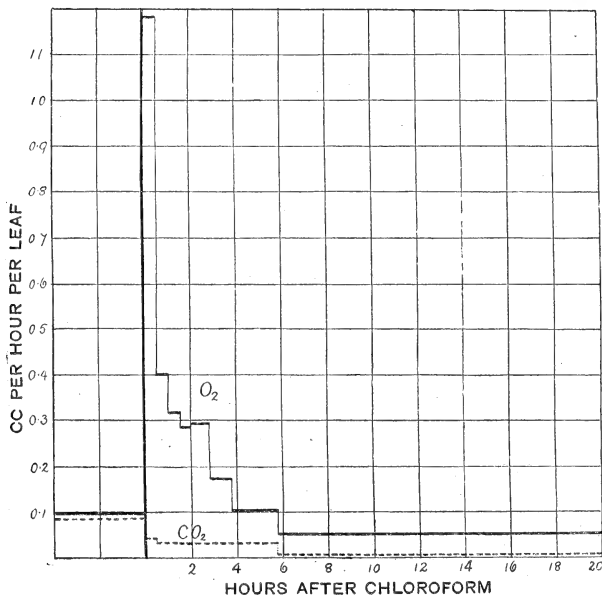

FIG. 6.

The experiments which have so far been described fall obviously into two classes, the first dealing with the gaseous exchanges during so-called 'stimulation', the second with the gaseous exchanges accompanying disorganization.

In experiments of the former class absorption of oxygen and production of  $CO_2$  are similarly affected, suggesting that they are still closely correlated.

In the latter class treatment with bigger doses of chloroform led to profound disorganization, accompanied by a rapid inrush of oxygen, and

<sup>1</sup> See also experiments with *Helianthus*. It is probable that such results represent the immediate fatal disorganization of a larger proportion of the cells of a leaf by bigger doses.

<sup>2</sup> Cf., however, p. 714.

a greatly diminished production of  $\text{CO}_2$ . Miss Irving's experiments, in which the  $\text{CO}_2$  production was determined from the first moment of the introduction of chloroform, show that the first effect here also is to increase the production of carbon dioxide; but the stimulation is of short duration. How the rate of absorption of oxygen is affected in this very transient initial phase has as yet not been determined, nor the course of the change from stimulation to the onset of irreversible changes: in my experiments these stages were passed through in the chloroforming vessel.

In order to determine whether the marked absorption of oxygen which accompanies disorganization in leaves of Cherry Laurel be a general phenomenon, similar experiments were made with other leaves. Some experiments with leaves of Portugal Laurel showing a similar inrush of oxygen have already been referred to. These leaves change at the same time to a very dark chocolate colour. Experiments were also made with leaves of *Helianthus tuberosus* and *Tropaeolum majus*.

EXPERIMENTS WITH HELIANTHUS TUBEROSUS.

In the leaves of *Helianthus tuberosus* disorganization is accompanied by a blackening of the leaf, and if the dose of chloroform is sufficiently large, by the exudation of water and marked flaccidity.

In the first two of the following experiments the dose was small and the leaves showed none of these signs of disorganization.

EXPERIMENT VI. August 24, 1910. Dose, 0.05 c.c. for ten minutes. Temperature, 17.6-19° C. Eight starved leaves weighing 12.6 grammes.

The leaves were respiring at a low rate, having been in the dark for

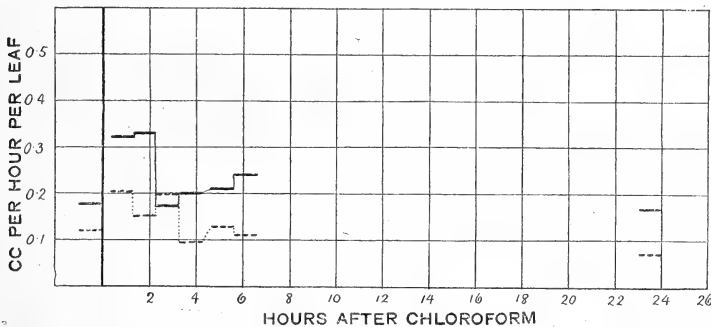

FIG. 7.

seven days. Here, as in the case of Cherry Laurel, a small dose of chloroform augmented the respiration, affecting both the production of  $\text{CO}_2$  and the absorption of oxygen. The respiratory quotient, however, appeared to be distinctly lower, the absorption of oxygen having been the more affected. Here, too, the maximum rates were attained at once, and the curves fell from the beginning, instead of rising to a later maximum as in Experiments

I and II with Cherry Laurel, which suggests that all the effects take place, or show themselves, much more rapidly in *Helianthus*, where stomata are present on both sides of the leaves and exchange of gases is normally rapid. A determination made after twenty-three hours showed a further slight fall in the rates; the  $\text{CO}_2$  output still bore a smaller proportion to the  $\text{O}_2$  intake than before chloroform. The leaves remained quite green to the end.

EXPERIMENT VII. July 7, 1911. Dose, 0.1 c.c. for five minutes. Temperature, 22.2–24.7° C. Five leaves weighing 7.5 grammes.

The leaves used had been gathered the day before and left in the dark for twenty hours. Immediately after treatment with chloroform they were

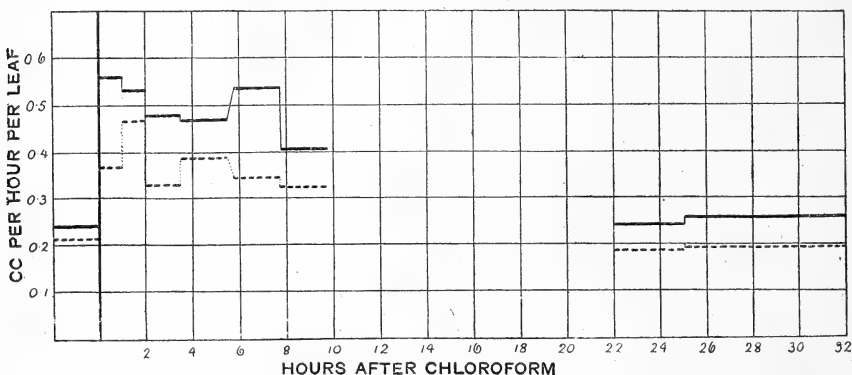

FIG. 8.

still turgid and green. After five and a half hours the leaf-chamber was opened and signs of a small amount of local disorganization were then visible. Twenty-two hours after chloroform respiration had fallen approximately to its original level, but disorganization was slowly spreading.

Stimulation was here relatively greater than in the previous experiment, in which the dose was only half as big, though applied for double the time. The absorption of oxygen was again affected more than the production of  $\text{CO}_2$ , and the respiratory quotient remained at the lower level.

In the following experiments disorganization had already begun when the leaves were enclosed in the respiration chamber.

EXPERIMENT VIII. August 25, 1910. Dose, 0.1 c.c. for ten minutes. Temperature, 17.4–18.2° C. Eight leaves freshly gathered, weighing 12.8 grammes.

When removed from the chloroforming vessel, the leaves had already begun to show signs of disorganization over the greater part of their surface. The first sample of air for analysis after chloroform was taken when the leaves had been enclosed for a quarter of an hour. Analysis gave as the composition of this sample 0.6%  $\text{CO}_2$  and 19.1%  $\text{O}_2$ . Thus in this short time the leaves had absorbed more than 2 cubic centimetres of oxygen

(the volume of the chamber being 150 c.c.). As shown in Fig. 9, a stimulation of the CO<sub>2</sub> output is also indicated, although the quantity concerned was small.

The very rapid absorption of oxygen only lasted a short time, then dropped to nearly the normal level and fell further slowly along with the

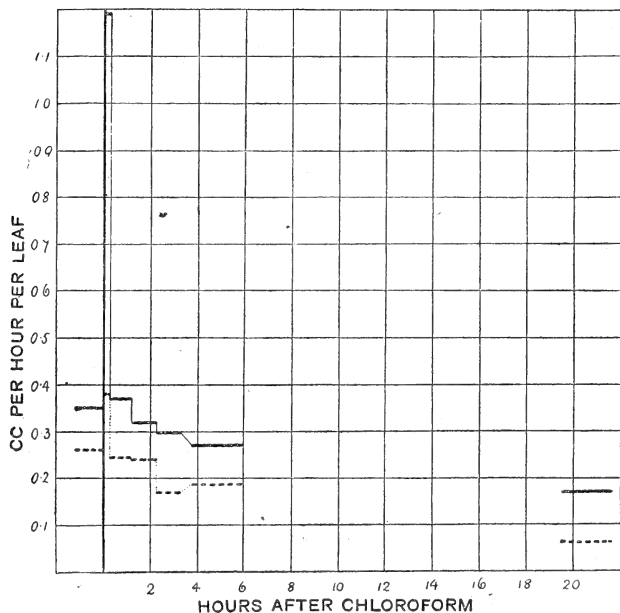

FIG. 9.

CO<sub>2</sub> output. After twenty hours both had fallen considerably, but the CO<sub>2</sub> output more than the O<sub>2</sub> intake, the respiratory quotient being 0.4.

EXPERIMENT IX. September 22, 1909. Dose, 0.1 c.c. for fifteen minutes. Temperature, 14.3-15.8° C. Six leaves in the dark for four days previously.

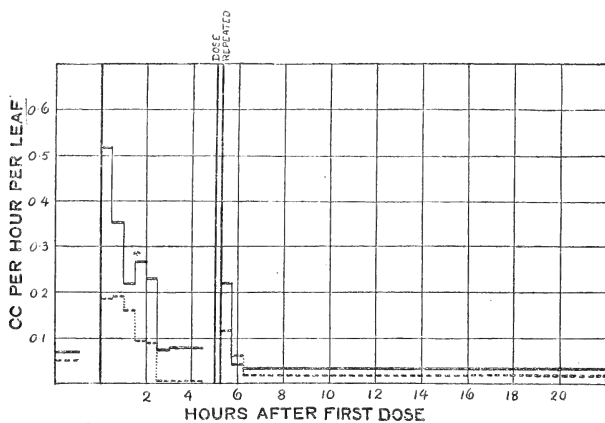

FIG. 10.

The rate of respiration before treatment with chloroform was low owing to starvation; the values given in the diagram are, however, rather too low, as they represent the average for nineteen hours.

As in Experiment VIII there was an immediate acceleration of the  $O_2$  intake, and at the same time a very unmistakable increase in the  $CO_2$  output. The latter fell off, however, to a very low rate by the fourth hour, the  $O_2$  intake falling meanwhile to near its previous level. Compared with the low  $CO_2$  output before chloroform, the relatively great increase after chloroform suggests comparison with the experiments with starved leaves of Cherry Laurel in which relatively great and persistent stimulation was shown.

After five hours the dose was repeated, and the results indicate a repetition on a small scale of the effects produced by the first dose. This may mean that cells hitherto but little affected were by the second dose strongly affected.

It is probable that only the outer cells are effectively exposed to the action of chloroform vapour unless its concentration is much greater, so that while the outer cells are killed, the inner remain alive. This would explain the fact that the leaves remained, as a whole, turgid. Microscopic examination of the distribution of the brown coloration supports this interpretation, as at first only the outermost layers of cells are affected.

On the other hand, repeated stimulation of a given cell is possible (cf. Expt. XII, with *Tropaeolum*, on p. 711), though it is uncertain whether the oxidation of tannin, once begun, can be further accelerated by exposing the cell a second time to chloroform.

EXPERIMENT X. August 19, 1910. Dose 0.3 c.c. for five minutes. Temperature 18.7–19.2° C. Eight leaves freshly gathered, weighing 9.2 grammes.

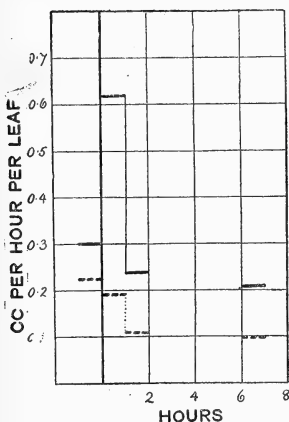

FIG. 11.

In this experiment a greater initial maximum rate of  $O_2$  intake (as in Experiment VIII) would have been revealed if a sample for analysis had been taken earlier than an hour after the leaves were enclosed. The total amount of oxygen absorbed was much greater than in Experiment VIII, where disorganization was initiated by treatment with a smaller dose of chloroform.

EXPERIMENT XI. August 27, 1910. Dose, 1.0 c.c. for five minutes. Temperature, 16–17° C. Leaves freshly gathered.

The first sample was taken after the leaves had been enclosed for seventeen minutes, and two others after further



intervals of an hour each. Here the result corresponded with that in Experiment VIII, since the very high rate of absorption of oxygen, the highest obtained, was confined to the first short interval. The results were as follows:

	<i>c.c. per hour per leaf.</i>	
	$CO_2$	$O_2$
After chloroform, 17 minutes	0.20	1.80
next 63    "	0.21	0.45
" 60    "	0.14	0.31

Doubtless the brevity and rapidity of the inrush of oxygen revealed in this experiment and in Experiment VIII always characterizes the absorption of oxygen which accompanies the beginning of disorganization in leaves of *Helianthus*: in the other experiments the first sample of air was not taken soon enough to show this feature so clearly.

Treatment of leaves of *Helianthus tuberosus* with chloroform to the point of disorganization resulted, therefore, in a marked absorption of oxygen very similar to that observed in the case of Cherry Laurel. Here, again, it was correlated with the change of colour due to oxidation of tannin. Small doses, too, evoked a temporary augmentation of both production of  $CO_2$  and absorption of oxygen.

It is clear, however, that chloroform penetrates the more delicate leaves of *Helianthus* much more readily than the better protected leathery leaves of Cherry Laurel. Whereas in the case of the latter a dose of 0.2 c.c. in the litre vessel usually left the leaves green for at any rate a long time, this was not always so in the case of *Helianthus*, even after a dose a quarter as big (0.05 c.c. per litre).<sup>1</sup> It is not unlikely, as a further consequence of this difference, that in some of the experiments with doses a little larger, especially where the leaves were exposed but for a short time to the chloroform vapour, most of it was absorbed by the outer layers of cells.<sup>2</sup> The results, some of which show stimulation of the  $CO_2$  output as well as the much accelerated  $O_2$  intake associated with disorganization, may therefore be complex, like those with Cherry Laurel, in which different parts of the leaves were differently affected.

The most striking feature of the results is the sharpness and relative brevity of the acceleration in the absorption of oxygen. It has already been remarked that the curve of  $O_2$  absorption in the case of leaves of Cherry Laurel exposed to a fatal dose falls very rapidly at first and slowly later. The same is more distinctly shown by the experiments with *Helianthus*, where a first short period of enhanced  $O_2$  absorption appears to be quite sharply distinguishable. This is illustrated in Fig. 12, in which the

<sup>1</sup> Cf. Weevers: Betrachtungen und Untersuchungen über die Nekrobiose und die letale Chloroformeinwirkung. *Recueil des travaux bot. néerland.*, ix, 1912, p. 255, &c.

<sup>2</sup> Weevers records the coloration of the epidermis alone in petals of *Magnolia*. *Loc. cit.*, p. 252.

total amount of oxygen that has been absorbed *per gramme* is plotted against the time as abscissa, the data being taken from two experiments in which freshly gathered leaves were exposed to the vapour of 0.1 and 0.3 c.c. respectively, for ten minutes. For comparison with these a third curve is added, from another experiment, in which treatment with 0.05 c.c. chloroform was followed by a typical stimulation effect. The broken lines represent the corresponding curves of total production of  $\text{CO}_2$ .

The contrast between the typical stimulation curves and those resulting from more drastic treatment is obvious. The former show no such sharp change in the rate of  $\text{O}_2$  absorption as is shown in the curves for the other two experiments. In those, the later parts of the oxygen curves are practically parallel, but at different levels corresponding to the different quantities of oxygen absorbed in the initial period. These quantities appear roughly proportional to the dose of chloroform received.

While the amount of oxygen absorbed is at first far greater than in the typical stimulation curve, the amount of  $\text{CO}_2$  produced is smaller, and the difference increases the more rapidly the bigger the dose.

With regard to the character of the augmentation produced by small doses, the respiratory quotient appeared to be less during stimulation than before treatment, even when the leaves remained fresh and green. The highest rate of respiration was observed as a rule within the first

hour after treatment with chloroform, and a steady fall from this initial maximum followed.

#### EXPERIMENTS WITH *TROPAEOLUM MAJUS*.

Leaves of *Tropaeolum majus* do not darken during disorganization, and the plant was chosen for this reason, as contrasting with the Laurels and *Helianthus*. The symptom most readily observed is flaccidity, accompanied by exudation of water into the air-spaces, and from the water-pores and the cut end of the stalk.

For each experiment the stalks were removed from sixteen small leaves, gathered usually a few minutes before use, and the laminae were

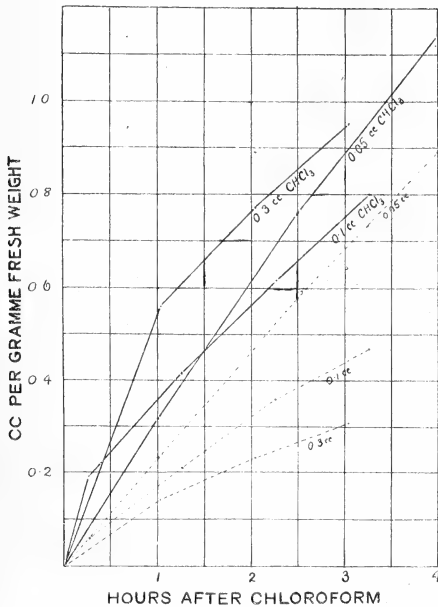

FIG. 12. Curves showing total  $\text{O}_2$  absorbed and  $\text{CO}_2$  produced after chloroform by leaves of *Helianthus tuberosus* in c.c. per gramme of fresh weight.

floated on water. They were then placed between a folded sheet of moistened paper, and so inserted into the leaf-chamber.

The first experiment is chosen as an example of the effect of a small dose of chloroform, insufficient to produce disorganization.

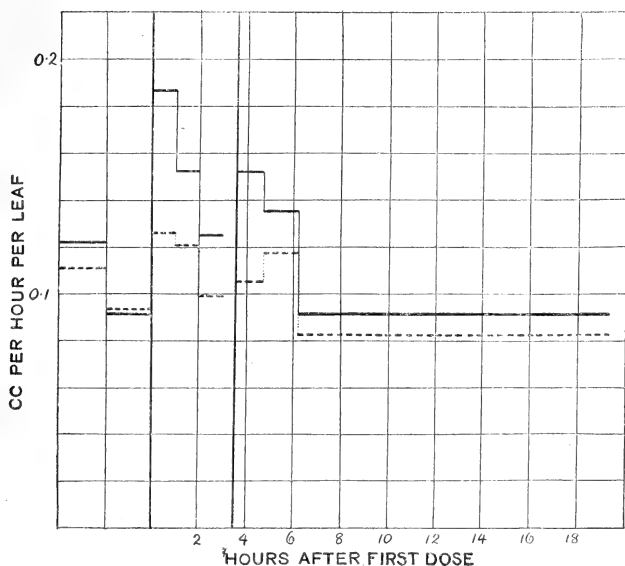

FIG. 13.

EXPERIMENT XII. September 24, 1909. Dose, 0.1 c.c. for ten minutes, repeated after three hours. Temperature, 16–17° C.

In this experiment the effect of the first dose of chloroform was a marked though relatively brief stimulation of both CO<sub>2</sub> output and O<sub>2</sub> intake, more especially of the latter (Fig. 13). The second dose produced a similar though rather smaller effect.

It is interesting to notice that the changes in the respiratory coefficient following the two doses are concordant, rising gradually from 0.7—after the first dose in three hours to 0.8, after the second reaching eventually 0.9. The same change was shown by other experiments.

The next two experiments are examples of cases in which the dose of chloroform was sufficient to produce disorganization.

EXPERIMENT XIII. October 15, 1909. Dose, 0.3 c.c., administered in six doses of 0.05 c.c. each at intervals of two and a half minutes; duration of exposure, fifteen minutes. Temperature, 15.7–17° C.

After chloroform the leaves were curled and rather flaccid, and their rate of respiration had greatly diminished; it fell still further to a very low level within six hours. In this case, however, unlike *Helianthus* and Cherry

Laurel, no inrush of oxygen accompanied disorganization; on the contrary, the  $O_2$  intake diminished more than the  $CO_2$  output, the ratio of the latter to the former rising to 2.0. Similar results were obtained in other experiments in which a similar dose of chloroform was employed.

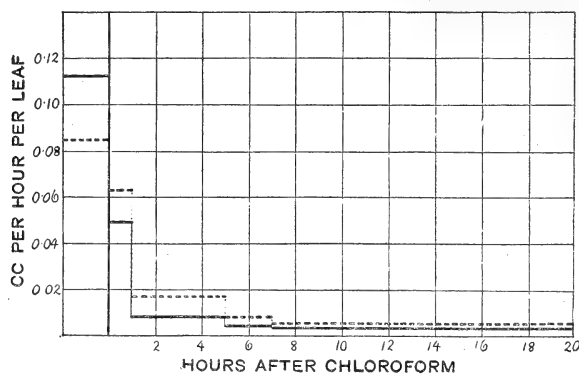

FIG. 14.

EXPERIMENT XIV. September 28, 1909. Dose, 0.5 c.c. or ten minutes. Temperature, 14–15° C.

Here for the first three hours after chloroform, the  $O_2$  intake remained greater than the  $CO_2$  output (Fig. 15), but this may be connected with the abnormally low respiratory coefficient during the hour preceding exposure

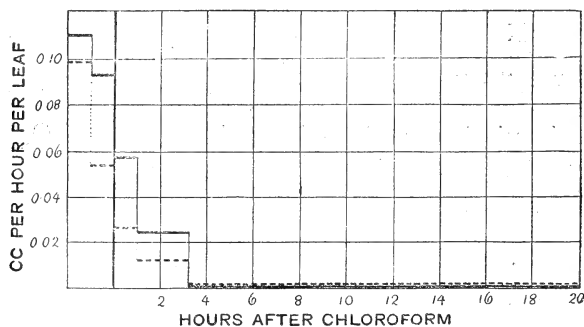

FIG. 15.

to chloroform. The depression after this large dose continued to a level still lower than in the previous experiments, and again the residual  $O_2$  was less than the  $CO_2$  output.

Thus in the leaves of *Tropaeolum*, which contain no tannin, the absorption of oxygen is affected by strong doses as well as weak in a similar way to the production of  $CO_2$ , and there is no such marked absorption of oxygen after strong doses as occurs in the other kinds of leaves.

The temporary augmentation of the respiration produced by small

doses was like that produced in the other leaves. As in the case of *Helianthus* the absorption of oxygen was more affected than the production of CO<sub>2</sub>; when the dose was big enough to cause a marked stimulation, the respiratory quotient fell from about 0.9 before exposure to 0.7 after chloroform; but after a few hours the original ratio was reached again. Also, as in the case of *Helianthus*, the maximum rates were observed in most experiments in the first hour, the rates then falling quickly to the normal level. A repetition of the same dose after three hours produced a second stimulation, the maxima being, however, rather less than after the first dose.

After exposure to doses of 0.2 c.c. or more no stimulatory effect was detected; but both CO<sub>2</sub> production and O<sub>2</sub> absorption diminished rapidly to a low level. Here again the absorption of oxygen was the more affected, and its rate fell below the rate of production of CO<sub>2</sub>, the ratio  $\frac{\text{CO}_2}{\text{O}_2}$  rising much above unity, instead of falling far below unity as it did in the other leaves.

It is to be noticed that *Tropaeolum* lies midway between Cherry Laurel and *Helianthus* in the degree of susceptibility, or (more probably) penetrability, of its leaves to chloroform vapour. The stimulation produced by ten minutes' exposure to 0.1 c.c. chloroform per litre is similar to that after a dose of 0.05 c.c. for ten minutes in the case of *Helianthus*, and 0.2 c.c. for twenty minutes in the case of Cherry Laurel. Gaseous exchanges take place normally less rapidly in *Tropaeolum* than in *Helianthus*, and the distribution and character of the stomata (including, for instance, their very ready tendency to close) may in part account for the less rapid penetration of chloroform. It is probable, however, that the wax which covers the surface of the leaf takes up the chloroform and protects the epidermal cells from being affected so soon as in leaves of *Helianthus*, where they have neither the waxy covering of *Tropaeolum* nor the thick cuticle of Cherry Laurel.<sup>1</sup>

#### DISCUSSION.

The fact which stands out most prominently in the foregoing experiments is the large absorption of oxygen which accompanies the disorganization of leaves of Cherry Laurel, Portugal Laurel, and *Helianthus* exposed to chloroform vapour in sufficient concentration. This result was only observed when visible signs of disorganization appeared, and only when one of these signs was the appearance of a brown or black coloration; in leaves of *Tropaeolum* which do not show any such marked change of colour during

<sup>1</sup> Weevers (loc. cit., p. 255) attributes the differences which he observed in the minimum time of exposure that was followed by fatal results in great part to differences of water content. This view will clearly not explain the different behaviour of leaves of *Helianthus* and *Tropaeolum*.

disorganization, the rate of absorption of oxygen was, on the contrary, greatly depressed. This change of colour is attributed to the oxidation of substances of the nature of tannins,<sup>1</sup> present in the Laurels and *Helianthus*, but not in *Tropaeolum*, owing to the activity of oxidases which follows as a result of the fatal influence of the chloroform. As is already well known, the breaking down of the organization of the leaf-cells of the Cherry Laurel is also followed by the production of hydrocyanic acid, owing to the hydrolysis of the cyanogenetic glucoside prulaurasin by an emulsin.<sup>2</sup>

The other fact of general importance is that during the temporary augmentation, or stimulation, of the respiration which follows less drastic treatment in all the leaves studied, the absorption of oxygen and production of CO<sub>2</sub> apparently still remain co-ordinated. The ratio between the quantities of oxygen and CO<sub>2</sub> concurrently absorbed and evolved shows indeed small changes; but such changes were not always observed, and they appear to differ in different kinds of leaves, though within the same kind some degree of concordance is shown.

A very interesting point is suggested by the character of the stimulation curves obtained in most of those experiments in which the leaves had previously been starved in the dark. These curves indicate a relatively greater and much more prolonged augmentation of the respiration, in comparison with the low rate of respiration characteristic of their starved condition. The same effect was not, however, obtained in all the experiments, and further investigation is necessary before a discussion of its significance and the conditions on which it depends would be profitable.

The transition from stimulation, with the production of CO<sub>2</sub> and absorption of oxygen still closely correlated, to disorganization and the complete breakdown of this correlation would appear to be sharply marked; for not only is the difference between doses which merely stimulate and doses which initiate disorganization very small, but intermediate doses may initiate disorganization in one part of a leaf and not in another, this part remaining green for a long time. It is interesting that even in leaves of Cherry Laurel disorganization only slowly spreads to parts which have been left green, notwithstanding the evolution of prussic acid from the disorganized areas.<sup>3</sup>

<sup>1</sup> In the case of *Aucuba*, the blackening of the leaves is said to be independent of oxygen. See Maquenne and Demoussy, Comptes rend., cxlix, 1909, p. 957.

<sup>2</sup> According to Weevers (loc. cit., p. 254) the HCN is detected, even by its odour, later than the beginning of the brown coloration, as it has first to diffuse out of the leaf.

<sup>3</sup> Weevers has found that the darkening of leaves may only begin some time after exposure to chloroform. He supposes (loc. cit., p. 261) that where this happens death has already taken place during exposure. The other alternative would appear, however, to be conceivable: even if, as Weevers holds, necrobiosis and stimulation be sharply distinct from each other, necrobiosis might still be preceded by stimulation and, in cases of deferred coloration, set in after exposure, not as a direct effect of the chloroform but through excessive stimulation of the normal respiratory processes. Prolonged starvation alone leads eventually to increase of permeability and necrobiosis.

Miss Irving, who determined the rate of production of  $\text{CO}_2$  from the first moment of exposure, has shown that the first effect, even of large concentrations of vapour, is to stimulate the production of  $\text{CO}_2$ ; this effect becomes more intense and more shortlived the more the dose is increased, until it may be described as a transient outburst of  $\text{CO}_2$ . In my experiments this brief stimulation was seldom observed, as it took place in the chloroforming vessel before the measurement of the gaseous exchange could be begun. When a detailed collation is attempted, however, it appears probable that the intensity and duration of the augmented output of  $\text{CO}_2$  shown in Miss Irving's experiments, depends in some degree upon the continuance of the exposure to chloroform vapour. This is well brought out if Miss Irving's Experiment XIII<sup>1</sup> and my Experiment IV<sup>2</sup> are compared. In her experiment leaves of Cherry Laurel were exposed continuously to the vapour of 0.63 c.c. of chloroform per litre of air; in mine, similar leaves were exposed for twenty minutes to the vapour of 0.5 c.c. per litre. The dose was rather smaller in my experiment, yet whereas in it the production of  $\text{CO}_2$  was far below normal from the first (i. e. from less than half an hour after the first moment of exposure, onwards), in Miss Irving's experiment it was increased nearly threefold, and was still above normal in the fourth hour, though rapidly diminishing. Only with much larger doses was the outburst over in half an hour under continued exposure to chloroform. It seems improbable that the difference of temperature ( $18.5^\circ$  in mine, and  $25^\circ$  in Miss Irving's) could account for such a difference, and the inference is suggested that this exaggerated production of  $\text{CO}_2$  only lasts so long as the leaf remains exposed to chloroform vapour, or dies away with great rapidity as soon as no more chloroform is administered.

When, on the other hand, the concentration of chloroform is low, the smaller acceleration then produced dies away more slowly after exposure to chloroform ceases: this more persistent stimulation appears, therefore, also as an after effect. Here again, however, if exposure is repeated, a similar stimulation is again produced, as in Experiment XII with *Tropaeolum*; <sup>3</sup> while continuous exposure intensifies and prolongs the stimulation, or may lead to disorganization.

There are many points which still require elucidation. One of the most interesting is the relation between the respiratory exchanges and changes of permeability. Lepeschkin<sup>4</sup> showed that the exudation of water from the sporangiophore of *Pilobolus* can be diminished by a small dose of chloroform gradually applied, indicating a decrease of permeability, whereas a large dose increased the permeability. Recently Osterhout<sup>5</sup> has found that 1 per cent. ether or 0.05 per cent. chloroform in sea-water pro-

<sup>1</sup> Loc. cit., p. 1089, Fig. 15.

<sup>2</sup> p. 703.

<sup>3</sup> p. 711.

<sup>4</sup> Beihefte z. Bot. Centralbl., xix, Abt. I, 1906, pp. 416-17.

<sup>5</sup> Science, N. S., xxxvii, 1913, p. 111.

duces a reversible increase of the resistance of the living thallus of *Laminaria* to the passage of ions in an electric current; whereas three times the concentration of anaesthetic produces a brief reversible increase of resistance followed by a progressive decrease which is irreversible, and always ends in the thallus becoming as good a conductor as the sea-water itself, i. e. completely permeable.

The increase of permeability shown by the exudation of fluid in leaves exposed to chloroform vapour has been recorded by Miss Irving and others, and already remarked on here; it is especially obvious in leaves of *Tropaeolum*. Miss Irving<sup>1</sup> observed the exudation of water and flaccidity in Barley leaves, in experiments in which the respiration did not indicate fatal disorganization, and it must still be held an open question whether a slight increase of permeability is always irreversible, as might be inferred from Osterhout's experiments. According to Lepeschkin the increased exudation of water which follows a moderate dose of chloroform, due to an increase of permeability, only lasts for a time when the chloroform is removed.

In leaves the evidence seems to point to the possibility of recovery so long as visible disorganization has not begun, even though some increase of permeability has resulted. Whether the recovery is complete is, however, another question. There is evidence that starvation is hastened; but this might be due merely to the depletion of reserves during stimulation. Müller-Thurgau and Schneider-Orelli<sup>2</sup> conclude, on the other hand, that etherized potatoes are prematurely aged, in the sense that the balance between starch formation and dissolution is altered in the same direction as during the normal ageing process which precedes sprouting, the concentration of sugar in the sap increasing.

Another important question is the nature of the augmentation of the respiratory exchanges spoken of as stimulation. H. E. and E. F. Armstrong have shown that after drastic treatment with chloroform leaves of Cherry Laurel contain more sugar; but this may be a degenerative change, due perhaps to hydrolysis of the glucoside, and associated with disorganization. It is true that where a distinct change in the respiratory quotient was observed in leaves of Cherry Laurel, it was an increase to approximately unity. On the other hand, the decrease in the respiratory quotient observed in leaves of *Helianthus* and *Tropaeolum* during stimulation suggests a temporary change in the nature of the respiratory material of quite a different kind. The data are not yet sufficiently numerous to allow of generalization.

<sup>1</sup> Loc. cit., p. 1079.

<sup>2</sup> Loc. cit., pp. 368-9. See also review in *New Phytologist*, ix, 1910, p. 337.



SUMMARY.

In conclusion, the following facts appear to be established :

1. In all the leaves examined, treatment with a small dose of chloroform results in stimulation of the respiration, the absorption of oxygen and production of  $\text{CO}_2$  increasing in like proportion, and therefore probably remaining co-ordinated.

In starved leaves the effect of stimulation was usually prolonged.

2. When the concentration of chloroform vapour was large enough to initiate visible disorganization, the production of  $\text{CO}_2$  after treatment was always diminished, the outburst of  $\text{CO}_2$  demonstrated by Miss Irving having already occurred, and it quickly fell to a very low level. At the same time the absorption of oxygen was no longer closely correlated with the production of  $\text{CO}_2$ .

In leaves of *Tropaeolum*, which contain no tannin, the absorption of oxygen was depressed still more than the production of  $\text{CO}_2$ .

On the contrary, in leaves of Cherry (and Portugal) Laurel, and *Helianthus*, which contain tannins, the oxidation of which imparts a brown or black colour to the disorganized leaves, the absorption of oxygen was very rapid for a short time, and, though quickly falling, remained at a much higher level than the production of  $\text{CO}_2$ .



# On the Value of Different Degrees of Centrifugal Force as Geotropic Stimuli.

BY

W. E. HILEY, M.A.

(*Demonstrator in Botany in the University of Oxford*).

With Plates LVII and LVIII and three Figures in the Text.

HISTORICAL.

THE first plant physiologist to use a centrifugal wheel was Knight (1806). He connected wheels rotating in horizontal and vertical planes with an improvised water-wheel in his garden; and the water served both to drive the wheel and to keep the seedlings moist with incessant spray. Knight worked with seedlings of the 'garden bean', and he found that when they were growing on a wheel with a horizontal axis the radicles all turned outwards and the 'germens' inwards, i. e. towards the axis. But when placed on a wheel which turned about a vertical axis the position taken up by the plant-members was dependent on the rate of rotation of the wheel. When the centrifugal force was about equal to gravity the radicles bent downwards and outwards at an angle of  $45^\circ$ ; and as the force was increased the radicles grew nearer and nearer to the horizontal. Knight described his chief discovery as follows: 'I conceive myself to have fully proved that the radicles of germinating seeds are made to descend and their germens to ascend by some external cause; and not by any power inherent in vegetable life: and I see little reason to doubt that gravitation is the principal, if not the only agent employed, in this case, by nature.' He then proceeded to propound an ingenuously mechanistic theory to account for the facts.

But Knight also discovered another very important fact, viz. that gravity as a geotropic stimulus could be replaced by centrifugal force. This discovery is of extreme value because it enables the investigator to substitute a stimulus which can be varied at will for one which is necessarily fixed.

Wigand ('54) carried out a series of experiments with a centrifugal wheel, placing seedlings along a radius at different distances from the centre (3" to 7"), with the wheel rotating at various rates (75 to 288 revolutions per min.); he found a marked disparity between the direction assumed by the radicles and the calculated direction of the resultant. There was in one case as great an angle as  $38^\circ$  between the two directions, but this and

similar discrepancies were probably due to unhealthy conditions of growth or to unintentional stimulation previous to rotation on the wheel. Wigand succeeded in making radicles grow nearly horizontally on a wheel, with a vertical axis, rotating at high speed. It may be mentioned here that Giltay ('10) undertook to show that radicles did actually take up the position of the resultant of centrifugal force and gravity when growing on a horizontal centrifugal wheel, for Wigand's results had never been experimentally improved upon. As a result of 368 tests, Giltay found them fall  $2.1^\circ$  below the calculated direction of the resultant; this inaccuracy is slight enough to be accounted for by variations in the speed of rotation.

Sachs ('74) worked on the effect of centrifugal force on secondary roots; he showed that if the radicle of a bean be amputated below the part where secondary roots have been given off, then these secondary roots respond positively to the force.

Elfving ('80) rotated vertically placed radicles on a horizontal wheel so that the radicles bent outwards at an angle to the vertical; and the greater the centrifugal force, the greater was this angle of inclination.

Schwarz ('81) showed that sporangiophores of *Mucor* are responsive to centrifugal force and bend towards the centre of rotation.

Czapek ('95) was the first to attempt to work out the relation between the speed or magnitude of response and the magnitude of the force. His method was to determine the reaction time (Latenzzeit) of radicles stimulated by centrifugal forces of different magnitudes. He experimented on radicles of *Vicia Faba* and *Lupinus albus* (which gave results identical with each other), subjected to forces varying from 0.0005 mg. to 38 mg. To the former stimulus no reaction was visible after eight hours. Reaction to 0.001 mg. took place in six hours and the reaction time gradually diminished to  $\frac{3}{4}$  hour for 35 to 38 mg.

From this time forward the literature of Geotropism is dominated by the conception of 'presentation time', i. e. the shortest period of exposure to a stimulus that will produce a noticeable after-effect when the object is placed after stimulation either in its normal position or on a horizontal clinostat. This presentation time is a critical time which can be determined experimentally for different plant-members under different experimental conditions, and can be used as a test for sensitiveness of the object worked upon. The conception was first introduced by Czapek ('98), and was further employed by Haberlandt ('03), Fitting ('05), Bach ('07), and many more recent authors. The actual length of this presentation time has tended to diminish markedly, with more exact investigation, even as determined for the same plant-member under similar tonic conditions. Thus, for the hypocotyl of *Helianthus annuus*: Czapek determined it at 20 min., Fitting at 5 to 6 min., Bach at less than 3 min. Still more recent authors, Polowzow ('09), Tröndle ('13), &c., have declared that with

a microscope actual response to the gravitational stimulus can be observed 1 min. or even  $\frac{1}{2}$  min. after the commencement of stimulation, and that in reality not only presentation time but also reaction time tend to vanish altogether. In that case presentation time comes to mean the least length of exposure to stimulus which will produce a bend *visible to the naked eye*, and is then of comparatively little value.

Bach ('07) and Pekelharing ('09) have worked out the relationship of presentation time to different angles of displacement and different centrifugal forces, and have shown that it varies inversely as the intensity of the stimulus acting at right angles to the parallelotropic organ.

Others have tried to determine the relation of presentation time to tonic conditions. Thus Bach ('07) and Rütgers ('10) have worked at different temperatures; and the latter author comes to the conclusion that presentation time varies with temperature according to Van't Hoff's law for chemical changes, i. e. for each rise of  $10^{\circ}$  C. in the temperature the presentation time is reduced  $\frac{1}{2}$  of its length, though this of course can only hold for the limits of temperature within which the seedlings can grow comfortably (i. e. within which other physiological activities are not wholly or partially inhibited). Thus Bach's and Pekelharing's results point to a physical basis for presentation time, whereas Rütgers's point to a chemical basis. The attempt at reconciliation of the two conceptions provides ground for speculation.

Árpád Páal ('11) showed that presentation time varied with artificial changes in the atmospheric pressure.

Buder ('08) tried to accommodate the statolith theory to Bach's figures for presentation time in relation to centrifugal force. His object was to show that when the seedlings of *Vicia Faba* and *Ricinus* were turned over, the movable starch-grains in the endodermis of the hypocotyl took just such a time to settle as Bach had worked out to be the presentation time. The presentation time might thus be nothing more or less than the time taken by the starch-grains to settle on the bottom of the statocyte. Also this time would vary inversely as the centrifugal force to which the seedlings were subjected. This theory is very ingenious and would seem to explain the tables obtained by Bach and Pekelharing for the relationship of presentation time to centrifugal forces and angles of displacement. But according to this theory the presentation time must be dependent purely on the specific gravity of the starch-grains and the viscosity of the cell-sap. Thus the relation between presentation time and temperature should be dependent on the relation between viscosity and temperature. But this relationship has been found for water to be approximately as follows:

$$\text{viscosity coeff.} = \frac{0.017941}{(1 + 0.023120t)^{1.5423}}$$

where  $t$  is the temperature in degrees Centigrade.<sup>1</sup> This means that the viscosity coeff. will be at 80° C. a third of what it is at 10° C., a result which is not at all in keeping with Rütgers's observations of presentation time. Also Heilbronn ('12) has shown that the movable starch-grains do not fall quite freely, but seem to be partially controlled by the streaming protoplasm.

But quite independently of presentation time, another method of investigating the effect of different degrees of stimulation has been employed. This is the method of neutralization of the effects produced by the alternation of opposing stimuli. It was employed independently by Fitting ('05), Newcombe ('05), and Hayes ('05).

The results which Fitting ('05) obtained with his intermittent clinostat are now well known. He was able, through the invention of an extension to Pfeffer's clinostat, to alternate the position of plant-members between two directions at different angles with the vertical; and by this means he was able to compare geotropic effects of various kinds in the two positions. We are here chiefly concerned with one aspect of the work; indeed the fundamental part on which all the other portions of this piece of research may be seen to be dependent.

A plant-member, say a hypocotyl, is made to rest in the position  $K$ , i. e. horizontal, with the side  $A$  uppermost and the side  $B$  lowermost. It rests so for a time  $t$ . Then by a rapid half-rotation of the clinostat axis the hypocotyl is made to assume the position  $L$ , at an angle  $\theta$  below the horizontal and now with the side  $B$  uppermost and  $A$  lowermost. Here it remains for a period  $t'$ , after which the clinostat axis completes the revolution bringing the

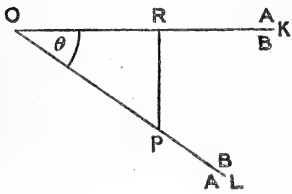

hypocotyl back to its former position. The regular alternation of times  $t$  and  $t'$  respectively in the two positions is maintained as long as desired.

When the hypocotyl lies in position  $K$  it tends to bend upwards, i. e. towards  $A$ ; when it has taken up the position  $L$  it still tends to bend upwards, but now towards  $B$ . So the tendencies in the two positions are opposed, and a kind of 'tug-of-war' is set up. Which tendency (i. e. to turn towards  $A$  or  $B$ ) will overcome the other depends on the angle  $\theta$  and the relative lengths of the times  $t$  and  $t'$ . Fitting found that the two tendencies would exactly neutralize each other (i. e. the hypocotyl would grow straight)

when  $\frac{t}{t'} = \cos \theta$ ,<sup>2</sup> a result which may be expressed geometrically as follows:

<sup>1</sup> Thompson and Pointing: Properties of Matter.

<sup>2</sup> Fitting expressed his results in terms of the angle between  $OL$  and the vertical. If we call

If from  $P$  (Fig. 1), any point on  $OL$ ,  $PR$  is drawn at right angles to  $OK$ , then  $\frac{t}{t'} = \frac{OR}{OP}$ .

This result may also be expressed in another way. The gravitational stimulus acting at right angles to the hypocotyl in the position  $K$  is  $mg$ , but in the position  $L$  it is  $mg \cos \theta$ . So that if  $S$  stands for the stimulating force at right angles to the position  $K$  and  $S'$ , that at right angles to the position  $L$ , we have

$$\frac{S'}{S} = \cos \theta$$

$$\therefore \frac{t}{t'} = \frac{S'}{S}$$

Thus, for the two bending tendencies to neutralize each other, the times must be inversely proportional to the stimulating forces which act at right angles to the member in the two positions. The result may also be expressed as follows:

$$St = S't',$$

i. e. the product of the stimulating force and its time of action is the same in each direction.

Now it seemed desirable to apply this principle to the case of centrifugal forces. This could be done if we could alternate the stimulus of gravity  $mg$  acting for a time  $t$  in one direction with a centrifugal force  $C$  acting for a time  $t'$  in the opposite direction, each acting at right angles to the plant-member in question. Should we find that when the times were so arranged that the member in question did not bend in either direction, then  $mgt = Ct'$ ? This is the question which the present research sets out to answer.

#### Note on the Use of the Term 'Centrifugal Force'.

This term has come into general usage in botanical literature to express the geotropic stimulus obtained on a centrifugal wheel, but as the expression is of doubtful accuracy, we may with advantage carefully consider to what extent the geotropic conditions of stimulus on a centrifugal wheel resemble those under the stimulus of gravity acting on a horizontal plant-member.

The stimulus of gravity may be regarded as follows. If a radicle were free to fall indefinitely without any retarding or accelerating force besides gravity, no geotropic stimulus would act upon it. Just as a man in a lift which, by some accident, fell without restraint, would not be at all conscious of gravity until he reached the limit of the fall, so a plant under similar circumstances would not perceive any gravitational stimulus. The geotropic

this  $\alpha$ , then  $\alpha = 90^\circ - \theta$ , therefore  $\cos \theta = \sin \alpha$  and the equation may be written  $\frac{t}{t'} = \sin \alpha$ . This has been called the 'sine law'.

stimulus arises because the plant is *held* and prevented from falling. This outlook may be expressed in terms of any theory of geotropic perception that may be held; thus, on the basis of the statolith theory, when a root is held horizontally the starch-grains fall to the lower side of each statocyte; but if, when the geotropic member was placed horizontally, the whole was allowed to fall indefinitely, the starch-grains would not reach the lower side of the statocyte, because they would not fall *faster* than the statocyte as a whole.

Now gravity 'g' is an *acceleration* of 32 feet or 981 cm. per sec. per sec., and this acceleration acts on all parts of a horizontal radicle. *The geotropic stimulus is caused by the radicle being prevented from falling.* If there were no gravity, the same effect could be produced on the radicle by moving it *upwards* with an acceleration of 981 cm. per sec. per sec. Movable starch-grains would then fall to the lower side of each statocyte and press upon it just as they do normally under the influence of gravity. Thus the radicles would tend to bend in a direction *opposite* to that of the acceleration.

Now on the centrifugal wheel a plant-member is always tending to fly off at a tangent, but is prevented from so doing by being held at a constant distance from the centre of rotation. In this way it is subjected to a *centripetal acceleration*, and it is this which causes the roots to bend *centrifugally*, i. e. in the direction opposite to that of the acceleration. Thus the so-called 'centrifugal force' might more properly be expressed in terms of this centripetal acceleration.

On the other hand, when we come to consider any sense-organ, the term 'centrifugal force' acquires a new meaning. Thus, in terms of the statolith theory, on the centrifuge the starch-grains move to the outer side and actually do exert a centrifugal force on the outer walls of the statocyte.

In this sense the term 'centrifugal force' may be used in a general way without violence to scientific accuracy. Such an expression as 'a centrifugal force of 10 mg.', when occurring in this paper, may best be interpreted in terms of such a sense-organ. Thus, with the statolith theory, it expresses the force exerted on the outer wall of a statocyte by statoliths whose mass is  $m$ . Since, by any theory of gravi-perception, sensitiveness to the direction of gravity must presumably be due to the weight of some heavy body or substance, we may speak of centrifugal force (e. g. 10 mg.) and not only centrifugal acceleration (e. g. 10 g.), realizing that the force is exerted by the heavy body of mass  $m$  on the sensitive protoplasm.

To prove the formula  $mg\ell = C\ell'$  it was necessary first to construct a machine which would automatically provide the desired alternation of gravity and centrifugal force acting in opposite directions,



Description of the Intermittent Centrifuge.<sup>1</sup>

The centrifuge itself is composed of a rod *RR* (Text-fig. 1), with a rider *S* carrying the growing-box *B*. The rod is a hollow brass cylindrical tube, 100 cm. long and 1.9 cm. in diameter. It is fixed by its middle to the axis *A*. The axis of rotation is vertical and the rod horizontal, so that the

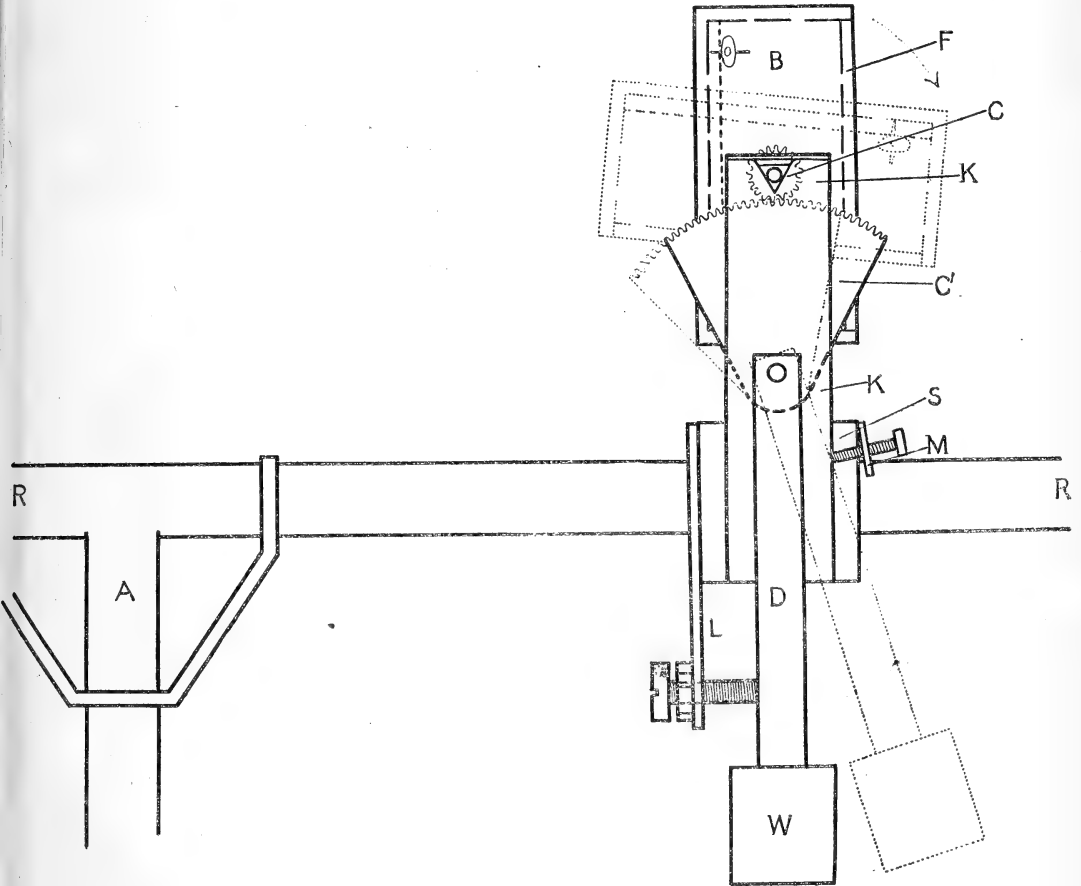

TEXT-FIG. 1.

centrifugal force is always exerted in the horizontal plane. The rider *S* is composed of an oak block 4 cm. broad, 4 cm. high, and 17 cm. long. The rod *RR* passes through a central hole and the rider is clamped by a butterfly screw as shown in Text-fig. 2, *BS*. At each end of the oak rider is a brass upright (*KK'*, Text-figs. 1 and 2), with a small **V** cut out at the top.

The box which contains the seeds is made of cedar wood and is of dimensions 11.5 x 9 x 4 cm. A glass window is let into the hinged cover

<sup>1</sup> The instrument was constructed by Mr. S. W. Bush of the Electrical Laboratory in Oxford.

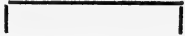
(*F*, Text-fig. 1). The back of the box is lined with sheet cork, to which the seeds can be pinned. The box is strengthened by a brass strip 1.8 cm. broad, which is bent into the form  clasping the box on the back and at each side. To each of the shorter arms of this strip is attached a steel axis (*AA*, Text-fig. 2), which fits into the above-mentioned **V**s in the uprights *KK'*. The axis is prevented from rising out of the **V**s by a hinged cross rod which fits above the gap, thus **V**. The whole box is thus free to rotate on the axis *AA*.

About the axis *AA* near one end is fitted a cog-wheel *C*, which is 0.65 cm. in radius to the 'clutch' of the cogs, and has eighteen cogs. Fitting into this is another cog-wheel *C'* (Text-figs. 1 and 2), which turns about a second axis *A<sub>1</sub>A<sub>1</sub>*. This cog-wheel is 4.7 cm. in radius, and only the upper part is cogged, having twenty-seven cogs. To the axis *A<sub>1</sub>A<sub>1</sub>* is firmly fixed a bar *D*, which hangs vertically downwards and bears a lead weight *W* at the bottom. Thus, as the weight *W* is swung backwards and forwards, the box *B* rotates about the axis *AA* and in the opposite direction from the weight.

Fixed to the rider *S* are two brass bars *L*, *M*, one on each side; and through them are screwed bolts which limit the swing of the bar *D* in the two directions. When the weight *W* is hanging vertically, the bar rests against the bolt on *L*, and the bolt on *M* prevents the weight from swinging outwards beyond a certain point. Now when the bar *RR* is still, the weight *W* hangs vertically and the box *B* is upright, as shown in the black line drawing in Text-fig. 1. But when the rod *RR* is rotating a centrifugal force acts on the weight *W*, causing it to swing outwards until the bar *D* is pressed firmly against the bolt on *M*. This causes the cog-wheel *C'* to rotate through a small angle, which in its turn reacts on the cog-wheel *C*, which is attached to the box. The weight *W*, the bar *D*, the cog-wheels *C* and *C'*, and the box *B* have now taken up the positions shown by the dotted lines in Text-fig. 1. The actual angle which the back of the box makes with the vertical can be altered at will by adjusting the bolt on *M*, which determines the limit of swing of the bar *D*. The position which the box is allowed to take during experiments is arranged so that the back will lie along the line of the resultant of the centrifugal force acting horizontally and gravity acting vertically.

When, however, the rod *RR* ceases to rotate and comes to rest, the centrifugal force no longer acts on *W*, so that the bar *D* sinks back to the black-line position and the box above becomes vertical. Thus the box *B* has two fixed positions: vertical when the rod *RR* is still, and in the line of resultant of the centrifugal force and gravity when the rod is rotating. For the accurate measurement of the angle which the box makes with the vertical in the second position a protractor is fixed to the end of the box *P* (Text-fig. 2, not shown in Text-fig. 1), and by means of the pointer, *p*, the

angle in question can be read off. Before performing an experiment the centrifugal force is theoretically calculated, and the appropriate angle for the second position is obtained by screwing the bolt in *M*, till the bar *D* swings to the right extent.

Fig. 4, Pl. LVII, shows the 'wheel' entire. It is propelled by a  $\frac{1}{16}$  h. p. electric motor which rotates at about 4,000 revolutions per min. By means

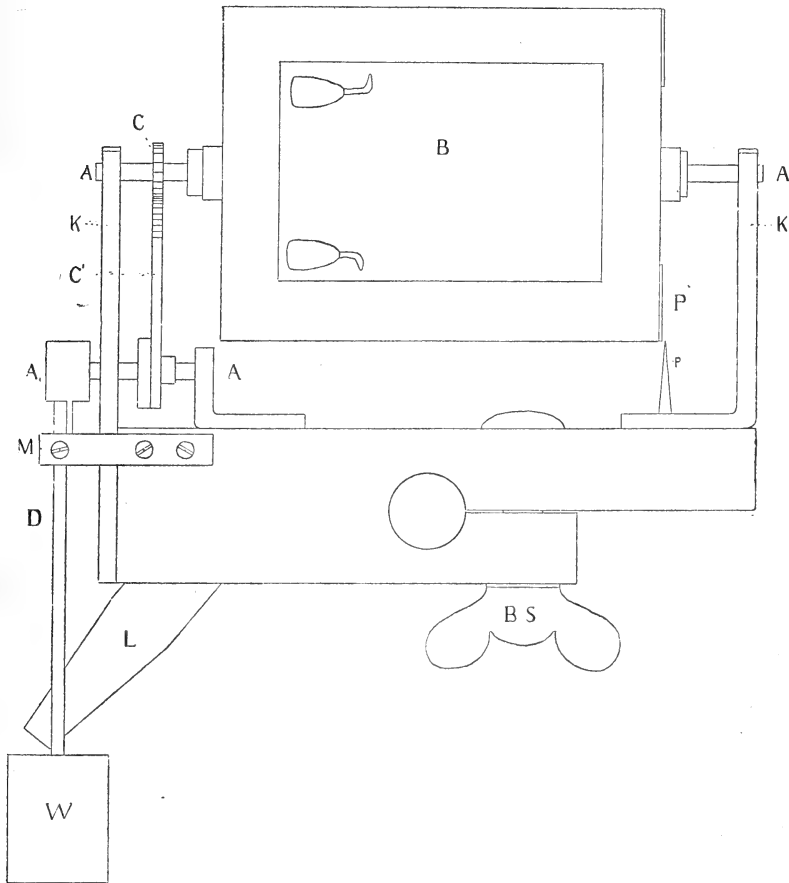

TEXT-FIG. 2.

of two pulleys the rotation of the wheel itself is geared down to about 200 per min. The actual number of rotations made by the 'wheel' is indicated by the rotation recorder, shown below the central pulleys.

The intermittent apparatus is diagrammatically shown in Text-fig. 3. To the minute axis of a clock *C* is fixed a pulley round which is wound about three yards of angler's twine. The free end of the twine is passed round one of the pulleys at *D* and then round the fixed pulleys  $p_1 p_2$ , eventually round the free pulley  $p_3$  (to which a weight *W* is attached), ending up at the

hook *K*, to which it is fixed. Now as the clock pulley rotates, the twine is gradually set free and the weight *W* slowly falls, keeping the twine tight, and while this is proceeding the pulley *D* is made to rotate, and the arms *A*<sub>1</sub>, *A*<sub>2</sub>, *A*<sub>3</sub>, *A*<sub>4</sub>, which are attached to it, pass successively into the mercury bath *M*. The pulley on the clock rotates once an hour, and the arms *A*<sub>1</sub>, *A*<sub>2</sub>, *A*<sub>3</sub>, *A*<sub>4</sub> can be made to rotate once in 10 min., 15 min., 40 min., or 60 min., according as the twine is passed round the smaller or larger pulleys at *D*. There being four arms, *A*<sub>1</sub>, *A*<sub>2</sub>, *A*<sub>3</sub>, *A*<sub>4</sub>, one, two, or all of which can

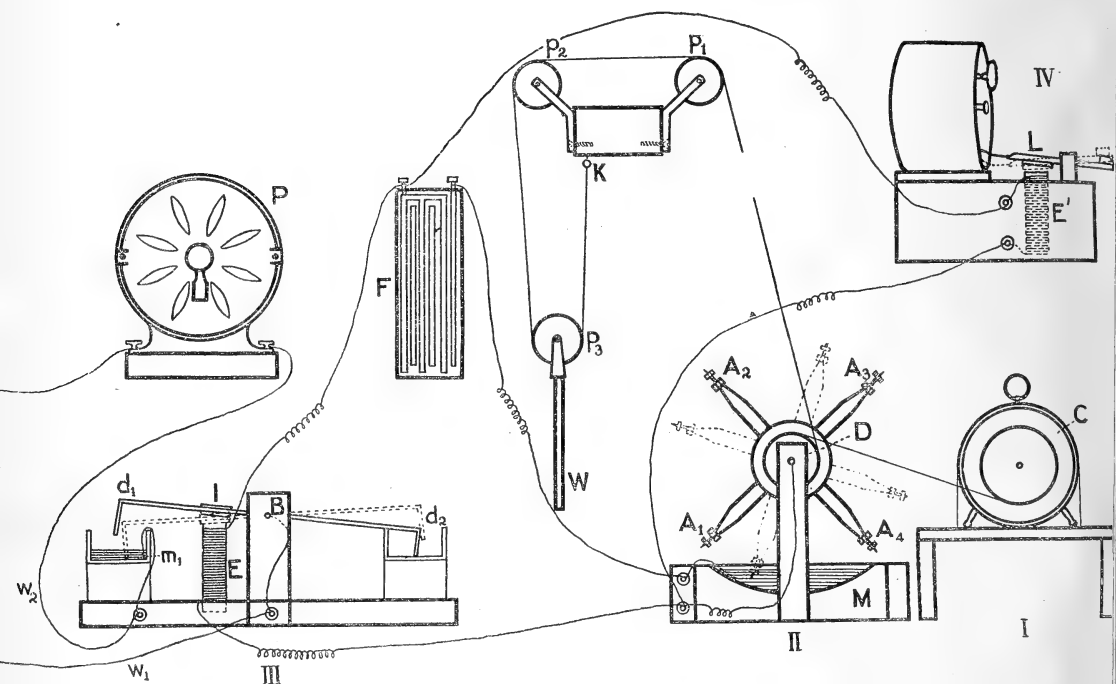

TEXT-FIG. 3.

be used, contacts with the mercury can be regularly made at intervals varying from  $2\frac{1}{2}$  min. to 60 min. (See also Fig. 5, Pl. LVIII.)

At *F* is a 2-volt electric accumulator, one terminal of which is connected with the mercury bath *M*. To the other terminal is attached a wire which passes round the electro-magnet *E*, and thence is connected with the axis of the pulleys at *D* and the arms *A*<sub>1</sub>, *A*<sub>2</sub>, *A*<sub>3</sub>, *A*<sub>4</sub>. Thus, when one of the arms *A*<sub>1</sub>, *A*<sub>2</sub>, *A*<sub>3</sub>, *A*<sub>4</sub> is dipping into the mercury bath *M*, the current is made which makes the electro-magnet operative.

At the point *B* is loosely hinged a stiff wire *d*<sub>1</sub> *d*<sub>2</sub>, bent downwards at each end. On this wire, in the part *Bd*<sub>1</sub>, is fixed a soft iron plate *I*, just above the magnet. The end *d*<sub>2</sub> is weighted so as to make this end heavier.

Now when the electro-magnet is not active, the end *d*<sub>2</sub>, being heavier,

rests on the support as shown in Text-fig. 3; but when one of the arms  $A_1, A_2, A_3, A_4$  touches the mercury  $M$ , as shown in the dotted line drawing, the electro-magnet  $E$  becomes alive and attracts the soft iron  $I$ , drawing the end  $d_1$  down so as to touch the mercury in the mercury-bath  $m_1$ . This connects the wire  $w_1$ , which attaches the wire  $d_1 d_2$  with the town main, and  $w_2$ , which connects the mercury bath  $m_1$  with the electric motor  $P$ , and starts the motor, since the other terminal of the motor is connected with the other terminal of the town main. The electric motor thus starts running and turns the 'wheel'. So when one of the arms  $A_1, A_2, A_3, A_4$  touches the mercury bath  $M$ , the wheel starts rotating, and when the arm leaves the mercury the wheel stops. The object of the complication shown in portion III of this figure is that it makes and breaks the town main current very rapidly, and so prevents the lengthened sparking which occurred when the town main current was allowed to pass through the mercury bath  $M$  in portion II.

An additional piece of apparatus was added in the form of a clock, which only worked whilst one of the arms  $A_1, A_2, A_3, A_4$  was touching the mercury. This is shown in portion IV of the figure. A lever  $L$  is weighted at the end  $l$ , and the other end touches an extension attached to the balance-wheel of the clock and prevents it from 'going'. On this end of the lever is attached a soft iron plate, which lies above the electro-magnet  $E'$ . This electro-magnet is joined up in the same way as the electro-magnet  $E$  in portion III of the figure and is parallel with it. When the electro-magnet  $E'$  becomes active, the lever  $L$  is pulled down, freeing the balance-wheel of the clock and thereby starting the clock. Thus the clock only goes whilst the current is passing and the wheel rotating, so that the clock records the total time that the wheel has been rotating during the experiment. This clock will be referred to as the 'control clock'.

The result of all this apparatus is that when any one of the arms  $A_1, A_2, A_3, A_4$  is in contact with the mercury  $M$ , the wheel is caused to rotate and the seedlings in the box are subjected to the centrifugal force. When the arm leaves the mercury the 'wheel' stops, and the seedlings are subject to gravity acting in the opposite direction. The alternation may be kept up as long as required (an experiment usually lasts from six to fifteen hours), and at the end of the time the control clock shows the total period during which the 'wheel' was rotating, and the rotation recorder denotes the number of rotations performed by the 'wheel'. From these data the average rate of rotation of the 'wheel', whilst moving, can be deduced and the centrifugal force worked out. The time during which gravity works alone is determined by subtracting the time recorded by the control clock from the total time of the experiment.

## Working Methods.

We will take an experiment in which the figures are simple. Suppose we try to find the effect of a stimulus of 9 mg. On the rod  $RR$  the rider carrying the seedling-box should be placed at about 18 cm. from the centre. The bolt on bar  $M$  (Text-fig. 1) should be screwed to the point which allows the bar  $D$  to swing out so far that the back of the box lies in a plane pointing  $6^\circ$  below the horizontal ( $\tan 6^\circ = \text{about } \frac{1}{9}$ ), as it will then lie in the line of the resultant of gravity and the centrifugal force. The bands must be arranged round the pulleys so that the wheel may rotate at about 210 revolutions per minute.

In portion II (Text-fig. 3) we must allow just so much mercury to lie in the bath  $M$  that in the revolution of the arms,  $A_1$  touches the mercury for 1 min., say, and is free of it for 9 min. The points can be removed from the other arms so that they do not touch the mercury. Thus the 'wheel' will alternately rotate for 1 min. and be still for 9 min.

When rotating, the middle of the box will be subject to a centrifugal force of  $4\pi^2 R^2 r$  dynes or  $4\pi^2 R^2 r \frac{1}{981}$  mg. where  $r$  is the radius of rotation in centimetres and  $R$  the number of revolutions per sec. By our hypothesis  $R = \frac{210}{60} = 3.5$  and  $r = 18$ .  $\therefore 4\pi^2 R^2 r = 8900$  dynes = about 9 mg.

This is at the middle point of the box; but the radius passed through by the outer side of the box is greater than 18 cm., and hence the centrifugal force is greater; and towards the inner side the radius of rotation is less than 18 cm., so that the centrifugal force is less than 9 mg. In fact, at the upper (outer) side the centrifugal force will be 11 mg., and at the lower (inner) side it will be 7 mg.

Now, suppose a force of 9 mg. acting for 1 min. exactly counteracts the force of gravity (1 mg.) acting for 9 min.; then, at the centre of the box the radicles will not bend in either direction, but will grow straight. But in this case a force of 11 mg. acting for 1 min. will more than neutralize a force of 1 mg. acting for 9 min., so that the radicles growing above the middle will bend outwards. Similarly, below the middle of the box they will bend inwards or downwards. This actually happens in all successful experiments, and Fig. 6, Pl. LVIII, shows such a result. There is thus a line of equilibrium across the box, outside which the radicles will bend outwards and inside which they will bend inwards, whilst in this line of equilibrium the radicles remain approximately straight. This will afterwards be referred to as the 'line' or 'point of equilibrium'.

In actual working, owing to variability in the strength of the town-main current, it is impossible exactly to foretell the rate at which the wheel will rotate, and consequently the exact force acting at the centre of the box will not be known till the end of the experiment, when the data supplied by the rotation recorder and the control clock give the required

value. And it usually happens that the point of equilibrium does not lie exactly in the middle of the box, but either above or below it. In Fig. 6 it lies 2 cm. below the middle of the box, and in taking a reading the centrifugal force at this point has to be worked out.

**Two Sources of Error.**

There are two main sources of error in these calculations:

(i) The town-main current is not constant, and this gives rise to irregularity in the rate of rotation of the 'wheel'. Such irregularities are shown in the last column on p. 732, where variations in rotation are shown from 3.59 revolutions per sec. to 3.75 revolutions per sec., and this within the course of twelve hours. I have found no method of correcting for this error.

(ii) When the motor starts at the commencement of each period of rotation, it does not acquire its full speed for perhaps three or four seconds. Also, when the current ceases to flow, the 'wheel' does not immediately stop. This causes an error in the estimated rate of rotation, worked out from the number of rotations completed and the actual time during which *the current has been flowing*. This error is most marked when the individual periods of rotation are short, so that the times taken by starting and stopping are longer compared with the time of even running; and also when the bands round the pulleys are slack so that a considerable amount of slipping is allowed. When the individual periods of rotation are long, and the bands are tight, no correction need be made for this error.

I have been able to compensate for this error, to some extent at any rate, in the following way.

To take an example: the current flows for 30 seconds, but owing to the momentum acquired the 'wheel' rotates for 35 seconds, i.e. for 5 seconds after the current has ceased to flow. In this total time (35 sec.) the 'wheel' makes 107 revolutions. Now, working out the value of the centrifugal force from the data of the control clock and the rotation recorder, we have

$$R = \frac{107}{30} = 3.57 \therefore R^2 = 12.74 \text{ and } C = \frac{4\pi^2 R^2 r}{981} = 22.9 \text{ mg.}$$

since in this experiment the radius of rotation was 45 cm. A period was then carefully watched and the number of revolutions in each five seconds was recorded with the following result:

1st period of 5 sec.	9 revolutions	$R^2 = 3.2$	$C = 5.7$	$Ct = C \times 5 =$	28.5
2nd	15	9	16.2	81.0	
3rd	17	11.5	20.7	103.5	
4th	17	11.5	20.7	103.5	
5th	17	11.5	20.7	103.5	
6th	17	11.5	20.7	103.5	
7th	12	5.7	10.2	51.0	

Total in  $Ct$  units = 574.5

(The  $Ct$  unit represents a force of 1 mg. acting for one second).

But as determined by the control clock and rotation recorder the stimulation was 22.9 mg. acting for thirty seconds, which represents 687 *Ct* units.

I now assume that the stimulating power as reckoned by the method of summation of the stimulating force for each five seconds is more accurate than that reckoned from the total number of revolutions and the time the current was flowing. In this case a more accurate value for the stimulating force is obtained by multiplying the recorded centrifugal force by  $\frac{574.5}{687}$  or 0.84.

This correction I call the *Mechanical error correction*, and this will be quoted by saying *M.E.C.* = 0.84.

The example here taken is one in which the mechanical error correction makes a very great difference. This is due to the fact that in this experiment (i) the bands were very slack so that a considerable amount of slipping was possible, which made the 'wheel' both slow in getting up speed and slow in stopping, (ii) the period of running was short, so that the starting and stopping took up a greater amount of time in proportion to the time of normal running; and (iii) the rider was far out on the rod *RR* so that the wheel acquired a great momentum.

#### Specimen Experiment.

July 29, 1912. *Helianthus annuus* radicles.

Total period ( $t + T$ ) = 11 min. where  $t$  is the length of one period still, and  $T$  the length of one period of rotation.

Temp. = 20°C.

$\theta$  = angle made with vertical by back of box when rotating = 96°.

Distance of middle of box from centre of rotation = 20 cm.

Time.	Control Clock.	Time rotating.	Rotation recorder.	Rotations per sec.	
h. m. s.	h. m. s.	m. s.			
July 29 10 20 0 p.m.	5 4 53	54 <sup>1</sup>	47,772	3.59 <sup>2</sup>	
	5 5 49		47,973		
July 30 9 24 8 a.m.	6 5 8	59 17 = 3,557 s.	61,096	3.69	
	6 6 8		61,391		
	10 40 0	6 12 7	5 59 = 359 s.	62,654	3.71

$$\text{From the above } \frac{t+T}{T} = \frac{\text{Total time of experiment}}{\text{Time recorded by control clock}}$$

$$= \frac{22^{\text{h}} 40^{\text{m}} - 10^{\text{h}} 20^{\text{m}}}{6^{\text{h}} 12^{\text{m}} 7^{\text{s}} - 5^{\text{h}} 4^{\text{m}} 58^{\text{s}}} = \frac{44,400^{\text{s}}}{4,034^{\text{s}}} = 11.0.$$

$$\therefore \frac{t}{T} = 10.0.$$

<sup>1</sup> This is the actual length of a period of rotation. It could not be kept quite constant.

<sup>2</sup> This figure is obtained by dividing the number of revolutions by the number of seconds during which the 'wheel' was revolving,

$$\text{i.e. it} = \frac{47,973 - 47,772}{54} = 3.59.$$



$R$  = average number of rotations per sec. whilst running

$$= \frac{62,654 - 47,772}{4,934} = 3.69.$$

$$\therefore R^2 = 13.2.$$

Now in this experiment the point of equilibrium was 1 cm. below the middle of the box, and at this point the radius of rotation = 19 cm., i. e.  $r = 19$ .

$$\begin{aligned} \text{Cent. force} &= \pi^2 R^2 r = 39.5 \times 13.2 \times 19 \\ &= 10,222 \text{ dynes} \\ &= \frac{10,222}{981} \text{ mg.} \\ &= 10.42 \text{ mg.} \end{aligned}$$

But since gravity was also working the whole time we should take the value of the resultant of gravity and the centrifugal force in the direction  $6^\circ$  below the horizontal.

$$\begin{aligned} \text{This} = C &= (10.42 \cos 6^\circ + 1 \sin 6^\circ) \text{ mg.} \\ &= (10.42 \times 0.9945 + 0.1045) \text{ mg.} \\ &= 10.46 \text{ mg.}^1 \end{aligned}$$

In this experiment the value of the mechanical error correction, i. e. M.E.C. = 0.93.

$$\therefore C \text{ (corrected)} = 10.46 \times 0.93 = 9.7 \text{ mg.} \quad \therefore \frac{C}{mg} = 9.7, \text{ but } \frac{t}{T} = 10.$$

$$\therefore \frac{C \cdot T}{mg \cdot t} = 0.97, \text{ which is an approximation to } 1.$$

#### EXPERIMENTS.

*Helianthus annuus*. The 'seeds' of *Helianthus* were soaked in water for twenty-four hours in a dish, which in winter was placed on the hot-water pipes. They were then sown upright in damp sand and kept at a temperature of about  $20^\circ\text{C}$ . They were ready for experimenting from forty-eight to seventy-two hours after the commencement of soaking. In general the radicles were 2 to 10 mm. long at the beginning of an experiment. In all about 135 experiments have been carried out on the radicles of *Helianthus annuus*; but of these the first fifty have been disregarded, as in the light of later experience it was seen that sufficient precautions had not been taken in these earlier experiments to avoid errors. They served the purpose of providing experience in the use of the centrifugal machine, but will not be employed in deducing results. In many others the line of equilibrium did not fall within the limits of the box, so that the radicles either bent all upwards or all downwards. From these it can only be shown that with the times taken ( $t$  and  $T$ ) the centrifugal force necessary just to neutralize gravity is either less or greater than the calculable amount. If it had been possible to predict at the beginning of the experiment the centrifugal force that would be obtained sufficiently closely, failures arising from this source

<sup>1</sup> When the centrifugal force is high this correction makes very little difference and can be neglected.

could have been prevented. Other experiments failed owing to the accumulator running down or other parts of the instrument going wrong.

The following list of experiments includes all those in which none of the above-mentioned causes of failure occurred. The experiments are arranged in order of the centrifugal forces used, not in the order in which they were performed.

<sup>1</sup> EXPERIMENT 1. Sept. 17, 1912. 9.27 a.m. to 3 p.m.

Temp. = 20° C.

Radius of rotation at middle of box = 6.5 cm.

$\theta = 105^\circ$ .

Total period ( $t + T$ ) = 11 m.

$\frac{t}{T} = 3.31$ .

$R = 3.92$ .

Point of equilibrium is 1.5 cm. below middle of box.

$\therefore r =$  Radius of rotation here = 5 cm.

Cent. force here = 3.09 mg.

$C =$  resultant of centrifugal force and gravity = 3.42 mg.

Thus  $\frac{t}{T} = 3.31$ ,  $\frac{C}{mg} = 3.24$ .

$\therefore \frac{CT}{mg \cdot t} = 1.02$ .

EXPERIMENT 2. Sept. 15, 1912. 10.15 a.m. to 4.5 p.m.

Temp. = 20° C.

Radius of rotation at middle of box = 7 cm.

$\theta = 105^\circ$ .

Total period ( $t + T$ ) = 7 m. 30 s.

$\frac{t}{T} = 3.17$ .

$R = 4.045$ .

Point of equilibrium is 2.0 cm. below middle.

$\therefore r = 5$  cm.

Cent. force = 3.30 mg.

$C = 3.45$  mg.

Thus  $\frac{t}{T} = 3.17$ ,  $\frac{C}{mg} = 3.45$ .

$\therefore \frac{CT}{mg \cdot t} = 1.09$ .

EXPERIMENT 3. Sept. 15, 1912. 4.15 p.m. to 10.2 p.m.

Temp. = 20° C.

Radius of rotation at middle of box = 7 cm.

$\theta = 105^\circ$ .

<sup>1</sup> For the meaning of symbols see 'Specimen Experiment', p. 732.

Total period ( $t + T$ ) = 7 m. 50 s.

$$\frac{t}{T} = 4.5.$$

$$R = 4.086.$$

Point of equilibrium is 0.5 cm. below middle of box.

$$\therefore r = 6.5 \text{ cm.}$$

$$\text{Cent. force} = 4.36 \text{ mg.}$$

$$C = 4.51 \text{ mg.}$$

$$\text{Thus } \frac{t}{T} = 4.5, \frac{C}{mg} = 4.51.$$

$$\therefore \frac{CT}{mg \cdot t} = 1.00.$$

EXPERIMENT 4. Sept. 15, 1912, 10.14 p.m., to Sept. 16, 9.25 a.m.

Temp. = 20° C.

Radius of rotation at middle of box = 7 cm.

$$\theta = 105^\circ.$$

Total period ( $t + T$ ) = 7 m. 30 s.

$$\frac{t}{T} = 5.65.$$

$$R = 4.37.$$

Point of equilibrium is at middle of box.

$$\therefore r = 7 \text{ cm.}$$

$$\text{Cent. force} = 5.38 \text{ mg.}$$

$$C = 5.45 \text{ mg.}$$

$$\text{Thus } \frac{t}{T} = 5.65, \frac{C}{mg} = 5.45.$$

$$\therefore \frac{CT}{mg \cdot t} = 0.96.$$

EXPERIMENT 5. Sept. 19, 1912. 9.50 a.m. to 5.25 p.m.

Temp. = 20° C.

Radius of rotation at middle of box = 10 cm.

$$\theta = 105^\circ.$$

Total period ( $t + T$ ) = 7 m. 30 s.

$$\frac{t}{T} = 5.30.$$

$$R = 3.85.$$

Point of equilibrium is 1 cm. below middle of box.

$$\therefore r = 9 \text{ cm.}$$

$$\text{Cent. force} = 5.40 \text{ mg.}$$

$$C = 5.47 \text{ mg.}$$

$$\text{Thus } \frac{t}{T} = 5.30, \frac{C}{mg} = 5.47.$$

$$\therefore \frac{CT}{mg \cdot t} = 1.03.$$

EXPERIMENT 6. May 9, 1912. 9.25 a.m. to 8.30 p.m.

Temp. =  $20^{\circ}$  C.

Radius of rotation at middle of box = 15 cm.

$\theta = 100^{\circ}$ .

Total period ( $t + T$ ) = 11 m.

$$\frac{t}{T} = 7.97.$$

$R = 3.61$ .

Point of equilibrium is 1 cm. below middle of box.

$\therefore r = 14$  cm.

Cent. force = 7.34 mg.

$C = 7.40$  mg.

Thus  $\frac{t}{T} = 7.97$ ,  $\frac{C}{mg} = 7.40$ .

$$\therefore \frac{CT}{mg \cdot t} = 0.93.$$

EXPERIMENT 7. June 21, 1912. 10.20 a.m. to 6.40 p.m.

Temp. =  $21^{\circ}$  C.

Radius of rotation at middle of box = 15 cm.

$\theta = 100^{\circ}$ .

Total period ( $t + T$ ) = 11 m.

$$\frac{t}{T} = 7.94.$$

$R = 3.82$ .

Point of equilibrium is 1.5 cm. below middle of box.

$\therefore r = 13.5$ .

Cent. force = 7.93 mg.

$C = 7.98$  mg.

And  $M.E.C. = 1.00$ .

Thus  $\frac{t}{T} = 7.94$ ,  $\frac{C}{mg} = 7.98$ .

$$\therefore \frac{CT}{mg \cdot t} = 1.01.$$

EXPERIMENT 8. July 29, 1912, 10.20 p.m., to July 30, 10.40 a.m.

Temp. =  $20^{\circ}$  C.

Radius of rotation at middle of box = 20 cm.

$\theta = 96^{\circ}$ .

Total period ( $t + T$ ) = 11 m.

$$\frac{t}{T} = 10.0.$$

$R = 3.69$ .

Point of equilibrium is 1 cm. below middle of box.

$\therefore r = 19$  cm.

Cent. force = 10.42 mg.

$C = 10.46$  mg.

And  $M.E.C. = 0.93$ .

$\therefore C$  (corrected) = 9.7 mg.

Thus  $\frac{t}{T} = 10.0$ ,  $\frac{C}{mg} = 9.7$ .

$\therefore \frac{CT}{mg \cdot t} = 0.97$ .

EXPERIMENT 9. May 4, 1912. 11.50 a.m. to 10.20 p.m.

Temp. = 20° C.

Radius of rotation at middle of box = 20 cm.

$\theta = 96^\circ$ .

Total period ( $t + T$ ) = 11 m.

$\frac{t}{T} = 10.5$ .

$R = 3.78$ .

Point of equilibrium is 2 cm. below middle of box.

$\therefore r = 18$  cm.

Cent. force = 10.35 mg.

$C = 10.39$  mg.

Thus  $\frac{t}{T} = 10.5$ ,  $\frac{C}{mg} = 10.39$ .

$\therefore \frac{CT}{mg \cdot t} = 0.99$

EXPERIMENT 10. Dec. 18, 1911. 10.19 a.m. to 9.40 p.m.

Radius of rotation at middle of box = 30 cm.

$\theta = 94^\circ$ .

Total period ( $t + T$ ) = 5 m. 30 s.<sup>1</sup>

$\frac{t}{T} = 11.30$ .

$R = 3.03$ .

Point of equilibrium is 1.5 cm. below middle of box.

$\therefore r = 28.5$  cm.

Cent. force = 10.52 mg. =  $C$ .<sup>2</sup>

Thus  $\frac{t}{T} = 11.30$ ,  $\frac{C}{mg} = 10.52$ .

$\therefore \frac{CT}{mg \cdot t} = 0.93$ .

EXPERIMENT 11. Dec. 17, 1911. 11.35 a.m. to 11.30 p.m.

Temp. = 19° C.

Radius of rotation at middle of box = 30 cm.

$\theta = 94^\circ$ .

<sup>1</sup> In this experiment the times were arranged differently. The wheel rotated for 26 s., was still for 2 m. 17 s.; rotated for 27 s., and still for 8 m. It then started rotating again for 26 secs.

<sup>2</sup> When  $\theta$  is less than  $96^\circ$ , the resultant of the centrifugal force and gravity is so near the former that it may be taken as equal to it.

Total period ( $t + T$ ) = 5 m. 30 s.

$$\frac{t}{T} = 11.6.$$

$$R = 3.0.$$

Point of equilibrium is 1 cm. below the middle of box.

$$\therefore r = 29 \text{ cm.}$$

Here  $C = 11.4 \text{ mg.}$

$$\text{Thus } \frac{t}{T} = 11.6, \quad \frac{C}{mg} = 11.4.$$

$$\therefore \frac{CT}{mg \cdot t} = 0.98.$$

EXPERIMENT 12. Dec. 19, 1911. 8.27 a.m. to 3.45 p.m.

Temp. = 19° C.

Radius of rotation at middle of box = 30 cm.

$$\theta = 94^\circ.$$

Total period ( $t + T$ ) = 7 m. 45 s.<sup>1</sup>

$$\frac{t}{T} = 13.8.$$

$$R = 3.37.$$

Point of equilibrium is 1 cm. below middle of box.

$$\therefore r = 29 \text{ cm.}$$

$$C = 13.2 \text{ mg.}$$

$$\text{Thus } \frac{t}{T} = 13.8, \quad \frac{C}{mg} = 13.2.$$

$$\therefore \frac{CT}{mg \cdot t} = 0.96.$$

EXPERIMENT 13. April 28, 1912. 10.23 a.m. to 11 p.m.

Temp. = 20° C.

Radius of rotation at middle of box = 27 cm.

$$\theta = 94^\circ.$$

Total period ( $t + T$ ) = 11 m.

$$\frac{t}{T} = 16.5.$$

$$R = 3.74.$$

Point of equilibrium is at middle of box.

$$\therefore r = 27 \text{ cm.}$$

$$C = 15.2 \text{ mg.}$$

$$\text{Thus } \frac{t}{T} = 16.5, \quad \frac{C}{mg} = 15.2.$$

$$\therefore \frac{CT}{mg \cdot t} = 0.92.$$

<sup>1</sup> 37 sec. rotation, 3 min. 21 sec. rest; 26 sec. rotation, 11 min. 7 sec. rest, and repeat.

EXPERIMENT 14. Jan. 20, 1912. 10.40 a.m. to 9.10 p.m.

Temp. = 19° C.

Radius of rotation at middle of box = 30 cm.

$\theta = 94^\circ$ .

Total period ( $t + T$ ) = 15 m. 30 s.

$$\frac{t}{T} = 16.3.$$

$$R = 3.88.$$

Point of equilibrium is 3 cm. below middle of box.

$$\therefore r = 27 \text{ cm.}$$

$$C = 16.4 \text{ mg.}$$

$$\text{Thus } \frac{t}{T} = 16.3, \frac{C}{mg} = 16.4.$$

$$\therefore \frac{CT}{mg \cdot t} = 1.01.$$

EXPERIMENT 15. Jan. 18, 1912. 10.20 a.m. to 5.10 p.m.

Temp. = 20° C.

Radius of rotation at middle of box = 30 cm.

$\theta = 94^\circ$ .

Total period ( $t + T$ ) = 11 m.

$$\frac{t}{T} = 17.7.$$

$$R = 3.83.$$

Point of equilibrium is at middle of box.

$$\therefore r = 30 \text{ cm.}$$

$$C = 17.7 \text{ mg.}$$

$$\text{Thus } \frac{t}{T} = 17.7, \frac{C}{mg} = 17.7.$$

$$\therefore \frac{CT}{mg \cdot t} = 1.00.$$

EXPERIMENT 16. March 23, 1912. 11.10 a.m. to 10.20 p.m.

Radius of rotation at middle of box = 45 cm.

$\theta = 92^\circ$ .

Total period ( $t + T$ ) = 11 m.

$$\frac{t}{T} = 18.2.$$

$$R = 3.47.$$

Point of equilibrium is at middle of box.

$$\therefore r = 45 \text{ cm.}$$

$$C = 21.8 \text{ mg.}$$

$$\text{M.E.C.} = 0.85.^1$$

$$\therefore C \text{ (corrected)} = 18.5 \text{ mg.}$$

<sup>1</sup> The mechanical error was great owing to the bands having become very loose.

$$\text{Thus } \frac{t}{T} = 18.2, \frac{C}{mg} = 18.5.$$

$$\therefore \frac{CT}{mg \cdot t} = 1.02.$$

EXPERIMENT 17. March 26, 1912. 10.10 a.m. to 9.15 p.m.

Temp. 20° C.

Radius of rotation at middle of box = 45 cm.

$\theta = 92^\circ$ .

Total period ( $t + T$ ) = 11 m.

$$\frac{t}{T} = 19.0.$$

$$R = 3.56.$$

Point of equilibrium is 2.5 cm. below middle of box.

$\therefore r = 42.5$  cm.

$$C = 21.4 \text{ mg.}$$

But M.E.C. = 0.87.

$\therefore C$  (corrected) = 18.6 mg.

$$\text{Thus } \frac{t}{T} = 19.0, \frac{C}{mg} = 18.6.$$

$$\therefore \frac{CT}{mg \cdot t} = 0.98.$$

EXPERIMENT 18. March 22, 1912. 11.30 a.m. to 9.20 p.m.

Temp. 20° C.

Radius of rotation at middle of box = 45 cm.

$\theta = 92^\circ$ .

Total period ( $t + T$ ) = 11 m.

$$\frac{t}{T} = 20.85.$$

$$R = 3.66.$$

Point of equilibrium is 0.5 cm. above middle of box (not very clear).

$\therefore r = 45.5$  cm.

$$C = 24.6.$$

But M.E.C. = 0.85.

$\therefore C$  (corrected) = 20.9 mg.

$$\text{Thus } \frac{t}{T} = 20.85, \frac{C}{mg} = 20.9.$$

$$\therefore \frac{CT}{mg \cdot t} = 1.00.$$

The above results are summed up in the following table:



TABLE I.

*Helianthus annuus* radicles. Temp. about 20° C.

No. of Exp.	$\frac{C}{mg}$	$\frac{t}{T}$	$(t+T)$		$\frac{CT}{mg.t}$
			m.	s.	
1	3.24	3.31	11	0	1.02
2	3.45	3.17	7	30	1.09
3	4.51	4.5	7	30	1.00
4	5.45	5.65	7	30	0.96
5	5.47	5.30	7	30	1.03
6	7.4	7.97	11	0	0.93
7	7.98	7.94	11	0	1.01
8	9.7	10.0	11	0	0.97
9	10.39	10.5	11	0	0.99
10	10.52	11.30	5	30	0.93
11	11.4	11.6	5	30	0.98
12	13.2	13.8	7	45	0.96
13	15.2	16.5	11	0	0.92
14	16.4	16.3	15	30	1.01
15	17.7	17.7	11	0	1.00
16	18.5	18.2	11	0	1.02
17	18.6	19.0	11	0	0.98
18	20.9	20.85	11	0	1.00

Average value of  $\frac{CT}{mg.t} = 0.99$ .

The above results show that to a very near approximation  $\frac{CT}{mg.t} = 1$  or  $CT = mg.t$ , i. e. *the stimulating force multiplied by the time of action must be the same in each direction if a radicle is to remain straight under the influence of two opposing alternating stimuli.*

But it should be noted that the total period ( $t+T$ ) was never allowed to exceed 15 min. 30 sec. A large number of experiments, however, were performed with longer periods, but the results were quite out of keeping with those quoted above. It was usually impossible to trace a definite line of equilibrium across the box, so that any results that are given below are not very exact. And in many of the experiments the radicles all bent downwards, showing that the line of equilibrium is outside the box and further from the centre of rotation; so that for equilibrium  $C$  must be greater than that at the upper edge of the box.

The following experiments are quoted to show that the equation  $CT = mg.t$  does not hold if the total periods are long. In general the greater the centrifugal force and the longer the total period, the higher is the value of  $\frac{CT}{mg.t}$ .

Experiments with *Helianthus annuus* radicles, using total periods of more than twenty minutes.

EXPERIMENT 19. May 11, 1911. 11 a.m. to 8 p.m.

Temp. = 25° C.

Radius of rotation at middle of box = 20 cm.

$\theta = 96^\circ$ .

Total period ( $t + T$ ) = 1 hour.

$$\frac{t}{T} = 3.12.$$

$$R = 3.61.$$

All the radicles bent up.

$\therefore$  Point of equilibrium is below the lower edge of the box.

$\therefore r < 16$  cm.

$\therefore$  Cent. force < 8.41 mg.

$C < 8.46$  mg.

Thus  $\frac{t}{T} = 3.12, \frac{C}{mg} < 84.6$ .

$$\therefore \frac{CT}{mg \cdot t} < 2.71.$$

EXPERIMENT 20. April 6, 1911. 11 a.m. to 8.30 p.m.

Radius of rotation at middle of box = 30 cm.

$\theta = 100^\circ$ .

Total period ( $t + T$ ) = 1 hour.

$$\frac{t}{T} = 7.14.$$

$$R = 3.41.$$

Point of equilibrium is about 2 cm. below middle of box.

$\therefore r = 28$  cm.

$C = 13.1$  mg.

Thus  $\frac{t}{T} = 7.14, \frac{C}{mg} = 13.1$ .

$$\therefore \frac{CT}{mg \cdot t} = 1.83.$$

EXPERIMENT 21. Oct. 19, 1911. 12.30 p.m. to 10.30 p.m.

Radius of rotation at middle of box = 30 cm.

$\theta = 94^\circ$ .

Total period ( $t + T$ ) = 40 m. 30 s.

$$\frac{t}{T} = 5.04.$$

$$R = 3.57.$$

Point of equilibrium is about 1 cm. below middle.

$$\therefore r = 29 \text{ cm.}$$

$$C = 14.9 \text{ mg.}$$

$$\text{Thus } \frac{t}{T} = 5.04, \frac{C}{mg} = 14.9.$$

$$\therefore \frac{CT}{mg \cdot t} = 2.96.$$

EXPERIMENT 22. April 3, 1911. 10 a.m. to 7.30 p.m.

Temp. = 25° C.

Radius of rotation at middle of box = 30 cm.

$$\theta = 94^\circ.$$

Total period ( $t + T$ ) = 20 m.

$$\frac{t}{T} = 8.92.$$

$$R = 3.36.$$

Point of equilibrium is about 3 cm. above middle of box.

$$\therefore r = 33 \text{ cm.}$$

$$C = 15.0 \text{ mg.}$$

$$\frac{t}{T} = 8.92, \frac{C}{mg} = 15.0.$$

$$\therefore \frac{CT}{mg \cdot t} = 1.68.$$

EXPERIMENT 23. April 5, 1911. 12 noon to 6.40 p.m.

Radius of rotation at middle of box = 30 cm.

$$\theta = 100^\circ.$$

Total period ( $t + T$ ) = 1 hour.

$$\frac{t}{T} = 8.84.$$

$$R = 3.44.$$

All the radicles bent down.

$$\therefore r > 34 \text{ cm.}$$

$$\therefore C > 16.19 \text{ mg.}$$

$$\text{Thus } \frac{t}{T} = 8.84, \frac{C}{mg} > 16.19.$$

$$\therefore \frac{CT}{mg \cdot t} > 1.83.$$

EXPERIMENT 24. May 8, 1911. 9.30 a.m. to 7.30 p.m.

Temp. = 25° C.

Radius of rotation at middle of box = 30 cm.

$$\theta = 94^\circ.$$

Total period ( $t + T$ ) = 1 hour.

$$\frac{t}{T} = 3.16.$$

$$R = 3.66.$$

Point of equilibrium is about the middle of the box.

$$\therefore r = 30 \text{ cm.}$$

$$C = 16.22 \text{ mg.}$$

$$\text{Thus } \frac{t}{T} = 3.16, \frac{C}{mg} = 16.22.$$

$$\therefore \frac{CT}{mg \cdot t} = \text{about } 5.13.$$

EXPERIMENT 25. April 29, 1911. 9.30 a.m. to 6 p.m.

Temp. = 24° C.

Radius of rotation at middle of box = 30 cm.

$$\theta = 94^\circ.$$

Total period ( $t + T$ ) = 1 hour.

$$\frac{t}{T} = 6.00.$$

$$R = 3.50.$$

All radicles bent down.

$$\therefore r > 34 \text{ cm.}$$

$$C > 16.8 \text{ mg.}$$

$$\text{Thus } \frac{t}{T} = 6.00, \frac{C}{mg} > 16.8.$$

$$\therefore \frac{CT}{mg \cdot t} > 2.8.$$

EXPERIMENT 26. Oct. 21, 1911, 6.30 p.m. to Oct. 22, 10.30 a.m.

Radius of rotation at middle of box = 30 cm.

$$\theta = 94^\circ.$$

Total period ( $t + T$ ) = 41 m.

$$\frac{t}{T} = 6.11.$$

$$R = 3.77.$$

Point of equilibrium near middle of box.

$$\therefore r = 30 \text{ cm.}$$

$$C = 17.2 \text{ mg.}$$

$$\text{Thus } \frac{t}{T} = 6.11, \frac{C}{mg} = 17.2.$$

$$\therefore \frac{CT}{mg \cdot t} = \text{about } 2.82.$$

EXPERIMENT 27. Oct. 18, 1911. 9.20 a.m. to 6.30 p.m.

Radius of rotation at middle of box = 30 cm.

$$\theta = 94^\circ.$$

Total period ( $t + T$ ) = 40 m. 30 s.

$$\frac{t}{T} = 9.05.$$

$$R = 3.55.$$

All radicles bent down (except two which grew irregularly).

$$\therefore r > 34 \text{ cm.}$$

$$C > 17.2 \text{ mg.}$$

$$\text{Thus } \frac{t}{T} = 9.05, \frac{C}{mg} > 17.2.$$

$$\therefore \frac{CT}{mg \cdot t} > 1.90.$$

EXPERIMENT 28. April 7, 1911. 11 a.m. to 6.30 p.m.

Temp. = 24° C.

Radius of rotation at middle of box = 30 cm.

$$\theta = 94^\circ.$$

Total period ( $t + T$ ) = 1 hour.

$$\frac{t}{T} = 7.07.$$

$$R = 3.58.$$

All the radicles bent down.

$$\therefore r > 34 \text{ cm.}$$

$$C > 17.54 \text{ mg.}$$

$$\text{Thus } \frac{t}{T} = 7.07, \frac{C}{mg} > 17.54.$$

$$\therefore \frac{CT}{mg \cdot t} > 2.48.$$

EXPERIMENT 29. Oct. 2, 1911, 10.30 a.m., to Oct. 3, 10.5 a.m.

Radius of rotation at middle of box = 30 cm.

$$\theta = 94^\circ.$$

Total period ( $t + T$ ) = 40 m. 30 s.

$$\frac{t}{T} = 11.11.$$

$$R = 3.70.$$

Point of equilibrium is near the top of the box (rather doubtful).

$$\therefore r = \text{about } 34 \text{ cm. (?)}$$

$$\therefore C = \text{about } 18.8 \text{ mg. (?)}$$

$$\text{Thus } \frac{t}{T} = 11.11, \frac{C}{mg} = \text{about } 18.8?$$

$$\therefore \frac{CT}{mg \cdot t} = \text{about } 1.7 \text{ (?)}$$

These results are summed up in the following table :

TABLE II.

*Helianthus annuus* radicles. Temp. = 20°–25° C.

Results with long total periods (i. e. 20 m. and upwards).

No. of Exp.	$\frac{C}{mg}$	$\frac{t}{T}$	$(t+T)$			$\frac{CT}{mg.t}$
			h.	m.	s.	
19	< 8.46	3.12	1	0	0	< 2.71
20	13.1	7.14	1	0	0	1.83
21	14.9	5.04	40	30		2.96
22	15.0	8.92	20	0		1.68
23	> 16.19	8.84	1	0	0	> 1.83
24	16.22	3.16	1	0	0	5.13
25	> 16.8	6.0	1	0	0	> 2.8
26	17.2	6.11	41	0		2.82
27	> 17.2	9.05	40	30		> 1.90
28	> 17.54	7.07	1	0	0	> 2.48
29	18.8	(?) 11.11	40	30		> 1.7 (?)

By comparing the results in Tables I and II it will be seen that though the equation holds good when the total period is less than 16 min., yet  $CT > mg.t$  when the total period is greater than 19 min. This discrepancy was the cause of much confusion in the interpretation of earlier results. It is not easy to understand why, though a radicle grows straight under the influence of alternating stimuli of 10 mg. for 1 min. and 1 mg. for 10 min. in opposite directions, it does not grow straight under alternating and opposite stimuli of 10 mg. for 3 min. and 1 mg. for 30 min.; yet such is undoubtedly the case. It was thought that some light might be thrown on these results if it were found that the presentation time for *Helianthus* radicles was more than 16 min. and less than 20 min., as in that case a critical time would be passed in the later experiments. But experiments were carried out to determine the presentation time of Sunflower radicles, and these show that this time is less than five minutes.

*Presentation Time for Radicles of Helianthus annuus.*

This value was determined in the following way. Seedlings were grown in a pan of damp sand in the experimenting room which was kept at a temperature of 18 to 20° C. They thus remained at the same temperature from the beginning of germination till the end of the experiment. When the radicles were 5 to 15 mm. long, the seedlings were taken out, carefully washed in water at the temperature of the room, and pinned to squared corks covered with wet blotting-paper. The corks were pushed on to the

long axis of a Pfeffer's clinostat and covered by a glass cylinder as shown in Pfeffer's 'Physiology of Plants', vol. iii, p. 169. Up to this time the seedlings were constantly held with radicles vertical. The axis was then attached to the clinostat. They were allowed to remain motionless during the exposition time, after which they were made to rotate at a rate of about one revolution in 2 min. The following results were obtained :

Exposition time.		Temp.	No. of seedlings.	No. of radicles bent after						Percentage bent.
Min.	Sec.			1½ h.	2 h.	2½ h.	3 h.	4 h.	4½ h.	
10	0	20° C.	8	—	5	—	6	6	—	75 %
8	0	18° C.	9	3	—	5	—	—	8	89 %
6	0	20° C.	8	—	4	—	5	5	—	63 %
5	0	18° C.	9	4	—	5	—	—	5	55 %
4	30	18° C.	16	—	2	—	6	—	8	50 %
3	0	20° C.	8	—	3	—	4	4	—	50 %

Thus the presentation time is about 3 to 4½ min. at 18° to 20° C. Also Pekelharing ('09) showed that under stimulation greater than gravity the presentation time is inversely proportional to the stimulus ; so if, in the experiments summarized in Table I,  $t$  is greater than the presentation time for gravity,  $T$  will also be greater than the presentation time for the centrifugal force.

We thus see that radicles may be exposed alternately to centrifugal forces and gravity for much longer periods than the presentation time in each direction, and yet show neutrality when  $CT = mg. t$ . We have therefore to look for some other explanation to account for the discrepancy in the results with still longer exposition periods.

The most probable solution to the difficulty is suggested by the work of Jost and Stoppel ('12). These authors showed that under the action of high centrifugal forces, though roots at first respond positively, they will after a lengthened period of stimulation respond negatively. He found that Lupin roots, under the influence of a centrifugal force of 29 mg., will usually bend outwards (i. e. positively), but some show a tendency to bend inwards after prolonged stimulation. With a centrifugal force of 42 mg. roots sometimes respond negatively after six hours' stimulation. With a centrifugal force of 70 mg. most roots bend inwards after two hours.

These results have a very important bearing on the present work. Roots at first respond to a high centrifugal force positively, but after a while when the stimulation is continued they gradually become less active in their response and may end by bending *towards* the centre of rotation. Now we may suppose that in my earlier experiments the radicles were not stimulated continuously for sufficient time by the centrifugal force to cause any tendency to negative response. But in the experiments summarized in Table II stimulation proceeded long enough to allow of a diminution in the activity of response, so that less time

was required with normal gravitational stimulus in the opposite direction in order to counteract the tendency to bend outwards.

This result may be expressed as follows: When acted upon by a high centrifugal force roots at first perceive the stimulus fully, and the tendency to respond is proportional to the stimulating force. But after stimulation has proceeded for a certain time the tendency to respond falls off, and subsequent minutes are much less effective in their stimulating power. The actual period of stimulation by the centrifugal force (i. e.  $T$ ) in Experiments 10 to 18 is always less than 1 min.; in all the experiments summed up in Table II,  $T$  is more than 2 min. Comparing Experiment 13 (in which  $T = 38$  sec.) with Experiment 22 (in which  $T = 121$  sec.) it will be seen that the radicle tends to respond proportionally to the stimulus when it lasts for 38 sec., but not when it lasts for 121 sec. Thus the failure to respond fully begins before the expiration of two minutes.

#### EXPERIMENTS with *Cucurbita Pepo*.

A few experiments were also done with the Marrow; and the following results were obtained. The seeds were first soaked in water in a dish placed on the hot-water pipes for a day and were then transferred to a pan containing sand. They need a high temperature ( $20^{\circ}$ – $30^{\circ}$  C.) to germinate, and are usually ready for experimentation three days from the commencement of soaking.

EXPERIMENT 1. Dec. 10, 1912. 10.5 a.m. to 3.40 p.m.

Radius of rotation at middle of box = 7 cm.

$$\theta = 110^{\circ}.$$

Total period ( $t + T$ ) = 7 m. 43 s.

$$\frac{t}{T} = 3.8.$$

$$R = 3.93.$$

Point of equilibrium is 1.5 cm. below middle of box.

$$\therefore r = 5.5 \text{ cm.}$$

Cent. force = 3.42 mg.

$$\therefore C = 3.42 \cos 20^{\circ} + \sin 20^{\circ} = 3.56 \text{ mg.}$$

$$\therefore \frac{CT}{mg.t} = 0.94.$$

EXPERIMENT 2. Dec. 12, 1912. 2.10 p.m. to 10.45 p.m.

Radius of rotation at middle of box = 11 cm.

$$\theta = 102^{\circ}.$$

Total period ( $t + T$ ) = 5 m.

$$\frac{t}{T} = 5.64.$$

$$R = 3.93.$$

Point of equilibrium is 2.5 cm. below middle of box.

$$\therefore r = 8.5 \text{ cm.}$$



$\therefore$  Cent. force = 5.28 mg.

$$C = 5.28 \cos 12^\circ + \sin 12^\circ = 5.37 \text{ mg.}$$

$$\therefore \frac{CT}{\text{mg.} \cdot t} = 0.96.$$

EXPERIMENT 3. Dec. 15, 1912. 10.45 a.m. to 7.0 p.m.

Radius of rotation at middle of box = 20 cm.

$$\theta = 95^\circ.$$

Total period ( $t + T$ ) = 11 m.

$$\frac{t}{T} = 11.5.$$

$$R = 3.86.$$

Point of equilibrium is at middle of box.

$$\therefore r = 20.$$

$$C = 12.0.$$

M.E.C. = 0.94.

$$\therefore C \text{ (corrected)} = 11.28.$$

$$\therefore \frac{CT}{\text{mg.} \cdot t} = 0.98.$$

EXPERIMENT 4. Dec. 16, 1912. 10.15 a.m. to 5.40 p.m.

Radius of rotation at middle of box = 25 cm.

$$\theta = 96^\circ.$$

Total period ( $t + T$ ) = 11 m.

$$\frac{t}{T} = 12.8.$$

$$R = 3.83.$$

Point of equilibrium is 2.5 cm. below middle of box.

$$\therefore r = 22.5 \text{ cm.}$$

$$C = 13.3 \text{ mg.}$$

M.E.C. = 0.94.

$$\therefore C \text{ (corrected)} = 12.5.$$

$$\therefore \frac{CT}{\text{mg.} \cdot t} = 0.98.$$

EXPERIMENT 5. Dec. 16, 1911. 8.14 p.m. to Dec. 17, 11.10 a.m.

Radius of rotation at middle of box = 30 cm.

$$\theta = 94^\circ.$$

Total period ( $t + T$ ) = 5 m. 30 s.

$$\frac{t}{T} = 13.4.$$

$$R = 3.40.$$

Point of equilibrium is at middle of box.

$$\therefore r = 30 \text{ cm.}$$

$$C = 14.0 \text{ mg.}$$

$$\therefore \frac{CT}{\text{mg.} \cdot t} = 1.04.$$

NOTE. This experiment was performed before the M.E.C. was adopted.

EXPERIMENT 6. Dec. 16, 1912. 5.44 p.m. to 10.5 p.m.

Radius of rotation at middle of box = 25 cm.

$\theta = 95^\circ$ .

Total period ( $t + T$ ) = 11 m.

$\frac{t}{T} = 15.6$ .

$R = 3.97$ .

Point of equilibrium is at middle of box.

$\therefore r = 25$  cm.

$C = 15.9$  mg.

M.E.C. = 0.94.

$C$  (corrected) = 14.9 mg.

$\therefore \frac{CT}{mg \cdot t} = 0.96$ .

TABLE III.

No. of Exp.	$\frac{C}{mg}$	$\frac{t}{T}$	$(t + T)$		$\frac{CT}{mg \cdot t}$
			m.	s.	
1	3.56	3.8	7	43	0.94
2	5.37	5.64	5	0	0.95
3	11.28	11.5	11	0	0.98
4	12.5	12.8	11	0	0.98
5	14.0	13.4	5	30	1.04
6	14.9	15.6	11	0	0.96

Average value of  $\frac{CT}{mg \cdot t} = 0.97$ .

### CONCLUSIONS.

To obtain a clear idea of the place of the results obtained from this research in the science of geotropism, it is necessary to compare them with the results of other investigators in the same subject. Unfortunately, owing to the indefiniteness of our knowledge to-day, this is not easy to do. When Czapek ('98), Bach ('07), Pekelharing ('09), Rutgers ('10), and others had given us a definite conception of presentation time and reaction time, with sufficient data on which to base theories of graviperception, another school, represented by Polowzow ('09), Arisz ('11), and Tröndle ('13) makes us sceptical about all previous work on this subject by maintaining that presentation time and reaction time are artificial concepts founded on the fallibility of our unaided vision. They hold that whilst presentation time may be regarded as the least time of exposure to a geotropic stimulus which will cause a response *visible to the naked eye*, and reaction time as the period which elapses from the first exposure to stimulus to the time when response becomes *visible to the naked eye*, yet, as a matter of fact, response

occurs almost immediately after stimulation, though the movement can at first only be seen by the aid of a microscope.

Pekelharing ('10) subsequently remarks that the amount of bending which becomes visible to the naked eye is 'ein fester Punkt in dem Krümmungsprozess, der als Indikator einer bestimmten Reaktion benutzt werden kann'. Using the term 'presentation time' in this sense, we should expect marked inconsistencies in the results of different investigators. Also the naked eye test is scarcely as refined a test as might be desired, and results will involve the personal equation of the researcher as well as the individual peculiarities of the plants.

Some further compromise between the two points of view is possible. For it is noticeable that the latter list of authors always employed plant-members in which the perceptive region was also capable of response, e.g. hypocotyls of *Helianthus* and coleoptiles of *Avena*. Now in *Avena* response occurs first near the apex of the coleoptile, and gradually successive basal zones become involved in the bending. Thus the reaction time is different for different parts of the coleoptile and hypocotyl; and Tröndle finds that the reaction time for any particular zone is proportional to its distance from the apex of the coleoptile, so that at the apex the reaction time will be theoretically zero. Now in roots the responding portion is *not* also sensitive, at any rate to gravity, though Newcombe ('09) and Jost ('12) have shown that it is sensitive to more powerful stimuli, such as prolonged centrifugal forces. Thus for radicles reaction time would appear to be necessarily a definite period; and presentation time would be the least period of stimulation, the effects of which do not die out before the expiration of the reaction time.

It is true that Czapek, Bach, Pekelharing, and Rütgers also worked considerably with members in which the sensitive portion was also capable of response, and what value can be attached to their results will no doubt be ascertained by further researches of these investigators. Since, however, this paper is only concerned with radicles, it is unnecessary to deal generally with the subject of presentation time.

In determining the presentation time for radicles of *Helianthus* (see above, p. 746) it was found that in each experiment some radicles responded markedly, bending at right angles or beyond, while others did not bend at all. The presentation time was reckoned as that exposure which caused a noticeable bend in half the roots experimented on.

Thus the individual differences between different roots present another source of difficulty. It was found that some roots responded to the exposure of 3 min., whilst others showed no inclination to bend after an exposure of 10 min. One differs from another in delicacy of response as much as an expert athlete differs from the slowest 'hobbledehoy'. Yet reaction and presentation times have been worked out for different angles

of inclination, different temperatures, &c., by taking a dozen or so seedlings for each experiment, with the trust that differences between individuals will neutralize out when an average is taken. Tables of results can of course be made out from these experiments, and graphs drawn, but it shows a trustfulness amounting to credulity when a mathematically-minded investigator seriously deduces from such a graph that Reaction time =  $\frac{\text{Constant}}{150 \sqrt{\sin a}}$ , where  $a$  is the angle of inclination to the vertical at which the plant-member is placed.<sup>1</sup>

But fortunately there is another method of work by which this difficulty of the individual differences can be overcome. This is to expose one and the same seedling alternately to two opposing stimuli so as to let the effects of the opposing stimuli neutralize each other in the plant. The relative values of the two stimuli can then be reckoned from the relative times during which they have acted. The principle of this method was employed by Newcombe ('05), Fitting ('05), Haynes ('05), and later by Maillefer ('09).

By means of his intermittent clinostat, Fitting showed that a hypocotyl exposed to the stimulus of gravity, alternately horizontal for a time  $t$ , and at an angle  $\theta$  to the horizontal for a time  $t'$  remained straight when  $\frac{t}{t'} = \cos \theta$ . Now if the letters  $s + s'$  be made to stand for the gravitational stimulus acting at right angles to the hypocotyl in the two positions, then  $\frac{s'}{s} = \cos \theta$ . Thus  $\frac{s'}{s} = \frac{t}{t'}$  or  $s.t = s'.t'$ , when the times are so arranged that the stimuli produce a state of equilibrium in the plant.

Now though Fitting saw this relationship quite clearly, he did not insist on it, in view of the fact that the result might be read in other ways. Thus suppose  $\theta = 45^\circ$ ; on any theory of graviperception the effect of a stimulus acting at  $45^\circ$  to the long axis of the hypocotyl must be different from the stimulus acting at right angles to it, and the difference between the two stimuli is not only quantitative, but also qualitative.<sup>2</sup>

Maillefer ('09) applied the principle of alternation of opposing stimulations to centrifugal forces, and within rather narrow limits obtained results similar to those shown in this paper.<sup>3</sup> He did not deal with centrifugal forces higher than 2.071 mg. and he used a centrifugal wheel which rotated

<sup>1</sup> Maillefer ('09).

<sup>2</sup> 'Aus der Tatsache, dass die geotropischen Erregungen sich annähernd verhalten wie die Sinus der Ablenkungswinkel, darf man nicht den Schluss ziehen, dass nur die auf der Längsachse des Sprosses rechtwinklige Komponente für die Krümmung in Betracht kommt. Diese Tatsache dürfte vielmehr nur aus den Beziehungen zwischen den Reizzuständen, die in verschiedenen Ablenkungswinkeln geschaffen werden, erklärt werden können. Manches spricht dafür, dass diese Reizzustände nicht nur quantitativ, sondern auch qualitativ verschieden sind.'—Fitting ('05), p. 395.

<sup>3</sup> I did not know of Maillefer's paper till all my results had been obtained.

in the vertical plane. Such an instrument is open to the serious objection that the plant-members are not subjected to a constant centrifugal force. For at the bottom of each rotation gravity works with the centrifugal force (giving resultant  $C + mg$ ); at the top of each rotation gravity works in opposition to the centrifugal force (giving resultant  $C - mg$ ); whilst in intervening positions gravity and the centrifugal force work at an angle to each other producing a resultant which is not directed along a radius of the circle of rotation. Thus when  $C$  is less than  $mg$ , the resultant force at the top of a rotation acts *towards* the centre of the wheel.

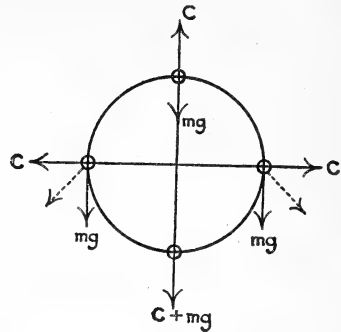

Pekelharing ('10, pp. 290, 303) has shown that the presentation time for centrifugal forces is the same whether the seedlings be placed on a centrifuge with horizontal or vertical axis. But Maillefer has not really proved that 'pour que l'induction géotropique produite par une force  $f_1$  soit égale à l'induction produite par une force  $f_2$ , il faut que le rapport  $\frac{f_1}{f_2}$  soit égal au rapport  $\frac{t_2}{t_1}$  des temps pendant lesquels les forces agissent', because his forces  $f_1$  and  $f_2$  were not constant, but vary with each position in each revolution. Also when  $f_1$  or  $f_2$  is less than  $mg$  in his experiments, then since  $f - mg$  will be negative, the force is really a mixture of positive and negative forces.

In the experiments described in this paper the radicles were subjected to alternating forces which always acted at right angles to the radicles and in opposite directions to each other. One of the alternating forces was always gravity and the other was a centrifugal force between  $3 mg.$  and  $21 mg.$  The results obtained show definitely that if gravity acts for time  $t$  and the centrifugal force for time  $T$ , then the radicles remain straight so long as  $\frac{C}{mg} = \frac{t}{T}$  or  $CT = mg.t$ . Or, expressing this generally, if  $s$  and  $s'$  are two stimulating forces acting at right angles to the radicles for alternating periods of  $t$  and  $t'$ , then when equilibrium is maintained  $s.t = s'.t'$ , i. e. the amount of stimulus in  $mg.$  seconds is the same in each direction (cf. Maillefer, '09, and Pekelharing, '10).<sup>1</sup>

Since, in the present chaotic state of the science of geotropism, we do

<sup>1</sup> Pekelharing states the law as follows:—'Das Produkt von wirkender Kraft und Reizzeit ist konstant.' She notes that this 'Produktregel' has been proved for four cases:—(1) Fitting: Intermittent stimulation at different angles of inclination; (2) Pekelharing: Presentation time at different angles; (3) Maillefer: Intermittent stimulation with different centrifugal forces; (4) Pekelharing: Presentation time with different centrifugal forces.

not even know whether presentation time and reaction time have any objective meaning, it came as rather a relief to find that in the experiments recorded in this paper, we have to deal with periods which far exceed the presentation time, as determined in the usual way, for *Helianthus* radicles. Thus in most of the experiments recorded in Table I there can be no doubt that each interval of exposure to gravity or centrifugal force had been fully perceived by the radicles, and the machinery had been set going which would normally result in response alternately in the two directions. In this case one of two things must have happened; either neutralization took place in the motor mechanism so that no movement actually became expressed, or movement may actually have occurred first in one direction and then in the other, and so on in alternation. It is the second of these alternatives, as will be seen below, which most satisfactorily corresponds to the facts.

Zielinski ('11) introduced the term 'kritische Zeit' to stand for the shortest period of stimulation, the response to which is not inhibited by an exactly similar equal-timed stimulation in the opposite direction following immediately after. To quote Zielinski's tables for the radicles of two plants:

	Temp.	Pres. Time.	Critical Time.	Reaction Time.
<i>Lepidium sativum</i>	17°-18° C.	5.5 min.	6 min.	25.5 min.
" "	25°-27° C.	1.5 "	2 "	12.5 "
<i>Lupinus albus</i>	17°-18° C.	8.5 "	11 "	46.5 "
" "	25°-27° C.	2 "	7 "	3.3 "

This means that if a radicle of *Lepidium sativum* be kept at a temperature of 17°-18° C. and be placed horizontally for 5.6 min. and then be turned through 180° and be kept horizontal again for 5.6 min. no movement is noticeable. Whereas, if it be kept for 7 min. in each position, a movement is noticeable first in one direction and then in the other.

The critical time for *Helianthus* has not been determined; but since the presentation time for the temperature at which my experiments were carried out is less than 5 min., the critical time is almost certainly less than 10 min. Thus in cases such as Experiment 14, there can be no reasonable doubt that the radicles actually moved during the course of the experiment first in one direction and then in the other, and so on in alternation, and that *the ultimate equilibrium was due to the neutralization of actual movements.*

Now suppose for any such experiment the centrifugal force working for time  $T$  and gravity working for time  $t$  neutralize each other when alternated, then since movement has actually taken place in response to each single stimulus the amount of response that took place to  $C$  acting for time  $T$  must have been equal to the amount of response that took place to  $mg$ . acting for time  $t$ .

But the experiments described above have shown that under these circumstances  $CT = mg.t$ , and each of these quantities is of the form  $S.t$

where  $S$  is the value of the stimulating force in terms of  $mg$ , and  $t$  is the number of seconds during which it acts. Thus the conclusion is reached that *in any given radicle a constant amount of response takes place to a stimulus of a given number of  $mg$ . sec. units, however this number may be made up, so long as the time of exposure to the stimulus is not long.*

This last reservation will be understood by reference to Tables I and II, from which it will be seen that for *Helianthus* radicles the statement is true so long as each single exposure to the stimulus of gravity does not exceed fifteen minutes, and the exposure to a centrifugal force is correspondingly small. The fact that the law does not hold good for longer induction periods becomes explicable, as shown above, from the discovery of Jost and Stoppel ('12) that roots respond negatively to prolonged stimulation by high centrifugal forces.

This result is in contradiction to Pekelharing's conclusions. She found that the geotropic response in coleoptiles displaced  $171^\circ$  from the normal was less than that in coleoptiles displaced  $5^\circ$  from the normal, though in the former position the stimulus acting at right angles to the coleoptiles was greater than in the latter. She continues: 'aus diesen Mitteilungen geht aber hervor, dass die alten Untersuchungen über die Reaktionskrümmungen nicht mehr zu gebrauchen sind, und meine Erfahrung warnt vor der Hypothese *dass gleich grosse Reize auch gleich grosse Krümmungen verursachen würden.* Augenscheinlich hängen diese Krümmungen nicht nur von Reizintensität und Reizdauer, sondern auch noch von einem oder mehreren, uns bis jetzt unbekanntem Faktoren ab.' (Italics are mine.)

The hypothesis, italicized in the above quotation, against which Pekelharing warns us, has, however, been proved to be true for the case of centrifugal forces by the results of the present research.

#### SUMMARY.

1. A comparison of the value of different degrees of centrifugal force as geotropic stimuli was obtained by the method of continued alternation of short-timed exposures to gravity and a centrifugal force in opposite directions. A machine was constructed to accomplish this alternation by which centrifugal forces up to  $21 mg$ . could be obtained. The centrifugal 'wheel' rotated in the horizontal plane and was driven by an electric motor. A description of this machine is given in the text.

2. The seedlings were pinned to the back of a box, which automatically took up a nearly horizontal position when the 'wheel' was rotating. Thus the radicles on the outer side of the box were subjected to a higher centrifugal force than those towards the inner side. If the exposures to the centrifugal force were neutralized by the alternated opposing exposures to gravity at a certain point in the box, the radicles at this point would not

bend. Those, however, which were further out in the box would bend outwards, and those further in would bend inwards. Thus a point of equilibrium could be determined with very fair accuracy, and the centrifugal force at this point of equilibrium could be deduced from the number of rotations made by the wheel in a known time and the radius of rotation of the point of equilibrium.

3. It was found that if a centrifugal force  $C$ , working for a time  $T$ , be regularly alternated with gravity ( $mg$ .) working for a time  $t$ , then equilibrium is only established when  $\frac{CT}{mg.t} = 1$ . (The actual value of  $\frac{CT}{mg.t}$  as deduced from the average of eighteen successful experiments with radicles of *Helianthus annuus* was 0.99.)

This equation may be expressed thus:  $CT = mg.t$ , i. e. the product of the force into the time in each direction is the same. The average experimental value of  $\frac{CT}{mg.t}$  for six experiments with radicles of *Cucurbita Pepo* was 0.97.

4. The equation  $\frac{CT}{mg.t} = 1$  does not hold good if the individual periods of exposure to gravity and centrifugal force are long. When  $(T+t)$  was as much as 20 min. it was found that for the point of equilibrium  $\frac{CT}{mg.t} > 1$ ; i. e. the centrifugal force had to be allowed to act for a longer time than would have been expected from previous experiments. This is probably connected with the fact, discovered by Jost and Stoppel, that radicles may respond negatively to prolonged exposure to centrifugal forces. Though, in the case of the present experiments, the period of exposure was not sufficiently long to cause a negative response, it may nevertheless have been sufficient to allow of a falling-off in the activity of the positive response.

5. The presentation time for *Helianthus* radicles was determined in the usual way, and was found to lie between 3 and  $4\frac{1}{2}$  min., at a temperature of  $18^{\circ}$ – $20^{\circ}$  C.

On the intermittent centrifuge, single exposures to gravity might be much longer than this without any failure of the equation  $\frac{CT}{mg.t} = 1$ .

6. From theoretical considerations it is clear that, at any rate in many of the experiments, actual movement must have taken place in response both to gravity and to the centrifugal force; but as the movement was of equal extent in each direction, there was no resultant bending. From this fact it is deduced that a given small amount of stimulation, reckoned in mg. sec. units, produces the same amount of response in a given radicle, however the amount of stimulation may be made up. For instance,



a stimulus of 10 mg. acting for 1 min. produces the same amount of response as a stimulus of 1 mg. acting for 10 min. On the other hand, as stated in § 4, it is found that a stimulus of 10 mg. acting for 3 min. does not produce so great a bend as a stimulus of 1 mg. acting for 30 min.

In conclusion I desire to express my thanks to Professor S. H. Vines for his constant help and encouragement in the course of this work.

## LITERATURE CITED.

- ANDREWS, F. M. ('03): Die Wirkung der Centrifugalkraft auf Pflanzen. *Jahrb. f. wiss. Bot.*, xxxviii, 1.
- ARISZ, W. H. ('11): On the Connection between Stimulus and Effect in Phototropic Curvatures of Seedlings of *Avena sativa*. *Proc. of the Sect. of Sciences. Konink. Akad. Wet.*, vol. xiii, p. 1022.
- BACH, H. ('07): Über die Abhängigkeit der geotropischen Präsentations- und Reaktionszeit von verschiedenen Aussenbedingungen. *Jahrb. f. wiss. Bot.*, xlv, 57.
- BLAAUW, A. H., and WENT, F. W. C. ('08): On the Investigation of Mr. A. H. Blaauw on the Relation between the intensity of Light and the Length of Illumination on the Phototropic Curvatures in Seedlings of *Avena sativa*. *Proc. of the Sect. of Sciences. Konink. Akad. Wet.*, vol. xi, p. 230.
- BUDER, J. ('08): Untersuchungen zur Statolithenhypothese. *Ber. der Deut. Bot. Ges.*, xxvi. (Festschrift), 162.
- CZAPEK, F. ('95): Untersuchungen über Geotropismus. *Jahrb. f. wiss. Bot.*, xxvii, 243.
- ('98): Weitere Beiträge zur Kenntniss der geotropischen Reizbewegungen. *Jahrb. f. wiss. Bot.*, xxxii, 175.
- ELFVING, L. ('80): Beitrag zur Kenntniss der Einwirk. d. Schwerkraft auf die Pflanzen. *Sep.-Abdr. aus Acta Soc. Scient. Fennic.*, xii, 33.
- FITTING, H. ('05): Untersuchungen über den geotropischen Reizvorgang. *Jahrb. f. wiss. Bot.*, xli, 221.
- GILTAY, E. ('10): Einige Betrachtungen und Versuche über Grundfragen beim Geotropismus der Wurzel. *Zeitschr. f. Bot.*, ii, 305.
- HABERLANDT, G. ('03): Zur Statolithentheorie des Geotropismus. *Jahrb. f. wiss. Bot.*, xxxviii, 447.
- HAYNES, J. A. ('05): The Angle of Deviation from the Normal Vertical Position at which Stems show the Strongest Geotropic Response. *Amer. Naturalist*, vol. xxxix, p. 77.
- HEILBRONN, A. L. ('12): Über Plasmaströmungen und deren Beziehung zur Bewegung umlagerungsfähiger Stärke. *Berichte d. Deut. Bot. Ges.*, xxx, 142.
- JOST, L. ('12): Die Verteilung der geotropischen Sensibilität in der Wurzelspitze. *Zeitschr. f. Bot.*, iv, 161.
- JOST, L., and STOPPEL, R. ('12): Die Veränderung der geotropischen Reaktion durch Schleuderkraft. *Zeitschr. f. Bot.*, iv, 206.
- KNIGHT, T. A. (1806): (Selection from his *Physiological and Horticultural Papers*, 1841.) Paper VII: On the Direction of the Radicle and Germen during the Vegetation of Seeds.
- KÜSTER, E. ('04): Beiträge zur Kenntniss der Wurzel- und Sprossbildung an Stecklingen. *Jahrb. f. wiss. Bot.*, xl, 279.
- MAILLEFER, A. ('09): Étude sur le géotropisme. *Bull. de la Soc. Vaudoise des Sc. Nat.*, vol. xlv, p. 277.
- ('10): Étude sur la réaction géotrope. *Bull. de la Soc. Vaudoise des Sc. Nat.*, vol. xlvi, p. 235.

- NEWCOMBE, F. C. ('05): Geotropic Response at various Angles of Inclination. *Ann. Bot.*, vol. xix, p. 311.
- ('09): Gravitation Sensitiveness not confined to Apex of Root. *Beihefte z. Bot. Centralbl.*, xxiv. 96.
- PAÁL, ÁRPÁD ('11): Analyse des geotropischen Reizvorganges mittels Luftverdünnung. *Jahrb. f. wiss. Bot.*, l. 1.
- PEKELHARING, C. J. ('09): Investigations on the Relation between the Presentation Time and Intensity of Stimulus in Geotropic Curvatures. *Proc. of the Sect. of Sciences. Konink. Akad. v. Wet.*, Amsterdam, vol. xii, p. 65.
- PEKELHARING, C. J. (RUTTEN) ('10): Untersuchungen über die Perzeption des Schwerkraftreizes. *Recueil des Trav. Bot. Néerlandais*, vol. vii, p. 241.
- PFEFFER, W. ('97): *Physiology of Plants*. Eng. Ed. by A. J. Ewart, Clarendon Press.
- POLOWZOW, W. ('09): Untersuchungen über Reizerscheinungen bei den Pflanzen. *Jena*.
- PRINGSHEIM, E. G. ('12): *Die Reizbewegungen der Pflanzen*. Berlin.
- RÜTGERS, A. A. L. ('10): The Influence of Temperature on the Presentation time in Geotropism. *Proc. of the Sect. of Sciences. Konink. Akad. v. Wet.*, Amsterdam, vol. xii, p. 476.
- SACHS, J. ('74): Über das Wachstum der Haupt- und Nebenwurzeln. *Arbeiten d. bot. Inst. in Würzb* ur. 557 .
- SCHWARZ, FR. ('81): Der Einfluss der Schwerkraft auf das Längenwachsthum der Pflanzen. *Untersuch. a. d. Bot. Inst. zu Tübingen*.
- TRÖNDLE, A. ('13): Der zeitliche Verlauf der geotropischen Reaktion und die Verteilung der geotropischen Sensibilität in der Koleoptile. *Jahrb. f. wiss. Bot.*, lii. 186.
- WIGAND, A. ('54): *Bot. Untersuchungen*. Braunschweig.
- ZIELINSKI, F. F. ('11): Über die gegenseitige Abhängigkeit geotropischer Reizmomente. *Zeitschr. f. Bot.*, iii.

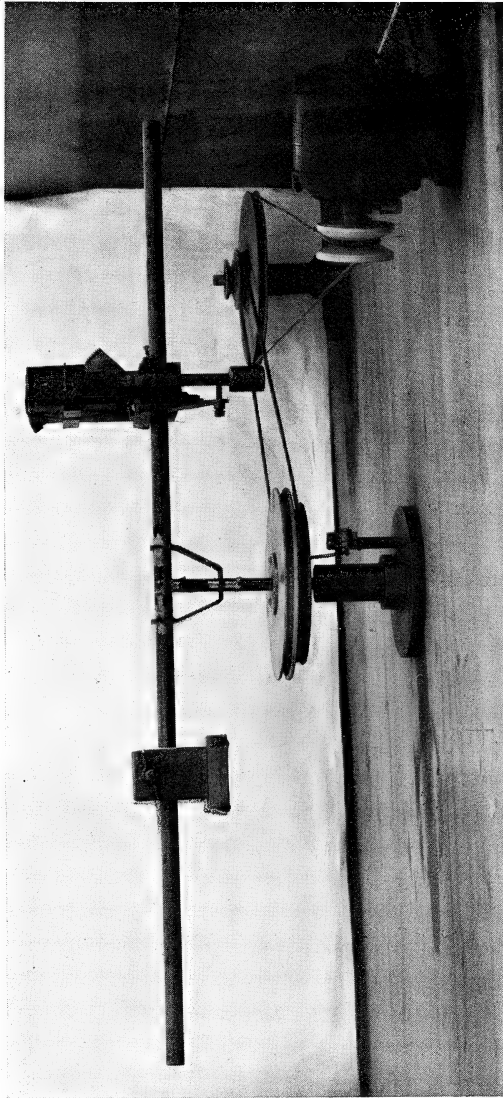

FIG. 4.

HILEY—CENTRIFUGAL FORCE



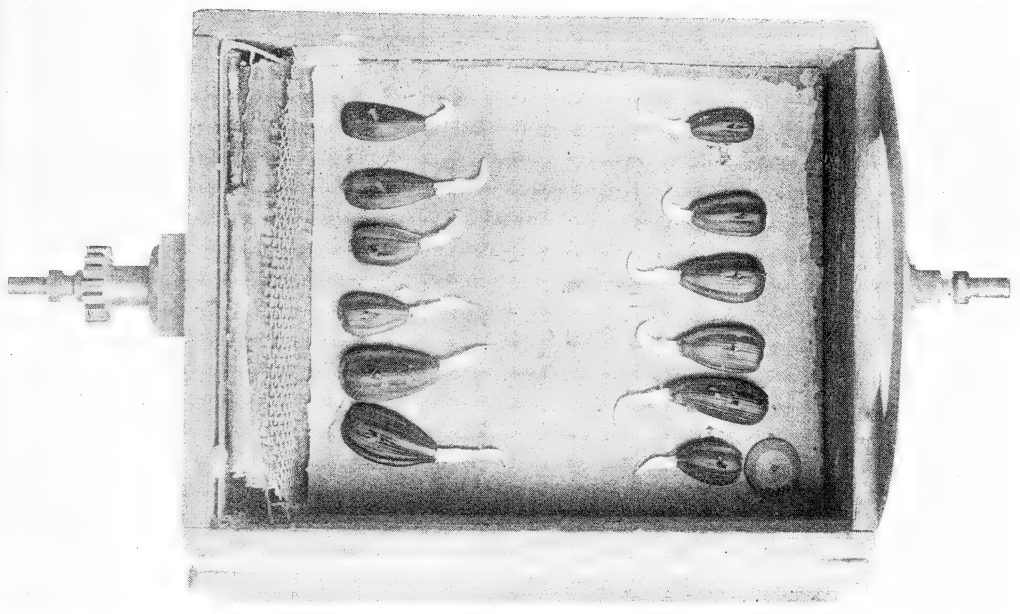

FIG. 6.

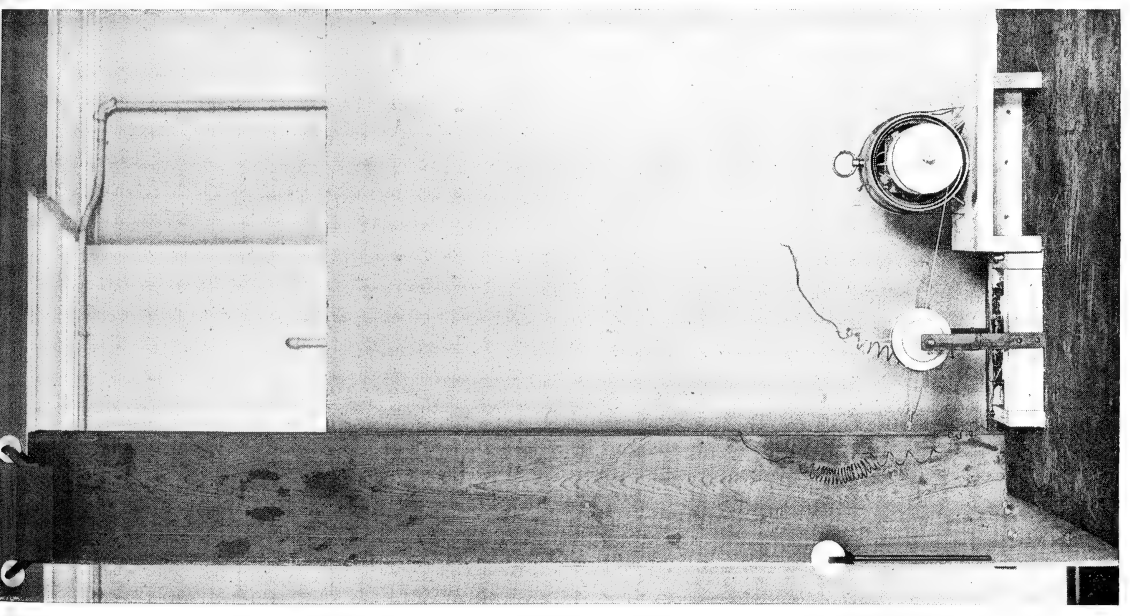

FIG. 5.



# On Diurnal Variation of Moto-excitability in Mimosa.

BY

J. C. BOSE, M.A., D.Sc., C.S.I.

*Professor, Presidency College, Calcutta.*

With seventeen Figures in the Text.

SEVERAL phenomena of daily periodicity are known, but the relations between the recurrent external changes and the resulting periodic variations are more or less obscure. As an example of this may be cited the periodic variation of growth. Here the daily periodicity exhibited by a plant is not only different in varying seasons, but it also differs in diverse species of plants. The complexity of the problem is very great, for not only are the direct effects of the changing environment to be taken into consideration, but also their unknown after-effects. Even in the case of direct effect, different factors, such as light, temperature, turgor, and so on, are undergoing independent variations; it may thus happen that their reactions may sometimes be concordant and at other times discordant. The nyctitropic movement of plants affords another example of daily periodicity. The fanciful name of 'sleep' is often given to the closure of the leaflets of certain plants at night. The question whether plants sleep or not may be put in the form of the definite inquiry: Is the plant equally excitable throughout day and night? If not, is there any definite period at which it practically loses its excitability? Is there, again, another period at which the plant wakes up, as it were, to a condition of maximum excitability?

In the course of my investigations on the irritability of *Mimosa pudica*, I became aware of the existence of such a daily periodicity; that is to say, the moto-excitability was found to be markedly diminished or even completely abolished at a certain definite period of the day; at another equally definite period, the excitability was observed to have attained its climax. The observations on the periodic variation of excitability appeared at first to be extremely puzzling. It might be thought, for example, that light would prove to be favourable for moto-excitability; in actual experiment the results apparently contradicted such a supposition: for the excitability of the plant was found much higher in the evening than in the morning. Favourable temperature, again, might be regarded as an important factor

for the enhancement of the moto-excitability; it was, nevertheless, found that though the excitatory response was only moderate at that period of night when the temperature was at its minimum, yet the excitability was altogether abolished at another period when the temperature was several degrees higher. The obscurities which surrounded the subject were only removed as a result of protracted investigation and comparison of continuous automatic records made by the plant itself during several months, beginning with winter and ending in summer.

The question whether a plant like *Mimosa* exhibits diurnal variation of excitability can be experimentally investigated by subjecting the plant at every hour of the day and night to a test-stimulus of uniform intensity, and

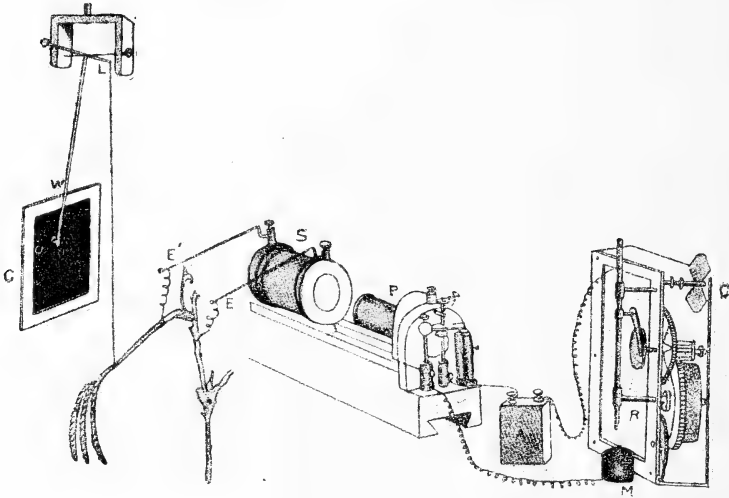

FIG. 1. Diagrammatic representation of the complete apparatus for determination of diurnal variation of excitability. Petiole of *Mimosa*, attached by thread to one arm of lever L; writing index W traces on smoked glass plate G the responsive fall and recovery of leaf. P, primary, and S, secondary, of induction coil. Exciting induction passes through the plant by electrodes E, E'. A, accumulator. C, clockwork for regulating duration of tetanizing shock. Primary circuit of coil completed by plunging rod R dipping into cup of mercury M.

obtaining the corresponding mechanical responses. Under these circumstances the amplitude of response at any time will serve as a measure of the excitability of the plant at the particular time. Any periodic fluctuation of response will then demonstrate the periodic character of variation of excitability.

The investigation thus resolves itself into—

1. The successful construction of a Response Recorder which will automatically record the response of the plant to uniform periodic stimulation at all hours of day or night;
2. The study of the effects of various external conditions on excitability;



3. The diurnal variation of excitability and its relation to the changes of external conditions.

I will first give a diagrammatic view of the different parts of the apparatus which I devised for this investigation. The leaf of *Mimosa* is attached to one arm of a light aluminium lever, L, by means of thread. At right angles to the lever is the writing index, W, which traces on a smoked glass plate, allowed to fall at a definite rate by clockwork, the responsive movement of the leaf. Under a definite stimulus of electric shock the leaf falls down, pulling the lever L, and moving the writer towards the left. The amplitude of this response-curve measures the intensity of excitation. The leaf re-erects itself after a time, the corresponding record exhibiting recovery. A second stimulus is applied after a definite interval, say an hour, and the corresponding response shows whether the excitability of the plant has remained constant or undergone any variation.

#### I. (a) UNIFORM PERIODIC STIMULATION.

*Electric mode of excitation.* I find that one of the best methods of stimulating the plant is by means of tetanizing induction shock. The sensitiveness of *Mimosa* to electric stimulation is very great; the plant often responds to a shock which is quite imperceptible to a human subject. By the employment of a sliding induction coil, the intensity of the shock can be regulated with great accuracy; the secondary is gradually brought nearer the primary till a stimulus is found which is minimally effective. The intensity of stimulus actually employed is slightly higher than this, but within the sub-maximal range. When the testing stimulus is maintained constant and of sub-maximal intensity, then any variation of excitability is attended by a corresponding variation in the amplitude of response.

The exciting value of a tetanizing electric shock depends (1) on the intensity, (2) on the duration of shock. The intensity may be rendered uniform by placing the secondary at a fixed distance from the primary, and keeping the current in the primary circuit constant. The constancy of the primary circuit is secured by the employment of an accumulator or storage cell of definite electromotive force. It is far more difficult to secure the constant duration of the tetanizing shock in successive stimulations at intervals of, say, one hour during twenty-four hours. The duration of the induction shock given by the secondary coil depends on the length of time during which the primary circuit is completed in successive excitations. I have succeeded in overcoming the difficulty of securing uniformity of duration of shock by the employment of a special clockwork device.

*The clockwork plunger.* The alarm clock can be so arranged that a wheel is suddenly released and allowed to complete one rapid revolution at intervals of, say, one hour. There is a fan-governor by which the speed of the revolution can be regulated and maintained constant. This will specially

be the case when the alarm spring is long and fully wound. The successions of short release, twenty-four times during the day, produce relatively little unwinding of the spring. On account of this and the presence of the fan-governor, the period of a single revolution of the wheel remains constant. By means of an eccentric the circular movement is converted into an up and down movement. The plunging rod R thus dips into a cup of mercury, M, for a definite short interval (Fig. 1) and is then lifted off. The duration of closure can be regulated by raising or lowering the cup of mercury. In practice the duration of tetanizing shock is about 0.2 second.

The same clock performs three distinct functions. The axis which revolves once in twelve hours has attached to it a wheel, and round this is wound a thread which allows the recording glass plate to fall through six inches in the course of twenty-four hours (Fig. 2). A spoke attached to the minute hand releases the alarm at regular and predetermined intervals of time, say once in an hour. The plunging rod R, actuated by the eccentric, causes a tetanizing shock of uniform intensity and duration to be given to the plant at specified times.

*Constancy of resistance in the secondary circuit.* In order that the testing electric stimulus shall remain uniform, another condition has to be fulfilled, namely, the maintenance of constancy of resistance in the secondary circuit, including the plant. Electric connexions have to be made with the latter by means of cloth moistened with dilute salt solution; drying of the salt solution, however, gives rise to a variation of resistance in the electrolytic contact. This difficulty is overcome by making the electrolytic resistance negligible compared to the resistance offered by the plant. Thin and flexible spirals of silver tinsel attached to the electrodes E, E' are tied round the petiole and the stem respectively. In order to secure better electric contact, a small strip of cloth moistened with dilute salt and glycerine is wound round the tinsel. As the resistance of contact is relatively small, and as drying is to a great extent retarded by glycerine, the total resistance of the secondary circuit undergoes practically no variation in the course of twenty-four hours. This will be seen from the following data: An experiment was commenced one day at 1 p.m., when the resistance offered by 8 cm. length of stem and 2 cm. length of petiole was found to be 1.5 million ohms. After twenty-four hours' record, the resistance was measured the next day and was found unchanged. The fact that the stimulus remains perfectly uniform will be quite apparent when the records given in the course of this paper are examined in detail.

#### I. (b) THE RESPONSE RECORDER.

The amplitude of response affords, as we have seen, a measure of the excitability of the plant. In actual record friction of the writer against the glass surface becomes a source of error. This difficulty I have been able to

overcome by the two independent devices, the Resonant Recorder<sup>1</sup> and the Oscillating Recorder. In the former the writer is maintained by electric means in a state of continuous to and fro vibration, about ten times in a second. There is thus no continuous contact between the writer and the smoked glass surface, friction being thereby practically eliminated. The writer in this case taps a record, the successive dots occurring at intervals of  $\cdot 1$  second. The responsive fall of the leaf is rapid, hence the successive dots in this part of the record are widely spaced; but the erection of the leaf during recovery takes place slowly, hence the recovery part of the curve appears continuous on account of the superposition of the successive dots. The advantage of the Resonant Recorder is that the curve exhibits both response and recovery. This apparatus is admirably suited for experiments which last for a few hours. There is, however, some drawback to its use in experiments which are continued for days together. This will be understood when we remember that for the maintenance of 10 vibrations of the writer in a second, 10 electric contacts have to be made; in other words, 36,000 intermittent electric

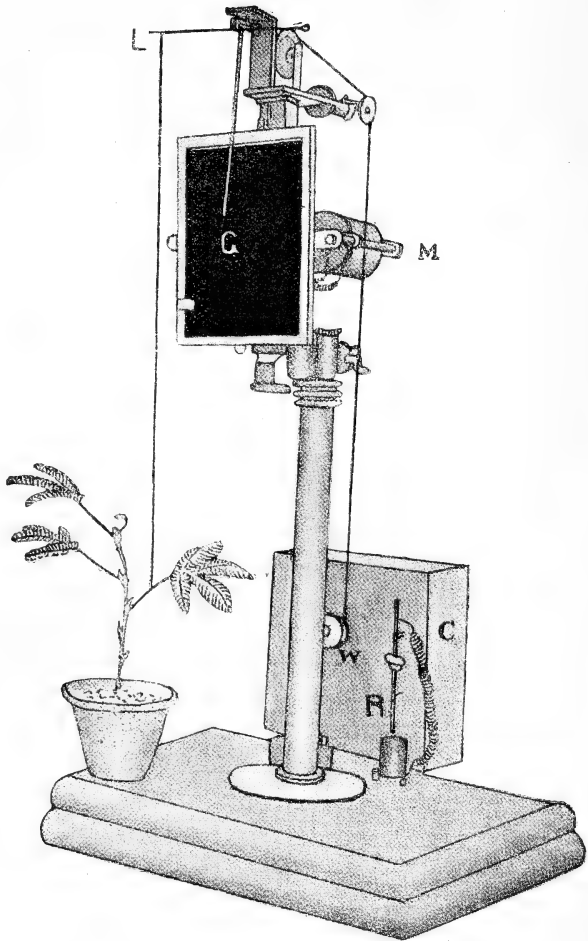

FIG. 2. The Oscillating Recorder. Petiole attached to one arm of lever L by thread. The writer traces response-record on glass plate G, which falls at definite rate by unwinding of the clock wheel W. M, magnetic device for maintaining to and fro oscillation of recording plate. R, plunging rod for periodic closure of exciting current. C, clockwork.

<sup>1</sup> A complete account of the former is given in my paper 'On an Automatic Method of Investigation of the Velocity of Transmission of Excitation in *Mimosa*', read before the Royal Society, March 6, 1913 (Phil. Trans., B, No. 305, vol. 204).

currents have to be kept up per hour. This necessitates the employment of an electric accumulator having a very large capacity.

In the Oscillating Recorder the recording plate itself moves to and fro, making intermittent contact with the writer, about once in a minute. In Fig. 2 is given an illustration of the apparatus, reduced to one-fourth the actual size. The recording smoked glass plate is allowed to fall at a definite rate by the unwinding of the clock wheel *w*. The same clockwork, acting on an arrangement of alarm, previously described, causes, by means of the plunging rod *R*, periodic closures of the exciting circuit for a definite duration.

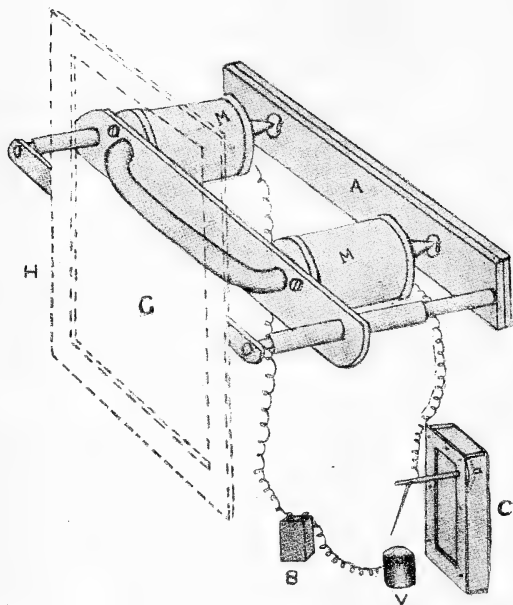

FIG. 3. The Oscillator. Electromagnet *M*, *M'*, periodically magnetized by completion of electric current by clockwork *C*. Periodic attraction of soft iron armature *A* moves attached glass plate to left, making thereby electric contact with writer.

Under normal conditions, the plate-holder is held by suitable springs, somewhat to the right of, and free from contact with, the writer. A clockwork *C* carries a rotating arm, which makes periodic contact with a pool of mercury contained in the vessel *V*, once in a minute. On the completion of the electromagnetic circuit, the armature *A* is attracted, the recording glass plate being thereby moved to the left, making contact with the writer. The successive dots in the record thus take place at intervals of a minute. Only a moderate amount of electric current is thus consumed in maintaining the oscillation of the plate. A 4-volt storage cell of 20 amperes capacity is quite sufficient to work the apparatus for several days.

The responsive fall of the leaf of *Mimosa* is completed in the course of about two seconds. The leaf remains in the fallen or 'contracted' position

*M* is an electromagnetic arrangement by which the holder of the smoked glass plate is made to oscillate to and fro, causing periodic contact with the writer.

The Oscillator is diagrammatically shown in Fig. 3. *M*, *M'* are the two electromagnetic coils, the free ends of the horseshoe being pointed. Facing them are the conical holes of the soft iron armature *A*. This armature carries two rods which slide through hollow tubes. The distal ends of the rods support the holder *H*, carrying the smoked glass plate. Under normal conditions, the plate-holder is held by suitable springs, somewhat to the right of, and free from contact with, the

for nearly fifteen seconds; it then begins to recover slowly. As the successive dots of the Oscillating Recorder are at intervals of a minute, the maximum fall of leaf is accomplished between two successive dots. The dotted response record here obtained exhibits the recovery from maximum fall under stimulation (cf. Fig. 11). The recovery of the leaf in one minute is less than one-tenth the total amplitude of the fall, and is proportionately the same in all the response records. Hence the successive amplitudes of response curves that are recorded at different hours of the day afford us measures of the relative variations of excitability of the plant at different times. This enables us to demonstrate the reality of diurnal variation of excitability. In my experimental investigations on the subject I have not been content to take my data from any particular method of obtaining response, but have employed both types of recorders, the Resonant and Oscillating. It will be shown that the results given by the different instruments are in complete agreement with each other.

## II. EFFECTS OF EXTERNAL CONDITIONS ON EXCITABILITY.

Before giving the daily records exhibiting periodicity of excitability, I will give my experimental results on the influence of various external conditions in modifying excitability. The conditions which are likely to affect excitability and induce periodicity are, first, the effects of light and darkness: under natural conditions the plant is subjected in the morning to the changing condition from darkness to light; then to the action of continued light during the day; and in the evening to the changing condition from light to darkness. A second periodic factor is the change in the condition of turgidity, which is at its maximum in the morning, as evidenced by the characteristic erect position of the petiole. Finally, the plant in the course of day and night is subjected to a great variation of temperature. I will now describe the effects of these various factors on excitability. It should be mentioned here that the experiments were carried out about the middle of the day, when the excitability, generally speaking, is found to remain constant.

### (1) Effects of Light and Darkness.

I have frequently noticed that a depression of excitability occurred when the sky was darkened by passing clouds. This is clearly seen in the following records obtained with the Resonant Recorder. Uniform sub-maximal stimuli had been applied to a specimen of *Mimosa* at intervals of fifteen minutes. The dotted up-line represents the responsive fall, and the continuous down-line, the slow recovery. The first four are the normal uniform responses (Fig. 4). The next three show the depressing effect of relative darkness due to cloudy weather. The sky cleared after forty-five minutes, and we notice the consequent restoration of normal excitability.

*Effect of sudden darkness and its continuation.* In the next record (Fig. 5) is shown the immediate and continued action of darkness. The

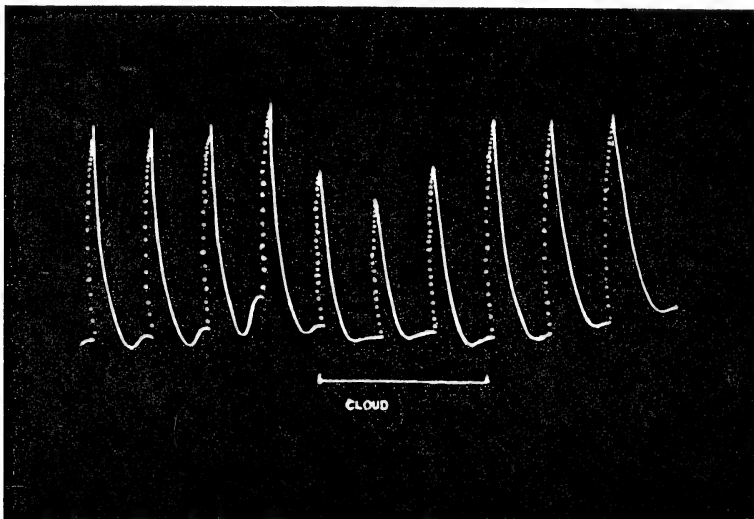

FIG. 4. Effect of cloud. Dotted up-curve indicates responsive fall, and continuous down-line exhibits slow recovery. First four responses normal; next three show depression due to diminution of light brought on by cloud, the duration of which is indicated by horizontal line below. Last three records show restoration of excitability brought on by clearing of sky. All records read from left to right.

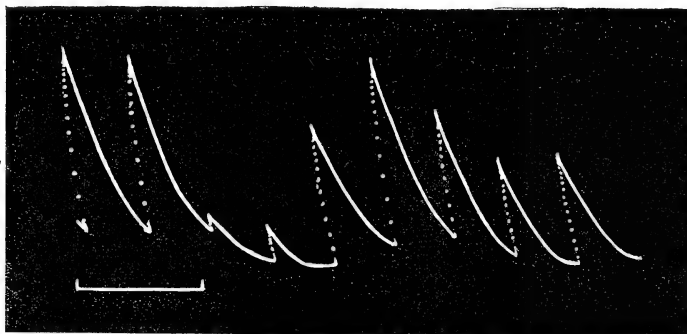

FIG. 5. Effect of sudden darkness. Plant subjected to sudden darkness beyond horizontal line seen below. First two responses normal. Note sudden depression of excitability, revival and final depression under continued darkness.

first two are the normal uniform responses in light. By means of screens, the plant was next subjected to sudden darkness; this brought about a marked depression of excitability. Subjection to sudden darkness thus acts as a stimulus inducing a marked but transient fall of excitability. Under the continuous action of darkness, however, the excitability is at first restored and then undergoes a persistent depression.

*Effect of transition from darkness to light.* Here we have to deal first with the immediate effect of sudden transition, and then with the persistent effect of continuous light. In the record given in Fig. 6 the plant had been kept in the dark and the responses taken in the usual manner. It was then subjected to light; the sudden change from darkness to light acted as a stimulus, inducing a transient depression of excitability. In this connexion it is interesting to note that Godlewski found that in the phenomenon of growth, transition from darkness to light acted as a stimulus,

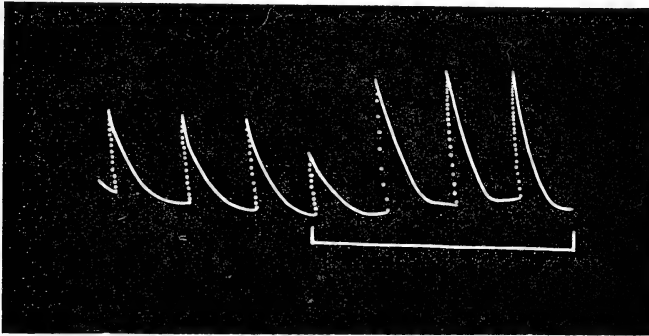

FIG. 6. Effect of change from darkness to light. The first three records are normal under darkness. Horizontal line below indicates exposure to light. Note preliminary depression followed by enhancement of excitability.

causing a transient decrease in the normal rate. The effect of continued light on *Mimosa* is an enhancement of excitability.

## (2) Effect of Enhanced Turgor.

I have often found that the moto-excitability is depressed under excessive turgor. Thus the over-turgid leaf of *Biophytum sensitivum* does not exhibit any mechanical response on rainy days. The effect of excessive turgor on moto-excitability may be demonstrated in the case of *Mimosa* by

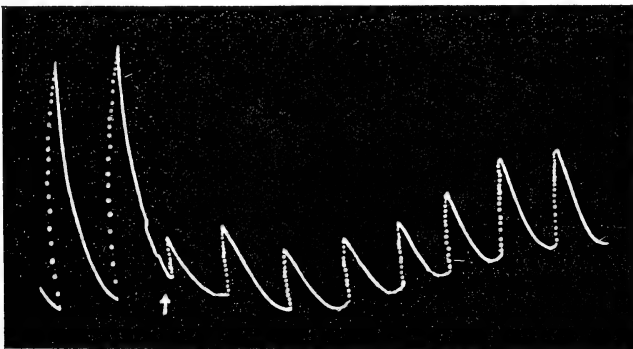

FIG. 7. Effect of enhanced turgor, artificially induced. First two responses normal. Application of water, at arrow, induces depression of moto-excitability.

allowing its main pulvinus to absorb water. The result is seen in the next record (Fig. 7), where water was applied on the pulvinus after the second response. It is seen how a depression of moto-excitability results from excessive turgor brought on by absorption of water. In such cases, however, the plant may accommodate itself to the abnormal condition and gradually regain its normal excitability in the course of several hours.

### (3) Influence of Temperature.

The moto-excitability of the pulvinus of *Mimosa* is greatly modified under the influence of temperature. For the purpose of this investigation I enclosed the plant in a glass chamber, raising the temperature to the desired degree by means of electric heating. Responses to identical stimuli

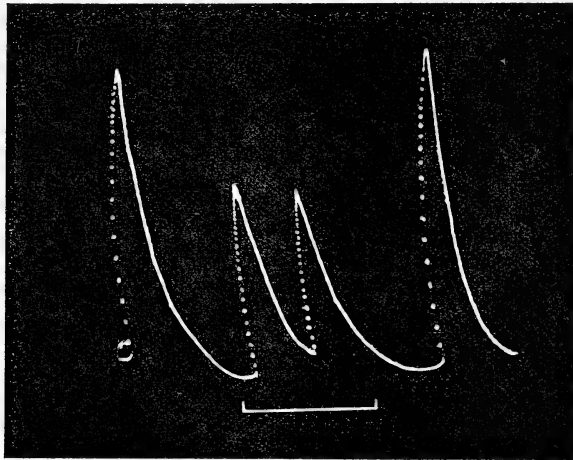

FIG. 8. Effect of moderate cooling during a period shown by horizontal line below. Moderate depression followed by quick restoration.

were then taken at different temperatures. It was found that the effect of heightened temperature, up to an optimum, was to enhance the amplitude of response. Thus with a given specimen it was found that while at  $22^{\circ}\text{C}$ . the amplitude of response was 2.5 mm., it became 22 mm. at  $27^{\circ}\text{C}$ ., and 52 mm. at  $32^{\circ}\text{C}$ .. The excitability is enhanced under rising, and depressed under falling temperature. The moto-excitability of *Mimosa* is practically abolished at a temperature of about  $19^{\circ}\text{C}$ .

*Effect of lowering of temperature.* A simple way of exhibiting the effect of lowering of temperature is by artificial cooling of the pulvinus. This cannot very well be done by application of a stream of cooled water, because, as we have seen, absorption of water by the pulvinus is attended by a loss of excitability: glycerine has, however, no such drawback. This fluid



at ordinary temperature was first applied on the pulvinus, and records were taken in the usual manner. Cooled glycerine was then applied and the record taken once more; the results are seen in Figs. 8 and 9. In the former, the first response was normal at the temperature of the room, which was  $32^{\circ}\text{C}$ .; the next two exhibit depression of excitability under moderate cooling; the duration of application of moderately cooled glycerine is here indicated by the horizontal line below. On the cessation of application, the normal temperature was quickly restored, with the restoration of normal excitability.

In the next record (Fig. 9) is shown the effect of a more intense cold. It will be noticed that the first effect was a depression, and subsequently, a complete abolition of excitability. The thick dots in the record represent applications of stimulus which proved ineffective. It will also be noticed

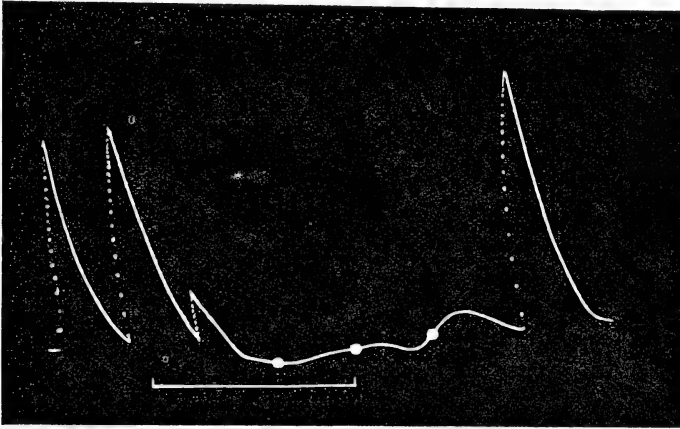

FIG. 9. Effect of application of more intense cold. Note sudden depression followed by abolition of excitability, also persistent after-effect.

that even on the cessation of cooling, and the return of the tissue to normal temperature, the induced abolition of excitability persisted as an after-effect for a considerable time. I have likewise found that the after-effect of cold in abolishing the conduction of excitation is also very persistent. These experiments show that the variations of excitability in the plant often lag considerably behind the external changes which induce them.

*Effect of high temperature.* It has been shown that the moto-excitability is enhanced by rising temperature; there is, however, an optimum temperature above which the excitability undergoes a depression. This is seen in the following record (Fig. 10), where the normal response at  $32^{\circ}\text{C}$ . was depressed on raising the temperature to  $42^{\circ}\text{C}$ .; the excitability was, however, restored when the plant was allowed to regain the former temperature.

I may now briefly recapitulate some of the important results: darkness depresses, and light exalts the moto-excitability. Excessive turgor depresses motility. Still more marked is the effect of temperature. Lowering of temperature depresses and finally abolishes the moto-excitability: rise of temperature enhances it up to an optimum temperature, but beyond this point the excitability undergoes depression. The change in excitability

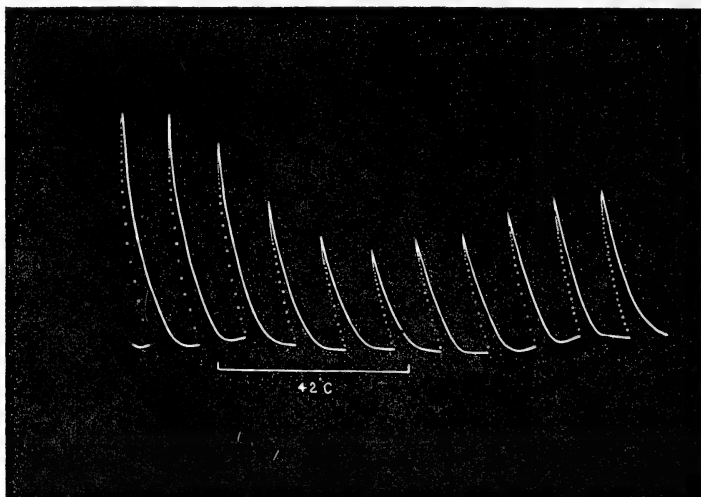

FIG. 10. Effect of temperature above optimum. Note depression of excitability induced by high temperature, and gradual restoration on return to normal.

induced by the variation of external condition is not immediate; the induced effect, generally speaking, lags behind the inducing cause.

### III. DIURNAL VARIATION OF EXCITABILITY.

I will now give automatic records of responses taken once every hour for twenty-four hours. They prove conclusively the diurnal variation of excitability in *Mimosa*. After studying in detail the variations characteristic of particular times of the day, I will endeavour to correlate them with the effects brought on by the periodic changes of the environment.

As a typical example I will first give a record obtained in the month of February, that is, say in spring. From this it will not be difficult to follow the variations which take place earlier in winter or later in summer.

The record given in Fig. 11 was commenced at 5 p.m., and continued to the same hour next day. The first thing noticeable is the periodic displacement of the base-line. This is due to the nyctitropic movements of the leaf. It should be remembered that the up movement of the leaf is represented by down-curve, and *vice versa*. After the maximum fall of the leaf, which in this case was attained at 9 p.m., there followed

a reverse movement: the highest erection, indicative of maximum turgor, was reached at 6 a.m. The leaf then fell slowly and reached a middle position at noon. The extent of the nyctitropic movement varies in individual cases; in some it is slight, in others very large. The erectile movement began, as stated before, at about 9 p.m.; in some cases, however, it may occur as early as 6 p.m.

In following the characteristic variations of response, occurring throughout the day, we find that while they are practically uniform between the hours of 5 and 7 p.m., a continuous decline is manifested after setting in of darkness (6 p.m.); the fall of excitability continues even after sunrise

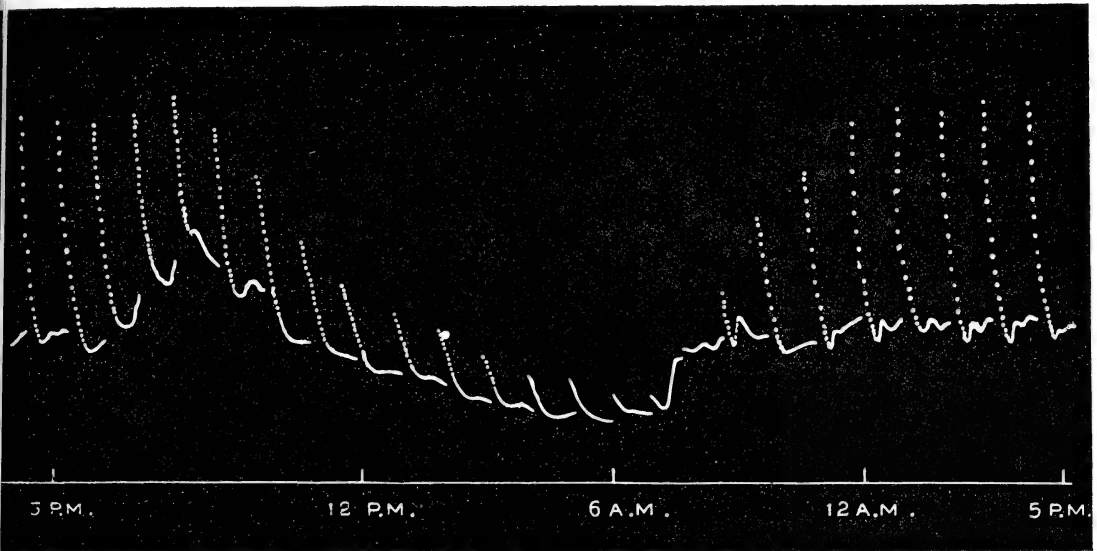

FIG. 11. Record for twenty-four hours, exhibiting diurnal variation of excitability (spring specimen). The displacements of base-line are due to nyctitropic movements.

(6.30 a.m.), response being practically abolished at 9 a.m. The excitability is then gradually restored in a staircase manner, the maximum being reached after 12 noon. After attaining this, the excitability remains constant till the evening. It will be noticed that the amplitude of response at 5 p.m. on the second day was the same as the corresponding response on the previous day.

The results of this and numerous other records taken in spring may be summarized as:

1. The maximum excitability of *Mimosa* is attained at about 1 p.m., and remains constant till the evening.
2. The excitability, generally speaking, undergoes a continuous decline from evening to morning, the response being practically abolished at or about 9 a.m.

3. From 8 a.m. to 12 noon, the excitability is gradually enhanced in a staircase manner, till the maximum excitability is reached near 1 p.m.

I have obtained numerous records in support of these conclusions, some of which are reproduced in the following figures. In these cases responses to uniform stimuli at intervals of half an hour were taken at different parts of the day, the recorder employed being of the Resonant type.

*Mid-day record.* The record of daily periodicity previously given shows that the excitability reaches its maximum after 12 noon, and that it remains constant at the maximum value for several hours. This fact is

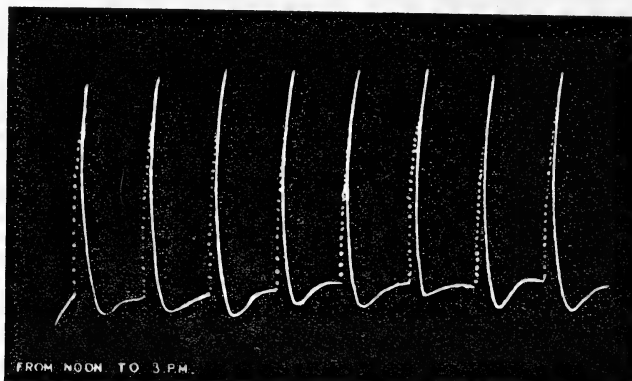

FIG. 12. Mid-day record from noon to 3 p.m. exhibiting uniform excitability. Responses taken once every half-hour.

fully borne out in the following record obtained with a different specimen (Fig. 12). The responses were taken here from noon to 3 p.m., once every half-hour.

*Evening record.* The record given in Fig. 11 shows that the amplitude of response falls continuously after 6 p.m. It might be thought that the diminished amplitude in the first part may be due to the natural nyctitropic fall of the leaf. The range of the pulvinal movement being limited, it is clear that the extent of the responsive fall must become smaller on account of the natural fall of the leaf during the first part of the night. That this is not the whole explanation of the decline of response in the evening will be clear from certain facts which I will presently adduce. It was stated that the leaf of *Mimosa* exhibits nyctitropic fall from 6 to 9 p.m., after which there is a reverse movement of erection. In certain specimens, however, the erectile movement commenced as early as 6 p.m. It is obvious that in these latter cases diminution of amplitude of response cannot be due to the reduction of the range of movement of the leaf. In Fig. 13 is given a series of records from 6 to 10 p.m. obtained with a leaf in which erectile movement had commenced early in the evening. Though the fullest range of

responsive movement was in this case available, yet the amplitude of successive responses is seen to undergo continuous diminution.

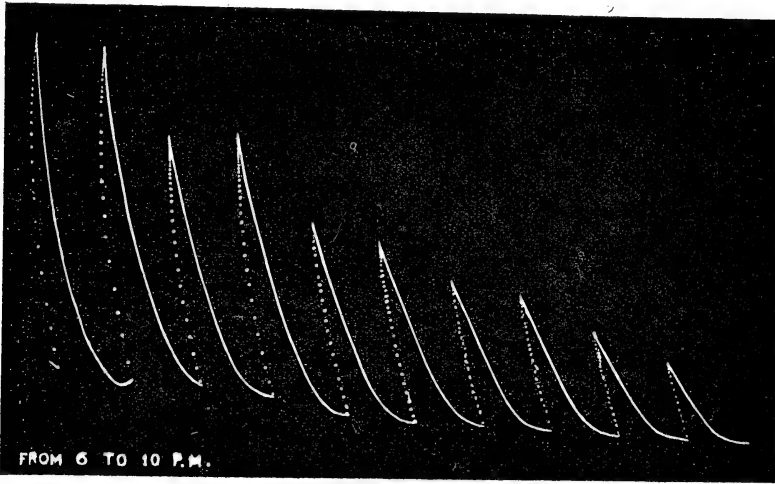

Fig. 13. Evening record from 6 to 10 p.m., showing gradual depression of excitability.

*Record in the morning.* The excitability is, as we have seen, nearly abolished about 8 or 9 a.m., after which there is a gradual restoration. This gradual enhancement of excitability to a maximum in the course of the forenoon is seen well illustrated in the following record (Fig. 14).

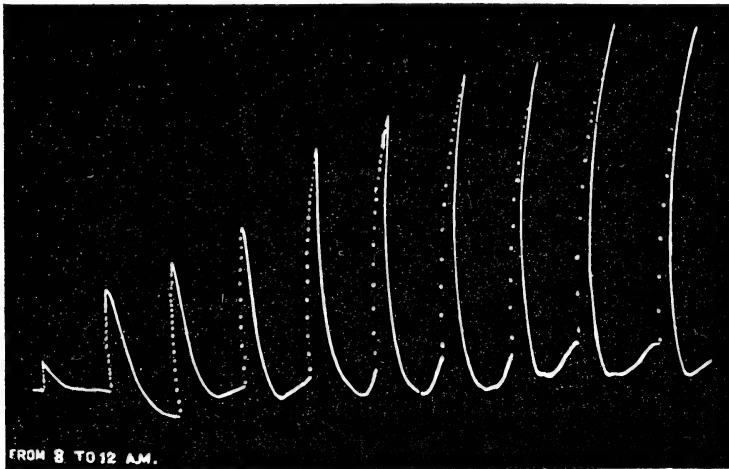

Fig. 14. Morning record from 8 a.m. to 12 noon, exhibiting gradual enhancement of excitability.

The record of daily periodicity given in Fig. 11 may be regarded as a typical example. Modifications may, however, be observed which are

traceable to individual peculiarities. As an example of this, I give a record (Fig. 15) obtained with a specimen in which nyctitropic movement was very pronounced. The periodic variation of excitability exhibited here is practically the same as shown by other specimens. The interesting variation is in the character of the recovery from stimulus; the leaf was falling from 6 to 9 p.m.; owing to the shifting of the base-line upwards the recovery appears to be incomplete. After 9 p.m. the leaf was erected, at first slowly, then at a very rapid rate. The consequent fall of the base-line late at night

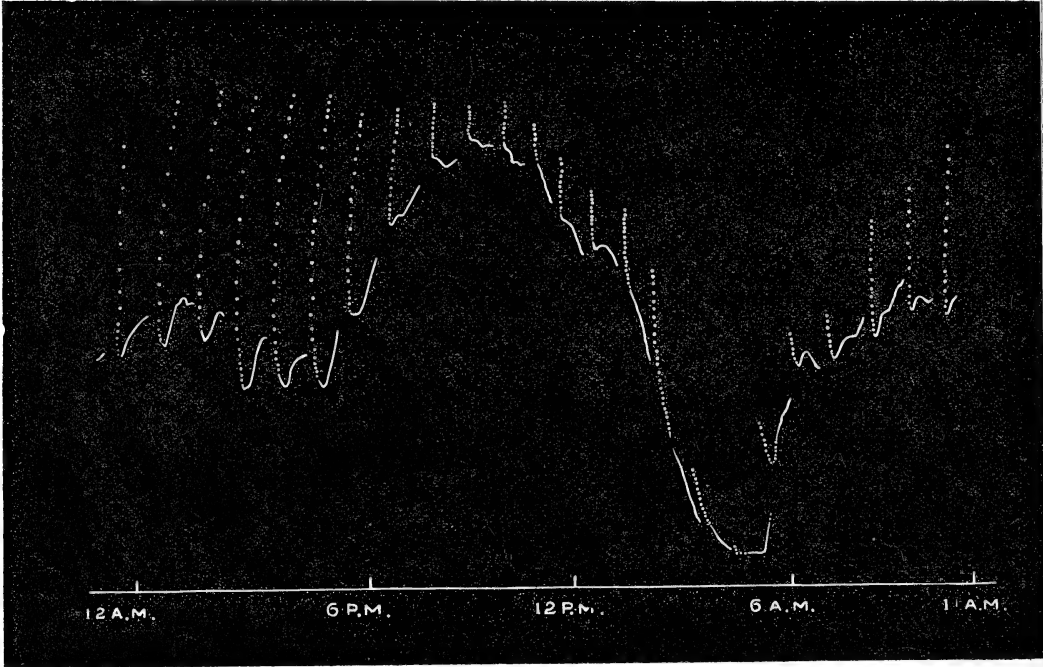

FIG. 15. Record of diurnal variation of excitability: it exhibits marked nyctitropic movement.

is very abrupt; hence there is an apparent overshooting in the line of recovery.

So far I have merely described the observed diurnal variation of excitability. We may next inquire whether there is any causal relation between the change of external conditions and the observed variation of excitability. It has been shown that the moto-excitability is greatly influenced by temperature. In order to find in what manner the diurnal variation of excitability was influenced by the daily variation of temperature, I took special care to secure by means of the thermograph a continuous record of temperature variations. The table which follows shows the relation between the hours of the day, temperature, and amplitude of response, in

that particular case whose diurnal variation of excitability is given in Fig. 11.

TABLE I.

Showing the relation between hour of the day, temperature, and excitability. (Spring specimen.)

Hours of day.	Temperature.	Amplitude of response.	Hours of day.	Temperature.	Amplitude of response.
5 p.m.	28° C.	28 mm.	5 a.m.	20° C.	5 mm.
6 "	25.5° "	28 "	6 "	20.5° "	4.2 "
7 "	24.5° "	27 "	7 "	21° "	3.5 "
8 "	23° "	23.5 "	8 "	22° "	2.5 "
9 "	22° "	21.5 "	9 "	24° "	0 "
10 "	21° "	18 "	10 "	26° "	6 "
11 "	20.5° "	15 "	11 "	26.5° "	15.5 "
12 "	20° "	13 "	12 "	28° "	22.5 "
1 a.m.	20° "	10 "	1 p.m.	28° "	26 "
2 "	20° "	8 "	2 "	28.5° "	28 "
3 "	20° "	7.5 "	3 "	28.5° "	28 "
4 "	19.5° "	6 "	4 "	29° "	28 "

From the data given in the table, two curves have been obtained. One of these shows the relation between the hours of the day and temperature; the other exhibits the relation between the hours of the day and the excitability as gauged by the amplitude of response (Fig. 16). It will be seen that there is, broadly speaking, a marked resemblance between the two curves, which, however, are not coincident. The minimum temperature, for example, was attained at about 4 a.m., but the excitability was not reduced to a minimum till several hours later. This want of coincidence is probably due to the following causes:

1. The influence of temperature on excitability is, as has been shown, not immediate. Hence there is a lag between the cause and the effect induced.

2. There are, again, other factors, such as variations of light and turgor, which affect the excitability. But the period of maximum effect induced by any of these does not necessarily coincide with that induced by temperature.

We may now discuss in greater detail the diurnal variation of excitability in *Mimosa*, taking the typical case, the record of which is given in Fig. 11. The temperature here is seen to remain almost constant, and at an optimum, from 1 to 5 p.m., the condition of light is also favourable. Hence the excitability is found to be constant, and at its maximum, between these hours. The temperature begins to fall in the evening after 6 p.m., and there is, in addition, the depressing action of gathering darkness. Owing to the time-lag, the fall of excitability does not commence immediately at 6 p.m., but an hour afterwards, and continues till the next morning. Various factors, moreover, conspire about this time to bring about a maximum depression of excitability. First, we have the cumulative effect of twelve hours' darkness; secondly, there is a diminution of moto-excitability

due to excess of turgor, the latter attaining its maximum at about 7 a.m. And, lastly, we have the depressing effect of cold, the temperature minimum occurring at 4 a.m. On account of the combined effects of these various factors, and the phenomenon of lag, the period of minimum excitability is in general reached about 9 a.m. In certain other cases this may occur

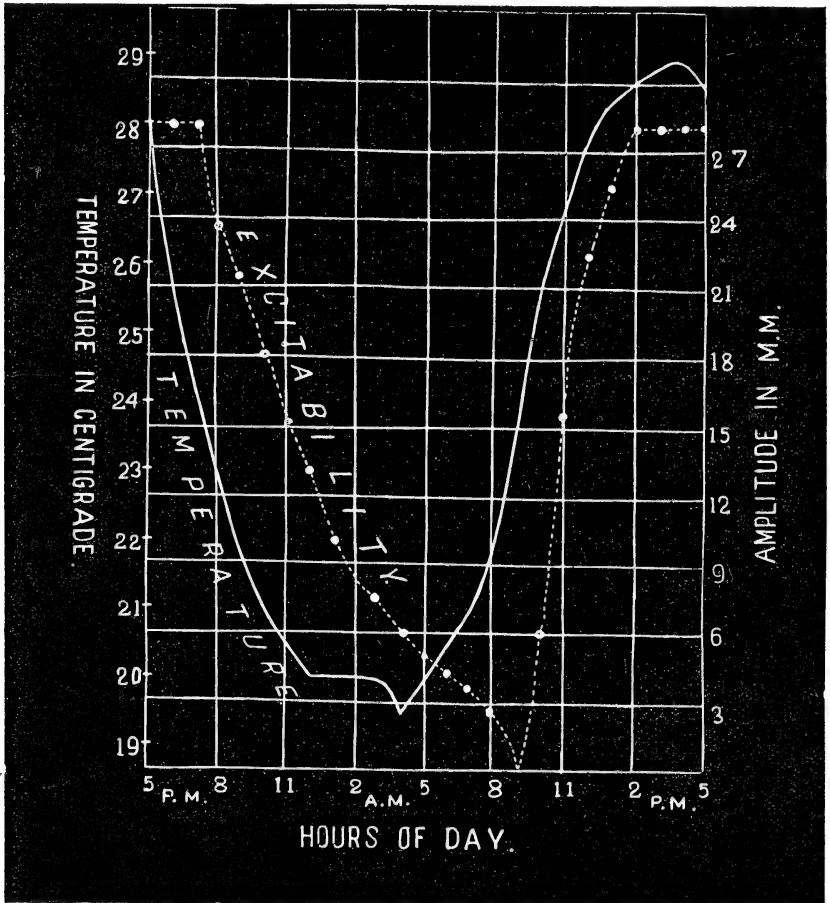

FIG. 16. The continuous curve shows the relation between the hour of the day and temperature. The dotted curve exhibits relation between the hour of the day and excitability.

earlier. After the attainment of this minimum, the excitability is gradually and continuously increased, under the action of light and of rising temperature. In the present case the highest temperature,  $28^{\circ}\text{C}$ ., was reached at noon, and the maximum excitability attained an hour afterwards.

It was said that temperature exerted a predominant influence in inducing variation of excitability. We may therefore expect that the diurnal period would be modified in a certain way according to the season.



In winter the night temperature falls very low; hence the depression of excitability is correspondingly great, and results in the complete abolition of excitability. The after-effect of intense cold is seen in the condition of inexcitability persisting for a very long period in the morning. In summer the prevailing high temperature modifies the diurnal periodicity in a different manner. When the night is warm, the fall of excitability is slight. In the day, on the other hand, the temperature may rise above the optimum, bringing about a depression. In such a case the excitability in the earlier part of the evening may actually be greater than in the middle of the day. These modifications are shown in a very interesting way in the following record (Fig. 17) taken at the end of April. The temperature of Calcutta at this

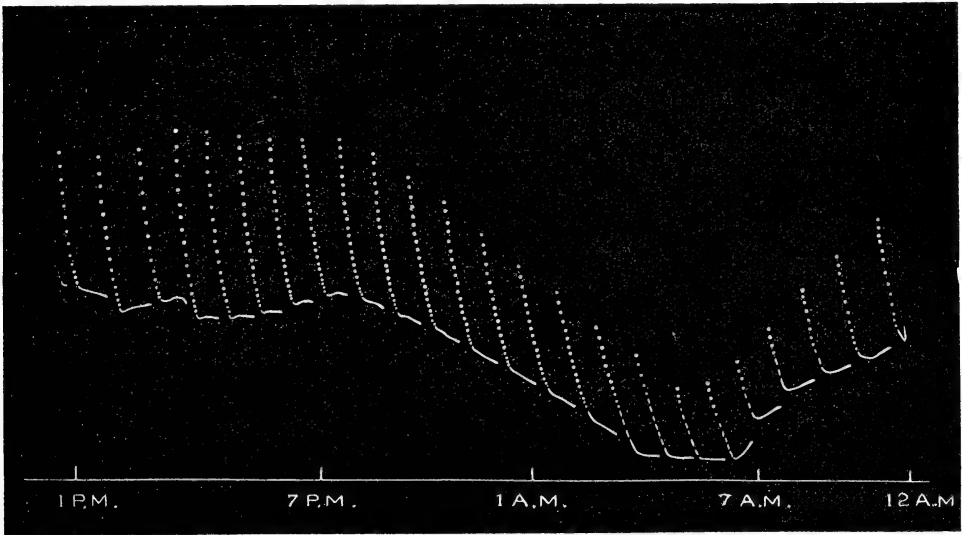

FIG. 17. Diurnal variation of excitability exhibited by summer specimen.

season often rises above  $100^{\circ}\text{F}$ . or  $38^{\circ}\text{C}$ . Table II also exhibits, in the case of the summer specimen, the relation between the hours of the day, temperature, and excitability.

An inspection of the record given in Fig. 17 shows that the amplitude of response was enhanced after 4 p.m. The temperature up to that time was unusually high ( $38^{\circ}\text{C}$ .), and there was in consequence a depression of excitability. After that hour there was a mitigation of heat, the temperature returning towards the optimum. Hence we find that the maximum excitability was attained between the hours 4 and 6 p.m. The minimum temperature at night was higher in the present case than that of the experiment carried out in February; in the former the minimum was  $25.5^{\circ}\text{C}$ ., while in the latter it was  $19.5^{\circ}\text{C}$ . On account of this difference the night record in summer shows a fall of excitability which is far more gradual than

that obtained in spring. The excitability is here not totally abolished in the morning, but reaches a minimum about 8 a.m.; the sensitiveness is then gradually enhanced in a staircase manner.

TABLE II.

Showing the relation between hour of the day, temperature, and excitability. (Summer specimen.)

Hours of day.	Temperature.	Amplitude of Response.	Hours of day.	Temperature.	Amplitude of Response.
1 p.m.	38° C.	22 mm.	1 a.m.	26° C.	21.5 mm.
2 "	38° "	23 "	2 "	26° "	20 "
3 "	38° "	24.5 "	3 "	25.5° "	18.5 "
4 "	37° "	28 "	4 "	25.5° "	17 "
5 "	35.5° "	29 "	5 "	25.5° "	16 "
6 "	33° "	27 "	6 "	26° "	15 "
7 "	31° "	26 "	7 "	27° "	14 "
8 "	30° "	26 "	8 "	29° "	13 "
9 "	29° "	25 "	9 "	30.5° "	11 "
10 "	27° "	24.5 "	10 "	33° "	16 "
11 "	27° "	24 "	11 "	35° "	17 "
12 "	26.5° "	22.5 "	12 "	37° "	21 "

## SUMMARY.

An account is given of the experimental method by which the moto-excitability of *Mimosa* is gauged, every hour of the day and night, by the amplitude of the response to a testing stimulus. This is effected by means of automatic devices which excite the plant periodically by an absolutely constant stimulus, and record the corresponding mechanical response.

From the record thus obtained, it was found that the excitability of the plant is not the same throughout the day, but undergoes a variation characteristically different at different times of the day. In a typical case in spring, the excitability attained its maximum value at 1 p.m. There was then a continuous fall in the excitability, the minimum being reached at nine the following morning. The plant at this time was practically insensitive. The moto-excitability was then gradually enhanced in a staircase manner till it again reached a maximum at 1 p.m.

Investigations are also described for the determination of the influence of periodically changing external conditions on the diurnal variation of excitability.

The effect of sudden darkness was found to induce a transient depression, followed by revival of excitability. The effect of persistent darkness was to induce a depression.

Exposure to light caused a transient depression, followed by an enhancement of excitability.

Excessive turgor induced a diminished response.

Lowering of temperature induced a depression of excitability, culminating in an abolition of response. The after-effect of excessive cold was a persistent depression of excitability.

Excitability was enhanced by rising temperature up to an optimum ; above this point a depression was induced.

The induced variation of excitability lags behind the inducing cause.

There is a relation between the recurrent changes of external conditions and the diurnal variation of excitability. The periodic variation of light, temperature, and turgor, as well as the phenomenon of lag, are factors which determine the periodic variation of excitability observed in the plant.

*Postscript.* It should be explained that the term 'moto-excitability' is intended to convey the idea that the observed periodic variation is probably to be attributed in part to variation in the motility of the pulvinus, as well as to variation in the excitability of the leaf. That the latter is the predominant factor appears from the fact that the minimal intensity of stimulus required in the afternoon was found to be only about one-fifth of that in the forenoon.

It is of interest to compare the results here recorded with those of Millardet ('Nouvelles Recherches sur la Périodicité de la Tension chez la Sensitive,' Strasbourg, 1869).



## Notes on Cephaleuros.

BY

N. THOMAS.

With Plate LIX.

THE group of organisms, a few of which form the subject of the present communication, has from time to time been examined by various investigators. Kunze (7) in 1827 created the genus *Cephaleuros* for two epiphyllous Algae brought by Weigelt from Surinam. He gave as the characters of his genus :

‘Thallus orbicular, lobed, formed of filaments of radiating cells like those of *Coleochaete* or *Melobesia*, the lower surface furnished with rhizoids containing coloured protoplasm, and the edges armed with sharp hairs, and from the discs arise thick septated filaments terminated by a bunch of sporanges.’

In 1829 Fries (4) amplified Kunze's description and compared *Cephaleuros* with the Lichen *Strigula*.

Montagne (12), Kützing (8), Mettenius (9), and Millardet (10) have described similar forms under various names ; Kützing gave the name *Phyllactidium arundinaceum* to the species he investigated, and Millardet called the small yellow discs which he found on leaves of *Abies pectinata*, *Phycopeltis epiphyton*. De Toni (3) and other systematists down to Oltmanns (13) have discussed the position and interrelationships of these Algae, and many conflicting classifications have resulted, owing to the inadequacy of description of the organisms and the difficulty of comparing the various forms.

Bornet (1) in 1873 described a *Phyllactidium* which is gradually invaded by Fungal hyphae, but which does not enter the composition of the Lichen until a comparatively late stage in development is reached. His figures and description, although incomplete, represent an Alga closely resembling the Ceylon forms of this investigation. It is of interest to note that, although there is no mention of it in the text, his Fig. 2 shows the curious loose end to the radial walls which is so remarkable a feature in the Ceylon material.

In 1879 appeared Cunningham's monograph (2) on *Mycoidea parasitica*. Briefly his results are as follows: A zoospore, which is formed by the division and liberation of the contents of a resting oospore, comes to rest on the leaf surface. This rounds itself off and grows, the coloured cell-contents become four-lobed, and each lobe divides dichotomously. The cell-wall of the original spore in the meantime sends into the cell processes which branch. These, coalescing with each other, form a series of cells arranged in radiant fashion. New cells are formed by a repetition of this process. Ultimately the cell-walls become double and the disc becomes more or less divided into a series of radiating filaments. These are the primary discs, which are found in profusion on the surface of the host. Some of the cells of the primary disc may bud downwards; the buds gradually penetrate the thickened cuticle and reach the layers between this and the inner cellulose membrane of the epidermal cell. A cell having reached this position divides actively in a dichotomous fashion and a mass of radiating filaments is formed. These are the secondary discs, consisting of a single layer of filaments. Later, ascending branches are developed which penetrate the cuticle. The ends of these become much swollen, and sporangia are produced from which motile zoospores escape. This is the method of reproduction during the rainy season. As the dry and cold season approaches, oogonia are formed from cells of the thallus and specialized slender-branched filaments become closely attached to them. Some of these filaments are dilated at their extremity, and the contents of one of the swollen ends are said to be emptied into the oogonium. The oospore, with its capacity of resisting unfavourable conditions, is formed as a result of this fusion. No rhizoids were observed by Cunningham, but branches were occasionally seen which forced their way between the epidermal cells into the inner tissues of the leaf. The presence of the Alga caused degeneration of the adjoining cells of the leaf, and in extreme cases the whole leaf became disorganized.

I have had, through the kindness of Dr. Rendell, an opportunity of examining the valuable series of slides prepared by Dr. Cunningham, now in the possession of the British Museum (Natural History), and have been able to recognize many of the appearances described in the monograph.

The Alga described by Cunningham was identified by Marshall Ward (15) as the gonidial constituent of the Lichen *Strigula*, but it may be perfectly autonomous. He placed it near *Chroolepus*, but regarded it as belonging to a distinct line of development. The Alga is at first a simple plate-like disc as described by Cunningham. In maturer stages rhizoids occur on the lower surface, zoosporangia sunk in the thallus are developed, which he regarded as corresponding to the structures described as oogonia by Cunningham. Nothing resembling a sexual

process was seen by him. Sporangia borne on special aerial branches are also described, corresponding with those of *Mycoidea parasitica*. The Alga of this monograph was always extra-cuticular, except on *Citrus* leaves, in which case Marshall Ward failed to determine the origin of the sub-cuticular position.

Möbius (11), under the name *Phyllactidium tropicum*, describes and figures an Alga which closely corresponds to one of the Ceylon forms of this investigation; it is epiphytic and extra-cuticular, and grows by means of false dichotomy, which, owing to the fact that the walls are not formed simultaneously, Möbius describes as monopodial branching. Very characteristic of this form are the pores which he describes in the transverse walls.

Hariot (5), in a paper on *Cephaleuros*, points out that the description of Cunningham's *Mycoidea parasitica* corresponds with that of Kunze's genus *Cephaleuros* founded fifty years previously; these are forms in which the plant is firmly fixed to the host by rhizoids. Hariot includes in the genus *Phycopeltis* all the easily detached forms such as *Phyllactidium tropicum* (Möbius).

Karsten (6), in a summary of this family, takes a more comprehensive view than Hariot; he substitutes *Cephaleuros* for all the many-layered disc forms, and includes in *Phycopeltis* all the regularly shaped one-layered discs. To the Alga described by Cunningham and Marshall Ward, he gives the name *Cephaleuros mycoidea*.

The most recent contribution to the study of these forms is that of Vaughan Jennings (14) who investigated two species of *Phycopeltis* from New Zealand. Under *Phycopeltis expansa*, he describes a form which in the young stages closely resembles the  $\alpha$  Ceylon plant, and his form seems to be associated with Fungal hyphae and Lichen-forming hyphae. The Fungal hyphae are colourless in their young, and brown in their older stages, and they are apparently independent of the Alga. They grow, however, between the Alga and the leaf surface and follow the course of the radial walls, occasionally anastomosing by sending branches along the transverse walls. Although the figures of Vaughan Jennings are not very clear, the association of Alga and Fungus, which does not affect the Algal growth, is interesting.

Certain interesting features, hitherto undescribed, were observed in an epiphytic Alga from Ceylon, collected by Professor Farmer. Supplementary material, sent from Barbadoes by Mr. W. Nowell, has been examined in conjunction with the Ceylon organisms.

On the leaves collected in Ceylon, two distinct forms were found, both occurring on the upper surface of the leaf, from which they are easily detached. For the present these are designated  $\alpha$  and  $\beta$  forms. The discs of the  $\alpha$  organism are, for the most part, circular, but assume a more or less lobed appearance in the maturer plants examined; the cells are

transparent and considerably larger than the small dark cells of the  $\beta$  form.

The Alga on the leaves sent from Barbadoes is distinct from the Ceylon plants, both in structure and mode of growth.

$\alpha$ . LARGE-CELLED FORM (CEYLON).

The Alga is always found on the upper surface of the leaf, from which it is easily detached as it is extra-cuticular. In the early stages the thallus is circular in outline, evidently arising from a rounded spore; young stages have been seen in which the thallus is very small, not exceeding 0.01 mm. in diameter (Plate LIX, Fig. 1).

Dividing walls are formed early; they arise as ingrowths of the outer wall. The appearance is unlike that described by Marshall Ward, who states that when the zoospore comes to rest, the resulting cell begins to grow and divide, forming cell-walls, 'the pale lines at first seem to be isolated in the protoplasm, but their ends become at length united in the centre, and before long also at the circumference of the mass.'

In the material of this investigation a large number of early stages occurred, and the following sequence of events was observed. The Alga at first consists of a single circular but flattened cell; as this enlarges cell-plates make their appearance at the periphery, and grow towards the centre of the expanding organism. Nine or ten, and even more, of these radially arranged plates may be observed, before two of them join at the centre to form a complete septum. The resulting disc, still retaining its circular outline, grows by the enlargement and further division of the peripheral cells, and transverse septa are formed.

As the thallus grows still more, it tends to lose its circular outline. Contact with any obstacle arrests growth at that point, and the thallus spreads out, assuming an irregularly lobed appearance. If in their growth two thalli come into contact, the one becomes fused with the other, and both thalli continue their growth at all points, except where they are in contact with each other.

Examination of a single lobe of the mature thallus suffices to show the typical structure. The cells of the Alga are arranged in a radiating fashion from a common centre, this is the result of the mode of growth. The growth is marginal; it may be conceived to have been derived from a condition such as that of *Coleochaete*, where the end cells of the filaments branch in a dichotomous fashion. In this organism, as the marginal cells grow outwards, they divide by means of a cell-plate from the periphery towards the centre of the disc, thus tending to divide the cell radially into two segments. This wall never divides the cell completely, its development ceases when it has attained a length equal to about half the length of the cell. These



radial walls are fully developed before any indication of a transverse septum is to be seen (Fig. 4).

The transverse wall is formed as an annular ingrowth from the lateral walls, the lateral and transverse walls being at right angles to each other. The formation of this septum must be very rapid, for only rare instances of its partial formation are to be seen, although there are numerous examples of young radial walls without corresponding transverse septa.

The most curious feature, however, is that the transverse and longitudinal septa do not fit. That is, the transverse wall does not join the radial wall at its free posterior extremity, but at a point slightly further forward, thus leaving a loose end which is a striking feature of the thalli (Figs. 3 and 4).

In the early stages a careful examination shows only thin cell-walls, colourless or pale yellow in alcohol material, but readily staining with haematoxylin, &c. Sometimes protoplasmic contents may be observed, and nuclei may be seen in the cells. In older discs the cell-wall consists of a double layer, and at a lower focus there are also distinct striations to be discerned on the inner wall next the host.

Rather thick transverse sections of 10 to 13  $\mu$  gave the following appearances. The thallus cells in section show a large open lumina, the wall of the cells staining a pinky violet in haematoxylin. On the lower side of the thallus and exactly below the radial walls, a small cell-cavity was observed. In oblique sections these may be seen to be hyphae which exactly correspond in position with the cell-walls of the thallus, and the striations are seen clearly, always on the Algal wall nearest the leaf on which the epiphyte grows (Fig. 6).

Sections cut in various directions support this observation, and the hyphae are seen in every case to correspond with the walls of the thallus cells, not only with the radial but also with the tangential walls.

Slides were made by mounting the Alga, after staining, either in glycerine jelly or Canada balsam between two thin glass slips, so that either surface of the Alga could be examined at will. Examination of these slides confirmed what the sections suggest. The lower surface of the Alga is covered by hyphae which branch freely, thus covering the lower surface with a network, the pattern of which coincides with that made by the cell-walls of the Alga. Where these curious hyphae are found in connexion with the plant, in a few cases a close connexion between the Algal discs and certain pale filaments, which wander in numbers over the leaf surface, was observed. The explanation of this curious hyphal structure, so closely connected in position with the Algal wall, is not obvious; no organic connexion has been made out between the larger cells of the disc and the filaments.

These may be rhizoids, but the lack of evidence to show a close

connexion precludes this interpretation. On the other hand, the close connexion, in several cases, between the Alga and certain pale filaments which may be traced outside the Alga, seems to indicate that the hyphae, which in some way have become closely connected with the discs, are of a Fungal nature.

A large number of tests were tried to demonstrate the nature of the cell-wall in this organism. Insolubility in cupric ammonia and in various acids, together with coloration tests, showed that the cell-walls did not consist of pure cellulose.

Tests were made for other substances, and among them, those described by van Wisselingh (17) for chitin were tried, in particular those tests by which chitin was converted into mycosin by means of dilute potash. The presence of the latter substance, which microchemically responds in a very definite way, was shown by staining in various reagents. Schultz's solution stains the walls of the Alga, in particular the transverse walls, a deep blue-violet.

It is evident from these tests that the constitution of the cell membrane of this Alga approximates to that of the cell-walls of certain Fungi.

The striations, referred to above, when observed in surface view, appear, in a middle focus, as an oblique fringe to the cell-wall, but in the lowest focus they are seen as straight or slightly curved markings across the cell lumina. The appearance of obliquity is due to the marked concavity of the lower cell-wall of the Alga nearest the leaf.

At first it was thought that the appearance was due to a crinkling of the cell-wall owing to contraction in spirit, but this does not explain the fact that it is only in the cell-wall adjoining the host that the crinkling or striations are observed.

That the appearance was not due to markings on the cell-wall of the epidermis of the leaf was evident from the way in which the striations corresponded with the cell lumina of the Alga, and also from the fact that they were clearly demonstrable in detached pieces of thalli which were not separated from the leaf by means of knife or razor.

It was thought that the appearances might be due to the contraction or hypertrophy of a membrane. One suggestion is that the membrane in question is the cuticle of the leaf dragged away by, and still adherent to the Alga, but from sections and from an examination of the lower surface of the thallus, it is clear that the striated appearance is in some membrane between the Fungal hyphae and the Alga, that is, in the Algal cell-wall itself.

The appearance is perhaps to be explained as the result of a lamellose structure of the cell-wall of the Alga, similar to that of *Trentepohlia*, as described by West and Hood (16). It is singular, however, that the markings should be confined to the lower wall of the Alga. It is not

possible to decide from the material available, whether this structure of the cell-wall is due to some purely physiological condition, or is due in some way to the proximity of the Fungus.

### β. DARK-CELLED FORM.

This occurs also on the upper surface of the leaf under the same conditions and mixed up with the large-celled discs (Plate LIX, Fig. 7). At first it was thought that these might be alternative forms in the life-history of one individual, but the evidence seems to point to a distinct organism. Although the majority of plants are in a fairly mature condition, young stages have been observed which are undeniably early stages of the older dark-celled thalli, such as occur in profusion over the leaf surface. The young stage is circular in outline, with indentations of the cell-wall similar to those already described in form *α*. The cell-walls are dark brown, and within the limiting walls no structure can be observed, but a uniform brown colour prevails. The mature plant also has dark brown cell-walls, unaffected by any dyes and strongly resistant even to concentrated acids.

The method of growth appears to be identical with that of the large-celled type. The marginal cells, as they grow, are divided radially by a cell-plate into two. This membrane grows from the periphery inwards until it is equal in length to about half the total length of the undivided cell; transverse walls are then formed, and the same curious free posterior end of the radial walls may be seen after the formation of the transverse septa (Fig. 8).

In section, the dark cell-walls are seen to be thickened, especially on the upper surface. The cells are much smaller in all their dimensions than those of the previously described *α* form, each cell only measuring  $8\mu \times 3\mu$  in surface view as compared with an average of  $18\mu \times 8\mu$  in the form *α*.

This organism is simpler in structure than the *α* form with which it grows. Not only are the cells smaller, but there are no Fungal hyphae connected with it, and the cell-walls do not show the lamellose structure of those of the *α* type.

This investigation suggests that the two forms belong to perfectly distinct species, but, on the other hand, one must not neglect the possibility that the *α* form may turn out to be a luxuriant variety of the *β* organism. It is well known that association with a Fungus frequently causes hypertrophy; perhaps one has here another instance of this, in which case the *α* form probably owes its larger cells and other peculiarities of structure to its early connexion with the Fungal hyphae.

From an examination of Dr. Cunningham's slides, a few points of comparison were made; although, as one would naturally expect in

glycerine jelly preparations, the slides do not show the characters described by the investigator of *Mycoidea parasitica* with the clearness which, doubtless, they originally possessed.

Primary discs closely resembling the  $\alpha$  Ceylon form were seen, although the structure was somewhat obscure. The slide described as 'sub-epidermal discs with young oospores' was not unlike a preparation of the thallus zoosporangia seen in the Barbadoes material, and the aerial reproductive filaments were plentifully present.

A slide of the 'epidermis of a Camellia leaf, showing mature oospores from below', showed rounded bodies with spherical cell-contents, and attached to them laterally an elongated cell. This is unlike anything observed in my material: the adherent cell is what was described by Cunningham as a pollinodium.

#### BARBADOES MATERIAL.

The position of this Alga is intracuticular, and hence is in direct contrast to that of the Ceylon forms.

No early stages of this Alga have been observed in the material sent by Mr. Nowell; and only mature plants were found, all occurring on the upper surface of the leaf.

The Alga is roughly circular, the patches having a diameter of 2.5 to 6 mm.

Examination of material cut tangentially to the surface shows a radiating structure, roughly circular in outline, but the circumference of the circle is much more irregular than in the type  $\alpha$  Ceylon; the discs are more loosely made, and tend to break up to form radiating filaments. The individual cells here are much larger, being approximately  $42 \mu \times 10$  to  $12 \mu$  when measured in surface view.

Growth is marginal and takes place in the following way. The marginal cells enlarge and begin to divide by means of a cell-plate which grows inwards from the periphery. At first the direction of growth is parallel to the lateral walls of the parent cell; but after a certain point the direction changes, and the new septum approaches and joins one of these lateral walls, curving in such a way that it meets the latter at approximately a right angle. A transverse septum may now be formed, joining the new median wall to the other lateral wall of the parent cell; this second septum cuts both walls perpendicularly. The curved and straight transverse septa are a striking feature of the thallus (Figs. 10 and 11).

Marshall Ward notes that in the Alga he investigated 'the tendency of the new walls to abut on the old ones at angles approaching the vertical is remarkable'. He describes the growth as being the result of dichotomous division of the marginal cells, although his figures resemble the appearance in this case (cp. Fig. 10 with Fig. 39 in his monograph).

If sections be cut perpendicularly to the leaf surface, it will clearly be seen that the Alga grows between the cuticle and the inner layers of the epidermal cell-walls. This is shown by the continuity of this membrane with that which occurs externally to the Alga. The cells of the epidermis and even of subjacent layers are affected by the presence of the Alga. The cell-contents become massed into dense aggregates, reddish brown in colour, and the walls become sclerotic (Fig. 12). In surface view, when the Algal patches are removed, the outlines of the discs may be traced owing to the darkened surface thus exposed, the presence of the Alga having brought about this degeneration.

In transverse section the large cells of the Alga show a clear lumina, and from the lower surface of the cells grow the 'rhizoids'. In surface view these are seen as irregular cells, much branched and curved (Fig. 11); they occur in abundance between the cells of the disc and those of the epidermis of the leaf. Owing to their curvature, in a transverse section of the Alga the 'rhizoids' are cut in various directions, so that circular ends in cross-sections and curved longitudinal pieces occur together (Fig. 12).

These 'rhizoids' are not penetrating organs, and nothing of the nature of a haustorium has been seen. They may become closely adpressed to the walls of the epidermal cells, but in no case has penetration been observed.

Nuclei stain prominently in haematoxylin, both in the thallus cells and in the rhizoids.

In the thalli, zoosporangia are frequently to be observed. In surface view they appear as terminal cells of a 'filament' which has enlarged and whose cell-contents are much denser. Haematoxylin picks out the nuclei; cases have been observed with one, a few, or numerous nuclei (Figs. 10 and 11). In section it may be seen that the zoosporangium becomes very much swollen, the swollen part projecting downwards. The wall of the zoosporangium becomes thickened and the nuclei lie irregularly in the granulated protoplasm (Fig. 14).

In addition to these fertile cells, an end cell of a 'filament' may give rise to a barren or fertile hair; these hairs grow vertically upwards, perforate a way through the 'cuticle', and thus reach the outer air. The barren hairs are simple structures, long, and consisting of several cells, as a rule arising from a thallus cell with dense cell-contents (Fig. 15).

The sterile hairs are about the same diameter all along their length, but certain others become very much swollen at the ends. The terminal cells of the latter have dense cell-contents and a prominent nucleus (Fig. 16).

Many stages have not been observed, but a few examples show a cell cut off from the apex of the hair, comparable with and closely resembling

the young stages in the development of the fertile aerial branches observed by Cunningham and Marshall Ward (Fig. 17).

The nature of the cell-wall has been tested by using numerous reagents. The cellulose is not a simple kind, but has been impregnated with pectic substances.

In some cases the Algal cell-wall itself seems to be lamellose, the layers being distinctly seen in stained sections (Fig. 13).

The presence of starch is made clear by staining with iodine; the contents of the marginal cells and of the zoosporangia stain a deep blue-black, all other parts take a yellow coloration.

Oil occurs in large quantities in the cells: the oil globules could clearly be seen in certain preparations.

#### SUMMARY.

In the forms described in the preceding pages, epiphytic Algal organisms are found to be free from infesting Fungal hyphae, which in the majority of previous investigations are described as occurring in association with the discs.

The most salient features which characterize both  $\alpha$  and  $\beta$  Ceylon plants are the method of growth and the curious loose end of the radial walls, owing to the formation of transverse septa, not at the extremity of the radial plate but at a point slightly further forward, and in the  $\alpha$  form the association of the discs with the Fungal hyphae. These characters are, as far as may be judged from the material, very different from those of the Barbadoes species, with its subcuticular habit, its development of 'rhizoids', the presence of barren and fertile aerial hairs and sub-cuticular zoosporangia, and the effect which it produces on the tissues of the host.

One is naturally drawn to the conclusion that this Alga represents a simpler stage of development than that of the Ceylon types.

The total absence in the latter of fructifications, and the incompleteness of the story presented by the Barbadoes material, make it impossible to arrive at a definite conclusion with regard to the specific and generic position of these organisms. As far as can be judged from vegetative structures, the  $\alpha$  form from Ceylon is almost indisputably the same as that described by Möbius as *Phyllactidium tropicum*, the primary discs of Cunningham, and the early stages of Marshall Ward's Alga: the Barbadoes form in many of its features resembles the older stages described by Marshall Ward and the intracuticular organisms of Hariot and Karsten.

In conclusion, I wish to express my thanks to Professor J. Bretland Farmer for his suggestions, help, and criticism throughout this work, and for supplying me with the material on which the investigations were made.

ROYAL COLLEGE OF SCIENCE,  
LONDON.

### BIBLIOGRAPHY.

1. BORNET, M. E. ('73): Les Gonidies des Lichens. Ann. Sci. Nat., Bot., Sér. 5, xvii, pp. 62, 63.
2. CUNNINGHAM, D. D. ('79): *Mycoides parasitica*, a New Genus of Parasitic Algae. Trans. Linn. Soc., 2nd ser., Bot., i, pp. 301-16.
3. DE TONI ('89): Sylloge Algarum, i, pp. 12-15.
4. FRIES ('29): Systema Mycologicum, iii, p. 327.
5. HARIOT, M. P. ('89): Note sur le genre *Cephaleuros*. Journ. de Bot., iii, Aug. and Sept., pp. 274-6, 284-8.
6. KARSTEN, G. ('91): Untersuchungen über die Familie der Chroolepideen. Ann. Jard. Bot. de Buitenzorg, x, pp. 24-7.
7. KUNZE ('27): Weigelt, Surinam Exsicc.
8. KÜTZING ('49): Spec. Alg., Lipsiae.
9. METTENIUS, G. ('65): Ueber die Hymenophyllaceae. Abh. der Königl. Sächsisch. Ges. der Wiss., math.-phys. Classe, Leipzig, xi.
10. MILLARDET ('70): Mém. Soc. Sci. Nat. Strassb., vi.
11. MÖBIUS, M. ('88): Ueber einige in Portorico gesammelte Süßwasser- und Luft-Algen. Hedwigia.
12. MONTAGNE ('38-'42): Flore de Cuba, i, p. 133. Histoire physique, politique et naturelle de Cuba. Plantes cellulaires.
13. OLTMANN ('04): Morphologie und Biologie der Algen. Jena. Vol. i, p. 250.
14. VAUGHAN-JENNINGS ('96): On two New Species of *Phycopeltis* from New Zealand. Proc. Roy. Irish Acad., ser. 3, vol. xxxi, no. 5, pp. 753-66.
15. WARD, H. MARSHALL ('84): On the Structure, Development, and Life-history of a Tropical Epiphyllous Lichen. Trans. Linn. Soc., 2nd ser., Bot., ii, pp. 87-115.
16. WEST, G. S., and HOOD, O. E. ('11): The Structure of the Cell-wall and the Apical Growth in the Genus *Trentepohlia*. New Phytologist, vol. x, nos. 7 and 8, pp. 241-8.
17. WISELINGH, C. VAN ('98): Mikrochemische Untersuchungen über die Zellwände der Fungi. Pringsh. Jahrb. f. wiss. Bot., Berlin, xxxi, pp. 619-85.

### EXPLANATION OF PLATE LIX.

Illustrating Miss N. Thomas's paper on *Cephaleuros*.

All drawings were made with camera lucida.

Figs. 5 and 9 were drawn under a  $\frac{1}{8}$ " semi-apo. imm. Koristka with comp. oc. 6.

Figs. 6 and 8 with  $\frac{1}{8}$ " and comp. oc. 4.

Figs. 1-3 and 7 with 3 mm. apochr. Hom. imm. Koristka and comp. oc. 8.

Figs. 4, 13, 14, and 17 with 3 mm. and comp. oc. 4.

Fig. 10 with D. Zeiss and oc. 6.

Figs. 11, 12, 15, and 16 with D. Zeiss and oc. 4.

Figs. 1-6 Ceylon form *a*.

Figs. 7-9 Ceylon form *β*.

Figs. 10-17 Barbadoes form.

Fig. 1. *Ceylon form a*. Early stages in development of discs. (*a*) Diameter not more than 0.01 mm. (*b*) Slightly older stage. Near the disc but not attached to it are hyphae of a Fungus. × 455.

Fig. 2. Older disc. Transverse walls not yet formed. Striations in lower wall. × 455.

Fig. 3. Specimen of older thallus. Transverse walls have formed and the loose posterior end of the radial walls is a prominent feature. × 455.

Fig. 4. Mature lobed thallus of Ceylon form *a*, growing between two thalli of the *β* form. Nuclei present in the cells. Specimen shows the characteristic radial walls and mode of cell-division and growth. × 225.

Fig. 5. Lobe of mature thallus seen from below, showing Fungal hyphae lying along the Algal walls. Connexions with free hyphae. × 535.

Fig. 6. Section of mature thallus, showing hyphae cut transversely and obliquely, and striations in lower wall of Algal cells only. × 730.

Fig. 7. *Ceylon form β*. Young stages, dark cell-walls, divisions already smaller in size. × 455.

Fig. 8. Lobe of mature thallus, showing mode of growth, smaller cells than in form *a*. Note characteristic radial walls. × 365.

Fig. 9. Section of Ceylon form *β*, showing thickened upper cell-wall. × 1,070.

Fig. 10. *Barbadoes plant*. Small piece of thallus, showing mode of growth, young zoosporangium and development of hair at periphery. × 430.

Fig. 11. Lobe of mature thallus, showing mode of growth, curved rhizoids in lower focus, thallus zoosporangium (uninucleate), and aerial hair. × 300.

Fig. 12. Section of thallus and leaf of host, showing subcuticular position, development of rhizoids, and decay of cells of host. × 300.

Fig. 13. Section of thallus, showing young zoosporangium embedded in the thallus, uninucleate, with dense cell-contents. Some of the cells show lamellose structure of the cell-wall. × 450.

Fig. 14. Section of thallus with older multinucleate zoosporangium with thickened cell-wall. × 450.

Fig. 15. Section of thallus with aerial sterile hair which has perforated its way through the cuticle. Hair with dense cell-contents and nuclei. × 300.

Fig. 16. Section of thallus with aerial hair with swollen extremity and prominent nucleus. Young stage of fertile hair. × 300.

Fig. 17. Section of thallus with aerial fertile hair more fully developed, a cell cut off at the extremity. × 450.





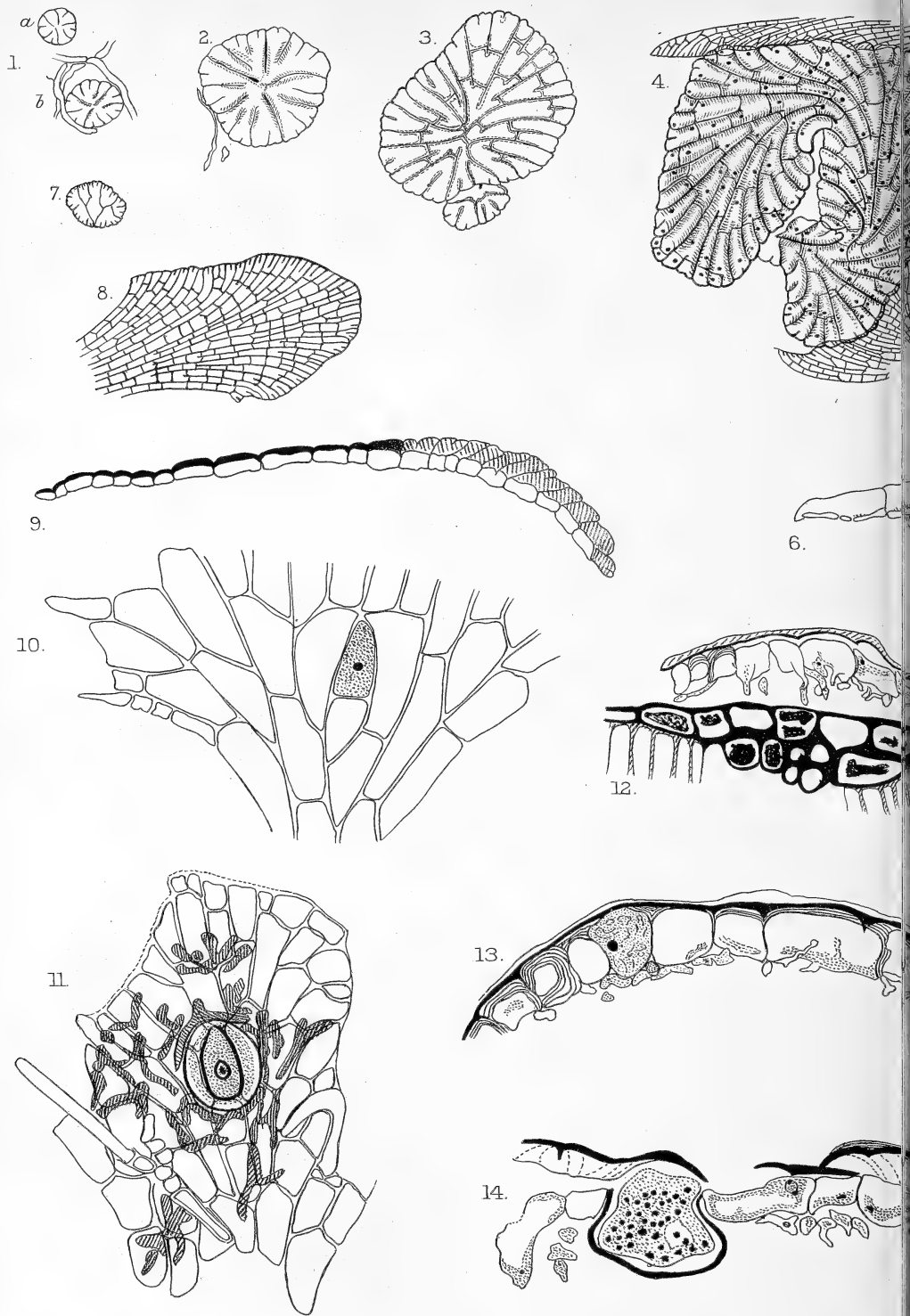

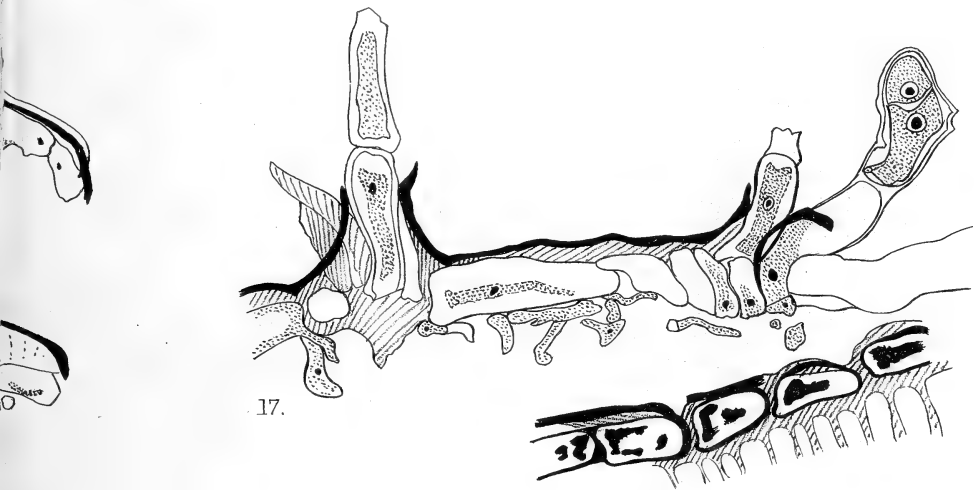
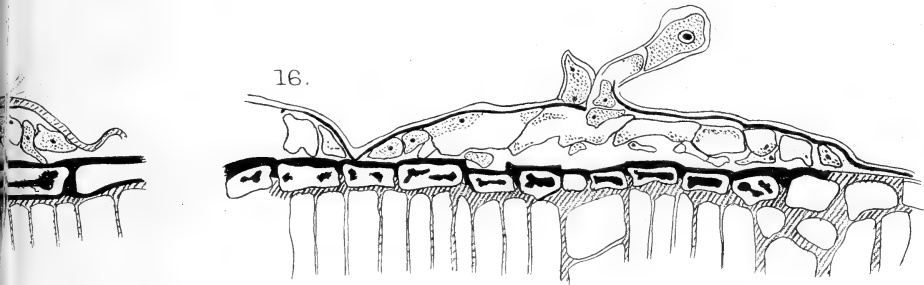
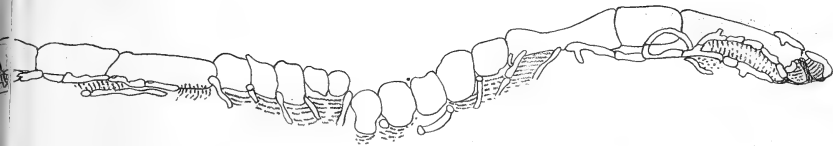
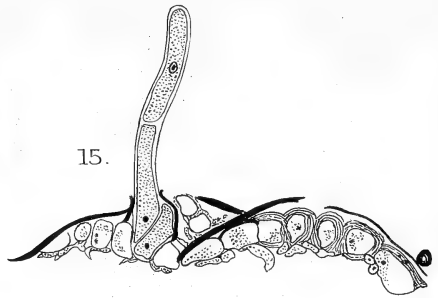
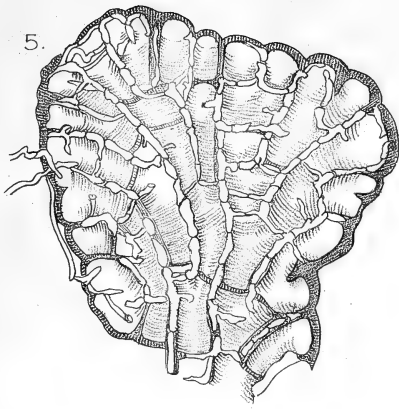



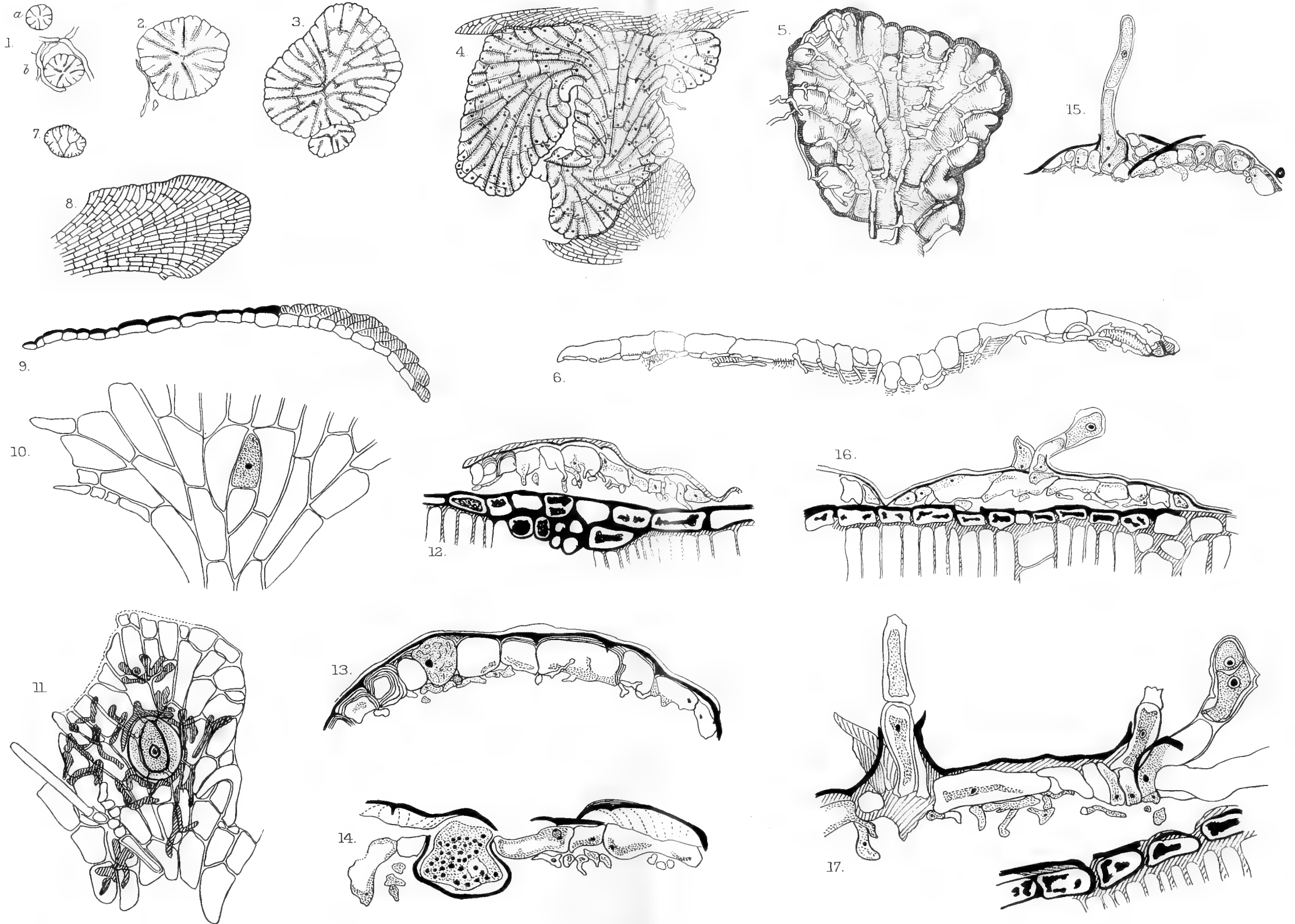

N. THOMAS—CEPHALEUROS.



# An Anatomical Study of Syncotyly and Schizocotyly.

BY

R. H. COMPTON.

With forty-one Figures in the Text.

## INTRODUCTION.

ONE of the most momentous events in the history of Systematic Botany and Phylogeny was the perception by Andrea Cesalpini (1583) of the fundamental importance of characters of seed and embryo in plant classification. John Ray's division of the Flowering Plants into Dicotyledons and Monocotyledons (1686-1704) has been the basis of the systematic study of Angiosperms ever since. The success of this primary division is perhaps due to the fact that characters which appear early in ontogeny are on the whole more likely to indicate remote ancestral affinities than those which develop later. The same cause has led to the modern reawakening of interest in seedling structure. In the vexed question of the origin of the Monocotyledons seedling characters have been the main point upon which attention has been focused.

The admirable simplicity of the classification of Angiosperms according as they have one cotyledon or two could not in the nature of things but be disturbed at some point. It was found that certain undoubted Dicotyledons had no seed-leaves recognizable as such; others had only one cotyledon; and others again had several; while in the Monocotyledons the question was often—and still is—what form has been taken by the cotyledon which we assume to be present. Moreover, teratologists found that material was provided them by seedlings just as by all other plant structures. Sometimes a seedling of a Dicotyledonous species was found to have but a single seed-leaf; sometimes it had three or four, or the cotyledons were lobed to a greater or less depth.

It is with this last class of variation that I propose to deal in the following paper. The study of teratology is full of intrinsic interest and is often of great value in elucidating obscure morphological problems. The question as to the modes of increase and decrease in number of cotyledons is of such great phylogenetic importance that one is impelled to investigate

cases in which the phenomena in question are taking place, so to speak, before our eyes. Moreover, it is impossible to judge how much theoretical weight to attach to any phenomenon, teratological or otherwise, before it has been adequately investigated; and cases such as the present cannot be dismissed on *a priori* grounds.

The paper will consist of two parts: the first will deal with Syncotyly, the second with Schizocotyly.

#### SYNCOTYLY.

There exists a small and scattered literature on this subject, for the most part simply recording instances of the anomaly. The most important investigation of the phenomenon is that of de Vries,<sup>1</sup> who dealt with it from the point of view of its heritability. From the morphological and anatomical point of view, however, syncotyly has not been studied, so far as I know: it is from this standpoint that I have approached the subject, partly from its intrinsic interest and partly in the hope that it might shed light upon the origin of the Monocotyledons. The following pages are the results, at present very incomplete, of an examination of some cases of syncotyly: owing to the comparative rarity of the anomaly the research is necessarily prolonged, but the future may furnish fresh material for study and render possible an amplification of what can be written upon the subject at present.

I shall proceed to describe the structures which have been observed in the material available, and shall then enter into a discussion of certain problems arising out of the investigation.

#### SWAINSONA CADELLI (Leguminosae).

The anatomy of the normal dicotylous seedling of this species is described in my paper on the Leguminosae.<sup>2</sup> The root is triarch, and each cotyledon takes one whole root xylem united with half of the third intercotyledonary xylem bundle.

A single syncotylous seedling was examined, the two cotyledons being fused to the tips, with only a very shallow apical sinus marking the line of union (Fig. 1): a double system of vascular bundles was evident in the seed-leaf. The root was triarch, as in the dicotyl, and the whole process of transition took place in precisely the same way: the sole difference from the type being that both double bundles entered the single seed-leaf (Fig. 2). The subsequent branching and anastomosing of the bundles took place in the usual fashion.

This is an example of the simplest type of syncotyly, in which there is practically no modification of the vascular anatomy introduced by the lateral union of the two cotyledons, even though this be complete. The simplicity of the bundle system probably accounts for this. When we

<sup>1</sup> de Vries ('95, '11).

<sup>2</sup> Compton ('12<sup>b</sup>), p. 44, and Pl. VI, Fig. 93.



examine other species with more complex vascular anatomy we find that fusion of cotyledons has led to reduction in the total vascular system of the seed-leaves, this being so pronounced in the more advanced cases of syncotyly as to affect the hypocotyl and root.

*HELIANTHUS ANNUUS* (Compositae).

The material examined was grown from seeds, provided by Professor H. de Vries, of a strain which produced from 50 to 95% of more or less syncotyloous seedlings.<sup>1</sup>

The seedlings showed a great range of variation from normal dicotyls to syncotylys with completely fused cotyledons and to amphisyncotylys. The syncotyloous seedlings were all more or less dwarfed and grew irregularly, the plumule having much difficulty in developing.

The vascular anatomy showed a corresponding range of variation, and several examples must be described.

**Dicotyls.** The anatomy of very young seedlings has been described by Chauveaud.<sup>2</sup> The older stages of development were studied by Reinke,<sup>3</sup> whose description the present author is able to confirm. For the sake of convenience and completeness the dicotyloous structure will here be described, especially as certain new points can be included.

The root is tetrarch, there being a solid four-rayed xylem star without pith, and four phloem groups alternating with the protoxylems. The xylem is usually somewhat irregular, owing to the abundance of lateral roots (Fig. 3). The transition changes begin at a low level in this massive seedling, the pith appearing in the midst of the xylem at about 1 cm. below the collet. The pith rapidly enlarges, and dilates the xylem into the form of a ring which soon opens on one side, the corresponding phloem dividing into two at the same time. Thus at 3 mm. below the collet there is a C-shaped band of xylem with four protoxylems, and five phloem groups (Fig. 4). The xylem-band then begins to break up into detached pieces in the way indicated by the dotted lines in Figs. 4 and 5: the result being the production of two triads, each consisting of a median protoxylem and a pair of lateral metaxylems, and each destined to become the middle vein of one cotyledon; and also of two curious bundles, each consisting of a single metaxylem group with a laterally attached protoxylem, these later dividing and becoming the lateral veins of the two cotyledons. There are now six phloems, one superposed upon each metaxylem (Fig. 6). It is seen that the opening of the xylem-ring on one side only and the formation of a C-shaped band is merely a precocity; and at the level of the collet the vascular system has again become practically symmetrical: this irregularity is, however, of fairly constant occurrence.

<sup>1</sup> de Vries ('95), where a number of seedlings are figured; and ('11), p. 466.

<sup>2</sup> Chauveaud ('11), p. 414.

<sup>3</sup> Reinke ('71), p. 11.

Thus at the base of the hypocotyl there are constituted six collateral bundles of xylem and phloem, and the two small median polar protoxylems (Fig. 6). This condition persists to the summit of the hypocotyl, slight rearrangements in the xylem taking place with the result that each group becomes truly endarch.

In the upper half of the hypocotyl the plumular procambium appears in four tangential bands, each lying between a polar triad and one of the lateral cotyledon traces.

There is a short cotyledon tube, at the base of which the cotyledonary vascular system which has ascended from the root moves outwards, leaving the epicotyledonary procambium behind to pass up into the plumule. The two lateral bundles of the hypocotyl divide radially, and on the cotyledons separating, each takes half of each bundle as well as the main polar triad (Fig. 7).

The base of each cotyledon therefore contains (1) the triad or 'double bundle' (Fig. 8) derived from the whole of a root-xylem; this comprising two collateral bundles of metaxylem and phloem, and a few effete scattered protoxylem elements in between—the latter sometimes accompanied by a tiny detached group of phloem:<sup>1</sup> (2) two collateral bundles, one at each edge of the cotyledon, each derived from half a root xylem.

The cotyledons are slightly asymmetrical, one side being more curved than the other: the venation is shown in Fig. 9.

**Syncotyls.** There are many degrees of fusion of cotyledons, ranging from seedlings whose cotyledons are united by the petioles alone on one side, to those which have apparently a single broad cotyledon with a barely perceptible apical notch, but with a double vascular supply. Amphisyncotyls, i. e. seedlings whose cotyledons are united by both edges, also occur, but more rarely.

The vascular system varies with the degree of fusion of the cotyledons, and a series of cases will be described in order to illustrate the mode of variation.

*Syncotyl A.* The two cotyledons were only united for about 5 mm., and the structure was closely similar to that of a dicotyl. The chief differences are illustrated in Fig. 10. There is a slight asymmetry of structure at the node, the lateral strand which is on the open side of the cotyledon dividing radially earlier than the other. The two edges of the seed-leaf have thus a more complex vascular system than the space between the two double bundles at the same level (Fig. 11). Another point of difference, which, however, has no special connexion with the phenomenon of syncotily, is the presence of an additional collateral bundle in between one of the double bundles and a lateral cotyledon trace; this passes out into the cotyledon and divides with the other bundles, forming part of the

<sup>1</sup> Cf. *Lupinus* spp., Compton ('12<sup>b</sup>), pp. 29, 79.

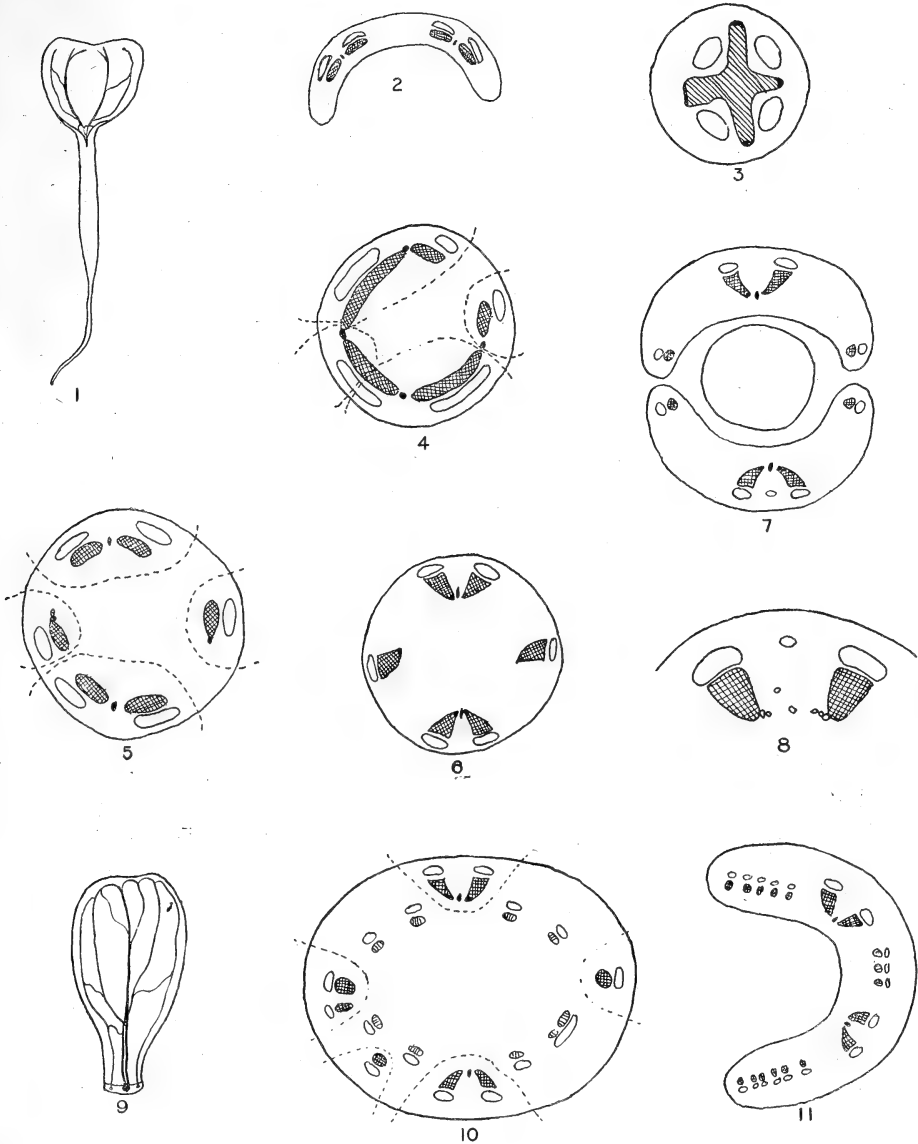

FIGS. 1-11. (Xylem cross-hatched, phloem clear.)

FIGS. 1-2. *Swainsona Cadellii*, syncotyl. 1. Syncotyl. 2. Trans. sect. base of seed-leaf.

FIGS. 3-11. *Helianthus annuus syncotyleus*. 3-9. Dicotyl. 3. Trans. sect. root. 4. Trans. sect. root 3 mm. below collet. 5. Trans. sect. at collet. 6. Trans. sect. 4 mm. above collet. 7. Trans. sect. just above cotyledonary node. 8. Trans. sect. cotyledon: the double bundle (triad). 9. Venation of one of the cotyledons. 10-11. Syncotyl A. 10. Trans. sect. at cotyledonary node (plumular xylems line-shaded). 11. Trans. sect. base of seed-leaf.

vascular supply of the lamina (Figs. 10 and 11). It is the same kind of accessory vascular strand which is of such frequent occurrence in *Phaseolus* spp., and which was called a 'Zwischenstrang' by Dodel:<sup>1</sup> these structures are often present in *Helianthus* also, and usually take their origin at a higher or lower level in the hypocotyl—frequently in the collet region.

*Syncotyl B.* In this seedling the cotyledons were fused together for about half their length (Fig. 12). The root was found to be triarch in the main, though towards the apex it became practically diarch by the disappearance of the protoxylem in the intercotyledonary plane. The triarch star became medullated in the usual way below the collet, and the xylem-ring opened out into the C-shape recorded for dicotyls, but with only three protoxylems: two of the phloems also dividing radially so as to produce five groups (Fig. 13). Just below the collet the xylem-ring broke into pieces as indicated by the dotted lines in Fig. 13, with the production of two ordinary triads (or double bundles) and a single asymmetrical lateral cotyledon trace (Fig. 14). That is to say, we have the dicotylous structure with the omission of one of the lateral cotyledon traces, viz. the one on the side of the axis on which the cotyledons had united. The condition of Fig. 15 was reached about 2 mm. above the collet and persisted through the greater part of the hypocotyl. In the upper part of the axis plumular bundles appeared, but no 'Zwischenstränge' were present in this seedling (Fig. 16). The single lateral cotyledon trace behaved in the same way, dividing between the two edges of the seed-leaf (Fig. 17).

Thus the first marked effect of syncotyly on anatomy is simply the elimination of one of the two lateral cotyledon traces, and the corresponding reduction of the root stele from tetrarchy to triarchy.

*Syncotyl C.* The cotyledons were fused for about three-quarters of their whole length. The root was triarch and the general structure was very similar to that of Syncotyl B, except that through the greater part of the hypocotyl the adjacent metaxylems of the two double bundles were almost in contact with one another, their phloem groups not separating until just below the cotyledonary node. A further difference was the presence of an accessory cotyledon strand (cf. Syncotyl A).

*Syncotyl D.* The cotyledons were united to the tip, there being a scarcely perceptible sinus to mark the line of fusion. This seedling carried further the modification foreshadowed in Syncotyl C. The two adjacent metaxylems of the triads lay practically in contact from the root to some distance up the cotyledon lamina, and the superjacent phloem group remained entire throughout the axis (Fig. 18). The lateral cotyledon trace on the side away from the fusion occurred and behaved as usual.

Advanced syncotyly thus results in considerable compression of the vascular system towards the line of fusion.

<sup>1</sup> Dodel ('72), p. 156; Compton ('12<sup>b</sup>), p. 61.

*Syncotyl E.* Complete syncotily obtained here, as in Syncotyl D, accompanied, however, by a further reduction. One of the triads had here lost the metaxylem group towards the line of fusion. Thus the seed-leaf traces consisted of (i) a normal 'double bundle'; (ii) a 'double bundle' with only one metaxylem group and a protoxylem; (iii) a lateral bundle; (iv) an accessory cotyledon trace (Fig. 19). The root was triarch, as usual in all except slight degrees of syncotily. It is doubtful whether this asymmetrical elimination of a single metaxylem should be considered as a stage in the series of reductions and compressions following upon syncotily; this was the only example of the kind seen, most of the advanced syncotyls approximating to type D.

*Other Types of Structure.* The syncotyls are frequently misshapen and twisted owing to difficulties in the process of extraction from the testa, growth inequalities, and, later, obstruction to the plumule. The anatomy often reflects these deformations, and examples were studied whose structure it was found impossible to relate to the normal syncotylous series. No useful purpose would be served by describing these seedlings, whose whole appearance was rather pathological than teratological.

In one seedling an accessory bundle ('Zwischenstrang') was prolonged downwards into the root, there giving rise to an additional xylem pole. This was in an example of advanced syncotily whose root would normally have been triarch, but that the addition of the accessory strand rendered it tetrarch. A similar occurrence in a dicotyl would produce a pentarch root, and pentarchy has actually been recorded in *Helianthus annuus* by Kattein;<sup>1</sup> but in this case it appears that the accessory strand was fused with the adjacent lateral cotyledon trace.

The effects of syncotily in *Helianthus annuus* are therefore as follows, according to the degree of fusion:

- (i) Retardation of division of the lateral cotyledon trace on the side of fusion.
- (ii) Elimination of this lateral cotyledon trace, reduction to triarchy.
- (iii) Compression of the triads towards the line of fusion.
- (iv) Partial union of adjacent triad metaxylems.
- (v) ? Elimination of one of the triad metaxylems towards the symphysis.

#### PRUNUS DOMESTICA.

Examples of dicotyls and syncotyls of certain cultivated Plums were given me by Mr. W. O. Backhouse, of the John Innes Horticultural Institute: these exhibit a state of affairs much the same as in *Helianthus annuus syncotyleus*. The dicotyl is tetrarch, and each cotyledon takes a median

<sup>1</sup> Kattein ('97), p. 129. The structure of tetrarch seedlings is also described, but no notice is taken of the median polar protoxylems of the triads.

triad and two edge-veins, each derived from half one of the intercotyledonary root-poles. Syncotyly results in a reduction to triarchy and the elimination of one of the lateral cotyledon traces, just as in *Helianthus*.

#### GENERAL REMARKS ON SYNCOTYLY.

A great number of dicotylous seedlings normally exhibit a small degree of syncotyly. This is a common occurrence in the Papilionatae, where the cotyledons are frequently united for a millimetre or two along the straighter edges—i. e. the edges against the accumbent radicle in the seed and opposite the first leaf (when unpaired). It is noteworthy that in many such cases among the Leguminosae the seedlings are triarch, and the vascular system is thus roughly similar in plan to that of a moderately syncotylous *Helianthus* such as Seedling B.<sup>1</sup> In the syncotyl of *Swainsona Cadelli*, indeed, we have a normally triarch structure remaining practically unaltered by the fusion. But we can hardly attribute triarchy to syncotyly in the Leguminosae, for the real problem in the case of small triarch seedlings is not the disappearance of one intercotyledonary bundle but the retention of the other; and this, as I have endeavoured to show elsewhere, is related to the useful supplementary function performed by the retained bundle in relation to the first primordial leaf.<sup>2</sup>

The chief interest of syncotyly is in relation to the vexed question of the origin of Monocotyledons. It is widely admitted that the forms with one seed-leaf have been derived from ancestors with two, and the problem is the method or methods by which this reduction in number has occurred. The two possible methods by which one seed-leaf may be derived from two are (1) by lateral fusion or syncotyly; (2) by the elimination or change in function of one cotyledon, or heterocotyly. Both these methods have been supposed to have taken place in various instances, and the rival schools, assuming monophylysis of the Monocotyledons, have warmly debated the alternatives. One of the most recent presentments of the problem, however, is that of Lotsy,<sup>3</sup> who considers that the Monocotyledons are at least diphyletic, and that both methods may have been adopted in different groups. Lotsy considers that the syncotylous origin of monocotyly is less well established than the heterocotylous, but that the former view derives support from the occurrence of syncotyly among undoubted Dicotyledons. He, indeed, regards the theory that the epiblast and the scutellum in the Gramineae are respectively equivalent to reduced and suctorial cotyledons as better supported than the syncotylous theory of the origin of monocotyledony. Here the present writer cannot follow Lotsy, having regard to the great diversity of opinion which still exists as to the morphology of the Grass embryo. But leaving this point on one side, if we accept the view

<sup>1</sup> Compton ('12<sup>b</sup>).

<sup>2</sup> Compton ('12<sup>b</sup>), p. 101.

<sup>3</sup> Lotsy ('11), p. 624.

that the Spadicifloreae are derived from Dicotyledons of the Piperalean alliance, we may agree that monocotyly has here arisen in the heterocotylyous fashion, as illustrated by certain geophilous species of *Peperomia*.<sup>1</sup> There remains the question of the origin of monocotyly in all the other Monocotyledonous orders, and here it appears that the theory of syncotyly has much to recommend it.

On the side of the Dicotyledons a large number of species are known in which fusion of cotyledons for a greater or less distance has undoubtedly occurred, and is a constant feature of the seedlings. The theory of syncotyly, as expounded by Miss Sargent,<sup>2</sup> is largely based on the resemblances in anatomy between such normally syncotylyous Ranunculaceae and *Ane-marrhena asphodeloides* among the Liliaceae. The syncotyly usually takes the form of the production of a long cotyledonary tube, through the base of which the plumule breaks; but in *Ranunculus chius* the fusion is along one margin only.

In studying such anomalous Dicotyledons comparison can only be made with other related species with two seed-leaves. The advantage of an examination of teratological syncotylys lies in the facts that we can compare them with normal dicotylys of the *same* species, and that a series of degrees of syncotyly can be studied. Unfortunately the material is necessarily scanty, except in such a case as de Vries's *Helianthus annuus syncotyleus*, which throws a high percentage of syncotylys. The criticism that such abnormalities are of no significance will be dismissed by serious students of teratology.

It is hoped that as time goes by it will be possible to obtain further examples of syncotyly to supplement the present account. Imperfect though this is, it throws a certain amount of light on the main problem.

In the first place, syncotyly, when it occurs, is a symmetrical process, both cotyledons taking an equal part in the production of the single seed-leaf. The vascular system, as would be expected, is also symmetrical about the plane in which the fusion takes place, i. e. the intercotyledonary plane, though in no other. In *Swainsona Cadelli* the fusion has no marked effect on the vascular system. This is also the case apparently in *Ranunculus chius*, a normally syncotylyous species, as compared with other Ranunculaceae;<sup>3</sup> but it is noteworthy that *Ranunculus Ficaria*, which Miss Sargent regards as a syncotyl, differs markedly from *R. chius*, the only other syncotylyous species of the genus examined. In *R. chius* the two cotyledons each send a double bundle into the diarch root, the two cotyledonary systems being independent of one another. In *R. Ficaria*, on the other hand, the bilobed seed-leaf only sends one double bundle<sup>4</sup> into the root, this

<sup>1</sup> A. W. Hill ('06).

<sup>2</sup> Sargent ('03), p. 66; and ('08).

<sup>3</sup> Sargent ('03), p. 65.

<sup>4</sup> Some of Sterckx's specimens also had lateral petiolar bundles in addition to the midrib (Sterckx ('99), p. 45).

being derived equally from the two similar lobes of the seed-leaf and from its midrib; the second xylem pole of the diarch root is plumular. The conclusion seems to be that the single seed-leaf of *R. Ficaria* represents a single cotyledon; the fact that it is bilobed cannot by itself be held to indicate syncotyly, for this phenomenon normally occurs in both cotyledons of other species of dicotyls, though there is nothing to suggest their derivation from tetracotylous ancestors (e.g. *Raphanus sativus*, *Eucalyptus orientalis*, *Eschscholtzia californica*,<sup>1</sup> *Schizopetalon* spp., &c.). Moreover, the venation of the seed-leaf of *R. Ficaria*, on which Sterckx lays such stress as being distinct from that of the forked cotyledon of *Raphanus sativus*, is not characteristic of syncotyls; indeed, it can be closely paralleled among hemitri- and hemitetracotyls such as those of *Cannabis sativa* and other species described in another part of the present paper. The presence of a median commissural nerve in the great majority of the seedlings of *R. Ficaria* which I have examined and some of those figured is no argument for either theory, for this may occur in both syncotyls<sup>2</sup> and in schizocotyls;<sup>3</sup> but in specimens of *R. Ficaria*, in which there is scarcely any lobing, the midrib is conspicuous and the venation is on the same general plan as that of the foliage leaves, allowing for differences of shape. There is nothing in the embryogeny of *R. Ficaria* to indicate which method of reduction was adopted; and, as a matter of fact, Hegelmaier<sup>4</sup> and Schmid<sup>5</sup> assume the heterocotylous, Sterckx<sup>6</sup> the syncotylous theory, without entertaining the other alternative.

On the whole the tendency of the evidence seems to be in favour of the view that the seed-leaf of *R. Ficaria* represents a single cotyledon; whether the second ancestral cotyledon has been completely aborted, as contemplated by previous authors, or whether it has been retarded in development and now appears as the first foliage leaf<sup>7</sup> are subsidiary questions which cannot be considered further here.

If we therefore omit *R. Ficaria* from the list of normal syncotyls we are left with two species only, in which there is pronounced cotyledonary fusion along one edge alone. These are *Ranunculus chiuss*, of which Miss Sargent saw three specimens; and perhaps *Anemone apennina*, as to which, however, the contradictory statements of Sterckx<sup>8</sup> leave the facts in some doubt. The production of a long cotyledonary tube and its rupture by the plumule are frequent, and may perhaps be compared to

<sup>1</sup> Kerner and Oliver ('02), p. 621.

<sup>2</sup> Winkler ('84), p. 39.

<sup>3</sup> e.g. in some specimens of *Cannabis sativa*.

<sup>4</sup> Hegelmaier ('78).

<sup>5</sup> Schmid ('02), p. 211.

<sup>6</sup> Sterckx ('99), p. 42.

<sup>7</sup> The second alternative is supported by the facts that (i) 180° separates seed-leaf and first foliage leaf—an argument used by Miss Sargent ('08, p. 157) for syncotyly. (ii) The first foliage leaf trace forms one protoxylem pole of the diarch root, the seed-leaf trace forming the other. (iii) Retardation of development is a marked feature of the embryogeny of *R. Ficaria*, as of the other pseudo-monocotyledons *Corydalis cava* and *Carum Bulbocastanum*.

<sup>8</sup> Sterckx ('99), pp. 34, 80.



teratological amphisyncotyly; but the ordinary form of syncotyly occurring as an abnormality in apocotylous species appears to be extremely rare as a normal feature.

A noteworthy feature of practically all the tube-forming species on record is that the seeds are 'albuminous'; the embryo is small, usually straight, and develops in a homogeneous medium, the endosperm.<sup>1</sup> Embryogeny is likely to be symmetrical under such conditions; and whether or no the presence of endosperm is conducive to conrescence of cotyledons, it seems probable that if such conrescence occurred at all it would affect both edges of the cotyledons equally. The rarity of one-sided syncotyly as a normal feature is therefore intelligible.

On the other hand, a remarkable feature of the species which are normally apocotylous, but occasionally produce syncotylys, is that the great majority of them have 'exalbuminous' seeds.<sup>2</sup> The normally monocotylous Dicotyledons, about which there is doubt as to the means of reduction, are largely exalbuminous, and in many of these the probabilities are apparently in favour of a heterocotylous origin.<sup>3</sup>

The conclusions which may be drawn from these facts are—

1. Syncotyly occurs in a great variety of species, normally or teratologically.
2. In species with albuminous seeds syncotyly usually gives rise to a symmetrical cotyledonary tube.
3. In species with exalbuminous seeds syncotyly is usually asymmetrical, the cotyledons uniting along one edge only.
4. The reason for (2) is probably the homogeneity of the surroundings of the embryo before germination, for (3) the asymmetry of its environment which produces accumbency and other irregularities.

Leaving on one side the Spadicifloreae whose monocotyly is very possibly heterocotylous, there can be little doubt that the Helobieae include those Monocotyledons which are most closely allied to such admittedly

<sup>1</sup> The only exceptions to this rule in the long lists of tube-forming Dicotyledons given by Holm ('99, p. 422) and Miss Sargent ('03, p. 73) are *Serratula radiata*, *Limnanthes Douglasii*, *Cardamine* spp., and perhaps *Megarrhiza californica*. (See Sargent, ('03), p. 83.)

<sup>2</sup> An examination of the species mentioned by de Vries ('11, p. 457 et seq.) and other authors as yielding occasional syncotylys reveals the fact that out of about *thirty-seven* species in which the anomaly is known to occur only the following six have the embryo surrounded by endosperm in the seeds: *Silene hirsuta*, *Phacelia tanacetifolia*, *Anagallis grandiflora*, *Polygonum Fagopyrum*, *Mercurialis annua*, *Urtica dioica*.

Syncotyly is also recorded in Coniferae, often accompanying polycotyly. The most striking example was observed by T. G. Hill and de Fraine ('08, p. 706) in a seedling of *Widdringtonia Whytei*, whose two cotyledons were fused nearly to their tips—a feature which the authors compare with the double needle of *Sciadopitys*. The anatomy was unaffected.

<sup>3</sup> See Miss Sargent's list ('03, p. 76). Abortion or displacement of a cotyledon seems to have been the probable cause in the *Corydalis* spp., *Ranunculus Ficaria*, *Carum Bulbocastanum*, *Pinguicula* spp., and *Abronia* spp.

primitive Dicotyledonous families as the Ranales, and are most probably, therefore, themselves primitive as compared with other Monocotyledonous families. The Helobieae are, however, remarkable among Monocotyledons in possessing exalbuminous seeds. The Ranales, on the other hand, are typically albuminous. No order of Dicotyledons yields so many tube-forming syncotylys as the Ranales, and we may perhaps expect a similar tendency to apply all through the Ranales-Helobieae alliance. Now we have seen that syncotyly in albuminous species usually produces a cotyledonary tube, but that in exalbuminous species the cotyledons tend to fuse on one side only. It is therefore probable that if the Helobieae are descended by syncotyly from exalbuminous dicotylys, the fusion of cotyledons would take place along one edge, and we should obtain an embryo symmetrical about one plane only, and not about two, as in the tube-forming Ranales. This form of embryo is what we actually find in the Helobieae—and, indeed, in the more advanced Monocotyledons generally, where the asymmetric condition may well persist in spite of endosperm in the seeds.

We may conclude that (i) syncotyly is a single phenomenon wherever it occurs, whether affecting one or both edges of the cotyledons; the differences being due to space and symmetry relationships within the developing seed. (ii) Since one-sided syncotyly is the form produced in exalbuminous seeds, this is what would be expected to occur in the primitive and exalbuminous Helobieae if that family had adopted syncotyly. (iii) The Liliifloreae, which according to modern views are very possibly derived from plants sharing many characters of the Helobieae, have retained certain primitive features, and among them tetrarchy and a seed-leaf with two equal vascular bundles as in *Anemarrhena*, though not in the majority of species.

Syncotyly has a more or less pronounced influence upon the vascular structure according as the typical anatomy is complex or simple. In the Ranunculaceae the structure of apocotylous and syncotylous species is closely similar, the diarch root and two double-bundles in the cotyledon occurring throughout; this is so whether a tube be present, as in most syncotylous species,<sup>1</sup> or whether syncotyly be one-sided, as in *Ranunculus chius*.<sup>2</sup> The same is true of the relatively simple *Swainsona Cadelli*, where, be it noticed, the base of the seed-leaf only contains two vascular strands, though the root is triarch. In the larger species, such as *Helianthus annuus* and *Prunus domestica*, where lateral cotyledon traces are present, syncotyly leads to elimination and compression of vascular bundles, together with reduction in the type of symmetry in the root.

The '*Anemarrhena* type' of vascular structure is characterized by the

<sup>1</sup> Sterckx ('99).

<sup>2</sup> Sargent ('03), p. 65.

possession of two vascular strands in the single seed-leaf giving rise to tetrarchy in the root. This type has also been found (with slight modifications) in certain Dicotyledons—viz. *Eranthis hiemalis*<sup>1</sup> and several Cactaceae.<sup>2</sup> The derivation of this type of structure from the stable tetrarch type found in large seedlings seems to have taken place by the crowding together of the double bundle and the two lateral bundles of each cotyledon into a single median vascular strand, the tetrarchy of the root remaining unaltered.<sup>3</sup> If the hypothetical dicotylous ancestors of *Anemarrhena* had such a compressed vascular system we should expect that syncotyly would not modify it greatly; the fact that other tetrarch seedlings show a reduction to triarchy through syncotyly cannot be maintained as an argument against the structure of the tetrarch *Anemarrhena* being produced by these means. In *Helianthus* and *Prunus* syncotyly is superposed on a complex cotyledonary vascular system, and reduction follows. In *Anemarrhena* (as in the instructive Leguminous *Swainsona Cadellii*) simplification of structure had occurred prior to syncotyly, and no further reduction is produced by fusion.

A feature of syncotylous anatomy which may be mentioned here is its similarity in some respects to the structures produced by longitudinal splitting of cotyledons. This parallelism between fusion and fission will be further discussed under Schizocotyly (p. 819).

Finally, there is evidence of the hereditary nature of syncotyly in *Helianthus annuus*, of which de Vries<sup>4</sup> cultivated an intermediate race (or ever-sporting variety) yielding from 50 to 95 per cent. of syncotyls. It appeared probable that similar races could have been isolated from *Mercurialis annua* and *Centranthus macrosiphon*, and also, perhaps, from some other species. A pure-breeding syncotylous variety, however, was not obtained, even after selection through ten generations. Thus there remains some doubt as to whether this teratological syncotyly can be considered as a parallel with that which occurs as a normal feature in so many Dicotyledons, and which it is thought gave rise to monocotyly in *Anemarrhena* and its allies.

#### SCHIZOCOTYLY.

Seedlings with more than two cotyledons are a normal feature in many Gymnospermae, and the question as to the primitiveness or the reverse of polycotyly has given rise to much discussion.<sup>5</sup> In the Angiosperms the phenomenon of polycotyly is extremely rare, being apparently confined to

<sup>1</sup> Sargent ('03).

<sup>2</sup> de Fraine ('10).

<sup>3</sup> An intermediate condition is very frequent among Leguminosae (Compton ('12<sup>b</sup>)).

<sup>4</sup> de Vries ('95); ('11), p. 466.

<sup>5</sup> Duchartre ('48), Dangeard ('92), T. G. Hill and de Fraine ('08-10) taking the view that dicotyly is primitive; Sachs ('82), p. 507, Masters ('91), Dorety ('10) holding the reverse view; Coulter and Chamberlain ('10) considering that 'the question is an open one'.

certain species of *Persoonia* (Proteaceae), *Nuytsia*, and *Loranthus* (Loranthaceae).<sup>1</sup> Other reputed examples have proved to be instances of deeply bifid cotyledons. The view that dicotyly is primitive in Gymnosperms and Angiosperms alike attaches much importance to the occurrence of bilobed seed-leaves; thus Hill and de Fraine<sup>2</sup> consider that in Conifers 'the polycotyledonous condition has been derived from the dicotyledonous condition, in the vast majority of cases by the splitting of the seed-leaves and by the promotion of cotyledons from a lower to a higher rank'. Fletcher also takes the same view for *Persoonia* and *Nuytsia*.<sup>3</sup> The reverse view either takes no account of these abnormalities or regards them as stages in fusion rather than fission.

The cases of teratological schizo- and polycotyly, which will be considered below, are of interest from whichever point of view we regard the phylogenetic problem. If dicotyly be primitive they afford an instructive parallel to the course of evolution of polycotyly; if dicotyly be a derived condition these teratological seedlings may be regarded as reversions to a more primitive type.<sup>4</sup>

A few examples of polycotyly among normally dicotylous species have been studied anatomically, the investigators relying on chance specimens. I have been so fortunate as to receive from Professor H. de Vries a number of packets of seed of several of his schizocotylous races; and although this seed was mostly harvested in 1894, the year when he discontinued his breeding experiments on these races, a large percentage of most of the species germinated and yielded abundant material, exhibiting all degrees of the abnormality. It is mainly on this material, for which, as well as for seed of *Helianthus annuus syncotyleus*, my warm thanks are due to Professor de Vries, that the following statements are founded.

I shall proceed to give some details of the structure of certain schizocotyls, following this by a discussion of the problems of polycotyly.

CANNABIS SATIVA (Urticaceae, or Moraceae).

**Dicotyls.** The hypocotyl is from 6 to 9 cm. long and 0.9 mm. in diameter throughout: the cotyledons are oblong-ovate, 11 by 5 mm.; their venation varies considerably, but usually there is a well-marked midrib in the basal half which may or may not be prolonged to the apex (Fig. 20).

The root has a continuous diarch xylem-plate flanked by two bands of phloem (Fig. 21). The xylem-plate begins to divide transversely at the collet and the phloems divide simultaneously: half-way up the hypocotyl the condition shown in Fig. 22 is attained. This slowly changes, triads being formed about three-quarters up the hypocotyl (Fig. 23), and each

<sup>1</sup> Duchartre ('48), von Müller ('82), Fletcher ('09), Hill and de Fraine ('12).

<sup>2</sup> Hill and de Fraine ('09a), p. 225.

<sup>3</sup> Fletcher ('09), p. 878.

<sup>4</sup> Dorety ('10), p. 428.

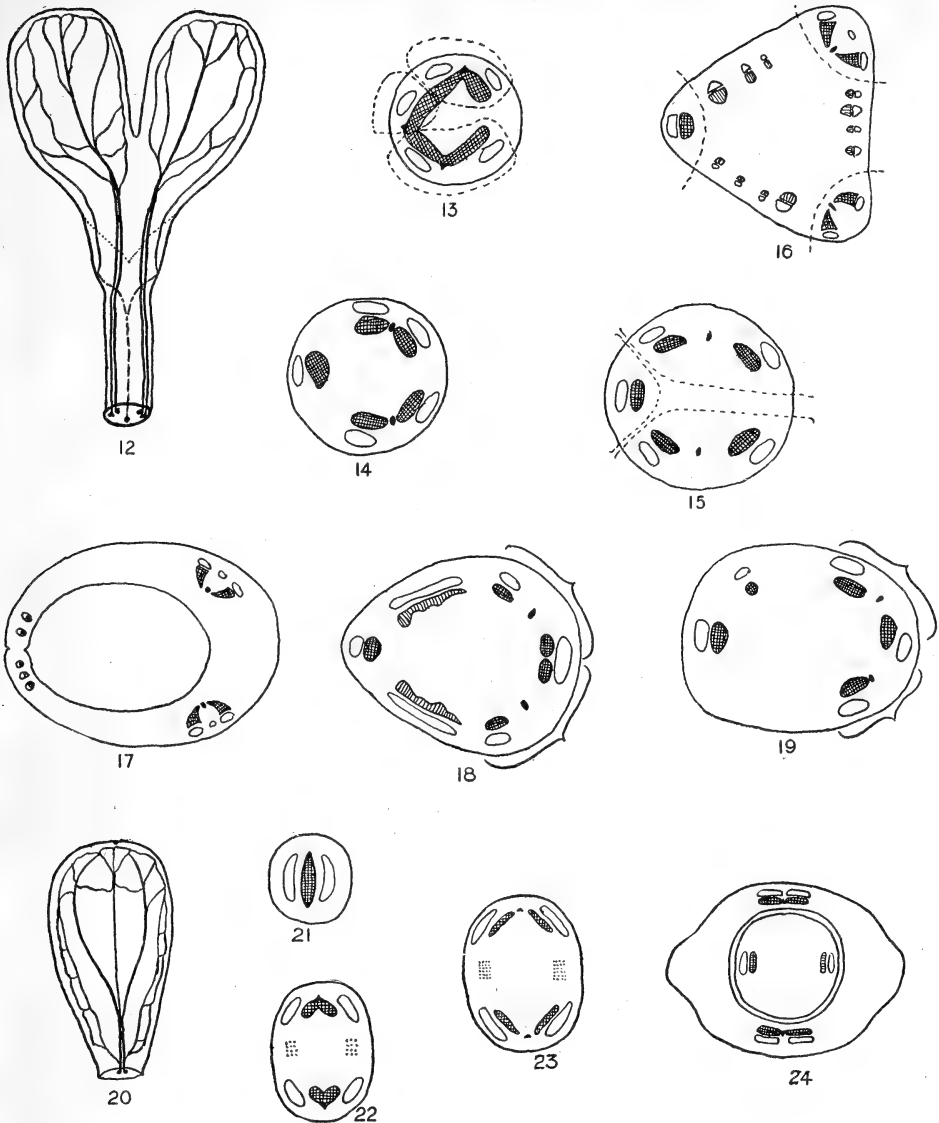

FIGS. 12-24. (Xylem cross-hatched, phloem clear.)

FIGS. 12-19. *Helianthus annuus syncotyleus (continua)*. 12-17. *Syncotyl B*. 12. The seed-leaf, showing course of bundles. 13. Trans. sect. 3 mm. below collet. 14. Trans. sect. 2 mm. below collet. 15. Trans. sect. 2 mm. above collet. 16. Trans. sect.  $\frac{3}{4}$  up hypocotyl. 17. Trans. sect. base of cotyledon tube. 18. *Syncotyl D*. Trans. sect. at summit of hypocotyl. 19. *Syncotyl E*. Trans. sect. at summit of hypocotyl.

FIGS. 20-24. *Cannabis sativa*. 20-24. *Dicotyl*. 20. Cotyledon showing venation. 21. Trans. sect. root. 22. Trans. sect.  $\frac{1}{2}$  up hypocotyl (dotted areas = plumular procambium). 23. Trans. sect.  $\frac{3}{4}$  up hypocotyl. 24. Trans. sect. just above cotyledonary node.

cotyledon takes one of these triads. There is a short cotyledonary tube (Fig. 24). The two main plumular traces appear in the intercotyledonary plane. Thus the transition is of a normal intermediate type, as might be expected in a seedling of this diameter<sup>1</sup>.

The transition has also been described by Gérard,<sup>2</sup> with whose description my own observations agree, except that he says that 'the vascular bundles of the root do not meet in the centre'.

**Schizocotyls.** Numerous examples were seen in which one or both of the cotyledons were more or less deeply bifid. In some cases there was a slight notch of 1 or 2 mm., in others the half-cotyledons were only united by a few millimetres at the base: and intermediate degrees of fission were abundant.

*Hemitricotyl A.* Fig. 25 shows the degree of lobing of the one bifid cotyledon and the venation of the two seed-leaves. Diarchy persisted till after the two root-xylems had separated. Just above the collet one of the protoxylems divided radially and equally, and the distance between the two halves gradually widened: the position at 5 mm. above the collet being shown in Fig. 26. A little higher up a new group of phloem appeared in the segment between the two half-protoxylems, these separating still further, the result being the formation of a middle collateral strand lying between the two half-protoxylems (Fig. 27, at half-way up the hypocotyl). This middle strand then divides radially, and so three triads are organized (Fig. 28); the two arising from one pole of the root entered the bifid seed-leaf, the third entering the entire one. The plumular vascular strands were two in number as in the dicotyl, and lay in the corresponding plane; two primordial leaves were present at the first epicotyledonary node.

*Hemitricotyl B.* The abnormal seed-leaf was divided nearly to the base. The chief difference from *Hemitricotyl A* was that the second pole of the diarch root divided radially 5 mm. below the collet; i. e. below where the transverse division of the two xylems took place (Fig. 29). Corresponding with this, the separation of the two triads serving the split cotyledon took place lower down in the hypocotyl.

*Hemitetracotyl C.* Two cotyledons were present, each being divided to about the same extent as the single split one of *Hemitricotyl A*, and the transition was essentially similar in all three cases; the main difference being that the division of the protoxylems was deferred to a much higher level, to three-quarters up the hypocotyl on one side and to the base of the seed-leaf on the other. Similar instances of slight lack of parallelism between the division of cotyledons and vascular system were frequently observed in other cases.

*Tricotyl D.* The three cotyledons were not exactly equal, one being distinctly larger than the other two. This is a general feature of terato-

<sup>1</sup> Compton ('12), pp. 67, 96.

<sup>2</sup> Gérard ('81), p. 396.

logical tricotylys, and in the present species at least is connected with their origin, the two smaller cotyledons representing the products of fission, as indicated by the anatomy. The mode of folding of the three cotyledons in the seed helps to explain their persistent differences in size and shape; this is shown in transverse section in Fig. 30, the ventral surfaces of the cotyledons being indicated by thicker lines. The two smaller cotyledons are also slightly falcate when unfolded, as shown in Fig. 31 (taken, however, from Tricotyl E): and the venation differs somewhat from that of the whole and symmetrical cotyledon; the two smaller seed-leaves being practically related to one another as object and mirror image.

The root was diarch, but began to become triarch at the collet: the mode in which this was effected was somewhat different from that seen in the above hemitri- and hemitetracotylys. The protoxylem, instead of dividing equally, did not divide at all: a protrusion of metaxylem appeared just below the collet (Fig. 32), and just above the collet this metaxylem acquired a new protoxylem having no connexion with any group lower in the axis (Fig. 33). Corresponding with the protrusion of metaxylem, the superjacent phloem group divided radially. A normal triarch stele was thus organized just above the collet, and this behaved in a precisely analogous fashion to the diarch stele in a dicotyl: three triads being produced, one serving each of the three seed-leaves.

It is noteworthy that this exceptional mode of origin of the third protoxylem is that considered as characteristic of what Hill and de Fraine term a 'subsidiary' cotyledon.<sup>1</sup> I shall return to this later.

*Tricotyl E.* The root was triarch (Fig. 34), and the whole transition was perfectly symmetrical, each cotyledon taking a triad derived from a single root-pole. The first whorl of plumular leaves was also trimerous; and there were three main plumular traces in the upper part of the hypocotyl alternating with the three triads (Fig. 35).

This seedling shows the anomaly in its most complete form: there is nothing to indicate its relations with dicotily, save possibly the slight inequality of the cotyledons (Fig. 31).

*Other Tricotyls.* Nine other completely tricotyloous seedlings were examined: of these, four had diarch, five triarch roots; no corresponding differences being noticed in the cotyledons. One triarch seedling had only two primordial leaves, but the others, diarch and triarch alike, had a trimerous plumule.

*Hemitetracotyl F.* This seedling bore two whole cotyledons and a third divided below half-way. The root was diarch, becoming triarch by division of one protoxylem 2 cm. below the collet; the three protoxylems thus formed supply the three seed-leaves. The other original root-pole forked about one-eighth up the hypocotyl and behaved just like the dividing strand

<sup>1</sup> T. G. Hill and de Fraine ('08), p. 708.

in Hemitricotyl A, forming two triads which enter the split cotyledon. There were three leaves in the first whorl.

*Hemitricotyl G.* A curious example, only observed once, in which the vascular system derived from one root-pole began to fork in the way typical of schizocotyly (cf. Seedling A), although there was no sign of a split in the cotyledon it supplied. It thus appears that the tendency to fork may be manifested in the vascular structure, though not in the external form. The other cotyledon was forked in the usual way.

We may summarize the main features of these anomalous seedlings of *Cannabis sativa* as follows:

- (i) The dicotyl is diarch with an intermediate level of transition.
- (ii) The fission of a cotyledon leads to a fission of the corresponding root-pole or its connexions, at a higher or lower level in the axis roughly according to the degree of splitting. This applies alike to the splitting of one or both cotyledons.
- (iii) There is a continuous series of stages from scarcely perceptible fission to deep lobing and complete tricotily.<sup>1</sup>
- (iv) The vascular structure seems to lag behind the degree of splitting of the cotyledons to some extent (except in Hemitricotyl G), for several examples were seen of complete tricotyls with diarch roots; others, however, had triarch roots and the whole structure was symmetrical about three diameters.
- (v) An instance of a 'subsidiary' cotyledon was observed in Seedling D; the validity of this category is doubtful, for we can hardly assume any phenomenon beyond schizocotyly in this case, whatever we may do in the Conifers.
- (vi) The plumular symmetry lags behind the cotyledonary: we do not find trimery in the epicotyl unless at least three distinct cotyledons are present, and occasionally not even then.

#### ULEX EUROPAEUS (Leguminosae).

The dicotylous anatomy has been described recently.<sup>2</sup> Mr. Bolland, of the Cambridge Agricultural Laboratory, gave me a single hemitricotyl whose lobed cotyledon was divided to within 1 mm. of the base. The structure of this seedling corresponded to some extent with that of *Cannabis sativa* and may be taken next in order.

The root was diarch, and the two polar protoxylems remained undivided to three-quarters up the hypocotyl: the usual processes found in the dicotylous transition taking place, so that two polar bands of xylem are formed each with two phloems. At three-quarters up the hypocotyl one of these phloems gives off a branch towards the cotyledonary plane, and at

<sup>1</sup> And probably tetracotyly, which, however, I have not observed.

<sup>2</sup> Compton ('12), p. 28.



the same time the corresponding protoxylem divides: the phloem branch coming to lie between the two half-protaxylems. A radial division then occurs along the cotyledonary plane on this side, separating the median xylem and phloem into two halves and thus producing two triads which enter the split cotyledon (cf. *Cannabis*, Figs. 27, 28). The other undivided polar protoxylem serves the unsplit cotyledon.

Thus the chief differences from *Cannabis* are (i) the mode of origin of the new phloem group by a branch instead of *de novo* (but cf. *Cannabis*, Seedling D); (ii) the high level at which the xylem forks.

#### PHACELIA TANACETIFOLIA (Hydrophyllaceae).

Abundant schizocotyls were obtained from Professor de Vries's seed: his 'intermediate race' yielding an average of 57% of schizocotyls.<sup>1</sup>

**Dicotyls.** The root is diarch, with a continuous one to two-seriate xylem-plate. In this slender seedling the transition is a high one, the cotyledon xylem-trace being widely V-shaped at the node, with two phloem groups on its flanks; shortly after entering the lamina the phloems fuse dorsally, and the midrib branches. No exceptional features worth recording were observed.

#### Schizocotyls.

*Hemitricotyl A.* The structure was diarch throughout the hypocotyl and in transition; after entering the deeply-split cotyledon the 'double bundle' began to divide equally, each half taking one of the two phloems and passing into the cotyledon lobe.

*Tricotyl B.* The root was diarch. About a quarter up the hypocotyl a new detached protoxylem appeared, dividing the adjacent phloem into two groups: this new xylem gradually increased in size, and joined on to the original diarch xylem-plate half-way up the hypocotyl. Thus a triarch 'root-like' structure was produced. Towards the cotyledonary node the three xylems developed into double bundles, one of which entered each of the three sub-similar seed-leaves.

This 'diarch-triarch' structure is common in tricotyls: there being much variety, however, in the level at which the new protoxylem appears. This method of increase in the number of protoxylems is the one generally adopted in *Phacelia*: *Hemitricotyl A* being the only instance observed of radial division such as is typical of *Cannabis sativa*. It is the method followed by the vascular bundles of so-called 'subsidiary cotyledons' in *Coniferae*.<sup>2</sup>

*Tricotyl C.* The whole seedling was constructed on the triarch plan, from root-tip upwards. The behaviour of the vascular system was strictly analogous with that of the dicotyl. Trimery continues in the epicotyl also.

This symmetrical type of structure is frequent, though perhaps not quite so abundant as varieties of the type of *Tricotyl B*. In seedlings which

<sup>1</sup> de Vries ('11), p. 436.

<sup>2</sup> T. G. Hill and de Fraine ('08), p. 708, &c.

possess it there is absolutely nothing to indicate that tricotyl is derived from dicotyl by splitting.

*Hemitetracotyl D.* There were three cotyledons, one of them being split about half-way. The root and hypocotyl were triarch throughout, the double bundle supplying the split cotyledon not dividing till after it entered the lamina. There were three leaves at the first epicotyledonary node.

*Tetracotyl E.* The root was diarch, with two lateral phloems. A third protoxylem appeared laterally about a quarter up the hypocotyl, this dividing the adjoining phloem into two equal halves; about half-way up the hypocotyl another protoxylem arose *de novo* on the opposite side of the original xylem-plate, this dividing the other phloem. A tetrarch root-structure was thus produced, and the upper half of the hypocotyl had a symmetrical structure, each xylem-pole producing a double bundle which supplied one of the four cotyledons.

The majority of the tetracotyls examined had diarch roots, but there was much variety in the level at which the new protoxylems were added. In one case the stele did not become triarch till three-quarters, and tetrarch till seven-eighths up the hypocotyl. It was general to find one of the new protoxylems appearing at a lower level than the other, though no more than a quarter of the hypocotyl separated them in any case. One seedling was seen which possessed a triarch root, and no instance of tetrarchy occurred in the root.

Tetracotyls have four leaves in their first epicotyledonary whorl.

The most striking feature in the schizocotyls of *Phacelia* is the fact that the vascular strands do not split to correspond with the split of the cotyledons. In all cases (except two, where the division occurred in the lamina) the number of xylem bundles is increased by the addition of new ones, not by the division of old. On tracing the strands from above downwards, we may say that in these cases the traces of certain cotyledons or half-cotyledons do not contribute to the structure of the root, but die out in the hypocotyl. This is the characteristic of 'subsidiary cotyledons'—a category of plant-members which apparently cannot be maintained.

#### *Other Species with Diarch Dicotyls.*

ANTIRRHINUM MAJUS (Scrophulariaceae).

SCROPHULARIA NODOSA (Scrophulariaceae).

AMARANTHUS SPECIOSUS (Amarantaceae).

CLARKIA PULCHELLA (Onagraceae).

PAPAVER RHOEAS (Double and Shirley) (Papaveraceae).

Seeds of schizocotylous races of the first four species were received from Professor de Vries:<sup>1</sup> the Papaver material was derived from trades-

<sup>1</sup> de Vries ('11), pp. 429, 432, &c.

men's seed. A considerable number of seedlings of each species was examined, the specimens ranging from dicotyly to tetracotyly, through all intermediate stages. The structures are very uniform for all the species, and closely resemble those described for *Phacelia*, so that I need not enter into details. The following is a summary of results.

In all the species the root is diarch in the dicotyl, and, since the seedlings are very small and slender, the transition is high, root-structure being found to within one or two millimetres of the cotyledons. Each cotyledon takes the strand derived from a single root-pole and a pair of half-phloems.

Splitting of a cotyledon or an increase in number of cotyledons involves the increase of the number of xylem-poles, this being almost always accomplished by the addition of one or more *de novo*.

Triarchy is frequent in tricotyly and seedlings of higher grades of schizocotyly. Tetrarchy is occasionally found in tetracotyly.

#### LEPIDIUM SATIVUM (Cruciferae).

The cotyledons of Cress are pinnately three-lobed (Fig. 36). It was thus of interest to ascertain if schizocotyly occurs in this species, and, if so, what effect it has. Large sowings were made, and among them were found three tricotylyous seedlings. Each of these seedlings had three equal and similar trilobed cotyledons. One of these was pickled and microtomed; the other two were grown to maturity in pots, and their seeds (self-pollinated or crossed by one another) were sown. The offspring were almost entirely dicotylyous, but after some search four complete tricotyly were found—about 0.5 per cent. of the whole number of seedlings.<sup>1</sup> These four seedlings were also studied anatomically. No other abnormalities of the class we are at present concerned with appeared in the seed-pans.

**Dicotyly.** The root is diarch, and the transition is high. At the cotyledonary node the 'double bundle' is practically tangential. On entering the cotyledon petiole it becomes a single collateral strand, giving off a pair of lateral bundles which pass into the lateral pinnae (Fig. 36).

**Tricotyly.** Three of the five tricotyly (A, B, C) were triarch throughout, the behaviour of the vascular strands being strictly analogous to that found in dicotyly.

One tricotyl (D) showed a diarch xylem in the root; just above the collet a third protoxylem appeared laterally but towards one end, thus not dividing the phloem; the new xylem gradually increased in size until it equalled the two original ones, and a new phloem appeared. The upper part of the hypocotyl was constructed on the triarch plan.

The fifth seedling (E) showed near the root-tip a xylem-plate with one protoxylem at one end, and two somewhat unequal ones at the opposite

<sup>1</sup> It therefore seemed clear that a rich 'intermediate race' was not obtained, and the experiment was discontinued.

end; two phloem bands were present. The xylem gradually became symmetrically triarch, a new phloem appearing in between the two adjoining protoxylems. Doubtless, if the seedling had been a little older, diarchy would have been found at the root-tip; but as it was there was no means of knowing the manner in which the three protoxylems could have joined on to the diarch plate—whether both or only one of the neighbouring ones would be prolonged downwards.

There is nothing in the external morphology of these seedlings to suggest schizocotyly: the vascular system, too, is either trimerous, or the third xylem arises in the 'subsidiary' manner (in D and perhaps also in E). It may be that this is an instance of true meristic variation—'absolute Vermehrung', as Winkler<sup>1</sup> calls it. Winkler, indeed, remarks that this mode of increase in the number of cotyledons is most obvious in seedlings with divided cotyledons; but the argument appears to be fallacious, and at present, owing to the small numbers observed, the question must remain unanswered.

#### LOTUS CORNICULATUS (Leguminosae).

The anatomy of dicotyls of these species has recently been described.<sup>2</sup> The root is normally triarch, each cotyledon receiving an equal share of the root xylem, viz. one whole protoxylem and half of the intercotyledonary protoxylem—the latter, however, being somewhat reduced in bulk. It is therefore a curious problem as to what will be the structure of tricotylous and hemitricotylous seedlings. One of each class was found and studied, with the following results:

*Tricotyl.* The root was triarch, as in dicotyls, and the whole transition was carried out on this plan of symmetry. Each cotyledon took a single triad derived from one root-pole. Thus the behaviour of one of the three root xylems was changed; instead of dividing itself between two cotyledons, as in a dicotyl, it served a single cotyledon.

*Hemitricotyl.* One cotyledon was split for about one-third of its length. The root was triarch, and the whole transition was carried out exactly as in the dicotyl. The base of the split cotyledon contained the usual 'double bundle' with two phloems (Fig. 37). A little distance along the petiole one of these phloems gave off a branch towards the median plane, so that a xylem bundle with three dorsal phloems was produced (Fig. 38). Further along the lamina this vascular complex divided into two equal halves, each consisting of a xylem with two phloem groups—in fact a 'double bundle' (Fig. 39). These two double bundles supplied the two lobes of the bifid cotyledon.

Thus the hemitricotyl yielded no hint as to the mode of origin of the tricotylous type of anatomy.

<sup>1</sup> Winkler ('84), p. 39.

<sup>2</sup> Compton ('12), p. 38.

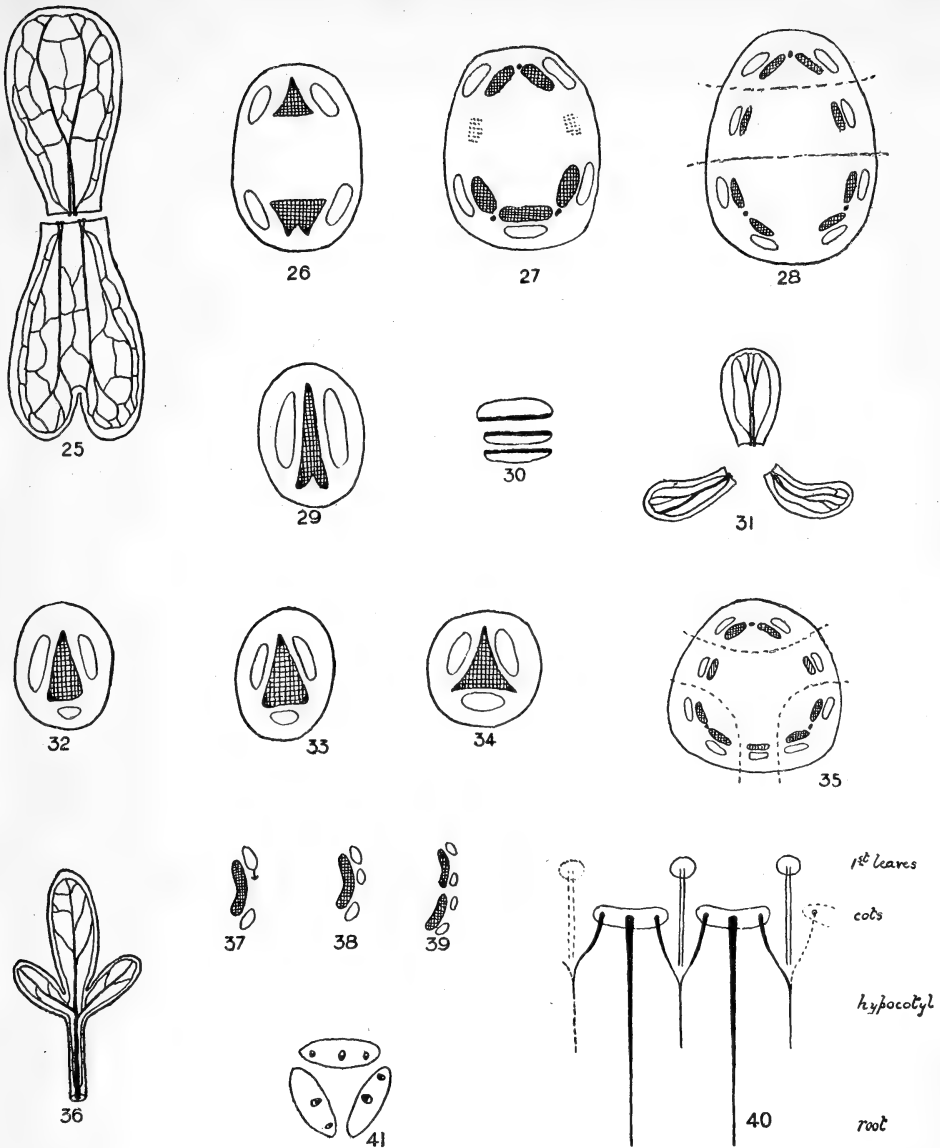

FIGS. 25-41. (Xylem cross-hatched, phloem clear.)

FIGS. 25-35. *Cannabis sativa* (continued). 25-28. *Schizocotyl A*. 25. Two seed-leaves, showing venation. 26. Trans. sect. 5 mm. above collet. 27. Trans. sect.  $\frac{1}{2}$  up hypocotyl. 28. Trans. sect. at summit of hypocotyl. 29. *Schizocotyl B*. Trans. sect. root 5 mm. below collet. 30. Diagram showing mode of folding of the cotyledons of a tricotyl in the seed; upper surface indicated by thick line. 31. *Tricotyl E*. The three cotyledons. 32, 33. *Tricotyl D*. 32. Trans. sect. just below collet. 33. Trans. sect. just above collet. 34-35. *Tricotyl E*. 34. Trans. sect. root. 35. Trans. sect. at summit of hypocotyl.

FIG. 36. *Lepidium sativum*. A cotyledon.

FIGS. 37-39. *Lotus corniculatus*, hemitricotyl. 37. Trans. sect. midrib at base of split cotyledon. 38. Trans. sect. further along petiole. 39. Trans. sect. further still along cotyledon.

FIGS. 40-41. *Helichrysum bracteatum*. 40. *Dicotyl*. Plan of the behaviour of the vascular system. 41. *Tricotyl* (second example): Trans. sect. just above node showing veins of the three cotyledons.

## CARMICHAELIA AUSTRALIS (Leguminosae).

A somewhat similar case to that of *Lotus*. The root of the dicotyl is triarch,<sup>1</sup> the xylem being equally shared between the two cotyledons. In a single tricotyl the root was also triarch, each cotyledon being supplied by one root-pole.

## HELICHRYSUM BRACTEATUM (Compositae).

It is unfortunate that schizocotyls have not been obtained of species with normally a tetrarch symmetry. The nearest approach to this is the above plant, the seed of a schizocotylous race being received from Professor de Vries.<sup>2</sup>

The root in dicotyls is diarch, but about half-way up the hypocotyl two new protoxylem groups appear, one on each side of the xylem-plate, these dividing the original two phloems into four, so that what is apparently a tetrarch structure results. The original root xylems pass out as the midribs of the two cotyledons; the new xylem groups divide, and half of each enters each cotyledon as a lateral nerve, there being no preliminary fusion with the midrib (Fig. 40).

**Tricotyls.** Material was unfortunately scarce, and only two seedlings can be described. These were both complete tricotyls, and their structure was on the whole similar. The root was diarch. A third xylem group appeared about half-way up the hypocotyl, metaxylem first, protoxylem higher up. The lateral cotyledonary traces appeared as usual, these being three in number and alternating with the three root-poles. The upper part of the hypocotyl was constructed on the triarch plan. In one seedling each of the three cotyledons received a whole root-pole and halves of the two adjacent lateral cotyledon traces. In the other seedling two of the lateral cotyledon traces did not divide, but each passed entire to one of the cotyledons; thus two of the cotyledons possessed only a midrib and one lateral bundle (Fig. 41).<sup>3</sup>

## THE LITERATURE OF SCHIZOCOTYLY.

The occurrence of Angiosperm seedlings with an abnormal number of cotyledons has attracted the attention of several writers; and numerous notes have been published dealing with the external features of such seedlings. Reference may be made to the work of Duchartre ('48), Junger ('69-'71), Krause ('80), Winkler ('84, '94), Gain ('00), Thiselton-Dyer ('02), Guillaumin ('11), and Lutz ('11). From the standpoint of Genetics a systematic study of the inheritance of seedling anomalies has been made by de Vries

<sup>1</sup> Compton ('12), p. 43. A rudimentary fourth protoxylem appears at the summit of the hypocotyl.

<sup>2</sup> de Vries ('11), p. 430.

<sup>3</sup> A similar variation was noticed in seedlings of *Lepidium sativum*, where the midrib typically gives off a pair of lateral bundles near its base.

('02, '11). No pure-breeding races of tricotylys were obtained, but 'intermediate races' were frequent.

On the anatomical side schizocotylys have been examined by Léger ('90), in *Acer platanoides*, Gain ('00), in *Phaseolus*, Guillaumin ('11), in *Ruta montana*, and *Schinus terebintifolius*, Lutz ('11), in *Dianthus margaritae*. Notes on their writings will not be out of place here.

*Dianthus margaritae*. A single tricotyl examined by Lutz ('11) showed a triarch structure throughout. No mention is made of the anatomy of dicotylys.

*Ruta montana*. The hypocotyl of a tricotyl showed a triarch symmetry, but Guillaumin ('11) does not mention the root structure nor the dicotylous anatomy.<sup>1</sup>

*Schinus terebintifolius*. A few diagrams are given by Guillaumin ('11), but these throw no light on the structure of the root, nor the transition in dicotylys nor in schizocotylys.

*Acer platanoides*. A full and careful study of a series of schizocotylys has been made by Léger ('90) in this species, which regularly produces a relatively high percentage of abnormal seedlings.<sup>2</sup> The dicotyl is tetrarch, so that Léger's work is complementary to my own, in which no tetrarch seedling is included.

The mode in which the gradual increase in number of cotyledons through schizocotyly is reflected in the structure is somewhat complicated, and reference must be made to Léger's paper for details. The anatomical anomaly may be described as a gradual increase in the importance of the vascular system in the margins of the half-cotyledons adjoining the line of fission. When the fission is deep enough these internal marginal systems produce an augmentation in the number of bundles in the hypocotyl, and finally in the root: complete tricotyly produces pentarchy and hexarchy; tetracotyly produces heptarchy (and octarchy is to be expected).

*Phaseolus* sp. The variety known as 'Haricot beurré nain Mont-d'Or' produces a high percentage of tricotylys, which were studied anatomically by

<sup>1</sup> The genus *Ruta* (like other Rutaceae) is of special interest in this connexion. Gérard ('71), p. 341) states that seedlings of *R. graveolens* are either tricotylylous, or else possess one small and one large forked cotyledon: in the latter case the large cotyledon takes two, the small one of the three root-poles; in the former each cotyledon takes one root-xylen. Duchartre ('48) mentions that *R. montana* and *R. graveolens* are always dicotylylous. The only two seedlings of *R. graveolens* I have seen were both dicotylys with practically equal seed-leaves.

<sup>2</sup> I am permitted by Dr. Ethel de Fraigne to include here the results of an examination of a great number of *Acer* seedlings growing wild or in gardens. In all 7,190 seedlings were collected, and among these 143 showed some abnormality: this being 1.98 per cent. of the whole. The numbers of the different classes were as follows: 2 complete syncotylys, 2 hemisyncotylys, 44 hemitricotylys, 72 tricotylys, 18 hemitetra-cotylys with two split seed-leaves, 2 hemitetra-cotylys with one split and two entire seed-leaves, 3 tetra-cotylys. A higher percentage of schizocotylys occurred among the offspring of cultivated than among that of wild trees. Schizocotylylous seedlings of *Acer pseudo-platanus* have also been figured and described from the morphological point of view by Thiselton-Dyer ('02), who draws attention to the importance of an anatomical study.

Gain ('00). The dicotyl is tetrarch (occasionally pentarch); tricotyls are either pentarch or hexarch. The behaviour of the individual vascular strands was not followed accurately; the author remarks that the structure of the upper part of the hypocotyl of tricotyls 'rappelle tout à fait la structure de la région correspondante des plantules dicotylées' (p. 383). Hemitricotyls were also observed, and exhibited a pentarch symmetry (p. 388).

#### GENERAL REMARKS ON SCHIZOCOTYLY.

In the case of syncotyly it was remarked that all degrees of the anomaly occur, from slightly attached cotyledons to complete fusion. The same is the case in schizocotyly, as has been emphasized by all writers on the subject. There can be scarcely any doubt that polycotyly and schizocotyly in the Angiosperms are one and the same phenomenon. The possession of three equidistant and equal cotyledons is the culmination of a series beginning with a slightly forked cotyledon; there is probably not so much difference between complete tricotyl and advanced hemitricotyly in fact as there is in thought and speech. There is no warrant for assuming more than one process or tendency in schizocotylyous races; though certain cases, perhaps owing to lack of adequate knowledge, may invite a meristic explanation (e. g. *Lepidium sativum*).

At one time I expected that the differences in genetic properties between different tricotylous races might be due to differences in the morphological nature of the anomaly; but no real support for such a view has been obtained. It seems reasonable to think that schizocotyly is the mode of increase of the number of cotyledons in all the above cases.

T. G. Hill and de Fraine ('08-'10), as a result of their extensive study of the seedlings of Gymnosperms, also see in schizocotyly the chief method by which the number of cotyledons has been increased from the primitive dicotylyous condition. But two other methods are also supposed to have been employed. One of these is the shifting of a plumular leaf downwards into the cotyledonary whorl. The other method is of more interest in the present connexion; certain seed-leaves were termed 'subsidiary cotyledons', the criterion of this class of members being the fact that their vascular supply 'plays no important part in the formation of the root structure'.<sup>1</sup>

I have found some difficulty in understanding how far Hill and de Fraine's subsidiary cotyledons constitute a morphological category: they say, for instance, that 'a subsidiary cotyledon may be promoted, as it were, to the rank of a half-cotyledon'<sup>2</sup>—a remark which appears to be unthinkable if taken in connexion with their further statement that 'the seed-leaves, as judged by the behaviour of their bundles in the transition region, naturally fall into three categories, viz. (a) whole cotyledons,

<sup>1</sup> Hill and de Fraine ('08), p. 708.

<sup>2</sup> Loc. cit. ('09), p. 222.



characterized by the bundle of each forming one pole of the root; (*b*) half-cotyledons, which are recognized by the bundles of two of them being required to form one pole of the root structure; and (*c*) subsidiary cotyledons, the strands of which have no influence on the number of bundles in the root structure'.<sup>1</sup>

The fact appears to be that Hill and de Fraine are not justified in arguing from anatomy to morphology in this matter. Their categories apply only to the behaviour of vascular strands (and even here not by any means strictly<sup>2</sup>); they cannot be transferred to the cotyledons.<sup>3</sup>

This may be illustrated by reference to the cases of polycotyly here described. As stated above, everything points to schizocotyly being the explanation of teratological polycotyly; and yet in a great many cases the two vascular strands of the split cotyledon (or of two equal half-cotyledons) do not behave alike, but one of them has the characteristic upon which Hill and de Fraine define a subsidiary cotyledon. (See, for example, *Phacelia tanacetifolia*.) In other cases (e. g. *Cannabis sativa*), the vascular strands of the half-cotyledons are strictly equivalent, and unite to form jointly a single root-pole. It seems quite clear that the distinction between subsidiary cotyledons on the one hand, and half- and whole cotyledons on the other, cannot be maintained. The term 'subsidiary cotyledon' should be restricted to the other use which Hill and de Fraine make of it, viz. to denote a displaced plumular leaf.

With the general conclusions of Hill and de Fraine's work I am in agreement, considering that the evidence for the derivation of polycotylous types from dicotylous ancestors is supported by highly cogent evidence. In addition to the arguments which have previously been brought forward in support of this view we have now the evidence that an increase in number of cotyledons by fission does take place as a more or less heritable anomaly in a great number of Dicotyledons, and that the anatomy of such schizocotyls shows features of close similarity with those described in normally polycotylous Gymnosperms.

Moreover, in the relatively advanced Dicotylous families Proteaceae and Loranthaceae we find a few species whose seedlings are polycotylous and show remarkable resemblances to Coniferous polycotyls; and here, as Fletcher<sup>4</sup> and Hill and de Fraine<sup>5</sup> have recently maintained, there can be practically no doubt that the ancestry was dicotylous.

<sup>1</sup> Hill and de Fraine ('09), p. 221.

<sup>2</sup> This becomes clear from a comparison of the different ways in which they explain the structure of, for instance, *Cupressus torulosa*, series C, *Abies sibirica*, series B, and *Abies amabilis* (('08) p. 699, ('09) pp. 191, 195.

<sup>3</sup> It is clear that the term 'half-cotyledon' implies that the structures in question have arisen by the fission of 'whole-cotyledons'. This, in itself, makes the idea that they can arise by 'promotion' of 'subsidiary cotyledons' unthinkable.

<sup>4</sup> Fletcher ('09), p. 877.

<sup>5</sup> Hill and de Fraine ('12).

It has already been remarked that there is a close similarity between the structure of a seed-leaf produced by fusion and one undergoing fission. This opens the door to the view that dicotyly may have been derived from polycotyly by a series of fusions. It is only possible to decide between the opposing views on the basis of other classes of evidence and on comparative studies.

The only recent argument in favour of a polycotylyous origin of dicotyly in Gymnospermae is that brought forward by Coulter and Chamberlain,<sup>1</sup> who remark that 'it must be remembered that probably our oldest group of Coniferales, older even than the Cycadales and Bennettitales with which we are acquainted, is the extreme illustration of polycotyledony, while the youngest of the Coniferales are dicotyledonous or nearly so'. With the implication of primitiveness in the word 'oldest' I cannot agree, for the argument is founded on our ignorance and the imperfection of the geological record: and almost the whole of modern morphological work tends to the conclusion that it is the dicotylyous Podocarpeae and Araucariaceae which must be regarded as the most primitive Coniferales; the polycotylyous Abietinae, old as they are, being a relatively advanced family.

The earliest known embryo, that of *Bennettites*, was dicotylyous; the cotyledon-bearing Pteridophyte, *Selaginella*, is dicotylyous; and numerous lines of investigation have led to the conclusion that dicotyly is a primitive character—whether for the Monocotyledons, or for teratological syncotyly and schizocotyly, for polycotylyous Proteaceae and Loranthaceae, or for Gymnospermae.

BOTANY SCHOOL,  
CAMBRIDGE.

#### BIBLIOGRAPHY.

- CESALPINI, A. (1583): *De plantis libri XVI*. Florence.
- CHAUVEAUD, G. ('11): L'appareil conducteur des plantes vasculaires. *Ann. Sci. Nat. (Bot.)*, 9<sup>e</sup> sér., t. xiii, p. 113.
- COMPTON, R. H. ('12<sup>a</sup>): Theories of the Anatomical Transition from Root to Stem. *New Phyt.*, xi, p. 13.
- ('12<sup>b</sup>): An Investigation of the Seedling Structure in the Leguminosae. *Journ. Linn. Soc. (Bot.)*, xli, p. 1.
- COULTER, J. M., and CHAMBERLAIN, C. J. ('10): *Morphology of Gymnosperms*. Chicago, p. 297.
- DODEL, A. ('72): Der Uebergang des Dicotyledonen-Stengels in der Pfahlwurzel. *Pringsh. Jahrb.*, viii, p. 149.
- DORETY, H. A. ('10): In J. M. Coulter and C. J. Chamberlain, *Morphology of Gymnosperms*. Chicago, p. 427.
- DUCHARTRE, P. ('48): Sur les embryons dits polycotylys. *Ann. Sci. Nat. (Bot.)*, 3<sup>e</sup> sér., t. x, p. 207.

<sup>1</sup> Coulter and Chamberlain ('10), p. 300. See also Dorety ('10), p. 428.

- FLETCHER, J. J. ('09): Illustrations of Polycotyledony in the Genus *Persoonia*, with some reference to *Nuytsia*. Proc. Linn. Soc. New South Wales, xxxiii, p. 867.
- DE FRAINE, E. ('10): The Seedling Structure of certain Cactaceae. Ann. Bot., xxiv, p. 125.
- GÉRARD, R. ('81): Recherches sur le passage de la racine à la tige. Ann. Sci. Nat. (Bot.), 6<sup>e</sup> sér., t. xi, p. 279.
- GUILLAUMIN, A. ('11): Germinations anormales. Bull. de la Soc. Bot. de France, lviii, p. 481.
- HEGELMAIER, F. ('78): Vergleichende Untersuchungen über Entwicklung dikotyledoner Keime. Stuttgart.
- HILL, A. W. ('06): Morphology and Seedling Structure of the Geophilous Species of *Peperomia*. Ann. Bot., xx, p. 395.
- HILL, T. G., and DE FRAINE, E. ('08-'10): On the Seedling Structure of Gymnosperms. Ann. Bot., xxii, p. 689; xxiii, pp. 189, 433; xxiv, p. 319.
- ('12): On the Influence of the Structure of the Adult Plant upon the Seedling. New Phyt., xi, p. 319.
- HOLM, T. ('99): *Podophyllum peltatum*, a Morphological Study. Bot. Gaz., xxvii, p. 419.
- JUNGER, E. ('69-'71): Ueber tricotyledone Embryonen. Jahresb. d. Schles. Ges., t. xlvj-xlviii.
- KATTEIN, A. ('97): Der morphologische Werth des Centralcylinders der Wurzel. Bot. Centralbl., lxxij, p. 91.
- KERNER, A., and OLIVER, F. W. ('02): The Natural History of Plants, i.
- KRAUSE, K. E. H. ('80): Drei Kotyledonen. Arch. d. Ver. d. Freunde d. Naturg., Mecklenburg, p. 236.
- LÉGER, L. J. ('90): Note sur les germinations anormales d'*Acer platanoides*. Bull. Soc. Linn. de Normandie, 4<sup>e</sup> sér., t. iii, p. 199.
- LOTSY, J. P. ('11): Vorlesungen über botanische Stammesgeschichte. iii, 1.
- LUTZ, L. ('11): Germinations à trois cotylédons. Bull. de la Soc. Bot. de France, lviii, p. 488.
- MASTERS, M. T. ('91): Comparative Morphology, Anatomy, and Life-history of the Coniferae. Journ. Linn. Soc. (Bot.), xxvii, p. 226.
- VON MÜLLER, F. ('82): Plurality of Cotyledons in the Genus *Persoonia*. New Zealand Journ. of Sci., p. 115.
- RAY, J. (1686-1704): Historia plantarum.
- REINKE, J. ('71): Untersuchungen über Wachstumsgeschichte und Morphologie der Phanerogamen-Wurzel. Hanstein's Bot. Abhandl., i. 3.
- SARGANT, E. ('03): A Theory of the Origin of Monocotyledons founded on the Structure of their Seedlings. Ann. Bot., xvii, p. 1.
- ('08): The Reccnstruction of a Race of Primitive Angiosperms. Ann. Bot., xxii, p. 121.
- SCHMID, B. ('02): Beiträge zur Embryo-Entwicklung einiger Dikotylen. Bot. Zeit. lx, i, p. 207.
- STERCKX, R. ('99): Recherches anatomiques sur l'embryon et les plantules dans la famille des Rénouculacées. Mém. Soc. Roy. Sci., Liège, 3<sup>e</sup> sér., t. ii.
- THISELTON-DYER, W. T. ('02): Morphological Notes. VIII. On Polycotyledony. Ann. Bot., xvi, p. 553.
- DE VRIES, H. ('95): Over de Erfelijkheid van Synfisen. Bot. Jaarboek, 1895, p. 129.
- ('02): Ueber tricotyle Rassen. Ber. d. deutsch. bot. Ges., xx, p. 45.
- ('11): The Mutation Theory. Vol. ii, London (Engl. transl.).
- WINKLER, A. ('84): Die Keimblätter der deutschen Dicotylen. Abhandl. d. bot. Ver. Brandenburg, xxvj, p. 30.
- ('94): Anomale Keimungen. Ibid., xxxvi, p. 127.



# FLORAL MECHANISM

By A. H. CHURCH, M.A., D.Sc.

LECTURER IN BOTANY IN THE UNIVERSITY OF OXFORD

The following statement has been drawn up by  
Professor Sydney H. Vines

THE object of this work is to provide the botanical student with a complete description of the development, morphology and mechanism of the principal types of flowers. Whilst giving the kind of information that is to be found in Payer's *Organogénie de la Fleur*, and in the late Professor Eichler's well-known *Blüthendiagramme*, it supplements this with an account of the ecology of the flower, including pollination and the formation of fruit and seed. Hence, when complete, it will be the most comprehensive treatise on the flower that has yet been published.

The general plan of the work may be gathered from Part I, which was published in 1908 as a royal 4to volume of 211 pages. In it are described the following twelve types of floral structure, selected from familiar garden flowers that bloom in the early part of the year (January-April):—

<i>Helleborus niger</i> . . .	Christmas Rose.	<i>Viola odorata</i> . . . . .	Sweet Violet.
<i>Galanthus nivalis</i> . . .	Snowdrop.	<i>Narcissus Pseudo-Narcissus</i>	Daffodil.
<i>Jasminum nudiflorum</i>	White Jasmine.	<i>Erica carnea</i> . . . . .	Heath.
<i>Crocus vernus</i> . . . .	Blue Crocus.	<i>Ribes sanguineum</i> . . . . .	Flowering Currant.
<i>Richardia africana</i> . .	White Arum Lily.	<i>Cydonia japonica</i> . . . . .	Scarlet Cydonia.
<i>Daphne Mezereum</i> . .	Mezereon.	<i>Vinca major</i> . . . . .	Greater Periwinkle.

In connexion with each type, two or three allied species are described for purposes of comparison.

The description of each type is illustrated by a full-page coloured plate, giving an accurate longitudinal section of the flower, and by a black-and-white plate giving the inflorescence, the floral diagram, and other structural details. As each subsidiary species has also a coloured plate allotted to it, the volume contains no less than forty coloured and fourteen uncoloured plates, in addition to a large number of figures, chiefly developmental, included in the text. It can be obtained at the original price of £1 1s. net by subscribers to Part II.

It was hoped that the reception of so striking a volume as Part I would have been such as to justify the Delegates of the Press in proceeding forthwith to publish Part II, the material for which is in readiness. Inasmuch as this anticipation has unfortunately not been realized so far, the Delegates are not disposed to undertake the publication of Part II without some assurance that the necessarily large expenditure involved will meet with the general support of those who, in one way or another, are interested in flowers. But the University Press has received such warm commendations of the work from Botanists who desire to push on the study of Botany in the English-speaking countries that they desire, if possible, to continue publication. They propose, therefore, to ask for subscriptions for copies of Part II at One Guinea each, on the understanding that Part II will, like Part I, consist of descriptions of twelve types of flowers, with allied forms, and be similarly illustrated, though it may be found necessary to reduce somewhat the number of coloured plates. Any copies not subscribed for will not be sold at less than thirty shillings each.

*Science Progress*:—‘Without doubt one of the most interesting botanical books of recent years, and one which in its turn should become a classic.’

*Journal of Botany*:—‘In noticing this very beautiful and elaborate work, one remark seems obvious—there is nothing else like it.’

*Nature*:—‘A valuable contribution to botanical literature, excellent alike in the text and in the illustrations, and the execution is worthy of the Clarendon Press. . . . No botanical school can afford to neglect so valuable and suggestive a storehouse of information.’

Order Forms may be had on application.

# THE JOURNAL OF ECOLOGY

EDITED FOR THE  
BRITISH ECOLOGICAL SOCIETY

BY  
FRANK CAVERS

THE objects of *The Journal of Ecology* are (1) to foster and promote in all ways the study of Ecology in the British Isles, serving as the organ of the BRITISH ECOLOGICAL SOCIETY; (2) to present a record of and commentary upon the progress of Ecology throughout the world. Each quarterly issue contains original articles and notes on ecological topics of current importance, including methods of ecological study and research; notes on current work in the British Isles; reviews and notices of publications of general ecological bearing, of work upon British vegetation, and of work upon foreign vegetation; answers to questions from members of the British Ecological Society, so far as these are of general interest; general correspondence; reports and notices of meetings of the British Ecological Society; progress of the Nature Protection movement and of ecological work in Nature Reserves; list of current literature.

*The Journal of Ecology*, being largely a Review, is indispensable to those desiring to keep abreast of the extensive and widely scattered literature of Ecology, of which it will take a comprehensive view, including in its scope not only work dealing with general principles, methods, surveys, and other ecological studies, but also publications dealing with Geography, Geology, Meteorology, Climatology, Plant Physiology and Anatomy, the science of soils (soil physics, chemistry, and the investigation of soil floras and faunas), and other branches of Natural Science, so far as these have a direct bearing upon Ecology—the relationships of plants to their environment in the widest sense, including the inter-relationships between plants and animals. In brief, it aims at furnishing a comprehensive review of progress in the entire field of Ecology, touching, as this field does, kindred branches of science on various sides.

*The Journal of Ecology* is published quarterly—in March, June, September, and December. The annual subscription price, including postage to any part of the world, for a single copy of each of the four issues making up the annual volume, is Fifteen Shillings (15s.) net; single copies, Five Shillings (5s.) net each. Subscriptions for the *Journal* are payable in advance and should be sent to Mr. C. F. CLAY, Cambridge University Press, Fetter Lane, London, E.C., either direct or through any bookseller.

Members of the British Ecological Society should send their annual subscription to the Society, One Guinea (£1 1s.), which includes the supply of one copy of each of the four issues of the *Journal*, to the Secretary, Dr. F. CAVERS, Goldsmiths' College, New Cross, London, S.E., to whom all Editorial communications should also be addressed.

## *Contents of Vol. I, No. 3. September 1913*

FÜRSTLICH HOHENZOLLERNSCHE NATURSCHUTZGEBIET IM  
BÖHMERWALD. Von H. CONWENTZ.

NOTES ON THE VEGETATION OF WESTON BAY, SOMERSET. By  
E. HELEN STEVENSON.

SOME METHODS OF PLANKTON INVESTIGATION. By G. K. SUTHERLAND.

NOTICES OF PUBLICATIONS OF GENERAL BEARING.

NOTICES OF WORKS ON BRITISH VEGETATION.

NOTICES OF WORKS ON FOREIGN VEGETATION.

16 Text-figures and 5 Plates.

A prospectus giving further particulars as to the *British Ecological Society* and *The Journal of Ecology* will be sent on application to Mr. C. F. CLAY, Manager, Cambridge University Press, Fetter Lane, E.C.

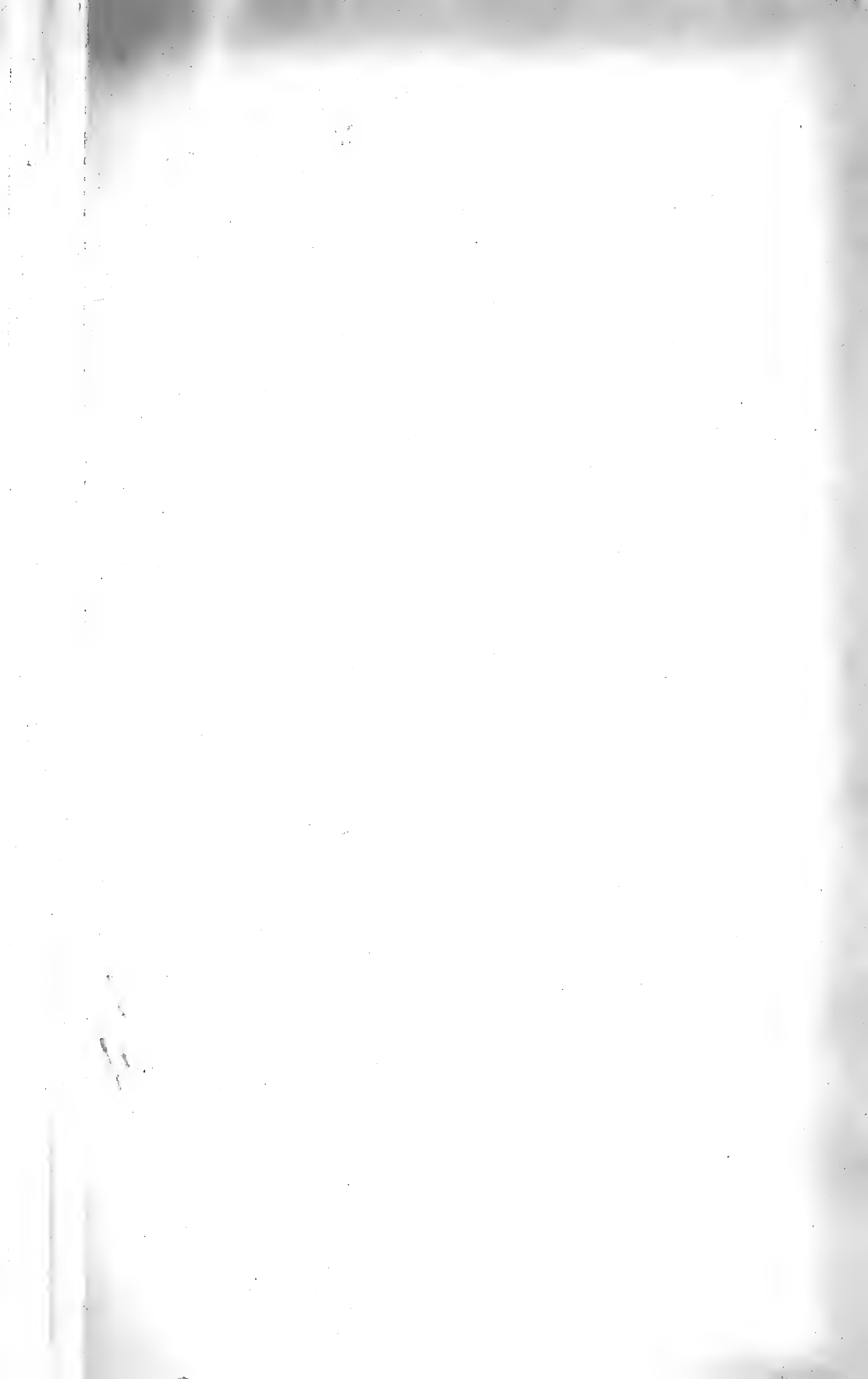

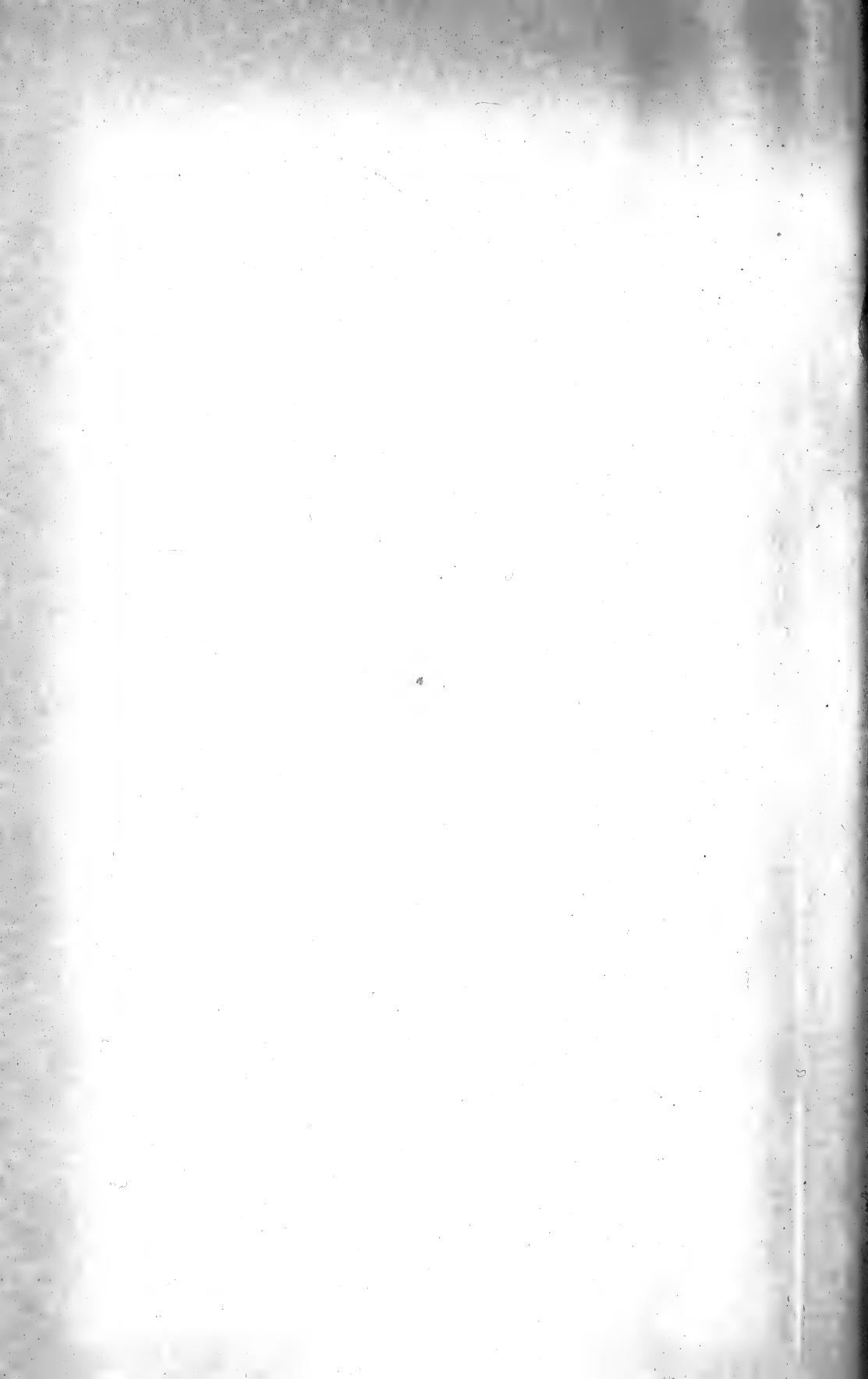



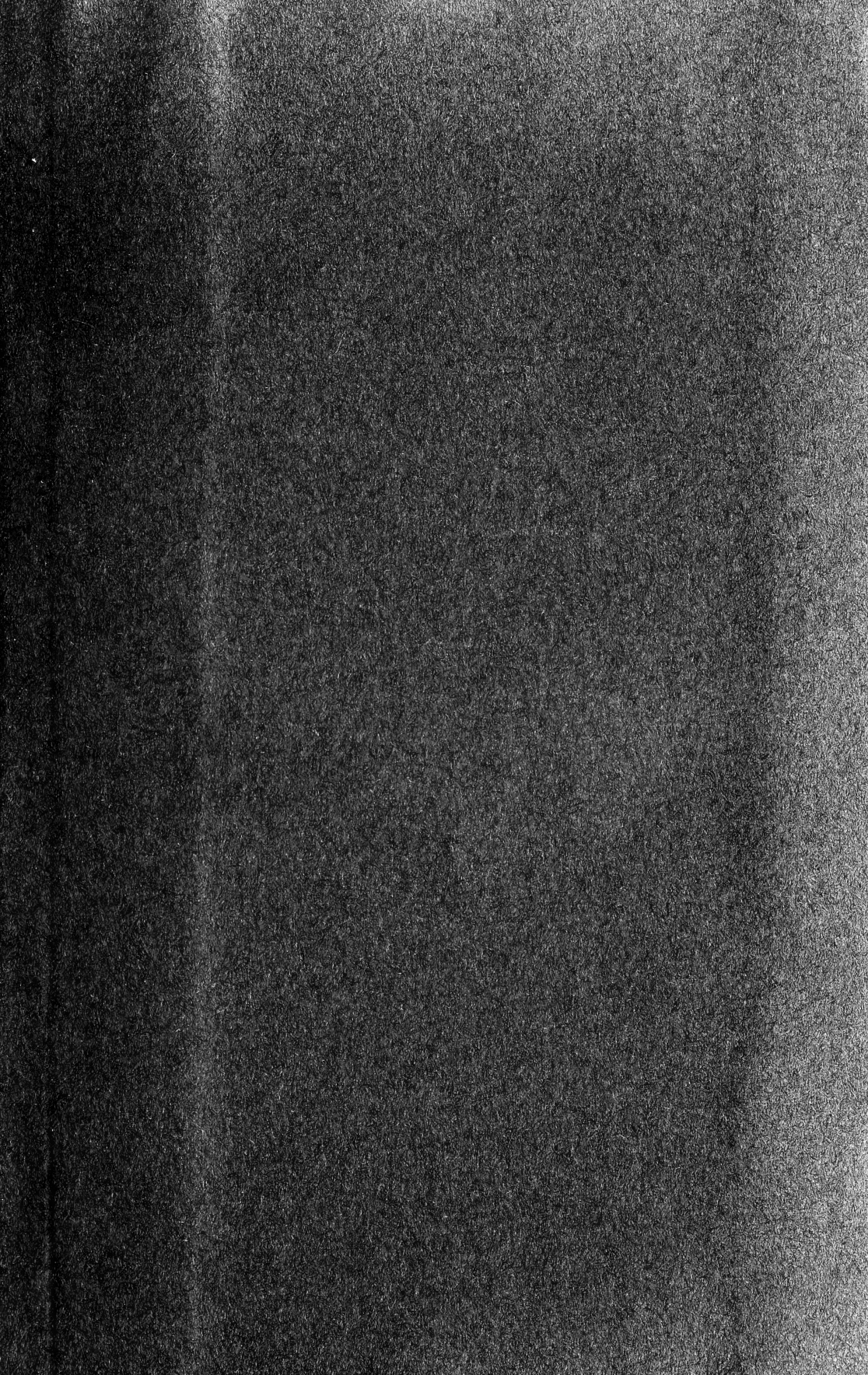



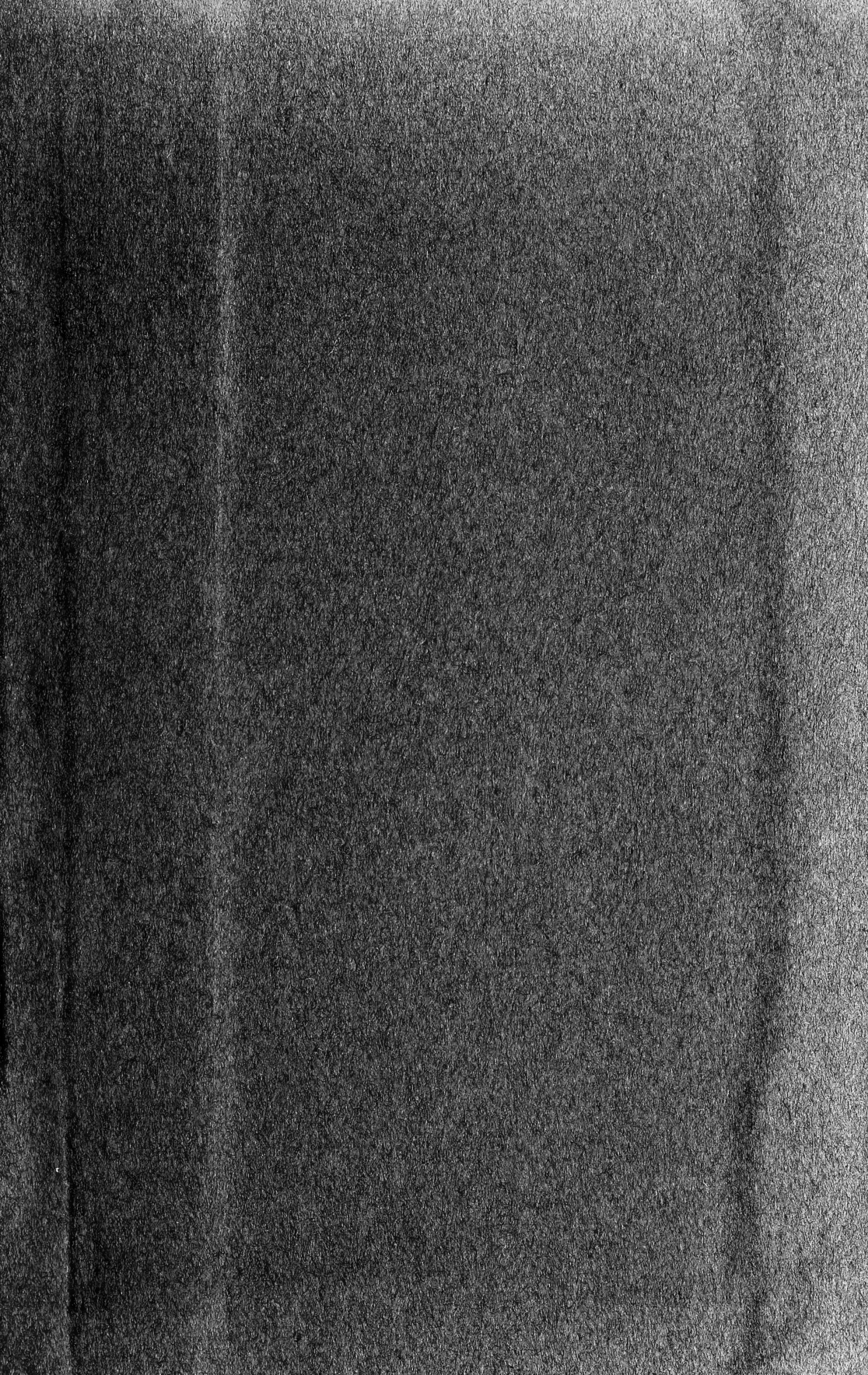

SMITHSONIAN INSTITUTION LIBRARIES



3 9088 00839 3597