



# ANNALS OF PHILOSOPHY;

OR, MAGAZINE OF

CHEMISTRY, MINERALOGY, MECHANICS,

*NATURAL HISTORY,*

AGRICULTURE, AND THE ARTS.

---

---

BY THOMAS THOMSON, M.D. F.R.S. L. & E. F.L.S. &c.

MEMBER OF THE GEOLOGICAL SOCIETY, OF THE WERNERIAN SOCIETY, AND OF THE  
IMPERIAL MEDICO-CHIRURGICAL ACADEMY OF PETERSBURGH.

---

---

VOL. VI.

JULY TO DECEMBER, 1815.

---

London:

*Printed by C. Baldwin, New Bridge-street;*

FOR BALDWIN, CRADOCK, AND JOY,

47, PATERNOSTER-ROW.

SOLD ALSO BY

W. BLACKWOOD, EDINBURGH; AND J. CUMMING, DUBLIN.

---

1815.

TABLE OF CONTENTS

CHEMISTRY, MINERALOGY, MECHANICS  
NUMBER XXXI—JULY, 1831

Some Account of the late Mr. Smithson Tennant, concluded ..... 1

Of a Lead found in the Mountains of Derbyshire, &c. &c. ..... 11

On the Red Sand-stone Formation, by Professor James Hutton, Esq. ..... 18

Of the Method of Illuminating the Streets by Gas-Lights, by Mr. A. C. ..... 20

Remarks on the Chemical Changes which take place in the ..... 20

Sketch of a General Theory of the Intellectual Faculties of Man and ..... 26

Animals, by Mr. W. B. ..... 26

On the Uses of the Doves, &c. &c. ..... 34

An Essay on the Frame in the ..... 43

Extract of a Letter from the ..... 47

Astronomical and Algebraical ..... 51

Recovery of the Acheron, &c. &c. ..... 52

Explosion at the Success, &c. &c. ..... 53

Critical Analysis of the Transactions of the Geological Society, Vol. II. ..... 55

Notice of a new Index of the ..... 55

Philosophical Transactions ..... 55

Proceedings of the Royal Society ..... 55

Prize Question of the Royal Medical Society, Edinburgh, ..... 71

Native Boron Salt, &c. &c. ..... 71

Climate of Athens ..... 71

Table of Passengers, Wagon, Coaches, &c. that pass over Blackfriars ..... 71

Bridges in one Day ..... 71

Further Observations on Mr. Lockhart's Imaginary Case-Rooms ..... 72

Sale of Minerals ..... 74

Newcastle Collieries ..... 74

Size of the Whale ..... 74

Number of Inhabitants of Ayr, &c. &c. ..... 75

Extract of a Letter from M. Van Moede, to Brussels, ..... 75

Death of George Mackenzie, Esq. A.D. 1831, &c. &c. ..... 77

School of Athens ..... 77

Werner's Collections of Minerals, sold ..... 77

Notices of Scientific Books, &c. &c. ..... 79

Meteorological Table and Observations, May 1 to 30, 1831, ..... 79



NUMBER XXXII—AUGUST

Account of the late Mr. Smithson Tennant, concluded ..... 81

# TABLE OF CONTENTS.

NUMBER XXXI.—JULY, 1815.

	Page
Some Account of the late Mr. Smithson Tennant.....	1
Of a Toad found in the Trunk of a Beech. By T. L. Dick, Esq.....	11
On the Red Sand-stone Formation. By Professor Jameson .....	13
On the Method of illuminating the Streets by Coal Gas. By Mr. Accum	16
Remarks on the Older Floetz Strata of England. By Dr. Prichard ....	20
Sketch of a General Theory of the Intellectual Functions of Man and Animals. By Mr. Walker .....	26
On the Uses of the Dorsal Vessel. By M. Marcel de Serres, <i>concluded</i>	34
An Essay on the Rents in the Earth. By Mr. Longmire, <i>continued</i> ....	43
Extract of a Letter from Dr. Berzelius to Professor Gilbert .....	47
Astronomical and Magnetical Observations. By Col. Beaufoy.....	51
Recovery of the Aachen Mass of Native Iron.....	53
Explosion at the Success Coal-pit, near Newbottle .....	55
Critical Analysis of the Transactions of the Geological Society, Vol. II.	56
Notice of a new Index to the Anatomical and Medical Papers in the Phi- losophical Transactions .....	66
Proceedings of the Royal Society, May 25, June 1, 8, and 15 .....	ibid.
————— Linnæan Society, June 6 and 20.....	70
Prize Question of the Royal Medical Society, Edinburgh .....	ibid.
Native Boracic Acid.....	71
Climate of Athens.....	ibid.
Table of Passengers, Waggon, Coaches, &c. that pass over Blackfriars Bridge in one Day.....	ibid.
Further Observations on Mr. Lockhart's Imaginary Cube Roots .....	72
Sale of Minerals .....	74
Newcastle Collieries .....	ibid.
Size of the Whale .....	ibid.
Number of Inhabitants of Ancient Rome.....	75
Extract of a Letter from M. Van Mons, of Brussels.....	ibid.
Death of George Montague, Esq. ....	77
School of Athens .....	ibid.
Werner's Collections of Minerals, sold .....	ibid.
Notices of Scientific Books at Press .....	ibid.
Meteorological Table and Observations, May 1 to 30 .....	79

NUMBER XXXII.—AUGUST.

Account of the late Mr. Smithson Tennant, <i>concluded</i> .....	81
--	----

	Page
Observations on Crystallization. By Dr. John Redman Coxe .....	101
Experiments on the Draught of Carriages. By Mr. Edgeworth .....	106
On Accidents in Coal Mines.....	108
Account of the Sunderland Lime-stone Formation. By Dr. Reid Clanny	115
Sketch of a Theory of the Intellectual Functions of Man and Animals. By Alex. Walker, <i>concluded</i> .....	118
Memoir on Iodine. By M. Gay-Lussac, <i>continued</i> .....	124
Magnetical Observations at Hackney Wick. By Col. Beaufoy.....	132
Critical Analysis of the Philosophical Transactions for 1814, Part II....	134
Proceedings of the Geological Society, May 19 and June 2.....	140
————— Wernerian Society, Jan. 21, Feb. 4, 25, March 11 and 25.....	142
————— Royal Institute of France, 1814 .....	146
Notices of Lectures .....	150
Of Ytthro-Cerite .....	ibid.
— Steinheilite .....	ibid.
— Fluo-Arseniate of Lime.....	ibid.
— Gadolinite .....	151
Mr. Konig on a new Mass of Native Iron.....	ibid.
————— Blumenbach's Arrangement of the Human Species .....	ibid.
Of Orthoceratite in Marble.....	152
On the Extraction of the Cube Roots of Binomials. By Mr. Lockhart ..	ibid.
Explosion at the Isabella Coal Mine, at Newcastle.....	153
Of Nickel-Antimonerz .....	154
— a New Curve .....	ibid.
Nature of Fatty Bodies .....	156
Accident to M. Vauquelin in a Chemical Experiment .....	157
New Patents .....	158
Meteorological Table and Observations, May 31 to June 28 .....	159

NUMBER XXXIII.—SEPTEMBER.

Biographical Account of M. Parmentier. By M. Cuvier .....	161
Origin of the Carbureted Hydrogen Gas of Coal Mines. By Mr. Longmire	172
Connexion between the Vascular and Extra-vascular Parts of Animals. By Mr. Carlisle .....	174
Further Observations on Fluxions. By Mr. Alex. Christison .....	178
Memoir on Iodine. By M. Gay-Lussac, <i>concluded</i> .....	183
Experiments on Tungsten. By Professor Bucholz .....	198
Description of an Elementary Galvanic Battery. By Dr. Wollaston....	209
Objections to Sir H. Davy's Theory of Chlorine. By Dr. Berzelius ....	211
Essay on the Rents in the Earth. By Mr. Longmire, <i>continued</i> .....	213
Magnetical Observations at Hackney Wick. By Col. Beaufoy.....	218
Critical Analysis of the Philosophical Transactions for 1815, Part I....	219
————— Buchanan's Treatise on the Management of Fuel, &c. 222	222

	Page
Critical Analysis of Accum's Treatise on Gas Light.....	223
Proceedings of the Royal Institute of France .....	ibid.
Notices of Lectures .....	229
New Mode of Manufacturing Hemp and Flax .....	230
Proposal respecting the Thermometer .....	231
On Chemical Nomenclature .....	ibid.
Of Howard's Nomenclature of Clouds .....	234
New Amalgam of Mercury .....	ibid.
— Galvanic Experiments .....	ibid.
Further Queries respecting Gas Light .....	235
Of Crystals of Arragonite.....	ibid.
Combustion of Carbureted Hydrogen Gas .....	236
Another Accident at a Coal Mine near Newcastle.....	ibid.
Carbonate of Bismuth.....	ibid.
Carbo-sulphuret of Mercury.....	237
New Patents .....	ibid.
Notices of Scientific Books at Press .....	238
Meteorological Table and Observations, June 29 to July 28.....	239

—◆—

NUMBER XXXIV.—OCTOBER.

On the Absorption of the Gases by different Bodies. By Theodore de Saussure .....	241
Analysis of the Mineral Waters of Dunblane and Pitcaithly, &c. By Dr. Murray .....	256
Observations on the Analysis of Organic Substances. By Dr. Prout ....	269
Description of an Instrument to Measure the Rise and Fall of the Tide. By Col. Beaufoy.....	273
New and important Combinations with the Camera Lucida. By W. G. Horner, Esq. ....	281
An Attempt to systematize Anatomy, Physiology, and Pathology. By Alex. Walker .....	283
Astronomical and Magnetical Observations at Hackney Wick. By Col. Beaufoy.....	293
Critical Analysis of Wainewright's Literary and Scientific Pursuits in the University of Cambridge .....	294
Notices of Lectures.....	304
Substance sublimed during the burning of London Bricks .....	ibid.
Queries respecting Valves, and of the Valves in the Human Body .....	305
Regulations for the Examination of Apothecaries .....	307
Extracts from the new Apothecaries' Act .....	308
Further Observations on Mr. Lockhart's Extraction of the Cube Roots of Binomials .....	309
Test of Iodine .....	312
Rapid Intercourse through Great Britain ..	ibid.



	Page
Description of the Woops: and Observations on the Size of the Whale.	
By Mr. Scoresby .....	313
On Spring Carriages. By Mr. Edgeworth .....	314
— Carbonate of Bismuth .....	315
Table Mountain at the Cape of Good Hope .....	ibid.
New Patents.....	316
Scientific Books in hand .....	317
Meteorological Table and Observations, Aug. 11 to 26.....	318
----- Aug. 27 to Sept. 25 .....	319

◆

NUMBER XXXV.—NOVEMBER.

Relation between the Specific Gravity of Bodies in their Gaseous State and the Weight of their Atoms .....	321
On the Absorption of the Gases by different Bodies. By M. de Saussure, <i>concluded</i> .....	331
Analysis of the Mineral Waters of Dunblane and Pitcaithly. By Dr. Murray, <i>concluded</i> .....	347
Geological Observations on North Wales. By Dr. Prichard.....	363
Register of the Weather at Plymouth, January to June, 1815. By Mr. Fox, jun. ....	866
Observations on Mr. Dalton's Theory of Chemical Composition. By Mr. Ewart .....	371
Magnetical Observations at Hackney Wick. By Col. Beaufoy.....	378
On the Theory of Radiant Heat; and on some Difficulties started against the Theory. By M. P. Prevost .....	379
Account of a Work entitled Hints for establishing an Office in Newcastle for collecting Information on the State of the Collieries. By Mr. Thomas .....	385
Proceedings of the Royal Institute of France for 1814.....	387
Notices of Lectures .....	391
The largest Diamond .....	ibid.
New Voyage of Discovery to Africa .....	392
Death of Gehlen .....	ibid.
Confirmation of Mr. Rose's Discovery of the Absence of Urea from Urine of Hepatitis .....	ibid.
Atmospheric Phenomenon.....	393
Queries respecting Fluxions .....	394
Errors in the Connoissance des Temps.....	ibid.
Weather in Iceland in 1814.....	395
Population of the Canaries.....	396
Temperature of the Atlantic.....	ibid.
Fucus Vesiculosus .....	ibid.
Animal Concretion from the Uterus.....	397

	Page
Saliva of a Patient under a Course of Mercury .....	397
New Patents .....	ibid.
Meteorological Table and Observations, Sept. 26 to Oct. 24 .....	399

—◆—

NUMBER XXXVI.—DECEMBER.

Biographical Account of Charles Bossut. By M. Le Chevalier De-lambre .....	401
On Septaria. By Dr. C. Wilkinson.....	408
Essay on Rents in the Earth. By Mr. J. B. Longmire .....	411
On the Collision of perfectly hard Bodies. By Mr. John Gough.....	414
Queries respecting the Ventilation of Coal Mines.....	416
Description of an Instrument for ensuring the Attention of Watchmen. By Henry Beaufoy Esq. ....	418
Further Observations on Fluxions. By Alexander Christison, Esq.....	420
Correction of some defective Statements in different Histories of the Intro- duction of Bleaching by Oxymuriatic Acid. By William Henry, M. D.....	421
On the Conversion of Starch into Sugar. By M. de Saussure.....	424
Answer to Mr. Prevost's Inquiries respecting the Explanation of M. B. Prevost's Experiments on Dew. By Dr. Wells.....	432
Memoir on Iridium and Osmium. By M. Vauquelin.....	433
Proceedings of the Royal Society, November 9, 16, 23.....	453
————— Linnæan Society, November 7, and 21 .....	455
————— Royal Institute of France for 1814 .....	456
Theory of Crystals .....	463
Fluxions .....	464
Account of a Meteor.....	465
Queries respecting Steam Engines and Steam .....	ibid.
Royal Geological Society of Cornwall .....	466
Prussic Acid .....	468
Cyanogen .....	470
Chloro-cyanic Acid .....	ibid.
Dr. Murray, of Edinburgh's, Method of preventing Explosions in Coal Mines from Fire-Damp .....	471
Meteorological Table and Observations, October 25 to November 22 ...	473
Index .....	475

## PLATES IN VOL. VI.

Plates	Page
XXXVI. On Rents in the Earth . . . . .	43
XXXVII. A Fossil Fish found in a Stratum of Lime-Stone. . . . .	116
XXXVIII. On Rents in the earth . . . . .	214
XXXIX. Instrument for registering the Rise and Fall of the Tide . . . .	278
XL. Variations of the Barometer and Thermometer at Plymouth, January to June, 1815 . . . . .	366
XLI. Instrument for ensuring the Attention of Watchmen. . . . .	418



ANNALS  
OF  
PHILOSOPHY.

---

---

JULY, 1815.

---

---

ARTICLE I.

*Some Account of the late Smithson Tennant, Esq.*

WE announced in a former number the death of Smithson Tennant, Esq. F. R. S. Professor of Chemistry in the University of Cambridge: we shall now proceed to lay before our readers some account of his life, studies, and character.

Mr. Tennant may be considered as one of those "who, without much labour, have attained a high reputation, and are mentioned with reverence rather for the possession than the exertion of uncommon abilities."\* Of such a man it is perhaps impossible to give an account, which will satisfy the judgment of his friends, without being suspected by others of considerable exaggeration. Mr. Tennant is only known to the public by his papers in the Philosophical Transactions, which, however admirable as specimens of his scientific powers, afford a very inadequate idea of the real extent of his genius and knowledge. These were in many respects so extraordinary, that it would be taking a most imperfect view of his intellectual character to consider him only as a man of science. Some attempt therefore ought to be made to do justice to his other distinguished attainments; although a certain degree of caution is obviously requisite in speaking of those qualities, however remarkable, which cannot be duly appreciated except by his particular friends.

Smithson Tennant was the only child of the Rev. Calvert Tennant, younger son of a respectable family in Wensley-dale, near Richmond, in Yorkshire, and Vicar of Selby in that county, where

\* Dr. Johnson's Life of Edmund Smith.

Mr. Tennant was born on the 30th of Nov. 1761. His mother, whose maiden name was Mary Daunt, was the daughter of a surgeon of the same town.

Of his father little is known, except that he had been a Fellow of St. John's College, Cambridge, and was a friend of Dr. Rutherford, Regius Professor of Divinity in that University. He was spoken of by his son with the most affectionate gratitude for the care he had bestowed on his education. To this he appears to have devoted himself from his son's earliest infancy; since he began to instruct him in Greek when he was only five years of age.

He had the misfortune to lose his father when he was about nine years old; and some years afterwards, shortly before he attained the age of manhood, was deprived also of his mother, by a very melancholy accident. She was thrown from her horse, whilst riding with her son, and killed on the spot.

Mr. Tennant's education subsequently to his father's death was irregular, and apparently somewhat neglected. He was sent successively to different schools in Yorkshire, at Scorton, Tadcaster, and Beverley. He is described by one who recollects him at the first of these places as being of a grave and pensive cast, with the appearance of being indolent and dispirited, and rarely joining in the amusements of the rest of the boys. Being an only child, and under little restraint when with his mother, he appears to have left home with singular reluctance, and to have had little enjoyment while at school. There is reason indeed to believe that he looked back upon this period with no agreeable recollections, since he very seldom alluded to the events of his early life; and it is in the recollection of the writer of this narrative that, on reading Mr. Gibbon's Memoirs, he entirely concurred in the protest which the historian has entered against the "trite and lavish praise of the happiness of our boyish years."

His talents were not suspected, and, if they had been known, would scarcely perhaps have been understood, by those concerned with his education. He appears, indeed, to have been little indebted for the eminence which he afterwards obtained, to any of his various instructors, and may be considered in a great measure as *self-educated*. This is perhaps more or less true of every person of distinguished talents or vigorous understanding. That it was in a remarkable degree the case of Mr. Tennant, will be evident from the few anecdotes, which are now recollected, of his early life.

He gave many proofs, while very young, of a particular turn for chemistry and natural philosophy, both by reading all books of that description which fell accidentally in his way, and making various little experiments which the perusal of such books suggested. His first experiment (as he has himself related) was made at nine years of age, when he prepared a quantity of gunpowder for fire-works according to directions contained in the Encyclopedia, or some other scientific book to which he had access.

During the time he was at school at Tadcaster, he happened to

be present at a public lecture given by Mr. Walker, formerly well known as a popular teacher of experimental philosophy. Although then very young, he put several pertinent questions to the lecturer respecting some of the experiments, and displayed so much intelligent curiosity as to attract the attention of the audience, and give great additional interest to the lecture. Mr. Walker, sensible of the effect which the boy's presence had produced, requested that he would continue to attend his lectures during the remainder of the course.

From Tadcaster Mr. Tennant was removed to Beverley, then rather a considerable school, under the care of Dr. George Croft, who afterwards obtained ecclesiastical preferment at Birmingham, and became known as a controversial writer. Mr. Tennant went somewhat late to Beverley, and did not readily enter into the studies or discipline of the place. But, although he was singular in his habits, and led rather a sequestered life for a school-boy, he was very far from being idle. There was fortunately a good library belonging to the school, containing a great collection of miscellaneous books, to which he devoted as much time as was in his power. His studies, even at that early period, were principally directed to works of natural philosophy; and Sir Isaac Newton's Treatise on Optics was one of the books which he read with the greatest eagerness.

About the time of quitting school he was very desirous of completing his education under Dr. Priestley, whose reputation, in consequence of his brilliant pneumatic discoveries, was then at its height. His mother seems to have been disposed to gratify him in this particular; but the design was found to be impracticable, in consequence of Dr. Priestley's other engagements.

With such tastes and habits, it cannot be supposed that Mr. Tennant, at the time of his leaving school, was a very regular or accurate classical scholar. Yet for every really useful purpose he possessed the full advantages of a classical education. He had a competent knowledge of Greek, and was well versed in the Latin language. What was still more important, he had acquired a strong feeling, and rational admiration, of the great writers in those languages, whom he justly regarded as the standards of true taste, and models of literary composition; and he continued during the whole of his life to be a diligent reader of the principal Latin Classics.

In the choice of a profession, his attention was naturally directed to the study of medicine, as being most nearly allied to his philosophical pursuits. He went accordingly, about the year 1781, with that view to Edinburgh, where he had the best opportunities of gratifying his favourite tastes; and he had the good fortune to meet with an instructor in the celebrated Dr. Black, well calculated to stimulate and direct his curiosity.

Of his companions, studies, or occupations at Edinburgh, nothing particular is known. His stay, indeed, at that University,

was of no long continuance; for in October, 1782, he was admitted a Member of Christ's College, Cambridge, where he began from that time to reside. He was at first entered as a Pensioner; but, disliking the ordinary discipline and routine of an academical life, he obtained an exemption from those restraints by becoming shortly afterwards a Fellow Commoner.

It was at this period that he began to be intimately connected with Sir Busick Harwood, the late Professor of Anatomy at Cambridge, then also a Fellow Commoner of the same College. During a long residence in the University, Professor Harwood was familiarly known to a very extensive circle of acquaintance, by many of whom he was perhaps chiefly valued for his social and convivial qualities. He had other merits, however, which were of a much higher order; and at the time when he first became acquainted with Mr. T., there were some circumstances connected with his history and situation, which gave a peculiar interest to his character.

Sir B. Harwood had gone out early in life to the East Indies, where he had obtained a competent fortune as a surgeon; but being compelled by ill health to return to his native country, he lost, by the misconduct of an agent, nearly the whole of what he had acquired. With the most cheerful and manly firmness, he began again his career of life; and with that view had entered himself at Cambridge at a much more advanced age than usual, for the purpose of obtaining a medical degree. His misfortunes and the spirit with which he rose above them, added to his liberal and benevolent disposition, his practical skill in medicine, his knowledge of anatomy and physiology, and his interesting accounts of the remote countries in which he had lived, produced their natural effect upon an ingenuous and inquisitive mind; and although there was a great disparity in the ages of Mr. Tennant and Professor Harwood, and a considerable difference in their tastes and habits, a cordial and sincere friendship was soon formed between them.

Having entered somewhat late at Cambridge, and being destined for the medical profession, Mr. Tennant did not pay any great attention to the regular course of academical reading, or devote much of his time to the study of mathematics. He acquired, however, a general knowledge of the elementary parts of that science, and made himself master of the most important propositions in Newton's Principia. But his attention at this period was principally directed to chemistry and botany; and it may be recorded as an instance of his early progress in the former science, that about the time of his residence at Cambridge he mentioned to some of his friends the substance of an experiment respecting heat— which he did not make public till more than twenty years afterwards. The experiment here alluded to consisted in a mode of effecting a double distillation by the same heat, in consequence of a diminished pressure of the air; which he communicated to the Royal Society in 1814, and forms the subject of his last paper published in the Philosophical Transactions.

The attention of the chemical world was at this time principally engaged by the great controversy respecting the antiphlogistic theory, which experienced much opposition in England. It may perhaps be worth mentioning that Mr. Tennant entirely satisfied himself as to the truth of this doctrine, when at Cambridge, at a very early period, and long before it obtained a general reception in this country.

But while engaged in these scientific pursuits, he was at the same time a very general reader of all the most interesting works in polite literature, history, metaphysics, and especially in political economy, which was one of his favourite studies, and on which he had already made many just and original observations. Yet, although he was thus incessantly employed, there was a singular air of carelessness and indifference in his habits and mode of life; and his manners, appearance, and conversation, were the most remote from those of a professed student. His College rooms exhibited a strange disorderly appearance of books, papers, and implements of chemistry, piled up in heaps, or thrown in confusion together. He had no fixed hours or established habits of private study; but his time seemed to be at the disposal of his friends; and he was always ready either for books or philosophical experiments, or for the pleasures of literary society, as inclination or accident might determine. But the disadvantages arising from these irregular habits were much more than counterbalanced by extraordinary powers of memory and understanding; and especially by a faculty, for which he was remarkable, of reading with great rapidity, and of collecting from books, by a slight and cursory inspection, whatever was most interesting and valuable in their contents.

It was during Mr. Tennant's residence at Cambridge that his principal friendships were formed; and the recollection of those who best knew him, will dwell upon this happy period of his life with a fond and melancholy pleasure. His health was then vigorous, his spirits were constant and unwearied, and his talents for society perhaps yet more striking and brilliant than in his after years. He was distinguished, even at that early period, by an extent of information, and maturity of judgment, which might have seemed to be the results of a long life of study and reflection; and these extraordinary attainments derived an additional interest, and peculiar grace, from the simplicity of his manners, the playfulness of his wit, and the careless, fascinating beauties of his conversation!

The summer of 1784 was employed by Mr. Tennant in travelling into Denmark and Sweden, partly to examine the great mines for which the latter country is remarkable, but principally for the purpose of visiting the celebrated Scheele, for whom he had conceived a high admiration. He was much gratified by what he saw of this very eminent person; and was particularly struck with the simplicity of the apparatus by which his great experiments had been performed. On his return to England he had a great pleasure in

showing to his friends at Cambridge various mineralogical specimens with which Scheele had presented him, and in exhibiting to them several interesting experiments which he had learned from that philosopher.

His next journey to the Continent, a year or two after his Swedish expedition, was to Paris, where he became acquainted with some of the most considerable French chemists. During his stay in that city he was seized with a dangerous illness; in consequence of which Professor Harwood, with the kindest solicitude, went immediately to join him; but finding his friend nearly recovered, he accompanied him on a tour through Holland and the Netherlands, previously to their return to Cambridge.

The latter of these countries, at the time when it was visited by Mr. Tennant, was in a state of insurrection against the Emperor Joseph II., and exhibited the singular spectacle of a bigotted people resisting a philosophic tyrant, and contending for their ancient privileges and establishments with the zeal and ardour of an enlightened nation.—Holland, then free and prosperous, presented a scene still more interesting and congenial to Mr. Tennant's feelings. He saw in that extraordinary country a striking illustration of his own most favourite opinions. He was gratified by the triumph of intelligent and persevering industry over the greatest physical difficulties; and by the general diffusion of wealth and comfort, the natural effects of unrestrained commerce, and of civil and religious liberty.

Such were Mr. Tennant's voluntary pursuits and occupations whilst in the prime and vigour of life, possessed of a competent fortune, exempt from every species of controul, and left to the sole guidance of his own disposition and understanding. After his mother's death, which happened about the time when he went to Edinburgh, he had no near relations, and seems from that time to have been entirely separated from his family connections. His college vacations (except when he was travelling) were passed with an intimate friend in North Wales.

On the 13th of January, 1785, he was elected, at a remarkably early age, a Fellow of the Royal Society. Among the signatures to his certificate of recommendation were those of the most distinguished members of that body, who were connected with the University of Cambridge; namely, Dr. Waring, Dr. Milner, Dr. John Jebb, Dr. Maskelyne, and the Bishop of Llandaff. With most of these Mr. T. was well acquainted; and with Dr. Milner, in particular, he lived on terms of some intimacy.

He had hitherto continued to reside at Christ's College from the time of his entering there in the year 1782; but Professor Harwood having for some reason determined to quit that Society, Mr. Tennant removed with him in December, 1786, to Emmanuel College, of which he continued ever afterwards to be a member. In the year 1788 he took his first medical degree as Bachelor of Physic, and soon afterwards quitted Cambridge, and came to reside in London.



In the year 1791 he communicated to the Royal Society his Analysis of the carbonic acid. M. Lavoisier had proved by decisive synthetic experiments that fixed air was a compound of oxygen and charcoal; but no one had yet resolved that gas into its simple elements. Mr. Tennant observing that phosphate of lime was not decomposed, when heated with charcoal, inferred that the joint attractions of phosphorus for oxygen, and of phosphoric acid for lime, exceeded those of charcoal for oxygen, and of carbonic acid for lime; and consequently that phosphorus and heated marble, when made to act on each other, would be resolved into phosphate of lime and charcoal. The correctness of this reasoning was fully justified by the event; and the result of the experiment was not merely the analysis of the carbonic acid, which was the immediate object of the investigation, but the discovery of a new compound, consisting of phosphorus and lime, possessed of several curious properties.

The ingenuity and elegance of this experiment established Mr. Tennant's reputation as a chemist; and there being at the close of that year the prospect of a vacancy in the Jacksonian Professorship at Cambridge by the resignation of Dr. Milner, he was prevailed upon by his friends to become a candidate for that situation; but desisted from the pursuit on finding that he had no reasonable prospect of success.

In the year 1792 he again visited the Continent, with the intention of travelling through France to Italy, and arrived at Paris not long before the memorable 10th of August. He hardly recognized some of his old scientific friends, now become Members of the Legislative Assembly, and deeply implicated in the revolutionary politics of the times. From various circumstances, he anticipated some great and speedy convulsion, and was fortunate enough to quit Paris on the 9th of August, before the flame actually broke out.

In passing through Switzerland he visited Mr. Gibbon, at Lausanne, and was much struck with his powers of conversation, and the sagacity of his remarks on the course and progress of the French revolution, and on the probable issue of the invasion of France by the allied armies under the Duke of Brunswick.

In Italy he was delighted with the softness and beauty of the climate, and the luxuriance of the vegetation, and was astonished by the wonders of ancient and modern art at Rome and Florence. He had hitherto been somewhat sceptical as to the degree of merit really belonging to the great masters in painting, whose fame he had supposed to be founded principally upon exaggeration. But he was converted from this error by the great works of Raphael and Correggio; and of the former, more especially, of these distinguished artists, he was ever afterwards a devoted and enthusiastic admirer.

He returned from Italy through a part of Germany, and was much amused with the mixture of science and credulity which he

found in some of the German chemists. The philosopher's stone was spoken of with respect; and he received from a man of science and character an introduction to a person who was reputed to be in possession of that treasure. Mr. Tennant used to relate with his own peculiar humour the solemnity with which he was received by this person; with whom he conversed in Latin, and who exhibited to him the mysterious powder, enlarging upon its transcendent qualities with much pomp, and in flowing and sonorous periods.

On his return through Paris in the latter end of 1792, or beginning of 1793, he was deeply impressed with the gloom and desolation arising from the system of terror then beginning to prevail in that capital; a particular instance of which deserves, on several accounts, to be recorded.

Among his philosophical acquaintance at Paris, there was one distinguished by his simplicity and moderation, of whose excellent qualities he always expressed a high value. This was M. Delametherie, editor of the *Journal de Physique*. Upon calling at his house, Mr. Tennant found the doors and windows closed, as if the owner was absent. Being at length admitted, he found his friend sitting in a back room, by candle-light, and with shutters closed, in the middle of the day. On his departure, after a hurried and anxious conversation, his friend conjured him not to come again, as the knowledge of his being there might be attended with serious consequences to them both. It should be mentioned, to the honour of this Gentleman, that through all the inquisitions of the revolution he preserved for his friend property of considerable value, which Mr. Tennant had entrusted to his care.

Soon after Mr. T.'s return from the Continent, he took chambers in the Temple, which continued from that time to be his established place of residence; and for many years his society was very much limited to a small circle of friends. Owing to accidental circumstances, his early connections had been much more formed among students of the law than among those of the profession which he had originally designed to pursue, but to which he was gradually becoming more and more indifferent. He had not, however, as yet abandoned the intention of practising medicine; and for several years applied himself to the cultivation of the studies connected with that science, and attended regularly at some of the principal London hospitals. Of his industry and perseverance in this course sufficient proofs exist in the medical notes and memoranda now found among his papers; and it is well known to some of his friends that he had also read with great attention most of the standard books in that science. Among these he always spoke of the works of Sydenham (with reference to the age in which they were produced) in terms of the highest admiration. Curiosity had also led him to examine the principal medical writers of antiquity, whose merits and defects he correctly appreciated, and upon whom he had made many curious and valuable remarks. He had taken a



comprehensive view of the origin and progress of medicine, and of the various medical theories and opinions which have prevailed in different ages and countries; and seemed on this account peculiarly well qualified (independently of his practical knowledge) to have written a philosophical history of the science.

But the question was very different, how far he was well qualified to practise medicine with advantage as a lucrative profession; and the period was now arrived, when this point was to be determined. Several of his friends, although very doubtful as to the ultimate success of the measure which they recommended, were yet extremely desirous that he should try the effects of a regular profession; which they considered as affording the best prospect of giving an useful direction to his talents, and fixing his desultory habits. In deference chiefly to their opinion, he took his degree of Doctor of Physic at Cambridge in the year 1796, and for some time had serious thoughts of commencing medical practice. But, after some hesitation, he wisely relinquished a design, which, whether successful or not, was unlikely to contribute to his happiness. His desires were moderate, and his private fortune exempted him from the necessity of following any employment as the means of subsistence. He was at liberty, therefore, to indulge his own inclinations; and his careless, independent habits of life, no less than the general cast of his character and understanding, rendered him altogether averse to the drudgery and restraints of a profession. It may be observed also as a circumstance by which he was undoubtedly much influenced in adopting this resolution, that he had suffered very greatly, during his attendance at the hospitals, in consequence of the acute and painful emotions he had constantly experienced from those sights of hopeless misery which he had so often occasion to witness. He justly apprehended that the frequent recurrence of such scenes, unavoidable in medical practice, would be destructive of his comfort and happiness.

The keen and exquisite sensibility, from which these feelings originated, was a striking feature in Mr. Tennant's character, and not only gave a colour to many of his opinions, but powerfully influenced his conduct. An instance of his practical benevolence, derived from this principle, happened about this period, which may perhaps deserve to be mentioned. He had a steward in the country in whom he had long placed implicit confidence, and who was considerably indebted to him. In consequence of this man's becoming embarrassed in his circumstances, Mr. T. went into the country, in order to look into his accounts. A time and place were appointed for him to produce his books, and shew the extent of the deficiency; but the unfortunate steward felt himself unequal to the task of such an explanation; and in a fit of despair put an end to his own existence. Touched by this melancholy event, Mr. T. used his utmost exertions for the relief and protection of the family whom he had left, and not only forgave them the debt, but afforded them pecuniary assistance, and continued ever afterwards to be their friend and benefactor.

During the course of the year 1796 Mr. Tennant communicated to the Royal Society his paper on the nature of the Diamond. Sir Isaac Newton had conjectured that this body was inflammable, as was afterwards proved by the experiments of the Duke of Tuscany and of Messrs. Darcet and Rouelle. M. Lavoisier effected its combustion by means of a lens, in close vessels, and obtained from it a gas, which precipitated chalk from lime-water. But this was at an early period of pneumatic chemistry; and although he concluded that the gas was fixed air, yet he did not consider the analogy between charcoal and the diamond as very intimate, but as depending only on their common property of being combustible. The merit of completely ascertaining the nature of this substance was therefore reserved for Mr. Tennant. He succeeded in burning the diamond when reduced to powder, by heating it with nitre in a gold tube. A solution of the alkaline salt was then poured into liquid muriate of lime; and the quantity of carbonic acid which had been generated was inferred from the weight of the precipitate, which was found to consist of carbonate of lime.

From experiments made upon minute quantities of diamond powder, not exceeding  $2\frac{1}{2}$  grains, he shewed, by comparing them with Lavoisier's experiments on charcoal, that equal weights of diamond and charcoal yield equal quantities of fixed air, and that fixed air contains between 27 and 27.8 per cent. of diamond; results which very nearly agreed with those of M. Lavoisier, and were subsequently confirmed by the investigations of Messrs. Allen and Pepys.

In the course of his investigation of the diamond, Mr. Tennant observed that gold and platina were corroded and dissolved by heated nitre; and that on the addition of water to the salt, the metals, owing to the presence of nitrite of potash, were in a great measure precipitated. These appearances, together with some peculiar properties of the nitrous solutions of gold, were the subject of a further communication to the Royal Society in 1797.

It is worthy of remark, that Mr. Tennant had ascertained the true nature of the diamond some years before he made the above communication to the Royal Society. In conversing about this time with a particular friend, whom he was attending with affectionate care during a lingering illness in the spring of 1796, he happened to mention the fact of this discovery. His friend, who had often lamented Mr. T.'s habits of procrastination, urged him to lose no time in making his experiment public; and it was in consequence of these entreaties that the paper on the diamond was produced. A still more remarkable example of the same indolence or inattention occurred in the case before alluded to of the paper on double distillation, communicated to the Royal Society in 1814, the substance of which he had mentioned to some of his friends during his residence at Cambridge.

These facts are memorable and instructive instances of the strength and weakness of Mr. Tennant's mind. His curiosity and activity were incessant; he had a vigilance of observation which

suffered nothing to escape him, and was continually gaining new information from a variety of interesting sources. But although the knowledge thus acquired was remarkable for its correctness, and complete for the purposes of its possessor; yet the industry and perseverance, by which it ought to have been embodied and made permanent for the benefit of others, were too often altogether wanting. The ardour and energy of Mr. Tennant's mind cooperated, unfortunately in this respect, with his want of method and of systematic habits of application; since he was constantly pressing on to new discoveries, instead of arranging and bringing to perfection those which he had already made.—His memory was a great storehouse of discoveries and hints for discovery, of ascertained facts, probable conjectures, and ingenious trains of reasoning, relative to the various important subjects, upon which he had at any time been engaged. These he was continually treasuring up, with the intention of reducing them to order and preparing them for use at a more convenient season. But that period rarely arrived. In the carelessness of intellectual wealth, he neglected the stores of knowledge which he had accumulated, and suffered them to remain useless and unproductive, till his attention was recalled to them, perhaps after a long course of years, by some new fact or discovery, some remark in conversation, or other accidental occurrence. It is yet to be ascertained, by a careful examination of his papers, whether any fragments of this great body of knowledge still remain, which can now be converted to use; whether any of his various discoveries not hitherto made public (some of which unquestionably were important) are capable of being traced out and understood from the loose and imperfect hints which his scattered notes may furnish. But there is too much reason to believe that the far greater part of them existed only in the mind of their author, and that with him they have unfortunately perished!

(To be continued.)

---

## ARTICLE II.

*Account of a Toad found in the Trunk of a Beech.*  
By Thomas Lauder Dick, Esq.

(To Dr. Thomson.)

SIR,

IN your Journal for this month, which has just reached me, I observe some queries have been proposed relative to toads found in rocks and trees. I agree with you, that in every such instance some fissure will be found communicating with the external air, nor have I ever heard of any well-authenticated case to the contrary. I am led to trouble you with this, not with any view of throwing light on

this part of the subject, but to state to you a recent instance of one of those animals being found in a very singular situation. I was not an eye-witness; but the person who has charge of my father's woods here, a man for whose integrity I can be answerable, told me the particulars.

A quantity of timber being felled here, a wright, who had made some purchases, came to take his trees away, and amongst the rest a beech, which had grown with a smooth, straight, unbranched, stem of about 30 feet high, above which it divided into two large limbs. As this tree was lying on the ground, the wright and his man set about cross cutting it with a saw just below the cleft, when, to their surprise, the stem was no sooner divided than a large toad crept out of a circular hole, the upper and smaller part of which had been cut off by the saw. As far as I can make out from conversation with the man above alluded to, the tree had all the appearance of being quite solid above; yet I have no doubt that some slight, though perhaps almost imperceptible, communication, must have existed from the fork into the hole where the toad was lodged; and I am the more satisfied of this from the account which the man gives of the appearance of the interior of the hole, which seemed to be sheathed all round with something resembling bark.

But the curious query arising from this fact is, how came a toad to be lodged so high? The toad has no power of crawling perpendicularly so as to have ascended the smooth bark of a straight tree to such a height. I know from my own observations that trees grow in altitude in two ways: 1st, Something is annually added to the height of the tree by the new shoots: and 2dly, in addition to this mode of increment, the whole tree seems to stretch itself yearly out of the ground, throughout its entire length, to a very considerable extent, as I have proved by measuring the height of knots upon trees at different periods. But with all this I do not think it very rational to suppose that the cleft in question, which may have once extended quite down to the hole, could have ever existed so near the ground of a size sufficient to have admitted of a toad crawling into it. The only way in which it appears to me that this circumstance can be accounted for, is by supposing that the spawn, after being removed from the female by the obstetrical aid of the male toad, must have been transported and dropt into the cleft of the tree by some bird.

As to what Pennant and others say of the obstetrical aid afforded by the male to the female toad, I am led to suspect that the object of the operation is more for the purpose of impregnating the spawn as it is dragged from the female than any thing else. It appears to be the same with frogs. In the course of a solitary walk in the beginning of last March, my attention was excited by an uncommon commotion in a shallow pool of water not much more than four feet square. My approach to ascertain the cause being rather too hasty, I had only time to observe it was occasioned by a parcel of frogs, when immediately on my advance they disappeared under

water, concealing themselves beneath a quantity of spawn already floating on the surface. Having placed myself behind an adjoining hedge, through which I could perfectly see the pool, being about two yards from its surface, and at the same time without giving any disturbance to its inhabitants, I remained quiet for more than a quarter of an hour. At length, when my patience was nearly exhausted, I saw the head of a frog rise above water; and on a closer inspection I perceived underneath the head of another one, which seemed to be embraced by the first. In this way they silently raised themselves pair by pair, till there were not less than 50 or 60 pairs of them in the small space I have already mentioned. In a short time the little pool was all in action. Those frogs which were mounted on the backs of the others seemed to be busily employed with their hinder feet and legs, whilst the fore legs of each firmly embraced the body of his mate. In some too a mass of spawn seemed to move after the pair as they altered their position in the pool. These violent exertions of what I took to be the males continued without any intermission, and with so much force as very considerably to agitate the little pool for some time, until the noise of a person passing on horseback alarmed them, and they were all again under water in a moment. From the hinder parts of what I took to be the female frogs having been so much under water, I could not positively assert the fact, but I had not a doubt, from the nature of the motions I saw, that the animals were engaged in an operation similar to that which is ascribed to the toad; and I was confirmed in this belief by observing on my return, five or six hours afterwards, that the quantity of spawn had been nearly doubled; and though I approached the pool with the utmost caution, I could not see a single frog, and had every reason to think, from a careful examination of the shallow pool, that they were all gone.

I fear the above may be very uninteresting to you; and if so, I have to apologize for troubling you with it.

I have the honour to be, Sir,

Your obedient humble servant,

*Fountain Hall, by Tranent,  
May 8, 1815.*

THOS. LAUDER DICK.

### ARTICLE III.

*On the Red Sand-stone Formation.* By Professor Jameson.

THIS important formation has been met with in the most widely distant parts of the globe, and generally occupying great tracts of country. It rests sometimes on primitive rocks, but more frequently on those of the transition class; and in many countries it is covered

with an extensive series of newer rocks. It is distinctly stratified; and the strata vary from the horizontal to the nearly perpendicular position. The strata are sometimes waved, sometimes disposed in a concentric lamellar manner, but are more frequently straight. Sometimes vertical strata are to be seen meeting others which are in a horizontal position, and occasionally vertical strata are contained in masses of nearly horizontal or slightly inclined strata. Occasionally the strata in a small district appear disposed in every possible position; and at first sight suggest to us the idea either of great original inequalities, or of violent action on the strata after their formation; but which, upon more careful examination and consideration, would seem rather to intimate that the whole mass of strata is composed of a series of distinct concretions, in each of which the layers or strata vary more or less in position.

Red sand-stone contains many different rocks, either in beds, mountain-masses, or veins. The following are the principal kinds of rock I have met with in the red sand-stone of Scotland.

1. *Red-coloured Slate-clay*.—This rock occurs in beds that vary in thickness from a few inches to several fathoms. It is sometimes so highly impregnated with calcareous earth as to pass into marl. Its red colour is sometimes variegated with stripes, layers, and circular portions of a green colour. It passes sometimes into clay-stone, and sometimes into clay-iron-stone. It occurs in Salisbury Craigs, near Edinburgh; Pentland and Ochre Hills; Isle of Arran; Ayrshire, near Saltcoats; Dumfriesshire; Angus-shire, &c.

2. *Clay-stone*.—This mineral occurs in beds that vary in thickness from an inch to several yards. It alternates with the preceding rock, and also with red sand-stone, and some other rocks subordinate to it. It occurs in Salisbury Craigs, Pentland and Ochil Hills; Arran, Ayrshire, Dumfriesshire, Angus-shire, &c.

3. *Clay-iron-stone*.—It occurs in layers, or in irregular shaped masses, generally included in slate-clay. It is a frequent mineral in many red sand-stone districts, as in the Island of Arran, Dumfriesshire, Lothians, Angus-shire, &c.

4. *Trap Tuff*.—This singular and interesting rock occurs in the red sand-stone in beds, which are frequently of great thickness. It passes into clay-stone and red sand-stone. It is by no means an uncommon rock in several of the red sand-stone districts of this country, as in the Lothians, Arran, Angus-shire, &c.

5. *Amygdaloid*.—This rock, like the trap tuff, occurs in great beds or hills connected with the red sand-stone, and occasionally imbedded cotemporaneous masses of it are met with in the sand-stone. It passes into the tuff and sand-stone. It is one of the rocks of the red sand-stone districts in East Lothian and Mid-Lothian, Islands of Bute and Arran, Angus-shire, &c.

6. *Basalt*.—This rock occurs in beds and veins in the red sand-stone of Bute, Arran, Ochils, Pentlands, Lothian, Angus-shire, &c.

7. *Clink-stone*.—This beautiful rock is abundant in several red



sand-stone districts in Scotland, in beds, hills, and veins. The following are a few of the localities of this rock: Arran, East Lothian, Ochils, Pentlands, Angus-shire, &c.

8. *Green-stone*.—Beds, imbedded cotemporaneous masses, mountain masses, hills, and veins, of this rock occur in the red sand-stone formation of Scotland. Thus it is met with in East and Mid Lothian, Ochil Hills, Arran, Bute, Renfrewshire, Ayrshire, Angus-shire, &c.

9. *Pitch-stone*.—Green and black coloured varieties of this rock are met with in the form of imbedded masses, beds, and veins, in the red sand-stone of the Island of Arran.

10. *Felspar*.—Beds of compact felspar, often passing into clay-stone, occur in the red sand-stone of Arran, Pentland Hills, Ochil Hills, &c.

11. *Porphyry*.—Varieties of this rock, namely, clay-stone, horn-stone, and felspar-porphyry, occur in beds, hills, and veins, in the red sand-stone formation. The Pentland and Ochil Hills, the Island of Arran, the upper ward of Lanarkshire, Angus-shire, afford examples of porphyry in red sand-stone.

12. *Lime-stone and Lime-stone Conglomerate*.—These rocks occur in beds in the red sand-stone of East and Mid Lothian, in that of the Ochil and Pentland Hills, of Arran, Dumfrieshire, Ayrshire, Lanarkshire, Renfrewshire, Angus-shire, &c.

13. *Coal*.—Of this mineral several kinds occur in the red sand-stone, viz. glance-coal, slate-coal, and pitch-coal; and they are met with in Arran, Dumfrieshire, Lothian, &c.

From the short enumeration just given, it is evident that the red sand-stone formation is much more interesting than has been generally imagined. The great variety and abundance of trap, pitch-stone, and porphyry rocks, contained in it, their transitions into each other and into the sand-stone and clay are very striking facts in their natural history, and deserving the particular attention of those who take an interest in the volcanic and neptunian theories of their formation. Those naturalists who are inclined to think favourably of the opinion which maintains the chemical formation of sand-stone will adduce the various kinds of structure exhibited by the red sand-stone as so many facts illustrative of its plausibility; and the miner and engineer, if they adopt this opinion, will probably obtain an easy solution of many difficulties that occur in their respective arts, and practical rules of value and importance to them.

## ARTICLE IV.

*On the Method of Illuminating the Streets by Coal Gas.*  
By Mr. Frederick Accum.

(To Dr. Thomson.)

SIR,

YOUR Correspondent in the *Annals of Philosophy* for April, p. 313, who appears to be alarmed concerning the safety of the application of the gas light illumination, and is desirous of obtaining information concerning certain facts relating to the scheme of procuring light by means of carbureted hydrogen, or coal gas, is hereby informed that the explosion he alludes to was occasioned in consequence of a quantity of coal gas having been suffered to enter into the building where the gazometer was erected, and where it mingled with common air, and was set on fire by the approach of a lighted candle. I give this statement from a letter before me, written by the proprietors of the establishment at which the accident happened to a Gentleman in this town. They who are familiar with the system of lighting with coal gas will readily allow that gas light illumination is more safe than the illumination by candles or lamps. As a proof of this statement, it need only be mentioned that the fire-offices engage themselves to ensure cotton-mills and other public works at a less premium where gas lights are used than in the cases of any other lights. In fact no danger can arise from the application of gas lights, in any way but what is common to candles and lamps of all kinds, and is the fault of none of them. Even in this case the gas lights are less hazardous. There is no risk of those accidents which often happen from the guttering or burning down of candles on carelessly snuffing them. The gas light lamps and burners must necessarily be fixed to one place, and cannot fall, or otherwise become deranged, without being immediately extinguished. Besides, the gas lights emit no sparks, nor are any embers detached from them. And with regard to the production of the gas, it is certain that the manufacture of coal gas is a process perfectly safe. There is no more risk in the action of a gas light machine *properly constructed* than in the action of a steam engine built on just principles. No part of the machinery is liable to be out of order. There are no cocks to be turned; no valves to be regulated; nor can the operator derange the apparatus but by the most violent efforts; and when the stock of gas is prepared we may depend as much on its lighting power as we depend on the light of a certain number of candles or lamps. To obtain this gas the workman is not called upon to exercise his own judgment: it requires nothing more than what the most ignorant person, with a common degree of care and attention, is competent to perform.



The heating of the gas furnace, the charging of the retorts with coal, the closing them up air-tight, and keeping them red-hot, are the only operations required in this art ; and these demand no more skill than a few practical lessons can teach to the meanest capacity.

The diversified experiments which have been made by different individuals unconnected with each other have now sufficiently established the perfect safety of the new lights, and numerous manufactories might be named in which the gas lights have been in use for upwards of seven years, where nothing like an accident has occurred, though the apparatus in all of them is entrusted to the most ignorant man.

That coal gas, when mixed with a certain portion of common air in close vessels, may be inflamed by the contact of a lighted body, is sufficiently known. But the means of preventing such an occurrence in the common application of this species of light are so simple, easy, and effectual, that it would be ridiculous to dread dangers where there is nothing to be apprehended.

In speaking thus of the safety of this new art of illumination, it would nevertheless be easy to name instances where explosions have been occasioned, but solely through egregious mistakes having been committed in the erection of the gas light machinery, were this a subject on which I meant to speak ; but as I do not, I shall merely mention, on the present occasion, that an explosion very lately took place in a manufactory lighted with coal gas, in consequence of a large quantity of gas escaping (from the gazometer being overcharged with gas) into the gazometer house, where it mingled with common air, and was set on fire by the approach of a lighted candle. That such an accident could happen, is an evident proof that the apparatus for preparing the gas was a *bad one*, because such an accident might have been prevented effectually by adapting a waste pipe to the gazometer, as well as to the gazometer house. By this means, if more gas had been prepared by a careless operator than the gazometer could contain, the superfluous quantity could never have accumulated, but must have been transported out of the building into the open air, in as effectual a manner as the waste-pipe of a water cistern conveys away the superfluous quantity of water when the cistern is full.

In answer to the second question made by your Correspondent, namely, what sort of coal is to be prepared for producing the gas, it remains to be observed, that Cannel coal produces the very *best gas* ; or at least the gas which it affords requires the least trouble of being purified and rendered fit for illumination ; though Newcastle coal is employed for illumination in this metropolis.\* But the

\* The public buildings already illuminated in this town with coal gas are the following : the church of St. John the Evangelist, the avenues to the House of Lords and House of Commons, Westminster Hall, the Admiralty, the house and offices of the Speaker of the House of Commons, the Mansion House, the whole liberty of Norton Folgate, &c. ; and the total length of pipe laid down as mains in the streets of London amounts already to 15 miles.

nature of the gas obtained from the same coal varies considerably, according to the conditions under which it is obtainable. 112 lb. of common Cannel coal produce at the *minimum* from 350 to 360 cubic feet of carbureted hydrogen; but the same quantity of the best Newcastle coal, that is to say, such as coke readily, and send out brilliant streams of flame, which undergo a kind of semifusion when laid on the fire, produce upon an average 300 cubic feet of this gaseous fluid, besides a large portion of sulphureted hydrogen, carbonic acid, and carbonic oxide.

Half a cubic foot of this gas, when fresh prepared, that is to say, holding in solution or suspension a portion of the essential oil which is generated during the production of the gas, is equal in illuminating power to from 170 to 180 grs. of tallow, which is the quantity of this material consumed in one hour by a well snuffed tallow candle six to the pound. Now 1 lb. avoirdupois is equal to 7000 grs., and consequently 1 lb. of candles of six to the pound, burning one at a time in succession, would last  $\frac{7000}{175} = 40$  hours. To produce the same light, we must burn one half of a cubic foot of coal gas per hour; therefore one half multiplied by 40 hours is equal to 20 cubic feet of gas in 40 hours, and consequently equal to 1 lb. of candles, six to the pound, provided they were burnt one after another.

Further, 112 lb. of Cannel coal produce at the *minimum* 350 cubic feet of gas, and are equal to 350 divided by 20, which last is equivalent to 1 lb. of tallow, making therefore 112 lb. of coal equal to  $\frac{350}{20} = 17\frac{1}{2}$  lb. of tallow; and 112 lb. of coal divided by  $17\frac{1}{2}$  of tallow gives six and four-tenths of coal equal to 1 lb. of tallow.

With regard to Newcastle coals, it may be stated that one chaldron of Wall's End coal produces in this large way upwards of 11,000 cubic feet of crude gas, which when purified diminish to nearly 10,000 cubic feet. But the quantity and quality of the gas, as stated already, is much influenced by circumstances attending the formation of it. If the tar and oil produced during the evolution of the gas in its nascent state be made to come in contact with the sides of the red-hot iron retorts; or, better, if it be made to pass through an iron cylinder or other vessel heated red-hot, a large portion of it becomes decomposed into carbureted hydrogen and olefiant gas; and thus a much greater quantity of gas is produced than would be obtained without such precautions. If the coal be distilled with a very low red heat, scarcely observable by day-light, the gas produced gives but a feeble light: if this distillatory vessel be of a dull redness, the light produced by the burning gas is more brilliant: if a bright, or cherry-red, heat be employed, the gas produced burns with a brilliant white flame: and if the heat be increased so far that the retort is almost white hot, and consequently in danger of melting, the gas given out has little illuminating power, and burns with a clear bluish flame: and if this coal abounds in pyrites, a large portion of sulphureted hydrogen gas is

then produced, which has the capital disadvantage of affording a suffocating odour when the gas is burnt.

I need scarcely mention that it makes no difference in what form the coal is used, and that the very refuse or small coal, which passes through the screen at the pit's mouth, and which finds no market, nay, even the sweepings of the pit, which are thrown away, may be employed for the production of the gas.

With regard to the pressure of the gazometer, your Correspondent is informed that experience has shown that a pressure of a column of water from an half to one inch is sufficient for regulating the proper supply of the gas to the lamps and burners; but this pressure must be constant and uniform. It is obvious that the weight of the gazometer or vessel which contains the gas is constantly increasing in proportion as it fills with gas and rises out of the water or cistern in which it is immersed; and consequently, if a constant or uniform balance weight equal only to that of the gazometer in the first moment of its immersion be employed, the gas becomes gradually more and more compressed by that part of the weight of the gazometer which is not counterpoised; therefore insurmountable difficulties would follow, because it would be impossible to regulate the size of the flames, &c. To compensate for this increasing weight of the gazometer, the chain by which this vessel is suspended, or at least such a part of it as is equal in length to the height of the gazometer (measured at right angles to the axis of the wheel over which it passes downwards) must be loaded with a weight equal to the quantity of water which the gazometer displaces;\* and thus the density of the gas will be uniform, or at all times the same.

The diameter of the pipes which convey the gas is not *taken at random*, as your Correspondent imagines. Their diameters is a simple matter of calculation, depending upon the quantity of gas which they have to deliver in a given time, and the diameters of the branch pipes proceeding from them.

Further information concerning the general nature of the gas light illumination, together with a description of the best machineries employed in this new branch of civil economy, your Correspondent will find in a *Treatise on Gas Light*, illustrated with copper plates, which will be published on the 10th of next month, by, Sir,

Your most obedient humble servant,

Compton-street, Soho,  
April 22, 1815.

FREDERICK ACCUM.

\* For this elegant contrivance we are indebted to Mr. Clegg, the engineer of the Gas Light Company.

## ARTICLE V.

*Remarks on the Older Floetz Strata of England.*

By J. C. Prichard, M. D. F. L. S. F. W. S. &amp;c.

(To Dr. Thomson.)

SIR,

I HAVE long entertained a suspicion that it may be possible by comparing the organic remains found in the lime-stones, which are connected with coal-fields, with those which characterize some other rocks, to elucidate the series of secondary strata, which our island presents, and especially to determine the era of the independent coal formation. On reading Dr. Fleming's late communication on the fossils found by him in Linlithgowshire, I was so strongly confirmed in this persuasion that I have ventured to submit the following remarks on the subject to your inspection, and to that of the public if you think them worth inserting in your Journal.

It seems improbable that a single species of organized beings should appear in one stratum, and then vanish entirely during an interval, and afterwards show itself again. It is contrary to what we find in nature. A fossil which abounds in one formation is often seen more scantily dispersed through a second, in a third it is scarcely found, and at length withdraws itself altogether from our view. A continual progress seems to have been made from the more simple to the more complex forms. We observe no retrograde changes. But if the extinction and revival of a single animal be thus improbable, how much more difficult is it to suppose that an entire assemblage of co-existent beings should disappear altogether, that their place should be filled during an interval by creatures of a totally different character, and that these should become extinct to make way for a reproduction of the former class? The supposition is so contrary to the usual course of our observations, that I think we may conclude, when we discover two formations to abound with similar fossils, and a third to be characterized by remains of a different description, that the two former belong to one era, and that the latter is either more ancient or more recent than both of them. If this conclusion be allowed, it will enable us to ascertain the relative age of the independent coal formation, or at least of the coal-fields in Britain.

I shall first enumerate the extraneous fossils found in the oldest class of rocks which contains any, viz. those of the transition formation, and chiefly the transition lime-stone.

Mr. Jameson mentions among the fossils of this rock encrinites, madreporites, tubiporites, corallites, and trochites.

Von Buch found in the transition lime-stone of Norway, Sweden, and Finland, which lies under granite, a great abundance and

variety of orthoceratites, some of which were many feet in length. He observes that they distinguish this formation throughout Europe. He notices also pectinites, the oniscus, trilobites, a number of large madreporites, a great many trochites, entrochites, patellæ, a few ammonites, and a great number of other univalves.

Saussure found in the lower chains of the Alps, between Mont Blanc and Geneva, pectinites, terebratulites, gryphites, entrochites, a great many corallites and madreporites, turbinites, and ammonites.

I shall now mention some of the fossils found in the lime-stone rocks which accompany the coal formation in Britain, and which generally shut in or inclose the coal-fields.

Orthoceratites, as observed by Dr. Fleming. Their existence in the coal-field of Linlithgowshire is not a solitary fact. I have seen one which was found in St. Vincent's Rock, in the boundary of the Somersetshire coal basin. It was in the possession of Mr. Cumberland.

Encrinites and trochites occur in astonishing abundance in all the rocks of this class in South Britain. Dr. Fleming has mentioned them in Linlithgowshire.

A great variety of madreporites is commonly seen.

Tubiporites are mentioned by Mr. Townsend.

Pectinites are often found in the rocks near Bristol.

The trilobite is well known in the lime-stone rocks at Dudley, in Staffordshire.

Ammonites occur, though more rarely, in the lime-stone of the coal formation. They are mentioned by Mr. Aikin in the coal-field of Shropshire.

Terebratulites are found very commonly in all the lime-stones of the coal formation.

I might enlarge this catalogue to a much greater extent; but what I have said will suffice to show that there is a general conformity between the animal remains found in the transition lime-stone and the lime-stones of the coal-fields. Hence it appears that at the periods when these two formations were deposited, the ocean was filled with organized beings of the same description. The astonishing abundance of these relics in the rocks of both orders testifies the vast profusion of animal life which the sea contained at each of the periods in question.

That the whole of this assemblage of animals became extinct, and were afterwards produced anew, and that the ocean in the interval was filled with a different set of creatures, which suddenly vanished when their predecessors appeared for the second time, can scarcely be imagined. It follows, therefore, that the first floetz lime-stone of the Wernerian series, to which fossils of a different character are assigned, is more recent than the rocks of the independent coal formation.

This conclusion is confirmed by considering the situation in which

the coal basins in South Britain are found. A considerable track of country in the midland counties of England and South Wales is occupied by a red sand-stone formation, which agrees remarkably with the characters of the old red sand-stone of Werner. On this sand-stone several, if not all the coal-fields of South Britain, rest. In the neighbourhood of this tract the older formations are in many places to be seen, as in the range of the Malvern Hills, between Herefordshire and Worcestershire. Beginning from these hills, we easily trace the succession of rocks from the primitive to the newest floetz strata. I shall briefly mention the most important rocks which this series contains in this part of England.

The Malvern Hills, of which Mr. Horner has given an account, form a small range running nearly from N. to S. They consist chiefly of granite and syenite, in which no stratification can be discovered, perhaps on account of their being very much concealed by soil. On the western side of them, beds of a very hard compact lime-stone lie against the feet of the hills dipping towards the west. In conformable position with these, and frequently alternating with them, are beds of a clay rock, which varies in its appearance. In some places it is a hard slate, and contains scales of mica in great abundance; in others it becomes a mere shale. These rocks contain a profusion of organic remains, particularly encrinurites, madreporites, and terebratulites. Mr. Horner's account of them is minute and accurate: I only mention them for the sake of remarking their position with respect to the red sand-stone, which I have traced, and which appears to fix their place in the geological series.

Mr. Horner considered these rocks as belonging to the transition formation. In this opinion he was right, if, as it appears scarcely to be doubted, the sand-stone is the old red sand-stone.

As we approach these hills from Ross, we perceive that the country which lies to the S. W. of the range is occupied by a succession of low ridges lying nearly parallel to the direction of the Malvern Hills. Most of the observations which Saussure made of the calcareous chains of the Alps are here verified in miniature. The ridges generally turn their abrupt sides towards the primitive range, and slope on the other side. They consist of the lime-stone and clay rock above mentioned, the beds of which generally dip towards the W. and S. W.; but at the northern extremity of several ridges they turn round the hills, and dip northward. In the most westerly of these ridges, near Fownhope, about 13 miles in a direct line from the Malvern Hills, the clay and lime-stone rock dips at an angle of about  $60^{\circ}$  towards the S. W. Here we lose this formation.

Immediately after passing over this western limit of the lime-stone, we find the red sand-stone above-mentioned lying upon it, and in a position exactly conformable with it. The sand-stone forms low ranges of hills parallel to the former. It dips to the S. W. at a considerable angle, which diminishes as we recede from the



lime-stone. It runs hence through the greatest part of Herefordshire, generally preserving the same direction and dip.\* It passes into Shropshire, where, from Mr. Aikin's observations, it appears to pass under the coal-fields. It forms a great part of Cheshire; and, according to Mr. Aikin, contains the salt springs of Droitwich, &c. and the salt deposit of Northwich.† I have followed it into Brecknockshire and Monmouthshire. The lime-stones which shut in the coal-fields every where lie upon it. These I shall denominate mountain lime-stones, for the sake of distinction. They may be traced from a few miles S. of Ross to Chepstow, forming the beautiful cliffs which overhang the Wye, and in a conformable position with the subjacent sand-stone, dipping to the S.W. In general the sand-stone consists of fine grains of quartz, with a little argil, and a variable quantity of oxide of iron and mica: but in the hills, and on approaching the lime-stone, its constituents are differently disposed. At the bottom of a hill we often find the common red sand-stone; higher up, a stratum of pudding-stone, containing rounded pieces of quartz, large masses of which in loose blocks cover the declivities; then there are beds of a whitish stone, the iron and mica disappearing, which makes a good building stone, but near these there is a thin bed consisting almost wholly of oxide of iron, and others almost entirely of mica. All these varieties occur in a hill near Ross, called Herol Hill. On the top of it the mountain lime-stone appears; and about a hundred yards further a pit is open, when the lowest bed of the forest coal rises near to the surface of the ground.

This red sand-stone formation is concealed near the Severn by the red marl rock and the Lias lime-stone; but it appears again near Bristol, forming the basis on which the Somersetshire coal basin rests, of which Mr. Gilby has given an excellent account in the *Philosophical Magazine* for last November. I have seen it lying under the lime-stone near Axbridge, at the southern edge of this basin. This formation would appear every where to rest upon the

\* Mr. Horner considered the Malvern Hills as affording countenance to the Huttonian theory. He observes, that the position of the stratified rocks seems to indicate that they were lifted up by a force from beneath. But if he had traversed the country to the westward of these hills, he would have found that the strata have generally a similar position, and even dip at a much greater angle, at the distance of 12 or 14 miles from the Malvern Hills. The absence of the stratified rocks on the eastern side may be accounted for by supposing that a submarine current flowed down the present Vale of Severn at the era when the rocks in question were deposited. Many indications may be found of the existence of such a current; but if none could be produced, surely the hypothesis is fully as admissible as the ejection of the granite masses from the abyss of Tartarus.

† It is very strange that, after all that has been said concerning this salt formation, we are yet without any satisfactory account of the stratum in which it occurs. Dr. Holland, in the first volume of the *Geological Transactions*, says, that it is subordinate to the sand-stone of the independent coal formation. Mr. Aikin, in the same volume, informs us that they belong to the old red sand-stone; and Mr. Horner, as I perceive by the abstract of his late memoir on the south-eastern part of Somersetshire, given in the last number of the *Annals*, assigns them to the newer argillaceous sand-stone termed red marl.

transition rocks. I have mentioned its relation to those near Malvern. Mr. Aikin informs us that it rests, in Shropshire on highly elevated strata of grey-wacke; and I observe, by the last number of your *Annals*, that Mr. Horner has found it lying on the same formation near the Quantock Hills, in Somersetshire.

The red sand-stone is supposed to contain no organic remains. I believe, however, that I have seen traces of entrochites in it. The mountain lime-stone which rests upon it contains the fossils enumerated above, and which agree so remarkably with those of the transition formation. It often resembles the transition lime-stone in its texture, but is less crystalline, and has much thicker beds.\*

From these considerations I think it is evident that the rocks belonging to the independent coal formation follow the old red sand-stone in the geological succession, and are more ancient than any other member of the floetz series.

But further, we may almost venture to assert that the succeeding formations in the system of Werner have no existence in this country, and that the order of floetz rocks, from the old red sand-stone up to the chalk which form the greater part of South Britain, bear very little analogy to the succession pointed out by that celebrated naturalist.

I have stated that the strata above-mentioned dip most commonly towards the S. W. The coal, together with the micaceous sand-stone and the argillaceous stone which forms the roofs, &c. of the coal seams, dip conformably; but this, as well as the general inclination of the subjacent rock, is subject to variations. The whole commonly incline at a very perceptible angle. Over these rocks are deposited a series of strata which lie very nearly parallel to the plane of the horizon.

The first or lowest of these is that which Messrs. Townsend and Farey denominate red ground and red marl. It has, if I mistake not, been confounded with the old red sand-stone. Its composition varies; sometimes it is an argillaceous sand-stone, but without mica, and destitute of that slaty form which characterizes the older sand-stone. I never saw it contain any rounded pieces of quartz. In some places it becomes a marl rock, consisting chiefly of carbonate of lime. This is the case on the banks of the Severn, where it contains a bed of gypsum.† According to Mr. Townsend, the

\* This resemblance accounts for the disagreement we find among high authorities on the subject of these lime-stones. Mr. Werner, in his little book on veins, mentions the lime-stone rocks at the peak in Derbyshire twice; once he calls them transition rocks, and once affirms that they are floetz. M. Brochant says they are transition, and I understand that Mr. Jameson considers them as floetz.

† I scarcely need observe that I have not mentioned these strata for the sake of claiming the discovery of them, but merely with the view of making some remarks on their order, and the relation which their succession bears to the series of M. Werner. A very accurate account of these formations is already before the public, in the paper of Mr. Gilby above referred to; and an extensive collection of interesting facts respecting these and other newer floetz rocks in South Britain is contained in the work of the Rev. I. Townsend, who mentions that he derived his first information concerning them from Mr. W. Smith.



magnesian lime-stone of Derbyshire and the North of England belongs to this formation,

Above this is the Lyas lime-stone enclosed in a bed of clay. This stratum abounds in shells. In this respect it agrees with the second floetz lime-stone of Werner, which is called in Germany muschel kalkstein. It contains pentacrinites, which are considered as peculiar to this stratum. I have, however, found them in the oolite rock in Gloucestershire, but the Lyas is their proper abode, and they gradually disappear in the succeeding formations. It is here also that those large heads and bones are discovered which have been supposed to be the relics of crocodiles. They are of several species. The remains which Mr. Johnson, of Bristol, has collected, proves that some of them at least belong to an unknown marine animal. From the account which M. Cuvier has given of the cliff at Honfleur, containing the remains of crocodiles, I think it is highly probable that it belongs to the Lyas stratum. He mentions two species which nearly resemble the gavial. If any of your correspondents has seen the rock at Honfleur, and will favour us with an account of it, which may enable us to ascertain its identity with the Lyas lime-stone rock, it will throw an additional interest on these remains. All the other fossils occurring in this stratum are oceanic, among which are ammonites often three feet in diameter.

The Lyas formation is very extensive in South Britain. It is well known at Lyme and Chasmonth on the south coast, and traverses the island towards the German Ocean. I have been informed that it occurs in Anglesea.

Above the Lyas is the extensive calcareous formation containing the oolite or roestone. This cannot be, on account of its position, the roogenstein of Werner, which is subordinate to the second sandstone, and therefore below the muschel kalkstein.

Above this several other rocks are enumerated by Mr. Townsend, which I have not traced. Over these is the upper stratum of sandstone, which supports the chalk formation.

On the whole, I think it appears that there is very little conformity between the floetz series of Werner and that which occurs in South Britain; but the older formations, as far as they are yet known, coincide with his system. We may observe that the travellers, who in distant regions of the earth have been so powerfully struck with the conformity of geological phenomena with the observations of the Saxon Professor, as Humboldt and Von Buch, have chiefly directed their attention to the older formations. I am not aware that any disciple of the Freyberg school has detected the succession of floetz rocks, as detailed by Werner, beyond the limits of Germany.

But if we are to admit any reasons grounded on speculative geology, an universal conformity in the primitive and transition formations is quite as much as can be expected. At the period of the deposition of the last, the waters of the ocean are supposed by

Werner to have subsided, and to have formed separate basins or seas. The subsequent deposits must have varied according to local circumstances. Therefore some variety in the succession of floetz rocks rather confirms than invalidates the Wernerian theory of the earth.

I have the honour to be, Sir,

With great respect,

Your very obedient humble servant,

College Green, Bristol,  
May 14, 1815.

I. C. PRICHARD.

## ARTICLE VI.

*Sketch of a General Theory of the Intellectual Functions of Man and Animals, given in reply to Drs. Cross and Leach. By Alexander Walker.\**

(To Dr. Thomson.)

SIR,

IN the 26th number of your *Annals of Philosophy*, was announced a discovery of the use of the cerebellum and spinal marrow by Dr. Cross;—in the 27th number, Dr. Leach stated “that the same facts, or facts that lead to similar conclusions, were published in *Lettres de Hufeland à Portal*, 1807, and *Anatomie du Système Nerveux, &c. par Gall et Spurzheim*;—in the 28th number, I, conceiving that Dr. Leach meant to ascribe these discoveries to Gall and Spurzheim, denied that they were contained in the work referred to; †—and in the 29th number, Dr. Leach says, “Permit me, Sir, to assure you that the letter from Hufeland to Portal contains precisely the same opinion respecting the use of the cerebellum as that given by Mr. Alexander Walker and Dr. Cross; but he there adds, that he had quoted Gall and Spurzheim’s work only as stating these opinions to be erroneous; and, while he asserts that my anatomical and physiological statements are “inaccurate, suppositious, and at variance with nature,” he gives the results of his own “recent examinations” ‡—the conclusions which he draws after having “carefully examined the structure of the spinal mass of nerves.” §

\* Though this communication is rather too long for the *Annals of Philosophy*, we have given it a place, that every one of the Gentlemen concerned in this dispute may be upon a footing; but as the object of the *Annals of Philosophy* is not controversy, the Editor trusts that they will see the propriety of letting this subject rest where it is.—T.

† Certainly when a Gentleman has said “that facts which lead to similar conclusions were published” in a particular work, meaning thereby to give them priority over another statement, it is most natural to suppose that such was the original source of these facts; and, at all events, the conclusion is unavoidable that they are there considered as facts—the term which Dr. Leach employs.

‡ *Annals of Philosophy*, vol. v. p. 346.

§ *Ibid.* p. 345.

Now, Sir, however unimportant it may seem to Dr. Leach to investigate the origin of these statements, it seems otherwise to me, who imagine myself to have rather a deeper interest in them; and (though, in reply to this Gentleman, I shall not imitate him in the littleness of perpetually repeating his list of Christian names, as he has done my one; nor, ignorant though I am of him, shall I, like Dr. Cross, designate him as *one* Dr. Leach; for these are tendencies to personality, which is the bane of rational discussion;) yet I shall blend the question of the discovery of these facts with that of their absolute truth. The question of the discovery of the circulation of the blood has not been deemed unimportant: I cannot reckon that which regards the circulation of nervous action less so; and into that question the use of the cerebellum enters. This, Dr. Leach will perhaps say is a comparison of very little men with great ones: be it so; but it is not a comparison of very little things with great ones; and to things alone do I wish to attend. No one will venture to say, that the general functions of the brain and cerebellum are less important than that of the heart.

With regard, then, Sir, to the cerebellum, as Dr. Leach, though he begs to be "permitted to assure you that Hufeland thinks it the organ of volition," has not quoted that writer's expressions, or, what is of more importance his *reasons* for such a conclusion, I cannot comment on them. If, however, I may judge of the accuracy of this ascription to Hufeland, by the additional assertion which Dr. Leach now makes as to Willis also having thought so, the conclusion will be most unfavourable to the Doctor's accuracy. Dr. Leach, then, adds that "Willis considered the cerebellum as the source of *voluntary* power." Now, Sir, it is an absolute fact, that Willis asserts the very opposite of this: he says it is the organ of *involuntary* power. "The office of the cerebel," says he, "seems to be for the animal spirits to supply some nerves, by which *involuntary* actions, which are made after a constant manner unknown to us, or *whether we will or no*, are performed."\* And now, Sir, I hope you will permit me also to assure you, that I am not a little surprised that any Gentleman, after accusing another of inaccuracy, and referring with such confidence to his own "recent examinations," should have made so untrue a statement, in order to ascribe to an old author new observations. After this, I should be glad, indeed, to see Hufeland's statement, and his *reasons* for the conclusion alluded to; and, should that writer advance any proofs that the cerebellum is the organ of volition, or rather of those impulses which cause all muscular action, I shall of course readily resign to him the honour or disgrace of the opinion, and shall only regret that my reading has not been as extensive and as "accurate" as that of Dr. Leach.

I am willing, however, to grant something in favour of Willis:—

\* On the Brain, chap. xv.

he was right in assigning to the cerebellum the involuntary motions; but erred in excluding the voluntary ones; for the cerebellum is the source of all motion, voluntary and involuntary, as I shall show in the sequel: while it is the source of every impulse on the muscular system, voluntariness is changed into involuntariness only by ganglia on the cerebellic nerves. I must, however, remark, that even if Willis had stated that which is accurately true, and grounded his statements, as he has done, only on conjecture, or on proofs which do not deserve the name, I should not have thought of yielding to him the merit of observing this truth; for even then he would equally have proved that "the dura mater administers heat for the distillation of the spirits," "that the pia mater does by chemical artifice instil the animal spirits into the brain and cerebel," and innumerable other absurdities—all of which, as well as this one, he supports by ridiculous conjecture, and not by argument. Even truth, however, if struck out only by wild conjecture, and unsupported by proof, would not constitute discovery: the mental effort of rational conjecture, and the personal one of "careful examination" would still remain to be performed by some one who, if successful, would certainly deserve the honour as well as the labour.

And now, Sir, I can furnish Dr. Leach with a quotation from the great work of Baron Haller—a more recent and a better writer than Willis, which will be just as much to his purpose as his own "accurate" reference to Willis; but which I nevertheless deem it necessary to state, in order that the history of this important question may be completely before the reader. "Convulsionibus artuum," says he, "constanter vidimus in animalibus supervenisse, quorum cerebellum vulneraveramus.—Et de convulsionibus dictum est, quæ sunt musculorum voluntariorum. Ex cerebello etiam, si ullus, quintus sensui destinatus et voluntario motui nervus prodit. Quare collectis omnibus, videtur cerebellum et a cerebro hactenus parum differre, et graves in utrovis læsiones mortem inferre, leviores in utroque tolerari. Deinde cerebrum ad vitalia organa et sentientem vim et moventem mittere, et ad partes mentis arbitrio subjectas cerebellum." Here, then, it appears that Haller, after proceeding upon an "it is said" as to the convulsion of the voluntary muscles; observing that the fifth pair coming from the cerebellum is, however, destined both to sense and motion; and thinking that, upon the whole, the cerebellum in so far differs little from the cerebrum,—at last concludes that the cerebrum seems to send both feeling and moving power to the vital organs; while the cerebellum sends both feeling and moving power to the parts which are subject to the will. Now, from this, I differ by asserting, that the cerebrum sends neither sensation nor motion to any part, but merely receives sensation from the organs of sense; while the cerebellum has not only nothing to do with sensation, as Haller erroneously asserts, but sends motion both to the voluntary and to the involuntary parts—or, in other words, both to the mechanical or locomotive, and to

the vital or nutritive system, which Haller inaccurately excludes from its influence. The motions of the vital, are, however, not less important than those of the locomotive, system.

The term volition, however, may be still applied to the function of this organ, whether voluntary or involuntary action be its result, because the impulse of the cerebellum on which they both depend is one and the same, and the involuntariness is a modification of that impulse or of its effects produced only by ganglia on certain fibrils of the cerebellic nerves. This extended meaning of the word volition is perfectly analogous to that of the term sensation; for though sensation does not exist separately, except in those animals which have no sensorium commune,—though, in man, it is inseparable from perception, yet still is the simple term sensation employed. An improved nomenclature, however, or an extension of the very admirable one of Dr. Barclay, would perhaps give us new terms in both cases.

I have now said, in opposition to the statement of Haller, that the cerebrum sends neither sensation nor motion to any part external to the encephalic cavity; and, as Dr. Leach says, I have “neglected to take any notice of the cerebrum,” and seems to demand what use I assign to it, I may “assure him” that there still remain very important uses for it to serve; and as the Doctor, not having submitted them to any “recent examination,” is perhaps less familiar with these *particular* functions, I may hint to him, that they are—observation, reflection, and judgment.

I shall now, Sir, state some of my reasons for asserting, that the organs of sense being those of sensation, and the cerebrum that of mental operation, the cerebellum is the organ of volition, or rather of all the motions of animals, voluntary and involuntary.

1. There are *three distinct intellectual organs* or classes of intellectual organs, namely, the organs of sense, the cerebrum, and the cerebellum.—That the cerebellum, though separated from the cerebrum only by membranes in man, is not on that account less distinct from it than are the organs of sense separated by bony plates, is rendered evident by the consideration, that membranes form, in the one case, as effectual a separation as bony plates do in the other; that many animals\* have a bony tentorium between the cerebrum and cerebellum, as they have bony plates between the cerebrum and face; and that others (birds) have membranes between the cerebrum and face, as they have a membranous tentorium between the cerebrum and cerebellum.

2. There are *three distinct intellectual functions* or classes of intellectual functions, namely, sensation, mental operation, † and volition.

3. Of the *organs*, those of the senses are the first, the cerebrum

\* Viz. most species of the cat and bear kind, the martin (*mustela martes*), the coaita (*caracopithecus paniscus*), and others.

† Including observation, reflection, and judgment, and the subordinate faculties analyzed by Gall and Spurzheim.

intermediate, and the *cerebellum* the last.—For, although the face, containing the organs of sense, and the cerebellum, are, in different animals, very differently placed with regard to the cerebrum, yet there is a peculiar relation between the situation of one of these and that of the other with regard to it. In other words, although the face is sometimes in one situation and sometimes in another with relation to the cerebrum, yet to each given variation of its situation with regard to that body there is a corresponding and uniformly accompanying variation in the situation of the cerebellum. Thus as, in man, the face is placed below the anterior part of the cerebrum, so is the cerebellum placed below its posterior part; and precisely as, in the inferior animals, the face advances, precisely so does the cerebellum recede, till, in those animals in which the face is placed exactly before the cerebrum, the cerebellum is placed exactly behind it.\*

4. Of the *functions*, sensation is the first, mental operation intermediate, and *volition* the last.—That sensation precedes and excites, if it do not generate, mental operation, few will deny: that mental operation, however rapid or evanescent, precedes and excites volition, or that the motive to an action must precede the action, none will refuse: and that, of any one series of intellectual action, volition is the last stage, all must admit.

5. As, then, the *cerebellum* is the last of the intellectual *organs*, and *volition* the last of the intellectual *functions*, and as, at the same time, there is no organ without function, or function without organ, it follows, that the cerebellum must be the organ of volition.

6. In perfect conformity with this truth, the inferior animals, however defective in intellect, possess motion; and, in almost all of them which have any visible nervous system, a cerebellum, the organ of that motion, exists.—This leads me to an observation which seems to me to possess considerable interest and beauty. As we descend among animals, one of the three portions of the nervous system and one of its three general functions gradually disappear. Now it is not the first and the last portions of the nervous system—it is not the organs of sense and the cerebellum, neither is it their respective functions, sensation and volition, which are thus lost. It is the cerebrum and mental operation which are. This organ is, among men, most conspicuous in the Caucasian race; and we accordingly find that that race alone has cultivated the sciences. It is less even in the Mongal and Ethiop, who have ever disregarded them. It gradually disappears and ultimately evanishes as we descend among quadrupeds, birds, reptiles, fishes, &c. and with it gradually disappear and ultimately vanish the powers of thought. But organs of sense and a cerebellum,—sensation and volition, yet remain to characterize myriads of animals below these.

\* The cerebellic cavity, moreover, seems uniformly to commence on the inside of the base of the cranium exactly opposite to the place where the face, or the lower jaw, terminates on the outside.



7. This truth receives new confirmation when we observe, that the degrees of voluntary power always bear a close analogy to the various magnitudes of the cerebellum. In fishes, for instance, which possess amazing locomotive power, the cerebellum is often larger than the cerebrum; and they sometimes possess an additional tubercle, which seems to Cuvier to form a second cerebellum!

In the statement of these reasons, Dr. Leach will find obviated any quibble which might be founded on the various meanings of the word 'opposite' which, for the sake of brevity, I formerly used. They will also enable the reader to correct Dr. Cross's representation of them.

Dr. Leach, then, endeavours to prove, that there is no proportion between the various magnitudes of the cerebellum and the degrees of voluntary power.—The cerebellum, he says, is proportionally smaller in children than in the adult, and yet children have more of muscular agility than adults. Now, if by *agility* Dr. Leach means that their voluntary powers are stronger, I unhesitatingly deny it; and if he do not mean this, his example is inapplicable: the truth is, he does not take into consideration the evanescent action of children and the permanent and sustained action of adults.—A shark, he says, which has the greatest locomotive power, has a remarkably minute cerebellum. Now this instance is as inapplicable as the last; for I have nowhere asserted the greater absolute magnitude of the cerebella of fishes; but have, in distinct terms, asserted their greater proportional magnitude.—The same answer applies to Dr. Leach's third example of the swallow.

That, contrary to Dr. Leach's assertion, this is a "*general principle*," is sufficiently proved by this, that if our considerations be *general*—if we compare the cerebella of birds with those of quadrupeds, we find the former larger in proportion to the brain consistently with their more intense, frequent, and rapid voluntary motion; and if we compare the cerebella of fishes with those of birds, we find the former, in both these respects, excel the latter. But if we enter into more *particular* examinations—if we compare these parts in the genera and species of animals, as Cuvier has done, our observations must be more *particular* than his—we must attend not only to the general magnitude of the organs, but to their particular form; for (I now repeat an important fact which I, prior I believe to any other person, announced some years ago,) "on the length of the cerebral organs depends the intensity of their function, and on the breadth of these organs the permanence of their function." As liquids pass with greater velocity through the narrow portion of a tube than through its wider parts, precisely so must all nervous action pass between the parietes of the organs—the tubes of the neurilema, whether that action be performed by fluids, by liquids, or by globules, as proved by Prochaska and others. That the nervous matter is thus laterally confined by the neurilema, is proved by the circumstance of the ends of nerves expanding when



cut; and they are, therefore, in so far subject to similar laws with liquids contained in tubes.\*

It is, then, from Cuvier's not distinguishing between the height and the breadth of the organs, and their corresponding intensity or permanence of function, that his comparison of man and the bull, and his scale in general, which Dr. Leach has quoted, is of diminished value, and quite inapplicable to the present question. This curious and important fact may be illustrated even from the classes of animals; for the laterally compressed and *high* cerebellum of birds corresponds admirably with the *intensity* of their voluntary powers, and the depressed and *flat* cerebellum of the turtle, frog, salamander—in short, of all the slow but long moving reptiles, equally corresponds with the *permanence* of their voluntary power.

In reply to Dr. Cross's last observations (in the 30th number of the *Annals*), I need say little indeed. The strongest argument which he adduces in refutation of the preceding doctrine, is the ironical application of the words "logical and sapient," and the direct one of the words "absurd and groundless." Now whether Dr. Cross's authority in matters of science is sufficient to render such words, when used by him, the very death-warrant of a new doctrine, I am perfectly ignorant; but, with me, even much higher *authority* than the Doctor's would not constitute proof. Dr. Cross adds, "that volition ranks among the faculties of the mind, whose organ is the cerebrum;" and *so far* as authority in general and the authority of Dr. Cross in particular goes, this is another proof of the falseness of my doctrine. The Doctor, however, further adds, "that affections of the cerebrum, while the cerebellum remains sound, produce palsy, which I *humbly submit* is just a loss of volition." At last, then, the Doctor does give us an argument; and as it is a solitary one, and follows so much of mere authoritative determination, it must no doubt be so triumphant that the "humble submission" which the Doctor forgot when adducing his authority, but so generously appends to his proof, must be intended only to enhance talent by modesty, and to heighten triumph by moderation. This is certainly very fine; and it involves only one little awkward circumstance, which is, that while the Doctor's proof consists of two propositions, it presents precisely as many errors! "Affections of the cerebrum," says he, "while the cerebellum remains sound, produce palsy;" and hence he means to conclude that palsy which he deems a loss of volition, and consequently volition itself is dependent on the cerebrum, and not on the cerebellum: indeed he actually says so in the preceding portion of the same sentence; thus placing the induction (logically no doubt) before the datum, and

\* It is perhaps also for the same reason, that, in a galvanic battery, the intensity of its action seems to correspond with the number of the plates (for the igniting power is as the number), and the permanence of its action with the magnitude of the plates. Accordingly, M. de Luc observes that the number of the plates is analogous to the length of a pump for raising water; and the size of the plates is analogous to the magnitude of the bore of the pump.

reducing it to a mere assertion. The conclusion, however, is inaccurate; for even if palsy were *just* a loss of volition, it would be by no means wonderful if the functions of the cerebellum were deranged by an injury of the cerebrum, since two immediately contiguous and intimately connected organs must powerfully influence each other. Dr. Cross must be aware that even remote organs evidence this sympathy; and it may even to himself have happened, that a deranged state, for instance, of the Doctor's bowels may have caused an affection of his head; but surely the Doctor would not therefore conclude that the cause of the derangement was in his head. Just so it is, that no derangement of volition caused by injury of the cerebrum is any proof that the cerebrum is the seat of volition. So much for one half of the Doctor's proof. In the other, he humbly submits that palsy is *just* a loss of volition. I reply that palsy is no such thing; and as the Doctor is fond of logic, I shall give him my proof in a logical form.—We cannot be conscious of any mental act unless that act exist; but volition is a mental act of which the patient is conscious in palsy; therefore palsy is not *just* a loss of volition!

Having thus, I believe satisfactorily, replied to the Doctor's argument against me, I must notice the claim which he sets up for himself. He has discovered, he says, that "the cerebellum supplies the face with nervous energy;" and of me he asserts "that there is not *even* the *smallest* hint, from the *beginning* to the *end* of his tract, that could *at all* lead in the *smallest* degree towards this discovery." Now as that and the succeeding tract show, in great latitude and detail, that all muscular parts are supplied with nerves from the cerebellum or the posterior columns of the spinal marrow, and more especially that *all those encephalic nerves* which supply *muscles of the face* have at least *one origin directly* from the *cerebellum*, it is difficult to conceive how any Gentleman could venture to make so *anxiously tautologous* and obviously untrue an assertion as the preceding. In these tracts, I have said, "Like these (the spinal nerves), all the encephalic nerves have two portions—a cerebral and a *cerebellic*, except the first, second," &c.—p. 175; and "The transverse bands (these are the pons varolii, the narrower and flatter band of Spurzheim immediately below it, and the much broader and radiating but perfectly flat band below that, which was first pointed out by myself) seem uniformly to serve the purpose of conducting the *cerebellic* origins of the nerves;"—p. 179. With regard to that encephalic nerve in particular which is by way of pre-eminence named *facial*, I have demonstrated the remarkable course of its two portions, cerebral and *cerebellic*, overlooked by all other anatomists—p. 148; and I have done the same with regard to several other nerves. These I think are proofs sufficiently ample to show how far the face (though opposed, in the sense above explained, to the cerebellum, that is in so far as it contains the organs of sense, and not as it is furnished with muscles) is yet dependent on the cerebellum for the supply of its muscular parts. These proofs

I adduced six years ago ; and yet Dr. Cross tells me I have not said one word of the cerebellum receiving nervous energy from the face, but that *he has now* made the discovery ! Though, however, the muscles of the face thus receive motive energy from the cerebellum, not one of its sensitive nerves are derived from it ; for even the auditory nerve, after crossing the corpora restiformia, ascends to the cerebrum. As, then, the face receives only motive and not sensitive energy from the cerebellum, and as I proved this six years ago, I cannot divine to what discovery it is that Dr. Cross on this subject pretends.—Having thus done justice to myself by exposing this (I dare say unintentional) plagiarism, I leave it to some friend of Dr. Crawford's to do him similar justice with regard to Dr. Cross's charcoal hypothesis of respiration.

(*To be continued.*)

---

## ARTICLE VII.

*Observations on the Uses of the Dorsal Vessel, or on the Influence which the Heart exercises in the Organization of articulated Animals, and on the Changes which that Organization experiences when the Heart or the Organ of Circulation ceases to exist.* By M. Marcel de Serres.

(*Concluded from Vol. V. p. 379.*)

### I. *Respiration in the Air by means of Tubular Tracheæ.*

#### *Division 1.—Only Arterial Tracheæ.*

PULMONARY tracheæ exist in the greater number of the coleopteres ; but there are certain genera, as the cerambyx, blaps, and most of tenebrunides, in which they are not observed. These tracheæ take air immediately, forming round the stigmata very numerous bundles. But that a communication may be established among all the tracheæ, there exists a common trunk which extends from one stigma to another, and which opens in that part. It is from this common trunk that these numerous bundles proceed, of which we have spoken, and which distribute the air to all parts of the body. The direction of the tracheæ, then, is almost always transversal. As these vessels issue in bundles from a common trunk, they present in some measure the disposition of a horse's tail. In the genera of which we are speaking, the tracheæ are very numerous in the breast ; to such a degree, indeed, that they almost cover the muscles of that part. We see them all presenting a transversal direction. As they are very near each other, they form on the muscles parallel streaks, so very close together that it is with difficulty that any interval at all can be seen between them. These

pectoral tracheæ proceed from the common trunk, which takes up air in the first stigma of the abdomen.

In general the arterial tracheæ are very much branched, and give out an infinite number of ramifications. This disposition is very striking in the genera of which we are speaking, and which are distinguished by the position of their stigmata. These stigmata are placed below the *elytres*, and on the sides of the body in the back. It may be owing to the difficulty which the air finds to introduce itself into these stigmata, especially when they are concealed below immoveable *elytres*, as in the blaps, that the arterial tracheæ are so disposed that all parts of the body speedily enjoy the influence of the air. These stigmata are formed in the common way by a jutting out horny border of considerable thickness. Their opening is oval, and their greatest diameter is in a transverse direction. It is easy, by opening them, to perceive the common trunk of the arterial tracheæ, which opens there. The disposition of the arterial tracheæ in the *cebrio longicornis* is almost the same as in that which we have just described.

In the phalangium and analogous genera, only a single order of tracheæ is observed. The respiratory system in these genera may be considered as formed of common trunks, which, situated in the neck, are the centre from which all the other ramifications proceed. These common trunks are found near the stigmata, to which they send a branch; and from this point proceed two bundles of tracheæ, which spread over all the body, especially the intestinal viscera. We see even that they surround each appendix of the intestinal tube, and their first membrane is in part formed of these tracheæ. The common trunks continue thus along the sides of the body, giving out different branches to the muscles of the legs, to the mouth, to the dorsal vessel, and to the organs of generation. This respiratory system is one of the simplest. Only two stigmata exist, placed on each side of the corcelet, on the same line as the fourth pair of legs. These stigmata are oval, the greatest diameter proceeding from below upwards. Internally we see that they have a border pretty strong. They are very large, compared to the size of the body.

The larvæ of lepidopteres, or caterpillars, have likewise nothing but arterial tracheæ. Lyonnet,\* to whom the anatomy of insects is so much indebted, had already remarked this fact. However, I thought it worth verifying in the caterpillars of different butterflies, especially in those of the cabbage and of fennel; in the larvæ of the *bombyx pavonia major*, *mori*, and in that of the *sphinx atropos*. In all these I found only arterial tracheæ. When there are only arterial tracheæ, we see them always formed by a common trunk, which opens into the stigmata, and from which numerous ramifications proceed, which are distributed to all parts of the body. This common trunk extends from one extremity of the body to another,

\* See *Traité Anatomique de la Chenille du Saule*, p. 101 and 237, tab. x. fig. 2.

and its diameter is at least a millimetre (0·03937 inch); sometimes it is even more considerable. It is from this common trunk that the bundles of transverse tracheæ always divided into pairs proceed; the ramifications of which are generally unequal. The number of these bundles of tracheæ is always twice that of the stigmata, as two always proceed from each stigma.

The insects which respire air immediately, and which have only arterial tracheæ, are those in which the respiratory system is simplest. The species in which this disposition exists require to enjoy the influence of air as speedily as possible. Hence it is distributed almost as soon as it is received.

The pulmonary tracheæ of the scarites *gigas* originate above the cerebriiform ganglion by a transversal branch, from which proceed ramifications to the upper lip, the antennæ, and the eyes. This branch is prolonged in the head by two principal trunks, which extend in the corcelet, and then in the rest of the body. These trunks having reached the corcelet, form on each side of the dorsal vessel a kind of semicircle, giving out numerous ramifications to the dorsal vessel and the surrounding muscles. The pulmonary trunks, when they reach the breast, approach the dorsal vessel more and more, forming on each side *erismes*, semicircles, from the centre of which proceed the branches that form a communication between the pulmonary and arterial tracheæ. The common pulmonary trunks continue in the same manner in the abdomen, where they form afterwards rings in semicircles, from which proceed the principal branches, which form a communication between them and the arterial tracheæ. As to the branches that come from the internal side, they all go to the dorsal vessel and the muscles that surround it. In this place the pulmonary trunks never acquire a large diameter.

The trunks of the arterial tracheæ rise below the cerebrum by two principal branches, which distribute themselves over the mandibles, and the different parts of the mouth. These branches have a very considerable diameter, and a reddish colour. When they come to the corcelet, they unite, and form only one trunk. After this they send a large branch to the first pair of legs; while from their interior side they send branches to the trunks of the pulmonary tracheæ, and to the intestinal tube. The same thing takes place in the thorax. These tracheæ diminish somewhat in size in the abdomen, and keeping always at the side of the body, the external branches go to the stigmata, while the internal surround the intestinal tube and the organs of generation with a fine network of tracheæ. The common trunks form from ring to ring semicircles, always furnishing the branches of which we have spoken. We observe that from each semicircle formed by the arterial tracheæ there issue two long cylindrical tracheæ, which ramify to infinity on the intestinal tube and the organs of generation. There are few species in which these tracheæ are more distinct or extensive. In general the abdominal tracheæ are of a silver-white; those of the

corcelet have a shade of red. The stigmata of this species placed upon the inferior sides of the abdomen are rounded and bordered by a salliant fold of the coreaceous envelope.

Several of the orthopteres exhibit at once arterial and pulmonary tracheæ. Of this number are the forficulæ, blattæ, phasmes, mantes, achetes, locustæ, mole crickets. But as these tracheæ are not similar in different genera, and as their complication is not quite the same, we shall make them known in those in which it presents the greatest peculiarity.

The respiratory organs of the forficulæ and blattæ present little difference. They are composed of a system of arterial tracheæ formed by a common trunk, which extends from one extremity of the body to another, and into which transversal tracheæ pass, which are distributed in a great number of parts. In the head they furnish the ramifications to the principal muscles, especially to the adductors and abductors of the mandibles and œsophagus. They then extend in the corcelet by two principal trunks which lie below the pulmonary tracheæ, but which soon divide, giving out numerous ramifications to the muscles of the corcelet, to the intestinal tube and the first pair of legs. The principal trunks continue to the thorax, keeping on the sides of the body. They then send a pretty large branch, which passes into the opening of the tremaer, to take up the air which other ramifications distribute in the muscles contained in the thorax, and in those of the wings and legs. It appeared to me that the arterial tracheæ furnished in the corcelet and thorax branches which spread in the legs, where they give out a much greater number of ramifications than the pulmonary tracheæ, which equally make their way thither. The trunks of the arterial tracheæ communicate with those of the pulmonary tracheæ by lateral branches proceeding from the internal sides of these tracheæ. The same thing takes place in the corcelet, the thorax, and abdomen. The same tracheæ form round the stomach and its appendages nets of tracheæ quite inextricable.

The arterial tracheæ, after having given numerous ramifications in the thorax, extend themselves in the abdomen by a common trunk, which opens into the six stigmata placed on the sides of the body. It is likewise near these stigmata that the common trunks furnish each two bundles of transversal tracheæ; so that there are 24 such bundles in the abdomen. These same tracheæ make all the parts enjoy the impression of the air, distributing themselves over the intestinal viscera, the organs of generation, and the abdominal muscles. I must observe that the communication of the arterial and dorsal tracheæ takes place by means of transversal branches, which the first send off at intervals to the second.

The pulmonary tracheæ appear equally in the head, where they extend round the superior portion of the cerebriform ganglion and round the eyes, whether single or compound. They give out but a small number of ramifications in the head; and passing through the superior portion of the occipital foramen, they go to the corcelet,



where they spread themselves in the first pair of legs without sending out many branches. Always placed at a small distance from the dorsal vessel, they pass into the thorax; where, however, they separate a little from that vessel, forming round it a kind of S. These tracheæ send branches into the two last pair of legs, in which they do not ramify much. When they come into the abdomen they approach the dorsal vessel, sending it small ramifications, as they do during their whole passage. These ramifications appear to compose the first membrane of this vessel. These tracheæ extend to the extremity of the abdomen, forming from ring to ring semi-circles more or less near each other. Such is the general distribution of the tracheæ in these two genera, in which these vessels have a very small diameter.

The disposition of these two orders of tracheæ is not quite the same in the achetes as in the genera of which we have spoken. They have likewise a greater diameter, so that they are more easily followed.

The arterial tracheæ begin below the cerebrum, from which, as from a central point, they send branches to different parts of the head. These branches have not an equal diameter; and those which go to the muscles of the mandibles are remarkably large. These branches, penetrating into the mandibles, give numerous ramifications, the smallest divisions of which penetrate as far as the teeth of these parts. The arterial tracheæ furnish equally branches to the different parts of the mouth, and extend by two principal trunks into the corcelet passing through the opening of the *foramen occipitale*. They then go towards the fore part, along the sides of the corcelet, and give pretty numerous ramifications to the rotatory muscles of the head, and to the muscles belonging to the corcelet, and likewise to those of the legs. Come to the base of the corcelet, the arterial tracheæ form a very large trachea, which passes into an opening situated on the lateral and inferior side; and in this manner they receive directly the impression of the external air. This trachea then extends to the extremity of the first pair of legs, without giving out many ramifications. The arterial tracheæ then proceed to the thorax, being always situated at the side of the body. They send numerous branches to the muscles of the thorax, principally to those of the wings, the elytres, and legs. These tracheæ furnish likewise branches to the last pair of legs, and to the pulmonary tracheæ, to which they carry air. After having furnished these principal branches, and a great number of others much more small, the arterial tracheæ proceed to the abdomen, where they form a more complicated apparatus. Extending always along the sides of that part, their trunks open into the stigmata by a ramification whose diameter is not so considerable. These tracheæ towards their inside give out six principal branches, divided each into two ramifications, much larger, which unite in a single trunk that passes into the pulmonary tracheæ. But before uniting in a common trunk, the large ramifications give out two lateral branches,



which establish a communication of superior and inferior ramifications. All these tracheæ enjoy immediately the action of the air, and distribute it into the pulmonary tracheæ. It is from the first branch principally that the tracheæ proceed which spread themselves on the organs of generation, while those of the intestinal viscera are furnished successively by the six branches. Besides these principal branches, the common trunk furnishes other four, one which precedes all the branches, and three which come immediately after them. The first spreads itself on the superior abdominal muscles, and upon the intestinal tube. The others, on the contrary, give numerous ramifications to the muscles of the abdomen, and particularly to the organs of generation.

The pulmonary tracheæ, more constant in their direction, rise above the cerebriform ganglion by a common trunk, which divides into two principal branches, the upper of which go to the eyes and the antennæ. The lower extend backwards to the foramen occipitale, traverse the muscles of the mandibles, and penetrate into the corcelet. There they separate a little from each other, give out a branch to the first pair of legs, and furnish a very few branches to the muscles of the corcelet. These tracheæ then make their way into the thorax, where they give out two principal branches, which terminate in the legs, furnishing some ramifications to the muscles. When they come to the abdomen, they approach each other, and run near the dorsal vessel, sending out a great number of branches, which divide themselves on the external membrane of this vessel. During their whole passage we see them almost always sinuous, forming from distance to distance semicircles, which touch each other by their summits. As we have already explained how these tracheæ receive air, we shall not resume the subject again.

The respiratory organs of the phasmæ consist equally of two orders of tracheæ, the arterial and pulmonary. These last present in the head four principal branches. The superior branches are the largest and longest. They furnish branches to the antennæ, the upper lip, and the mandibles. When these tracheæ make their way into the corcelet, they separate from each other, and unite with the branches of the inferior pulmonary tracheæ to penetrate into the first pair of legs, where they spread themselves. The inferior branches of the pulmonary tracheæ are situated below the preceding. Their trunks are more nearly straight. All these tracheæ issue through the foramen occipitale, and unite in the corcelet, so as to form only two principal trunks, more or less near to the dorsal vessel, but always accompanying it. When these branches have come as far as the second pair of legs, they send them a principal branch. The same thing happens when they come to the third pair. When they enter the abdomen, they proceed still nearer the dorsal vessel, to which they send numerous branches.

The arterial tracheæ have not a direction so constant as the pulmonary. In general, being composed of bundles of branches, they make all parts enjoy the impression of air, which they receive im-

mediately. Their common trunks, situated below the cerebriform ganglion, furnish numerous branches to different parts of the head, then in the corcelets to the different parts of the legs. When they reach the thorax, these trunks throw out a branch on each side, which goes to receive air by the opening of the tremaer, and their two other principal branches go to the legs. These tracheæ give likewise branches to the muscles of the thorax, and to the pulmonary tracheæ and the intestinal viscera. The same is the case in the abdomen. In the abdomen the arterial tracheæ give out on each side as many branches as there are stigmata, and these communicate with the pulmonary tracheæ. The direction of these branches is transverse, compared with the axis of the body, while the common trunks of these same tracheæ, as well as of the pulmonary, are parallel to the axis of the body.

The abdominal arterial tracheæ furnish branches to the intestinal viscera and the organs of generation. They form on these parts very numerous networks.

The distribution of the tracheæ is still more admirable in the mantes than in the different genera that we have hitherto studied. Their direction is so complicated that it is difficult to describe it. We shall observe, however, that the pulmonary tracheæ originate above the cerebriform ganglion by a common trunk, from which six principal branches proceed: two lateral, which go to the eyes; two inferior, for the upper lip; and two others for the antennæ. From these branches there proceed others, which proceed to the different organs of the mouth. This common trunk then proceeds to the corcelet, always separating more and more. When it has got into that part it sends off a branch which unites with an arterial trachea. These two tracheæ, thus forming but a single one, go to the first of the legs, and extend to its extremity, giving off numerous branches,

The pulmonary tracheæ, proceeding on in the corcelet, approach a little to the dorsal vessel. They then enlarge considerably opposite to the first pair of legs, sending to them a branch, which unites with the most external arterial branch of the tremaer. By this union the two trunks form only a single one, which extends to the extremity of the first pair of legs. The pulmonary tracheæ then approach the dorsal vessel, send it some branches, as they do likewise to the muscles of the corcelet. When they have come to its extremity, they send out a lateral branch, which unites with the most external of the arterial tracheæ. The pulmonary tracheæ then become large, and give out at first a branch, which goes to the second pair of legs; and after having diminished in diameter, they send out another branch in that part. These tracheæ furnish likewise different ramifications to the dorsal vessel, and they gradually approach nearer it. But when they have got as far as the first stigma they separate from it suddenly, forming a semicircle, which gives out a branch that establishes a communication with the arterial tracheæ and with the seventh stigma. From this point the pulmonary tracheæ have two principal trunks: the most internal is very wind-

ing and irregular; the external extends in a straight line to the opening of the seventh stigma, where it receives the impression of the air as well as the internal trunk. These two trunks of pulmonary tracheæ communicate with each other by means of the lateral branches, which are six in number on each side; but besides these lateral branches, there exists one at the base of the body, which unites the two systems of pulmonary tracheæ. This apparatus, in combining with that of the arterial tracheæ, forms an admirable whole, which the silvery colour of the tracheæ renders still more agreeable to the eye. The internal trunk of the pulmonary tracheæ sends out a great many branches to the dorsal vessel, branches which divide themselves to infinity. We see how complicated the pulmonary tracheæ are in this genus, and all in order that there may be a greater reservoir of inspired air.

The arterial tracheæ rise in the head below the cerebriform ganglion. They give out there large branches, which spread themselves in the muscles of different parts of the mouth. They go likewise to the upper part of the head, and unite with the tracheæ that proceed to the eyes. They then pass into the corcelet, always along the side of the body. The two great branches parallel to the common trunk of the arterial tracheæ, and which open into the tremæ situated at the base of the corcelet, may be considered as belonging to this system, though they appear to be divisions of pulmonary tracheæ. The external trunk of the arterial tracheæ gives a great many ramifications to the muscles of the thorax. We have not given a figure of them, because we wished to render our representation more intelligible; for if we had exhibited all the ramifications that we perceive, it would have been very difficult to have followed the direction of the principal tracheæ; so that we should have run the risk of failing in our object. The arterial tracheæ unite with the pulmonary towards the base of the corcelet. They then penetrate into the thorax by three principal branches, and the two external unite, forming a kind of oval, before which the intermediate branch unites with the first pulmonary trachea, which goes to the third pair of legs. These arterial tracheæ form soon after two principal trunks, situated further down, and more externally, than the trunks of the arterial tracheæ. Each of them sends a lateral branch, which opens into the stigmata; so that there exist 12 lateral branches, since there are six stigmata, and each receives two. We may even reckon 14, since the whole of the system terminates in the seventh stigma by two principal branches. The tracheæ which go to the organs of generation proceed from the third lateral branch: these tracheæ are very large and numerous. But besides these tracheæ, the common trunks furnish a great number to the intestinal viscera. We have not given figures of them, for the reason already stated.

The descriptions which we have given of the various respiratory organs in insects, must have shown that by means of this complicated apparatus there is a real circulation of air in that order of

animals. This circulation is still more evident in the mantes than in the genera that we have described. The air taken in by the branches of the arterial tracheæ in the stigmata, is spread, by means of their common trunks, into the branches of the pulmonary tracheæ which carry it to their principal trunks, where it is taken up by other ramifications, and distributed in all parts of the body. When the decarbonization of the blood is effected, the remaining oxygen, the azote, and the carbonic acid, are driven out by the contraction of the elastic tracheæ. These gases may either take the road by which the air entered, or a different one. All parts, then, enjoy the impression of air; and the pulmonary tracheæ are destined to serve as a reservoir, that this impression may be for some time independent of the inspirations and expirations.

The locusta exhibits likewise two orders of tracheæ, but their situation is different from what we described as that of the mantes. The pulmonary tracheæ extend in a straight line from one extremity of the body to the other, always keeping towards the middle and upper part of the body. They originate above the cerebrum, give some branches to that organ, then proceed to the eyes, sending different branches to the organs situated in the head.

These tracheæ penetrate into the corcelet through the foramen occipitale, approach each other by degrees, and become gradually parallel, giving out a branch to the first pair of legs. When they come to the thorax they give out different branches, some of which go to the two last pair of legs, and others to the muscles of the thorax. When they reach the abdomen their diameter diminishes, though they receive nine branches from each side, furnished them by the arterial tracheæ. These tracheæ then extend to the extremity of the body, giving out a certain number of ramifications to the dorsal vessel.

The pulmonary tracheæ are very conspicuous in this genus; but the contrary is the case with the arterial. Originating below the cerebriform ganglion, they distribute themselves to different parts of the head, giving in particular numerous branches to the muscles of the head. They extend in the corcelet by two common trunks, which go along the side of the body. But when they reach as far as the first pair of legs, they become considerably larger, form a sort of tubular cavity, and take air immediately by a large oval opening or stigma situated in that part. This tracheæ, the diameter of which is very considerable, extends to the extremity of these legs. Besides this great branch, the arterial tracheæ furnish other ramifications to the muscles, and which bring air to the trunk of the pulmonary tracheæ. The arterial tracheæ continue in the thorax and abdomen by two common trunks, send branches to the legs, the pulmonary tracheæ, and the muscles of the thorax.

The arterial tracheæ become very complicated in the abdomen. By their internal side they give off 16 principal branches, 12 of which proceed in pairs, while the other four are simple. The first branch is simple: at first very small; it increases suddenly, giving



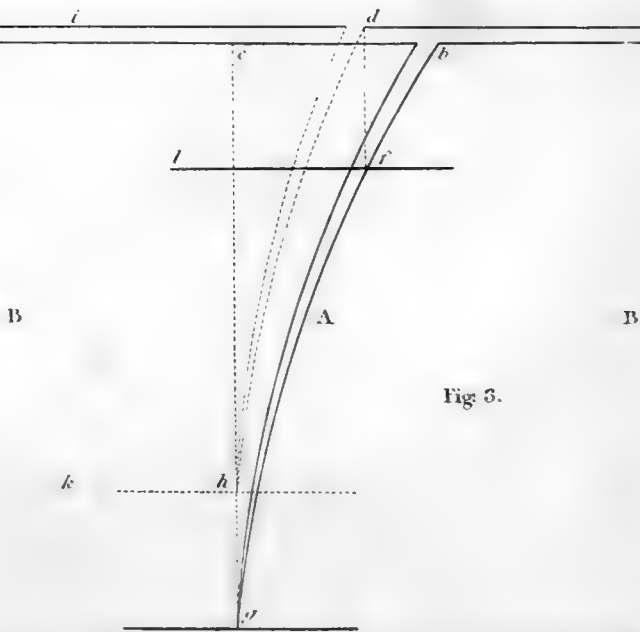
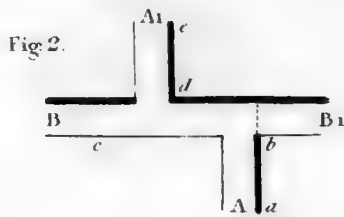
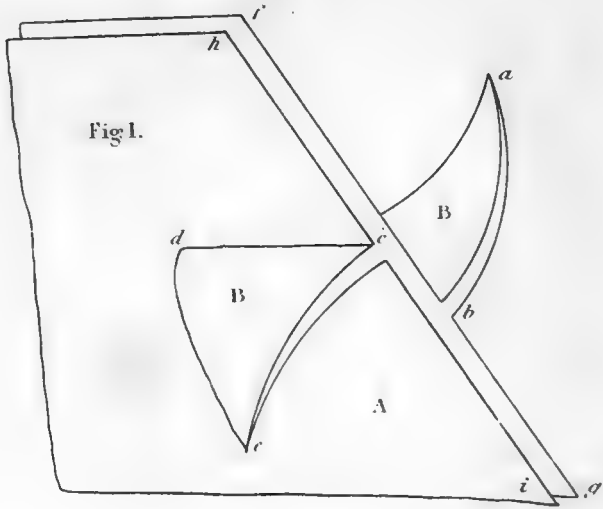

*M<sup>r</sup> Longmire on Rents 1/3.*

different ramifications to the abdominal muscles and the pulmonary tracheæ. The second branch sets out simple, but speedily divides into two branches, each much larger than the common trunk. Near the point where these tracheæ unite to furnish a single branch to the pulmonary tracheæ, they send off two branches, the superior of which goes to the superior branch, and the inferior to the inferior. Thus on each side of the abdomen are disposed the five other common trunks which open into the stigmata, so that these six orders of tracheæ correspond to the openings of these parts. As there are in all 16 branches on each side of the abdomen, the arterial tracheæ give on each side three large simple branches, which go to the pulmonary. They communicate with each other by means of small ramifications which they send to each other. All these principal branches have constantly a transverse direction. The bundle of tracheæ that go to the organs of generation proceeds from the first double branch. What is remarkable in this respiratory apparatus is the great diameter of all the abdominal tracheæ, especially those with double branches. These tracheæ are so large, and so close together, that they form a kind of envelope round the organs contained in the abdomen.

---

## ARTICLE VIII.

*An Essay on the Shapes, Dimensions, and Positions of the Spaces, in the Earth which are called Rents, and the Arrangement of the Matter in them.* By Mr. John B. Longmire.

(Continued from vol. v. p. 281.)

### *The junctions of bended-tabular Rents.*

The horizontal direction of any rent is not parallel to this direction of all the other rents in a formation; and as the lengths of rents in general are much greater than the distance between any two contiguous rents, many rents must be joined to others. Two of the junctions of bended-tabular rents I am now to describe.

Bended-tabular rents, according to the difference in their positions, are joined together in their horizontal directions, and in those which are at right angles to them, whether angular or perpendicular. The junctions of these rents, in common language, are called crossings: and one rent is said to intersect and to cross another; and to disturb it by throwing or heaving it, either upwards or downwards, in horizontal junctions, and either to the right or left hand, in angular junctions.

#### 1. *Of horizontal Junctions.*

When the sides of one rent, say the rent A. fig. 1, Plate XXXV.,



are joined to those of another,  $BB$ , in a direction  $cd$ , which is horizontal, they are joined together in their horizontal directions.

If a miner, in travelling downwards in the angular direction,  $ab$ , of a rent,  $B$ , meet with another rent,  $A$ , having a reverse position, and whose *upper side*,  $fg$ , is horizontally joined to both sides of that part of the rent in which he is standing, then the part of the latter rent which is joined to the *under side* of the former rent, will join it, as at  $c$ , above the place where the part  $ab$  joins it on the opposite side.

Let it be remembered that the strata are always lower on the upper side than on the under side of every rent of this shape, then this separation of the rent  $B$  into parts will be easily accounted for. The lowest extremities of any one rent are generally situated in one stratum; hence, as the matter of the formation contracted, these extremities of both parts of the *separated* rent would necessarily sink with the stratum that contains them; but this stratum, as well as those above it, sunk a greater distance on the upper side, than on the under side of the unseparated rent, and brought down the part of the separated rent which lies on the former side as much lower than that part of this rent on the latter side of the *unseparated* rent, as the strata are lower on this than on that side of the last rent. This "want of opposition," therefore, in the two parts of one of the joining rents which lie on opposite sides of the other is the effect of that unequal contraction of the matter which produced the rents, and is not caused by the action of a newer rent on an older, as has been generally supposed.

In every junction where the unseparated rent is the larger, it is as old as, if not older than, the separated rent; but when it is the smaller, it is always the newer of the two joining rents. I would in both instances, however, be understood to mean, that the formation of these rents took place during the process of the matter's consolidation; and when I say one is older than the other rent, I only mean that the commencement of the formation of the older happened before that of the newer rent; and, not that any one rent was completely formed and filled before the formation of any other had commenced.

## 2. Of angular Junctions.

When two rents are joined together in their angular directions, they exhibit the appearance of fig. 3, Plate XXXV.; in which the parts,  $bg$ ,  $hd$ , of one rent,  $A$ , are joined to another rent,  $BB$ , in a direction,  $bfg$ , which is parallel, or nearly so, to the angular direction of both rents. I will at present only describe the horizontal junctions of two rents that meet each other at nearly right angles; one of which, the unseparated rent, contains both kinds of the earthy tabular masses, and the other, or the separated rent, contains both of the earthy associated with the metallic tabular masses. If a miner, in travelling in the horizontal direction of a rent,  $ab$ , fig. 2, (which figure is a horizontal view of an angular junction of

two rents) whose under side is on his right hand, meet with the upper side,  $cb$ , of an unseparated rent, then that part of the separated rent,  $ed$ , which lies on the other side of the unseparated rent, is always a given distance,  $bd$ , to his left hand. Let fig. 3. represent the angular direction of such a junction as the man sees it when he looks towards the unseparated rent in the direction  $ab$ , fig. 2.  $bc$  is the upper side, and  $di$  the under side of the unseparated rent. The dotted lines  $dh$  represent the angular figure of the separated rent on the under side, and the lines  $bf$   $g$  the same figure of this rent on the upper side of the separated rent. Suppose the line  $id$  represent a stratum on the under side of the unseparated rent, then the line  $lf$  will represent the same stratum on the upper side of this rent. Again, let the line  $hk$  represent the stratum in which the lowest extremity,  $h$ , of the separated rent on the under side of the unseparated rent is situated, then the line  $g$  will be the same stratum, and one that contains the lowest extremity of the former rent on the upper side of the latter rent. Now a line,  $df$ , drawn from  $d$ , down the rent  $BB$ , at right angles to its horizontal direction  $cb$ , will pass through the point  $f$ , and a similarly disposed line, drawn from the point  $h$ , will pass through the point  $g$ ; hence the part  $fg$  is equal to the part  $hd$ , and both make a similar angle with the perpendicular line  $gc$ ; but the top of the part  $fg$  is a given distance below the top of the part  $hd$ ; this distance is equal to that which the strata are lower on the upper than on the under side of the unseparated rent. Continue the rent  $gf$  upwards in its natural direction, till it reaches the line  $bc$ , say at  $b$ : at that place it is the distance  $bd$  from the other part of the rent. This horizontal distance between the two parts of the separated rent, is caused entirely by the strata sinking lower on the upper than on the under side of the unseparated rent, and carrying down with them the separated rent on that side lower than the strata carry its opposite part on this side of the rent; for it is evident that, if the stratum  $g$  be elevated to  $hk$ , and the stratum  $lf$  to  $di$ , the part of the separated rent,  $fg$ , will be directly opposite the part,  $hd$ , of the same rent.

The unseparated rent in all junctions has hitherto, for the following reasons, been considered the newer rent. The tabular masses in the unseparated rent preserve their usual arrangement opposite the ends of the separated rent, while these masses in the latter rent end against the side of the former rent; hence the separated rent must first have been formed and supplied with its contents, then another or unseparated rent produced across the rent, which, of course, would separate it, and which, in consequence of being formed the last, would not have its contents disturbed opposite that rent which it crossed. But such an arrangement of matters in rents at these junctions does not, by any means, warrant this conclusion! For, if the separated rent be the older, the tabular masses in it must have been in such a state of solidity, that when the formation of the unseparated rent commenced, they could

retain their situations. But we have only to say, that the unseparated rent is the older, and that the tabular masses in it were so sufficiently consolidated as to preserve their situations, when the separated rent was formed and filled, and the arrangement of these masses will evidently support this, equally as well as the other assertion: this reasoning will not, therefore, *of itself*, decide whether is the older rent. When the unseparated rent is the larger, it is as old as, and probably older than, the separated rent. For, the formation of all rents commenced at their lowest extremities, and as the larger rent extends farther downwards than the smaller, if their respective dimensions be taken from one level, that part of the former which is below the lowest extremity of the latter must have been the soonest forming; and it is certain that the larger rent would commence in the stratum containing the lowest extremity of the smaller rent, as soon as this rent commenced in that stratum. Whether rent took the lead upwards we cannot tell with certainty: but that there has not been much difference in point of time between those unseparated rents which contain the first and second-formed earthy tabular masses, and those separated rents which contain the earthy and metallic masses, is very probable; because the first-formed earthy masses in both rents clearly point out the small degree of the matter's solidity at the commencement of the formation of both these rents. One circumstance inclines me to suppose that the unseparated rent is the older; namely, the existence, in this rent near these junctions, of large metallic tabular masses, which are similar to the metallic masses in the separated rent, and which are not found in other parts of the unseparated rent, except in very small quantities. For it is probable the hollow places which contain these metallic masses were produced after those first-formed earthy masses near which they are situated, and that the metallic matter passed out of the separated rent into these hollow places in a fluid state. Now the metallic masses in the separated rent being cotemporary with the first-formed earthy tabular masses in it, it is clear that they were not produced as soon as the first-formed earthy tabular masses in the unseparated rent; hence, this is older than that rent. But in all junctions where the unseparated rent is the smaller, it is the newer rent; and then its contents indicate its newness.

There are four distinct examples of the horizontal junctions of bended-tabular rents, and eight angular junctions of the same rents; but as these junctions could not be described without reference to drawings, I have, for the present, omitted them. The junctions also of bended-tabular with all other rents, I need not at present describe, as excellent descriptions of many of them will be found in Williams' Mineral Kingdom, and as the reader will have no difficulty in referring all their phenomena to the cause which I have already pointed out; namely, the unequal contraction of the earth's matter.

June 7, 1815.

## ARTICLE IX.

*Extract of a Letter from Professor Berzelius to Professor Gilbert.\**

Stockholm, Oct. 8, 1814.

FEW letters have given me so much pleasure as that which I found from you on my return from Fahlun, where I had been the whole summer. I had been long without hearing from you, and none of my acquaintances who had been at the battle of Leipsick could give me any information respecting you, I was apprehensive in consequence that you were no longer in the land of the living.

I have not yet answered the objections of Dr. Fischer, of Breslau, to my analysis of nitrate of silver. The experiment of Dr. Fischer, who obtained an explosion by heating nitric acid over muriate of silver, did not succeed with me. † I repeated the experiment according to his directions; but no explosion followed. After Davy's *ozotane* became known, I made some experiments with it, and satisfied myself, from the smell, that whenever concentrated muriatic acid and concentrated red nitric acid are digested together, this remarkable compound is always formed; but I have not in these cases observed any explosion. Warned by Fischer's statement, I always placed the vessel in which this mixture was digested in a separate and safe place. It is exceedingly probable that this peculiar body is nothing else than *aqua regia* quite free from water; for it dissolves slowly in water, and forms, as Davy likewise remarked, a weak *aqua regia*. These few observations show clearly that Davy's analysis of this substance is inaccurate, and that he corrected his results in consequence of theoretical views.

Hitherto too little attention has been paid to the combination of acids with acids, and to acids free from water. Hence the reason why so much of the wonderful has been observed in isolated observations, which, when the whole mass of chemical facts are surveyed, lose every thing wonderful, and harmonise with our previous knowledge.

How much, for example, have chemists wondered at the smoking state of sulphuric acid? yet they missed observing the real nature of that body; for though it was known that common sulphuric acid contains abundance of water, and that the smoking *Nordhauser* sulphuric acid forms with water common sulphuric acid, and with the bases common sulphates; yet the consequence was not drawn that the smoking acid contains no water.

\* Translated from Gilbert's *Annalen der Physik* for Nov. 1814, vol. *lxviii*, p. 327. I have been induced to publish it here, because it contains some opinions relative to British chemists with which I think they ought to be acquainted. Gilbert's *Annalen* contains many other similar letters.—T.

† The explosion only takes place, as Dr. Fischer has more lately stated, (*Annalen*, *lxvi*. 439.) when diluted nitric acid or *aqua regia* is boiled over horn silver, but not when these acids are concentrated.—GILBERT.

This anhydrous sulphuric acid agrees in various points with the anhydrous acid formed by the action of aqua regia upon sulphuret of carbon. Anhydrous sulphuric acid, this triple acid, nitrous sulphuric acid, murio-carbonic acid (phosgene gas), nitro-muriatic acid, fluo-boric acid, &c. form a complete new class of chemical compounds. Some of these compounds contain no water, and show in consequence properties, which, from the analogy of the hydrous acids, we could not have expected, and which they lose as soon as they come in contact with water. Some of them are even decomposed by this liquid, the water introducing a new play of affinities. As long, however, as chemists are involved in the maze into which they have been led by the new hypothesis respecting the nature of muriatic acid, they will not be able to see these appearances in a proper and general point of view.

I have published in Dr. Thomson's *Annals of Philosophy* an examination of Davy's new hypothesis, and of the old doctrine respecting the nature of muriatic acid, and I have produced a very decisive argument against Davy's hypothesis, furnished me by the analysis of the submuriates of copper (as well as those of lead) containing water of crystallization. The proportion of these two substances is such that the quantity of oxygen in the water of crystallization is equal to that in the oxide of copper according to the old theory; but according to Davy's hypothesis, which supposes muriatic acid composed of one volume of hydrogen and one volume of chlorine, we find the corresponding quantity of oxygen in the oxide of copper; but one-fourth of the water must be abstracted in order to form the muriatic acid and oxide of copper. Hence it follows that the oxygen in the water is to that in the oxide of copper as 3 : 4. Hence Davy's hypothesis is inconsistent with the doctrine of definite proportions.

Both Dr. Thomson and Sir Humphry Davy have answered this objection in a manner that has astonished me. Dr. Thomson's answer is barely this: "Berzelius's arguments are not at all hostile to Sir H. Davy's theory."\* And Davy himself says, in his last Bakerian lecture, "I cannot regard the arguments of my learned

\* Since Berzelius does not perceive the fallacy of his argument, I shall point it out to him here. His submuriate of copper is a compound of muriatic acid, oxide of copper, and water. I have no doubt that his analysis of it is nearly accurate; and that the law which he points out and applies to it is correct. But this has nothing whatever to do with Davy's theory, because the salt in question is not a chloride, but a muriate. Suppose we were to convert it into a chloride by exposure to heat, (the process in the present case would not answer; but we may suppose it;) in that case all the water would be driven off, the oxygen of the copper would combine with the hydrogen of the acid, and fly off in the state of water, and nothing would remain but chlorine and copper. Here Berzelius's laws could not apply, because neither water nor oxygen is present in the compound. It is amazing to me that so acute a man as Dr. Berzelius should advance so futile an argument. It can only proceed from his never having made himself acquainted with the details of the theory which he was opposing. Muriates exist as well as chlorides; though, as they always contain water, they are not so easily examined. All his other arguments, like this, are founded on misconceptions.—T.

friend as possessing any weight—and there is no general canon with respect to the multiples of proportions in which different bodies combine," &c.

My experiments upon the constant and definite proportions which exist in compounds I have been at some pains to get translated into English and published in Great Britain. However, sufficient attention has not yet been paid to them in that country. In a treatise upon the Daltonian theory of chemical proportions, Dr. Thomson has given the whole merit to Dalton. My laws are only mentioned to be refuted; and when they do not immediately follow from Dalton's atomic doctrine, to be discarded without further proof. The consequence is, that my experiments have only been handled in a very slight manner. A friend has communicated to me from London some preliminary information respecting Wollaston's treatise on Chemical Equivalents, in which he has employed a sliding rule for the discovery of the requisite proportions. He adds, "I have the pleasure to be able to say that Dr. Wollaston has therein admitted the accuracy of your numerous labours." But this excellent philosopher, of whose friendship I am proud, has not named me. At present being uncertain how the oxalates are combined, he has made some experiments respecting them; and my friend says, "I have the satisfaction to find that his experiments agree with yours."—Lately attempts have been made to show that Higgins was the discoverer of the atomic theory, and a dispute on the subject has arisen between Dalton and Higgins. Dr. Thomson says, that even if the atomic doctrine had escaped Dalton, it would have been discovered by other *English* philosophers; and afterwards, in order to correct the improper use of the word *English*, he explains himself, by informing us that he alluded to Dr. Wollaston. We may see in this example how difficult it is in England to estimate foreigners correctly.\* You need not, therefore, be surprised that your Annals are not better known in England. When I was in that country I allowed some numbers of your Annals to come from Sweden, that I might be able to get my papers translated out of them. However, had not Dr. Thomas Young, Foreign Secretary of the Royal Society, undertaken the translation out of friendship for me, I should have found it difficult to meet with a single chemist in the whole country who could have translated the papers in question. Mr. Accum and Mr. Brande are Germans by birth.—You will receive from me in a short time a second and third appendix to my experiments on the definite proportions in which bodies combine.

\* That novelty of matter has more share in this than the circumstance of foreigner appears to me evident, among other things, from Dalton's vindication of his atomic doctrine, which does not appear groundless, and from Mr. Mier's determinations respecting azotic gas, with both of which I shall shortly make my readers acquainted. The former terminates as follows: "Notwithstanding this, whatever may come from the pen of Berzelius on the subject will, no doubt, be worthy the attention of the chemical world."—GILBERT.



You ask me to examine what Gay-Lussac has advanced respecting the nitrous gas eudiometer, and to repeat the experiments on which his method is founded, because they are in opposition to my views relative to nitric and nitrous acids. I acknowledge that I feel no inclination to undertake such a task. I am always averse to disputes; and if I were to engage in one, it must be of such a nature that it could be fully resolved by experiment. This is not the case with Gay-Lussac's experiments. Dalton has already shown, with tolerable accuracy, that according as there is an excess of nitrous or oxygen gas, a maximum or minimum of nitrous gas will be absorbed, both measured by the quantity of oxygen gas which is likewise absorbed. On this maximum or minimum usually depends the formation of pure nitric or nitrous acid. The question, therefore, comes to this: whether between these two points there are gradations, consisting of combinations of determinate proportions of nitric and nitrous acids, or not; and likewise whether the results of Gay-Lussac be those which he really obtained, or whether he did not correct them by his views of true theory. The solution of these questions is attended with too much difficulty for me to bestow upon them the time that would be required for their examination.

M. Avogadro's remarks upon my electro-chemical theory I have already read in the *Annales de Chimie*. He appears not to know the treatise on the chemical action of the electrical pile by Hisinger and myself. His remarks upon my use of the terms *electro-positive* and *electro-negative* are correct. They had been already anticipated in your *Annals*, on occasion of my experiments and those of Davy. I had changed them for others long before Avogadro's paper appeared, as may be seen from my papers published in England. Some additions to the electro-chemical theory, which these papers contain, and which hitherto are unknown both in Germany and France, are perhaps worthy of your attention. You will find them in my treatise on the Cause of Chemical Proportions.

Van Mons has communicated to me the discovery that he has decomposed the fluates at a red heat by means of hydrogen, and obtained compounds of fluoric acids and metals destitute of oxygen. Certainly this is strange. It ought likewise to be inaccurate, according to his preconceived opinions. Has he obtained a fluoric oxide, or a compound of *fluoricum* with metals? Had he given me the names of the salts on which he made his experiments, it would have been easy to have investigated the subject. But I must wait for a more accurate account of his experiments, which he has promised me, before I can repeat them.

You say to me that different persons wish that I would give an example how I make accurate chemical analyses on a small scale. This would be a difficult task; for I believe that I possess no other method or greater dexterity than other chemists. I seldom work upon a small scale. Most of my analyses are performed with ten or five grammes, that is to say, with 160 or 80 Nurnberg medicinal grains (154.44 and 77.22 grains troy); and this I believe is the best



quantity for chemical analyses. The difficulty is increased when either much more or much less is employed. In all my analyses I have this rule before my eyes: "Endeavour to find a method of analysis so that the accuracy depends as little as possible upon the manual dexterity of the operator. When this is found, consider what unavoidable circumstances intervene to render the results inaccurate, and whether by their means the quantities obtained are increased or diminished. Then make a second analysis, in which all these circumstances act in a way directly contrary. If the results agree, the experiment is accurate." For example, you will find in my analysis of red oxide of iron that in one of my experiments I dissolved the iron in a weighed glass capsule, evaporated the solution, and exposed the oxide to a red heat. Here no loss was possible. In a second experiment I dissolved the iron in aqua regia, precipitated it by ammonia, washed the oxide upon a weighed filter, and exposed it to a red heat. Here no increase was possible; nothing but a diminution could take place. But both experiments gave the same results. Hence I concluded that in the first experiment no increase of weight had taken place, from the impurity of the acid, or the corrosion of the glass; and that in the second no remarkable loss had been sustained, in consequence of the inaccuracy of the method followed. By these perpetual checks I have learnt to look for, and to avoid, sources of inaccuracy. I have pointed out several of these sources in my manual of chemistry under the article *inorganic substances*. Still, however, a good deal depends upon manual dexterity and long practice; so that it is as impossible to make an accurate chemist by written directions as it is for one artist to make another a consummate tradesman by mere written rules. A clever student of chemistry might perhaps learn from me to attend to several small particulars, which he might not of himself remark, and yet are of importance.

But my letter is already too long.

BERZELIUS.

## ARTICLE X.

*Astronomical and Magnetical Observations at Hackney Wick.*  
By Col. Beaufoy.

Latitude,  $51^{\circ} 32' 40.3''$  North. Longitude West in Time  $6^{\text{h}} \frac{20}{100}^{\text{m}}$ .

June 10, Occultation of $\gamma$ Cancri	{ Immersion.... 9 <sup>h</sup> 26' 11'' } { Emersion .... 10 9 34 }	Mean Time at H. W.
by the moon .....		
June 11, Emersion of Jupiter's	{ 11 <sup>h</sup> 33' 19'' } { 11 33 26 }	Mean Time at Hackney Wick. Ditto at Greenwich.
1st Satellite .....		

## Magnetical Observations.

1815.

Month.	Morning Observ.			Noon Observ.			Evening Observ.		
	Hour.	Variation.		Hour.	Variation.		Hour.	Variation.	
May 18	8 <sup>h</sup> 35'	24° 16'	29''	— <sup>h</sup> —'	— <sup>o</sup> —'	—''	7 <sup>h</sup> 15'	24° 20'	18''
Ditto 19	8 45	24 19 00		1 30	24 26 03		— —	— —	—
Ditto 20	8 35	24 17 10		1 40	24 28 38		7 20	24 20 04	
Ditto 21	— —	— — —		1 35	24 26 28		7 15	24 20 07	
Ditto 22	8 35	24 16 17		1 35	24 26 58		7 10	24 18 54	
Ditto 23	8 40	24 16 58		1 30	24 29 27		7 10	24 18 53	
Ditto 24	8 50	24 16 32		— —	— — —		7 10	24 17 34	
Ditto 25	8 50	24 17 52		— —	— — —		— —	— — —	
Ditto 26	8 40	24 16 51		1 35	24 27 42		7 05	24 19 06	
Ditto 27	8 40	24 15 22		— —	— — —		7 15	24 19 00	
Ditto 28	8 35	24 13 57		1 40	24 28 50		— —	— — —	
Ditto 29	8 35	24 15 05		1 45	24 28 03		7 05	24 18 50	
Ditto 30	8 25	24 14 16		1 40	24 26 59		7 10	24 18 26	
Ditto 31	8 10	24 15 18		1 40	24 25 34		7 15	24 19 45	

## Magnetical Observations continued.

1815.

Month.	Morning Observ.			Noon Observ.			Evening Observ.		
	Hour.	Variation.		Hour.	Variation.		Hour.	Variation.	
June 1	8 <sup>h</sup> 40'	24° 17'	05''	— <sup>h</sup> —'	— <sup>o</sup> —'	—''	7 <sup>h</sup> 05'	24° 19'	16''
Ditto 2	8 35	24 15 45		— —	— — —		— —	— — —	
Ditto 3	— —	— — —		— —	— — —		7 05	24 19 19	
Ditto 4	8 40	24 17 00		1 20	24 27 20		— —	— — —	
Ditto 5	8 25	24 16 02		— —	— — —		— —	— — —	
Ditto 9	— —	— — —		— —	— — —		7 05	24 18 53	
Ditto 10	8 30	24 16 03		1 30	24 29 15		7 05	24 18 24	
Ditto 11	8 40	24 16 46		1 40	24 28 50		7 10	24 17 39	
Ditto 12	8 30	24 16 19		— —	— — —		— —	— — —	
Ditto 13	— —	— — —		1 30	24 25 53		— —	— — —	
Ditto 14	8 40	24 16 04		1 30	24 27 09		7 05	24 18 31	
Ditto 15	8 40	24 16 39		1 35	24 26 40		7 05	24 21 07	
Ditto 16	8 35	24 17 10		1 15	24 27 37		— —	— — —	
Ditto 17	8 45	24 15 38		1 10	24 26 28		7 25	24 21 34	

		1813.	1814.	1815.
April.....	Morning .....	24° 09' 18''	24° 12' 53''	24° 16' 01''
	Noon .....	24 21 12	24 23 53	24 27 42
	Evening.....	24 15 25	24 15 30	24 17 48
May .....	Morning .....	24 12 02	24 13 12	24 16 32
	Noon .....	24 20 54	24 22 13	24 27 03
	Evening.....	24 13 47	24 16 14	24 19 12

There appears to be a singular increase of the variation in the month of April, more particularly so in May and June. Suspecting there might be some error, the source of which was in the instrument, but which I could not discover, I sent it to the maker, Mr. Dollond, who examined it, sharpened the point of suspension, and placed new agates in the needles, which alterations do not seem to have affected the result of the observations. May it not therefore be justly inferred that the increase is real, and not apparent? One circumstance is indubitable, which is, that the vibration of the needle has been seldom, and of small extent, since the 20th of February last, on which day the needle vibrated between 28 and 29 minutes.

The immersion and emersion of  $\eta$  Cancri was instantaneous, and no diminution of the star's light was perceptible.

The dew which fell on the instrument rendered the observation on the 11th inst. doubtful to a few seconds.

Rain fallen	{	Between noon of the 1st May	}	1.131 inch.
		Between noon of the 1st June		
Evaporation during the same period		.....		2.70

## ARTICLE XI.

*Recovery of the Aachen Mass of Native Iron.* In a letter from Dr. Benzenberg.\*

*Kloster Brüggen, near Crefeld, Dec. 15, 1814.*

You will already know that the great mass of native iron at Aachen, which had been lost, has been lately again found. I went last week to Aachen to see it, and can give you the following information respecting it.

In the year 1762 Councillor Löber was with Maximilian Prince of Saxony at the baths of Aachen, as his physician. At the time they inhabited the house called Büchel, at the new bath. Löber observed in the pavement an uncommonly large iron-stone. He requested liberty to dig it up, obtained it, and took some specimens of it. He gave some of the smallest to the physician Dr. Kretschmann, in Dresden, whose collection of minerals came into the possession of the University of Wittenberg. This information is to be found in the Wittenberg Weekly Paper for 1773, page 36; from which it found its way into the Memoirs of the Berlin Natural History Society, vol. vii. page 323. By a mistake of the writer in both accounts, Aken is substituted for Aachen; and Chladni, who mentions this mass of iron in his well-known treatise, considers the place as Aken in Magdeburg. Letters were written to Aken on the

\* Translated from Gilbert's *Annalen der Physik* for Dec. 1814, vol. xlviii. p. 410.

subject; but there they knew of no mass of iron whatever. It was then referred to Aachen, in another paper which appeared in 1804, on native iron. Probably the mistake was discovered by the reference to the baths in the original paper.

In the year 1812 Dr. Chladni wrote to the Consistorial President, Frederick Jakobi, at Aachen, requesting information respecting this mass of iron. As Dr. Lesoinne could give no intelligence respecting it, he and apothecary Monheim applied to the old town secretary, Couver. He recollected the digging up of the mass in 1762, and that some pieces had been struck off, and deposited in the town-house, but had been soon after lost. The mass, he said, had been again deposited in the place from which it had been dug, and the surface again plastered over. Fourteen days after this information Couver died, at the age of 78.

Mr. Monheim gave this information to Trommsdorf, who published it in his journal in 1812. Professor Weiss, in Berlin, endeavoured to interest the Academy in the re-discovery of this mass of iron in a town which belonged to the general government of Prussia. In consequence an order was obtained from the Chancellor Prince Hardenberg to the Governor-General Sack to fulfil the wishes of the Academy.

The plaster being again removed, and the bottom examined for several days, the mass of iron was at last found, dug up amidst a crowd of people, and brought into the court of Mr. Biergans, Director of the Circle, where it lies at present.

It is covered with iron ochre, and, like all similar masses, is of an irregular shape, approaching to the oval. Its length is four feet nine inches; its breadth, two feet eleven inches; and its thickness two feet six inches; and its specific gravity, determined by a piece struck off from it, is 6·7. The whole weight amounts to about 10,000 lbs., supposing we reduce the size to  $\frac{3}{4}$  or  $\frac{2}{3}$  in order to convert it into a parallelogram. The coating of ochre is half a line thick. Under it there lies a kind of bark half an inch thick, which may be easily separated from the stone. It is greenish, vesicular, and exhibits the marks of fire. Under this covering lies the native iron. It is extremely tough. In breaking off a few specimens, no fewer than eight chissels were broken. Mr. Monheim, a pupil of Vauquelin, has not yet finished his analysis of it; but he has ascertained that it contains no nickel, but is composed of about  $\frac{1}{5}$  arsenic and  $\frac{4}{5}$  iron. Perhaps also there may be a third metal; but it is in so small quantity that Mr. Monheim has not yet determined its nature.\*

How this mass has come to Aachen, we have no information.

\* According to the statement of Lüber, the weight of this mass of iron was between 15,000 and 17,000 lbs., and it was covered with a coating from an half to one inch in thickness. It was malleable, and could be hardened and polished like the best English steel. Klaproth found no nickel in the 300 lbs. of native iron found at Villa, on the Collina di Brianza; but in the 130 lbs. from Ellnbogen he found 2·5 per cent. of nickel.—GILBERT.

The Governor-General ordered search to be made; but the old chronicles are wanting. There is a tradition among the people that it lay at the Büchel, and that as long as it lay there the warm baths would never fail. Some are of opinion that when the castle of Charlemagne at Aachen was burnt, the iron in it was melted, and formed this mass. Others are surprized that it was not destroyed in former times. My opinion is that we ought not, without knowing the conclusions of naturalists, determine any thing respecting the origin of this remarkable mass of iron.

---

## ARTICLE XII.

*An Account of the Explosion at the Success Coal-Pit, near Newbottle, in the County of Durham: drawn up for the Annals of Philosophy.*

ANOTHER dreadful and destructive explosion of carbureted hydrogen gas took place in the Success coal-pit, near Newbottle, in the county of Durham, the property of Messrs. Nesham and Co., on Friday, June 2, at half-past four o'clock, *p. m.* by which 57 persons were killed upon the spot, besides several wounded.

The immediate cause of this shocking catastrophe is not clearly ascertained; though it is generally believed that the pitmen had inadvertently worked into the old workings, or some place where there had been a large collection of inflammable air.

As all the unfortunate labourers were instantly killed, and the explosion and consequent very rapid return of the atmospheric air *after* the explosion destroyed the headings and air courses, the whole of the colliery became so completely altered that no correct idea of the cause from appearances could be formed. It is also the opinion of well-informed persons, who were present at the time of the accident, that from some unaccountable circumstance the atmospheric air could not be sent down in sufficient quantity, and in a proper direction, *after* the explosion, to those persons who might have escaped the destructive power of the explosion, who might live till their scanty supply of atmospheric air became exhausted.

When the explosion took place, 72 men and boys were at work at the depth of 108 fathoms; and though the greatest endeavours were made to relieve those distressed persons, only 15 survived, some of whom are in a very precarious state. The explosion was so great as to carry every thing before it, till it was impeded in its progress by a large waggon, which, with the driver and horse, were dashed to pieces.

Several men in the colliery, after they had escaped this *tornado* of fire, endeavoured to reach the shaft; but death arrested them on their road; for breathing an atmosphere surcharged with carbonic acid gas, their destruction now became inevitable.

Some of the men survived till they were brought up the shaft into the atmosphere, when they died, perhaps unable to bear the stimulus of the atmospheric air after the state of exhaustion in which they had previously lived for some time.

After a considerable explosion takes place in a coal-mine, the pitmen are often drenched with water, which is probably occasioned by the rapid combustion of hydrogen gas in such a confined situation, as may be readily understood by persons conversant with chemistry. At the same time all the partitions and divisions being broken down, whilst the air courses are converted into a complete wreck, and the whole atmosphere of the mine so much agitated, it is to be expected that the carbonic acid gas will be distributed through the bottom of the mine, and suffocation become the fate of those persons who escape the immediate effects of the explosion.— Out of 19 horses only six died.

It is melancholy to relate, that in the short space of a month 132 useful and laborious persons have been numbered with the dead at Heaton and the Success collieries, leaving nearly 300 widows and orphans to be subsisted by charity and parochial assistance.

It is curious, and perhaps worthy of remark, that Robson and Miller, accomplices with Edward Smiles in the robbery at Mr. Cuthbert Pye's, Scaffold Hill, some time ago, are amongst the killed in the late accidents at Heaton and Success collieries; and upon the 3d inst., the day after the latter accident, Mr. Cuthbert Pye himself died at Scaffold Hill.

The efforts at Heaton colliery, though very considerable, have not yet been so far successful as to remove the water, and permit the interment of the unfortunates who were lost in that colliery.

On Monday, June 5, another explosion occurred at the Tyne Main colliery, by which one man was severely, though not fatally, scorched.

As most of the explosions in coal-mines have taken place in the summer season, it appears desirable that particular care be taken during the hot weather, which, perhaps, by expanding such an elastic fluid as hydrogen gas, may afford a facility to such dreadful accidents. F.

Newcastle, June 12, 1815.

---

## ARTICLE XIII.

### ANALYSES OF BOOKS.

I. *Transactions of the Geological Society*, Volume 2d. London, William Phillips, 1814.

(Concluded from Vol. v. p. 452.)

XI. *Account of the Coal-Field at Bradford, near Manchester.* By Robert Bakewell.—This coal-field is about two miles long, and

2000 yards broad. It lies over the old red sand-stone. There are ten beds of coal, which dip to the south, at an angle of about  $30^{\circ}$ . The other beds consist of slate-clay and bituminous shale, with iron-stone, sometimes in beds, sometimes in nodules. Above the first bed of coal there lie three beds of lime-stone, from two to six feet in thickness, of a reddish-brown colour, and without animal remains. The most important bed of coal is about the middle, and is four feet thick. On the north side of the field, about ten yards from the red sand-stone, a perpendicular bed of coal four feet thick rises to the surface. It terminates the coal. The space between it and the red sand-stone being filled with irregular fragments of rock, every thing shows that this perpendicular bed is the same as the four-feet bed in the coal-field. Fourteen hundred yards to the north of Bradford there is another coal-field. They are divided from each other by old red sand-stone. Mr. Bakewell supposes that this sand-stone has been forced in horizontally between the two fields, and has occasioned the change in the direction of the four-feet bed. He supposes likewise that the mill-stone grit of Derbyshire is a continuation of the old red sand-stone.

XII. *Some Account of the Island of Teneriffe.* By the Hon. Henry Grey Bennet, M.P. F.R.S. Pres. Geological Society.—This is the principal of the Canary Islands. It is about 70 miles long and 30 broad. A range of mountains runs through its centre. The Peak is a little to the south-west of the centre. Its height is about 12,500 feet. The whole of the island is volcanic, and all its rocks are lava. Mr. Bennet conceives that formerly a very large crater (twelve miles in diameter) existed, the sides of which, under the name *Las Faldas*, may be still traced a great way. Many extinct volcanoes are to be seen every where. The crater at the top of the Peak is but small, and seldom in activity. The lavas vary in their appearance; some are composed of horn-blende and felspar, without any foreign body; these are porphyritic; some are composed of green-stone, and contain olivine, augite, zeolites; some are basaltic. These decompose the soonest, and constitute the most fertile soil. There is also pumice in abundance, tufa, ashes, and a lava exactly resembling obsidian. Mr. Bennet gives an interesting account of a journey which he made to the top of the Peak in 1810.

XIII. *On the Junction of Trap and Sand-stone at Stirling Castle.* By Dr. Macculloch.—The appearance here described was laid open to view by digging a new road across the Castle Hill. Horizontal beds of sand-stone occur, at first thick, but becoming thinner as they ascend. Green-stone lies over them, and several of the beds of sand-stone appear forcibly bent upwards at one end, while the green-stone has insinuated itself below them, and filled up the interval. The sand-stone where in contact with the green-stone is converted into horn-stone, or rather flinty-slate. This fact Dr. Macculloch brings forward as a confirmation of the Huttonian theory of the formation of green-stone. I have myself examined



with all the requisite care the different spots of a similar nature pointed out by Dr. Hutton, or his followers, near Edinburgh, but never was able to perceive the force of any of their conclusions. I was long at a loss to conceive what was meant to be conveyed by the term *indurated sand-stone*. At last a friend was good enough to show me specimens. I found that the indurated sand-stone of Dr. Hutton and his followers is the mineral well known by the name of *flinty slate*. Dr. Macculloch mentions clay-slate as occurring in the rock of Stirling Castle. He obviously means slate-clay.

XIV. *On the Economy of the Mines of Cornwall and Devon.* By John Taylor, M. G. S.—The mining concerns of Great Britain being all under the management of individuals, without any controul whatever on the part of government, cannot be expected to proceed with such regularity, or to be conducted with such skill, as in those countries where the whole has been for ages under the management of men educated for the purpose, and where every particular relating to the mines has been from the first carefully recorded. Yet the improvements which have taken place in mining, especially in Cornwall, have been very great; and the vigour with which mining is carried on in that country is truly surprising. Mr. Taylor ascribes this in a good measure to the system which has been gradually introduced, and which he describes. The owner of the soil lets the mine for 21 years to the adventurers, at a stipulated rate, which varies from  $\frac{1}{3}$  to  $\frac{1}{2}$  part of the ore raised, to  $\frac{1}{8}$ th part, according to circumstances. The mine is usually divided into 64 shares, which are parcelled out among the adventurers. The mine is under the charge of a principal captain or agent, who has under him several subordinate captains. These are all practical miners of great skill and integrity. There are other subordinate persons connected with the mines, whom Mr. Taylor describes. The workmen are all employed by the piece. The work to be done is put up to auction and given to the lowest bidder. These sales are open, and considerable competition often takes place at them. The work to be done is of three kinds: *tutwork*, *tribute*, and *dressing*. Tutwork is done by measure, as sinking of shafts, driving of levels, stopping ground. Tribute is payment for raising the ore, dressing it, and rendering it marketable. Dressing is money given for dressing those parts of the ore which the tributers throw away. It is to this mode of raising ore by contract that Cornwall is indebted for the intelligence of its miners, and for most of the improvements in mining which have taken place in it. The ore, when dressed, is sold to the different tin and copper companies.

XV. *On the Origin of a remarkable Class of Organic Impressions occurring in Nodules of Flint.* By the Rev. William Conybeare, M. G. S.—This substance was first observed by Mr. Parkinson, and thus described by him: "Small round compressed bodies, not exceeding the eighth of an inch in their longest diameter and horizontally disposed, are connected by processes nearly

of the fineness of a hair, which pass from different parts of each of these bodies, and are attached to the surrounding ones; the whole of these bodies being thus held in connexion." He classes them among the corals, acknowledging at the same time that they bear no resemblance to any known genus. Mr. Conybeare, in this paper, shows that they are silicious casts of cavities, which have been formed in different kinds of shells by some animalcule, which fed upon the substance of the shell, and which, after exhausting one place, made its way to another.

XVI. *A Description of the Oxide of Tin, the Production of Cornwall; of the primitive Crystal and its Modifications, including an Attempt to ascertain with Precision the Admeasurement of the Angles by means of the reflecting Goniometer of Dr. Wollaston; to which is added a Series of its crystalline Forms and Varieties.* By Mr. William Philips, M. G. S.—This is a most elaborate and exact delineation of all the different crystalline figures which Mr. Philips has observed in Cornish tin ore, referred to the primitive figure of tin-stone and twelve modifications of it. But it would be impossible to render the paper intelligible to the reader without the numerous figures which accompany it, and indeed constitute its chief value. The primitive form is an octahedron, consisting of two four-sided pyramids applied base to base. The plane formed by their junction is a square. The inclination of the faces of one pyramid to those of the other is  $67^{\circ} 50'$ . The twelve modifications, described by Mr. Philips, consist of the primitive form altered by various truncatures, (for the language of Romé de Lisle applies best to Mr. P's mode of describing,) on the angles and edges. The figures of the different crystals given by Mr. P. are in general very distinct and beautiful.

XVII. *On some new Varieties of Fossil Alcyonia.* By Thomas Webster, M. G. S.—In the green sand-stone in the Isle of Wight, Mr Webster observed numerous bodies exactly resembling the branches of trees; in the lime-stone he observed small smooth round bodies, bearing a resemblance to eels in motion. These bodies occur in prodigious quantities in the romantic cliffs of Western Lines. In that place they are found frequently terminating in bulbous heads, bearing a certain resemblance to a closed tulip. He considers them as casts of three or four new and hitherto undescribed species of alcyonia.

XVIII. *Miscellaneous Remarks accompanying a Catalogue of Specimens transmitted to the Geological Society.* By Dr. Macculloch.—This long paper consists of remarks on the mineralogical structure of various places in Scotland. The Island of Rona consists chiefly of gneiss. There are many granite veins in which our author observed wolfram. Graphical granite is common, containing a mineral which has been termed chalcidony. I believe it to be rock crystal. Dr. M. makes some remarks on the impropriety of applying the term *green-stone* to primitive transition and floetz rocks. His primitive green-stone is obviously *syenite*, from the

description he gives of it. He will find this rock always the same in its appearance, whether it occur in primitive, transition, or floetz formations. Therefore, like *lime-stone*, it must always bear the same name. Good specimens of primitive green-stone may be met with in the neighbourhood of Crieff. I do not recollect to have met with them any where else in Scotland. I do not understand what is meant by the floetz green-stone being independent of the rocks with which it is associated. If Dr. M. will travel from Kelso to Sutra Hill, on the road to Edinburgh, he will find in the southern part of his journey, abundance of very characteristic specimens of floetz green-stone. As he advances northward, he will find these characters slowly and almost imperceptibly changing, till at last the rock at Sutra Hill is pure grey-wacke. In this part of Scotland the transition from green-stone to grey-wacke may be distinctly traced. What is more common than to find green-stone passing into basalt, into wacke, and even into slate-clay? Such transitions must be familiar to every person who has examined the rocks about Edinburgh and in Fife.

The Shiant Islands, near Lewes, are composed of trap; but the Doctor's descriptions are not sufficiently minute and precise to enable us to know the individual species. He terminates his account, as usual, with an invective against the inaccuracy of the present nomenclature of rocks. Perhaps a more minute attention than he seems to have paid to the Wernerian division and description of trap rocks, would have induced him to alter his opinion upon this subject. It appears to me an odd way of proceeding to estimate the progress which a science has made, by our own progress in the knowledge of it.

The Island of Rum is of so difficult access that it was only partially examined. The lowest rock found was a sand-stone, supposed to have been formed from granite. Over this was a green-stone, composed of augite and felspar, which Dr. M. thinks peculiar to Rum. It occurs, however, in East Lothian. Over this is an amygdaloid, containing chalcedony, heliotrope, and plasma. The occurrence of these two last minerals in this place had been previously pointed out by Professor Jameson.

The Scur of Egg, which in magnificence far exceeds the celebrated columns of Staffa, was first pointed out by Professor Jameson. Dr. M. says these columns are composed of black pitch-stone porphyry. I believe, with Professor Jameson, that they consist of a mineral intermediate between basalt and pitch-stone.

Dr. M. gives an account of a very extensive lime-stone formation, beginning at Assynt, and running east, and alternating with a quartz rock. He calls it bituminous lime-stone. This name is not correct. It contains carbon, and emits, when rubbed, the smell of sulphureted hydrogen. It belongs to the well-known lime-stone formation, described and analyzed by John, under the name of *lucullite*. It is not possible, from Dr. M.'s description, to make out its geognostic relations. I have little doubt that it is a

transition lime-stone, as lucullite has only been hitherto observed in that position.

Our author gives a description of the lime-stone of Isla, and says it is the general opinion of the Scotch mineralogists that it is a floetz lime-stone. This is surely a mistake. Mr. Jameson, in his *Travels*, calls it primitive lime-stone; and as far as my information goes, this is the general opinion at Edinburgh. How far it is correct, I have no means of knowing, as I never visited the island.

The craig of Ailsa is a well-known mountain, that rises out of the sea at the mouth of the Frith of Clyde. Dr. M. rightly calls it a syenite. From its texture and resemblance to the syenite of Arran there can be little doubt that it is a floetz syenite. The rock of Syene is a true syenite. It does not occasionally contain hornblende; that mineral is an essential constituent. Syenite is connected usually with porphyry, not with granite; primitive syenite with primitive porphyry; and floetz syenite with floetz porphyry. Hence the propriety of giving the same name to both; and hence the reason for separating the rock from granite, with which it is not connected.

An account is given of Devar, an island at the harbour of Campbellton, composed of felspar-porphry. Dr. M. says this rock constitutes the finest specimen of porphyry he has seen in Scotland. Much finer, however, exist in Arran. Our author's invectives against the word *porphyry* are very amusing. I am not aware that any ambiguity exists in the use of that term. Porphyry is a rock consisting of a basis containing crystals of felspar imbedded in it. These crystals are essential to the stone, and therefore never wanting. The term *porphyry*, like *trap*, is generic. The species are distinguished by naming the base, and prefixing it to the term porphyry. Thus *felspar-porphry*, *clay-stone-porphry*, *horn-stone-porphry*, *pitch-stone-porphry*. There is no ambiguity here. Every mineralogist knows, or ought to know, that these bases are connected together, and pass into each other. If I am told that a rock is composed of porphyry, I ask what porphyry? The answer, felspar-porphry or clay-stone-porphry, defines the species. It is true that porphyry occurs in different formations; so do trap and lime-stone; but it will be found that it assumes a similar position in all the different formations.

Under the head Arran, Dr. M. introduces a discussion whether granite ever occurs stratified or not, and terminates as follows:—“We have, however, a perfect certainty that it (*Arran granite*) is not stratified, because veins are found arising from it, and entering the mass of incumbent schistus in the well-known junction at Loch Ranza.” I do not perceive the force of this mode of reasoning. Dr. M., I dare say, will admit sand-stone to be a stratified rock; yet veins of it passing into the incumbent rock are not uncommon in quarries near Edinburgh.

Under the head of Portsoy, Dr. M. enters into some speculations

about the origin of the crystals of schorl, &c. They have sometimes the appearance of being broken, and sometimes are incurvated. I conceive the broken appearance is merely a deception arising from the simultaneous formation of various crystals, which are intermixed with each other. I have seen similar appearances in the crystallization of various mixtures of salt in my own laboratory. The curve must also have been the original state of the crystal which Dr. M. describes. I recollect several years ago to have obtained, crystallized in a common phial, large curved crystals of muriate of strontian. The crystal of schorl passing through garnet must be explained on similar principles.

Craig Cailleach, a mountain near Killin, is composed of chlorite-slate, and contains veins and nodules of quartz. In this quartz crystals of rutile occur.

Dr. M. enters into some speculations respecting the contortions in the strata of mica-slate visible at Loch Lomond, and infers that they must have been produced by the action of external forces. The reasoning of the Huttonians on this subject is well known. The subject ought to be considered in a more general point of view than has hitherto been done. Nothing is more usual than to find granite, gneiss, marble, lime-stone, green-stone, basalt, &c. composed of granular distinct concretions. A section of all such rocks would yield the same appearance of contortions. The apparent contortions in mica-slate, and in the contemporaneous veins which Dr. M. has drawn, are owing to the same cause, whatever it is, that has produced the granular distinct concretions in the above-mentioned rocks. It is impossible to ascribe this to an external force. It must be owing to a law connected with the original formation of the stone similar to that which produces the various cleavages in crystals, and depending obviously upon the same cause.

Dr. M.'s observations on grey-wacke and transition slate appear to me perfectly just; though I am not aware that they possess any novelty. They may, however, be useful in drawing the attention of English mineralogists to the definition of a term which they are in the habit of using with too much latitude. I do not think that the term mechanical, in the usual sense of the word, can be applied to grey-wacke. I believe it was originally formed in the same state as it exists in at present, and that it is not a true sand-stone.

Our author terminates his paper with an account of the rocks about Aberfoyle and Loch Ketterin. He considers them as grey-wacke alternating with mica-slate. As far as I could make out these rocks, for I have been on the spot, they are primitive; sometimes mica-slate, sometimes quartzose clay-slate. There can be no doubt that the primitive rocks graduate imperceptibly into the transition; but so do the transition into the floetz, as may be seen very well in Berwickshire; so that if this gradation were sufficient, as the Doctor supposes, for inducing us to confound the primitive and transition rocks, it would be equally sufficient to induce us to

confound the primitive, transition, and floetz rocks, and to abolish all distinctions whatever. Such gradual transitions might have been expected, and indeed were previously well known.

XIX. *Remarks on several parts of Scotland which exhibit Quartz Rock, and on the Nature and Connections of this Rock in general.* By Dr. Macculloch.—Our indéfatigable mineralogist describes, in the first place, the mountains of Jura, which are chiefly composed of a granular quartz. He endeavours to show that this quartz is in reality a sand-stone formed of disintegrated granite: that it sometimes contains clay, sometimes rounded grains of felspar, and sometimes rolled masses or pebbles of quartz itself. No mode of reasoning is more apt to lead into mistakes than this. And I am strongly inclined to believe that on the present occasion Dr. Macculloch has misled himself by his own ingenuity; at least no specimen of this rock which I ever saw contained a single true fragment, or gave any evidence that it was any thing else than true granular quartz. He then gives an account of the quartz rock which occurs in Sutherlandshire, at Schihallien, and in several other places. In all these, according to him, it is exactly of the same nature as at Jura. Now at Jura it is covered by mica-slate; therefore mica-slate, he infers, is of later formation than sand-stone, and consequently ought to be struck out of the list of primitive rocks. This mode of reasoning is not accurate. Quartz rock occurs in primitive, transition, and floetz formations, provided the old red sand-stone be included under it. Primitive quartz rock is not a sand-stone, but a granular quartz; so is transition quartz rock; but floetz quartz is a true sand-stone, at least in many cases. Primitive quartz rock forms beds in mica-slate as in Jura, in gneiss and granite in Braemar, in mica-slate in Schihallien, in clay-slate in Beniwhone. It occurs also in grey-wacke. It occurs in the coal formation, and among the floetz rocks. In this respect quartz rock agrees with lime-stone, trap, porphyry. There is nothing wonderful in finding this recurrence. Nor does it militate in the least against the doctrine of formations, or the division of rocks into primitive, transition, and floetz. That division is founded entirely upon petrifications. None exist in primitive. They exist in transition rocks; but only the lowest classes of vegetables and animals are found in this position. The floetz rocks contain petrifications more similar to the living beings that now exist; and this similarity increases as we descend in the series. Remove these grand distinctions, and the whole doctrine of rocks is plunged into confusion. Retain them, and the whole is clear. When the same rock occurs in different classes, we have only to apply to it the name of the class in which it is found to keep every thing distinct: and we have only to abstain from applying the observations which we make upon a rock when it occurs in one class to the same rock when it occurs in another class, to prevent our falling into mistakes, and drawing absurd consequences.

XX. *Notice relative to the Geology of the Coast of Labrador.*



By the Rev. Mr. Steinhauer.—The United Brethren have visited this coast as missionaries. They formed a settlement at Nain, in N. lat.  $56^{\circ} 38'$ ; and afterwards two others, Okkak in lat.  $58^{\circ} 43'$ , and Hopeland in lat.  $55^{\circ} 36'$ . It is by these missionaries that all the Labrador minerals have been sent to Europe. The present notice is drawn up from the information of the missionaries. The coast is mountainous and nearly barren, the rocks being bare of soil. Deep rifts are common, as if they were veins not yet filled up. The rocks, as far as observed, are primitive; granite and chlorite are particularly mentioned; both the Hypersten and the Labrador felspar seem to occur in primitive rocks. Floetz or transition rocks occur at Hopedale; for lime-stone has been found there containing madrepores. The height of the mountains is estimated at 3000 feet.

XXI. *Memoranda relative to Clovelly, North Devon.*—By the Rev. I. I. Conybeare, M. G. S.—This is a very interesting paper. The rocks at Clovelly are grey-wacke and grey-wacke-slate. Several distinct drawings are given of the contortions of the beds. Whoever will take the trouble to examine these drawings will see how utterly impossible it is to account for these contortions by the squeezing system, which has been brought forward with such parade. The view of Mr. Conybeare with respect to the Cornish clay-slate is the same which I myself gave in my paper on Cornwall. But there are some circumstances which throw doubts upon the real position of the Cornish slate. The slate at Plymouth is undoubtedly transition; yet it possesses all the characters of the killas of Cornwall. This transition slate may be traced as far west as St. Michael's Mount; and from the direction of the beds there can be no doubt that it passes under the granite, which constitutes the greatest part of that mount. Indeed, upon the south-west side of the mount it may be found alternating with that granite. Hence the mere appearance of the killas is not sufficient to constitute it a primitive rock. We have no proof at present to the contrary; but the discovery of any petrifications in it would be a decisive proof. It is to be hoped, therefore, that the Gentlemen in Cornwall who are interested in the subject will endeavour to ascertain whether any such petrifications exist in it or not.

XXII. *On Staffa.* By Dr. Macculloch.—Staffa has been so often described that little remains to be said respecting it. Dr. M. visited it twice, and examined it with as much care as possible. The columns, he says, are basalt. From the specimens which I have examined, I conceive that the term porphyry-slate is more applicable to the rock of Staffa than basalt. The Doctor refuses to admit the presence of trap tuff in Staffa, though there cannot be a doubt that the pillars stand upon trap tuff. Trap tuff is not a breccia, as Dr. M. supposes. Nothing is more easy than to study this rock, as a considerable part of Arthurseat is composed of it. Its base is a reddish-brown clay. It contains what has the appearance of fragments of other stones; but a careful examination will satisfy any person that they are not real fragments, but minerals,



which have been deposited at the same time with the clayey basis. I consider traptuff not as a breccia, but as an original rock. Dr. M. observed rolled masses of granite, gneiss, and other primitive rocks upon Staffa. He supposes that this had escaped the observation of preceding observers. But this is a mistake. I am pretty sure that the same observation was made by Faujas de St. Fond; though I have it not in my power at present to consult his book. Mr. Mills mentions the same thing in his paper published in the *Philosophical Transactions*, 1790, vol. lxxx. p. 73.

XXIII. *On Vegetable Remains preserved in Chalcedony.* By Dr. Macculloch.—Nothing is more common than to observe in agates arborizations having a close resemblance to plants. The same thing occurs in chalcedony. Daubenton many years ago wrote a paper on the subject, in which he even names the species of plant contained in the chalcedony which he examined. Dr. M. likewise collected a great many of these chalcedonies, and the result of a careful examination satisfied him that true plants, chiefly confervas and mosses, occur in chalcedonies; though very perfect imitations of them are often produced by chlorite. To distinguish the true plant, he applies sulphuric acid to the mineral. If the acid be blackened he concludes that a true vegetable exists in the stone; if not, he considers the appearance as owing to chlorite. It would be difficult to convince me that such delicate vegetables as confervas and mosses can exist in chalcedonies, without so much as their colour or texture being altered. I am rather disposed to ascribe these appearances to manganese, iron, &c. occasionally mixed with bitumen. This bitumen I conceive colours the sulphuric acid, and leads to the conclusion that vegetable matter is present. The fact that some of the lines in agates are blackened by sulphuric acid, mentioned by Dr. Hamel in a late number of the *Annals*, shows that bituminous matter is a pretty frequent constituent of agates.

XXIV. *On the vitreous Tubes found near to Drigg in Cumberland.* Compiled by the secretaries from several communications.—These tubes have been found in hillocks of drifted sand at the mouth of the Irt in Cumberland. The first account of them was sent to the Society in 1812 by Mr. Irton of Irtonhall, Cumberland. Three were found in a single area of 15 yards, forming a hillock elevated 40 feet above the level of the sea. The diameter of each was about an inch and a half. Within they consist of a very hard glass, which strikes fire with steel. One of them was traced to the depth of 30 feet without terminating, though it became smaller. The sand falling in prevented the continuance of the excavations: the sand consists of quartz mixed with grains of horn-stone porphyry. By the blow-pipe urged by a stream of oxygen gas, this sand was imperfectly vitrified, so as to resemble the inside of the tubes. The most probable opinion is, that these tubes have been formed by the action of lightning.

II. *An Index to the Anatomical, Medical, Chirurgical and Physiological Papers contained in the Transactions of the Royal Society of London; from the commencement of that Work to the end of the year 1813; chronologically and alphabetically arranged.* Callow, &c. London.

The Philosophical Transactions contain perhaps a greater number of valuable papers on medical and physiological subjects, than any other publication whatever. But they are so voluminous that it is a very difficult and laborious task to ascertain what they contain. Hence the utility of good indexes, which serve greatly to facilitate the investigations of the medical student. The present Index is very well executed, and calculated in every respect to answer the purposes for which it was intended.

## ARTICLE XIV.

### *Proceedings of Philosophical Societies.*

#### ROYAL SOCIETY.

ON Thursday the 25th of May, a paper by Dr. Parry was read on the cause of the pulsation of the arteries. He stated the opinion of Haller, which is generally received by physiologists, and that of Bichat, who had rejected Haller's explanation in consequence of his dissections of living animals. Dr. Parry then stated the results which he himself had obtained by laying open the arteries of living sheep and rabbits. No alteration in the size of the artery could be perceived, but a motion of the artery backwards and forwards, corresponding to the inspiration and expiration of the animal. Dr. Parry conceives that the artery is a tense tube always full of blood, and that when its diameter is diminished by external pressure, the blood makes an effort to restore the original size. Hence the pulsation. I do not see clearly how this supposition will account for the various diseased states of the pulse well known to medical men, unless we ascribe the aberrations in all these cases to the heart.

At the same meeting, part of a paper by Mr. Donovan was read, giving an account of a new vegetable acid, discovered by him in the juice of the berries of the sorbus aucuparia, together with some observations on malic acid. He extracted the juice of the ripe berries by pressure, precipitated by acetate of lead, washed the precipitate in boiling water, and threw the whole upon the filter. A hard white mass remained upon the filter, and the liquid which passed through deposited, on cooling, fine, white, silky, needle-form crystals. Scheele had stated the acid in these berries to be the malic. But malate of lead had never been observed to crystallize. To clear up the subject, Mr. Donovan saturated the juice of ripe apples with potash, and precipitated the liquid by acetate of lead. The

precipitate treated with boiling water, as in the preceding case, yielded similar silky crystals; but the substance remaining on the filter was a soft magma. Gooseberry juice treated in the same way yielded no crystals; nor raspberry juice, nor the juice of elder berries, nor of sedum tectorum, nor green apples. Thus it appears, that acetate of lead precipitates two different acids in the first two liquids. The first an acid not hitherto observed, which readily forms a supersalt with oxide of lead soluble in hot water; and this solution on cooling deposits the neutral salt in silky crystals: the second malic acid, which forms with oxide of lead a salt not capable of crystallizing. To obtain the new acid in a state of purity, the colourless silky crystals are to be treated with a quantity of sulphuric acid capable of saturating the greater part, but not the whole, of the oxide of lead present. The liquid being filtered to separate the sulphate of lead, a current of sulphureted hydrogen is driven through it till the whole remaining oxide of lead is thrown down. The filtered liquid is now boiled for some time, and then exposed to the air for a few days to get rid of the sulphureted hydrogen.

On Thursday the 1st of June, Mr. Donovan's paper was continued. To the acid thus obtained he gave the name of *sorbic acid*. It possesses the following properties. It is colourless. Its taste is intensely sour, and it reddens vegetable blues. It does not crystallize. It does not readily undergo spontaneous decomposition. Mr. Donovan kept a quantity of it in a phial for a year: no other change happened except the deposition of a very small quantity of mucilaginous matter. It combines with oxide of lead in three proportions, forming, 1. Subsorbate of lead, which is a hard white insoluble powder. 2. Sorbate, which may be obtained either in powder or in crystals, and which is likewise insoluble. 3. Supersorbate, which does not crystallize. The alkaline supersorbates may be all obtained in the state of crystals. It forms soluble salts with barytes, lime, and magnesia. It does not combine with alumina. These properties sufficiently distinguish this acid from the malic.

Mr. Donovan likewise related his experiments on the preparation of malic acid. He found none of the methods recommended by Scheele capable of furnishing pure malic acid. He considers Vauquelin's process for preparing malic acid from the juice of the sedum tectorum as the only one that yields a tolerably pure acid. I may observe here, that about 10 years ago I made some experiments on the preparations of malic acid, and found that unless it be freed from mucilage before precipitation with lead, it cannot afterwards be separated from a considerable quantity of gummy matter which seems to fall down in combination with the lead. I ascribe most of the difficulties which have occurred to chemists in preparing this acid, to not animadverting to this circumstance.

Mr. Donovan conceives it likely that the bitter principle which exists at first in various fruits and disappears as they advance to maturity, may be the basis of some of the vegetable acids.

At the same meeting a paper by Sir Everard Home, Bart. on the respiratory organs of some genera of vermes that live in water, was read. These organs consist of a number of openings on both sides of the neck, which lead into spherical or flattened balls. Water passes through these openings into the bags, and is afterwards thrown out again. The reason why the water does not enter at the mouth as in fishes, is because these animals, as the leech, require their mouths for suction, either to procure food or to fasten themselves to other bodies.

On Thursday the 8th of June, a paper by Dr. Brewster was read on the multiplication of images and colours which accompany them in some specimens of Iceland spar. Towards the end of the session of the Royal Society, the number of papers presented is usually so great, that only a small portion of them can be read to the Society. On this account nothing can be added to the notice of Dr. Brewster's discovery relative to this subject given in the last number of the *Annals of Philosophy*.

At the same meeting a paper by C. Babbage, Esq. was read, entitled, On the Calculation of Functions. This he informed us is a new species of calculus, which will require new methods of investigation. But as only the introduction of the paper was read, it is impossible to give any farther account of it.

At the same meeting a paper by Dr. Herschell on the satellites of the Georgium Sidus, with some observations on the space penetrating power of telescopes, were also read. The object of the paper was to furnish data to astronomers to determine the number and orbits and periodical times of the satellites of this very remote planet. He described the orbits and periods of two of the satellites, supposed that another existed within them, and probably three others without them.

On Thursday the 15th June, a paper by Sir Everard Home, Bart. was read, on the mode of generation of the lamprée and myxine. He found by a great many dissections at different periods during the summer, that these animals are all hermaphrodites; those, which were supposed to be males, producing eggs as well as the supposed females.

At the same meeting a paper by Anthony Carlisle, Esq. was read, on the connection between the extravascular and vascular parts of animals. Hair, feathers, nails, hoofs, are extravascular substances, and possess no vessels. The chief object of the paper was to show, that the shells of shell-fish and snails are likewise without vessels. They cannot be injected. Their membranes do not exhibit the same appearance as those that contain vessels. When a piece of snail-shell was broken off, the injury was repaired by a viscid substance applied internally, and then layers of calcareous matter were laid over it.

At the same meeting a paper by John George Children, Esq. was read, on the effects of a very large galvanic battery. It consisted of 20 pair of zinc and copper plates 6 feet long and 2 feet 6 inches

broad, joined together by straps of lead and plunged in a mixture of nitric and sulphuric acids, diluted with from 20 to 40 times their weight of water. By this battery metallic wires were ignited in the following order, beginning with the wire most easily ignited.

Platinum	Copper
Iron	Silver
Gold	Zinc.

Tin and lead are so fusible, that with them the experiment could not be tried. Mr. Children considers the ignitability as the inverse of the conducting power of the metals; therefore platinum conducts worst and zinc best of the above six metals. When the two poles of the battery were connected by two parallel platinum wires of different sizes, the thick wire was ignited and not the fine one; but when the two wires were tied one to the end of the other, the fine wire was ignited first.

Iron wire was slit, some diamond powder put into the slit, and this powder surrounded by iron wire above and below. The wire was faintly ignited. The diamond powder disappeared and the iron was converted into steel and partly fused. This demonstrates the truth of Clouet's original experiment, which was afterwards verified by Sir George Mackenzie. Iridium was fused by the battery and reduced to a porous globule of the specific gravity 18.6. Oxide of tantalum was fused and reduced. The metal was of a yellowish colour and brittle. Oxide of cerium was fused without being reduced. This was the case also with oxide of titanium. Oxide of tungsten was reduced and fused. The metal was grey and very heavy. Oxides of molybdenum and uranium were likewise fused and reduced, and both metals were brittle.

The titles of the following papers were read, in order to entitle them to insertion in the next volume of the Transactions; want of time rendering it impossible to read the papers themselves at full length.

Considerations on the Solution of Bodies in Liquids, by Mr. Daniell.

On the Dispersive Properties of the Air, by Mr. Stephen Lee.

Considerations on the Vascular System of Animals, by Dr. Philips.

The Polar Distances of 30 Circumpolar Stars, by John Pond, Esq. Astronomer Royal.

The Society adjourned during the long vacation,

N.B. In the last number of the *Annals of Philosophy*, the numerical results of several of Mr. Porrett's analyses of Prussic acid and its compounds were inaccurate. The following are the correct numbers, which Mr. Porrett has been so obliging as to communicate.

100 Prussiate of mercury are composed of

Prussic acid.....	13.8
Peroxide of mercury.....	86.2

---

100.0

100 Prussic acid of

Azote .....	40·7
Carbon .....	34·8
Hydrogen .....	24·5
	100·0

Sulphureted chyazic acid is a compound of 4 atoms of sulphur + 1 atom Prussic acid. Ferrureted chyazic acid is a compound of 1 atom black oxide of iron + 4 atoms Prussic acid,

## LINNÆAN SOCIETY.

On Tuesday the 6th of June a paper by Dr. Benjamin Smith Barton was read, giving an account of a singular bird lately observed in the United States of America, which he considers as a new species of *tantalus*.

On Tuesday the 20th of June a paper by Mr. J. Murray was read, containing experiments on the application of vegetable poisons to animals. He laid bare the crural nerve and muscle of the hind leg of a frog, and applying the poisonous juice to the part, tried whether the muscle could be excited by a galvanic battery. Opium destroyed the excitability in 5 minutes; but the addition of citric acid restored it again. Tincture of *digitalis* produced no effect. A considerable number of similar experiments were related.

At the same meeting a paper by Mr. Bicheno was read, describing three native species of *orchis*, hitherto very frequently confounded together.

At the same meeting a Latin paper by Sir Justly Green, Bart. was read, describing 40 species of *phascum*.

The Society adjourned during the long vacation.

## ARTICLE XV.

SCIENTIFIC INTELLIGENCE; AND NOTICES OF SUBJECTS  
CONNECTED WITH SCIENCE.I. *Royal Medical Society, Edinburgh.*

The Royal Medical Society propose, as the subject of their prize essay for the year 1816, the following question:—

“What changes of composition does the process of digestion in quadrupeds produce, on earths, oxides, and earthy, alkaline, and metallic salts?”

A set of books, or a medal, of five guineas value, will be given annually to the author of the best dissertation on an experimental subject proposed by the Society; for which all the members, honorary, extraordinary, and ordinary, shall alone be invited as candidates.

The dissertations are to be written in English, French, or Latin,

and to be delivered to the Secretary on or before the 1st of December of the succeeding year to that in which the subjects are proposed; and the adjudication of the prize will take place in the last week of February following.

To each dissertation shall be prefixed a motto; and this motto is to be written on the outside of a sealed packet, containing the name and address of the author. No dissertation will be received with the author's name affixed; and all dissertations, except the successful one, will be returned, if desired, with the sealed packet unopened.

## II. Native Boracic Acid.

Mr. Smithson Tennant first observed native boracic acid attached to some specimens from Lipari. Dr. Holland afterwards visited this place, and found boracic acid in large quantity within the crater of Volcano, forming a white feathery covering to the sulphur, which is deposited from sublimation in various parts of this great cavity.— (See Holland's Travels in Greece, p. 9.)

## III. Climate of Athens.

It appears from a note in Dr. Holland's Travels, p. 411, that at Athens the thermometer sometimes rises in summer to  $104^{\circ}$ , and that in winter it falls as low as  $28^{\circ}$ . In July the thermometer is frequently above  $90^{\circ}$ . The average quantity of rain that falls is stated at only 21 or 22 inches; I presume French, as the observer, M. Fauvel, was a Frenchman.

## IV. Table of Passengers, Waggons, &c. that cross London Bridge and Blackfriars Bridge in one Day.

The day chosen by the Directors of the Southwark bridge was in July, 1811. A rate is fixed for the purpose of showing the proprietors of the Southwark bridge the probable quantity of money that may be raised on that new bridge:—

	Rate.	London Bridge.			Blackfriars Br.		
		d.	£.	s. d.	£.	s. d.	
Foot passengers .....	1	89,640	373	10 0	61,069	254	8 4
Waggons .....	8	769	25	12 8	533	17	15 4
Carts and drays .....	4	2,924	48	14 8	1,502	25	0 8
Coaches .....	6	1,240	31	0 0	990	24	15 0
Gigs and taxed carts .....	4	485	8	1 8	500	8	6 8
Horses .....	1½	764	4	15 6	822	5	2 9
			491	14 6		335	8 9
Deduct half the amount of waggons, &c. for return			59	2 3		40	10 3
			432	12 3		294	18 6

The transit over Blackfriars bridge is nearly double what it was six years before the above account was taken.



V. *Further Observations on Mr. Lockhart's Imaginary Cube Roots.*

(To Dr. Thomson.)

SIR,

Mr. Lockhart seems to have made a mistake in one of the signs of the root connected with  $t$ : when corrected, his roots will stand thus:

$$\begin{array}{ll} \sqrt[3]{\frac{c}{2} + \sqrt{\frac{c^2}{4} - \frac{b^3}{27}}} & \sqrt[3]{\frac{c}{2} - \sqrt{\frac{c^2}{4} - \frac{b^3}{27}}} \\ \frac{x}{2} + \sqrt{\frac{x^2}{4} - \frac{b}{3}} & \frac{x}{2} - \sqrt{\frac{x^2}{4} - \frac{b}{3}} \\ -\frac{t}{2} - \sqrt{\frac{t^2}{4} - \frac{b}{3}} & -\frac{t}{2} + \sqrt{\frac{t^2}{4} - \frac{b}{3}} \\ -\frac{v}{2} - \sqrt{\frac{v^2}{4} - \frac{b}{3}} & -\frac{v}{2} + \sqrt{\frac{v^2}{4} - \frac{b}{3}} \end{array}$$

But, as Mathematicus justly observes, any quantity "in which the square root enters admits of two values;" the above roots may be more conveniently expressed thus—

$$\begin{array}{l} \sqrt[3]{\frac{c}{2} \pm \sqrt{\frac{c^2}{4} - \frac{b^3}{27}}} \\ \frac{x}{2} \pm \sqrt{\frac{x^2}{4} - \frac{b}{3}} \\ -\frac{t}{2} \mp \sqrt{\frac{t^2}{4} - \frac{b}{3}} \\ -\frac{v}{2} \mp \sqrt{\frac{v^2}{4} - \frac{b}{3}} \end{array}$$

In which formula, if the upper sign be used in the first, the upper sign must likewise be used in each of the roots, and the contrary. It may be proper, before I make any further observations, to point out the part of Mr. L.'s demonstration where the error appears to

have originated. In extracting the square root of  $\frac{b^2 t^2}{4} - \frac{b t^4}{2} + \frac{t^6}{4} - \frac{b^3}{27}$  he has overlooked the ambiguity of the quantity

$$\pm \left( t^2 - \frac{b}{3} \right); \text{ for } \sqrt{\frac{b^2 t^2}{4} - \frac{b t^4}{2} + \frac{t^6}{4} - \frac{b^3}{27}} =$$

$$\sqrt{\left( \frac{b^2}{9} - \frac{2 b t^2}{3} + t^4 \right) \times \left( \frac{t^2}{4} - \frac{b}{3} \right)} = \pm \left( \frac{b}{3} - t^2 \right) \times$$

$$\sqrt{\frac{t^2}{4} - \frac{b}{3}}. \text{ But as the quantity originally squared was } + \frac{b - t^2}{2} \cdot t,$$

and not  $-\frac{b-t^2}{2} \cdot t$ , it would therefore be improper, in the present case, to use the sign  $-$ , and consequently Mr. L.'s equation should have been  $+\left(\frac{b}{3} - t^2\right) \cdot \sqrt{\frac{t^2}{4} - \frac{b}{3}} = \sqrt{\frac{c^2}{4} - \frac{b^3}{27}}$ , or its equal  $-(t^2 - \frac{b}{3}) \cdot \sqrt{\frac{t^2}{4} - \frac{b}{3}} = \sqrt{\frac{c^2}{4} - \frac{b^3}{27}}$ : and then by proceeding as he has done we obtain  $-\frac{t}{2} - \sqrt{\frac{t^2}{4} - \frac{b}{3}} = \sqrt[3]{\frac{c}{2}} - \sqrt{\frac{c^2}{4} - \frac{b^3}{27}}$ , the same as the root given above. But

it ought not to be forgotten that Mr. L., notwithstanding the above oversight, has the merit of being the first who has pointed out the method of finding the cube roots of a *binomial*, by means of the three roots of the cubic equation with which that binomial is connected.

If we take the equation employed by Mr. L., viz.  $x^3 - 24x = 72$ , where  $x = 6$ ,  $t = 3 + \sqrt{-3}$  and  $v = 3 - \sqrt{-3}$ , the binomial and roots will be as follows:  $\sqrt[3]{36 \pm \sqrt{784}} = \sqrt[3]{64} \sqrt[3]{8}$ , according as the upper or under sign is used.

$$\text{First root} = \frac{6}{2} \pm \sqrt{\frac{6^2}{4} - \frac{24}{3}} = 3 \pm 1 = 4 \text{ or } 2.$$

$$\begin{aligned} \text{Second root} &= -\left(\frac{3 + \sqrt{-3}}{2}\right) \mp \sqrt{-\left(\frac{13}{2} - \frac{3}{2}\sqrt{-3}\right)} \\ &= -\left(\frac{3 + \sqrt{-3}}{2}\right) \mp \left(\frac{1 + 3\sqrt{-3}}{2}\right) = -(2 + 2\sqrt{-3}) \text{ or} \\ &-(1 - \sqrt{-3}). \end{aligned}$$

$$\begin{aligned} \text{Third root} &= -\left(\frac{3 - \sqrt{-3}}{2}\right) \mp \sqrt{-\left(\frac{13}{2} + \frac{3}{2}\sqrt{-3}\right)} \\ &= -\left(\frac{3 - \sqrt{-3}}{2}\right) \mp \left(\frac{1 - 3\sqrt{-3}}{2}\right) = -(2 - 2\sqrt{-3}) \text{ or} \\ &-(1 + \sqrt{-3}). \end{aligned}$$

So that when the upper signs are used, we obtain the cube roots of 64; but when we use the under ones, the results are the cube roots of 8. Hence it appears that N. R. D. was not "too positive" when he said, "it is *not* the cube root of 64, but of 8;" for he used the sign given by Mr. L., and then the quantity is a cube root of 8, as appears from the above. The reason why Dr.

Tiarks made it a cube root of 64, was his using  $-\left(\frac{3 + \sqrt{-3}}{2}\right) + \left(-\sqrt{-\left(\frac{13}{2} - \frac{3}{2}\sqrt{-3}\right)}\right)$ , instead of the quantity given

by Mr. L., viz.  $-\left(\frac{3 + \sqrt{-3}}{2}\right) + \left(\sqrt{-\left(\frac{13}{2} - \frac{3}{2}\sqrt{-3}\right)}\right)$

As the above six different quantities are, if I mistake not, *all* the different values of which the three formulæ for the roots admit, it follows that they give *all* the cube roots of both 64 and 8, which were before known, and *no more*. It may likewise be observed, that  $x = \sqrt[3]{36 \pm \sqrt{784}}$ , being an equation of six dimensions, ought, according to the received opinion, to have six different roots; but it has been shown above that it has just six roots, and no more: this therefore agrees exactly with that opinion.

When Mr. Lockhart speaks of binomials in their vanishing state having "functions and connections widely different from those deduced from binomials which are evanescent," I am not certain that I understand him perfectly: if he mean to tell us that  $\sqrt[3]{64 - \sqrt{4096 - 4096}}$  is not universally equal to  $\sqrt[3]{36 + \sqrt{784}}$ , I perfectly agree with him; for the former is equal to  $\sqrt[3]{64} \mp 0$ , and the latter to either  $\sqrt[3]{64}$  or  $\sqrt[3]{8}$ ; the one being an equation of three dimensions, and the other of six. Neither do I clearly comprehend what he means, when he speaks about the roots of equations being preserved in some cases, and extinct in others.

I am, Sir, your obedient servant,

Newcastle-upon-Tyne, June 16, 1815.

HENRY ATKINSON.

### VI. Sale of Minerals.

We are informed that the extensive and valuable collection of minerals of the Rev. R. Hennah, late of St. Austell, in Cornwall, and which is now in the possession of his son, the Rev. R. Hennah, of Plymouth, consisting of nearly 2000 specimens of the most rare and curious productions of that county, particularly of tins, is to be disposed of.

### VII. Newcastle Collieries.

The Literary and Philosophical Society of Newcastle-upon-Tyne is engaged in the publication of two tracts on the means of establishing authentic records relative to the state of the collieries in that neighbourhood, and to other points which promise to be both of local and national importance. We have no doubt that much curious and valuable information will result from the labours of this Society, which include nearly all the well-informed men of Newcastle and its neighbourhood.

### VIII. Size of the Whale.

In a paper on the whale by Mr. Scoresby, printed in the first number of the *Annals of Philosophy*, that Gentleman says, that he never heard of one longer than 70 feet; and that out of 200, which

he had himself taken, not one measured 65 feet in length. In the North Pacific, however, the size is often much larger than this; for Capt. Clarke measured the skeleton of one near Columbia river, and found it 105 feet in length. (See Travels to the Source of the Missouri, &c. by Captains Lewis and Clarke, p. 422.)

### IX. *Inhabitants in Ancient Rome.*

In ancient Rome the number of *insulæ*, or houses, standing separately, was 46,000 in the time of Trajan. The *domus* (probably the principal buildings or palaces of Rome), 1800. The houses of Rome were usually four stories high. If we suppose, with Gibbon, that each story lodged a family of six persons, each of the *insulæ* would contain 24 inhabitants. This would give us the whole inhabitants of Rome at 1,118,448; so that the population of ancient Rome, when greatest, exceeded the present population of London by about 60,000. (See Gibbon's Posthumous Works, v. 318.)

### X. *Extract of a Letter from M. Van Mons, of Brussels.*

I take this opportunity of sending you some curious information which I have just learned by a letter from the discoverer.

If indigo in powder be thrown upon red hot charcoal or iron, a fine violet coloured vapour rises, which Brugnatelli at first took for iodine. This vapour when condensed crystallizes in four-sided prisms very brilliant and of a fine violet colour. To this substance Brugnatelli gives the name of *indigogen*, because when united to the fecula of the plant it forms indigo.\* He considers it as a metal, because if mercury be exposed to its vapour a combination takes place, which is hard or soft according to the proportion of the indigogen, and which possesses the properties of an amalgam. Indigo deprived of this substance loses the property of acquiring a cupreous lustre by friction. The new substance is found in every variety of indigo.

Brugnatelli has observed that ice when rasped becomes positively electric. This confirms the notion that its conducting power follows immediately that of the metals. Pure water, or water exempt from all salt, is almost a non-conductor. Brugnatelli was unable to construct a galvanic battery by uniting ice with any metal which he tried.

Zamboni at present draws strong sparks, and gives shocks with the dry galvanic column. But I venture to predict, that it will never be able to produce chemical effects, where an abstraction of electricity is requisite. The charge may circulate without water, but cannot be renewed.

Volta has just obtained electric fluorine in considerable quantity. Configliachi is the editor of it.†

Gay-Lussac believes that euchlorine or your oxide of chlorine

\* It has been known to chemists for many years. T.

† I do not understand the meaning of the sentence. The original is *Configliachi en est l'editeur.*

contains only the 5th part of the oxygen of chloric acid, such as it exists in the detonating chlorates; that is to say, twice the oxygen which we suppose to exist in oxymuriatic gas; being capable of saturating only twice as much hydrogen as that gas, while chloric acid saturates six times as much. Euchlorine would result from an oxide dissolved in muriatic acid gas, of which the chlorine would take the oxygen in place of the hydrogen, which would be converted into water, the metal being reduced. It is obvious that this acid cannot be formed except when the oxygen is separated by means of muriatic acid, three quantities taking oxygen for six quantities in exchange for water, represented by a half quantity of this principle; or two quantities of acid taking four quantities of oxygen from one quantity of this remaining with a quantity of acid in the salt. But when separated by the simple acid, a great deal of acid must be necessary to render the whole salt simple, or what you long before others called *chloride of potassium*, in place of which the term *chloruret* has been introduced, a name which does not express that chlorine, as it is called, is the vicegerent of oxygen; and this cannot be the case in the process of Davy, in which very little acid is employed. And Davy does not say that the euchloric acid was mixed with oxygen, nor that the salt remaining was six times or three times oxygenated. Besides the acid characters of euchlorine, and the way in which it is decomposed, do not permit us to adopt the calculation as accurate. M. Gay Lussac obtained liquid superoxygenated muriatic acid by employing weak sulphuric acid and hyperoxymuriate mixed with a little simple muriate, by means of the acid of what the decomposition begins, for hyperoxygenated chlorine united to sulphuric acid is a compound analogous to that which Davy formed with hyperoxygenated iodine. Gay-Lussac likewise obtained this compound, and considered it as a pure euiodine, which has not yet been exhibited in a separate state. Muriatic and iodic acids resemble fluoric acid, which combines with sulphuric acid and oxygen, in which water is supercombined.

My advice has been at last followed, in decomposing the euchlorates and euiodates, namely, to put a little acid or simple salt along with the mixture. The simple acid becomes oxygenated, and then euacid, which is immediately separated by or engaged with the sulphuric acid, unless we wish that both the sulphate and the simple salt and the oxygenated salt should be immediately decomposed. To explain according to the new views the formation of acids merely bisoxygenated, we must make a great many gratuitous suppositions of decompositions and combinations of the simple acids of these bodies. Besides, if it be true that iodino-chlorine allows oxygen to escape when heated, the question may be considered as decided.

I know at present that when a dry fluuate is decomposed by a metal, we can only remove one half of the acid; the metallic fluoride combines with the base thus reduced to the state of a subfluoride. Water separates the metallic fluoride from the fluuate, provided the

base of this salt is not soluble, or together with this base if it be soluble, and then under the form of a metallo-fluoret with an oxide, a body analogous to the sulphurets and phosphurets of the same substance.\*

J. B. VAN MONS.

### XI. *Death of George Montague, Esq.*

This celebrated British zoologist who had attained the 76th year of his age; but was still healthy and vigorous, and actively employed in his favourite pursuits, about a fortnight ago wounded his foot with a nail, which rendered him lame. He was at length seized with locked jaw and all its concomitant horrors, and died in the course of the following day. In him Britain loses a zealous and successful zoologist. His works are well known and highly valued by naturalists in general.

### XII. *School of Athens.*

Most of my readers are probably aware, that for some time past the Greeks have displayed a considerable desire to put themselves on a footing, in point of knowledge, with the other nations of Europe. Schools have been erected in different parts of the country, books have been translated from the Italian, the French, the German and the English, several original Greek works have appeared, Greek newspapers have been regularly published for some years past, and even a Greek periodical work is edited at Vienna. Athens, formerly the seat of science and of the arts, is still a considerable city, inhabited chiefly by Greeks. The inhabitants enjoy a greater degree of liberty and are distinguished by a greater degree of sprightliness, intrigue, and wit, than are to be found in the other cities of Greece. Formerly there existed a school in Athens supported by a sum of money which a charitable Athenian had lodged in the bank of Venice. But when this bank was destroyed by the conquest of Venice by Bonaparte, the income of course was at an end, and this obliged the inhabitants of Athens to shut up their school. About six years ago Dr. Rhasis being travelling through Greece, was affected even to tears when he observed the state of Athens, reduced to subjection and even deprived of a school. He summoned a meeting of the principal inhabitants, and after they had concerted the means of re-establishing the school, he accepted the title of *Ephorus*, or principal director of it, which the inhabitants offered him. On his return to Constantinople he consolidated the school by the privileges which he obtained from the government and the patriarch, and at present the school of Athens flourishes under his inspection. The following is an extract of a letter from Mr. John Polama, Professor of the school, dated the 27th May 1814, in which he gives an account to Dr. Rhasis of the solemn distribution of the prizes. It is published in the *Ἐπεὶς ὁ Λογίος* (the Literary

\* The account of Gay-Lussac's opinions respecting the combination of chlorine and oxygen in this letter is very obscure to me, probably from not understanding the nomenclature of Van Mons. I have translated it therefore as literally as possible. T.



Mercury) a periodical Greek work edited at Vienna by Anthimos Gazy.

“I have opened,” says he, “a literary concourse, and collected in the school the inhabitants of the first and second class, to hear the reading of different pieces in prose and verse, composed by the pupils in ancient and modern Greek. The applauses were unanimous, not only of the Greeks but of the French and English who assisted at the meeting, and who were loud in their praises of the scholars and of the professor who had directed them. The successful pupils were rewarded by the Society of the *Philomuses*,\* which has been just formed, some with gold or silver rings, each according to his merit, some with money. The poor children were even supplied with clothes.”

A Greek college has even been lately established at Melios by Anthimos Gazy. A school existed already in the same place, but it has been greatly enlarged, and the number of professors or teachers increased.

### XIII. *Werner's Collection of Minerals.*

Werner has disposed of his invaluable collection of minerals to the Academy of Mines at Freyberg. It was valued by the Saxon Government at 56,000 dollars; but Werner declared that in the present impoverished state of his country so great a sum ought not to be taken, and therefore most patriotically reduced the price to 40,000 dollars. He parted with his collection to the Academy under the following conditions: 1. That he should receive immediately the sum of 7,000 dollars. 2. That he should receive during his life the interest of 33,000 dollars, at the rate of five per cent. 3. That at his death the capital of 33,000 dollars should fall to the funds of the Academy.

---

## ARTICLE XVI.

### *Scientific Books in hand, or in the Press.*

In consequence of the numerous important discoveries that are daily making by Berzelius and others in the science of chemistry, Mr. W. Henley is induced to delay his promised series of Chemical Tables some time longer, in order to render them as perfect as possible; particularly as the composition of many of the vegetable bodies is not at present correctly determined.

Dr. Henry, of Manchester, is preparing for the press a new edition of his Elements of Chemistry.

Mr. Huish's Practical Treatise on Bees will be ready for publication in a few days.

The new edition of Dr. Hutton's Philosophical Dictionary is nearly ready for publication.

The Eighth Volume of Shaw's Zoology, under the superintendance of Dr. Leach, is in considerable forwardness.

\* The object of this Society is to furnish the funds necessary for the propagation of learning in Greece, for the publication of classical works, for supporting indigent young persons educated to the sciences, and for researches into antiquity of every kind.

ARTICLE XVII.  
METEOROLOGICAL TABLE.

1815.	Wind.	BAROMETER.			THERMOMETER.			Evap.	Rain.
		Max.	Min.	Med.	Max.	Min.	Med.		
5th Mo.									
May 1	E	29·67	29·65	29·660	67	50	58·5		—
2	S E	29·72	29·70	29·710	71	47	59·0		·13
3	N E	29·70	29·68	29·690	73	47	60·0		
4	N E	29·67	29·65	29·660	67	44	55·5		3
5		29·69	29·65	29·670	67	48	57·5		4
6	S	29·70	29·66	29·680	68	49	58·5		2
7	S	29·70	29·67	29·685	69	49	59·0		5
8	S W	29·81	29·67	29·740	70	47	58·5	·61	
9	W	29·80	29·79	29·795	69	49	59·0		5
10	S W	29·85	29·79	29·820	70	51	60·5		
11	S W	29·79	29·51	29·650	73	51	62·0		5
12	S W	29·66	29·64	29·650	67	47	57·0		4
13	S V	29·65	29·55	29·600	67	43	55·0		·19
14	S W	29·81	29·77	29·790	66	45	55·5		6
15	S	29·90	29·72	29·760	69	41	55·0		·13
16	Var.	30·23	29·90	30·065	70	40	55·0	·52	
17	W	30·23	30·19	30·210	71	56	63·5		
18	N W	30·19	30·10	30·145	76	50	63·0		
19	W	30·10	29·78	29·940	77	48	62·5		
20	N W	29·78	29·51	29·645	76	43	59·5		
21	N W	29·77	29·51	29·640	65	42	53·5		2
22	W	29·88	29·85	29·865	61	34	47·5	·45	
23	S W	29·85	29·67	29·760	61	44	52·5		·20
24	S W	29·97	29·72	29·845	66	48	57·0		—
25	N W	30·12	29·97	30·045	71	51	61·0		
26	N W	30·12	30·10	30·110	80	47	63·5		
27	N E	30·10	29·89	29·995	73	52	62·5		
28	N E	29·89	29·80	29·845	78	58	68·0		—
29	Var.	29·85	29·80	29·825	69	50	59·5		9
30	Var.	29·90	29·85	29·875	68	49	58·5	·50	
		30·23	29·51	29·812	80	34	58·58	2·08	1·10

The observations in each line of the table apply to a period of twenty-four hours, beginning at 9 A. M. on the day indicated in the first column. A dash denotes, that the result is included in the next following observation.

## REMARKS.

*Fifth Month.*—1. Dew this morning: a very fine day: lightning at night far in the S. 2. Dew, with rudiments of thunder clouds, which in increasing became very beautiful: a storm was within hearing the whole mid-day, to S. and S. W.: p. m. a heavy shower mixed with large hail, followed by lightning in the S. E. 3. A strong breeze: thunder clouds, which dispersed in the evening. 4. *Cumulostratus*: some showers, followed by *Cirrostratus*. 5. Much dew: clear morning, succeeded by *Cumulus*, &c.: thunder to the S.: a shower in the evening. 6. Dew in large drops: somewhat misty and overcast: a shower in the night. 7. Windy: dripping at eve. 9. *Cumulostratus*: a few drops by inosculation at sun-set: rain in the night. 10. Windy: driving clouds. 11. Dew: windy, a. m. at S. E. with large *Cirri*, and below them *Cirrocumulus*, variable and beautiful: p. m. the *Cumulus* was added, with *Cirrostratus* in the region of its base: at sun-set a storm in S. W., which about nine passed us to N. E: the lightning in violet coloured sheets, with delicate white branched streaks on them: the thunder moderate, rolling out to a great length. 12. Much wind: slight showers, a. m.: clouds and haze at sun-set. 13. Wind and rain: at half-past six p. m., during a heavy shower which passed to the E., there was a perfect double rainbow, on which I repeated an observation already recorded in this register, under Fifth Month, 4, 1813. The contrast of the space, included between the two bows, with the tint of the remainder of the cloud, was on the present occasion very striking. 14. Fair and warm: a shower, p. m. with a bow: *Cirrostratus*. 15. Hollow wind at S. with an overcast sky: wet evening. 16. *Cumulostratus*: wind, p. m. N. W. a milky luminous twilight: much dew. 17. Somewhat misty morning: p. m. *Cirrostrati* advancing from the N. overspread the sky, without any other cloud. 18. a. m. Windy at N., and overcast with *Cumulostratus*: clear and calm, p. m.: red sun-set. 19. A very fine day: the twilight luminous, and somewhat ruby-coloured, followed by *Cirrostratus*. 20. Windy: various clouds: the sky purplish round the moon at night. 21. a. m. Brisk N. W. wind: showers. 23. Showers. 28. A brisk wind at S. E.: *Cirrus*, followed by *Cirrostratus*: *Nimbi* in the S. at sun-set: rain by ten at night. 29. Some thunder: rainy afternoon.

## RESULTS.

Winds Westerly, with a small portion of Easterly at the beginning and end of the period.

Barometer: Greatest height.....	30·23 inches.
Least .....	29·51
Mean of the period .....	29·812
Thermometer: Greatest height.....	80°
Least .....	34
Mean of the period.....	58·58
Evaporation, 2·08 inches.	Rain, 1·10 inch.

From the 6th to the 22d inclusive, I made observations on the temperature with an additional Six's thermometer, placed in a position nearly horizontal exposed to the sun on a grass plat, 20 yards distant from the standard one (which is near the house), and about ten feet lower than the latter. This second thermometer indicated, with two exceptions, a higher temperature for the day; the difference in one case being 10°, and the mean difference 4°: it indicated, uniformly, a lower temperature for the night, the greatest difference being 6°, the mean difference 4·9°: but the total mean of the observations differed, as I anticipated, very little, the upper thermometer giving 57·5°, the lower 57·1°.

ANNALS  
OF  
PHILOSOPHY.

---

---

AUGUST, 1815.

---

---

ARTICLE I.

*Some Account of the late Smithson Tennant, Esq.*

*(Continued from p. 11.)*

THAT desire of visiting remote countries, of viewing the productions of Nature in more favoured climates, and of observing the practical effects of different systems of laws and government, which is common to every man of talents and curiosity, was felt with peculiar force by Mr. Tennant, and may be considered as one of his ruling passions. He was therefore much disposed, after he had relinquished the intention of medical practice, to indulge this inclination, and to travel in those parts of Europe which he had not already visited. But the war with France opposed many obstacles to continental excursions; and the uncommon sufferings which he experienced from sea sickness, deterred him from forming any project in which a sea voyage of any considerable length was to be undertaken. He often regretted that this unfortunate peculiarity of his constitution prevented him from seeing the United States of America; and he abandoned, but with considerable reluctance, those schemes of travelling in distant countries, to which, at this particular period of his life, he would otherwise have been strongly inclined.

But although he was thus prevented from indulging in a favourite taste, his situation at this period was in many respects one of the most enviable in which a man of science could be placed. He was independent in his circumstances; and being free from all professional avocations, enjoyed the entire command of his own time. His residence in the metropolis gave him easy access to whatever was new and valuable in science and literature, as well as the means

of constant intercourse with several of his most intimate friends, who were more or less interested in his own particular pursuits, and with whom he could freely communicate relative to the various subjects upon which he was continually employed. His philosophical reputation was established; his talents were fully acknowledged; and he was beginning to be known and valued in a distinguished circle of society for the extent and originality of his knowledge, and his extraordinary powers of entertainment and information.

Something, however, was still wanting to his happiness; for though his time was agreeably and usefully filled up, he was without any regular occupation or definitive object of pursuit; and his studies, however interesting, were too desultory to fix his attention, or take a sufficiently permanent hold on his thoughts. The composition of some literary or scientific work (of which at different periods of his life he had several vague and floating projects) would have been the natural resource and occupation of such a mind. But although Mr. Tennant was capable of great efforts on a sudden emergency or for a particular purpose, he had his full share of that indecision, and fastidiousness of taste which belong to the temperament of genius; and which seldom fail, unless counteracted by early habits of self controul, to disqualify the possessor for those long continued, and persevering exertions, so indispensable to great literary undertakings. This defect of resolution, originating in part from his extraordinary powers, was lamented by all his particular friends, but by no one more feelingly than by Mr. Tennant himself. It increased with his increasing years; and the evil was now aggravated by an unfortunate alteration in the state of his health, which was beginning gradually to decline, and to require continual attention.

It was owing principally to these causes that, within a very few years after he had relinquished the study of medicine, he became insensibly disposed to some new occupation; and one of those accidents upon which the fortunes of human life depend, determined him to engage in agricultural pursuits. He had for some time been accustomed to take long journies for the sake of his health; during one of which he happened to pay a visit to a friend in Lincolnshire, who had been much connected with his family, but with whom he was not in habits of regular intercourse. This was about the year 1797, at an early period of those great advances in agriculture, since become very general, by which that part of the kingdom has been so much distinguished. His friend's residence was in an extensive tract of country, very favourable for such improvements, adjoining to the river Trent, and known by the name of the Isle of Axholme, where very considerable enclosures had lately taken place. A great spirit of enterprize had, in consequence, been excited; and the cultivation of new land (principally by the growth of rape seed) was carried on to a great extent, and with extraordinary vigour and success. There was nothing in the previous habits of Mr. Tennant's life which had particularly led him to the study or practice of agri-

culture; but the sight of these great improvements afforded much gratification to his feelings, and was highly interesting to his curiosity. His attention was very naturally directed to the system of cultivation itself; and the knowledge and experience of his Lincolnshire friend, who had himself practised the new husbandry with great intelligence and success, afforded him the best means of information relative to the whole of this subject. Under the influence of his example and advice, and after having satisfied himself that the speculation afforded a reasonable prospect of advantage, Mr. Tennant shortly afterwards purchased several allotments of unenclosed land in that neighbourhood, and began to cultivate them on his own account, entrusting the chief management of the concern to the skill and judgment of his friend. At subsequent periods he purchased other allotments, and made considerable additions to this property.

From the time of making his first purchase in Lincolnshire, Mr. Tennant paid great attention to the study of rural economy; and his attachment to this new pursuit gradually increasing, he became desirous of engaging in some agricultural concern upon a more extensive scale. It was with this intention that about the year 1798 or 1799 he purchased a considerable tract of waste land, newly allotted under an Enclosure Act, on the Mendip hills in Somersetshire. The purchase was originally made in conjunction with a particular friend, who for some time resided on the spot, and personally superintended the concern. But a partition of the estate afterwards taking place, a portion of land was assigned to Mr. Tennant, situated near the well-known village of Cheddar, which was retained by him in his own hands, and became the principal scene of his farming operations. Here he built a small house, at which, during the remainder of his life, he passed some months every summer, besides occasional visits at other times of the year.

London, however, still continued to be the principal place of his residence; since his passion for agriculture, however strong, had in no respect diminished his high relish for the pleasures of cultivated society, and for the interesting objects continually afforded by the metropolis. It must be obvious, however, that these latter tastes must have interfered very considerably with the due management of his farming concerns. Such undertakings, in order to be profitable, require for the most part strict personal inspection, and a constant attention to minute details. This sort of vigilance it was impossible for Mr. Tennant to exert; but he kept up a constant correspondence with his agents in the country, receiving from them such information, and transmitting such instructions, as could be communicated by letters. For a certain period (as it was reasonable to expect), owing partly to his own inexperience, and partly to unfavourable seasons, and other accidents, his speculations were not prosperous; and he occasionally suffered some anxiety and disappointment. But in process of time he acquired more practice and information, and became insensibly habituated to many trifling

vexations, which at first had given him uneasiness. The prospect gradually brightened; and during the latter part of his life his concerns were brought into better order, and appear to have been attended with a reasonable degree of success.

But whether these agricultural undertakings were profitable or not, they doubtless contributed in several important respects to his comfort and happiness. They were conducive to his health, by affording additional motives for exercise in the open air, and for those long journies on horseback which his constitution required, and which were thus rendered less irksome. They furnished his mind with a perpetual supply of that steady, equable occupation, which forms so essential an ingredient in human happiness, but which possibly he would not have provided for himself from any other source. What was scarcely less important, these pursuits were the accidental occasion of his reviving a connection with one of his early friends, formed originally at Cambridge, but which distance of place and other circumstances had interrupted for many years. The intercourse between them was renewed soon after Mr. Tennant became established at the Somersetshire farm, which was not far from his friend's residence; and it was productive of great happiness to both parties. Mr. Tennant found in his friend's family those congenial tastes and opinions, which form the strongest bond of union; and during the remainder of his life he invariably experienced from them all that affectionate regard, which the greatest personal esteem, united with a sincere admiration of his talents, could inspire. With these friends, whenever he had leisure and inclination, he found a constant home; and it is highly probable that some of his happiest hours were passed in their hospitable mansion.

The change in his habits, occasioned by his agricultural engagements, was not equally favourable to his scientific pursuits. His spirits were often exhausted, and his mind fatigued and oppressed, by the attention which he thought it necessary to bestow upon the correspondence with his agents, the examination of his farming accounts, and other details equally tedious and minute; and it is impossible to reflect upon the time thus consumed, without lamenting that it was not employed for purposes more beneficial to mankind, and more worthy of his genius and understanding.

It appears, however, from various notes and memoranda which are found among his papers, that from the time when he first became engaged in agricultural pursuits, he was very industrious in procuring information from the best works upon farming, and that he made various practical remarks during his journies, and collected many accurate and circumstantial details relative to the modes of cultivation adopted in different parts of England. In the course of these inquiries, he had discovered that there were two kinds of limestone known in the midland counties of England, one of which differed from common lime-stone in yielding a lime injurious to vegetation. He explained the cause of this difference in a paper



communicated to the Royal Society in the year 1799; shewing that carbonate of magnesia is an ingredient in the latter species of lime-stone, which he describes as an extensive stratum in the midland counties, and as being found also in many other situations, particularly among the primitive marbles, under the name of Dolomite. He gives the proportions in which lime and magnesia exist in many specimens of this lime-stone, and infers from its slow solution in acids, and from its crystalline structure, that it is rather the result of chemical combination than of a casual mixture of the two earths. This conjecture has since been verified by the goniometrical researches of Dr. Wollaston, and by the near agreement of Mr. Tennant's analysis with the constitution of the mineral as inferred from the law of definite proportions.

Mr. Tennant had found that grain will scarcely germinate, and soon perishes, in moistened and perfectly mild carbonate of magnesia; and that the injurious effects of the magnesia in agriculture do not depend on its property of long remaining caustic, but probably on some inherent quality of the earth itself. He also made many experiments on the germination and growth of various seeds and plants in different mixtures of the simple earths; and transporting portions of soil, either from his own estates, or from different parts of England, to the neighbourhood of London, he tried on a small scale the effects of various manures in promoting the growth of different vegetables, and endeavoured in this way to obtain hints for improved modes of cultivation.

In the year 1802 he communicated to the Royal Society his chemical examination of Emery, which had hitherto been considered as an ore of iron. He showed that it consists principally of alumina, and that it nearly agrees with the Corundum of China, which had been analyzed a short time before by Klaproth.

In the month of July during the same year, in endeavouring to make an alloy of lead with the powder which remains after treating crude platina with aqua regia, he observed remarkable properties in the powder, and found that it contained a new metal. But while he was engaged in pursuing this investigation, the attention of two French chemists was accidentally directed to the same object. In the autumn of 1803 M. Descotils had discovered that the powder contains a metal which gives a red colour to the ammoniacal precipitate of platina; and M. Vauquelin having treated the powder with alkali, obtained from it a volatile oxide, which he considered as belonging to the same metal.

In the spring of the year 1804. Mr. Tennant having completed the course of his experiments, communicated the results to the Royal Society. He shewed that the powder consisted of two new metals, to which he gave the names of Iridium and Osmium, and that these might be separated from one another by the alternate action of heated alkali and of acid menstrua. By crystallization from the acid solution, he obtained a pure salt of iridium, from

which he determined with accuracy the real properties of the metal and of its compounds; and from a comparison with these he ascertained that the volatile oxide belonged to another metal (osmium), which he also obtained in a state of purity.

The analysis of crude platina presented, perhaps, some of the greatest difficulties with which chemistry had ever yet ventured to contend. Besides affording traces of several of the known metals, the ore contained, in very minute quantities, four new metallic elementary bodies, whose existence was previously unsuspected, and whose respective characters were to be distinguished before the separate nature of the bodies could be ascertained. Dr. Wollaston and Mr. Tennant, who were employed upon this ore at the same time, and whose habits of friendly intercourse led them to communicate freely with each other during the progress of their experiments, gave proofs of their great sagacity by completely solving this problem; Mr. Tennant in the manner already described, and his friend by the discovery of the two metals called Palladium and Rhodium.

On the 30th of November, 1804, Mr. Tennant had the honour of receiving the Copley medal, which was conferred on him by the Royal Society for his various Chemical Discoveries.



About the year 1805 and 1806 Mr. Tennant made two journies during successive summers into Ireland; going and returning on both occasions by Scotland, in order to abridge as much as possible the sufferings attendant on a sea voyage. In the course of these journies he visited most parts of Ireland which possess any attraction for a traveller, and had the advantage of viewing the Giant's Causeway, in company with Dr. Wollaston, whom he met by a fortunate accident in the north of Ireland during one of these tours.

His attention, however, was not confined to scientific objects; for he made many remarks on the agriculture, manufactures, and general state of Ireland. He was particularly struck with the vast population of the country, compared with that of Scotland, through which he had lately passed, and even with the average population of England. The backward state of its improvement and cultivation, considering its various resources, and the natural fertility of the soil, presented other objects of contrast, which could not fail to interest him. His attention was naturally led to the causes of this inferiority; but to enter into his opinions on this important subject, would require a wider field of discussion than is consistent with the limits of the present narrative. One observation, however, selected from many others, which is strongly marked with his characteristic liberality and good sense, may perhaps deserve to be mentioned. His curiosity had led him to inquire into the state of education among the lower Irish Catholics, and he was much struck

with the narrow and illiberal cast of most of their books of popular instruction. This, which he justly considered as a serious evil, he attributed in a great degree to a sort of party spirit in the Catholic clergy, which arises from the unfortunate alienation subsisting between them and the Government. He observed, that if proper means were taken to conciliate this body, they would gradually relax from their strictness, and become better informed and more enlightened; and that thus, without the formality of conversion, the great mass of their followers might perhaps, by little and little, imbibe a portion of the spirit of protestantism, and be brought to partake of the knowledge and improvements of the age.

In one of the journies to Ireland, which has given occasion to these remarks, Mr. Tennant was accompanied by Mr. Browne, the celebrated African traveller, with whom he had lived for some time in habits of great intimacy. As Mr. Browne, although not much personally known, was remarkable on several accounts, and a man of considerable merit, it may not be improper to describe shortly the nature and origin of this connection; which will also afford an opportunity of throwing a new light upon Mr. Tennant's character, and placing it in a particular point of view, in which it has not yet been considered.

Mr. Tennant was one of the most determined advocates of civilized life, in opposition to those sentimental theories, which extol simplicity, and undervalue the advantages of a refined and cultivated age. The decided superiority of the latter was one of his favourite topics of conversation; and he would often dwell with particular pleasure upon the spirit of improvement displayed in our own times, and the energy and intelligent activity of modern Europe, which he was fond of contrasting with the apathy and torpor of the East. Yet by one of those inconsistencies, from which no human understanding is entirely exempt, he took a singular interest and delight in all accounts of Oriental nations, and in the peculiarities and details of their characters, habits, and institutions. The historical recollections and images of ancient renown which are associated with those remote countries, the entire difference of manners and religions, and the dignified gravity and imposing exterior of the present inhabitants, amused and gratified his imagination. He was a considerable purchaser and collector of books and engravings relative to the East; and had perused with great eagerness and curiosity all the numerous publications respecting Turkey, Egypt, and Persia, which have appeared during the last twenty years. He was also familiarly acquainted with the principal Eastern travellers of former times; among whom Chardin, Norden, Russell, and Shaw, were those whom he particularly valued. His knowledge of the countries described by these writers was remarkably accurate and minute, and extended in many cases even to geographical details.

With the tastes and feelings resulting from this turn of mind, it may easily be conceived that Mr. Tennant had a peculiar gratifica-

tion in the society of Mr. Browne. He found in that distinguished traveller, not only an intimate acquaintance with those countries which so much interested his curiosity, but a considerable fund of learning and information, united with great modesty and simplicity, and with much kindness of disposition. By strangers, however, Mr. Browne's character was apt to be misunderstood. Whether from natural temperament, or from habits acquired in the East, he was unusually grave and silent, and his manners in general society were extremely cold and repulsive. Even in company with Mr. Tennant, to whom he became sincerely attached, he would often remain for some time gloomy and thoughtful. But after indulging himself with his pipe, his eye brightened, his countenance became animated, and he described in a lively and picturesque manner the interesting scenes in which he had been engaged, and to which he again looked forward. Of the impression left on Mr. Tennant's mind by these interviews, some idea may be formed from the following passage of a letter written by him to an intimate friend soon after he had received the account of Mr. Browne's death. "I recall," he says, "the *Noctes Arabicæ* which I have often passed with him at the Adelphi, where I used to go whenever I found myself gloomy or solitary; and so agreeable to me were these soothing, romantic evening conversations, that after ringing his bell, I used to wait with some anxiety, fearful that he might not be at home."

In the autumn of 1812, some years after his journey to Ireland with Mr. Tennant, Mr. Browne took his departure from England on an expedition which he had long projected, to the unexplored Tartar city of Samarcand. He first visited Constantinople; and at the instigation of Mr. Tennant made a diligent, but fruitless, search for the meteoric stone, which is mentioned to have fallen at Egos-potamos in the Parian Chronicle and in Pliny. From Constantinople he went to Smyrna, where he passed the winter; and from thence to Tabriz in Persia; from both which places he wrote several very interesting letters to Mr. Tennant. In one of these he mentions, that in passing through Armenia he had satisfied himself by mineralogical observations which he had made, that a considerable tract of that country, including Mount Ararat, is of volcanic origin. He likewise ascertained, by measuring the temperature of boiling water, (at the suggestion of Mr. Tennant) that the city of Arzroum, the capital of Armenia, is 7000 feet above the level of the sea.

Most unfortunately for the cause of scientific discovery, Mr. Browne perished afterwards (as is well known) by the hands of Banditti, near the river Kizzil Ozan, east of Tabriz. Previously to his leaving England, when he was setting out on this journey, he had made his will, by which he named Mr. Tennant one of the executors, and left him a considerable bequest. On opening the packet in which the will was enclosed, a paper was found in Mr.

Browne's hand-writing, containing a characteristic and remarkable passage from one of Pindar's Odes, highly expressive of that generous ambition, and contempt of danger and death, which are the true inspiring principles of such enterprizes.\* Till he saw this paper, Mr. Tennant, notwithstanding his long intimacy, had never been fully aware of the real force of his friend's character, and of the powerful and deep feelings which his cold manners and habitual reserve had effectually concealed from observation. †

It was before stated that Mr. Tennant's health had been gradually declining. His frame was naturally feeble; and during the latter years of his life, though he was seldom materially indisposed, he was scarcely ever entirely well. Almost always on going to bed he had a certain degree of fever, and was often obliged to get up in the middle of the night, and to obtain relief by exposure to the cool air. To preserve himself in any degree of bodily vigour, he was under the necessity of using daily exercise on horseback; a practice which, though he complained of as a serious encroachment on his time, he hardly ever omitted in the severest weather. His long journies into various parts of England and Ireland were usually performed in this manner.

\* The following is the passage alluded to:—

Ὁ μέγας δὲ κίνδυνος  
ἀναλκιν ἐφῶ-  
τα λαμβάνει. Θανεῖν δ' οἶσιν ἀνάγκη,  
τί κέ τις ἀνάνθυμον γῆρας ἐν σκότῳ  
Καθήμενος ἔψοι μάταν, ἀπάντων  
Καλῶν ἄμμορος; ἄλλ' ἔμοι μὲν ἔπος ἶ  
Ἄθλος γ' ὑποκίσσεται.

*Pindari Olymp. Carm. 1, v. 129,*

In the paths of dangerous fame  
Trembling cowards never tread;  
Yet since all of mortal frame  
Must be number'd with the dead,  
Who in dark inglorious shade  
Would his useless life consume,  
And with deedless years decay'd  
Sink unhonour'd to the tomb?  
I that shameful lot disjoin,  
I this doubtful list will prove.—

*West's Pindar.*

† It may be worth mentioning, that Mr. Tennant always lamented, after he became acquainted with Mr. Browne's learning and talents, that his intimacy with him had not commenced before the publication of his *African Travels*. In preparing that work for the press, Mr. Browne, from an unreasonable distrust of his own powers, had thought it necessary to have recourse to literary assistance; but was not happy in his compiler. Neither the style of the *Travels*, nor the tone in which they are composed, is such as to do any justice to the important information which they contain, or to the character and merits of the distinguished traveller whose name they bear.

In the summer of 1809, as he was riding to Brighthelmston, he met with a serious accident, by which his collar bone was broken. He was removed to the house of his friend Mr. Howard, in the neighbourhood of London, where he was treated with the most affectionate kindness, and remained till his complete recovery.

During the early period of his residence in London, Mr. Tennant had led rather a retired life; but in his more advanced years he went much more into the world, and cultivated general society. He had a particular pleasure in conversing with intelligent travellers newly returned from distant countries, or in suggesting rational objects of inquiry to such as were about to visit them. As an instance of the latter, it may be mentioned, that he was at considerable pains in instructing M. Burchardt, a gentleman sent out by the African Association to explore the interior of that continent, in the principles of mineralogy. He frequently gave small morning parties at his chambers in the Temple, which he rendered very amusing to his friends by the exhibition of interesting prints and drawings, of rare specimens and new substances in chemistry, or of other objects calculated to gratify an intelligent and well-directed curiosity. It happened in the spring of 1812 that he had engaged to shew his mineralogical collection to a large party of his acquaintance, with a view of explaining to them the nature of some of the principal substances, and of giving them some general ideas of mineralogy. His intention being known, several others of his friends requested permission to be present; and he was gradually induced to extend his original plan, and to give a few lectures on the general outlines of mineralogical chemistry. The undertaking was somewhat arduous, considering the expectations which his high character was likely to excite, his total inexperience as a lecturer, and the difficulty of adapting himself to so mixed an audience; which, though consisting principally of females, included many individuals distinguished for science and literature. It was attended, however, with complete success. Of Fontenelle, the first of those writers who have given a popular and engaging form to the lessons of philosophy, it is said by Voltaire:—

“ L'ignorant l'entendit, le savant l'admira.”

This praise was strictly applicable to Mr. Tennant. The great clearness and facility of his statements, the variety and happiness of his illustrations, and the comprehensive philosophical views which he displayed, were alike gratifying to every part of his audience. He delivered about four lectures, each of which was of great length; yet the interest of his hearers was never in the least suspended. Though his style and manner of speaking were raised only in a slight degree above the tone of familiar conversation, their attention was perpetually kept alive by the spirit and variety with which every topic was discussed, by anecdotes and quotations happily introduced, by the ornaments of a powerful, but chastised, imagination; and, above all, by a peculiar vein of pleasantry, at

once original and delicate, with which he could animate and embellish the most unpromising subjects.

The delivery of these lectures may be considered by some persons as a very trifling occurrence in the life of a man of science; but the writer has thought it well worthy of a place in the present narrative, not only as affording a new proof of the extent and variety of Mr. Tennant's powers, but because it exemplifies in a very pleasing manner one of the striking and amiable peculiarities of his character. As he had a remarkably clear perception of the most refined scientific truths, so he possessed a power of explaining and illustrating such subjects, which might justly be deemed unrivalled. Without any ostentation of learning, he had a peculiar delight in communicating knowledge to others; but especially, in unfolding the principles of science to young persons, capable and desirous of receiving such information; and he partook with the most lively sensibility in the emotions of curiosity, pleasure, and surprise, which his lessons seldom failed to inspire. He entirely differed from those who condemn as trifling and superficial, that increasing taste for scientific knowledge in the higher and more opulent classes, to which many circumstances have lately contributed. He considered the diffusion of this taste among the young, the idle, and the wealthy, though liable in some cases to degenerate into affectation, as being in its general effects highly beneficial; both by affording to an important class of society additional sources of intellectual pleasure and new objects of rational pursuit; and indirectly, by obtaining for science and its professors a greater degree of public consideration and respect than they have enjoyed in any former age.

In the spring of the year 1813 Mr. Tennant delivered before the Geological Society a lecture on the principles of mineralogy. After taking an historical view of the subject, and pointing out the merits and defects of the principal writers by whom it had been systematically treated, he took an enlarged view of the science, regarding it as that branch of chemistry which treats of the definite compounds that are found native in the mineral kingdom, and whose crystalline forms and other properties are to be studied and described in the same manner as those of any other chemical substance. He then noticed several artificial productions which are analogous to those of Nature; and amongst the rest a silicate of copper, which he had formed by adding a solution of that metal to an acidified *liquor silicum*, which he conceived might perhaps be identical with the Siberian mineral called Diopside.

Mr. T. had communicated to the Geological Society some time previously (in the year 1811) the result of his investigation of the native boracic acid, which he had discovered in a collection of volcanic substances from the Lipari Isles, and which has since been found in the island Volcano by Dr. Holland. This communication was published in the first volume of the Transactions of the Geological Society.



In the year 1813, a vacancy happening in the Chemical Professorship at Cambridge, he was urged by some of his friends resident in the University to become a candidate for that appointment. He was induced to accede to their solicitations, principally from thinking that the duty of delivering an annual course of lectures would furnish him with a motive of useful and honourable exertion. For a short time after he had declared himself, some opposition was apprehended on the part of a very respectable candidate resident in the University; and during this period the exertions which were made by Mr. Tennant's friends, and the assurances of support which he received, greatly exceeded what had ever been known on any similar occasion. The opposition being withdrawn, he was elected Professor in May, 1813.

During the months of April and May in the following year he delivered his first and only course of academical lectures, which was attended by a very numerous class of students. The greater part of these lectures were spoken from notes containing the order of the subjects, and the principal heads of discussion. But the introductory lecture was written at length, and still remains in manuscript. It presents a rapid and masterly outline of the history of chemistry, interspersed with many original and striking remarks on the nature of the science itself, on its extensive application, and prodigious effects in promoting the civilization of mankind, and on the merits and discoveries of some of its most distinguished professors in different ages and countries.

The impression made by these lectures will not soon be forgotten in the University; and it is impossible, without the greatest regret, to consider the effects which a continuance of these labours during a series of years might have produced, not only in advancing chemical knowledge, but in diffusing a general love of philosophical research, and in promoting enlightened and comprehensive views on all the various subjects with which that science is more or less immediately connected.

In June, 1814, his two last communications were read to the Royal Society: the one upon an easier mode of procuring potassium than that which is in common use; and the other on the means of procuring a double distillation by the same heat, which has been more than once alluded to in the course of this memoir.

The great variety of chemical subjects on which Mr. Tennant had been at different times engaged, but upon which his experiments were left incomplete, or insufficiently recorded, has been already mentioned. A brief notice of some of the most important facts which he ascertained, and of the principal series of experiments to which his attention was directed, would form an interesting part of the present memoir; but this, owing to various causes, and especially to the state of his papers, cannot as yet be attempted. Among the insulated facts, one of the latest was the making sugar from starch with oxalic acid, in the same manner as it had been made by M. Kirchoff with oil of vitriol; and the last chemical in-

vestigation to which he applied himself was an endeavour to ascertain from whence the Iodine found in several marine plants is derived. On this he had laboured assiduously during the spring and summer of 1814; and early in September in that year, the evening before he left London, he mentioned to a friend that he had detected iodine in sea water. A tarnishing which he had observed in silver leaf,\* led him to promise himself a successful termination of these researches; but it is not known what were the decisive experiments by which he had succeeded in making this discovery.†

Mr. Tennant had always lamented his omission to visit the Continent of Europe during the short peace of 1802. He therefore took an early opportunity, after the general pacification of 1814, of passing over to France for the purpose of observing those changes which the eventful period of the last twenty years has produced, and of renewing his personal communications with men of science at Paris, from which he had been so long debarred. His own experience had taught him how much may be known, which has not been communicated in books. In this respect he was not disappointed; for in one of his letters, written a short time before he left Paris, he mentioned with much satisfaction how many interesting facts he had collected which would enliven his Cambridge lectures.

He went to France early in September, 1814; and the following passage of a letter, in which he relates his first sensations, may be worth transcribing, both because it affords somewhat of a specimen of his general manner, and may perhaps recall to the recollection of his friends several of his favourite topics and opinions. "After a short and favourable passage of three hours and a half, we got into the harbour of Calais, with its immense pier. The difference of every thing struck me prodigiously. I felt quite intoxicated with

\* The same test for iodine in iodic salts is proposed by Sir Humphry Davy in the *Philosophical Transactions* for 1814.

† Among the different series of experiments alluded to in this memoir, upon which Mr. Tennant had been engaged at various periods of his life, but which he had not brought to a completion, the following may deserve to be mentioned:—

Researches on the pigments used by the ancients.

Experiments made with a view to improve the glass employed in the construction of achromatic lenses.

Experiments on the refractive powers of compound bodies compared with the refractive powers of their constituents.

Mr. Tennant had at one time very nearly obtained an insight into the wonderful class of phenomena belonging to voltaic electricity; as appears from the following extract from an old note-book, in which there is no date; but Mr. T. always spoke of the experiment as having been made many years since.

"If a piece of silver or gold is immersed in a solution of vitriol of copper, and the silver or gold is touched with iron or zinc, the copper is diffused upon them around the point of contact; upon platinum, not so easily; the iron, though very near, occasions no precipitate upon the silver or gold; but if iron touches silver, and silver gold, the latter gets the copper."

the novelty of the scenery, the abundance of the country, the bright blue sky without a cloud, and the broad magnificent roads, with elms, and sometimes fruit-trees, on each side for fifty miles. I was a little mortified on comparing the climate with our own, till I observed the many points in which its advantages were neglected; open fields; harvest not finished, as in England; corn full of weeds; and oats more than one-third inferior in quality to my own at Mendip. On approaching Paris, the vineyards were new features of this superior climate. At Paris, what strikes one most is the narrowness of the streets; along which as I passed I was in constant expectation of getting out of the eternal narrow lanes. Now I am quite reconciled to them.—The backward state of civilized life is more apparent here than in the country. You are struck with the imperfection of every thing, and the mixture of dirt and meanness with pomp and expence. In the theatres, (which, however, are quite inferior to ours in size, and still more in elegance,) you see in the passages behind the boxes, dirty pavements of brick, with wide cracks; and the boxes are opened by a few old women, who are employed during the intervals in knitting or mending stockings. The women are such as might be taken from a field in England, where they would be employed in weeding.”

During his stay in France, Mr. Tennant, in the months of October and November, made a tour into the southern provinces, which he had not before seen, and visited Lyons, Nismes, Avignon, Marseilles, and Montpellier. He was much gratified by this journey, during which he made many interesting remarks on the state of the country, paying particular attention to mineralogy and agriculture. In his letters written about this time he describes in striking terms the feelings of enjoyment, which he always experienced from new scenes and objects, and especially from viewing the productions of Nature in southern climates. In speaking of the range of mountains from whence the Saone takes its rise, he says, “The country is the most rich and picturesque that can be imagined; but the contrast of the beggary and dirt of the towns and common habitations with the rich vegetation of the country is universal, with the exception only of towns of the first rate. I am not yet sufficiently at home in the political economy of the country to say on what this depends. In part, on its extreme population.—After passing these mountains, a new world appears, marked with the characters of a southern climate. The race of people is different, with finer skins than in the North. The country women wear immense hats, to defend them from the sun; and the houses (there being no snow) have low pitched roofs, like those in Poussin and Claude Lorraine. Nothing can be more beautiful than this style of building, which continues to the Mediterranean.—Proceeding south, vines and mulberries chiefly cover the ground; and following the Saone, its mountainous banks, studded with country houses, almost buried in the rich vegetation of figs, mulberries, vines, and pomegra-

nates, exceed all anticipation. Suppose the scenery of the hot wells at Bristol extended 50 miles, with a broader rapid river, higher mountains, under a glowing climate, and thickly set with white cottages, intended to be copied by a painter. Nothing is so fine as the situation of Lyons, and the views into the paradisiacal valley from the mountains on each side of the town. This wonderful scenery continues along the Rhone by Vienne (from whence comes the *Coté rotie* wine) and Tain (from whence *Hermitage*) till you arrive in Provence, where the olive, a new production of the southern climates, begins to make its appearance. Through this rich garden or forest you come to the calcareous mountains, which on their summits are white rocky hills, covered with wild plants, thyme, rosemary, lavender, ilex, quercus coccifera, and innumerable plants unknown in our latitude, but which I hope to raise in England next year, to renew my impressions of this country. These mountains enclose the valley of that wonderfully situated immense town of Marseilles. As you descend, the Mediterranean appears, and the great city with its endless suburbs in the hollow vallies sloping towards the sea. \* \* \* \* It was with infinite regret that I left Marseilles; if I could stay the winter, it should be there. Avignon is pleasingly situated; Nismes has fine antiquities; Montpellier is in a rich and plentiful country; but they are all *triste* and dead compared with Marseilles, where every attraction is united."

On his return from Montpellier to Paris, he writes, while stopping for a few days at Lyons, "At Montpellier I had the peculiar advantage of a most attentive acquaintance (M. Berard), who is one of the best chemists in France. The country affords few such; but he was brought up at the feet of Berthollet, who gave me a letter to him. He succeeded to the chemical works of Chaptal, which are now very extensive, and carried on with great intelligence.—On my return I visited the great Roman aqueduct of the Pont du Gard, so striking for its antiquity, its altitude, its solidity, and the very romantic situation where it passes over the valley and river. Pont St. Esprit is hardly less interesting, being of such immense extent (more than half a mile), and the lowest bridge on the Rhone. It was built, not by the Romans, but in the darkest ages by the powers of superstition, the great principle of energy and exertion at that period. In 1265 the offerings to the convent of St. Esprit were sufficient for this undertaking, and were thus applied by the monks, with honour to themselves, and with great advantage to a remote posterity; for the passage over it is immense at this time.—I stopped for half a day at Tain, from whence we have the *Hermitage* wine. Nothing can be more beautiful than the gold colour of the 'vine-covered hills,' nor more extraordinary than the sand or gravel in which the plant grows. There is not a particle of soil, but merely broken, sharp fragments of granite, chiefly felspar, perfectly clean; for though the roots of the vine are manured once a year, this totally disappears. The gravel soil is supported by walls.

From the top are seen endless mountains, which border on the Rhone, and which along the slopes facing the south are yellow with vines, in spite of the extreme barrenness of the soil. Such mountains, which are here among the most valuable parts of the kingdom, would not in England be worth a penny an acre.—From this place (Lyons) we rode the other day into the mountains near Arbresle to see a new copper-mine, consisting of a blue carbonate; compared with which the specimens from Siberia are quite insignificant. \* \* \* \*

Mr. Tennant returned to Paris during the month of November, and was to have returned to England about the latter end of the year. But he continued to linger on till February following. On the 15th of that month he reached Calais; and wrote from thence on the next day, to account for his long delays; which had been occasioned, he said, “by his postponing the disagreeable exertion of setting off, added to the severe weather, and the odious view of the ocean, of which he had so great a horror, that it darkened the agreeable prospect of meeting his friends in England.”

The wind then blew directly into Calais harbour, and continued to be unfavourable for several days. After waiting till Monday, the 20th, he went to Boulogne, in company with Baron Bulow, a German officer, who was also going to England, in order to take the chance of a better passage from that port. They embarked on board a vessel on the morning of Feb. 22d; but the wind was still adverse, and blew so violently that the vessel was obliged to put back. When Mr. Tennant came on shore, he said, “that it was in vain to struggle against the elements, and that he was not yet tired of life.”

It was determined that, in case the wind should abate, another trial was to be made in the evening. During the interval, Mr. Tennant proposed to the Baron that they should hire horses, and take a ride. They rode at first along the sea side; but on Mr. Tennant’s suggestion, they went afterwards to Buonaparte’s Pillar, which stands on an eminence about a league from Boulogne, and which, having been to see it the day before, he was desirous of shewing to Baron Bulow.

On their return from thence, they deviated a little from the road, in order to look at a small fort near the pillar, the entrance to which was over a Fosse 20 feet deep. On the side towards them there was a standing bridge for some way, till it joined a draw-bridge which turned upon a pivot. The end next to the fort rested on the ground. On the side towards them it was usually fastened by a bolt; but the bolt had been stolen about a fortnight before, and was not replaced.

As the bridge was too narrow for them to go abreast, the Baron said he would go first, and attempted to ride over it. But perceiving that it was beginning to sink, he made an effort to pass the centre, and called out to warn his companion of the danger; but it

was too late—they were both precipitated into the trench. The Baron, though much stunned, fortunately escaped without any serious hurt; but on recovering his senses, and looking round for Mr. Tennant, he found him lying under his horse, nearly lifeless.

He was first conveyed to a cottage, inhabited by the person who had the care of the pillar; and medical assistance being procured from Boulogne, it was found that his skull and one of his arms were dreadfully fractured, and that there was no hope of his recovery. He was taken, however, to the Civil Hospital, as the nearest and most convenient place to receive him. After a short interval, he seemed in some slight degree to recover his senses, and made an effort to speak, but without effect, and died within an hour.—His remains were interred a few days afterwards in the public Cemetery at Boulogne, being attended to the grave by most of the English residents.

Mr. Tennant was tall and slender in his person, with a thin face and light complexion. His appearance, notwithstanding some singularity of manners, and great negligence of dress, was on the whole striking and agreeable. His countenance in early life had been singularly engaging; and at favourable times, when he was in good spirits and tolerable health, was still very pleasing. The general cast of his features was expressive, and bore strong marks of intelligence; and several persons have been struck with a general resemblance in his countenance to the well-known portraits of Locke.

The leading parts of his moral and intellectual character are apparent in the principal transactions of his life. But in this memorial, however imperfect, of the talents and virtues of so extraordinary a man, some attempt must be made to delineate those characteristic peculiarities, of which there are no distinct traces in the preceding narrative.

Of his intellectual character, the distinguishing and fundamental principle was good sense; a prompt and intuitive perception of truth, both upon those questions in which certainty is attainable, and those which must be determined by the nicer results of moral evidence. In quick penetration, united with soundness and accuracy of judgment, he was perhaps without an equal. He saw immediately and with great distinctness, where the strength of an argument lay, and upon what points the decision was ultimately to depend; and he was remarkable for the faculty of stating the merits of an obscure and complicated question very shortly, and with great simplicity and precision. The calmness and temper, as well as the singular perspicuity, which he displayed on such occasions, were alike admirable; and seldom failed to convince the unprejudiced, and to disconcert or silence his opponents.

These powers of understanding were so generally acknowledged, that great deference was paid to his authority, not only upon ques-

tions in science, but upon most others of general interest and importance. What Mr. Tennant thought or said upon such subjects, his friends were always anxious to ascertain; and his opinions had that species of influence over a numerous class of society which is one of the most certain proofs of superior talents.

Next to rectitude of understanding, the quality by which he was most distinguished, was a lofty and powerful imagination. From hence resulted a great expansion of mind, and sublimity of conception; which, being united with deep moral feelings, and an ardent zeal for the happiness and improvement of mankind, gave a very peculiar and original character to his conversation in his intercourse with familiar friends. He partook with others in the pleasure derived from the striking scenes of nature; but was more particularly affected by the sight or contemplation of the triumphs of human genius, of the energies of intelligent and successful industry, of the diffusion of knowledge and civilization, and of whatever was new and beautiful in art or science. The cheerful activity of a populous town, the improvements in the steam-engine, the great Galvanic experiments, and, above all, the novelty and extent of the prospects afforded by that revolution in chemical science which has illustrated our own age and country—these magnificent objects, when presented to Mr. Tennant's mind, excited in him the liveliest emotions, and called forth the most animated expressions of admiration and delight.

This keen sensibility to intellectual pleasure may be partly understood, from the following passage of a letter written by him in January 1809, to an intimate friend who was then abroad. After mentioning the great phenomena of the decomposition of the alkalies by Voltaic electricity, and giving a general view of the experiments founded upon them, he thus concludes: "I need not say how prodigious these discoveries are. *It is something to have lived to know them.*"

His taste in literature and the fine arts partook, in a considerable degree, of the peculiar character of his imagination. His favourite writers (those whom he most valued for the eloquence of their style) were such as describe "high actions and high passions," and have the power of exciting strong and deep emotions. Of the poets, he principally esteemed Virgil, Milton, and Gray; and the prose writers to whom he gave the preference for powers of composition were Pascal and Rousseau. He had a particular admiration of the "*Pensées de Pascal*," regarding it as a production altogether unequalled in energy of thought and language, in occasional passages of refined and deep philosophy, and, above all, in that sublime melancholy, which he considered as one of the peculiar characteristics of great genius.

The same principles governed Mr. Tennant's judgments in the fine arts. Considering it as their proper office to elevate the mind, and to excite the higher and nobler passions, he estimated the merits of the great masters in music and painting by their power



of inspiring these emotions. What he particularly admired in musical compositions was that tone of energy, simplicity, and deep feeling, of which the works of Handel and Pergolesi afford the finest specimens.\* In painting he awarded the superiority to those distinguished masters, of whom Raphael is the chief, who excel in the poetical expression of character, and in the power of representing with spirit, grace, and dignity, the most exalted sentiments and affections.

It was almost a necessary consequence of his intense and deep feeling of these higher beauties, that his taste was somewhat severe, and that his ideas of excellence, both in literature and the fine arts, were confined within strict limits. He totally disregarded mediocrity, and gave no praise to those inferior degrees of merit, from which he received no gratification.

In consequence principally of the declining state of his health, his talents for conversation were perhaps less uniformly conspicuous during his latter years. His spirits were less elastic, and he was more subject to absence or indifference in general society. But his mind had lost none of its vigour; and he never failed, when he exerted himself, to display his peculiar powers. His remarks were original; and his knowledge, assisted by a most retentive memory, afforded a perpetual supply of ingenious and well-applied illustrations. But the quality for which his conversation was most remarkable, and from which it derived one of its peculiar charms, was a singular cast of humour, which, as it was of a gentle, equable kind, and had nothing very pointed or prominent, is hardly capable of being exemplified or described. It seldom appeared in the direct shape of what may be called *pure* humour, but was so much blended either with wit, fancy, or his own peculiar character, as to be in many respects entirely original. It did not consist in epigrammatic points, or brilliant and lively sallies; but was rather displayed in fanciful trains of imagery, in natural, but ingenious and unexpected, turns of thought and expression, and in amusing anecdotes, slightly tinged with the ludicrous. The effect of these was much heightened by a perfect gravity of countenance, a quiet-familiar manner, and a characteristic beauty and simplicity of language. This unassuming tone of easy pleasantry gave a very peculiar and characteristic colouring to the whole of his conversation. It mingled itself with his casual remarks, and even with his graver discussions. It had little reference to the ordinary topics of the day, and was wholly untinged by personality or sarcasm.

It should be mentioned, among the peculiarities of Mr. Tennant's literary taste, that in common perhaps with most other

\* In Mr. Tennant's conversations on this subject, he often alluded to a remarkable passage in Rousseau's Musical Dictionary (the article "Génie") in which that celebrated writer describes with his own peculiar eloquence the feelings produced by great musical compositions, considering the capacity of receiving such emotions as the true criterion of musical genius. Mr. T. was also accustomed to speak of Avison's Treatise on Musical Expression in terms of high praise.

original thinkers, he bestowed little attention on books of opinion or theory; but chiefly confined himself to such as abound in facts, and afford the materials for speculation. His reading for many years had been principally directed to accounts of voyages and travels, especially those relating to Oriental nations; and there was no book of this description, possessing even tolerable merit, with which he was not familiarly conversant. His acquaintance with such works had supplied him with a great fund of original and curious information, which he employed with much judgment and ingenuity, in exemplifying many of his particular opinions, and illustrating the most important doctrines in the philosophy of commerce and government.

Of his leading practical opinions, sufficient intimations have been given in the course of the preceding narrative. They were of a liberal and enlightened cast, and such as might be expected from the character of his genius and understanding. Among them must be particularly mentioned an ardent, but rational, zeal for civil liberty; which was not, in him, a mere effusion of generous feeling, but the result of deep reflection and enlarged philosophic views. His attachment to the general principles of freedom originated from his strong conviction of their influence in promoting the wealth and happiness of nations. A due regard to these principles he considered as the only solid foundation of the most important blessings of social life, and as the peculiar cause of that distinguished superiority, which our own country so happily enjoys among the nations of Europe.

Of his moral qualities, it is scarcely possible to speak too highly. He described himself as naturally passionate and irascible, and as roused to indignation by any act of oppression or wanton exercise of power. The latter feeling he always retained, and it formed a distinguishing feature of his character. Of his irritability, a few traces might occasionally be discovered; but they were only slight and momentary. His virtuous dispositions appeared on every occasion, and in every form, which the tranquil and retired habits of his life would admit of. He had a high sense of honour and duty; and was remarkable for benevolence and kindness, especially towards his inferiors and dependents. But his merits were most conspicuous in the intercourse of social life. His amiable temper, and unaffected desire of giving pleasure, no less than his superior knowledge and talents, had rendered him highly acceptable to a numerous and distinguished circle of society, by whom he was justly valued, and is now most sincerely lamented. But the real extent of his private worth, the genuine simplicity and virtuous independence of his character, and the sincerity, warmth, and constancy of his friendship, can only be felt and estimated by those, to whom he was long and intimately known, and to whom the recollection of his talents and virtues must always remain a pleasing, though melancholy, bond of union.

## ARTICLE II.

*Observations on Crystallization.* By John Redman Coxe, M. D.  
Professor of Chemistry, Philadelphia.

THE efficacy of temperature in augmenting the solvent power of liquids is laid down by most chemical writers. This is more especially the case with the class of salts; to which, however, some exceptions occur, as in muriate of soda, which is nearly equally soluble in boiling water, and in water at the common atmospheric temperature. There is, nevertheless, something as yet not well understood, that appears to me operative in such cases, independent entirely of temperature, even in the instances of our most soluble salts, as Glauber's, or the sulphate of soda and some others.

It is almost universally asserted by authors on the subject, that atmospheric pressure is essential to the crystallization of salts; and the proof advanced is, that if a phial, nearly filled with a *boiling saturated* solution of Glauber's salt, be closely corked whilst filled with vapour, so as to exclude the atmospheric pressure; this solution will remain, even when cold, perfectly fluid, and may be shaken without becoming solid: but if the cork be withdrawn, the sudden impulse, from the air rushing into the phial, immediately induces the crystallization of the mass, with a sensible evolution of heat.

Now this beautiful and interesting experiment, which is usually shown in every course of chemical lectures, certainly at first sight appears to prove the position advanced. There are, however, numerous objections to its truth; yet so numerous are the anomalies that present themselves in experimenting upon this subject, that I am unable to form any theory or speculation on their causes.

1. If the above position were true, then certainly, by a parity of reasoning, we should expect every other saline solution, in which a boiling heat is employed to promote its fullest state of saturation, to be affected in a similar way; but this is not the case as far as I have tried it. Nitrate of potash and muriate of ammonia, both nearly as soluble as Glauber's salt, *when secured from atmospheric pressure*, by corking the phial, or tying a bladder over the mouth, precipitate in regular crystals as the solution cools. This fact alone is sufficient to overturn the theory advanced to explain the case stated of the Glauber's salt;—but,

2. A perfectly saturated solution of Glauber's salt, thus carefully corked at a boiling heat, has repeatedly crystallized throughout, *without any exposure* to the atmospheric pressure; whilst a solution of equal strength, and prepared and secured in every respect as the former, has, whilst standing beside it, remained perfectly fluid.

3. Saturated solutions of salts as above, *uncorked*, evince the

same results. I have kept some vessels thus exposed to the full atmospheric pressure for three days, without any consolidation; and others, during all the intermediate periods, with similar results. Sometimes one or more will crystallize, whilst others continue fluid. I have made these experiments in phials holding from two drachms to 16 ounces; in receivers of a globular and oval shape, from half a pint to half a gallon; some with short, and others with long necks; and in open glass jars of one to two inches diameter, and eight or nine long; so that the *form* of the vessel in no way appears to influence the result. Nor has the *quantity* of solution in the vessel any influence, since it is the same when filled to the top, or when only filled to one-fourth or one-fifth part. The result was the same when I employed the common Glauber's salts of the shops, the *native*, or the *artificial*, made by the direct combination of the constituents. In one experiment made with the artificial sulphate I filled three equal phials, two were closely corked, the third remained open, and all were placed beside each other to cool. In four hours *one* of the *corked* solutions was regularly crystallized in solid transparent crystals, one-fifth only of the mass being in a liquid state, which did not consolidate by shaking, or by withdrawing the cork. The contents of the *other corked*, and of the *uncorked* phial, both continued fluid; and *both* became solid by shaking, without withdrawing the cork of the closed one.

4. Solutions as above, after remaining exposed, have even not crystallized when briskly shaken, and some time afterwards without any apparent cause, have assumed the solid form.

5. Solutions as above, and closely secured, have failed to become solid, when the cork has been drawn, or the bladder punctured, for some moments, and even minutes; and in a few cases when even agitation was employed in addition: and these, in like manner, when least expected, have suddenly crystallized.

6. Solutions as above, both *corked* and *uncorked*, have gradually deposited regular *transparent firm* crystals,\* in some instances two inches in length; in others, in irregular masses, at the bottom of the vessel—the fluid above, in these cases, continuing clear and saturated; and when shaken, sometimes consolidating in the usual way.

7. Solutions as above, both *corked* and *uncorked*, after thus depositing these *regular* crystals at the bottom, have, without an apparent cause, become consolidated above them, whilst remaining untouched.

8. Solutions as above (especially in a mattrass with a neck nearly two feet long), have, after considerable exposure and frequent agitation, refused to crystallize, even although continued at intervals for

\* The crystals which form *suddenly* in these solutions are always of a soft, spongy, silk-, striated, appearance; and do not exhibit the firm, transparent, glassy, appearance of the common crystals of Glauber's salt.

more than an hour; yet by then *turning* the vessel, so as to pour out a little from the neck, the crystallization has immediately occurred.

9. The same solution in the matrass above mentioned has frequently become completely crystallized when left uncorked; at other times a large mass, equal to half the volume of the solution, has crystallized regularly, in hard transparent crystals, the remainder of the solution continuing fluid.

10. Saturated *mixed* solutions of nitre and Glauber's salt, *corked* closely, have allowed the nitre to crystallize regularly at the bottom; whilst the Glauber's salt remained fluid, and on drawing the cork became solid in the usual way.

11. Solutions, by *no means saturated*, evince similar results with the above fully saturated ones, although not in so strongly marked a manner.

12. One of the most singular and interesting facts connected with these experiments is, that in those cases in which (*either* in the *corked* or *uncorked* solutions) regular, firm, *transparent* crystals form, so soon as the *residuary* saturated solution above them solidifies, either spontaneously, or by shaking, drawing the cork, &c. an immediate (or nearly so) opalescence, or loss of transparency, ensues in those *first formed* crystals, which gradually increases to a beautiful porcelainous whiteness. This I have almost invariably noticed under the above circumstances: I believe it arises from the gradual abstraction of the water of crystallization of the first formed regular crystals, by the mass of secondary crystals; for in one experiment made, I found the porcelainous mass, when dissolved in water, and regularly recrystallized, afforded a quantity of transparent crystals, *superior in weight* to those I employed, which could only arise from their re-obtaining their thus lost water of crystallization. How the secondary crystals operate in withdrawing this water from the first, I cannot form the most distant idea.

13. In those solutions in which spontaneous crystals have formed, in the course of a few days, if the secondary crystallization does not take place, a complete truncation of the summits of the crystals occurs, gradually forming a level of the whole, as in common cases; yet in several instances the solution above was sufficiently saturated to consolidate when shaken.

14. In one experiment two equal sized phials were filled to the top with saturated solutions; one was corked, the other was left open: in two hours the uncorked one had consolidated; the other was observed to have contracted above one-fourth of an inch, and continued fluid; it crystallized, however, as usual, when briskly shaken, without withdrawing the cork.

It should perhaps be mentioned, that this sudden crystallization always commences at the surface.

I have put the solutions, both corked and uncorked, into cold water, as soon as made, in order to expedite their cooling, and have found the same results generally as when suffered to cool gra-

dually. The solution in open phials has sometimes cooled down to the temperature of the cold water (about  $40^{\circ}$ ), and has then remained fluid in it for two or three hours; it has then sometimes crystallized in the soft spongy mass; at others in firm, well formed regular crystals.

15. Four or five phials have burst in which spontaneous regular crystals had formed, and over which subsequently a sudden consolidation of the residuary solution had taken place, after the change of colour was effected in the first crystals (as mentioned in No. 12), but whether from an expansion in the first or second crystals, I know not, as I was never present when this occurred.\* I have never seen this fracture of the phial when *only* the regular crystals had formed, nor when *only* the spontaneous solidification took place. It is probably, therefore, somehow connected with the abstraction of the water of crystallization from the regular by the spontaneous spongy mass. In the above instances the crystals which had formed regularly were perfectly white, and were readily separated from the superior spongy ones by a little water gently poured over them, leaving them of the most perfect regularity, and forming a beautiful white crystalline preparation easily preserved, and not efflorescent, as in common cases.

In all the cases thus enumerated, such are the anomalies presented as to prevent my drawing one conclusion from them which could give me any insight into the causes that produce them. In some cases atmospheric pressure seems to operate, in others not; agitation sometimes, but not invariably. The whole series of experiments is so interesting, I trust this account may lead to further investigation, which may finally afford an explanation, and possibly lead to new views on the subject of crystallization generally. I can only add, that I never could promise myself, *à priori*, that any one case should certainly turn out as I expected; it appeared a matter of chance in a great degree, whether this or the other result should ensue. †

\* I apprehend it must occur during the abstraction of the water of crystallization from the primary by the secondary crystals, which must be accompanied by a correspondent expansion.

† In speaking of the effect of atmospheric pressure on saturated solutions of salts, Dr. Higgins details an experiment which he made in a narrow-necked glass matrass of three gallons dimensions. It was fixed in a vessel filled with a saturated solution of sea salt: a solution of 144 oz. of Glauber's salts in 96 oz. of water, in a separate vessel, was filtered into the matrass, which was filled two-thirds by it, and the whole was made to boil so as to exclude the air by the vapour formed. A strip of wet bladder secured the mouth of the matrass, and sustained the atmospheric pressure.

Two matrasses were thus prepared: they stood three days at a temperature between  $40^{\circ}$  and  $50^{\circ}$ , and were often shaken without crystallizing; as soon as the bladder was cut a few small concentric spicular crystals formed, and shot rapidly through the liquor till it was almost solid: the calorific evolved, raised the temperature from  $60^{\circ}$  to  $90^{\circ}$ , and in one experiment from  $40^{\circ}$  to  $90^{\circ}$ .

From this experiment connected with those above detailed, as also from many well-known facts, I am impelled to deny the *perfection* of Dr. Black's celebrated theory of latent heat. It will be observed that boiling saturated solutions of



I have tried similar experiments with other salts, of which I shall barely state the outlines.

1. *Sulphate of Magnesia*.—Boiling saturated solutions of this salt, corked and uncorked, like the before-mentioned ones, sometimes crystallize, and sometimes continue fluid, I have never observed the beautiful satin-like crystallization perceptible in the sulphate of soda; but the crystals fall down in minute grains, like sand, diffused through the solution, gradually sinking to the bottom.

2. *Alum*, as above.—Crystals formed at the bottom; the remainder continued fluid, even when shaken; when the cork was withdrawn, shaking produced no effect for nearly a minute, when the same sand-like precipitation ensued, commencing from the top. When this ceased, it appeared nearly solid; but by standing for 24 hours, more than one-half was fluid.

3. *Sulphate of Iron* exhibited an appearance nearly similar to that of alum.

4. *Sulphate of Copper*.—The same, with some occasional variation, even in the same solution.

5. *Sulphate of Zinc* remained fluid for 24 hours, although a boiling saturated solution was employed, and frequent agitation.

6. *Subcarbonate of Soda* (*sal sodæ*) boiling and saturated. In one case (*corked*) it became nearly solid when cold, from the spontaneous crystallization. The same solution subsequently deposited, whilst corked, a smaller quantity of spontaneous crystals; and after drawing the cork and shaking, small granular crystals speedily clouded the solution. The same resulted in uncorked solutions.

7. *Muriate of Lime*, saturated and boiling, crystallized, when *corked*, completely throughout: subsequently, dissolved by heat again, and corked, it remained fluid, *until shaken without uncorking*, when a crystallization as beautiful, and nearly resembling that of sulphate of soda, took place, with an extrication of more caloric than in any of the preceding cases.

8. *Muriate of Ammoniu*, corked and uncorked; boiling saturated solutions became solid as they cooled, with a firm crystallization.

9. *Nitre* deposits regular crystals at the bottom, both in corked and uncorked phials; but I never perceived any further result, except by the slow evaporation of the fluid.

I have tried a number of other salts, but the results are not worth

Glauber's salts have repeatedly refused to crystallize, even when exposed to the full pressure of the air, and that for days. Now it is to be remembered that such solutions had cooled from at least  $212^{\circ}$  to near the freezing point, and yet were enabled to hold that portion of salt in solution, which our theories presume to depend on the additional temperature. What was it that thus enabled the water to maintain its fluidity and transparency, although charged with such a quantity of solid matter, in opposition to atmospheric pressure and a diminished temperature of at least  $150^{\circ}$ ? Can it possibly have depended on a quantity of latent heat only equal in the above experiment of Dr. Higgins to  $59^{\circ}$ ? And is not the fact that water itself has been cooled down to  $20^{\circ}$  or  $25^{\circ}$  below the freezing point without coagulating, evidence that *something more* than a certain quantum of latent heat is essential to the fluidity of water, &c. Other objections to this theory present themselves, but this is not the place for considering them.



repeating at present, as I have not extended my experiments on them sufficiently.

If what I have stated should be sufficiently interesting, and at the same time compatible with the nature of your publication, I will thank you to give it an insertion.

*Philadelphia, July 27, 1814.*

### ARTICLE III.

#### *Experiments on the Draught of Carriages.*

By R. L. Edgeworth, Esq.

Mr. Bryan presented the following Report from the Committee of Mechanics and Natural Philosophy of the Dublin Society:—

#### *Report of the Committee of Mechanics and Natural Philosophy of the Dublin Society.*

On Saturday, the 22d of April, your Committee attended in the yard of Leinster House, when the following experiments were publicly made by Mr. Edgeworth:—

##### *Experiment I.*

Two furniture carts were placed at one end of the yard, which was paved in the ordinary manner. They were both constructed upon grasshopper springs; one of them was painted yellow, the other green.

These carriages were pulled forward by the apparatus invented by Mr. Edgeworth, which consists of a two-wheeled carriage, drawn by one or two horses, upon which a wheel or pulley, of nearly eight feet diameter, is so placed as to turn freely in an horizontal direction. A rope, passing round this wheel or pulley, is attached by its ends to the carriages that are to be compared; and, as the apparatus is drawn forward, the two carriages must follow, and that which goes the easiest will get foremost.

This apparatus was drawn at a moderate pace by two horses, and that carriage which ran the lightest and easiest was loaded till the other kept pace with it.

Five cwt. was then placed upon each.

The springs of the yellow carriage were prevented from acting by blocks of wood interposed between the springs and the body of the carriage. The green carriage, the springs of which were allowed to act, was now loaded with  $1\frac{1}{4}$  cwt. additional weight, making a total of  $6\frac{1}{4}$  cwt.; and the green carriage so loaded was found to get before the yellow carriage, the weight on which amounted to only 5 cwt.

By this experiment it appeared that the carriage upon springs had

an advantage over that without springs of one-fourth of the weight that was laid upon it.

### *Experiment II.*

Two post-chaises, weighing each 12 cwt. 7 lb. one of them painted black, the other white, were next compared; the perch of the black one was moveable, so that it could be lengthened or shortened at pleasure.

When their perches were of equal length, viz. of seven feet six inches, the carriages were compared previous to these experiments, and their draft was equalized by an addition of weight to that which ran the lightest.

The perch of the black carriage was now lengthened to ten feet three inches. The carriages were each of them loaded with 2 cwt.

They now nearly kept pace with each other, the one with the long perch appearing to have rather the advantage.

### *Experiment III.*

The load, which in the former experiments was placed in the bottom of the white carriage, was now placed in an imperial on the top. The removal of the weight four feet higher from the ground did not promote the progress of the carriage, which did not yet keep pace with the black carriage.

### *Experiment IV.*

Two similar Scotch drays, one of them painted blue, and the other red, were now compared. They had been brought to an equal weight; and the blue carriage was supported upon wooden springs, consisting of two pieces of elastic timber, connected with the bottom of the dray by iron shackles; each dray was loaded with 6 cwt.

The (blue) dray upon springs had now a weight of  $1\frac{1}{4}$  cwt. placed upon it. With this additional weight, however, it got before the (red) dray which had no springs.

From this experiment, the application of wooden springs to carts upon pavements, or upon ordinary roads, appears to have an advantage in the proportion of  $7\frac{1}{4}$  to 6. It must be observed, that a perfect coincidence of draft could not be obtained; because the carriages to be compared rolled upon different tracts of the pavement, so that the smallest inequality of the roads must have made some difference in the relative progress of the carriages; but to make as fair a comparison as possible between their drafts respectively, that carriage which was placed on the northern track, as the carriages went from east to west, was in its return placed on the southern track.

Some small variation of the draft might be occasioned by the elasticity of the long perch, and some by the vibratory motion of the fore carriage, which was drawn by a single rope. But to those conversant with the subject, these slight variations were but of little moment.

The result of these experiments fully prove, in the opinion of this Committee,

That the apparatus invented by Mr. Edgeworth is adequate to the purpose for which it is intended :

That it may be considered as a sure criterion of the relative draft of carriages :

That very short perches do not contribute to the ease of drafts :

That the dangerous system of loading the tops of carriages is by no means advantageous.

Signatures to the Report of the Committee respecting Mr. Edgeworth's experiments:—R. B. Bryan, Charles Cobbs Beresford, Robert Hutton, N. P. Leader, Richard Griffith, jun. John Patten, Richard Wynne, J. Lester Foster, and P. D. La Touche.

#### ARTICLE IV.

*On Coal Mines.* By Φιλαγθος.

(To Dr. Thomson.)

SIR,

THE numerous accidents which have of late years happened in the coal-mines of this district, have been productive of sorrow and wretchedness to many, and have excited commiseration and horror in all. To hear of 50, 60, nay 100, of one's fellow creatures being suddenly shut up within the bowels of the earth, a certain proportion of them instantaneously destroyed,\* the rest left to perish, either by hunger or slow suffocation, is such a piece of intelligence as shocks and outrages every feeling of the heart; yet it is a calamity which the inhabitants of the district of the Tyne and Wear are doomed very frequently to deplore. The risk and the frequency of these misfortunes are doubtless owing in no small degree to the great depth and extent to which the workings of the coal-mines penetrate, and the difficulty thence arising of avoiding wastes, and of maintaining the air in a state fit for combustion and respiration. To a certain degree, therefore, they are perhaps unavoidable. But what tends greatly to embitter the regret felt on their occurrence, is the alleged prevalence of a certain disinclination in those concerned in the working of coal-mines, either to communicate information on the subject in general, or to promote, with all the zeal that might be expected of them, those measures necessary for the discovery of the means of preventing accidents. Unhappily, the air of secrecy,

\* In the many fatal accidents which have occurred within my knowledge from explosions of inflammable gas, I think I may venture to assert, that not more than one-fourth of the persons they have ultimately killed have been the victims of their immediate effects; three-fourths of them almost invariably perish by suffocation. (Vide First Report of the Sunderland Society, p. 12.)

which they seem so desirous of maintaining, affords but too much room for censure, and subjects them to unfavourable imputations, of which they are probably wholly undeserving, and from which a different conduct would assuredly exempt them. Of their repugnance to grant information, both yourself and Mr. Bakewell have had experience, and have seen cause to complain publicly; and it is to be hoped that it will at last give way, if not to a spirit of liberality, or the power of conviction, at least to the force of necessity. Instances of the loss of lives are becoming so frequent, and of such frightful magnitude, that proprietors, occupiers, and workers, of coal, must in the end be driven to the necessity of rousing themselves in their own defence, for the benefit of their suffering workmen, and of their own interest.

It would, Sir, require but few arguments to prove that the system of mystery which they are anxious to preserve, so far from enhancing the value of their concerns, must, in every point of view, operate to its depreciation; and that the tendency must, instead of diminishing, be every day increasing. It would also be easy to show that the only mode left of averting the ruinous finale to which the whole is hastening, is to promote, and even to invite, investigation and publicity. But, Sir, it is unnecessary, if I were capable, which I certainly am not, of writing a dissertation on coal-mines. The subject is not new; and in the present state of our information there is scarcely any thing very interesting to be offered on it. The whole that I intend at present is to draw your attention, and, through your means, the attention of the public, to certain points in the economy of coal-mines, which are already known, from which I am inclined to think advantage may be derived, if they should come to be improved with that eagerness and energy which their importance so justly demands. I shall advert to these in the order they occur to my mind, without much adherence to methodical arrangement.

*Fire-damp*, or, in scientific language, the explosion of carbureted hydrogen, as being the most frequent, apparently the most destructive, and (as in the present instance) the most recent, cause of mortality in our coal-mines, naturally and forcibly claims precedence. It is to the prevention of this occurrence that the principal attention has been directed; yet, notwithstanding all that has been done, the security against its ravages is still very imperfect. The generation of carbureted hydrogen, from whatever cause it originates, is so incessant and so enormous, that with all the perfection to which ventilation has hitherto been carried, it is found altogether impracticable wholly to guard against those tremendous subterranean combustions, the effects of which produce lamentation, and woe, and misery, to all in their immediate vicinity. Two years ago a society was established in Sunderland for the express purpose of preventing accidents in coal-mines. Its first Report was lately published, containing a letter addressed to Sir Ralph Milbanke, the President, by Mr. John Buddle, who is, I understand, deservedly considered one of the most scientific and experienced coal viewers in this quarter.

That letter contained an account of the methods most generally pursued of ventilating coal-mines, accompanied with draughts illustrative of the different descriptions. From these one may form a very accurate notion of the principle upon which the ventilation proceeds, and that it of course depends upon a thorough circulation of atmospheric air being kept up through all the different coursings and workings of the mine. So rapid, however, is the ordinary accumulation, and sometimes so unexpected is the accession of inflammable gas, that with all the apparatus of ventilation in the most complete condition, it is a matter of no small difficulty to keep the air in circulation in a state fit for the various purposes, or in the language of miners, to prevent it from reaching the *firing point*, or point of hydrogenous impregnation at which it explodes when brought in contact with the flame of a candle. The slightest interruption to the regular transmission of atmospheric air, or the least unlooked-for addition of carbureted hydrogen, exposes the lives of the miners to the most imminent jeopardy, and the mine itself to the risk of total destruction. It would appear that as far as mechanical means are adequate to the end, ventilation has reached the utmost point of perfection of which it is susceptible. Mr. Buddle in some measure stakes his reputation as a viewer on the opinion, that any further advancement in the discovery of mechanical powers for the ventilation of collieries is unattainable. His words are: "On the strength of my own experience in collieries thus circumstanced, I freely hazard my opinion, that any further application of mechanical agency towards preventing explosions in coal-mines would be ineffectual; and therefore conclude that the hopes of this Society ever seeing its most desirable object accomplished must rest upon the event of some method being discovered of producing such a chemical change upon carbureted hydrogen gas as to render it innocuous as fast as it is discharged, or as it approaches the neighbourhood of lights. In this view of the subject, it is to scientific men only that we must look up for assistance in providing a cheap and effectual remedy." (Report, p. 23.) These positions, though perhaps not very accordant to the genuine spirit of philosophy, as tending rather to repress than to animate the zeal of discoverers, may in the present case be assumed as principles for the purpose of simplifying and facilitating the discussion. By the publication, therefore, of Mr. Buddle's letter in the Report alluded to, our knowledge of this part of the subject may, in one respect, be considered as having not only advanced a step, but our perceptions of what we do know, and of what remains to be done, are rendered more clear and precise. According to this view, then, we may be said to have arrived at a fixed point. We have reached, as it were, a spot from which we can see more distinctly the route to be pursued. A person, in every respect qualified to pronounce a deliberate and decided opinion, has declared that all further attempts at improvement in what may be called the mechanism of ventilation will prove abortive, and that it is to scientific men that we are to trust.

for the discovery of some chemical agent which shall condense or neutralize, or in some way or other render harmless, the destructive substance as fast as it is disengaged.

But, Sir, in order to give the investigation of the subject by men of science any chance of being prosecuted with success, it is indispensably necessary that some inducement should be held out. It would be to draw on philosophy or philanthropy to a much greater amount than either will be found to bear, to suppose that scientific men, from the mere impulse of benevolence, or love of the subject, are to engage in a course of laborious and costly experiments, for the purpose of finding out that which, though it would unquestionably gratify the feelings of every true friend of science, as well as of humanity, would be attended with no decided advantage to the discoverer himself. I am aware it has been said, by a writer whose authority stands deservedly high, that "in the present state of our knowledge, an infallible method of obviating by chemical means the deplorable catastrophes which occur in coal-mines, is a hopeless acquisition; and that to hold forth any such proposal, with confident pretensions, would be the boast of empiricism, and not of science."\* It has also been urged, that the limited power which art has, or even can be supposed to exercise over the mightier operations of Nature, leaves little room to expect that any thing can be done by chemical means to controul the powers of the latter in any considerable degree. Between these discouraging opinions, and the one promulgated by Mr. Buddle, which forbids us to look for any further mechanical means, we should be left, were we implicitly to abide by them, in such a state of utter abandonment, as would go to preclude all endeavours to ameliorate the present system. To aduce, therefore, such dogmas as these, is to throw a damp upon exertion of every kind, by a species of cold-blooded doctrine, hostile both to feeling and to the interests of science, and which is the more likely to obtain credence from the respectable sources whence it derives its authority. In prosecuting this interesting subject, then, such gloomy and disheartening views must positively be discarded, and sentiments indulged in, which shall be more consonant to our hopes and wishes, and which shall afford to the mind a brighter and more satisfactory prospect. Chemistry has in our age made rapid and astonishing advances in the pursuit of truth; and calculating from past experience, it does not appear why such a discovery as that of preventing or counteracting the excessive generation of carbureted hydrogen, or of neutralizing it when formed, should be placed out of the reach of chemical research. Although art can certainly do little to regulate or subdue any of the more stupendous operations of Nature, yet in some extraordinary instances she has undoubtedly succeeded. Besides, the ventilation of a coal-mine is nothing more than the artificial adaptation of scientific principles to the successful accomplishment of a great practical result, and bears

\* Vide Reply to Dr. Trotter's Proposal for destroying Fire and Choak Damps.



little or no analogy to corresponding phenomena at the surface, where the power of restraining the currents of air is not within the guidance or governance of human agency. But even though the discovery of such means, as shall render innocuous the whole carbureted hydrogen generated, were to be granted as unattainable, still the finding out a substance capable of decomposing such a proportion of it as shall bring it more within the range of human management, need not on that account be despaired of. Let, then, some suitable encouragement be offered; such a reward as shall incite the learned in this branch of knowledge, to apply themselves sedulously to the detection of that which, while it will constitute so inestimable a benefit to the public, may be of signal advantage to the discoverer himself. Let the coal proprietors, and all concerned in coal-mines, subscribe a sum by way of premium, or bind themselves to pay it at any future period, to the fortunate individual who shall discover this great desideratum. In aid of such an object, let Parliament, on behalf of humanity and of the country, vote a certain sum; suppose 5,000*l.*, 10,000*l.*, or 20,000*l.*, in the same manner as is held out to the person who shall discover the longitude; a discovery, by the way, perhaps fully as problematical as the one now in contemplation. As connected very intimately with the accidents from *fire-damp*, those from *choak-damp*, or carbonic acid gas, next bespeak our attention. This substance, though not so ostensibly hostile to life, perhaps in point of fact destroys a far greater proportion of the miners than even the *fire-damp* itself. It is the opinion of Mr. Buddle, as we have already seen, that only one-fourth of the people below ground at the time the carbureted hydrogen ignites, suffer by the immediate effects of the blast. Those who survive are afterwards stifled, before the mine can be entered, by the inhalation of foul air; and a great part of this foul air consists of carbonic acid gas, formed by the chemical effects of the explosion. In reality, therefore, the consideration of the subject of *choak-damp*, though not so immediate, is not less important than that of *fire-damp*. It need not, however, be enlarged upon in this place, as a similar experimental inquiry to that already suggested is requisite, and probably would lead to the detection of the means of preventing its formation. In truth, as the presence of a great part of the carbonic acid gas is a necessary consequence of the chemical action produced by the ignition of the carbureted hydrogen, the prevention of the one must infallibly obviate the generation of the other.

Another fruitful source of fatal disasters in our collieries is *water*. By the last accident from this cause at Heaton Colliery, it is well known that no less than 75 men and boys lost their lives. Some of these were doubtless immediately drowned by the rapid influx of the water; but others were, in all probability, doomed to one of the most lingering and horrible deaths of which the mind of man is able to form any conception. Entombed alive in the earth, at a depth of 500 or 600 feet; shut out from all communication with



those at the surface; driven, in their search of refuge from the roaring flood, to seek shelter in some of the more elevated parts of the mine; there, if they succeeded in escaping the torrent for the moment, to lie in darkness and despair, some of them perhaps in solitude, conscious that every hope of being rescued was for ever cut off, waiting the approach of the water to swallow them up; or the equally certain ravages of hunger or suffocation; no sound to be heard but the dying groans of their companions. Great God of mercy! what a situation for human beings to be reduced to! The imagination turns away with sickening horror and affright from the picture which itself has drawn; and the only hope which even the most benevolent heart can cherish, with any degree of patience composure, is, that the noxious air, or submersion in the water, must have speedily put a period to their miseries by terminating their existence.

An event of a similar description is said to have taken place in this neighbourhood about 30 or 40 years ago. The manner in which this accident happens is sufficiently well understood, and may be easily conceived. Throughout the greater part of the Tyne and Wear district there are innumerable wastes, or spaces, left by the former working out of coal seams. These old workings, on account of the deficient means, both chemical and mechanical, possessed by our forefathers, are, generally speaking, shallow, when compared with the depth to which the operations in what is called the *Low Main* now penetrate. They therefore now constitute so many cisterns, into which the water from the surface, and from other sources in the silent and stupendous laboratory of Nature, is perpetually filtering; till at last there come to be collected prodigious bodies of water, which in general overlay the stratum of coal in which the more modern workings are carrying on. From uncertainty respecting the vicinity of these wastes and aqueous reservoirs, from tenderness or want of power in the wall or roof of the mine, to support the lateral or superincumbent pressure of the water, or, still more, from ignorance or rashness in the workmen in approaching too near to these vast accumulations, the side or roof of the mine gives way, and the overwhelming inundation takes place. Against such an awful and ruinous occurrence there neither is, nor probably can there be, provided any effectual safeguard. Yet much may be done by way of precaution: and here I must take the liberty of mentioning a plan which was brought forward with this view by Mr. Thomas, of Denton, near Newcastle, so far back as the year 1797. A paper by this Gentleman on the subject of establishing an office in Newcastle for recording plans and other particulars respecting coal-mines was read at that time; but, from some unexplained cause, was never acted upon. On account of the increasing importance of the subject, this paper was again read at the last meeting of the Literary and Philosophical Society of this place, held on the 6th inst., and was ordered to be published, together with supplementary observations by Mr. Wm. Chapman,

civil engineer, calculated to put the whole into such a train as shall enable the public to avail themselves of the advantages comprehended in the proposal. It would only be to anticipate the contents of the intended pamphlet, were I now to enter upon any details. I shall, therefore, merely observe, that the plan seems admirably well suited to a most humane and useful object, and will, I should hope, meet with every encouragement.

There are one or two points more to which I wish to allude, as meriting more notice than has yet been bestowed upon them. One of these is the state of discipline which obtains in coal-mines. It is an acknowledged truth, that the various unfortunate events in our collieries, though passing under the general denomination of *accidents*, are frequently, if not always, brought about by circumstances to which the epithet *fortuitous* can scarcely be applied. In those instances where the escape of any of the miners affords an opportunity of ascertaining the particulars, the accident can generally be traced to have originated in want of science in some of the immediate superintendents, or ignorance of the workmen, or want of attention in the boys, to whose care are entrusted some of the most important arrangements,\* but more especially still, in most reprehensible and over-weening confidence in all, which being translated, means nothing more or less than the grossest *carelessness*. In fact, this latter circumstance may, to a certain degree, be regarded as the primary cause of all the mischief that happens. Unless, therefore, some method be devised for preventing relaxation in the discipline, and for instituting some reformation in the interior economy of the mines, it is obvious that all other means, however perfect, must come lamentably short of their intended effect. This desirable change, however, can hardly be effected but by Legislative interference, which it would consequently be for the interest of all parties to see exercised.

Another most essential object would appear to be to establish some efficient method of alarm amongst the inhabitants of the mine. From the accounts received from the survivors of the late terrible catastrophe at Heaton colliery, it is evident that had a more perfect system of alarm, as well as of discipline, prevailed, a considerable proportion of the unfortunate miners might, nay would, have been saved. Indeed, it is easy to imagine how it may happen that a workman, or set of workmen, in any particular district of a colliery, shall have satisfactory evidence of approaching danger, and save themselves by rushing to the shaft, while they have no means of giving timely warning to others working at the distance of perhaps more than a mile from them. This actually happened at Heaton. The men who were working at the fatal spot where the

\* Mr. Biddle defines a *trapper* to be "the person, generally a boy, who opens and shuts the doors. The trappers have seats near their doors, and remain by them all the time the pit is at work. This is the first branch of pit work the boys go to." (Report, p. 26.) It is of some consequence here to know that these doors, which these children are employed to watch, are the apertures through which the air is transmitted; in other words, they appear to be the *main channels of ventilation*.

water burst through extricated themselves by hastening to the shaft, but before the alarm could be spread to the more distant parts of the mine, where most of the men appear to have been at work, the water had formed an impassable barrier, and deprived them of all chance of retreat.

It may also occur in a similar manner, with respect to explosions of carbureted hydrogen, that men working at a certain part of the pit may be aware of danger from the state of the air in their immediate neighbourhood, and though not able to save themselves from injury or death, may by early alarm be the means of saving some of their comrades nearer the shaft, many of whom are sacrificed simply from not knowing that danger is at hand. For the purpose, then, of the better guarding against these evils, might it not be advisable and proper to have established throughout the mine a series of speaking trumpets, or alarm bells, arranged in such order as should convey with the greatest possible celerity intimations of danger to its various departments?

These, Sir, are all the remarks which occur to me at present, as worth while to trouble you with. There are many other contrivances which might be proposed, and which might be adopted, with increased security to the miners, and certainly, at a very moderate cost to the proprietors. But I fear I have already trespassed at too great length to presume to encroach any further. One observation there still remains to be made, that will apply to all these different causes of the loss of so many valuable lives, and it is this, that the accidents resulting from them in coal-mines must be daily becoming more frequent. From the very nature of the case, the more numerous, deep, and extensive, the excavations become, the greater must be the difficulty of avoiding wastes and old workings, where reservoirs of carbureted hydrogen, of carbonic acid gas, and especially of water, are in a state of unceasing accumulation. In a word, the subject is assuming a fearful importance, and must very soon extort from the public, and particularly from those more nearly interested, that attention which hitherto seems to have been partly withheld from it.

I am, Sir, your most obedient servant,

Newcastle-upon-Tyne,  
June 13, 1815.

Φιλαιγαθος.

---

## ARTICLE V.

*An Account of the Sunderland Lime-stone Formation.* By W. Reid Clanny, M.D. M.R.I.A. of Sunderland.

(To Dr. Thomson.)

DEAR SIR,

Sunderland, June 12, 1815.

WHEN I had the pleasure of your short visit last summer, I forgot to show you the Pallion lime-works, the property of John

Goodchild, Esq. which are situated upon the Wear, about a mile up the river from this town. They are the deepest wrought of the Sunderland lime-stone formation, and are of great extent and value.

I have taken some pains in examining the Pallion lime-stone, assisted by those persons who were best qualified to give me the requisite information; and the following sketch, which I have drawn up for the *Annals of Philosophy*, will, I expect, be found worthy the perusal of your readers.

These lime-works have afforded employment for many years to a great number of quarry-men, lime-burners, and sailors, many of whom were so advanced in years that they had little chance of constant employment elsewhere. The works are conducted with the greatest care and regularity; and a steam-engine of considerable power is in constant use, to draw the lime from the quarry to the kilns. Whether we consider the *extent* or the *order* in which the different operations are carried on, the Pallion lime-stone must be always considered as an object of much interest and curiosity.

The following are the strata of Pallion quarry:—

Soil, from a foot to two feet.

Marl, containing small pieces of lime-stone of a cream-yellow colour, 25 feet.

A stratum of common compact lime-stone 18 feet in depth, colour white, through which are observed a few horizontal stripes of ochre-yellow. It is massive; fracture even, inclining to large conchoidal; translucent upon the edges; brittle; easily frangible; not particularly heavy; may be scratched with fluor spar, but not with the nail. Several horizontal indentations, slightly crystallized, run through this stratum, in some places having the appearance of dovetailing, and in others resembling the sagittal suture of the human cranium. From the chemical trials which I have made, I find that this stratum contains no magnesia.

The second stratum of lime-stone is 35 feet in depth, colour ochre-yellow, with very frequent clouds of bluish-grey. The ochre-yellow is soft, giving to the touch the sensation of indurated marl. The bluish-grey is very hard and compact; of course the fracture of this stratum of lime-stone is very uneven. This stratum contains magnesia, though in no great proportion.

The third stratum of lime-stone is three feet in depth; colour cream-yellow, having many small spots of ochre-yellow interspersed; texture uniform; fracture conchoidal; translucent upon the edges; hard; not brittle; cannot be scratched with the nail, but readily with fluor spar. In this stratum the remains of a flat fish was found, a drawing of which I have taken for you: (see Plate XXXVII.) and near the remains of this fish I have discovered several shells, which are in such a state of mutilation that even with a good magnifying glass it appears impossible to refer them to any class, in which opinion I am supported by a well-informed conchologist of this place.

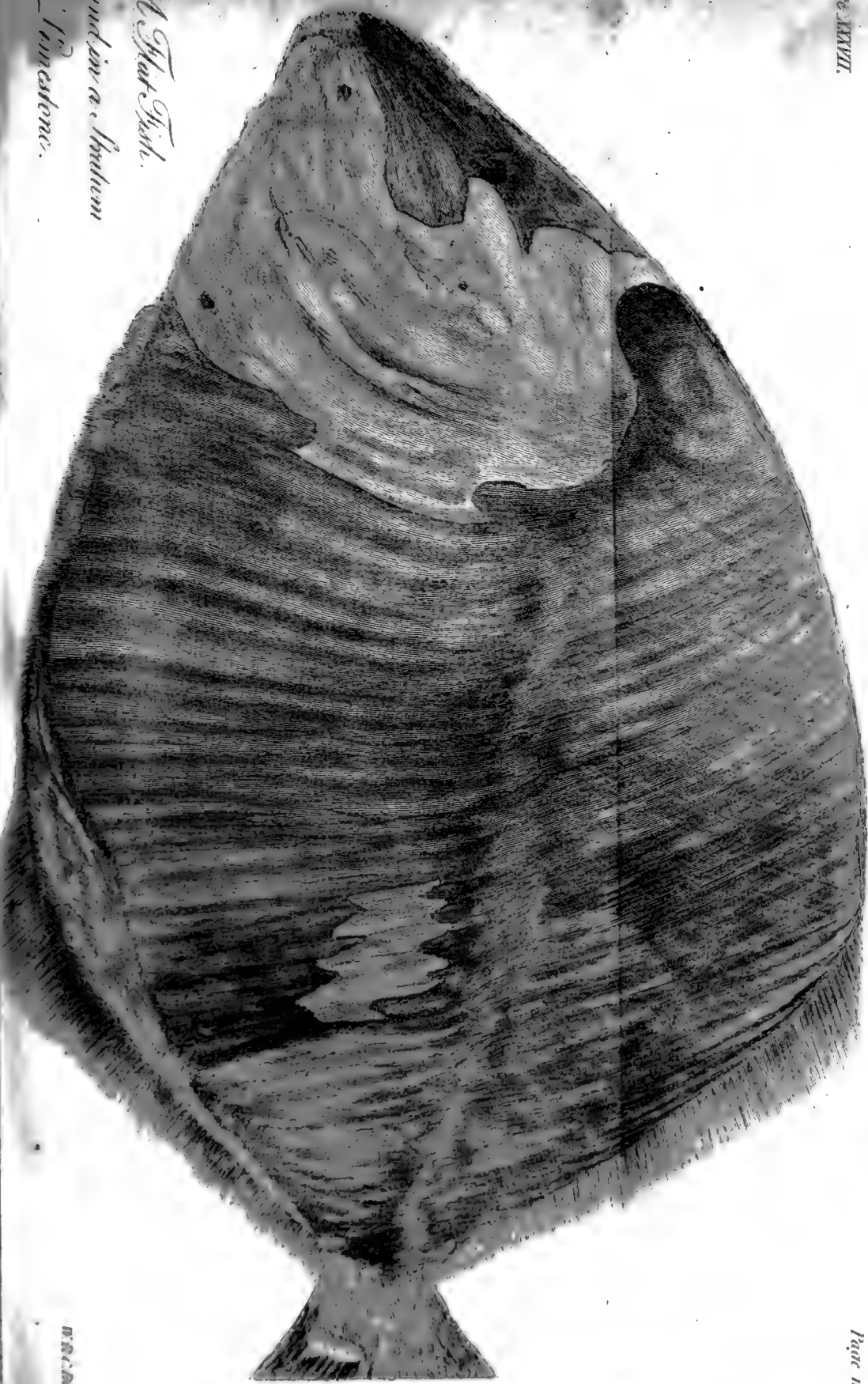

*A Flat Fish.  
found in a Harbour  
of - Amsterdam.*

Goodchild, Esq.  
up the river from  
Sunderland lime  
value.

I have taken  
assisted by those  
quisite informatio  
up for the *Annal*  
the perusal of yo

These lime-w  
great number o  
whom were so a  
stant employmen  
greatest care an  
power is in cons  
kilns. Whether  
different operati  
always considere

The following  
Soil, from a f  
Marl, contain  
colour, 25 feet.

A stratum of  
colour white, th  
of ochre-yellow.  
conchoidal; tra  
not particularly  
with the nail.

lized, run throu  
ance of dovetail  
the human crani  
I find that this st

The second  
ochre-yellow, v  
ochre-yellow is  
marl. The blue  
fracture of this  
contains magnes

The third str  
cream-yellow,  
spersed; texture  
the edges; hard  
but readily with  
fish was found,  
Plate XXXVII.  
covered several  
that even with  
refer them to a  
well-informed c





The lime-stone of this stratum has been much in request for the sculpture of coats of arms for mansion-houses.

The fourth stratum of lime-stone is worked to the depth of 17 feet, and is the lowest at present wrought. I shall have occasion to offer some remarks afterwards at the conclusion of this paper, when I shall mention the depth of this stratum where it was worked through in sinking a coal-pit shaft. The colour of this stratum is bluish-grey; it is massive; fracture conchoidal; fragments sharp edged; translucent upon the edges; cannot be scratched by the nail, though readily enough by fluor spar; it is hard, and not readily frangible; contains not more than five per cent. of magnesia.

About two feet from the bottom of the quarry, this stratum becomes so fine in the texture that it has been sculptured for ornamental purposes, and is well known under the name of the Pallion marble.

The Pallion lime is much valued, and is very extensively used for agricultural purposes along the whole eastern coast of England and Scotland. An observation of the late Dr. Anderson, in his excellent *Essays on Agriculture*, is so much in point, that I shall offer no apology for transcribing it:—"The only extensive lime-quarries of such a pure lime-stone that I have met with are at Sunderland, in the county of Durham."

The Pallion lime-stone, generally speaking, is hard; but when burnt, it is as light and soft to the touch as chalk-lime. This lime-stone accordingly loses much weight by calcination, and requires a large proportion of water to slake it.

In the year 1787 a coal shaft was sunk about half a mile southwest of the Pallion quarry, and upon the same estate. The same order and appearance of the strata were observed as in the Pallion quarry, that is, as far down as the latter quarry is worked, which is to the extent of 17 feet in the fourth stratum of lime-stone, as mentioned above. After this the shaft was carried through 64 feet of blue lime-stone, which became coarse, and of inferior value.

Immediately below this stratum of lime-stone the shaft was worked through a stratum of dark slate-clay alternating with blue slate-clay, which was 240 feet in depth. The shaft was next passed through a mass of green-stone (the whin-stone of this county) and clay-slate to a considerable depth.

Mr. Goodchild has lost the memoranda which were taken when the shaft was sunk; but you may rely upon the accuracy of the above statement, as I had it from himself.

I am, dear Sir, your faithful friend,

W. REID CLANNY.



## ARTICLE VI.

*Sketch of a General Theory of the Intellectual Functions of Man and Animals, given in reply to Drs. Cross and Leach. By Alexander Walker.*

(Concluded from p. 34.)

ON the subject of the cerebellum, I have only to add, that all the observations which Drs. Gall and Spurzheim have adduced to prove that it is the organ of amativeness, are accountable from the circumstance that the degree of physical love seems to be more or less connected with the degree of voluntary power—the proper function of this organ: and hence it is that the man, the stallion, and the bull, having more voluntary power, have also more amativeness and a larger cerebellum than the eunuch, the gelding, and the ox. With this modification—considering the cerebellum not as the *organ*, but as a convenient *sign*, of amativeness, the general theory which I now deliver of the nervous system is in perfect harmony with the more particular doctrine of Gall and Spurzheim as to the cerebral organs.

My former brief paper being entitled, On the Use of the Cerebellum and Spinal Marrow, it was less to the structure of these parts (which I conceived to be sufficiently well known) than to their use that I referred. In particular, I meant to lay no claim to the first observation of the division of the spinal marrow, either on the ground of its having lateral fissures, asserted by Soemmerring, who, however, will no doubt now abandon his opinion, since Dr. Leach “has carefully examined the structure of the spinal mass of nerves,” or on a ground which is, I believe, peculiar to myself, that these columns being laterally separated by cineritious matter, that substance serves the purpose of insulating them from each other, and serves a similar purpose, and no other, throughout the brain. Even on this ground, which I believe to be the best one, however peculiar it may be, it was not my intention to claim the observation; but it was my intention to consider as my own, the observation that the anterior columns (in which end the anterior spinal nerves) terminate in the cerebrum, while the posterior columns (in which begin the posterior spinal nerves) commence in the cerebellum; as well as that the anterior may be termed the ascending columns and nerves, and the posterior the descending—that the former may be called those of sensation or impression, which, to be cognizable to the brain, must ascend from by far the greater part of the surface of the body; and that the posterior may be called those of volition or expression, which, to affect almost all the muscles, must descend from the head. And, to say the least of it, this is rendered highly probable by the circumstances that sensation and volition—an ascending and a descending motion cannot possibly take place in

the same fibrils of the same nerve; that consequently all nerves, having at once sensation and volition, divide into two series of fibrils on joining the spinal marrow, namely, an anterior series and a posterior one; that the anterior series is, in form and structure, totally different from the posterior; and that the spinal marrow, divided as it is by fissures and by cineritious matter, does really form four columns which are joined by these series, viz. the anterior columns, by the anterior fasciculi, and the posterior columns, by the posterior fasciculi.

In reply to my statement, that the anterior columns join the cerebrum, and the posterior the cerebellum, Dr. Leach says, "Gall and Spurzheim have shown that the brain and cerebellum cannot be considered as the continuation of the spinal marrow, any more than the spinal marrow can that of the brain and cerebellum." This reply the Doctor no doubt thinks decisive; and as I have shown that he has rather too hastily, and without reason, called my anatomical and physiological statement inaccurate, I must now inquire into his. The argument, then, which he here adduces, from whatever source derived, is a bad one, because it proves a great deal too much, as the following observation will show.—Various parts, then, of the body, have been generated separately in the uterus or ovaria, as hair, teeth, limbs, &c. Now, in the case of the lower part of the body or the lower extremity being generated alone or detached from the superior parts, the generated parts would contain vessels as well as nerves—namely, an aorta and vena cava, or a femoral artery and vein. But, from the Doctor's argument, it would follow that, because in this case the lower parts of these vessels were produced separately from the upper, therefore, in the natural state, these parts are not continuations of each other! and that the aorta and femoral artery are not descending, and the vena cava and femoral vein ascending!\* Such, then, are the precise and "accurate" arguments employed by Dr. Leach to prove that the anterior columns and their nerves do not join the cerebrum, and the posterior the cerebellum.

In reply to my statement, that the anterior of the nervous fasciculi which join the spinal marrow are not nerves of sensation, nor the posterior nerves of volition, Dr. Leach, instead of proving my inaccuracy, places upon record a most astonishing specimen of his own!—Dr. Leach says, "The two roots of nerves of each half of the spinal marrow, namely, the anterior and posterior, go to different parts of the body:—the muscles and skin of the back receive their nerves from the posterior roots, whilst the muscles and skin of the abdomen receive theirs from the anterior roots, and yet the fore and back parts of the body have sensation and voluntary motion." Now certainly if this were but true, my doctrine would be not

\* This argument is not limited to the separate production of one part of the body, as the trunk, or the lower extremity; but obviously applies to any part which may ever have been separately produced, and even to all degrees of mutilation.

merely inaccurate, but altogether false; for this would prove, that both roots were at once nerves of sensation and of volition: but, not being true, the case is certainly somewhat altered. Unluckily for Dr. Leach, it is his own statement which is inaccurate. In his "careful examination of the structure of the spinal mass of nerves," the Doctor has absolutely mistaken the *branches* for the *roots* of these nerves! It is from the branches that the nerves he alludes to go off; for, however lucky this may be for humanity, since it prevents our moving with only one half the body, and feeling only with the other, it is certainly unfortunate for the Doctor's argument that neither to skin nor muscles is the slightest twig given from the roots. These roots then combine, communicate, and even cross by twigs, in order to form a trunk; and, that the Doctor may not be put to the trouble of another "careful examination," if he will only cross the fingers of one of his hands between those of the other, he will have a tolerable conception of the trunk so formed, remembering, however, that only about half the fibrils of either root do so cross, while the other half, instead of crossing to the opposite branch, runs onward in the branch of the same side. A rather greater number of fibrils, indeed, pass from the posterior root to the anterior branch than from the anterior root to the posterior branch, because the anterior branch, being destined to supply a greater portion of the body, requires to be larger. I do not find this decussation described in *any anatomical book*, which I have at hand; but the slightest inspection will demonstrate it. The law of this decussation is maintained even in very inferior animals; for, in those which have no vertebræ and in which the spinal marrow is formed below the œsophagus by the union of the two crura of the cerebellum, though the two fasciculi generally remain distinct throughout the greater part of their length, yet they always unite at different spaces by knots whenever a nerve is given off! Thus *each branch* is composed from *both roots*: and it is only from the branches thus *composed*, and by no means from the roots, that the nerves the Doctor speaks of are distributed: hence it is not wonderful that they give *both* sensation and voluntary motion. These *branches*, however, the Doctor calls "the two roots of nerves of each half\* of the spinal marrow, namely, the anterior and posterior;" and asserts, as is seen above, that these identical roots of *each half* of the spinal marrow "go to different parts of the body!" Every anatomist and every anatomical work declares that from the roots no twig proceeds either to skin or muscles; and if it were not obvious that the Doctor had mistaken the branches for the roots, I should be apt to think that, in his "careful examination of the structure of the spinal mass of nerves," the Doctor had refuted the whole of them.

I have now to mention, that even some of those anatomists who

\* Thus, too, the Doctor after all allows that there are a sternal and dorsal half of the spinal marrow.

succeeded Willis conjectured that there were cerebral and cerebellic nerves. They indeed only conjectured this; and they, moreover, erred by distinguishing them into vital and animal. The vital nerves, said they, are chiefly derived from the cerebellum, and the animal from the cerebrum.—They have *believed*, says Haller, that several nerves have roots partly from the cerebellum. But Haller objects that the fifth pair arising, as he says, from the cerebellum, is appropriated both to sense and to motion; “nor would,” says he, “Nature have so solicitously blended both species of nervous fibres if their nature had been different,” and if, he might have added, they had been destined to supply totally distinct parts of the body. He shows also, that some of those nerves which they believe to have some origin from the cerebellum, have nothing to do with vitality; and he adduces various other objections. Speaking of the possibility of fibrils of different kinds being in the same nerve, Haller also says, “*Infinitum ad infinitissimum possis deponere, falli hominem, qui Dei consilia voluerit conjectura expiscari.*” Even Haller, however, when speaking of the double series of roots of the spinal nerves, involuntarily allows some connection of that kind; for he says, “*quarum anterior altera in eodem cum cerebralibus nervis ordine pergit, posterior medullæ propria est, et demum sub fine quarti ventriculi incipit.*”

In proof, however, that the sensitive and motive nerves are perfectly distinct, I can quote for Dr. Leach a much better authority than that of any old author: first, that of reason, which tells us, that as sensation cannot reach the cerebrum without an ascending motion—a motion towards the brain; as the consequent volition cannot affect the muscles without a descending motion—a motion from the brain; and as it is contrary to all analogy that there should be motion in opposite directions in the same tubes of neurilema—for these reasons, there must be a series of nerves appropriated to each: and, secondly, the authority of anatomy, which shows us that, though nerves supplying parts which are contiguous in position but different in nature often run in one common sheath, yet on arriving at the spinal marrow they split into two roots, as they are termed; that these roots are quite different in form, the anterior being more fibrous, and the posterior more simple and round; that the anterior roots join the anterior columns of the spinal marrow, and the posterior roots the posterior columns; that these columns actually do join the cerebrum and cerebellum respectively; and that even those cerebral nerves which are at once nerves of sensation and volition have two roots, one from the cerebrum, and another from the cerebellum. This may be most easily observed in the seventh pair or facial nerves, the origin of which has hitherto been mistaken by all anatomists. They directly penetrate the medulla oblongata from its lower to its upper surface; and, throughout this very considerable internal passage, each nerve consists of two perfectly distinct, silvery and glistening cords, of which one joins the cerebellum, and the other runs onward to the cerebrum. This may

easily be seen by any anatomist who chooses to look at the subject itself, instead of only making such a "careful examination" as Dr. Leach last instituted on "the spinal mass of nerves."

The views which I have now taken enable me to answer a most important question on this subject, which has twice been put by Soemmerring. After stating the opinion that the use of the ganglia is to place certain parts out of the power of the will, or to change voluntary into spontaneous motions, he asks why the spinal ganglia are formed only on the posterior roots—"Qua causa est," says he, "cur in radice posteriore tantum nervorum spinalium ganglia inveniuntur, minime autem in priore?" And again, "Cur radix prior nervorum spinæ medullæ, adeo vicina, ganglia non immiscitur?" The obvious answer to these two questions is, that the anterior roots, as stated above, have nothing to do with motion—are those of sensation alone; while the posterior, being those of motion, it is on them alone that ganglia can be necessary to impede the impulse of the will, or to change, in some of their fibrils, voluntary into involuntary motion.

Now as in this situation, ganglia impede voluntary motion, so in others do they impede sensation, and prevent the brain being disturbed by all the impressions on the viscera, which would have been incompatible with thought. Such, then, are the ganglia of the viscera, &c.; for wherever the anterior spinal branch communicates with the great sympathetic, there is a ganglion at the place of this union. Thus there are ganglia of sensation as well as ganglia of motion; and these ganglia are always as near as possible to the origins of their respective nerves:—in other words, as these sensitive or ascending nerves originate from the internal surfaces of the body, their ganglia, which prevent sensation reaching the sensorium commune and becoming perception, are placed nearer to their system—the great sympathetic nerve, and the organs from which they arise; and as the motive or descending nerves originate from the cerebellum, their ganglia, which prevent volition reaching certain muscular parts, are placed nearer to their system—the cerebellum, &c. That the ganglia are admirably adapted thus to impede sensation, as I have stated, and volition as conjectured by Johnstone, and confirmed by these remarks, is evident from the observation of Cuvier, that the ganglia of red-blooded animals do not differ much from nervous plexus; that even the simple ganglia, or those formed by a single nerve, are resolved by maceration into several filaments which anastomose together; and that in the crustacea, insects, and worms, the ganglia are mere homogeneous enlargements of the medullary cord to which they belong. All of these circumstances are well adapted to impede the motion which takes place in them—a motion, however, which is only of this kind, that each globule communicates its impulse to a succeeding one; and, as the last of a series of globules must thus move the instant that the first is impelled, the extreme velocity of nervous action is thus conceivable. It does not follow, however, that all the

fibrils of nerves on which ganglia are formed belong to impeded sensation or impeded (involuntary) motion; for, in the ganglia, many nervous fibrils are seen running over the whole length of the ganglion, and forming no involvement with it. This circumstance of there being two kinds of ganglia will be found to obviate many difficulties which have hitherto attended the physiology of these bodies.

The leading heads, then, of this new system of the intellectual functions are as follows:—

1. That the nerves of sensation arise in the organs of sense, and, by means of the anterior fibrils, terminate in the anterior columns of the spinal marrow.

2. That those nerves of sensation which do not terminate in these columns, pass directly to the cerebrum.

3. That the anterior columns of the spinal marrow terminate also in the anterior part of the cerebrum.

4. That these nerves and columns are the sensitive or ascending nerves and columns.

5. That it is in this way that sensation becomes perception, and that are excited in the cerebrum the faculties analysed by Gall and Spurzheim.

6. That the cerebral influence passes to the cerebellum by means of the corpora striata posteriora or thalami, the anterior peduncles of the cerebellum, &c.

7. That the cerebellum is the organ which gives impulse to all muscular motion, voluntary and involuntary.

8. That the posterior columns of the spinal marrow originate in the cerebellum.

9. That from the cerebellum arise also several nerves of volition.

10. That those nerves of volition which do not arise directly from the cerebellum, spring from the posterior columns of the spinal marrow by means of the posterior fibrils.

11. That these nerves and columns are the motive or descending nerves and columns.

12. That as there are two great encephalic organs, two anterior and two posterior columns of the spinal marrow, and two series of nerves, so there are two series of ganglia—ganglia on the sensitive and ganglia on the motive nerves.

13. That the intensity of the intellectual functions is as the length of their organs, and the permanence of these functions as the breadth of their organs.

I believe that not one of these statements were ever made by any one before they were made either here or elsewhere by myself; but should *any* of them have been previously made on any rational ground, I shall feel no pain in resigning the merit or demerit of their discovery to its proper author. Still less, of course, has the general system which I now advance been thought of by any one.

It appears, then, that there is a species of circulation in the nervous system, of which I have sketched the general course, as curious and admirable as that which exists in the vascular (the



centre of the one being the heart, and of the other the head); and that there is scarcely any point of the body which this circle does not involve and rest on, since from almost every point ascends impression to the cerebrum by a nerve of sensation, the anterior nervous roots, and the anterior columns of the spinal marrow; and to each returns expression from the cerebellum by the posterior columns, the posterior nervous roots, and the nerves of volition. Nothing perhaps more than this beautiful correspondence between the vital and intellectual systems is calculated to raise the mind to him of whom the wisdom is testified by all that lives, from the most simple to the most complex of beings—from the polyp which can boast no other organ than a stomach, to man who has an intellectual system thus wonderfully complex and beautifully symmetrical.

Having, Sir, been long engaged in dissections of the brain of fishes, amphibia, and birds, in order further to illustrate and establish these important truths, I shall, on their conclusion, be happy to communicate them through the medium of your Journal. But you will excuse my in future not replying to statements so hastily made as those in answering which I have been reluctantly compelled to occupy so much of your present number—statements in which a confident reference is made to a book for a doctrine which that book, on the contrary, most pointedly contradicts; and to the animal body for a structure which has no other foundation than in the writer's mistaking the branches of a nerve for its roots.

I am, Sir, with great respect,

Your most obedient servant,

ALEXANDER WALKER.

## ARTICLE VII.

*A Memoir on Iodine.* By M. Gay-Lussac.

(Continued from vol. v. p. 413.)

### *Observations on Chlorine.*

THE analogy which I have established between chlorine, sulphur, and iodine may serve to throw some light on some of the combinations of chlorine, as I shall endeavour here to show.

M. Thenard and myself were the first persons who showed by a numerous series of experiments, that oxymuriatic acid might be considered as a simple substance, as there was no direct means of showing the presence of oxygen in it. We had even given this hypothesis at full length, in a memoir which we read to the Society of Arcueil, on the 26th of February, 1809; but it appeared so extraordinary, that M. Berthollet prevailed upon us to state it with the greatest reserve. In fact, though Davy has announced in his memoir on oxymuriatic acid, that this hypothesis had been advanced by Scheele, it was entirely new, and it appeared extra-



ordinary only because it was in opposition to a manner of thinking fortified by long habit and by many good experiments. It was making a great step towards the knowledge of the real nature of oxymuriatic acid, to have questioned the received opinions respecting the nature of this acid: for it is much easier to find a new truth than to detect an old error. And we claim it as our own property, that we first perceived that oxymuriatic acid might be considered as a simple body. Davy, in adopting the conclusion which we had drawn from our experiments, has added nothing to its certainty; but we must admit that he has illustrated it at great length, and by the influence of his great abilities, has contributed very much to propagate it. I ought to observe, however, that M. Dulong and M. Ampere had adopted it long before Davy, and that I myself had always stated it as the most probable opinion, in the courses of chemistry which I delivered at the Polytechnic School. At present the discovery of iodine appears to have fixed the opinion of the French chemists on the nature of oxymuriatic acid. I shall therefore refrain from all discussion on the subject.

Admitting then that oxymuriatic acid is a simple body, it becomes in the first place necessary to introduce a modification into the proportions of the muriates. But as this does not follow immediately, from oxymuriatic acid being a simple substance, it may be necessary to justify it. Admitting a muriate to be a combination of muriatic acid and an oxide, it is possible that the hydrogen of the acid and the oxygen of the oxide may not form water; but may remain in the salt. I exposed in succession barytes, strontian, lime, and oxide of zinc, to the action of dry hydrochloric gas, in a glass tube, to a temperature approaching to a red heat, and I always obtained a great deal of water. To verify the same fact on potash, I put about a gramme of potassium in a platinum crucible, melted it, and plunged it into a glass vessel filled with hydrochloric gas. When the combination appeared complete, I weighed the crucible exactly, and then poured water on the salt, which occasioned no effervescence. The salt being dried in a low temperature, was found not to have increased in weight, nor after being fused was it found to have lost any thing. We ought then to admit it as a certain fact, that the muriates are all changed into chlorurets when melted, or even dried, and some of them even by being crystallized. We may suppose, as we have done for the iodurets, that the chlorurets dissolve in water without undergoing decomposition, and that when we unite hydrochloric acid with an oxide, the hydrogen of the acid and the oxygen of the oxide form water.\* Whether this be the case or not, nothing but chlorurets exist at a red heat. It is therefore of these compounds that it is necessary to determine the proportions.

I have found (*Mem. d'Arcueil*, ii. 168) that 100 parts of silver take 7.6 of oxygen. Berzelius instead of that number gives 7.44. Though it be difficult to say which is most exact, I shall adopt this

\* See Note A.

last number, and will admit further with Berzelius, taking the mean of his results that 100 parts of muriatic acid free from water combine with 424.92 oxide of silver.\* Now these 424.92 of oxide are composed of 395.50 of silver, and 29.42 of oxygen. And since in the muriate the silver is in the metallic state, we must, in order to have the weight of the chlorine, add that of the oxygen to the weight of acid which we supposed to be combined with the oxide. We shall thus obtain for the composition of chloruret of silver

Chlorine .....	100 + 29.42 =	129.42
Silver .....		395.50

Or Chlorine .....	100
Silver .....	305.59

Thus, having the proportions of the muriates, we must, in order to obtain those of the chlorurets, add to the quantity of muriatic acid that of the oxygen supposed to be combined with the base.

According to the preceding ratio, and the composition of muriate of potash, as found by Berzelius, namely :

Muriatic acid .....	36.566
Potash .....	63.434

The chloruret of potassium is composed of

Chlorine .....	100.
Potassium .....	111.310

And potash of

Potassium .....	100
Oxygen .....	20.425

I have adopted this last proportion, which differs but little from that obtained directly by M. Thenard and myself.

We find likewise from the same data, that the ratio of oxygen to chlorine is that of 10 to 43.99, or in round numbers 10 to 44. It is therefore nearly three times as great as that of oxygen to iodine. If from the ratio of oxygen to iodine and chlorine we seek the density of chlorine, on the supposition that that of iodine is 8.6095, as we found it above; we find that it is 2.427, instead of 2.421, which was deduced from the supposition that the specific gravity of hydrochloric gas is 1.247.

The great analogy which I found between iodine and chlorine ought naturally to lead me to believe that the salts known by the name of hyper-oxy-muriates, are analogous to the iodates; that is to say, that they are combinations of the alkali, with an acid composed of oxygen and chlorine.

It is easy to see that on this hypothesis the acid cannot be the gas found by Davy, and called by him euchlorine. Chemists are nearly agreed that 100 parts of hyper-oxy-muriate of potash, when

\* I found 418.2, Mem. d' Arcueil, ii. 168.

decomposed by heat, give out about 38·88 of oxygen, and that there remain 61·12 of what has been considered as neutral muriate of potash; but which is, in fact, chloruret of potassium. From the proportions given above, the 61·12 contain 28·924 chlorine, and 32·196 potassium. Now this quantity of potassium would take 6·576 of oxygen to convert it into potash. There remain, of consequence,  $38·88 - 6·576 = 32·304$  for the 28·924 of chlorine; hence the acid which I suppose to exist in hyper-oxy muriate of potash must be composed of

Chlorine .....	100
Oxygen .....	111·68

and the oxygen will be to the chlorine in a proportion five times greater than that which I have already given. It deserves attention that the proportion in weight of the potassium in the chloruret, ioduret, and sulphuret, is nearly the same as that of the oxygen in the chloric, iodic, and sulphuric acids.

According to Davy euchlorine gas contains one volume of chlorine and half a volume of oxygen; and taking 2·421 for the specific gravity of chlorine, we find that euchlorine is composed by weight of

Chlorine .....	100
Oxygen .....	22·79

This last number, multiplied by 5, gives 113·95, and though it differs from 111·68, we may, notwithstanding, conclude, that the acid existing in the hyper-oxy muriates, which I shall henceforth call *chloric acid*, contains five times as much oxygen as euchlorine gas.

If we dissolve chloruret of potassium (composed of 100 chlorine and 111·31 potassium) in water, and suppose that the water is decomposed, we will have hydro-chlorate of potash, admitting the oxygen to combine with the potassium and the hydrogen with the chlorine. But if we suppose the oxygen to unite with the chlorine, we form exactly euchlorine gas. I consider this gas formed by the combination of two parts in volume of chlorine and one of oxygen, as analogous to the protoxide of azote, which contains two volumes of azote and one of oxygen. Hence I propose to distinguish it by the name of oxide of chlorine. We may likewise distinguish by the names of *oxide of sulphur* and *oxide of iodine*, combinations of sulphur and iodine with oxygen, in the same proportions in volume. The first gives by weight about 10 oxygen and 20 sulphur; the second 10 oxygen and 156·21 iodine. I think it very probable that chlorous and iodous acids exist analogous to the sulphurous and nitrous, which ought to be composed of one volume of chlorine or vapour of iodine, and 1·5 of oxygen.

It appears to me demonstrated from the quantity of oxygen in oxide of chlorine, that this oxide does not exist in the hyper-oxy muriates. Davy, however, is of a different opinion, for he

says that "euchlorine produces the phenomena which Chenevix in his paper on oxymuriatic acid ascribes to hyper-oxymuriatic acid:" and that "it is probably combined with the peroxide of potassium in the hyper-oxymuriate of potash." But I shall demonstrate that this is not the case.\*

We must admit it as an incontestable principle, established by Berthollet, that an acid put into a saline solution acts on the base of the salt, and separates a portion of it from its acid. This principle holds especially with the strong acids when brought in competition with the weak acids. On the other side, we must recollect, that peroxide of potassium does not combine with sulphuric acid, and that as soon as these two bodies are brought in contact, oxygen is disengaged. Hence, if hyperoxymuriate of potash were produced by the combination of euchlorine with peroxide or potash, there ought to be disengaged oxygen gas, when diluted sulphuric acid is poured into a solution of this salt. Since at least the euchlorine, a gaseous oxide, whose acid properties, if it has any, are very weak, will be partly separated by the sulphuric acid, and this acid is incapable of dissolving peroxide of potassium. But no oxygen is disengaged, and consequently the potassium is not in the state of peroxide in hyper-oxymuriate of potash. Besides, even supposing potash super-oxygenated in the hyperoxymuriate, it ought to contain five times its usual quantity of oxygen, a conclusion which it would be very difficult to admit. The fact is, that potassium is in the same degree of oxydation in the hyper-oxymuriate as in the sulphate, as I shall now demonstrate, by giving an account of the real acid which forms the fulminating salts of chlorine.

In consequence of the above considerations, I was led to believe, that since sulphate of barytes is insoluble, and barytes is not super-oxydated in this salt, if sulphuric acid be put into the hyper-oxymuriate of barytes, it would be easy to see if oxygen be disengaged, and perhaps even to obtain chloric acid. I accordingly prepared a certain quantity of this salt, employing the ingenious process of Mr. Chenevix, and I obtained it easily in fine rhomboidal prisms, quite exempt from muriate. Into a diluted solution of this salt I poured weak sulphuric acid. Though I only added a few drops of acid, not nearly enough to saturate the barytes, the liquid became sensibly acid, and not a bubble of oxygen escaped. By continuing

\* In a preceding memoir on oxymuriatic acid, Davy appears to doubt the existence of an acid in the hyper-oxymuriates. He expresses himself in this manner. "If we consider with attention the facts concerning the hyper-oxymuriate of potash, we can only consider it as a triple compound of oxymuriatic acid, potassium, and oxygen. We have no sufficient motive to conclude that any particular acid exists in that body, or that it contains a considerable quantity of water. It is perhaps more conformable to chemical analogy, to suppose the great quantity of oxygen to be combined with the potassium, the very great affinity of which for oxygen we know, rather than to consider this quantity of oxygen as in a state of combination with the oxymuriatic acid, which, as far as we know, has no affinity for that substance. And from some experiments, I am induced to believe that potassium may combine directly with more oxygen than exists in potash."

to add sulphuric acid with caution, I succeeded in obtaining an acid liquid entirely free from sulphuric acid and barytes, and not precipitating nitrate of silver. It was chloric acid dissolved in water. Its characters are the following.

This acid has no sensible smell. Its solution in water is perfectly colourless. Its taste is very acid, and it reddens litmus without destroying the colour. It produces no alteration on solution of indigo in sulphuric acid. Light does not decompose it. It may be concentrated by a gentle heat without undergoing decomposition, or without evaporating. I kept it a long time exposed to the air, without perceiving that its quantity diminished sensibly. When concentrated it has somewhat of an oily consistency. When exposed to heat it is partly decomposed into oxygen and chlorine, and partly volatilized without alteration. Hydrochloric acid decomposes it in the same way at the common temperature. Sulphurous and hydro-sulphuric acids have the same property; but nitric acid produces no change upon it. I combined it with ammonia, and obtained a very fulminating salt, announced for the first time by Mr. Chenevix. With potash I produced hyper-oxy muriate with all its characters. It does not precipitate nitrate of silver nor any other metallic solution. It readily dissolves zinc, disengaging hydrogen; but it appeared to me to act slowly on mercury.\* This acid without doubt cannot be obtained in the gaseous state. As it contains five times as much oxygen as the oxide of chlorine, which is so easily decomposed, we cannot doubt that it is the water which keeps its elements united, as is the case with nitric and sulphuric acids. In this point of view the water acts the same part as the salifiable bases. But as it does not neutralize the bodies which it holds in solution, on account of the perfect equilibrium which exists between the acidifying properties of the oxygen and the alkalinizing properties of the hydrogen, and because its affinities are much weaker than those of the bases, it serves merely to unite the elements, and allows us to study the characters of the combinations which it forms, as if they were independent of its presence.

The theory of the chlorates will not now present any difficulty. They are salts formed by the combination of chloric acid with bases, and are entirely analogous to the iodates. Some obscurity, however, may remain about the circumstances of their formation, when an alkaline solution is saturated with chlorine. I shall therefore endeavour to throw some light on the subject. I shall commence by determining theoretically the ratio of the quantities of chloruret of potassium and chlorate of potash which form at the same time, and then I shall inquire if it agrees with that which experience gives.

\* It is composed of 1 volume of chlorine and 2.5 of oxygen, or by weight of 100 chlorine and 113.95 oxygen, supposing the specific gravity of chlorine to be 2.421.

I have already remarked, that from 100 parts of chlorate of potash we may obtain 38.88 of oxygen and 61.12 of chloruret of potassium, and that this chloruret is composed of 28.924 chlorine, and 32.196 metal. Further, as I have demonstrated that potassium is in the state of potash in the chlorate, we must give it 6.576 of the 38.88 of oxygen. There will remain 32.304 to convert the 28.924 of chlorine into chloric acid. But what hypothesis soever we adopt with respect to the existence of the hydrochlorates, the oxygen can only have been furnished to the chlorine either by the potash or the water. On the first supposition there will be formed evidently a quantity of chloruret of potassium, proportional to the quantity of oxygen which the potash has furnished to the chlorine. And as that obtained from the decomposition of the chlorate is neutral, and that it is equally proportional to the oxygen which its potassium would take to be converted into potash, we see that the quantity of chloruret of potassium which forms at the same time with the chlorate, will be to that of the chloruret obtained from the decomposition of the same chlorate, as 32.304 to 6.576, or nearly as 5 to 1; and the quantity of chlorate will be to that of the chloruret formed at the same time as 100 to 300.2.

On the second supposition such a quantity of water will be decomposed, that there will result 32.304 of oxygen for the chlorine, that is to say, 36.59, and the corresponding hydrogen will form with the chlorine hydrochloric acid, which will saturate the potash. We will then have for the proportion of chlorate to hydrochlorate, 100 to 300.2 + 36.59; or 100 to 336.79. We must suppose that the hydrochlorate remains in solution in water; for I have demonstrated, that as soon as the water is removed, even by a very gentle evaporation, it is converted into chloruret of potassium.

The proportion of 100 chlorate to 300.2 chloruret, which I have just determined is very different from that found by experience. Mr. Chenevix, in his paper on oxymuriatic acid (Phil. Trans. xcii. 132) finds that there are formed 16 parts of chlorate for 84 of chloruret. Correcting this ratio from his data, and the results which I have just established, I find 14.4 of chlorate to 85.6 of chloruret, or 100 to 595.4. M. Berthollet (Stat. Chim. ii. 198) says, that he obtained a proportion still weaker. If these proportions were nearly exact, it would follow, that we have not attended to all the circumstances which accompany the formation of chlorate and chloruret; for otherwise what hypothesis soever we adopt, the proportions of chlorate to chloruret and to hydrochlorate, cannot differ from those which I have just established, supposing the data correct from which I set out. To determine this point I made the following experiments.

I passed chlorine into a somewhat concentrated solution of potash, till it refused any longer to dissolve in it.\* The liquid was green-

\* It has been believed that the property which the chlorates have of being



ish, and had a strong odour of chlorine, which it lost when heated. I observed that during this process a little oxygen was disengaged, and the liquid became alkaline. Having evaporated it to dryness, I put a certain quantity of the residual saline mass into a small glass retort, to the beak of which was fitted a syphon-shaped tube, rising to the upper part of the vessel in which the oxygen gas was collected. I heated the retort gradually nearly to redness. When no more oxygen was disengaged, and when the apparatus had sunk to its original temperature, I brought the water in the jar to a level with that in the cistern, and withdrew the tube which had conducted the gas into the jar. By this method, the oxygen which remained in the tube and retort was replaced by an equal quantity of common air. Knowing the quantity of oxygen disengaged, and of chloruret remaining in the retort, it was easy, on the supposition that 100 parts of chlorate contain 38·88 of oxygen, to determine the quantity of chlorate of potash mixed at first with the chloruret of potassium, and to calculate the ratio of the one to the other. By this method I found that 100 of chlorate corresponded in this mixture to 356·5 of chloruret. On saturating with chlorine a solution of potash more concentrated than the preceding, the proportion of chlorate to chloruret was still found sensibly the same. But when the potash was dissolved in about 30 times its weight of water, the ratio of the chlorate to the chloruret was then 100 to 512. It results then from these experiments, that the more concentrated the potash is, the more chlorate do we obtain relatively to the chloruret; but that the ratio always differs from that of 1 to 3, which calculation gives us. As I remarked that the solution of potash, though super-saturated with chlorine, is alkaline, when the excess of chlorine is disengaged by heat, I determined the quantity of alkali in excess, by saturating it with hydrochloric acid of a given strength. By this means I reduced the ratio of 100 chlorate to 356·5 chloruret, to that of 100 to 349. I observe further, that oxygen is disengaged when we heat a solution of potash saturated with chlorine, and even during the saturation of the potash, according to the observation of M. Berthollet. But as I have not determined the quantity, I cannot say what modification it will introduce into the ratio. However, as it is evident that on decomposing by heat the saline mass produced by the saturation of potash with chlorine, we must obtain a quantity of oxygen equal to that contained in the alkali, whether chloric acid be formed, or any other combination of chlorine and oxygen, we cannot ascribe to any other causes than those of which I have just spoken, the

easily decomposed by heat, and of burning most combustible bodies, depends on the chlorine preserving all its caloric when it combines with potash. As a proof, it was stated, that during the combination of these two bodies, the temperature of the solution did not sensibly vary. This cause cannot be true, for in the experiment of which I have just spoken, the temperature at the commencement of the saturation rose from 61° to 174°.



difference between the quantity of oxygen which I ought to have obtained, and what I actually obtained by experiment.

The action of chlorine on the oxides is entirely analogous to that of iodine ; and chloric acid is produced nearly in the same circumstances as iodic acid. Thus we obtain with peroxide of mercury and chlorine, chloruret and chlorate, in the same manner as with iodine and this peroxide we form ioduret and iodate of mercury. These different objects require new researches, and it is to be desired that they may fix the attention of chemists.

The chloruret of azote, from its analogy with the ioduret, ought to be composed of three parts of chlorine and one part of azote ; but Davy instead of this found four to one. When we see azote forming with chlorine and iodine very fulminating compounds, we may ask whether fulminating gold and silver, and even mercury, are not binary combinations of azote and the metal. This is the more probable, as gold, silver, and mercury, having very little affinity for oxygen, seem by this property to approach chlorine and iodine.

From the analogies which I have established in this memoir, the reader must be convinced that oxygen, chlorine, and iodine do not form an insulated group to which belong exclusively the property of acidifying. We have seen that this property belongs likewise to sulphur and azote, and to a great number of other bodies. However, oxygen may be always considered as the principal acidifying substance, both from the energy with which it possesses it, and from the numerous acids which it forms ; and because we are only able to employ as solvents liquids containing oxygen or hydrogen, capable of changing the nature of the compounds which they dissolve. Though chlorine does not disengage oxygen from all its combinations, I think it should be placed before it, on account of the energy of its properties. But fluorine, which has not hitherto been obtained in a separate state, will, without doubt, stand before chlorine, because it disengages oxygen from all its combinations. It is to M. Ampere that we owe the first idea that fluoric acid is analogous to hydrochloric acid ; that is to say, that it is composed of hydrogen and a body analogous to chlorine, which he proposed to call fluorine. Davy, to whom he communicated that theory did not adopt it nor endeavour to verify it till long after, when M. Ampere had answered his objections.

(To be continued.)

## ARTICLE VIII.

*Magnetical Observations at Hackney Wick.* By Col. Beaufoy.

Latitude,  $51^{\circ} 32' 40.3''$  North. Longitude West in Time  $6^{\text{h}} \frac{0}{100}^{\circ}$ .

1815.

Month.	Morning Observ.			Noon Observ.			Evening Observ.		
	Hour.	Variation.		Hour.	Variation.		Hour.	Variation.	
June 18	8h 50'	24° 28'	03''	1h 30'	24° 27'	22''	7h 15'	24° 18'	42''
Ditto 19	8 40	24 18	25	1 20	24 25	22	7 05	24 19	06
Ditto 20	8 45	24 16	20	1 35	24 27	36	7 05	24 20	05
Ditto 21	8 40	24 16	18	1 55	24 25	07	7 05	24 18	17
Ditto 22	8 40	24 16	33	1 45	24 24	42	7 15	24 18	46
Ditto 23	8 15	24 16	40	—	—	—	—	—	—
Ditto 24	8 40	24 15	25	1 30	24 27	24	7 00	24 19	16
Ditto 25	8 40	24 13	39	1 25	24 30	30	—	—	—
Ditto 26	8 35	24 15	52	1 20	24 31	45	7 05	24 20	55
Ditto 27	8 30	24 16	51	—	—	—	7 05	24 22	12
Ditto 28	8 35	24 15	29	1 20	24 25	10	—	—	—
Ditto 29	8 20	24 15	08	—	—	—	7 05	24 20	22
Ditto 30	8 25	24 15	12	—	—	—	—	—	—

*Magnetical Observations continued.*

1815.

Month.	Morning Observ.			Noon Observ.			Evening Observ.		
	Hour.	Variation.		Hour.	Variation.		Hour.	Variation.	
July 1	8h 15'	24° 14'	13''	1h 40'	24° 27'	23''	7h 05'	24° 18'	53''
Ditto 2	8 45	24 13	56	1 35	24 25	15	7 10	24 19	51
Ditto 3	8 25	24 14	39	1 25	24 26	04	7 00	24 18	00
Ditto 4	8 15	24 14	21	—	—	—	7 10	24 19	33
Ditto 5	8 35	24 13	58	1 50	24 25	40	7 00	24 17	26
Ditto 6	8 45	24 14	08	1 25	24 26	52	7 00	24 18	30
Ditto 7	8 35	24 16	03	—	—	—	—	—	—
Ditto 8	8 25	24 16	16	1 25	24 26	54	7 00	24 18	04
Ditto 9	8 20	24 15	15	1 35	24 27	10	7 05	24 18	59
Ditto 10	8 30	24 15	51	1 20	24 24	41	7 05	24 20	39
Ditto 11	8 20	24 14	48	—	—	—	7 00	24 20	51
Ditto 12	8 25	24 12	53	1 30	24 24	16	7 20	24 17	30
Ditto 13	8 35	24 15	04	1 25	24 26	22	7 00	24 18	52
Ditto 14	8 20	24 15	06	1 25	24 24	37	7 00	24 20	40
Ditto 15	8 30	24 17	53	1 25	24 25	12	7 00	24 18	15
Ditto 16	8 35	24 17	25	1 35	24 24	03	7 00	24 19	21
Ditto 17	8 40	24 16	32	1 15	24 25	46	7 00	24 19	07

## Comparison of Observations.

		1813.	1814.	1815.
April.....	Morning .....	24° 09' 18"	24° 12' 53"	24° 16' 01"
	Noon .....	24 21 12	24 23 53	24 27 42
	Evening .....	24 15 25	24 15 30	24 17 48
May .....	Morning .....	24 12 02	24 13 12	24 16 32
	Noon .....	24 20 54	24 22 13	24 27 03
	Evening .....	24 13 47	24 16 14	24 19 12
June .....	Morning .....	24 12 55	24 13 10	24 16 11
	Noon .....	24 22 17	24 22 48	24 27 18
	Evening .....	24 16 04	24 16 29	24 19 40

In deducing the mean of observations for June, the variation of the morning observation of the 18th is rejected, on account of its uncommon greatness.

Rain fallen { Between noon of the 1st June } 1.927 inch.  
 { Between noon of the 1st July }  
 Evaporation during the same period ..... 2.9

## ARTICLE IX.

## ANALYSES OF BOOKS.

*Philosophical Transactions of the Royal Society of London, for the Year 1814, Part II.*

This part contains the following papers.

I. *On a new Principle of constructing his Majesty's Ships of War.* By Robert Seppings, Esq. one of the Surveyors of his Majesty's Navy. —This method, which appears to be the greatest improvement introduced into ship-building for many years, consists in substituting triangular or oblique beams for the parallel ribs which have hitherto constituted a ship's frame. This adds prodigiously to the stiffness and strength. The intervals between these beams are filled by solid pieces of wood driven in and calked and pitched, so that the ship would swim even if the external coating of planks were removed. This method renders the internal coating of planks unnecessary, and this adds considerably to the size of the hold. The decks are not loose as was the case in the old system; but systematically connected with the sides of the ship, so as materially to increase the strength of the whole.

II. *Remarks on the employment of oblique Riders, and on other Alterations in the Construction of Ships. Being the Substance of a Report presented to the Board of Admiralty, with additional Demonstrations and Illustrations.* By Thomas Young, M.D. For. Sec. R. S.—In this paper Dr. Young considers in the first place

the different forces which act upon a ship when sailing, and the effects apt to be produced by these forces. He then examines the different arrangements of Mr. Seppings, and shows that they are all improvements; though, if we understand him right, he seems to state that several of them are not new.

III. *Some further Observations on Atmospheric Refraction.* By Stephen Groombridge, Esq.; F.R.S.—In a preceding volume of the Transactions Mr. Groombridge published a paper on this important subject, giving a formula for the mean refraction down to  $80^\circ$  from the zenith, deduced from his own observations. He has since continued his observations and determined the refraction as low down as  $87^\circ$ , the trees in Greenwich Park preventing him from observing stars any nearer the horizon. He has made some alterations in his preceding formula. The paper concludes with a table of the mean refraction from the zenith to the horizon.

IV. *Propositions containing some Properties of Tangents to Circles; and of Trapeziums inscribed in Circles, and non-inscribed. Together with Propositions on the Elliptic Representations of Circles upon a Plane Surface by Perspective.* By Richard Hey, LL.D. late Fellow of Sidney Sussex, and Magdalen Colleges in the University of Cambridge.—It is not in our power to give any intelligible account of this curious paper to our readers without the assistance of figures, and without introducing demonstrations not quite consistent with the nature of a review. We must therefore refer those who wish to study the subject to the paper itself.

V. *On the new Properties of Light exhibited in the Optical Phenomena of Mother-of-Pearl and other Bodies, to which the superficial Structure of that Substance can be communicated.* By David Brewster, LL.D. F.R.S. Edin. and F.S.A. Edin.—The beautiful play of colours exhibited by mother-of-pearl, has been always ascribed to its laminated structure. Dr. Brewster, however, observed that the same property was communicated to wax, gum, tin, lead, &c., merely by pressing them against the surface of mother-of-pearl. Hence it is obvious, that the property is owing to the configuration of the surface. Dr. Brewster found by means of the microscope, that the surface of mother-of-pearl was composed of waving lines, something like the skin at the point of an infant's finger. These lines could not be obliterated by grinding or polishing. They vary considerably in fineness in different specimens. Sometimes they may be seen with the naked eye, while at others more than 3000 may be reckoned within the space of an inch. To this configuration of the surface Dr. Brewster ascribes the property of mother-of-pearl to reflect various tints of splendid colours. Dr. Brewster found likewise, that when a ray of light falls obliquely upon mother-of-pearl, both the portion reflected and the portion transmitted are polarized, and both in the same manner. This is different from what happens either in crystallized or uncrystallized bodies.

VI. *An improved Method of dividing Astronomical Circles and*

*other Instruments.* By Captain Henry Kater.—It is not possible to convey an adequate idea to the reader of the method of graduating contrived by Captain Kater, without the assistance of figures. We must therefore refer those who wish to understand this important subject to the paper itself.

VII. *Results of some Experiments on the Properties impressed upon Light, by the Action of Glass raised to different Temperatures, and cooled under different Circumstances.* By Dr. Brewster.—The author found that a ray of light passed through hot glass was depolarized; but when the glass cooled the original polarization was restored. Prince Rupert's drops exhibited the same phenomenon, together with the coloured rings, which characterise doubly refracting crystals.

VIII. *Considerations of various Points of Analysis.* By John F. W. Herschel, Esq. F.R.S. The subjects treated of in this paper preclude the possibility of abridging it.

IX. *Observations on the Functions of the Brain.* By Sir Everard Home, Bart. F.R.S.—The author conceives that it would greatly tend to promote our knowledge of the uses of the particular parts of the brain, if anatomical surgeons would collect all the observations which they have an opportunity of making in cases of injury of that organ. The present paper contains an arranged collection of his own observations in the course of his practise. 1. A certain degree of pressure is requisite to keep up the functions of the brain. A diminution of it produces faintness, an increase insensibility. The water in the ventricles may increase indefinitely without injuring the functions of the brain, if the skull expands in the same proportion. A curious example of this is detailed. 2. Concussion of the brain produces delirium and coma. 3. Sudden dilatation of the blood vessels of the cerebrum, in consequence of exposure to the sun, is sometimes accompanied by delirium, loss of speech and the power of swallowing. 4. Blood extravasated in the lateral and third ventricles was attended by repeated fits of vomiting and coma. In other parts of the brain it produced stupor, paralysis, idiotism. 5. The formation of pus is attended with delirium. 6. Depression and thickening of different portions of the skull was attended with heaviness, torpor, head-ache, &c. 7. Tumors in different parts of the brain produced violent head-aches, apoplexy, loss of sight, epileptic fits, &c. 8. Wounds in the anterior lobes of the brain produced no sensible effect. Loss of a portion of one of the hemispheres was attended with difficulty of swallowing for 24 hours, and slight delirium of short duration. 9. In a boy in whom the tuberculum annulare had become indurated, the effects were, that the boy had been an idiot from his birth, never walked, spoke, or understood what was said. 10. Pressure upon the medulla spinalis produces paralysis.

X. *Further Experiments and Observations on Iodine.* By Sir H. Davy, LL.D. F.R.S. V.P.R.I.—This paper is divided into five sections. 1. On the triple compounds containing iodine and

oxygen. When iodine is dissolved in potash or soda, two compounds are formed; one composed of oxygen, iodine, and potassium or sodium; the other of iodine and potassium or sodium. Our author calls the first *oxiide of potassium*, &c. the second *iode of potassium*, &c. When the alkali is saturated with iodine crystals are deposited. These are to be digested in alcohol of 8·6, or 9·2. The undissolved portion is the triple compound. Oxiide of potassium is almost tasteless, has no action on vegetable colours, is scarcely soluble in cold water; but more so in hot water. By heat it may be dissolved in sulphuric, nitric, and phosphoric acids. The saturated solutions congeal and form crystalline masses of an intensely acid taste. When strongly heated the triple compound is decomposed at the temperature at which the acids are driven off, and oxygen and iodine exhales. Oxiide of potassium dissolves readily in phosphorous acid. When the solution is heated the acid is converted into the phosphoric, and iodine appears. When thrown into muriatic acid, an effervescence is perceived, the smell of chlorine becomes sensible, and the fluid, when evaporated, yields chlorionic acid. Similar appearances take place with the vegetable acids and the oxiide; all easily explained by the transfer of oxygen to the solvent.

Sir H. Davy conceives oxiide of potassium to be composed of one atom iodine, one atom potassium, and six atoms oxygen; but his experiments scarcely seem sufficient to warrant any such conclusion.

He formed likewise by a similar process, oxiides of barytes, lime, and magnesia.

His attempts to obtain a compound of oxygen and iodine were not attended with success.

2. On hydrionic acid and the compounds obtained by means of it. This acid is obtained pure by heating iode of potassium and hydro-phosphoric acid together. It is slowly decomposed by heat, and rapidly when heated along with oxygen gas. When condensed in water it is instantly decomposed by nitric acid and iodine precipitated. It rapidly absorbs oxygen from the air, and becomes yellow, and at last a deep tawny orange. It will probably answer well as a eudiometrical substance. It was decomposed by all the metals tried, except gold and platinum. With the alkalies and common earths it forms compounds very similar to those formed with the same bases by muriatic acid. 3. On other acid compounds of iodine. Iodine absorbs nearly one third of its weight of chlorine gas, and forms a very volatile compound, which acts upon mercury, and is dissolved by water. Sir H. Davy supposes that this compound is composed of an atom of iodine and an atom of chlorine. He calls it *chlorionic acid*. Its colour is yellow, and it readily dissolves iodine becoming deeper coloured. When agitated in chlorine gas it becomes colourless. In this state, when poured into alkaline or earthy solutions, oxiides are precipitated. If it be coloured a quantity of iodine appears at the same time. When

poured into ammonia a white powder falls, which detonates feebly, and affords iodine and a gas not capable of supporting combustion. When the acid is coloured the precipitate formed is black, and detonates much more loudly.

Tin and iodine, when combined, form a body possessing acid properties, though no hydrionic acid could be detected in it. 4. On the action of some compound gases on iodine. It absorbs sulphureted hydrogen and forms a reddish brown fluid. When iodine was sublimed in olefiant gas a little reddish brown fluid was formed. It produced no change on nitrous gas nor carbonic oxide; but when mixed with carbonic oxide in the gaseous state and exposed to the light of the sun, a combination seems to take place. 5. On the mode of detecting iodine in combinations, and on certain properties of its compound with sodium. The marine productions of the Mediterranean contain less of it than the *sel de varec*. Ashes of the ulva, that abounds on the coast of Languedoc, yielded traces of it. As did the ashes of the following plants: fucus cartilagineus, fucus membranaceus, fucus rubens, fucus filamentosus, ulva pavonia, ulva linza.

The ashes of corralines and sponges exhibited no traces of it. Its presence is detected by its property of tarnishing silver, and by the red fluid which alkaline leys containing it form with sulphuric acid.

Sir H. Davy conceives it possible that the superiority of bay salt in curing fish and meat, may depend upon the presence of this substance. He rubbed pieces of beef with iode and oxide of sodium. They did not putrify. The piece rubbed with the iode became brown, soft, and tender; that rubbed with the oxide hardened considerably and became paler.

XI. *Observations respecting the natural Productions of Saltpetre on the Walls of subterraneous and other Buildings.* By John Kidd, M. D. Professor of Chemistry in Oxford.—The formation of nitre upon calcareous stones in certain situations has been long known, and advantage has been taken of it to procure that important salt in great quantities; though no satisfactory theory of the formation of the salt itself has yet been offered to the public. The present paper contains a set of observations on the appearance of an efflorescence of saltpetre on the walls of the Ashmole laboratory at Oxford, a large ground room, sunk below the area of the street. The walls are built of Oxford lime-stone, a granular floetz lime-stone containing many fragments of shells, of vegetable bodies, and composed of 96 carbonate of lime, and 4 of ochrey sand. The salt formed was nearly pure, though it contained traces of lime and of sulphuric and muriatic acids. What was formed in winter contained most lime. The formation of this salt was most rapid in frosty weather; it formed slowly, and the quantity even diminished in moist weather after it had been deposited. Exclusion from the air did not preclude the deposition of the salt, though it diminished it considerably.



XII. *On the Nature of the Salts called Triple Prussiates, and on Acids formed by the Union of certain Bodies with the Elements of the Prussic Acid.* By Robert Porrett, jun. Esq.—I have already given a pretty full account of this important paper in the number of the *Annals of Philosophy* for January, 1815, to which I refer the readers. I intend to publish an abridgment of the paper in a future number of the *Annals*, as it contains some discoveries which I consider as important.

XIII. *Some Experiments on the Combustion of the Diamond, and other Carbonaceous Substances.* By Sir H. Davy.—Diamonds were put in a small glass globe filled with oxygen gas, and kindled by means of a burning-glass. When once set on fire, they were found to burn, though removed out of the focus of the lens. The result of the experiments was, that diamonds, when burnt, produced only carbonic acid gas, and no alteration took place in the bulk of the gas in which the combustion was performed. Hence it follows that the diamond consists of pure carbon. Plumbago and charcoal, besides carbonic acid, formed also a sensible portion of water when burnt, and the bulk of the oxygen gas was diminished. Hence these bodies contain hydrogen as a constituent, though only in a very minute proportion.

XIV. *Some Account of the Fossil Remains of an Animal more nearly allied to Fishes than to any other Class of Animals.* By Sir Everard Home, Bart. F.R.S.—These bones were found in a cliff on the sea coast of Dorsetshire. The skull was pretty perfect; most of the other bones were broken and crushed. The ribs were 60, and make the skeleton 17 feet long. These bones approach most nearly to those of fishes, though the author considers the animal as not having been a perfect fish, but as constituting one of those intermediate links so commonly observed in the animals of New South Wales.

XV. *On an easier Mode of procuring Potassium than that which is now adopted.* By Smithson Tennant, Esq. F.R.S.—This method is to put the potash and iron turnings together into a gun-barrel about a foot and a half long, and covered with a lute composed of Stourbridge clay, partly in its natural state, and partly previously baked. Into the mouth of the gun-barrel another iron tube about eight inches long is to be put, perforated at the lower extremity, and having its upper end projecting about an inch beyond the gun-barrel. The mouth of the gun-barrel is shut by another tube which slips over it. The mouth of it is filled by a perforated cork, through which there passes a bent glass tube, having in it a drop of mercury. This apparatus being exposed to a strong heat for an hour in a smith's forge, the potassium is found perfectly pure in the upper perforated iron tube.

XVI. *On the Influence of the Nerves upon the Action of the Arteries.* By Sir Everard Home, Bart. F.R.S.—Our author accidentally observed that the application of stimulants to nerves produced a violent increase of the action of the blood-vessels connected

rock is for the most part a compact, sonorous, dark blue trap, nearly with them. He laid bare the carotid artery of a dog, and upon touching the intercostal nerve and par vagum with potash, a violent increase in the action of the artery took place. The same experiment succeeded equally in rabbits; so that the circulation of the blood is not wholly dependant upon the heart and the elasticity of the arteries, the action of the nerves is necessary to regulate the distribution of it to the different parts of the body.

XVII. *On the Means of producing a double Distillation by the same Heat.* By Smithson Tennant, Esq. F.R.S.—The method is to make the worm from the first still pass through a second, which is air-tight, and has attached to it a worm connecting it with an air-tight receiver. Heat is applied to the second still till the liquid in it is made to boil; the cocks are then shut, and the distillation carried on by the heat communicated by the worm from the first still.

XVIII. *An Account of some Experiments on Animal Heat.* By John Davy, M.D. F.R.S.—From these experiments it appears that there is no material difference between the specific heats of venous and arterial blood, except what arises from difference in the specific gravity; that of the former being 1·049, and of the latter 1·050. Our author considers the relative specific heats as 0·913 and 0·903. The temperature of arterial blood is higher than that of venous, and the temperature of the left side of the heart than of the right. The temperature of parts diminishes as the distance of the parts from the heart. These results are incompatible with Dr. Crawford's theory of animal heat, but agree with the theory of Dr. Black.

## ARTICLE X.

### *Proceedings of Philosophical Societies.*

#### GEOLOGICAL SOCIETY.

May 19—A notice accompanying an additional drawing to the paper on Vegetable Remains in Chalcedony, by Dr. Macculloch, was read, describing a vegetable remain possessing decidedly the genuine characters of *conferva*.

June 2.—The Secretary reported that a communication on the Native Tellurium of Norway had been received from Professor Esmark, of Christiana.

Dr. Macculloch's paper on the Isle of Sky, begun at a former meeting, was concluded.

The principal group of mountains in Sky is the Cuchullin. This elevation probably exceeds 3000 feet, and the principal escarpments look east and north. It is remarkable for the spiry granitic form of its summits, and its naked barrenness, owing to the strong resistance which it opposes to the usual causes of decomposition. The

allied to green-stone, passing sometimes into syenite, sometimes containing glassy felspar and hyperstene, and sometimes composed merely of quartz and hornblende. It is traversed throughout by dykes of basalt, in some places approaching to pitch-stone, and appears to rest on a very compact grey quartz sand-stone, which does not contain shells, and like the superincumbent trap, is traversed by veins and dykes of basalt.

Adjacent to the Cuchullin is another group, called the Red Mountains, of lower elevation than the former, presenting rounded outlines, and so covered with fragments in a state of decomposition, that the massive rock can rarely be perceived. The chief constituent ingredient of these mountains is flesh-red felspar, passing into clay-stone, and containing a small and variable proportion of hornblende and quartz. This rock, like that of the Cuchullin, is also traversed by veins of trap, and probably by veins of granite.

The northern portion of the island consists for the most part of floetz trap in beds approaching to horizontal, alternating with sand-stone, and presenting seams of basaltic coal generally broken, imperfect, and of little extent. This trap offers the usual varieties, namely, basalt, either perfect, or approaching to wacke, green-stone, and amygdaloid. This latter variety contains nodules of steatite, balls of filamentous mesotype, crystallized mesotype, chabasite, and occasionally stilbite and ichthyophthalmite. In some parts the shale and sand-stone adjoining the trap are indurated, and more or less altered, the former in particular being converted into lydian-stone and botryoidal schist. The whole of the eastern shore of Strathaird exhibits one continuous cliff of blue compact lime-stone, split by numerous fissures, and hollowed out into caves.

At Kilbride, near Loch Clapin, another lime-stone district occurs, the connections of which it is very difficult to ascertain. This lime-stone is unstratified, contains no organic remains, is of a granular structure, and is in many places a perfect marble, more or less coarse in its grain, of a white, blue, and yellowish-green colour (this latter from an intermixture of serpentine), and applicable to various uses in ornamental architecture. This lime-stone ceases a mile or two short of Bradford; and on the shores of this latter water another formation of lime-stone, totally distinct from the other, makes its appearance. This forms thin beds, alternating with sand-stone and shale, is highly bituminous, and contains *annoniæ*, *ammonitæ*, and other shells, and is traversed by trap veins.

Between Loch Oransa and the northern part of the shore near Bradford is a tract of quartz rock, which also occurs in other parts of the district of Clate, accompanied by various primary schistose rocks, and intersected by veins of trap.

A paper by J. Williams, jun. Esq. of Scorvier, describing the mine of Huel Peever, was read.

The tin vein of Huel Peever, in the parish of Redruth, in consequence of its intersection by cross veins, by the underlie of a

parallel copper vein, and by the oblique course of a channel of porphyry, was lost, and exercised the skill of the ablest Cornish miners for more than 40 years before it was recovered. A description of the particular deviations produced in the course of the vein by each of these disturbing causes is given in this paper, and its accompanying plans and sections.

#### WERNERIAN SOCIETY.

At the meeting on 21st January, Mr. P. Syme laid before the Society an account of some remarkable atmospheric appearances observed by him during a thunder-storm on the 29th of July 1814, accompanied with several beautiful drawings executed by him from sketches which he took at the moment.

At the meeting on 4th February was read an essay on the germination and physical economy of ferns, by Dr. Yule.—At the same meeting there was read an account of the mineralogy of the Red Head, by Dr. Fleming. The Red Head is a well known promontory in the county of Forfar. The rocks consist of sand-stone and gravel-stone. The author seemed inclined to consider these rocks as mechanical deposits, as they bear the closest resemblance in all respects, except in being cemented, to beds of sand and gravel in the neighbourhood. The sand-stone belongs to the old red sand-stone formation, in which many trap-rocks rising into hills, such as the Ochils, and hills of Kinnoul and Perth, occur in the form of great beds.

At the meeting on 25th February, Professor Jameson read a short account of the places where fossil remains of elephants have been found, and exhibited the tooth of a mammoth discovered by William Auld, Esq. in Hudson's Bay, this being the first time that such remains have been observed so far to the northward in America. Professor Jameson also read a notice concerning the indurated tale which occurs in quantity in the island of Unet, one of the Zetlands, and which, he stated, might be profitably brought to market, the article being in demand for removing stains from silks, &c. and selling at a considerable price.

At the meeting on the 11th of March, Professor Jameson read the continuation of his mineralogy of the Lothians.

At the meeting on 25th March was read a description of a new species of water ouzel or dipper, found in this country by James Wilson, Esq. A specimen of the young bird and a drawing of the bird in full plumage were exhibited. It differs from the common ouzel chiefly in the deep rufous band on the lower breast being wanting, and in the breast feathers being marked with transverse waved lines, from which last circumstance Mr. Wilson proposes to call it *Aquatilis undulatus*.

At different meetings of the Wernerian Society in January, February and March, a paper by Mr. Scoresby junior of Whitby, on Polar Ice, and the Practicability of a Journey to the Pole, excited much interest.

He began with some notices as to the characteristics of the atmosphere and the land in West Greenland and Spitzbergen. The *atmosphere* is remarkable for darkness of colour and density, for the production of highly crystallized snow, and for almost instantaneous changes from perfect calm to impetuous storm. The *land* is remarkable for abrupt precipices, rising directly from the ocean to a great height: the dark-coloured rocks contrasted with the snow of the purest whiteness with which they are capped, produce a very striking effect. Here the *white bear* is the lord of the creation: seals and all other animals flee his presence. He is yearly attracted over the ice to the fishing ground, by the carcasses of whales, the smell of which he seems to perceive at a wonderful distance.

As to the *ice*, Mr. Scoresby remarked that Davis Straits is noted for enormous *ice-bergs* or ice-islands, and that Greenland is more remarkable for *ice-fields*. Some of these ice-fields are of vast extent, perhaps 100 miles long and 50 broad; the surface being raised from 4 to 6 feet above the water, and the base sunk near 20 feet below the water. The ice-bergs of Baffins Bay are sometimes nearly two miles long and perhaps 100 feet high, while their base must reach 450 feet below the surface of the water. Some ice-bergs are formed on the land; but the most huge are, in Mr. Scoresby's opinion, produced in the deep sheltered bays of the sea, and formed partly of sea water and partly of snow and sleet, yearly accumulated perhaps for successive ages.

Mr. Scoresby mentioned, that he never could, by experiments made in Greenland, obtain from sea water, ice that was either compact, transparent, or which yielded a fresh solution. Yet fresh-water ice is common, and the whale-fishing ships frequently water at some pool on the surface of an ice-berg. *Salt-water ice* is soft, porous, white; it is lighter than the other, its specific gravity being about 0.873, while that of *fresh-water ice* is 0.937. This last has a black appearance while floating in the sea, and is transparent, with a green hue, when held in the air. Its edges are sharp like glass. With pure pieces of this kind of ice Mr. Scoresby sometimes amused himself in forming lenses, with which he was able to fire gunpowder, light the sailors' pipes, burn wood, and even melt lead.

Ice is generated in the Northern Ocean entirely independent of the vicinity of land. It is formed even in rough seas during intense cold; first producing what is called by the sailors *sludge*, and then flat pieces of a rounded shape, and turned up at the edges, which have received the whimsical name of *pancakes*. In the sheltered openings which occasionally occur in the great fields of ice, *bay-ice* is often rapidly formed: it will bear a man's weight in 48 hours, and in a month is fully a foot thick. Suppose a large opening to be thus frozen over, and cemented on every side to the older ice, a great basin or hollow is produced: this becomes a receptacle for snow: next summer the snow is melted, and during the following winter the water is converted into a solid layer of fresh-water ice.

In this way, Mr. Scoresby thinks, the most compact *field-ice* may be generated in a few years. Other fields are formed of boards of packed ice cemented by frost. Ice-fields have an invariable tendency to drift to the south-westward, amid various or contrary winds. They appear in June in the fishing latitudes, and many are yearly broken up by the agitation of the waves when they advance to the open ocean. When two fields come in contact, the concussion is tremendous.

Mr. Scoresby gave a description of the present situation or boundaries of the circumpolar ice, both in *close* and in *open* seasons,—which it is impossible to abridge. Such is the outline, that when the ice touches the south point of Spitzbergen, a barrier is formed against access to the open sea farther north, where whales are to be found. If this barrier consist only of packed ice, and be not cemented into fields, the ships are forced through it, with great difficulty no doubt, and not without peril. In June this barrier divides in the middle, and when the vessels return from the fishing it frequently happens that no vestige of it is to be seen. The largest fields of ice are always moving and changing place, generally drifting to the south-west, although, on account of their vast extent, it is difficult to estimate the amount of the change. A ship *beset* in a field was carried, with a semicircular sweep, between fifteen and twenty leagues in fifty hours. Two ships embayed in packed ice, within a few furlongs of each other, were separated to the distance of some leagues in the course of two days, and yet the continuity of the pack of ice appeared to the eye to have remained unbroken.

The effects of the ice on the atmosphere are very striking. A strong gale blowing against one side of a large field, is so moderated in its passage over the ice, that it is scarcely felt on the other side. Moist and temperate gales from the southward, on reaching the fields, immediately discharge their superfluous moisture in the form of snow. The *ice-blink* is a curious phenomenon. The rays of light which fall on the ice are reflected, while those which fall on the water are in a great measure absorbed. A luminous belt appears in the horizon, containing a beautiful map of the ice, sometimes so perfect that a practised eye can determine whether field ice or packed ice be represented.

In the last part of his paper Mr. Scoresby treated of the practicability of reaching the North Pole, by setting off from the north of Spitzbergen, and travelling over the ice. That this may not be met with a smile of contempt, we may mention that his reasonings, and the statements founded on his own experience, went a great way in removing the objections of some of the most distinguished Scottish philosophers. Mr. Scoresby has been several times beyond  $80^{\circ}$  N. lat. Indeed, he on one occasion made a nearer approach to the polar point than any other scientific observer. Captain Phipps (Lord Mulgrave) in 1773 reached  $80^{\circ} 37'$ ; but in 1806 Mr. Scoresby (then acting as chief mate to his father, well



known as one of the most enterprising and intelligent captains in the Greenland trade) penetrated as high as  $81\frac{1}{2}^{\circ}$  N. a distance of only 170 leagues from the pole. Even when north winds had prevailed for days, Mr. Scoresby did not find the cold of  $80^{\circ}$  much different from that of  $70^{\circ}$  N. With woollen clothing, therefore, he thinks the cold would not be overwhelming, and an external garment of varnished silk would protect the body from moisture. It would be impossible to accomplish a journey of 1200 miles (600 going and 600 returning) without the assistance of some fleet quadrupeds accustomed to harness. Rein-deer or dogs are the only animals that could be employed, and they must be procured from the countries where they are trained. Dogs are most hardy and tractable, and would on the whole be preferable. Drivers must also be procured from the same countries. The sledges must be light, and in the form of boats, in case of spaces of open water occurring. Between a month and six weeks, Mr. Scoresby thinks, would suffice for the journey. To avoid the retarding effects of soft snow, he suggests that the party should set out by the close of April. When the aid of the magnetic needle as a director should be lost, by its pole being directed to the zenith, the sun would be the only guide. A chronometer would be an indispensable instrument. With a chronometer adjusted to the meridian of north-west Spitzbergen, the bearing of the sun at the time of noon (provided this could be accurately ascertained very near the pole) would afford a line of direction for the return; the position in regard to longitude being corrected twice a day. White bears are the only living enemies to be expected; but they are not likely to occur in numbers very far north, as their food must necessarily be scarce. Mr. Scoresby has little expectation of mountainous *land* occurring, and he thinks it highly improbable that the sea will be found free from ice at the pole, as the Dutch navigators have asserted it to be. Mr. Scoresby's ample experience convinces him, that thick weather is only to be dreaded as the accompaniment of southerly winds, which occur but seldom and at distant intervals.—Such a journey must necessarily be hazardous; but great difficulties have in former times been overcome in travelling the northern ice. In the Spring of 1715, Alexei Marcoff, a Cossack, travelled from Siberia, in a sledge drawn by dogs, near 400 miles northward, over a surface of packed ice. He was obliged to stop about the 78th degree, on account of the provisions for his dogs falling short; by killing some, and feeding the others with the carcasses, he effected his return in safety. But if the party were to reach the pole either by means of rein-deer or dogs, and these entirely to fail through cold and fatigue, it is at least possible that they might be able to accomplish their return on foot, drawing their provisions in a sledge; a large party of the crews of the Dutch Greenland fleet wrecked in 1777 having traversed the ice for a hundred leagues, amid the severity of the arctic winter, and actually reached the settlements of the Danish missionaries, without any suitable preparations for such a journey.



## ROYAL INSTITUTE OF FRANCE.

*Account of the Labours of the Class of Mathematical and Physical Sciences of the Royal Institute of France during the Year 1814.*

I. *Physical Department.* By M. le Chevalier Cuvier, Perpetual Secretary.

## CHEMISTRY.

(Continued from Vol. V. p. 463.)

More than a hundred years ago there had been extracted from the quarries of Oeningen, near the lake of Constance, a petrified skeleton, which Scheuchzer, a naturalist of Zurich, had taken for that of a man, and which he had engraven under the title *homo diluvii testis*. More recent naturalists had considered it as the skeleton of a fish. M. Cuvier, from the simple inspection of the figure published by Scheuchzer, had considered it as an unknown and gigantic species of salamander. Having made a journey to Harlem, where this celebrated fossil is deposited in the Teylerian Museum, and having obtained permission from M. Van Marum, Correspondent of the Class, and Director of that Museum, to dig into the stone in order to expose those parts that had been hitherto concealed, M. Cuvier discovered feet, with their bones and toes, small ribs, teeth along two large jaw-bones; in short, all the characteristic parts; so that it is now no longer possible to doubt that the skeleton really belonged to a salamander. He has shown to the Class a figure of this fossil thus exposed, which he means to send, together with a description, to the Academy of Harlem.

The same member has exhibited a head of the last animal, called *palæotherium medium*, recently disengaged from the gypsum of Montmartre. This head was complete, and confirmed all the conclusions hitherto drawn from isolated fragments.

M. de Humboldt, Foreign Associate, has communicated the truly astonishing history of the volcano of Jorullo, which burst out in 1759 at Mexico, on a well cultivated platform, where two rivers of cold water flowed, and where, during the memory of man, no subterraneous noise had been heard. The catastrophe was announced some months beforehand by earthquakes and bellowings, which continued 15 or 20 days. A shower of ashes then fell, and more violent bellowings took place, which induced the inhabitants to fly; flames arose over an extent of more than half a league square; pieces of rock were thrown up to a great height; the crust of the earth rose and sank like the waves of the sea; there arose an innumerable multitude of small cones, from six to nine feet high, which covered the surface of the platform, and which still remain there. Finally, there arose in the direction of S. S. E. and N. N. E. six hills, the principal of which, still distinguished by a burning crater, is not less than 1600 feet in height. These frightful operations of

Nature continued from the month of September, 1759, till next February. Eye-witnesses declare that the noise was equal to what would have been produced by thousands of cannon, and that it was accompanied by a burning heat, part of which still continues; for M. de Humboldt found the heat of the soil  $36^{\circ}$  Fahr. higher than that of the atmosphere. Every morning thousands of columns of smoke rise from the cones and the crevices of that great platform. The two rivers now contain hot water impregnated with sulphureted hydrogen; and vegetation is only beginning to appear upon this shattered country.

This volcano is 46 leagues from the sea, and nearly as far from the nearest active volcano. On this occasion M. de Humboldt remarks that several volcanoes of the New World are at as great a distance from the sea as this is; while in the Old World we know no volcano that is 12 leagues distant from the sea, and the greater number are upon the shore. This scientific traveller informs us, likewise, that all the great volcanoes of Mexico are found not merely in almost the same line transversal to the direction of the Cordilleras, but likewise within a few minutes of the same parallel, as if they were all elevated above a subterraneous crevice which extends from sea to sea. He ascertained all these facts by measures and determinations of positions, as exact as troublesome to take. The public will see the whole details in the continuation of the celebrated work in which M. de Humboldt has consigned the result of his great work on America.

M. de Humboldt, in a memoir on vegetation in the Canary Isles, has stated some general considerations on the geography of plants. By combining the results of observation with the double influence which the latitude and the height in the atmosphere produces on the temperature, he has fixed for a certain number of points the limits of perpetual snow, the mean temperature of the air at that limit taken during the whole year, and likewise the particular temperature of the winter and summer months; and he has shown that we may deduce from these different data the habitual distance between that limit and the heights on which trees and corn grow; and that even the variations, apparently capricious, which the same species of trees present in different climates, may be explained when we join to these data the consideration of the period of the year when each tree increases in bulk.

It has been long known that the number of stigmata is not constant in the family of cyperace; nor was it believed that these variations were sufficiently important to serve as a basis for the distinction of the genera.

M. Schkuhr, a German botanist, first observed that in the genus of carex there exist species with two and three stigmata, and that the number of these organs is always the same as that of the angles of the fruit.

Our associate, M. the Baron de Beauvois, has generalized this observation to all the plants of the family. He has remarked some

that have four stigmata, and in which the fruit is evidently quadrangular, at least in some of its parts. Such in particular are the *schoenus mariscus*, the *gahnia psittacorum* of M. de la Billardiere, and a very remarkable new genus brought from the Cape by M. du Petit Thouars, and which M. de Beauvois calls *tetraria*, on account of the repetition of a quaternary number in the different parts of its flower.

M. de Beauvois concludes from his observations that the number of stigmata has an importance more than sufficient to furnish the generic characters. This will be so much the more advantageous, as some genera of cypereæ have very numerous species, very difficult to distinguish.

M. de Beauvois has likewise made new observations, which in his opinion more and more confirm a notion which he has long entertained and supported, respecting the fructification of mosses; namely, that the green powder which fills the urns, and which Hedwig considers as the seed, is nothing else than the pollen; and that the true seed is contained in what botanists term the columella of the urn.

M. de Beauvois has remarked, that at first this green powder, like the pollen, is nothing else than a compact, shapeless mass, which gradually acquires consistence, and at last divides into powder, the grains of which are united by small filaments, and composed each of two or three small compartments, full of a humor comparable to the *aura seminalis* of ordinary pollen; and mixed with other smaller grains which are opaque and ovoid. This successive division holds equally with the powder contained in the reniform bodies of the lycopodiæ, and in the interior of the mushrooms called lycoperdons. The little central body regarded hitherto as a columella, which varies in form in different genera, but preserves nearly the same shape in the same genera, and to which in all cases the green powder is attached, terminates in an appendix, which is prolonged in the opercula of the urn, and which falls off with that opercula; so that the pretended columella is then open, doubtless to facilitate the escape of the little grains which M. de Beauvois has observed there, and which he considers as seeds.

This skilful botanist has observed that in the polytricha and other mosses the small filaments which Hedwig considers as antheræ are still perfect at a period when the powder in the urn has acquired its full development. But the contrary ought to be the case if these filaments were male organs. They ought to have performed their function and to be decayed, before the green powder, considered as the seed, has come to a state of maturity. Hence M. de Beauvois concludes that the filaments in question are rather female organs. The mosses, then, belong to the class of *polygamia*; for M. de Beauvois shows that the small opaque grains which he has seen in the columella were also seen and represented by Hedwig, at least in the *bryum striatum*. The urns of mosses, then, according to M. de Beauvois, are incontestably hermaphrodite flowers.

M. du Petit-Thouars has made the Class acquainted with some interesting observations in vegetable philosophy. One among others shows very well the connexion of the leaves with the woody layer of the same year. When a leaf falls, we see at the base of its pedicle a number of points, variable according to the form of the leaf, and the number of leaflets of which it is composed. These are sections of as many filaments, which are vessels, or rather bundles of the fibres of the leaf. If we examine the place from which the leaf fell, we discover the same points, and we may follow the filaments into the interior of the wood; but if we make the same observation in the spring, upon a leaf newly developed, the filaments will be found to extend only to the surface of the wood. Two or three months after a new layer of wood being formed envelopes them in its thickness.

The same botanist has made curious remarks respecting the relation of the number of stamina with that of the other parts of the flower, and has found that in several genera, as the polygonum, rheum, &c. in which this relation seems very irregular and inconstant, the number of stamina is equal to the sum of the divisions of the calix and pistils taken together. This is a singular fact, the connexion of which with the general structure of the flower is not easily seen.

M. Desvaux has presented a memoir on a family of plants the fructification of which is concealed, namely, the *algæ*, comprehending, among others, all the sea plants called *fucus*. He has proposed to establish in them several new genera, and has made experiments to ascertain if the filaments by which the fuci adhere to the rocks, and to the bottom of the sea, be true roots. For that purpose, after having detached several feet of their natural adhesions, he fixed them to stones by means of cords, or other artificial methods, and plunged them again into the sea. Having visited them some time after, he found that they had increased very sensibly. It was known, likewise, that some species, as the *fucus natans*, live and increase very well without being attached to any thing.

M. Lamouroux, Professor at Caen, has sent several memoirs to the Class on the same plants, which his nearness to the sea has enabled him to observe, and to which he gives the name of thalassiophytes. After having pointed out all the divisions of which they are susceptible, he has considered them as furnishing food to man and the inferior animals, as useful in rural and domestic economy, and in the arts. One is astonished to learn how many useful and agreeable purposes they are applied to by different nations. Some eat them directly, or form them into a nourishing and agreeable jelly: others employ them for feeding their cattle. They are all capable of furnishing soda, and they constitute an excellent manure. Some furnish sugar, others dye stuffs. Of some mats are made, and drinking vessels, and even musical instruments. What is called *Corsican moss* constitutes a valuable remedy, &c.

(To be continued.)

## ARTICLE XI.

SCIENTIFIC INTELLIGENCE; AND NOTICES OF SUBJECTS  
CONNECTED WITH SCIENCE.I. *Lectures.*

The following lectures, which were formerly delivered in the Theatre of Anatomy, will in future be delivered in the Medical Theatre, No. 42, Great Windmill-street:—

1. On the Laws of the Animal Economy, and the Theory and Practice of Physic: by George Pearson, M.D. F.R.S. senior physician to St. George's Hospital, &c. &c. \*

2. On *Materia Medica*, Therapeutics, and Medical Jurisprudence: by Richard Harrison, M.D. Fellow of the Royal College of Physicians, and Physician to the Northern Dispensary.

3. On Chemistry: by — Granville, M.D.

4. On the Theory and Practice of Surgery: by B. C. Brodie, F.R.S. Assistant Surgeon to St. George's Hospital.

Sir Everard Home's gratuitous lectures to the pupils of St. George's Hospital will also be given in this theatre.

II. *Ytthro-Cerite.*

There has been lately found at Finbo, near Fahlun, in Sweden, a new substance, containing

Lime .....	47·77
Yttria .....	14·60
Oxide of cerium .....	13·15
Fluoric acid .....	24·46
	<hr/>
	99·98

Messrs. Gahn and Berzelius have given it the name of *ytthro-cerite*. It has been found in the form of a powder, of a violet colour, or pale blue, covering pyrophyllite.

III. *Steinheilite.*

This mineral has been long valued in collections, on account of its blue colour, but has been merely considered as quartz. Count Steinheil, Governor General of Finland, having, however, from the angles of some crystals, considered it as something different from quartz, requested Professor Gadolin to examine it; and he has found it to contain a large quantity of alumina. It appears to be something between quartz and sapphire.

\* Some of Dr. Pearson's lectures are delivered at his theatre, in George-street, Hanover-square.

IV. *Fluo-Arseniate of Lime.*

This is a yellowish substance, which accompanies the oxide of tin at Finbo, near Fahlun. It is seldom got in large masses; but is spread on the quartz or felspar. It is a combination of fluoric and arsenic acids and lime.

V. *Gadolinite.*

Mr. Berzelius has found that all the gadolinites contain cerium, and that the yttria hitherto obtained from gadolinite has not been pure, but contained cerium. He has lately discovered a method of separating the cerium from the yttria.

VI. *New Mass of Native Iron discovered—Blumenbach's Arrangement of the Human Species.*

(To Dr. Thomson.)

MY DEAR SIR,

If you can make any use of the following notices for the miscellaneous articles of the next number of your Journal, I beg you will insert them in any manner you think proper. Being again in correspondence with Germany, I may be enabled in future to furnish you with other materials for that part of your publication.

Baron Moll, of Munich, writes to me that towards the end of October, 1814, a mass of native iron, weighing about 200 lbs., has been discovered by a shepherd at Lenarto, in the comitate of Sarosh, on the declivity of a small range subordinate to the Carpathian mountains. Internally it is light steel-grey, approaching to silver-white; externally it is covered by a slight coat of a dark brown rust; its surface is rough, uneven, and marked with impressions; only three cavities are observed, which may be called cells; but they are without any of the olivine-like substance which has been found within those of the Siberian native iron. The form of this mass is irregular and flat, as if compressed. It is of a very close grain, and takes an excellent polish; its fracture is hackly in a high degree; it is perfectly malleable in the cold; its solution in nitric acid is of a light emerald-green colour. A complete account of it will be given by Professor Sennowitz, at Eperies; and a chemical analysis by Dr. Schuster, of Pesth.

In the New Annual Register for 1813, the following notice has been taken of the *Physionomies Nationales*, published at Paris:—“This tract is drawn up agreeably to the system of Mr. Blumenbach, who, *in truth*, has derived his classification from Gemlin (*sic*), with a mere variation of the names: for the five divisions under which the human species is enumerated by the former, we mean the Caucasian, Mongul, American, Ethiopian, and Malay, are only the white man, brown man, red man, black man, and tawny man of the latter.” Whoever is in the least acquainted with the respective merits of the two Professors confronted in this passage, will probably not be disposed to believe that the celebrated

author of so many original works, especially relative to the history of the human species, should have condescended to commit plagiarism on a writer, who, whatever merit his laborious works may be allowed to possess, cannot possibly lay claim to a single original idea relative to the subject in question.—The fact is, that Blumenbach published his classification of the human species as early as 1779, in the first edition of his Manual of Natural History; and afterwards (1781) in a new edition of his work *De Generis Humani Varietate*, &c. In 1788 the same division was adopted by Gmelin in his edition of Linnæus's *Systema Naturæ*, t. i. p. 23, seq. where, without mentioning the source from which he has derived them, he substitutes five names perfectly improper for designating the varieties of the human species.—*Suum cuique!*

Believe me, my dear Sir,  
Your very obedient servant,

British Museum, June 24, 1815.

CHARLES KONIG.

### VII. *Orthoceratite in a Marble.*

(To Dr. Thomson.)

DEAR SIR,

Those of your readers who feel interested in Dr. Fleming's ingenious paper on orthoceratites will find in the Philosophical Transactions for 1757, article 104th, a valuable description of a shell of the same species, discovered in a marble table at an inn in Ghent. The marble was of a coarse grain, and dusky brown colour, interspersed with streaks of white. It was 2 feet  $4\frac{7}{8}$  inches long—a concamerated tube, of a slender conical figure, and consisted of 66 partitions or concamerations, all filled with the stalactical matter of the marble. I am, Sir, yours, &c.

Aberdeen, 1815.

M. W.

### VIII. *On the Extraction of the Cube Roots of Binomials.*

By Mr. Lockhart.

(To Dr. Thomson.)

SIR,

The utility of a method for extracting the cube roots of binomials being well known to your algebraical correspondents, I am anxious that the one which I have given should, if correct, be established past all doubt.

Your correspondent, Mr. Atkinson, supposes that I have made a mistake in respect of the root relating to *t*. Let it be tried by the proper test of an equation.

$$x^3 - 252x = 1296$$

$$\text{Where } x = 18, t = 12, v = 6$$

$$\text{Then } -t = \sqrt[3]{648} + \sqrt{-172800} + \sqrt[3]{648 - \sqrt{-172800}}$$

The cube root of the first number is  $-6 + \sqrt{-48}$ , not  $-6 - \sqrt{-48}$ , as corrected by Mr. Atkinson.



*Proof.*

$$\begin{array}{r}
 - 6 + \sqrt{\quad} - 48 \\
 - 6 + \sqrt{\quad} - 48 \\
 \hline
 36 - 12 \sqrt{\quad} - 48 \\
 - 48 \\
 \hline
 - 12 - 12 \sqrt{\quad} - 48 \\
 - 6 + \sqrt{\quad} - 48 \\
 \hline
 72 + 72 \sqrt{\quad} - 48 \\
 576 - 12 \sqrt{\quad} - 48 \\
 \hline
 648 + \sqrt{\quad} - 172800
 \end{array}$$

In irreducible equations,  $t^2$  is always greater than  $\frac{b}{3}$ , therefore  $\frac{b}{3} - t^2$  would be a contradiction. When the equations are reducible,  $t$  is imaginary, and consequently has no magnitude.

I am, Sir, your obedient servant,

*Field Head, June 8, 1815.*

JAMES LOCKHART.

#### IX. *Another Explosion in a Coal-Mine near Newcastle.*

We are sorry it should so soon again be our painful duty to have to record another of those melancholy accidents which have so frequently of late occurred in our coal-mines. On the morning of the 27th ult. an explosion of inflammable air took place in the Isabella pit, at Sheriff-hill colliery, by which Mr. Fogget, viewer, Robert Fogget, underviewer, Geo. Fogget, deputy overman, John Scott, overman, Wm. Wind, Nich. Codling, Geo. Richardson, and Jas. Young, deputy overman; also Geo. Wind and Hugh Barker, boys, were unfortunately killed. During the night of the 26th, a fall of the roof, accompanied by a feeder of water, took place; the water passing into the dip workings, filled them up so as to obstruct the current of air, and an accumulation of the inflammable gas ensued. When Mr. Scott, the overman, went down the following morning, he observed that the ventilation of the mine was nearly suspended, and immediately stopped the pit's crew from going in to work until he could investigate the cause of the stagnation. This he effected in a short time, and restored the ventilation partially. He then sent to Mr. Fogget for his advice and assistance, who went down the pit without loss of time, accompanied by his two brothers, the parties above-named, and John Ledger, a boy. Had Mr. Scott not acted with this caution and judgment, it is more than likely that the lives of the whole of the crew would have been lost. Mr. Fogget, accompanied by John Scott and the other parties, then proceeded into the workings, to make such a change in the ventilation as would restore the pit to a safe working state again. While

they were employed in this operation, the gas backed against the current of atmospheric air, and exploded at the lights which were placed to *windward* of the *foul* part of the workings. Mr. George Fogget being ill, was obliged to leave his two brothers and their companions before the accident happened, and nearly reached the bottom of the pit, accompanied by Robt. Copeland, who was employed in the rail-way, when they felt the shock of an explosion. They immediately returned, and had proceeded to within 200 yards of the place where Geo. Fogget had left his brothers, when Copeland found it impracticable to go further with safety, on account of the *after-damp*. He then advised Geo. Fogget to return with him to give the alarm; but this he refused to do, and persisted in going *in-by* to look after his brothers, and James Young, his son-in-law. He unfortunately fell a victim to his exertions; he died of suffocation, and his body was found lying beside those of his two brothers. John Ledger, the only survivor, was within 20 yards of the candles at which the gas fired, and saw it fire; he was slightly hurt, but, from the effect of the *after-damp*, lay about ten hours in a state of insensibility before he could be rescued from his perilous situation. The above accident forms another powerful reason of the necessity for the establishment of some general and permanent fund for the relief of the survivors of those who suffer in the mines.

#### X. Nickel-Antimonerz.

This new ore of nickel has been lately analyzed by Dr. John. He found the constituents as follows:—

Nickel .....	23·33
Antimony, with arsenic, and a trace of iron .....	} 61·68
Sulphur .....	
Unknown body, probably lead or silver, with silica .....	} 0·83
	100·00

#### XI. New Curve.

(To Dr. Thomson.)

SIR,

By presenting to the readers of the *Annals of Philosophy* the following curve, which I denominate a *radiatrix*, you will oblige  
M. N.

*Genesis of the Curve.*—If one extremity, O, of the radius of a circle be made to trace the circumference, the other extremity, V, moving always in the direction of a given point, F, in the circumference will describe a curve called a *radiatrix*.

*Definitions.*—1. The directing point, F, is the *focus*. 2. Any straight line, FP or FP', drawn from the focus to any point in the curve is a *chord*. 3. The chords FV and FV', which pass through the centre of the circle, are the *interior* and *exterior axes*.

4. The extremities,  $V$  and  $V'$ , of the axes are the *interior* and *exterior vertices*. 5. The angle contained by a chord and the axis is the *vertical inclination* of that chord.

*Corollary 1.*—The interior axis is equal to the radius of the circle, and the exterior axis is equal to thrice that radius.

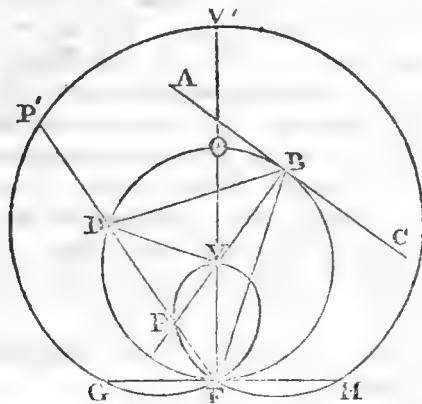

*Corol. 2.*—If radius equal unity, any interior chord,  $FP$ , is equivalent to the difference between the interior axis and the rectangle under twice that axis, and the cosine of the vertical inclination of that chord.

*Corol. 3.*—Any exterior chord is equivalent to the interior axis plus or minus the same rectangle, according as the chord is greater or less than the interior axis.

*Corol. 4.*—If a tangent,  $GH$ , to the circle at the focus be limited by the curve at  $G$  and  $H$ , it is equal to twice the interior axis.

*Problem.*—Any obtuse angle,  $ABF$ , being given, to trisect it by means of the radiatrix.

Produce  $AB$  one of the sides of the angle, and upon the other side let a segment of a circle be described, which shall contain an angle equal to the supplemental angle  $CBF$ : through  $F$  as a focus, and the centre,  $V$ , as an interior vertex, let a radiatrix be described: through the point  $P$ , where the curve is cut by the diameter, draw  $FPD$ , join  $DB$  and  $DV$ . The angle  $DBP$  is one-third part of  $ABF$ .

For since  $DV$  is equal to  $BV$ , the angle  $VDB$  is equal to  $VBD$ , and the exterior angle  $DVP$  to double of the interior angle  $DBP$ : and because  $DP$  is in the direction of the focus  $F$ ,  $DP$  is equal to the radius  $DV$ : therefore the angle  $DPV$  is equal to  $DVP$ , or is double of  $VBD$ . Now the angle  $CBF$  being equal to  $BDP$  in the alternate segment, the angles  $DBP$  and  $DPB$  are together equal to  $ABF$ : and consequently the angle  $DBP$  is one-third, and  $DPB$  two-thirds, of  $ABF$ .

*Corollary.*—The excess of  $60^\circ$  above one-third of  $ABF$  is one-third of the supplemental acute angle  $CBF$ .

XII. *Nature of Fatty Bodies.*

M. Henri Braconnot has lately made a curious set of experiments upon the fatty bodies, both animal and vegetable. He has shown that they all consist of two distinct substances: 1. A liquid oil: 2. A solid substance, analogous to wax or tallow in its appearance and properties. He separated these two bodies from each other by a mechanical contrivance. The oil is imbibed by paper, but not the wax. He therefore compressed the fatty body in the midst of a sufficient quantity of paper. The oil was absorbed, while the wax remained in a state of purity. Then by steeping the paper in hot water, the oil separated from it, and swam upon the surface of the liquid. The wax or tallow thus obtained from all the fatty bodies closely resembles myrtle wax in its properties. If the fatty body be liquid, it is necessary to congeal it, by exposure to cold, before subjecting it to pressure.

The following are the results which Braconnot obtained from different fatty bodies.

Vosges butter in summer is composed of

Oil .....	60
Tallow .....	40
	<hr/>
	100

But in winter its composition was

Oil .....	35
Tallow .....	65
	<hr/>
	100

Hog's lard was composed of

Oil .....	62
Tallow .....	38
	<hr/>
	100

Ox marrow, of

Tallow .....	76
Oil .....	24
	<hr/>
	100

Marrow of sheep, of

Tallow .....	26
Oil .....	74
	<hr/>
	100

Goose fat, of

Oil .....	68
Tallow .....	32
	<hr/>
	100

Duck fat, of	
Oil .....	72
Tallow .....	28
	<hr/>
	100
Turkey fat, of	
Oil .....	74
Tallow .....	26
	<hr/>
	100
Olive oil, of	
Greenish yellow oil .....	72
Tallow (very white) .....	28
	<hr/>
	100
Oil of sweet almonds, of	
Yellow oil .....	76
Tallow .....	24
	<hr/>
	100
Oil of colsa, of	
Yellow oil .....	54
Tallow .....	46
	<hr/>
	100

(See *Annales de Chimie*, March, 1815.)

### XIII. *Accident which happened to M. Vauquelin.*

M. Vauquelin, wishing to examine the properties of chloric acid lately discovered by M. Gay-Lussac, prepared a quantity of it according to the process of Mr. Chenevix. This process consists in saturating barytes with chloric acid, and evaporating to dryness. The saline mass is mixed with phosphate of silver, and boiled in water acidulated with acetic acid. Nothing remains in solution but chlorate of barytes, which is easily obtained in crystals. Vauquelin put 30 grains of these crystals into a platinum crucible, and exposed them to heat, in order to ascertain the quantity of oxygen gas which they contained. A violent detonation took place, and the crucible was broken and torn in a remarkable manner. Vauquelin found that these crystals were not pure chlorate of barytes. They contained likewise a mixture of acetate of barytes. To this salt the combustion was owing. Hence Chenevix's method of preparing this salt does not answer.

## ARTICLE XII.

*List of Patents.*

**THOMAS POTTS**, Batchworth Mills, Rickmansworth, in the county of Herts; for combining and applying principles already known for the purpose of producing pure fresh warm air, and of such mode or means of combination and application of principles already known to such purposes as aforesaid. March 14, 1815.

**JONATHAN RIDGWAY**, Manchester; for a method of casting and fixing at the same time metallic types on the surface of metallic cylinders or metallic rollers; or any cylinders or rollers having metallic surfaces; or on blocks of metal; or on blocks having metallic surfaces; or on flat metallic plates; for the purpose of printing patterns on cloth made of cotton or linen, or both. March 14, 1815.

**WILLIAM BELL**, Edinburgh; for certain improvements in the apparatus for manuscripts or other writings or designs. March 14, 1815.

**HENRY HOULDSWORTH**, Anderton, near Glasgow; for a method of discharging the air and condensed steam from pipes used for the conveyance of steam, for the purposes of heating buildings, or other places. March 18, 1815.

**CHARLES GENT**, Congleton, Chester, and **SQUARE CLARK**; for a method of making a swift, and other apparatus thereto belonging, for the purpose of winding silks. March 21, 1815.

**RICHARD SMITH**, Tibbington House, Staffordshire; for improvements in smelting iron stone or iron ore, lead or copper ore, and other mineral or metallic substances; also of refining crude iron, lead, copper, gold, silver, tin, and all other metals or metallic bodies; and of making and manufacturing iron. March 29, 1815.

**THOMAS BAGOT**, Birmingham; for a method and machine for passing boats, barges, and other vessels from a higher to a lower level, and the contrary, without loss of water. April 4, 1815.

**WILLIAM VAUGHAN PALMER**, Ilminster, Somersetshire; for a method of twisting and laying of hemp, flax, ropes, twine, line, thread, mohair, wool, cotton, silk, and metals, by machinery, whereby considerable saving of manual labour is effected. April 4, 1815.

**WILLIAM LOSK**, Point Pleasant, Northumberland; for a plan for fire-places or furnaces for heating ovens and boilers, and the water or other liquids contained in boilers, and for converting such water or other liquids into steam, for the purpose of working engines, and for other uses in manufactures. April 8, 1815.

**JOSHUA SHAW**, Mary-street, Fitzroy-square, London; for certain improvements in the tool or instrument called the glazier's diamond. April 14, 1815.

## ARTICLE XIII.

## METEOROLOGICAL TABLE.

1815.	Wind.	BAROMETER.			THERMOMETER.			Evap.	Rain.
		Max.	Min.	Med.	Max.	Min.	Med.		
5th Mo. May 31	S W	29.90	29.75	29.825	72	54	63.0		— C
6th Mo. June 1	N E	30.03	29.80	29.915	70	38	54.0		
	2 N W	30.03	29.93	29.980	72	55	63.5		.22
	3 W	29.93	29.83	29.880	69	56	62.5		2
	4 W	29.83	29.55	29.690	73	54	63.5		
	5 S W	29.55	29.41	29.480	71	47	59.0		
	6 S W	29.46	29.33	29.395	68	45	56.5	.45	.28
	7	29.62	29.33	29.475	72	42	57.0		○
	8 S E	29.77	29.62	29.695	72	46	59.0		—
	9 S E	29.78	29.77	29.775	73	42	57.5		
	10 N W	29.78	29.74	29.760	72	45	58.5		
	11 S W	29.73	29.67	29.700	76	41	58.5		1
	12 S	29.67	29.43	29.550	68	43	55.5		—
	13 Var.	29.43	29.21	29.320	67	50	58.5	.50	.80
	14 W	29.42	29.21	29.315	68	45	56.5		9 D
	15 S W	29.79	29.42	29.605	70	45	57.5		—
	16 E	29.79	29.50	29.645	80	55	67.5		.23
	17 S W	29.53	29.46	29.495	76	54	65.0		8
	18 S W	29.63	29.55	29.590	74	51	62.5		
	19 S	29.63	29.59	29.610	73	55	64.0		
	20 N	29.68	29.57	29.625	74	46	60.0		
	21 S W	29.81	29.68	29.745	73	50	61.5	.48	●
	22 N E	29.86	29.81	29.835	74	44	59.0		4
	23 N E	29.96	29.86	29.910	71	52	61.5		
	24 N	29.96	29.86	29.910	74	55	64.5		8
	25 N E	30.01	29.86	29.935	67	40	53.5		
	26								
	27 W	30.08	29.98	30.030	75	44	59.5		
	28 W	30.17	30.08	30.125	79	49	64.0	.30	
		30.17	29.21	29.708	80	38	60.10	1.73	1.85

The observations in each line of the table apply to a period of twenty-four hours, beginning at 9 A. M. on the day indicated in the first column. A dash denotes, that the result is included in the next following observation.



## REMARKS.

*Sixth Month.*—4. Cloudy: windy. 5, 6. Windy, with *Cumulostratus* and *Cirrocumulus*: showers. 7. Heavy clouds: and at noon a sound like distant thunder in the N. E.: towards evening the dense clouds dispersed, leaving *Cirri* at a great elevation, and a most beautiful *Cirrostratus*, grained like wood, in the N. W.: hygrometer (De Luc's)  $30^{\circ}$  to  $35^{\circ}$ . 8. A grey sky, with *Cirrocumulus*, &c. which formed heavy *Cumulostratus*, threatening thunder: but a few drops of rain falling, the whole dispersed, save some *Cirrostratus*. 9. *Cirrocumulus*, with *Cirrostratus*: a fine day: much dew at night, with  $5^{\circ}$  difference in the thermometers. 10. A very fine day: in the course of which the hygrometer went to  $24^{\circ}$ . 11. a. m. Clouds and wind, followed by a shower, p. m. 12. Overcast: hygrometer, at 8 a. m.  $62^{\circ}$ ; at 9,  $55^{\circ}$ : clouds from S. E., the wind being N. W.: a little rain: the evening obscure, with *Cirrus* and *Cirrostratus* hanging very low. 13. Cloudy morning: showers: after which large *Cumuli*, capped and followed by *Nimbi*: from one to two, p. m. heavy rain, the wind going from S. E. by S. to N. E., then back to S. W.: some thunder followed, and a fine afternoon, but the *Cirrostratus* remained at night. 14. Wet morning: hydr. at 8,  $72^{\circ}$ ; at 9,  $50^{\circ}$ : after some showers, a fine afternoon. 15. Hygr. at 9,  $55^{\circ}$ : showers and wind: fair, p. m. 16. Hygr. at 9,  $39^{\circ}$ : a fine day: *Cirrus*: a corona round the moon. 17. Hygr.  $71^{\circ}$ : wet morning, and rain in the night: a slight shower, p. m. 18. Hygr.  $52^{\circ}$ : rain in the night: rather cloudy. 19. Hygr.  $43^{\circ}$ : a pretty fine day. 20. Hygr.  $40^{\circ}$ : rather a dull day. 21. Hygr.  $55^{\circ}$ : pleasant: not very sunny: about one, p. m. a clap of thunder, and a few large drops of rain. 22. Hygr.  $49^{\circ}$ : a dull cloudy morning: a little rain, p. m. 23. Hygr.  $44^{\circ}$ : morning cloudy: pretty high wind. 24. Hygr.  $38^{\circ}$ : morning very dull: about 12, cleared up, and the sun shone very hot: p. m. cloudy again. 25. Rain in the night: p. m. sunshine at intervals. 26, 27, 28. Very fine days: hydr.  $46^{\circ}$  to  $52^{\circ}$ .

## RESULTS.

Winds Variable.

Barometer: Greatest height . . . . . 30·17 inches

Least . . . . . 29·21

Mean of the period . . . . 29·708

Thermometer: Greatest height . . . . .  $80^{\circ}$ 

Least . . . . . 38

Mean of the period . . . . 60·10

Evaporation, 1·83 inch.

Rain, 1·75 inch.

\* \* \* The observations from the 16th inclusive to the end were made, in my absence from home, by my son, Robert Howard.

TOTTENHAM,

L. HOWARD.

*Seventh Month, 10, 1815.*

ANNALS  
OF  
PHILOSOPHY.

---

---

SEPTEMBER, 1815.

---

---

ARTICLE I.

*Biographical Account of M. Parmentier.* By M. Cuvier,  
Secretary of the Institute.

THE sciences have made that degree of progress as no longer to excite such astonishment at the great efforts which they suppose, and the striking truths which they bring to light, as at the immense advantages which their application daily produces to society. There is not one at present in which the discovery of a single proposition may not enrich a whole people, and change the face of states; and this influence, far from diminishing, must daily increase, because it is easy to prove that it depends upon the nature of things.

Allow me to make some reflections on this subject, which cannot be misplaced, either in this house or before this assembly.\*

Hunger and cold are the two great enemies of our species. The object of all our hearts is either directly or indirectly to combat them.

This is accomplished by the combination and the disengagement of two or three elementary substances.

To nourish ourselves is nothing else than to replace the parcels of carbon and hydrogen which respiration and transpiration carry off. To warm ourselves is to retard the dissipation of the heat which respiration furnishes.

To one or other of these functions are devoted both the palace and the cottage; both the brown bread of the poor, and the expensive food of the glutton; both the purple of kings, and the ratters of beggars. Consequently architecture and the liberal arts,

\* This Eloge was read to the French Institute.

agriculture and manufactures, navigation, commerce, even the greater number of wars, and that great developement of courage and genius, that great apparatus of exertion and knowledge which they require, have nothing else for their final object than two simple chemical operations. Consequently the smallest new fact respecting the laws of nature in these two operations may reduce the public and private expenses, may change the tactics and direction of commerce, may transfer the power of one people to another, and may ultimately alter the fundamental relations of the classes of society.

This carbon and this hydrogen, which we consume, without ceasing, in our fires, in our clothes, in our food, are continually reproduced for a new consumption by vegetables which obtain them from the atmosphere and from water. Vegetation itself is fixed by the extent of the soil, by the species of vegetables cultivated, and by the proportion of wood, of meadows and corn-fields. It would be vain, therefore, for the most paternal government to increase the population of its territories beyond a certain limit. All its cares would be inefficacious, unless science came to its assistance. But let a philosopher contrive a fire-place which saves a portion of the fuel. This is exactly the same thing as if he had added to the quantity of our territory planted with wood. Let a botanist point out a plant which in the same space furnishes more nourishment. This is the same thing as if he had in the same proportion augmented our cultivated fields. Immediately there will be room in the country for a greater number of active men.

Happy conquests which occasion no effusion of blood, and which repair the disasters of vulgar conquests! Yes! how paradoxical soever it may appear, it is owing essentially to the progress of the sciences that society does not sink under the effects of its own fury.

Without chemistry, what would have become of all our manufactures when we were shut out from the places which furnished the raw materials? Has not vaccination preserved those children destined shortly to replace those that have been cut off by war? And to confine ourselves solely to the labours of Parmentier and Count Rumford, is it not evident to all the world that the perseverance with which the former encouraged the culture of potatoes has rendered whole countries, formerly sterile, fertile and inhabitable, and has twice saved us within 20 years from the horrors of famine; that the discoveries of the other on the best method of employing combustibles have counterbalanced the devastation of our forests, and that, applied to the preparation of food, they support even at this moment, from one end of Europe to the other, an infinite number of unfortunate persons.

Let any person reflect for a moment on the effect of a small improvement applied to so great a scale, and he will see that it must be calculated by hundreds of millions.

If I could bring before you those fathers of families who no longer hear around them the melancholy cries of want; those ma-

thers who have recovered that milk of which misery was drying up the source ; those children who no longer perish in their first years, withering like flowers in spring ;—if I could inform them to whom they are indebted for these alleviations of their misfortunes, their cries of gratitude would render it unnecessary for me to speak : there is not one of you who would not willingly exchange his finest discovery for such a concert of blessings.

You will listen therefore with some interest to the details of the life of this useful man—this is a tribute which you will pay to those labours which the progressive state of civilization requires the most imperiously.

Antoine Augustin Parmentier was born at Montdidier in 1737, of a family established for many years in that city, the chief offices in the magistracy of which it had filled.

The premature death of his father, and the small fortune which he left to a widow and three young children, confined the first education of M. Parmentier to some notions of Latin, which his mother gave him—a woman of abilities, and better informed than most of her rank.

An honest ecclesiastic undertook to developpe these first germs, on the supposition that this young man might become a precious subject for religion ; but the necessity of supporting his family obliged him to choose a situation which would offer more speedy resources. He was therefore under the necessity of interrupting his studies ; and his laborious life never allowed him to resume them again completely. This is the reason why his works, so important for their utility, have not always that order and precision which learning and long practice alone can give to a writer.

In 1755 he was bound apprentice to an apothecary of Montdidier, and next year came to continue it with one of his relations, who exercised the same profession in Paris. Having shown intelligence and industry, he was employed in 1757 as apothecary in the hospitals of the army of Hanover. The late M. Bayen, one of the most distinguished members whom that Class ever possessed, presided then over that part of the science. It is well known that he was no less estimable for the elevation of his character than for his talents. He observed the dispositions and the regular conduct of young Parmentier, contracted an acquaintance with him, and introduced him to M. Chamousset, Intendant General of the Hospitals, rendered so celebrated by his active benevolence, and to whom Paris and France are indebted for so many useful establishments.

It was in the conversation of these two excellent men that M. Parmentier imbibed the notions and sentiments which produced afterwards all his labours. He learned two things equally unknown to those, whose duty it was to have been acquainted with them : the extent and variety of misery from which it would be possible to free the common people, if we were seriously to occupy ourselves with

their happiness ; and the number and power of the resources which nature would offer against so many scourges, if we were at the trouble to extend and encourage the study of them.

Chemical knowledge, which originated in Germany, was at that time more general in that country than in France. More applications of it had been made. The many petty sovereigns who divided that country had paid particular attention to the amelioration of their dominions ; and the chemist, the agriculturist, the friend of useful arts, met equally with facts before unknown to them.

M. Parmentier, stimulated by his virtuous masters, took advantage of these sources of instruction with ardour. When his service brought him to any town, he visited the manufactures least known in France ; he requested of the apothecaries leave to work in their laboratories. In the country he observed the practice of the farmers. He noted down the interesting objects which struck him in his marches along with the troops. Nor did he want opportunities of seeing all varieties of things ; for he was five times taken prisoner, and transported to places whither his generals would not have carried him. He learned then by his own experience how far the horrors of need might go, a piece of information necessary perhaps to kindle in him in all its vigour that glowing fire of humanity which burnt in him during the whole of his long life.

But before making use of the knowledge which he had acquired, and attempting to ameliorate the lot of the common people, it was necessary to endeavour to render his own situation less precarious.

He returned then at the peace of 1763 to the capital, and resumed in a more scientific manner the studies belonging to his art. The lectures of Nollet, Rouelle and d'Antoine, and of Bernard de Jussieu, extended his ideas, and assisted him in arranging them. He obtained extensive and solid knowledge in all the physical sciences : and the place of lower apothecary being vacant at the *Invalides* in 1766, he obtained it, after an examination obstinately disputed.

His maintenance was thus secured, and his situation soon became sufficiently comfortable. The administration of the house seeing that his conduct justified his success, induced the King in 1772 to make him Apothecary in Chief ; a recompense which an unforeseen accident rendered more complete than had been intended, or than he had expected.

The pharmacy of the *Invalides* had been directed from its first establishment by the *Sœurs de Charité*. These good women, who had made a great deal of young Parmentier while he was only their boy, took it ill that he should be put upon a level with them. They made so much noise, and put in motion such powerful interest, that the King himself was obliged to draw back ; and after two years of controversy, he made the singular decision that Parmentier should continue to enjoy the advantages of his place, but should no longer fulfil its functions.

This enabled him to devote the whole of his time to his zeal for researches of general utility. From that moment he never interrupted them.

The first opportunity of publishing some results respecting his favourite subject had been given him in 1771 by the Academy of Besançon. The scarcity in 1769 had drawn the attention of the administration and of philosophers towards vegetables which might supply the place of corn, and the Academy had made the history of them the subject of a prize, which Parmentier gained. He endeavoured to prove in his dissertation that the most useful nourishing substance in vegetables is starch, and he showed how it might be extracted from the roots and seeds of different indigenous plants, and how deprived of the acrid and poisonous principles which alter it in some plants. He pointed out likewise the mixtures which would assist in converting this starch into good bread, or at least into a kind of biscuit fit for being eaten in soup.\*

There is no doubt that in certain cases some advantage may be derived from the methods which he proposes; but as most of the plants pointed out are wild, scanty, and would cost more than the dearest corn, absolute famine is the only thing that could induce mankind to make use of them. Parmentier easily perceived that it was better to turn the attention of cultivators to such plants as would render a famine, or even a scarcity, impossible. He therefore recommended the potatoe with all his might, and opposed with constancy the prejudices which opposed themselves to the propagation of this important root.

Most botanists, and Parmentier himself, have stated on the authority of Gaspar Bauhin that the potatoe was brought from Virginia about the end of the sixteenth century; and they usually ascribe to the celebrated and unfortunate Raleigh the honour of having first brought it to Europe. I think it more probable that it was brought from Peru by the Spaniards. Raleigh only went to Virginia in the year 1586; and we may conclude, from the testimony of Cluvius, that in 1587 the potatoe was common in different parts of Italy, and that it was already given to cattle in that country. This supposes at least several years of cultivation. This vegetable was pointed out about the end of the sixteenth century by several Spanish writers, as cultivated in the environs of Quito, where it was called *papas*, and where different kinds of dishes were prepared from it: and, what seems decisive, Banister and Clayton, who have investigated the indigenous plants of Virginia with great care, do not reckon the potatoe among the number; and Banister mentions expressly that he had for 12 years sought in vain for that plant; †

\* The memoir which gained the prize on this question: *Indiguer les Vegetaux qui pourroient suppléer en Temps de Disette à ceux qu'on employe communément à la Nourriture des Hommes.* Paris, Knapen, 1773, in 12mo.

† Morison, *Hist. Plant. Exot.* iii. 522.

while Dombey found it in a wild state on all the Cordillieras, where the Indians still apply it to the same purposes as at the time of the original discovery.

The mistake may have been owing to this circumstance, that Virginia produces several other tuberosé plants, which from imperfect descriptions may have been confounded with the potatoe. Bauhin, for example, took for the potatoe the plant called *openawk* by Thomas Harriot. There are likewise in Virginia ordinary *potatoes*; but the anonymous author of the history of that country says, that they have nothing in common with the *potatoe* of Ireland and England, which is our *pomme de terre*.

Be this as it may, that admirable vegetable was received in a very different manner by the nations of Europe. The Irish seem to have taken advantage of them first; for at an early period we find the plant distinguished by the name of *Irish potatoe*. But in France they were at first proscribed. Bauhin states that in his time the use of them had been prohibited in Burgundy, because it was supposed that they produced the leprosy.

It is difficult to believe that a plant so innocent, so agreeable, so productive, which requires so little trouble to be rendered fit for food; that a root so well defended against the intemperance of the seasons; that a plant which by a singular privilege unites in itself every advantage, without any other inconvenience than that of not lasting all the year, but which even owes to this circumstance the additional advantage that it cannot be hoarded up by monopolists—that such a plant should have required two centuries in order to overcome the most puerile prejudices.

Yet we ourselves have been witnesses of the fact. The English brought the potatoe into Flanders during the wars of Louis XIV. It was thence spread, but very sparingly, over some parts of France. Switzerland had put a higher value on it, and had found it very good. Several of our southern provinces had planted it in imitation of that country at the period of the scarcities, which were several times repeated during the last years of Louis XV. Turgot in particular rendered it common in the Limousin and the Angoumois, over which he was Intendant; and it was to be expected that in a short time this new branch of subsistence would be spread over the kingdom, when some old physicians renewed against it the prejudices of the sixteenth century.

It was no longer accused of producing leprosy, but fevers. The scarcities had produced in the south certain epidemics, which they thought proper to ascribe to the sole means which existed to prevent them. The Comptroller General was obliged in 1771 to request the opinion of the faculty of medicine, in order to put an end to these false notions.

Parmentier, who had learned to appreciate the potatoe in the prisons of Germany, where he had been often confined to that food, seconded the views of the Minister by a chemical examination



of this root,\* in which he demonstrated that none of its constituents are hurtful. He did better still. To give the people a relish for them, he cultivated them in the open fields, in places very much frequented. He guarded them carefully during the day only; and was happy when he had excited as much curiosity as to induce people to steal some of them during the night. He would have wished that the King, as we read of the Emperors of China, had traced the first furrow of his field. His Majesty thought proper at least to wear a bunch of potatoe flowers at his button-hole in the midst of the Court on a festival day. Nothing more was wanting to induce several great Lords to plant this root.

Parmentier wished likewise to engage the cooks of the great in the service of the poor, by inducing them to practise their skill on the potatoe; for he was aware that the poor could not obtain potatoes in abundance unless they could furnish the rich with an agreeable article of food. He informs us that he one day gave a dinner composed entirely of potatoes, with 20 different sauces, all of which gratified the palates of his guests.

But the enemies of the potatoe, though refuted in their attempts to prove it injurious to the health, did not consider themselves as vanquished. They pretended that it injured the fields, and rendered them barren. It was not at all likely that a plant which is capable of nourishing a greater number of cattle, and multiplying the manure, should injure the soil. It was necessary, however, to answer this objection, and to consider the potatoe in an agricultural point of view. Parmentier accordingly published in different forms every thing regarding its cultivation and uses, even in fertilizing the soil. He introduced the subject into philosophical works, into popular instructions, into journals, into dictionaries, into works of all kinds. During 40 years he let slip no opportunity of recommending it. Every bad year was a kind of auxiliary, of which he profited with care to draw the attention of mankind to his favourite plant.

Hence the name of this salutary vegetable and his own have become almost inseparable in the memory of the friends of humanity. Even the common people united them, and not always with gratitude. At a certain period of the Revolution it was proposed to give Parmentier some municipal place. One of the voters opposed this proposal with fury: "He will make us eat potatoes," said he, "it was he who invented them."

But Parmentier did not ask the suffrages of the people. He knew well that it was always a duty to serve them. But he knew equally that as long as their education remained what it is, it was a duty likewise not to consult them. He had no doubt that at length the advantage of his plans would be appreciated. And one of the

\* *Examen Chimique de Pommes de Terre, &c.* Paris, Didot, 1773; and *Ouvrage Economique sur les Pommes de Terre.* II Monory, 1774. Both are the same edition, with different titles.

fortunate things attending his old age was to see the almost complete success of his perseverance. "The potatoe has now only friends," he wrote in one of his last works, "even in those cantons from which the spirit of system and contention seemed anxious to banish it for ever.

But Parmentier was not one of those persons who occupy themselves exclusively with one idea. The advantages which he had perceived in the potatoe did not make him neglect those offered by other vegetables.

Maize, the plant which, next to the potatoe, gives the most economical food, is likewise a present of the New World, although in some places it is still obstinately called Turkey corn. It was the principal food of the Americans when the Spaniards visited their coasts. It was brought to Europe much earlier than the potatoe; for Fuchs describes it, and gives a drawing of it, in 1543. It was likewise spread more quickly; and by giving to Italy, and our southern provinces, a new and abundant article of food, it has greatly contributed to enrich them, and to increase their population.

Parmentier, therefore, in order to encourage its culture, had need only to explain, as he does in a very complete manner, the precautions which its cultivation requires, and the numerous uses to which it may be applied. He wished to exclude buck wheat, which is so inferior, from the few cantons where it is still cultivated.

The acorn, which they say nourished our ancestors before they were acquainted with corn, is still very useful in some of our provinces, chiefly about the centre of the kingdom. M. Daine, Intendant of Limoges, induced Parmentier to examine whether it was not possible to make from it an eatable bread, and capable of being kept. His experiments were unsuccessful; but they occasioned a complete treatise on the acorn, and on the different preparations of its food.

Corn itself was an object of long study with him; and perhaps he has not been of less service in explaining the best methods of grinding and baking, than in spreading the cultivation of potatoes. Chemical analysis having informed him that bran contains no nourishment proper for man, he concluded that it was advantageous to exclude it from bread. He deduced from this the advantages of an economical method of grinding, which, by subjecting the grain repeatedly to the mill and the sieve, detaches from the bran even the minutest particles of flour; and he proved likewise that it furnished, at a lower price, a white, agreeable, and more nutritive bread. Ignorance had so misunderstood the advantages of this method, that laws had long existed to prevent it, and that the most precious part of the grain was given to the cattle along with the bran.

Parmentier studied with care every thing relating to bread; and because books would have been of little service to millers and bakers, people who scarcely read any, he induced Government to

establish a School of Baking, from which the pupils would speedily carry into the provinces all the good practices. He went himself to Brittany and Languedoc, with M. Cadet-Devaux, in order to propagate his doctrine.

He caused the greatest part of the bran which was mixed with the bread of the soldiers to be withdrawn; and by procuring them a more healthy and agreeable article of food, he put an end to a multitude of abuses of which this mixture was the source.

Skilful men have calculated that the progress of knowledge in our days relative to grinding and baking has been such, that abstracting from the other vegetables which may be substituted for corn, the quantity of corn necessary for the food of an individual may be reduced more than a third. As it is chiefly to Parmentier that the almost general adoption of these new processes is owing, this calculation establishes his services better than a thousand panegyrics.

Filled with a kind of enthusiasm for arts which he appreciated according to their utility, Parmentier would have wished to have regulated by that basis alone the consideration and circumstances of those who exercised them. He laments particularly the condition of the baker, whose labours are so severe, whose industry is subjected to regulations often vexatious, and who never fails to become one of the first objects of the fury of the people on the least appearance of scarcity. His good heart made him forget that this is precisely one of the conditions of the existence of a great society, that the trades necessary for life should be brought to such a degree of simplicity, that no long time nor much money is necessary to learn them, and that of course those who practise them cannot demand great salaries. No nation could exist if the labourer pretended to require the same treatment as the physician, or the baker as the astronomer. Besides, it does not appear that the proportion of recompence is so much to the disadvantage of the mechanics; for we see many more of them make fortunes than of philosophers or artists.

Ardent as Parmentier was for the public utility, it was to be expected that he would interest himself much in the efforts occasioned by the last war to supply exotic luxuries. It was he that brought the syrup of grapes to the greatest perfection. This preparation, which may be ridiculed by those who wish to assimilate it to sugar, has notwithstanding reduced the consumption of sugar many thousand quintals, and has produced immense savings in our hospitals, of which the poor have reaped the advantage, has given a new value to our vines at a time when the war and the taxes made them be pulled up in many places, and will not remain less useful for many purposes, even if sugar should ever again fall in this country to its old price.

These labours, purely agricultural or economical, did not induce Parmentier to neglect those more immediately connected with his

original profession. He had published in 1774 a translation, with notes, of Model's Physical Recreations, a work in which the pharmaceutical preparations occupy a greater space than the other parts of the natural sciences: and in 1775 he published an edition of the Hydraulic Chemistry of Lagaraze, which is scarcely any thing else than a collection of receipts to obtain the principles of medicinal substances without altering them too much by fire. Probably he would not have remained a stranger to the great progress which chemistry made at this period, had not the disputes, of which we have given an account, deprived him of the laboratory of the Invalids. We may say likewise that his chemical examination of milk and of the blood, along with our associate M. Deyeux, constitute models of the application of chemistry to organized bodies and their modifications.

In the first of these works the authors compare with woman's milk that of the domestic animals which we chiefly employ; and in the second they examine the alterations produced in the blood by inflammatory, putrid, and scorbutic diseases—alterations often scarcely sensible, and far from explaining the disorders which they occasion, or at least which they accompany.

We have seen above how Parmentier, being by pretty singular accidents deprived of the active superintendance of the Invalids, had been stopped in the natural line of his advancement. He had too much merit to allow this injustice to continue long. Government employed him in different circumstances as a military apothecary; and when in 1788 a consulting council of physicians and surgeons was organized for the army, the Minister wished to place him there as apothecary; but Bayen was then alive, and Parmentier was the first to represent that he could not take his seat above his master. He was therefore named assistant to Bayen. This institution, like many others, was suppressed during the period of revolutionary anarchy, an epoch during which even medical subordination was rejected. But necessity obliged them soon to re-establish it under the names of *Commission* and *Council of Health for the Armies*; and Parmentier, whom the reign of terror had for a time driven from Paris, was speedily placed in it.

He showed in this situation the same zeal as in all others; and the hospitals of the army were prodigiously indebted to his care. He neglected nothing—instructions, repeated orders to his inferiors, pressing solicitations to men in authority. We have seen him within these few years deploring the absolute neglect in which a Government, occupied in conquering, and not in preserving, left the asylums of the victims of war.

We ought to bear the most striking testimony of the cares which he took of the young persons employed under his orders, the friendly manner in which he received them, encouraged them, and rewarded them. His protection extended to them at what distance soever they were carried; and we know more than one who was indebted

for his life in far distant climates to the provident recommendations of this paternal chief.

But his activity was not restricted to the duties of his place ; every thing which could be useful occupied his attention.

When the steam-engines were established, he satisfied the public of the salubrity of the waters of the Seine. More lately he occupied himself with ardour in the establishment of economical soups. He contributed materially to the propagation of vaccination. It was he chiefly who introduced into the central pharmacy of the hospitals at Paris the excellent order which reigns there ; and he drew up the pharmaceutic code according to which they are directed. He watched over the great baking establishment at Scipion, where all the bread of the hospitals is made. The *Hospice des Menages* was under his particular care ; and he bestowed the most minute attention on all that could alleviate the lot of 800 old persons of both sexes, of which it is composed.

At a period when people might labour much, and perform great services, without receiving any recompense, wherever men united to do good, he appeared foremost ; and you might depend upon being able to dispose of his time, of his pen, and, if occasion served, of his fortune.

This continual habit of occupying himself for the good of mankind, had even affected his external air. Benevolence seemed to appear in him personified. His person was tall ; and remained erect to the end of his life ; his figure was full of amenity ; his visage was at once noble and gentle ; his hair was white as the snow—all these seemed to render this respectable old man the image of goodness and of virtue. His physiology was pleasing, particularly from that appearance of happiness produced by the good which he did, and which was so much the more entitled to be happy that a man who without high birth, without fortune, without great places, without any remarkable genius, but by the sole perseverance of the love of goodness, has perhaps contributed as much to the happiness of his race as any of those upon whom Nature and Fortune have accumulated all the means of serving them.

Parmentier was never married. Madame Houzeau, his sister, lived always with him, and seconded him in his benevolent labours with the tenderest friendship. She died at the time when her affectionate care would have been most necessary to her brother, who had for some years been threatened with a chronical affection in his breast. Regret for this loss aggravated the disease of this excellent man, and rendered his last days very painful, but without altering his character, or interrupting his labours. He died on the 17th December, 1813, in the 77th year of his age.

## ARTICLE II.

*On the Origin of the Carbureted Hydrogen Gas of Coal-Mines.*  
By Mr. John B. Longmire.

(To Dr. Thomson )

SIR,

THE carbureted hydrogen gas of coal-mines having lately attracted the attention of philosophers, as well on account of the ravages it commits, when ignited, on the mines and miners, as on its mode of formation, I have drawn out the following essay from a manuscript copy of observations made on this gas in different parts of England, Wales, and Scotland; and if you think it so interesting as to ensure its insertion in your *Annals of Philosophy*, it is very much at your service.

I am, Sir, your very humble servant,

June 30, 1815.

JOHN B. LONGMIRE.

Many opinions have been entertained respecting the origin of the inflammable air of coal-mines. Some writers attribute its existence in these mines to the agency of iron pyrites: the pyrites, they say, decomposes the water, unites with its oxygen, and becomes sulphate of iron or green vitriol, while its hydrogen is set at liberty in a gaseous state. Other persons assert that the coal is undergoing a slow decomposition, and that the inflammable air and carbonic acid gas are given out by it in consequence. And other persons maintain the opinion that it exhales from the putrefying animal and vegetable matter in the stagnant water of coal-mines. But before we conclude as to its origin, let us carefully examine its mode of entry into the mine.

The carbureted hydrogen gas proceeds from the body of the coal, and generally enters the mine from the pores, sometimes from the seams of distinct concretions, and occasionally from small rents of the coal. A miner extends a common working at the rate of two or three yards every week; and if he is cutting through the gas-yielding parts of the coal, they generally discharge all their gas, or as the miner calls it, "bleed off," as fast as he advances; so that the greatest quantity of the gas always enters a working near its forehead. But, although the gas is exhausted in the most of these workings as fast as they are driven, there are many places where the coal continues to yield gas for several weeks, or months, after workings are driven past them. This gas, besides entering the mine from the coal, sometimes proceeds from small rents in the incumbent strata. In many of the coal formations these rents are small, not numerous, and generally only simply filled with gas; but in some they are large, numerous, and filled with gas, which appears to have been forced into them by a compressing power; for on



meeting with them, it issues into the mine with a considerable velocity. These gas-yielding rents are frequently met with in the coal-mines round Newcastle-on-the-Tyne; and the gas is often discharged into these mines in such streams, as to be compared, in force and quantity, with the air from powerful blast furnaces; but the quantity of gas discharged, however great at first, continually decreases till the rents cease to yield it.

The gas-yielding parts of the coal differ considerably in dimensions; they are situated at variable distances from one another; and the quantity of gas varies very much in different parts, as well as in different situations in any one part. Sometimes the gas-yielding parts have the characteristic appearance of the common coal, but occasionally they are softer, in small pieces, or dusty; in some parts iron pyrites is abundant; in others it is not found; water sometimes enters the mine along with the gas, but often the gas comes off alone; but the coal has its characteristic appearance, or is soft, in small pieces, or dusty, in many parts which give out water, but not gas; so that the parts which produce this gas, *apparently*, are not essentially different to those which do not produce it.

When the carbureted hydrogen gas leaves the coal alone, it comes off silently; but when accompanied with water, it always makes a noise. When it enters the mine, along with water, from many pores, in small quantities, and at intervals, various sounds are produced, which have some resemblance to those expertly made on the musical glasses, but which are not so loud, though more agreeable. If the gas escape much quicker, the sounds are considerably lower, but not so various as in the first instance: this is a simmering noise, and would be well imitated by the noise from the pipes of a few tea-kettles when boiling gently. But if the gas escape more copiously than in the last instance, it makes a hissing noise, not unlike, but not so loud; as that made by the steam escaping quickly from the safety valve of a steam-engine.

If the gas is set on fire as it enters a working, when the atmospheric current is traversing the mine, its inflammation is carried on, close to the sides of the coal wall, under different circumstances. Where the gas enters the mine sparingly, but from many pores and seams, to set it on fire, the candle must be moved in every direction along the sides or forehead of a working; then it will inflame the gas issuing from one pore, after it has done so with that from another as it moves forwards; and each inflammation will resemble in sound and appearance that which is produced by the firing of two or three grains of gunpowder. When it enters more abundantly after the gas from one pore is fired, the burning gas fires the gas from many other pores, during which the flame flies from the first pore in a very varying direction, and in a very fantastic and entertaining manner; for sometimes it runs horizontally for a small distance, then bends obliquely in different directions, then perhaps horizontally, and then obliquely again, till it ceases. During these



motions the flame of the gas issuing into the mine from the first pore touched the gas from an adjoining pore, and set it on fire, which did so with the gas from a third pore, and thus the motion of the flame continued; but as the gas issues from every pore at intervals, the portion set on fire at the first pore was consumed before another issued from it, but not before it inflamed the portion of gas then escaping from the second pore, which, though consumed before another portion left that pore, communicated with the gas of a third pore, and so on. In this manner the flame's flitting motion was produced. When the gas escapes from the pores of the coal in constant streams, or at least in a succession of portions at very small intervals, the flame is stationary at every pore.

With the help of these remarks, we may make the following conclusions as to the origin of the carbureted hydrogen gas of coal-mines. It is a part of the matter of the coaly strata; but how it is separated we cannot exactly determine. It may be set at liberty by the action of the component parts of the coal on one another; but not in the way of decomposition by fermentation. Or it may consist of an original redundancy of volatile matter which has been kept in by pressure, but which, as soon as hollows are made into the coal, is suffered to escape. The gas, by either mode of formation, may very well exist in the rents above the coal: for as these rents were forming, room was made for the gas to lodge in; and, to account for its degree of compression, we know that it afterwards escapes from the coal with a great force, and, if suffered to fill hollows like these rents, would leave them with a similar velocity.

---



---

### ARTICLE III.

*On the Connexion between the Vascular and Extra Vascular Parts of Animals.* By Anthony Carlisle, Esq. F.R.S.

(To Dr. Thomson.)

SIR,

*Soho square, July 3, 1815.*

THE following memoir having been partially made known to the public, I beg you to lay it before your scientific readers, as a means of preventing misrepresentation or piracy.

Sir, your obedient servant,

ANTHONY CARLISLE.

General or comparative anatomy, the great branch of natural knowledge on which the rationale of the medical art is founded, has lately risen in esteem, and is every day more accurately and more extensively cultivated. Considering how intimately the discovery of new facts, their relation to each other, and the physiological in-

ferences to be drawn from them, are connected with the previous establishment of definite views, of clear intelligible terms, and of strict physical methods; and feeling the importance of the present subject, I hasten to submit this memoir to competent judges.

I am aware that premature generalizations of facts, as well as premature inductions from them, are seldom useful; and I should not have troubled the scientific inquirer with this communication, had I not felt assured that the present state both of anatomy and physiology would authorise it. In my statements I shall purposely avoid all metaphysical pretension to dive into the hidden mystery of vitality, confessing myself wholly incompetent to reduce that power within the rules of physical science: a power which appears to my judgment as allied to the nature of an inscrutable First Cause, or as an emanation from it.

The vast variety in the substances, texture, bulk, and combinations, which the living animal and vegetable kingdoms exhibit, renders it difficult to define the essential residence of life as connected with any of the modes of organic structure. Some of the compounds and textures of animals are known to be more important for the maintenance of life than others, as the cerebral substance and the muscular textures; but there is a numerous tribe of living bodies that appear to be wholly destitute of those peculiar parts, of which the entire vegetable kingdom may be adduced as an instance. Habits of meditation and research have led me to conclude that some benefit may arise to physiology from more accurate discriminations between the several substances of living bodies; especially as to the relative dominion of vitality, or of physical causes on those substances respectively.

The active phenomena of life appear to be generally distinct from those of physical causation; but the passive condition of living substances is not so obvious. The suspended actions of torpid animals and vegetables, and the latent vitality of many of the more simply constructed animals and vegetables during the absence of heat and moisture, show the intimate connections which subsist between vitality and physical causes. Difficult and intricate as the investigation may seem when extended to all the cases of vital phenomena, they are not so in the grosser examples to be now adduced; and if it should be found that many substances distinctly continuous with vital organic bodies are wholly subjected to physical dominion, and that several other substances are in part influenced by the one cause and by the other, it may perhaps open new and more precise views in the medical art. Those parts of living organic bodies which have no power of self repair, which hold no continuity with the fluid circulating material destined to replenish the waste, to augment the bulk, or repair the accidents of the living fabric, may be justly deemed extra vital. The exuvial coverings and defences of animals are of this kind, viz. hairs, nails, feathers, and all other cuticular structures, as well as the epidermoid coverings or husks of the vegetable kingdom. Some of those substances which are destined

to be worn away retain a partial continuity with the organic system of circulating fluids, as the organic bulbs of hair, the roots and lamellæ of nails and hoofs; whilst the other parts, which are destined to be shed, as feathers and cuticular scales, are wholly detached from the vascular communion after their complete formation, and only adhere mechanically to the living parts for a time.

The most apposite illustrations, and the most positive instances, of union between vital and extra vital parts are to be found in the testaceous tribe of animals. After a long continued and careful investigation, I am fully convinced that the shells of all the vermes of Linnæus are extra vascular from their commencement, and remain so during their whole connexion with the living creature. The first production and the growth of those shells always depends upon a deposit of the material thrown out from the surface of the body of the living animal. The figure and colours of the several parts of those shells in every species depend upon the shape and the colouring glands of the modelling organs: fractures are repaired by spreading a cretaceous fluid over the inner edges, and never by any exudation from the fractured parts, since they always retain the angular broken surfaces after such repairs. Extraneous bodies are equally coated with shell, whether they are in contact with the parent shell or not. The first may be seen in the frequent envelopment of Neides in the common oyster; and the latter has been often ascertained by experiments made for the purpose of creating artificial pearls, and which might, if skilfully practised, yet prove very successful. The borings of parasitical vermes into shells are never filled up, or the bored surfaces altered, unless such borings penetrate into the cavity where the living animal dwells, and then the apertures are invariably plugged up, or smeared over with pearly matter. The water-worn outer surfaces of old shells, and other external abrasions, are never repaired, which is to be seen in old living oysters exposed to the moving friction of currents or strong tides; in the worn-off spines of the *pholas dactylis*; and in the convex points of the two valves of old *mytili*, especially the *mytilis unatinus*. I have sought in the most extensive collections of the metropolis for examples of fractures, and other injuries, which have occurred to the shells of living vermes, and I have collected many remarkable specimens. They all demonstrate the same results, without any exception. I have made numerous experiments upon the garden snail (*helix nemoralis*), by fracturing and breaking away the shell in various parts; and have always found the repairs to be effected from within by first smearing over an epidermoid varnish, and then by plastering the inner surface of that film with successive calcareous laminae. I have in vain attempted to inject the shells of recent vermes from the vascular parts of their bodies, and am fully satisfied that none of their albuminous or gelatinous testaceous membranes were ever at any time permeable to vessels; indeed they do not possess any of the reticular texture or arborescent pores which are common to all vascular parts; but, microscopically examined;

they resemble the exuvial or epidermoid membranes. To these facts may be added the notorious circumstance of the unchangeableness of the outer surfaces of testaceous shells during their growth, and the continual renewal of their other surfaces, which admit of contact with the living inhabitant: next the stains and coloured transudations which they often derive from metallic salts and other colouring materials placed in their vicinity: and, lastly, that such occurrences do not affect the living animal. The mechanical connexion or contact that subsists between the living animals which occupy the testaceous shells, and their extraneous dwellings are in many instances very slender. The common oyster possesses its first pair of valves, consisting of single laminæ, before it quits the parental organs. A muscle passes between the centres of the cavity of each shell adhering to each, and it acts upon the valves nearly at right angles. The animal has no other continuity with the shells. At the hinge an elastic substance is wedged in, the spring of which is excited by compression, but it does not possess the property of extension beyond its passive state; when dried, this substance cracks into cubes. As the animal grows, it augments the margin of its shells, and thickens them by adding new laminæ on their insides. The muscular adhesion glides forward, still keeping to the centre of the valves. The elastic substance at the hinge is augmented along its inner surface only, and must have been always deposited during the expanded state of the valves, since the limit of its elastic condition is exactly adapted to that state. As the laminæ of the shells increase, there is a gap at the outside of the hinge filled with soft, crumbling, and decomposing worn-out elastic ligament. This gap presents two inclined planes which meet in an acute angle, and that space is kept free from pebbles and hard extraneous bodies by the presence of the decomposing ligament, as such an accident would prove fatal by preventing the opening of the valves. The growth of all the testaceous shells affords remarkable proofs of their extra vascular formation. The muscular adhesions are generally the only parts of continuity between the animal and its shells, and these are constantly changing with the augmentations of bulk. In all the conoid univalves which revolve upon spiral axes the successive parts of the shell are merely spread upon the older parts without any intermixture of their substances, and epidermis or extraneous bodies are alike involved in the successive folds. In other classes of animals similar phenomena occur. The calcareous shells of birds' eggs are merely deposited upon the *membrana putaminis*, and the inner portions are regular crystallized prisms, the long diameters of which point to the centre of the egg. These shells are wholly extra vascular, and their albuminous membranes are alike cuticular, whilst the inner true *membrana putaminis* is made reticular, and capable of vascular organization. The order of deposit in these examples is like that of enamel in teeth, which appears to be precipitated upon the bone of the teeth under the guidance of a membranous case or mould. From a disordered fowl I have seen eggs produced;

the calcareous crusts of which were inflated with bubbles, so as to form a cancellated shell, in texture like pumice-stone. The most durable substances of animal bodies, such as the bones and teeth, are only partly vascular, since their calcareous materials are fixed by chemical precipitants, and remain under chemical laws. Injuries done to the horns of cattle, to the hoofs of animals, and to human nails, are never restored; these parts do not possess the power of self repair; and it is only by the mechanical wearing away that such injuries are obliterated. Indeed the beneficent construction of animal nature is sufficiently manifested in the insensibility of all the exuvial coverings, and in the organic composition of many parts which are exposed to mechanical attrition, as the enamel of teeth, the horny beaks of birds, and the cuticular or horny coverings of feet. The same beneficence appears to be extended to many parts of the internal organic substances, by which painful sensations are obviated, whilst the substances themselves being less directly under the dominion of the vital superintendency become more permanent; such parts are the tendons, ligaments, cartilages, cellular tissue, the gelatine and lime of bones; even water is an essential constituent of the animal fluids, and affords the necessary softness and flexibility to solids. But this subject, and its connexion with the vegetable composition and texture, extends far beyond the limits of a memoir; and I must therefore suspend my observations.

(To be continued.)

---

#### ARTICLE IV.

*Further Observations on Fluxions.* By Alexander Christison, Esq. F.R.S.E. Professor of Humanity in the University of Edinburgh.

(To Dr. Thomson.)

MY DEAR SIR,

Edinburgh, July 19, 1815.

AN experienced mathematician will find no difficulty in the reasoning, *Annals of Philosophy*, vol. v. pp. 330 and 331; a learner, however, will understand that reasoning better if he suppose the accent, which is put after the  $y$  at the top, to be put not at the top, but half way down the side of the  $y$  in p. 330, line 40; and likewise wherever that letter so occurs afterwards with one or two accents, unless there be two letters in the numerator; and if he read  $i$  for  $z$  after the mark of equality in the last line but one of p. 330, and in the second line of p. 331.

You may insert the following observations.

It is evident from fig. 2, p. 328, that the ratio of the increments is never the ratio of the fluxions; for at F H, 5 minus one centillionth to -1 is too small, and 5 plus one centillionth to 1 is too

great. Newton's expression, therefore, "The ultimate ratio of the increments is the ratio of the fluxions," is incorrect, and seems to have misled the Bishop of Cloyne. If a man is not a soldier, he may be the last of the men in a train, but, in that train, he cannot be the last of the soldiers. Newton, therefore, must be understood rationally, not literally; the literal interpretation, indeed, is impossible. In Milton too, the literal interpretation of "The fairest of her daughters, Eve," is also impossible. Such incorrectness of expression is frequently found in Robins. I do not remember that Maclaurin has corrected it till article 505, in the second volume of Fluxions. Maseres has rectified it more directly in p. 21 of the preface to the fifth volume of the Logarithmic Writers. Euler has fallen into the same mistake in his Definition of the Differential Calculus, in p. 8 of the preface.

I am inclined to think that, in p. 468, Harvey's idea of developing generated quantities is better than mine of generating them. It was to avoid the idea of motion that, in the demonstration, which I think is new, I employed bisection like the ancients. I might have avoided the idea of motion in the solution too; for I might have solved as Lacroix does in the beginning of his Calcul in 8vo. As the fluxional calculus was derived from the celebrated problem of the tangents, I think that the easiest and shortest demonstration is to be obtained from the same source. I consider such a demonstration as an extension of Descartes' application of algebra to geometry. I think that no rigorous demonstration of the fluxional problem purely algebraical can be so short as that in pp. 330 and 331; it occupies no more than twelve entire lines, as it properly begins at line 33, p. 330, and ends at line 8, p. 331; for, in order to prove that the limits of a variable quantity are equal, I might have referred to Robins, vol. ii. p. 56, art. 120; or to Lacroix Calcul, vol. i. p. 18. D'Alembert observes, that all the differential calculus may be referred to the problem of the tangents.

Without the aid of a diagram, the application to tangents, quadratures, cubatures, rectifications, and complanations, is much more difficult and tedious to a learner. This is evident from Lagrange.

Motion conceived may be rigorously mathematical; not so, motion executed. Now in fluxions it is motion conceived only that comes under consideration.

With regard to Newton's second lemma, as a square is simpler than an oblong, if we subtract the square of  $A - a$  from that of  $A + a$ , there will remain  $4 A a$ , of which the half is  $2 A a$ ; and then as the momentum is evidently greater than the decrement, and smaller than the increment, when the rate of change thus varies, we may prove by reduction to absurdity that the momentum of  $A A$  can be neither more nor less than  $2 A a$ ; for it may be demonstrated to differ less from  $2 A a + a a$ , the increment, than by any assigned quantity how small soever: and, in  $\frac{2 A a}{a}$ , if the



momentum  $a$  be multiplied by  $i$ , an indeterminate quantity, and if  $x$  be substituted for  $A$ , we shall have  $\frac{2 A a i}{a i} = \frac{2 x \dot{x}}{\dot{x}}$ . We next, by Maclaurin's process, Fluxions, art. 708, get the fluxion of an oblong, thence that of a cube, &c. Thus Newton's demonstration seems superior in brevity, and equal in rigour, to that of any of his contemporaries and successors at home or abroad; for it has evidently no dependance whatever on motion, or on infinitesimals, or on vanishing quantities, or even on limits. It is wholly algebraical, but may, by a diagram, be rendered geometrical. I think the demonstration in Newton's second lemma one of the finest productions of his unequalled genius. The conception of motion, from which Maclaurin demonstrated so very tediously, belongs not to Newton's demonstration, but to his idea of the continuous generation of quantity. It seems to be through Maclaurin that some very eminent foreign mathematicians see and blame Newton.

Robins, from what Newton says himself, observes that Newton in his Mathematics uses the word momentum in two senses: first, for an infinitely small quantity, when he solves; and secondly, when he demonstrates, for an indeterminate quantity which is to be conceived to vanish: in the first sense,  $\frac{o}{o} = \frac{\dot{y}}{\dot{x}}$  for example;

here the quantities really employed are  $\frac{\dot{y}}{\dot{x}}$ , not  $\frac{o}{o}$ : but it is evident that in the second lemma he uses the word momentum in a third sense: for it is there neither a quantity which is to be conceived to vanish, nor is it  $\dot{y}$  or  $\dot{x}$  till it be multiplied by an indeterminate quantity  $i$ .

From Newton's second lemma we obtain the easiest demonstration of the binomial theorem for any exponent; because from the first fluxion we obtain the second, &c. Now these are the successive fluxional coefficients. We have therefore only to multiply them by the successive powers of  $i$ , and to divide the terms by 1,  $1 \times 2$ ,  $1 \times 2 \times 3$ , respectively. This would not be a legitimate demonstration, if the binomial theorem had been previously employed to find the fluxions. No one, I think, will say this is demonstrating the binomial theorem by employing the higher mathematics; for in my former paper I showed that much of fluxions belonged properly to the very elements of geometry and algebra.

From fig. 3, p. 330, it is easy to demonstrate that any term  $\frac{n \cdot n - 1 x^{n-2}}{1 \cdot 2} i$ , for example, may be not greater only, but greater in any proportion than the sum of all the succeeding terms; for if  $n x^{n-1}$  be transferred, with the negative sign, to the other side, and if the equation be then divided by  $i$ , the thing is evident. Lagrange's demonstrations are not so easy: it is extremely tedious and teasing for a learner to proceed by his method to tangents, quadratures, &c.; a proof that his method of investigation and demonstration, how refined and convincing soever, is not short and



easy, but circuitous and difficult. Thus the learner may think with regard to Lagrange's process; but the learned will admire its generality, vigour, consistency, and important applications. Why is not the Calculus of Variations, the noble discovery of Lagrange, admitted into our initiatory books? Much of it is quite elementary, and its nature is easily apprehended.

It appears to me also that much of the *Mécanique Analytique* is elementary, and may be taught early. Can any thing be easier and simpler than the two formulas, the one for statics, the other for dynamics? How delightful will the study of that comprehensive treatise, and of Laplace's masterly work the *Mécanique Céleste*, be, if the learner previously understand, as he easily may, the paralleliped of forces, the three perpendicular axes of rotation, the three perpendicular co-ordinates, the three co-ordinated planes, the principle of virtual velocities, and be accustomed to introduce by substitution the sines and co-sines, &c.? Nothing will allure a learner more than to study the way in which Euler, vol. ii. of *Introduction to the Analysis of Infinites*, employs the sines and co-sines in changing the position of the co-ordinates. May not the student also learn early, in that fine performance, the generation of curves from their equations, and the progressive induction of those equations without end?

I wish Lagrange had been more precise in the titles of his two books, *Theory of Analytical Functions*, *Calculus of Functions*; for, as his *Theory* does not include geometrical analysis, it relates to algebraical functions only, and not to them all; for it does not relate to common functions of known and unknown, of constant and variable, quantities; it therefore relates to derived functions only; and not even to them all; for let any one consider Arbogast's *Derivations*, and he will see that it does not relate to derived functions where the operations, not the quantities, are derived from each other; it is, consequently, the theory of fluxional or differential functions direct and inverse.

Here let me remark, that the views of perhaps all the writers on the important subject of fluxions relate more or less directly to the doctrine of ratios,  $\frac{y}{x}$ ,  $\frac{d y}{d x}$ ,  $f \cdot x = \frac{d y}{d x}$ , according to Lagrange's own statement; for, in every fraction, is not the numerator the antecedent, and the denominator the consequent, of a ratio?

The observations of Lacroix and other eminent mathematicians may remove the difficulties which learners always find, in consequence of the differential and the integral notation, as the differences of the absciss and of the ordinate are not employed, nor the integer of a fraction, nor the sum of quantities; the notation, however, is extremely convenient, and will not puzzle a learner, if its defect be supplied by a very careful explanation.

Even variation is not a very happy word, for variation may be either starting or continuous. Fluxion is the happiest word that I know, as it marks a continuous, not a starting, change: and since

variations as a calculus succeed fluxions in the order both of nature and of invention, the proper appellation, perhaps, would have been subfluxions, with a suitable notation. It would be improper, however, to propose any change.

With regard to the fluxional notation,  $\frac{ny}{x^n}$  seems as convenient as  $\frac{d^n y}{d x^n}$ , while the latter  $d$  is preserved for algebraic operations; and  $f$  seems as convenient as  $s$  for marking the fluent. In a philosophical point of view, there is no comparison.

I sometimes hear mathematicians say, We ought to adopt the foreign notation. Would not such adoption be to attempt, as far as it is in our power, to efface the knowledge of one of Newton's greatest discoveries? Would it not be also unpatriotic? Independently of a natural patriotism, and of the respect due to Newton, would a change rather unphilosophical be a change for the better?

To some it may seem a digression, that the formula  $\frac{1st \times A}{2d \times B} = \frac{3d \times A}{4th \times B}$  is derivable by a boy from the simplest operation in the Rule of Three; that in the eighth of a line it contains Euclid's fifth definition of eight lines in his fifth book; that it comprehends all proportional quantities, whether commensurable or incommensurable; and that Euclid, it is probable, thus deduced the definition.

The mistake of a very able mathematician, Carnot, in his *Mécanique du Calcul Infinitésimal*, where he endeavours to show that the differential equations are imperfect, seems to arise from his not distinguishing sufficiently the differences or increments from the fluxions or differentials.

From all that has been said we may conclude, that no demonstration ought to depend on motion, if motion can be avoided, but that motion is either mathematical or mechanical: that no demonstration of the fluxional problem can be rigorous and satisfactory that depends on infinitesimals and on vanishing quantities: that though, in compliance with custom, I said in p. 331, line 24, "vanishing quantity," yet it is not strictly a vanishing quantity, but a quantity which, by the continued bisection of the increment of the abscissa, may become less than any assigned quantity how small soever: that in my former paper I might without fig. 1 or 2 have stated and demonstrated by fig. 3 the doctrine of fluxion in the form of a theorem; or in the form of a problem thus, prop. problem, to find the fluxion of any function of a variable quantity: or thus, prop. problem, to find the rate, &c. To find the rate of change in a quantity and its function. This procedure would have been more scientific and elegant, not more intelligible, than that which I employed: that Newton's lemma consists of two parts; first, of the conception of the generation of quantity by motion; and, secondly, of the demonstration which relates neither to mo-

tion, nor to infinitesimals, nor to vanishing quantities, nor even to limits except indirectly: that fluxions, and variations which are also fluxions, ought to be taught among the very elements of geometry and algebra: that curves are most easily conceived and understood from their equations, not from the sections of solids: that the sections of cones and of other solids may be very requisite in masonry, carpentry, civil and military engineering; but that the student of general science, without neglecting these sections, ought, soon after he knows the fourteenth proposition of Euclid's second book, and a little of algebra, to acquire the principles of fluxions, availing himself of that knowledge to render his progress continuous from Euclid through conics, which he will do by taking the equations to the ellipse, &c. from that to the circle: and that, if such a method be followed, a diligent student will leave our Universities with a competent knowledge of Newton, Euler, Lagrange, Monge, Laplace, and many others, and of any department of natural philosophy to which their mathematical researches are applicable.

---



---

## ARTICLE V.

*A Memoir on Iodine.* By M. Gay-Lussac.

(Concluded from p. 132.)

### *Historical Note on the Discovery of Iodine.*

IT was about two years after M. Courtois had discovered iodine that M. Clement announced it to the Institute on the 29th November, 1813. M. Courtois had observed several of its properties, and particularly that which it has of forming a very fulminating powder when treated with ammonia. He intended to have ascertained all its properties; but being prevented by the attention required by an extensive manufactory of nitre, he engaged M. Clement to continue his researches. M. Clement, from similar motives, could only consecrate to it a few moments. However, he obtained a great number of results, as may be seen by the note printed in the *Ann. de Chim.* lxxxviii. 304. He discovered that by the combination of iodine and phosphorus a gaseous acid is obtained; but he concluded from his experiments that this acid was composed of about  $\frac{1}{3}$  muriatic acid and  $\frac{2}{3}$  iodine. M. Clement was employed in these experiments when Sir H. Davy came to Paris; and he thought that he could not better receive so distinguished a philosopher than by showing him the new substance, which he had likewise shown to MM. Chaptal and Ampere. I state these circumstances to answer a strange assertion which we find in the *Journal of Messrs. Nicholson and Tilloch*, No. 189, p. 69:—"It appears that this gas (iodine) was discovered above two years ago; but such is the deplorable state of scientific men in France, that no account of it was published till

the arrival of our English philosopher there." It is Sir H. Davy of whom they speak. Soon after showing iodine to Davy, and communicating to him the result of his experiments, M. Clement read his note to the Institute, and concluded by announcing that I was going to continue the subject. On the 6th of December I read a note to the Institute on the subject, which was printed in the *Moniteur* of the 12th of December, and afterwards in the *Annales de Chimie*, lxxxviii. 311. It is needless to say here that the results which it contained determined the nature of iodine, and that I there established that it is a simple body analogous to chlorine. Nobody hitherto has disputed that I was the first who discovered the nature of iodine: and it is certain that Davy did not publish his results till more than eight days after having known mine.

◆

#### NOTE A.

When we make iodine, an alkaline oxide, and water, act upon each other at once, there is formed in general an iodate and hydriodate, or, if you choose, an ioduret. The oxygen which acidifies the iodine may be furnished either by the alkaline oxide or by the water. Let us examine which of these two in all probability furnishes it. When we employ potash, we may admit that it is it which furnishes the oxygen to the iodine; for as iodine disengages oxygen from the potash at a red heat, we may conceive that the same thing takes place at the ordinary temperature by means of water; especially if we consider that here two products are formed, iodate and ioduret, and that there are of consequence two forces which tend to decompose a portion of the potash. The same thing may be said of soda, from which iodine likewise separates the oxygen at a red heat; and of all the oxides in which the oxygen is but weakly condensed. But is this necessarily the case also with all the other oxides? Iodine does not disengage the oxygen from barytes, strontian, lime, and magnesia, even at a very high temperature; and this circumstance, while it renders it more difficult to conceive the decomposition of a part of these alkalis by means of water, although there is then the concurrence of two affinities, renders very probable the existence of a limit beyond which the united affinities of the iodine for the metal, and the iodic acid for the metallic oxide, cannot overcome the affinity of the metal for oxygen. In this case the water may be decomposed; and I have no doubt that this is the fact. On the supposition that there exist only iodurets in solution in water, and no hydriodates, it is a necessary consequence that the oxygen is furnished to the iodine by the metallic oxide. But if there exist hydriodates, then the oxygen will be furnished by the water in all the cases in which they are formed. The question then reduces itself to this—do hydriodates exist? We shall examine it. But as it is the same with the hydro-chlorates, which are better known, we shall turn our more particular attention to them.

It may be stated, in the first place, against the existence of hydro-chlorates, that we must admit that on evaporating the water in which they are dissolved, they are changed into chlorurets, and that by redissolving these we reproduce the hydro-chlorates.

It is very true that crystallization is sufficient to change the hydro-chlorates of potash, soda, and barytes, into the state of chlorurets. But this does not happen with the hydro-chlorates of lime and magnesia. A high temperature is necessary to deprive the first of the whole of its water. And how can we affirm that a part of that water is not the result of the oxygen and hydrogen which constituted the hydro-chlorate? That of magnesia requires likewise a high temperature to be decomposed, and the chlorine finds still sufficient hydrogen to be changed into hydro-chloric acid.

Here then is a decided case in which hydro-chloric acid, and we may add hydriodic acid, are not able to reduce magnesia, though in circumstances most favourable to their action. But if we cannot deny the existence of hydro-chlorate and hydriodate of magnesia, by what certain character can we know that those of lime cannot exist at the ordinary temperature of the atmosphere?

When a solution of chloruret of calcium is mixed with subcarbonate of ammonia, the chlorine must pass to the state of hydro-chloric acid in order to combine with the ammonia. And if we can admit that water is decomposed at the moment of precipitation in order to furnish hydrogen to the chlorine, and oxygen to the calcium, nothing in that case prevents us from admitting that the act of crystallizing is sufficient to convert an hydro-chlorate into a chloruret, and that the solution of a chloruret in water converts it into a hydro-chlorate; for it is the difference of solubility of subcarbonate of lime and hydro-chlorate of ammonia which occasions the double exchange of the bases and acids; and consequently it is on account of that difference of solubility that the water is decomposed. If we mix together chalk and muriate of ammonia, we reproduce by heat subcarbonate of ammonia and chloruret of calcium. Thus, though we refuse to admit that the chloruret of calcium is changed into hydro-chlorate by solution in water, we must still allow that the elements of water may be separated or united by a trifling change of temperature. What I have just said of the hydro-chlorate of lime applies to most of the other hydro-chlorates and hydriodates; and I might mention other analogous facts. But I ask this only to be granted me, that water in certain circumstances may be formed or decomposed by the same forces which produce the double decomposition of salts. These forces being in general very weak, since a slight change in temperature is sufficient to vary the nature of double decompositions, it will be obvious that solution in water and crystallization may determine the decomposition and formation of this liquid. But in that case the reason which I assigned in favour of the existence of chlorurets and iodurets dissolved in water, does not appear to me to have the same force.

It may be alleged, on the other hand, in favour of the existence

of chlorurets in solution in water, that when they are dissolved only a very slight change of temperature takes place; while if the water were really decomposed, the variation would be very great.

The temperature produced by the solution of a solid body being the result of two opposite causes, it is difficult to distinguish the heat owing to the combination of the liquid with the solid from that which is owing to the change of state in the solid. But independent of this consideration, I must remark, that some of the chlorurets produce cold when dissolved in water, and others heat. Thus the chloruret of sodium sinks the temperature of the water about  $3.5^{\circ}$ , while that of calcium raises it more than  $108^{\circ}$ . Farther, if it be demonstrated that the forces, which determine the double saline decompositions, are sufficient to operate the separation of the elements of water and their union in the circumstances of which we are speaking, we ought to admit that the state of condensation of the oxygen and hydrogen in water is little different from that which they experience in the hydro-chlorate, and then the variations of temperature owing to the separation or re-union of these two elements ought to be but little sensible. Besides, my object is not to prove that only hydro-chlorates exist in solution in water. I believe, on the contrary, that according to the nature of the substance with which the chlorine is combined, the chlorurets may dissolve in water without undergoing decomposition, or be changed into hydro-chlorates during that solution.

To acquire still further light on that head, I supposed that on mixing a solution of sulphate of ammonia with that of chloruret of calcium or barytes, there ought to be produced a great deal of heat, if these metals were not combined with oxygen; for having to pass into the state of oxide in order to combine with sulphuric acid, the decomposition of the water must necessarily take place, and its oxygen experiencing a great condensation on uniting to the calcium or barium, there ought to be a very sensible disengagement of heat. On mixing solutions of chloruret of calcium and sulphate of ammonia nearly in equal volumes, the temperature scarcely rose half a degree, though such a quantity of sulphate of lime was formed that the whole mixture became solid. The solution of chloruret of barium treated in the same way produced an elevation of about  $3.5^{\circ}$ . From these facts it would seem that in the solution of chloruret of calcium the metal is in the state of an oxide, while in that of chloruret of barium the metal is still in the metallic state.

Analogy, to which one should not yield too blindly in chemistry, but which ought not to be neglected when founded on a numerous series of phenomena, furnishes still, as we shall see, some probabilities in favour of the existence of the hydro-chlorates.

It cannot be doubted that sulphur, and even phosphorus, approach a good deal to chlorine and iodine, and that of course their combinations have an analogy with each other. But if we dissolve in water the sulphuret of potassium, we obtain a combination the odour of which announces the presence of hydro-sulphuric acid,



and which allows that acid to escape by the action of a moderate heat. In the same way, when phosphuret of potassium is dissolved, phosphureted hydrogen gas is disengaged. The water then in these different circumstances is decomposed: in the first case, in consequence of the affinity of potassium for oxygen, and of sulphur for hydrogen; and in the second, in consequence of the same affinities, together with that of phosphorus for oxygen, since at the same time phosphorous acid is formed. Further, I have already remarked that among the chlorurets, iodurets, and sulphurets, it is those one of whose elements has more affinity for oxygen than the other for hydrogen, that are soluble in water. Hence after the unequivocal existence of hydro-chlorate and hydriodate of magnesia; after the proofs which I have given that water, either in dissolving a chloruret, or in abandoning it, may be decomposed or formed by the same forces that determine the double saline decompositions; and after the analogies which I have just stated, I think we may admit that most of the chlorurets, iodurets, and sulphurets, in solution in water, those at least whose metals have a great affinity for oxygen, may be considered as hydro-chlorates, hydriodates, and hydro-sulphates. I do not, however, deny the existence of the chlorurets, &c. in solution in water. On the contrary, I admit as a principle that we ought to have a chloruret or a hydro-chlorate in solution, according as the forces which act in order to decompose water are smaller or greater than those which keep its elements united.

#### NOTE B.

##### *On Acidity and Alkalinity.*

All the combinations which bodies form may be divided into two sets. In the one there is perfect neutrality; in the other, acidity or alkalinity.

Neutrality may not only exist in the saline combinations, but likewise in many others. Thus the ethers formed by the combination of an acid with alcohol, the soaps with an alkaline or acid basis, are so many compounds in which the respective properties of the constituents disappear completely. In the acid or alkaline combinations, on the contrary, the peculiar properties of one of the constituents still show themselves.

From the idea of neutrality derived principally from the saline combinations, we regard, as performing the function of an alkali, all the bodies which saturate either completely or in part the properties of acids; and as acids, all bodies that saturate the properties of alkalies. We consider, further, the neutral state as resulting from a certain constant ratio between the body which possesses the properties of acids, and that which possesses those of alkalies. In every other ratio the compound is acid or alkaline. But in all cases the acidity or alkalinity which is in excess is less than before the combination; and this excess may be exactly measured by the quan-



tity of substance which it is necessary to add to obtain the neutral state compared with the whole of the same substance contained in the neutral compound. Let us apply these considerations to the acids themselves, and to the alkalies.

Neutrality, or complete saturation of the acid properties by the alkaline, takes place both between two simple bodies and two compound bodies. It is in the first case even that acidity and alkalinity show themselves in all their energy. Water and white oxide of arsenic are neutral combinations, analogous in this respect to the salts: and as it is oxygen which possesses acid properties, hydrogen and arsenic ought to possess alkaline ones. When oxygen is combined with the metal in greater quantity than in white oxide, then the compound is acid. In like manner protoxide of azote ought to be considered as a neutral compound; but when the oxygen is combined with azote in three times or five times as great a proportion, the acid properties of the oxygen are no longer neutralized by the alkaline properties of the azote, and the combination possesses acid characters.

Since most of the oxides are alkaline, though they contain oxygen, the metals whose oxides have that property ought themselves to possess it in a much more considerable degree. It would seem from this that oxygen loses or preserves its character in combinations, according to the proportion in which it enters into them. Let us examine if these proportions should be constant or variable to produce this effect. We shall compare the bodies according to their volumes in the elastic state, and not according to their ponderable quantities, which have much less influence on their combinations.

In water there enter two volumes of hydrogen and one of oxygen. Hence, equal volumes considered, oxygen is much more acidifying than azote is alkalifying; and that equal volumes of azote and hydrogen are alkalifying in the same degree, if we can compare exactly the protoxide of azote with water. The oxide of carbon appears to me to result from the combination of two volumes of the vapour of carbon with one of oxygen gas, and if we might consider the protoxide of azote and water as combinations equally neutral, we might conclude that the acidifying properties of oxygen gas are neutralized by a double proportion of the body with which it combines, and it would be very remarkable that azote, hydrogen, and carbon, possess alkalifying properties in the same degree.

In carbonic acid we may conclude with the greatest probability that the oxygen is combined with an equal volume of the vapour of carbon, and in sulphurous acid that it is combined with an equal volume of the vapour of sulphur. But though in nitrous gas there are equal volumes of oxygen and azote, this gas does not possess acid properties. But as these three compounds contain the same proportions in volume, and as there is no other difference between them except that in sulphurous and carbonic acids, the condensation

amounts to half the whole volume, while in nitrous gas there is no condensation whatever, it would seem that this is the cause why nitrous gas does not possess acid properties, and consequently that the combination of an equal volume of oxygen with a certain class of bodies will constantly produce acids, if the condensation of the elements be one half of the whole volume.

Nitrous acid is composed of 1 azote and 1.5 oxygen, and nitric acid of 1 azote and 2.5 oxygen, and yet the acidifying property of these two acids is the same; for with equal quantities of azote they saturate the same quantity of alkaline base. The case is the same with sulphurous and sulphuric acids, the last of which contains 1.5 more oxygen than the first, though they both saturate the same quantity of base. Iodic acid is composed, like nitric acid, of one part in volume of vapour of iodine and 2.5 of oxygen; and chloric acid results also from the union of one part of chlorine with two and a half of oxygen.

It is very remarkable to see acids very different, both in the nature of their radical and in the quantity of oxygen which they contain, saturate the same quantity of alkali, supposing each to contain the same gaseous volume of radical. The following table shows this:—

Chloric acid . . . . .	{ Radical . . . . . 1 Oxygen . . . . . 2.5 }	saturates 2 ammonia
Iodic acid . . . . .	{ Radical . . . . . 1 Oxygen . . . . . 2.5 }	..... 2
Nitric acid . . . . .	{ Radical . . . . . 1 Oxygen . . . . . 2.5 }	..... 2
Nitrous acid . . . . .	{ Radical . . . . . 1 Oxygen . . . . . 1.5 }	..... 2
Sulphuric acid . . . . .	{ Vapour of sulphur 1 Oxygen . . . . . 1.5 }	..... 2
Sulphurous acid . . . . .	{ Vapour of sulphur 1 Oxygen . . . . . 1 }	..... 2
Hydriodic acid . . . . .	{ Vapour of iodine . . 1 Hydrogen . . . . . 1 }	..... 2
Hydro-chloric acid . . . . .	{ Chlorine . . . . . 1 Hydrogen . . . . . 1 }	..... 2

It is very probable that hydro-sulphuric acid follows the same law.

When we see such different acids saturate the same quantity of base (supposing each to contain the same volume of radical), ought we not to draw this consequence that the saturating property of an acid depends principally upon its radical, since only the ratio of this radical to the alkaline base is constant?

In fact, if there be no doubt that oxygen, chlorine, and iodine, possess very powerful acidifying properties, how comes it that chloric acid and iodic acid do not saturate more than nitric acid, nitrous acid, &c. It may be answered that the way in which I here measure

acidity is not exact, and that there is a great difference between the property which an acid has of neutralizing a greater or smaller quantity of base, and the energy of its acidity. I admit this for an instant; and I shall even suppose that the acid energy of a body depends upon its electric energy. Do we not admit that the electric energy of a neutral salt is null, or almost null? And even in this case, must not the electric energy of the acid be destroyed by the opposite energy of the base? If this were the case, it would be doubtless as remarkable to see the same quantity of base, the electric energy of which is constant, neutralize the energy of very different acids, which without doubt is variable. Besides, I must observe that M. Berthollet has long ago put it out of doubt that the insolubility and elasticity, both of the acids and bases, and of the compounds into which they enter, are the principal causes of their mutual decompositions; and consequently that the electric energies, though highly worthy of consideration, are here but secondary.

But I shall venture to say that the neutralization of acids and alkalies in simple ratios, and that of their electric energies, when they form neutral salts, are subordinate to the property which all bodies have of combining in definite proportions; and I conceive that what we call *neutrality* does not indicate a uniform degree for all combinations. A compound is neutral with respect to us when it refuses to unite with the acid or alkaline particles presented to it. But if the energy of the acid body which enters into the compound does not exactly correspond with the energy of the alkaline body; if it be necessary, in order to saturate the excess of the one or the other, to add a quantity of acid or alkali beyond the definite proportion in which the acid and alkaline body can combine, the combination of the portion added will not be possible, and consequently the saturation of the acidity or alkalinity cannot be complete, though re-actives indicate the contrary. Such combinations ought to preserve a certain energy of affinity, which is probably the cause of the formation of triple salts, and these salts ought to approach nearer to perfect neutrality than those of which they are formed. We observe, in fact, that the solubility of the triple salts is in general less than that of the salts of which they are composed; and it is natural to think that, *cæteris paribus*, a saline combination ought to be the less soluble the more neutral it is.

From what has been said, we see that oxygen in general gives a neutral, acid, or alkaline, character to a body according to the proportions in which it combines with it; but that the condensation of volume which the constituents undergo, has, independent of proportions, a very great influence in the determination of the character of the compound which they form. Thus the combination in volume of two parts of hydrogen, azote, or carbon, with one of oxygen, and a condensation of one-third of the total volume determines the neutral character. The combination of one part in volume of carbon or sulphur with one part of oxygen, and a condensation of half the total volume, determines the acid character. But

if the condensation be nothing, as in nitrous gas, the compound is neither acid nor alkaline, though it contain equal volumes of azote and oxygen. It seems to result from this that neutrality between two bodies may be obtained in different ways, by varying their proportions or the condensation of their volumes. When the proportion of oxygen is above half the total volume, there ought for a still stronger reason to be acidity. Yet when we compare sulphurous with sulphuric acid, nitrous with nitric acid, and phosphorous with phosphoric acid, we observe that the acidity is the same for each couple of acids, though they contain different quantities of oxygen. I consider it as very probable that the oxygen added to sulphurous acid to convert it into sulphuric does not change its volume, and that we have always the same number of compound molecules which combine with the same number of alkaline molecules. This view of the subject will explain the permanency of neutrality in the salts whose acid is capable of combining with a new quantity of oxygen, and it would make the neutral, acid, or alkaline, character depend both on the number of heterogeneous molecules which combine, and on their arrangement. It will explain likewise why an oxide saturates so much the more of an acid as it contains more oxygen; for it will be sufficient to admit that the number of molecules of the oxide increases, on receiving a new quantity of oxygen, in the same ratio as the number of acid molecules which it saturated at first has augmented.\* We shall be able to conceive likewise why two bodies, like chlorine and oxygen, which have such decided acid characters, form, on combining in the proportion of 1 to 2.5, an acid which saturates no more than hydro-chloric acid, which is composed of equal parts of chlorine and hydrogen, though the characters of hydrogen be rather alkaline than acid. We shall be able to conceive likewise why fat bodies and alcohol saturate acids like alkalies, and why the same fat bodies saturate alkalies like acids. Lastly, we shall be able to conceive the possibility of forming neutral compounds with bodies which have the same acid or alkaline character, and we will admit without difficulty that the oxide of chlorine or euchlorine, though resulting from the combination of two bodies strongly acidifying, may notwithstanding be neutral.

Neutrality, as I have already observed, takes place as well between two simple bodies of opposite characters, as between an acid and an alkali. We may say it takes place better; for in the metallic oxides, for example, the alkalinity which they enjoy is the result of two opposite properties, the alkalifying property of the metal, and the acidifying of oxygen, modified both by the combination and by the proportions. We have easy methods of recognizing the neutral, acid, or alkaline, state of some combinations; but as these methods do not apply to all, I shall endeavour to point out a new one.

\* It is very remarkable that in the acids the saturating property appears to depend solely on the radical, while in the oxides, on the contrary, it depends upon the oxygen, which they contain.

If we decompose nitrate of ammonia by heat, we obtain two products—water, which is neutral; and protoxide of azote, which ought to be so too. I say *which ought to be so*, first, because it has no acid nor alkaline character; secondly, because it is formed in a manner analogous to water, namely, two volumes of azote and one of oxygen.

The chloruret, ioduret, and sulphuret of potassium, give neutral compounds when in solution in water. If this neutrality did not exist between their elements, there can be no doubt that it would not exist in the solution. If, for example, there were an excess of potassium, hydrogen would be disengaged. If the chlorine, iodine, or sulphur, were in excess, their properties would be easily recognised. But the neutral hydro-chlorate of potash changing into neutral chloruret of potassium because water is formed, we see that when two of the four elements of this neutral salt form a neutral compound, that formed by the two other elements is neutral also. This is the fact which I wish to generalize, by saying that whenever a neutral compound is divided into two compounds of which the one is neutral, the other is so of necessity also; for example, in the neutral sulphate of ammonia all the oxygen of the acid, and all the hydrogen of the alkali, forming water which is neutral, the sulphur and azote which remain, and which are in the proportion of 20 to 17.5, will form a sulphuret of azote which ought to be neutral also, and which will be composed of equal volumes of sulphur and azote.

On decomposing neutral chlorate or iodate of potash by heat, we obtain neutral chloruret and ioduret of potassium; consequently the potassium by losing its oxygen, which necessarily diminished its alkaline energy, has gained as much alkaline energy as the chlorine and iodine have gained of acid energy by losing five times as much oxygen. Here is a new proof that the acid properties of a body do not follow the ratio of the quantity of oxygen which combine with it.

Another principle, which I think ought to be admitted, is that a neutral compound does not destroy the acid or alkaline energy of another compound with which it combines. This is proved by showing that when neutral compounds are mixed, the mixture remains neutral. According to this principle, water holding in solution an acid or an alkali ought to remain always acid or alkaline, whatever be its proportion. This liquid, considered as a solvent, presents therefore this remarkable circumstance, that it overcomes the cohesion or elasticity of the bodies with which it unites without destroying their characteristic properties, which enables us often to observe these properties better than in the bodies themselves.

In the neutral state, the acid or alkaline properties being in general saturated, it is evident that a neutral body ought to have less tendency to combine with acids or alkalis than those which are not so; and we may easily explain why, *cæteris paribus*, the affinity of an oxide for acids diminishes in proportion as it combines with a greater dose of oxygen. By that it approaches more and more to a

state of neutrality. It may even pass it, and assume the characters of acids, as happens to the peroxides of tin and antimony.

In what I have said I have supposed that oxygen communicates acidifying properties to other bodies; and I was the better entitled to make this supposition, because, though Sir H. Davy thinks that the chlorates and iodates contain no acid, and are triple compounds of the metals, oxygen and chlorine or iodine, I have demonstrated that they are true salts, analogous to the sulphates and nitrates, and that chloric and iodic acids may be obtained in a separate state. I do not refuse, however, to chlorine and iodine the acidifying property; I go even further, and assign it to sulphur, which in my opinion possesses it in a high degree, to phosphorus, carbon, and several other bodies. I have long considered an acid, in its most general acceptation, as merely a body (whether it contains oxygen or no) which neutralizes alkalinity; and an alkali is merely a body which neutralizes acidity. Thus in the soaps the oil performs the function of acid, since it saturates alkalies; and in certain ethers the alcohol performs the function of an alkali, since it saturates acids. Knowing the elements of hydro-sulphuric acid and ammonia, and the observations of M. Berthollet on prussic acid, we cannot refuse to admit that a body may be acid or alkaline without containing oxygen, and consequently that acidity and alkalinity may be communicated by other bodies besides oxygen. These observations, by generalizing our notions of acids and alkalies, have rendered the definition of them very imperfect; because acidity and alkalinity are correlative terms, and one cannot be defined without recourse to the other. The difficulty of tracing a limit between the acids and alkalies is still increased when we find a body sometimes performing the functions of an acid, sometimes of an alkali. Nor can we diminish this difficulty by having recourse to the beautiful law discovered by Berzelius, that oxygen and acids go to the positive pole; and hydrogen, alkalies, and inflammable bases, to the negative pole. We cannot, in fact, give the name of acid to all the bodies, which go to the first of these poles, and that of alkali to those that go to the second: and if we wished to define the acids by bringing into view the nature of their electric energy, it must be seen that it would be necessary to compare them with the electric energy which is opposite to them. Thus we are always reduced to define acidity by the property which it has of saturating alkalinity; because acidity and alkalinity are two correlative and inseparable terms.

Whatever definition of acid we prefer, we must divide the acids into different groups, because they do not all derive their acid character from the same body. We have,

1. The acids properly so called, in which we may consider oxygen as the acidifying principle, and which contain only two elements. Such are chloric, iodic, sulphuric, sulphurous, nitric, nitrous, phosphoric, phosphorous, carbonic, arsenic, boracic, and probably



a great number of metallic oxides, which really possess the properties of acids.

2. The acids formed by hydrogen and another body. This set comprehends hydro-chloric, hydriodic, and hydro-sulphuric acids. It is probable that in these acids chlorine, iodine, and sulphur, are the acidifying principles; but as hydrogen enters into them all, I thought it better to deduce from it their general name. These different acids may be distinguished by the name *hydracids*. Among this set I conceive the numerous compounds of carbon and hydrogen, which possess acid properties, ought to be arranged. The elements of some of these compounds, and perhaps of all of them, are in the same proportion in volume as in the preceding acids; and their molecules are doubtless arranged in an analogous manner.

Among the vegetable acids there are several which draw their acid character from oxygen, because that body is the greatest constituent in them. This is the case with oxalic acid. But citric, sacclactic, and acetic acids, probably owe their acid characters to the carbon, which they contain in the greatest proportion. We ought to admit this in particular in acetic acid, which we may conceive to be composed of equal parts by weight of carbon and water, or of three parts in volume of the vapour of carbon and two of the vapour of water.\* I am likewise convinced that benzoic acid does not owe its acid properties to oxygen, but rather to the carbon and hydrogen. And I consider the classification of vegetable substances established by M. Thenard and myself (Rech. Physico-Chim. ii. 321,) as presenting exceptions.

Prussic acid ought without doubt to be placed in a particular set, though near that of the hydracids; but it would be premature to determine its classification without knowing exactly its nature.

Besides these different acids, chlorine, which was always reckoned among the acids, while considered as a compound of muriatic acid and oxygen, ought still to be so, though a simple body. The same thing may be said of iodine, and of various other simple bodies, which have the property of combining with alkalies. Yet it appears to me more convenient to continue to class them among the simple bodies, and to reserve the term *acid* for the compound acids. But it becomes necessary to divide these bodies into as many sets as there are different generic characters.

Though chlorine and iodine possess acidifying properties, and though they can form acids by combining with other bodies, we

\* This composition of acetic acid does not differ sensibly from that of *woody matter*, which does not possess any acid characters. Here, then, are two bodies composed of carbon, oxygen, and hydrogen, in the same proportions, whose properties are strikingly different. This is a new proof that the arrangement of the molecules in a compound has the greatest influence on the acid, alkaline, or neutral characters of the compound. Sugar, gum, and starch, lead to the same conclusions; for these substances, though composed of identical elements, and in the same proportion, have very different properties.



ought not at present, considering the small number of acids which they form, and whose existence even is not sufficiently established, to be in a hurry to form these acids into particular sets. We ought to be so the less because there are bodies, as carbon, which are acidified by oxygen, and which in their turn acidify other bodies. Besides these considerations which I have offered on acidity, showing that it is not proportional in an acidified body to the quantity of the acidifying principle, and that it is greatly modified by the arrangement of the molecules, it is necessary to wait till experiment has furnished us with more light before pronouncing on its true characters, and on the circumstances which produce it. We know, indeed, that acids and acidifying bodies have an electric energy which is negative with respect to that of the alkalies and the alkali-fying bodies. But this is not sufficient; and we are still far from being able to assign from the electric energies of compounds, if the character of their compound ought to be neutral, acid, or alkaline. Thus silver having a very weak affinity for oxygen, it would seem that it ought to approach it by the nature of its electric energy; and yet the oxide of silver, in which I have found a small degree of solubility, is very alkaline, for it completely neutralizes the acids; and azote, which appears to approach oxygen, chlorine, and iodine, forms a very weak compound with hydrogen, though this last possesses a very great positive electric energy. We have more and more reason, then, to admit that the neutral, acid, or alkaline, character of a compound does not depend entirely upon the characters of its constituents, but likewise upon their proportions in volume, and their condensation; or, in other words, upon the arrangement of their molecules.

#### ADDITIONS.

I have said, vol. v. p. 106, that on passing water and iodine in vapour through a porcelain tube at a red heat, no oxygen was disengaged, and consequently that the water was not decomposed by the iodine. The same experiment repeated afterwards a second time gave me the same result, that is to say, that I obtained no oxygen. Nevertheless, the consequence which I drew from it is not exact, as I shall now show. M. Ampere having exposed during several months a solution of iodine in water to the action of solar light, observed that it was entirely freed from colour, and requested me to examine what could be the cause of this phenomenon. We ascertained that the water contained a mixture of iodic acid and hydriodic acid in very small proportions: and on letting fall into it some drops of sulphuric acid or solution of chlorine, the water assumed an orange-brown colour, and gave out the peculiar odour of iodine. Sulphurous acid did not colour it; but hydro-sulphuric acid rendered it milky, on account of the sulphur which precipitated. These experiments demonstrate evidently the presence of hydriodic and iodic acids in the solution of iodine under examination; and we imitated it by mixing together very dilute solutions of these two acids. The only conse-

quence which we can deduce from this fact is, that water was decomposed. Its oxygen formed with iodine iodic acid, and its hydrogen hydriodic acid. But the quantity of the two acids which can exist together in solution in water is subordinate to this condition, that when they are concentrated to a certain degree they decompose one another.

As we can in general substitute a certain elevation of temperature for solar light, I made a mixture of vapour of iodine and water pass again through a red-hot porcelain tube, and I attentively examined the products. No gas passed; and the water condensed had the same intensity of colour with cold water saturated with iodine. I heated it, in order to deprive it of its colour, and I succeeded. This water, which had no smell, and no action on litmus any more than the water obtained by M. Ampere, had likewise all the characters of it, and I easily recognized in it the presence of iodic and hydriodic acids. As before being discoloured by heat it had exactly the appearance of a cold solution of iodine, I thought that both might be similar. To verify this suspicion, I slightly heated a cold solution of iodine, in order to deprive it of its colour, an effect which may equally be produced by exposing it to the air. It then presented exactly the same characters as a solution of iodine which had been made colourless by long exposure to light, and as that which I had obtained by passing water and iodine through a red-hot tube, and rendered colourless by boiling. None of these solutions was coloured by sulphurous acid; but all of them were coloured by chlorine. This is because, on the one hand, the hydriodic and iodic acids exist in them in very small quantity; and because on the other there is five times as much iodine in the first acid as in the second. I have, however, succeeded in rendering the solution of the two acids coloured by sulphurous acid, by first saturating with ammonia, and then concentrating by evaporation.

It follows from these observations that when iodine is in contact with water it decomposes this liquid, and produces with its elements iodic and hydriodic acids. This action of iodine on water appears to me entirely independent of the solar light: and when a solution of iodine is deprived of its colour by exposure to light for some months, as in the experiment of M. Ampere, I ascribe the effect to the gradual evaporation of the iodine. It appears to me probable that iodine is dissolved in water only by the action of the hydriodic acid, which is formed at the same time that the solution takes place. But I have already remarked that we do not succeed in depriving hydriodic acid holding iodine in solution of its colour by boiling, while we easily do so to water which has been in contact with this substance. I presume that in this last case the hydriodic acid exercising some part of its action on the iodic acid, retains the iodine with less energy, and of course lets it be disengaged with more facility.

I have ascertained that on exposing to light a solution of chlorine in water, chloric acid is produced.

*Mutual Decomposition of the Iodate and Hydriodate of Zinc.*

In speaking of the action of the alkaline oxides on iodine by means of water, I was led to conclude (vol. v. p. 302) that if we cannot form hydriodates and iodates with the oxides of zinc, iron, &c. the reason is, that these oxides do not sufficiently condense hydriodic and iodic acids to prevent them from acting on and decomposing each other. I have since verified this consequence, by mixing iodate of potash with a solution of sulphate and hydriodate of zinc. Though the solution of these different substances was not sufficiently concentrated to allow sulphate of potash to be deposited, we may however admit, on account of the facility of the changes that take place in the solution of different salts, that the phenomena ought to be the same as if we had mixed directly hydriodate of zinc with the iodate of the same metal. The result was, that there gradually deposited in the solution of these three bodies, oxide of zinc which appeared to me pure, and iodine well crystallized, and the solution which contained hydriodate of zinc in excess was very strongly coloured. These results can only be explained by supposing that the acid of the hydriodate of zinc, and that of the iodate of the same metal, supposed to exist in the solution, have mutually decomposed each other, and produced water and iodine, and that the oxide of zinc held in solution by these acids precipitated after their destruction.

*On the Nomenclature of the Combinations of Iodine and Chlorine with other Bodies.*

It may be asked why, instead of calling the compound of iodine and potassium ioduret of potassium, I did not call it *potassuret of iodine*. I observe, in the first place, that the combinations of sulphur with the metals having the name of *sulphurets*, those of chlorine and iodine ought from analogy to receive the names of *chlorurets* and *iodurets*. But to apply in general with certainty the generic termination *uret*, I have taken for a principle to give it to that of the elements of a binary compound which has the greatest affinity for hydrogen, and which combines with it when the compound produces the decomposition of water. According to this principle, I call the compounds of chlorine with sulphur and azote, *chloruret of sulphur*, *chloruret of azote*; those of iodine with azote and potassium, *ioduret of azote*, *ioduret of potassium*; *chloruret of iodine*, the compound of chlorine and iodine; and *sulphuret of carbon*, *ioduret of phosphorus*, the combinations of sulphur with carbon and iodine with phosphorus.

*On Ammonia considered as an Oxide.*

Dr. Berzelius has concluded from his researches that ammonia contains oxygen, because in its combinations with acids it follows the same law as the metallic oxides. This conclusion is not necessary; for from the observations which I have presented, an alkali is

in general a substance which, by the nature of its energy, and the arrangement of its molecules, is capable of combining with acids, and of neutralizing them. I have observed, likewise, that we ought to consider azote as approaching by its properties the nature of oxygen, chlorine, iodine, and that, like them, it may acidify a certain class of bodies. But all acidifying substances may, as well as oxygen, when they combine with alkalifying substances in proper proportions, form salifiable bases. Of course, ammonia ought to be considered as a particular alkali, in which azote performs the function of oxygen in the other alkalies. I consider, in the same way, carbon in fatty bodies, and particularly in the margarine of Chevreuil, as performing the function of oxygen in the acids; and I consider it in alcohol as performing the function of oxygen in the oxides. I shall observe, that since the printing of the article in which I treat of hydriodic ether, I have ascertained the density of its vapour, and found that it does not coincide with that given by calculating on the supposition that the ether is a compound of the vapour of absolute alcohol and hydriodic acid. As the same thing holds with hydro-chloric ether, the density of which found by experiment is different from that found by calculating it as a compound of the vapour of absolute alcohol and hydro-chloric acid; it appears to me very probable that the alcohol, which may be considered as composed of equal volumes of the vapour of water and olefiant gas condensed into one volume, changes its nature on combining with the acids. I hope to be able to throw light on this subject in a memoir on vapours, which I propose soon to publish.

---

## ARTICLE VI.

*Experiments on Tungsten, and its Combinations with Oxygen, Ammonia, and other Substances, to determine the Accuracy of preceding Researches, and to promote our Knowledge of this Substance. By Professor Buchholz.\**

### *Introduction.*

SOME time has elapsed since I formed the resolution of making a set of experiments on tungsten, its oxides, and their combinations, in order to verify the accuracy of preceding researches on this substance, and in order to promote our knowledge of its nature and properties. I was in a situation to make these experiments in consequence of a considerable stock of wolfram and Scheele's tungstic acid with which I was furnished, and for which I have chiefly to thank the goodness of my friend Dr. Haberle. This resolution was

\* Translated from Schweigger's Neues Journal für Chemie und Physik, col. iii. p. 1.

rendered still stronger in consequence of a conversation which I had with the celebrated naturalist Professor Steffens, of Halle, who seemed to doubt the accuracy of the statements respecting the great specific gravity of tungsten. The following dissertation contains my experiments and their results as far as the time I had would allow me to follow them up. The continuation of them will follow.

(A.)

*Experiments on the best Method of forming Tungstic Acid, or rather Tungstate of Ammonia.*

As my object in these experiments was in the first place, for very obvious reasons, directed towards the reduction of tungsten, and as I wanted to verify the statement of Allen and Aikin that this metal may be fully melted by the application of a violent heat to tungstate of ammonia, on that account my first care was to discover a convenient method of obtaining a sufficient quantity of tungstate of ammonia. It was quite natural to try in the first place Scheele's tungstic acid, composed of oxide of tungsten, potash, and muriatic acid, because I had a considerable stock of it in my possession.

*Exper. 1.*—With a view to the statement of several chemists, who affirm that in order to form pure tungstate of ammonia it is necessary to separate the pure yellow oxide of tungsten from Scheele's tungstic acid by digestion in nitric acid, I made the following experiment:—Two ounces of the triple compound of tungstic oxide, potash, and muriatic acid, were triturated with eight ounces of pure nitric acid of the specific gravity 1.200; and being put into a glass vessel capable of holding 16 oz. of water, were boiled for six hours, and during that time were frequently agitated. This process was very difficult, because the salt and oxide settling at the bottom of the vessel occasioned a continual knocking of the vapour, and by that means the acid was sputtered about. The oxide obtained by this process was very light yellow, without the least shade of lemon. This entitled me to conclude that the triple salt had not been completely decomposed. To obtain a more complete decomposition, the whole was poured into a porcelain dish, and evaporated on the sand-bath to the consistence of a syrup, being constantly stirred during the whole process by a porcelain spatula. The whole was then diluted with 12 oz. of water, and after remaining at rest for 24 hours, the milky solution was separated from the heavy yellow oxide. This oxide was treated in the same way again in the porcelain dish with 6 oz. of nitric acid. The oxide obtained in this manner, and three times washed with 6 oz. of water, was considered by me as pure. When dried, and heated to redness, it assumed a light yellow colour, and weighed 13 drams. After several weeks, 90 gr. of the same oxide precipitated from the milky liquid.

With this oxide the following experiment was made.

*Exper. 2.*—300 gr. of the tungstic oxide which had been heated

to redness, and was of a light lemon-yellow colour, were digested for some time with a warm solution of concentrated caustic ammonia. In about an hour the mixture was raised to the boiling temperature; but I did not by this means obtain a complete solution. The mixture was allowed to remain at rest for some time; and by this means the liquid was separated from the undissolved yellowish-grey oxide, and carefully evaporated in a porcelain bason. By this means I obtained 47 gr. of a pea-coloured, foliated, brilliant mass, easily separated from the porcelain vessel, and possessing a hot bitter taste. It was tungstate of ammonia.

This result was quite contrary to my expectation, and to the assertion of other chemists, according to whom pure tungstic oxide is very easily soluble in ammonia. This required a further examination of the residuum which was insoluble in ammonia.

*Exper. 3.*—This residuum was treated with 8 oz. of caustic ammonia, in the same manner as above related; after which the liquid part was separated from the solid powder, which still had a very grey appearance. By evaporation the solution deposited only 27 gr. of a salt having the same colour as in the preceding experiment, of a pulverulent appearance, and having a sharp bitter taste.

*Exper. 4.*—As I conjectured that the tungstic oxide was somewhat deoxidized by the ammonia, and thereby rendered grey, I tried, by exposing it to a red heat, to bring this oxide back to its original state, and to obtain a greater proportion of it dissolved in ammonia. I found that by this treatment the grey oxide again assumed a yellow colour, and amounted now to only 230 gr. With this powder the following experiment was made.

*Exper. 5.*—100 gr. of the same oxide were mixed with 4 oz. of caustic ammonia, and the mixture was digested for 12 hours in a very moderate heat, being often agitated during the digestion. The liquid part was then allowed to separate from the undissolved portion, and decanted off. This solution by evaporation yielded 55 gr. of a white powder, which had a hot and bitter taste, and possessed the properties of tungstate of ammonia. The yellowish-grey colour of the undissolved residuum showed that even in this case, notwithstanding the very moderate heat of the ammonia, a commencement of deoxidation had taken place.

*Exper. 6.*—The solid residue of the preceding experiment was treated in the same way once more with 4 oz. of caustic ammonia, and the liquid portion separated from the undissolved powder, which had a light grey colour. This solution, when evaporated, gave 11 gr. of a pea-yellow powder, which was tungstate of ammonia, and possessed the same taste as that obtained in the preceding experiments. I could not in this case determine the quantity of matter that had remained undissolved, because a portion of it had been lost.

The result of these experiments shows us that our tungstic oxide, after being exposed to a red heat, is with difficulty soluble in caustic



ammonia, and that by the action of that alkali it undergoes a partial deoxidizement. I resolved, therefore, to make experiments on the solubility of our oxide in carbonate of ammonia.

*Exper. 7.*—100 gr. of the oxide rendered yellow in experiment 4th were heated with a mixture of half an ounce of subcarbonate of ammonia and 2 oz. distilled water, and the mixture was frequently agitated. A few air bubbles made their escape. The whole being kept almost boiling hot for two hours, the undissolved powder in this case also became grey.

The clear solution deposited on evaporation 66 gr. of tungstate of ammonia, having a white colour, a sharp and bitter taste, and not effervescing when dropped into muriatic acid; showing that it contained no carbonic acid. The dried residue weighed 48 gr.

*Exper. 8.*—The 48 gr. of residue in the preceding experiment were kept in a red heat for an hour in contact with the atmosphere. By this treatment it again assumed a light lemon-yellow colour. 35 gr. of it were mixed with half an ounce of subcarbonate of ammonia and 2 oz. of water, and the mixture was agitated for some hours, being kept warm all the time. A lively effervescence took place at first. The whole was then gently boiled for one hour, and the liquid portion separated from the grey oxide by the filter. By evaporating the liquid, 20 gr. of a light reddish-grey powder were obtained, which had a sharp bitter taste. The undissolved grey oxide weighed 18 gr.

From these experiments with subcarbonate of ammonia, we see that there exists the same difficulty of solution, and the same deoxidizement, when tungstic oxide is treated with carbonate of ammonia. But as these experiments, as well as the preceding, with caustic ammonia, contradict those of other chemists, as Scheele, Bergman, Klaproth, Richter, &c. respecting the solubility of tungstic oxide in ammonia, I conceived that further experiments were necessary in order to clear up this discordance.

*Exper. 9.*—A small portion, therefore, of tungstate of ammonia was converted into yellow oxide of tungsten by digestion in concentrated muriatic acid, washing it in a sufficient quantity of water, and drying it strongly, but without exposing it to a red heat. 10 gr. of this oxide were mixed with two drams of the solution of caustic ammonia. The whole was dissolved immediately without the assistance of heat. The old observations of preceding chemists were confirmed by this experiment.

*Exper. 10.*—In order to obtain a larger quantity of tungstic oxide not dried in a red heat, and therefore soluble in ammonia, 3 oz. of Scheele's tungstic acid were kept boiling for an hour in 6 oz. of the same nitric acid which I employed in the preceding experiments in a porcelain dish upon a sand-bath, and during the whole time the mixture was constantly stirred with a porcelain pestle. The whole was then evaporated to dryness in a moderate heat. The oxide obtained by this process was of a full lemon-yellow colour. A portion of this being washed with water, and gently dried, dissolved



immediately in ammonia, with the exception of a very small portion of a light white substance in powder.

This success excited in me the strongest hopes of succeeding in my object by this method, and led me to suspect that in all probability the tungstic oxide had been rendered insoluble in ammonia by exposing it to a red heat. I resolved to prove the truth of this conjecture in the following way.

The tungstic oxide obtained by the preceding process was well washed twice successively, each time with 24 oz. of water, and by that means freed from the saltpetre formed during the process, and from the excess of acid, and obtained in a state of purity. When collected on the filter, and well dried, it weighed 2 oz. 2 dr. The liquid retained a portion of oxide so light, and in a state of such fine division, that it could not be retained upon the filter, but passed through it how many times soever it was filtered. This yellowish milky liquid, being set aside for three months, allowed the oxide gradually to subside. When collected and dried, it weighed 2 dr. 1 gr.

With this oxide, which had a lemon-yellow colour passing into yolk of egg colour, the following experiments were made, in order to determine its solubility in caustic ammonia.

*Exper. 11.*—Two ounces of pure caustic ammonia, of the strength which it has when prepared according to the formula given by me in the Almanac for Chemists and Apothecaries of 1803, p. 20, were put in contact with the whole of our dry tungstic oxide. 1 oz. and 20 gr. dissolved in the ammonia, or were at least converted into a white pulverulent matter.

From the phenomena it was evident that a much greater proportion of the oxide would have dissolved, or been converted into a white powder, by the quantity of ammonia employed, more probably than all that I had in my possession. I determined, therefore, to ascertain in another experiment upon a smaller scale the capacity of ammonia in dissolving tungstic oxide, or converting it into a white powder.

In the mean time I separated by the filter the white, light, slimy matter, which existed in the ammoniacal solution. It was washed on the filter with  $1\frac{1}{2}$  oz. of caustic ammonia, and then dried. Its weight amounted to 80 gr. It exhibited the properties of a quadruple compound of ammonia, potash, tungstic oxide, and muriatic acid, with some oxide of iron and silica from which the tungstic oxide had not been freed. The ammoniacal solution was evaporated to dryness in a porcelain vessel. 300 gr. of tungstate of ammonia were obtained, though by an unlucky accident a third part of the solution had been lost.

*Exper. 12.*—50 gr. of a solution of caustic ammonia were brought in contact with 80 gr. of oxide of tungsten. The mixture became stiff; and it was with difficulty that some remains of the yellow oxide could be perceived mixed with the white mass. By agitation in a considerable quantity of water, and still better by the

addition of a little ammonia, this portion is dissolved. This solution being poured upon a filter, 12 gr. of a white matter were obtained, similar in its nature to the substance described in the last experiment. The ammoniacal solution, being evaporated, yielded 83 gr. of dry tungstate of ammonia.

*Exper. 13.*—A portion of the yellow oxide of tungsten which had not been heated to redness was kept for half an hour in a moderate red heat, by which its colour was changed into light yellow. 60 gr. of this oxide being agitated with 1 oz. of caustic ammonia exhibited the same phenomena as the oxide did in the 1st, 2d, 3d, 4th, 5th, 6th, and 7th, experiments; that is to say, it dissolved with difficulty, and when heated became grey.

From these last experiments, compared with the preceding ones, we may consider the following propositions as established:—

1. That the difficult solubility in ammonia of the oxide, after it has been heated to redness, is owing to a portion of the triple compound of oxide, potash, and muriatic acid, which still remains undecomposed, entering into an intimate combination with the pure oxide, the parts of which cohere so strongly together, that the ammonia makes its way through them with difficulty in order to dissolve the pure oxide.

2. That when the triple compound of yellow oxide, potash, and muriatic acid, is treated with nitric acid, only an imperfect separation of the potash and muriatic acid is produced; so that a pure yellow oxide of tungsten cannot be obtained by this method. This will appear hereafter in a still more striking point of view, from other experiments which I shall state. Among others, I treated the triple compound six times successively with eight times its weight of nitric acid, and yet I was not able to obtain any pure oxide. A result by which the experiments of other chemists, particularly of Richter, are confirmed.

Perhaps the formula given by the last-mentioned chemist for obtaining pure oxide of tungsten from wolfram, might be employed with advantage, when once it has been established by further experiments that we obtain by it an oxide really free from lime. This I expect to be able to prove hereafter.

Richter's process is contained in the sixth volume of the Chemical Dictionary of Bourguet continued by Richter, p. 188, and is as follows:—One part of wolfram in fine powder is melted with three or four parts of nitre, till the mass flows quietly. The potash containing tungstic oxide thus obtained, which may likewise be obtained by my method, by fusing one part of wolfram and two parts carbonate of potash, is dissolved in 12 or 15 times its weight of water, and freed by filtration from the oxides of iron and manganese. The colourless solution is now mixed with a very weak solution of muriate of lime, which is added as long as any precipitate falls. The tungstate of lime thus obtained is carefully washed, and treated while still moist with nitric or muriatic acid. By this means the oxide of tungsten is at once freed from lime, and obtained in a state

of purity. It is to be washed, and gently dried, upon which it assumes a fine yellow colour.

3. In order to obtain pure tungstate of ammonia, it is necessary to have in our possession pure oxide of tungsten. Respecting this also further details will be given hereafter.

(B.)

*Experiments on the best Method of obtaining Tungsten from Tungstic Oxide by means of Tungstate of Ammonia.*

*Exper. 14.*—30 gr. of the tungstate of ammonia formed in the first experiment by treating the impure oxide of tungsten that had been exposed to a red heat with ammonia were put into a small glass, which was placed in a crucible, and surrounded with charcoal powder. The whole was exposed for an hour to a strong red heat. The interior of the glass, when cold, exhibited a brownish red, almost copper-coloured, matter, of a flocky appearance, and considerably specific gravity. I could only consider it as a peculiar oxide of tungsten, which hitherto had not been observed by chemists.

The brown oxide thus obtained was put into a Hessian crucible rubbed over with some charcoal powder. Charcoal powder was laid over the oxide, and the crucible, being covered by another, was exposed for half an hour to a strong white heat raised by a double bellows. When the crucible was cold, the brown oxide appeared to have been converted into a loose pretty heavy substance, which here and there exhibited the metallic lustre, and had an iron-grey colour. When strongly rubbed and polished against hard and smooth bodies, its metallic lustre became still more distinct, and its colour was intermediate between that of iron and tin. The grains were slightly agglutinated together, and the portion that lined the sides of the crucible appeared to be so more distinctly than the rest. This reguline mass seemed to have been softened, and showed evidently that a stronger heat than the preceding would have melted it completely. To see whether it was possible to fuse it, the following experiment was made.

*Exper. 15.*—20 gr. of the iron-grey metal mass were put into a crucible lined with charcoal powder, as in the preceding experiment, covered with a layer of charcoal powder half an inch thick, and then exposed for an hour to the strongest heat that could be raised in the blast furnace. No real fusion took place, but a kind of cementation into a mass which was easily reduced to powder, and this union seemed to be strongest along the sides of the crucible. The colour, appearance, and every thing else, were as in the preceding experiment.

It follows from these experiments that tungstate of ammonia, when destroyed by a red heat, leaves behind it a reddish brown oxide, and that this oxide is deoxidized by charcoal powder long before the metal produced is melted.

*Exper. 16.*—130 gr. of tungstate of ammonia of the same kind

as that employed in the preceding experiments, were, as in experiment 14, exposed to a strong red heat for an hour in a glass surrounded with charcoal in a crucible. The result differed little from that obtained in the 14th experiment. The mass which remained behind after the process weighed 100 gr., and had the following properties. When spread upon a leaf of paper, that portion of it which had been in contact with the charcoal appeared grey or metallic. In the middle it was dark brownish red, passing into reddish brown, and almost the fourth part of the mass was of a fine violet colour below, owing probably to a mixture of dark blue and brownish red oxide.

88 gr. of this mass, or as much as the portion of brown oxide amounted to, were, as in the 14th experiment, rammed into a small Hessian crucible, and exposed to the strongest heat of a blast furnace for an hour and a half. The result of this operation was as follows. The oxide of tungsten was completely reduced, but was not in the state of a button, or in large grains, but in small grains, as fine as sand, having a strong metallic lustre, a light iron-grey colour, and slightly agglutinated. The weight amounted to 75 gr. A few pieces of a larger size were to be found among this sand; they consisted of the portions that had adhered to the sides and bottom of the crucible.

The metal obtained by this process possessed the following properties. When strongly rubbed upon a hard and smooth body, it assumed a strong metallic lustre, and appeared very hard and brittle. 21 $\frac{3}{4}$  gr. of this substance, composed of grains more or less agglutinated together, and of the size of pin heads, were weighed in the usual way in distilled water, and the specific gravity was found to be 17.400. This result is intermediate between the specific gravity of tungsten as stated by the Elhuyarts, namely, 17.600; and by Allen and Aiken, namely, 17.200. It leaves no doubt respecting the great specific gravity of this metal.

Partly to ascertain these facts with still greater accuracy, and partly to obtain a greater quantity of tungsten in the metallic state for further experiments, and lastly to put the properties of tungstate of ammonia in the fire, and the nature of the oxide which it leaves beyond doubt, the following experiments were made.

*Exper. 17.*—200 gr. of tungstate of ammonia, which had been obtained from oxide of tungsten not heated to redness in the manner described in experiment 10, were put into a small glass, which was put into a crucible, and exposed to a strong red heat for half an hour. The oxide was not covered with any charcoal powder. By this process the upper portion of the glass was melted. The oxide obtained had a dark greyish blue colour, almost slate-blue, and had in some measure assumed a crystalline appearance. It weighed 173 gr.

These 173 gr. were crammed into a crucible lined with charcoal powder, and covered with a layer of charcoal powder one finger

thick. This crucible was enclosed in a larger one, and both were covered by a third crucible. In this state they were exposed for an hour and a half to the strongest heat of a blast furnace. The result appeared to me very surprising. The whole contents of the crucible, with a portion of the vessel itself, were melted into a slag.

This surprising result, the cause of which requires to be cleared up by further experiments, was probably owing to a portion of the triple compound of oxide of tungsten, potash, and muriatic acid, which not having been exposed to a red heat, was soluble in ammonia, and therefore was present in our tungstate of ammonia. This was not the case in the first experiments, because the salt had been prepared from an oxide exposed to a red heat, and was therefore free from this triple compound. Hence the pure oxide was reduced, and gave us the good results which have been above described.

*Exper. 18.*—200 gr. of the same tungstate of ammonia were kept in a weak red heat in a long small glass vessel placed in a crucible, till the ammonia was completely dissipated. The mass, when cold, weighed 134 gr., and had the following properties. Its colour was light greenish yellow, and was in the state of a scaly powder, which dissolved readily in caustic potash with the assistance of heat, without the evolution of any ammonia. The 129 gr. of this powder that remained were exposed for an hour to a strong red heat, which melted the glass in which the oxide was contained. Its weight was reduced to 121 gr., and it exhibited the following properties. The uppermost layer had a dark greyish blue colour, which always became more and more grey as we came nearer the bottom, and appeared to crystallize finely in stars. At the bottom of the glass itself there was a hard whitish grey mass, which from its weight I was disposed to consider as tungsten reduced to the metallic state. To obtain satisfactory information respecting this point, I mean the possibility of reducing tungsten without the assistance of charcoal, or any body containing hydrogen; the 121 gr. were reduced to a fine powder, and crammed into a crucible lined with charcoal, covered with charcoal powder, and exposed, as in the preceding experiments, for an hour to the most violent heat that could be raised in a blast furnace. The result was as follows. The oxide had partly sunk through the crucible, and was partly melted into a porous grey substance, with not the least appearance of a regulus.

These results leave us to conjecture how they happened. They were beyond all doubt owing to the presence of a portion of the triple compound of oxide of tungsten, potash, and muriatic acid, as was the case in the preceding experiments.

The existence of a portion of this triple compound in our tungstate of ammonia, and the injurious effects which it produced when we attempted to reduce the metal, induced me to undertake a set of experiments in order to obtain pure tungstate of ammonia from the oxide of tungsten not exposed to a red heat, and obtained as in experiment 16.

(C.)

*Experiments on the best Method of obtaining pure Tungstate of Ammonia from the Oxide of Tungsten procured from the triple Compound, in the way described in Experiment 10, and not exposed to a Red Heat.*

*Exper. 19.*—250 gr. of yellow oxide of tungsten that had not been heated to redness were mixed with 1 oz. of caustic ammonia and 1 oz. of water, and the mixture was left for 12 hours in a moderately warm place. The whole was then thrown upon a moist filter, and the filtered liquid, being put into a porcelain dish, was placed upon a stove, that it might undergo slow evaporation. After about the half of the liquid had evaporated, snow-white brilliant prisms began to separate, and they continued to accumulate till the whole liquid was reduced to half an ounce. These crystals, being separated, were found to weigh 133 gr. They had not the properties of pure tungstate of ammonia, which is known to be very soluble: on the contrary, these were very difficultly soluble; and from their appearance, could be nothing else than a quadruple compound of oxide of tungsten, potash, ammonia, and muriatic acid. The existence of these substances in these crystals was ascertained by further experiments made with a view to ascertain their nature. Thus a portion, being exposed to a red heat, left after the escape of the ammonia a blue, greenish white residuum, which when boiled in muriatic acid became yellowish, like the triple salt of which we have spoken so frequently. In another experiment the quadruple compound was dissolved in caustic potash, with the escape of a great deal of ammonia. The potash being neutralized by acetic acid, the white triple compound precipitated, which remained unaltered in a gentle red heat; but being boiled in concentrated muriatic acid, acquired a yellow colour.

The white residuum of the oxide treated, as above, with ammonia and water, was once more digested in 1 oz. of caustic ammonia and 1 oz. of water, and the filtered liquid exposed, as before, to slow evaporation upon a stove. When the half was evaporated, crystals appeared, as before. The whole of them obtained amounted to 43 gr. They possessed the same properties as those just described.

The mother leys from which these crystals had deposited were evaporated separately. The first yielded 45 gr. of a saline mass, for the most part very soluble in water, and which possessed the properties of tungstate of ammonia, containing, however, mixed with it, a small portion of the quadruple compound.

The second yielded 37 gr. of a saline mass, possessing the properties of the preceding.

These 82 gr. were macerated in 3 dr. of distilled water, and the undissolved white quadruple compound, which weighed 33 gr., was separated from the easily soluble portion. The solution was slowly evaporated in a porcelain dish. There remained 48 gr. of a salt,



which possessed the following properties. Its external appearance was similar to that of gum-arabic; but it was more easily reduced to powder, and had a peculiar bitter, biting, and sharp metallic taste. This easily soluble tungstate of ammonia, being exposed for an hour to a gentle red heat in a glass with a narrow mouth, left 40 gr. of a light blue oxide, which at the commencement was yellow. These 40 gr. were put into a crucible, and exposed for an hour to a strong white heat in a blast furnace without any mixture of charcoal powder. It was converted into an oxide of a deep blue colour. Being mixed with charcoal powder, and treated as in experiment 16, a regulus was obtained in small grains, possessing the properties already described.

The salt remaining undissolved by the ammonia exhibited the properties of the quadruple compound, only it was somewhat more difficultly soluble, and probably contained a greater proportion of oxygen. It consisted of small clear crystals, and weighed 85 gr.

*Exper. 20.*—20 gr. of the quadruple compound were put into a glass vessel, and exposed to a heat raised by degrees till the glass melted. The resulting substance possessed the properties described in experiments 17 and 18, excepting that it was less blue, and more inclined to grey.

These last experiments show us not only that the preparation of pure tungstate of ammonia, by employing yellow oxide obtained from the triple compound of oxide of tungsten, potash, and muriatic acid, is very unprofitable; but that in this case a hitherto unknown quadruple compound of potash, oxide of tungsten, ammonia, and muriatic acid, is formed: and, lastly, they establish the conjecture hazarded in experiments 17 and 18, respecting the reality of the unfitness for reduction of the tungstate of ammonia altered as described in these experiments. This unfitness is the consequence of a mixture of the tungstate of ammonia with the so often mentioned triple compound, which has been dissolved by means of the ammonia, and converted into the quadruple compound.

*Results established by the Experiments related in this Memoir.*

1. The statement of other chemists, and particularly of Richter, respecting the great difficulty, or even impossibility, of obtaining a pure yellow oxide of tungsten by treating Scheele's tungstic acid with nitric acid, is established.

2. The employment of an oxide of tungsten obtained by the method described above is improper on two accounts. If we employ it after it has been exposed to a red heat, we obtain by means of it an apparently pure tungstate of ammonia; but for the extraction of the oxide of tungsten which it contains, an excessive quantity of ammonia is necessary; as by the red heat the oxide of tungsten is united with the undecomposed triple compound mixed with it, and forms a very cohesive compound, and therefore very difficultly acted on by ammonia. If we employ the oxide without exposing it to a red heat, we form, when we dissolve it in ammonia, a great quantity



of a quadruple compound (the properties of which are given in experiment 10) consisting of oxide of tungsten, potash, ammonia, and muriatic acid; and only a very small quantity of tungstate of ammonia can be obtained. This shows us the necessity of employing pure oxide of tungsten in the formation of tungstate of ammonia.

3. Besides the yellow and dark blue oxides of tungsten, there seems to exist another of a dark brownish red or reddish brown colour. It may be obtained by the application of heat to the tungstate of ammonia, in consequence of the deoxidizing property of the ammonia. In respect to the degree of oxidation, it seems to lie between the yellow and the blue oxides.

4. The complete reduction of oxide of tungsten by the method above described is a much easier process than the fusion of the reduced metal. This holds likewise with molybdenum, manganese, and other difficultly fused metals.

5. It is exceedingly probable that the failure which different chemists have experienced in their attempts to reduce the oxide of tungsten, was owing to a mixture of the triple compound with the oxide employed by them.

6. The statement of the Elhuyarts and of Allen and Aikin respecting the specific gravity of this metal is confirmed. We may consider 17.4, the mean of preceding statements, as near the truth. The other statements respecting the colour, lustre, hardness, and brittleness, of our metal, are likewise confirmed.

7. The presence of a portion of Scheele's tungstic acid in the oxide of tungsten prevents its complete reduction, and causes it to run into a slag.

## ARTICLE VII.

*Description of an Elementary Galvanic Battery.* By W. Hyde Wollaston, M.D. Sec. R.S.

(To Dr. Thomson.)

DEAR SIR,

AGREEABLY to your request, I now send you a description of a small battery which I showed you some time since, and shall feel obliged by the insertion of it in your *Annals*.

Since the ignition of metallic wires is highly instructive with respect to the vast quantity of electricity evolved during the solution of metals, I made, about three years since, a series of experiments for the purpose of ascertaining the most compendious form of apparatus by which visible ignition might be shown.

The result of these trials was, that a single plate of zinc one inch square, when rightly mounted, is more than sufficient to ignite a

wire of platina  $\frac{1}{3000}$ \* of an inch in diameter, even when the acid employed is very dilute.

But for this purpose each surface of the zinc must have its counterpart of copper or other metal opposed to it; for when copper is opposed only to one face, the action on the posterior surface of the zinc is wasted to little or no purpose.

The smallest battery that I formed of this construction consisted of a thimble without its top, flattened till its opposite sides were about  $\frac{2}{10}$  of an inch asunder. The bottom part was then nearly one inch wide, and the top about  $\frac{8}{10}$ ; and as its length did not exceed  $\frac{9}{10}$  of an inch, the plate of zinc to be inserted was less than  $\frac{3}{4}$  of a square inch in dimensions.

Previously to insertion, a little apparatus of wires, through which the communication was to be made, was soldered to the zinc plate, and its edges were then coated with sealing-wax, which not only prevented metallic contact at those parts, but also served to fix the zinc in its place by heating the thimble so as to melt the wax.

A piece of strong wire, bended so that its two extremities could be soldered to the upper corners of the flattened thimble, served both as a handle to the battery, and as a medium to which the wires of communication from the zinc could be soldered.

The conducting apparatus consisted in the first place of two wires of platina about  $\frac{1}{40}$  of an inch in diameter and one inch long, cemented together by glass in two parts, so that one end of each wire was united to the middle of the other. These wires were then tinned, not only at their extremities for the purpose of being soldered to the zinc and to the handle, but also in the middle of the two adjacent parts for receiving the fine wire of communication.

One inch of silver wire  $\frac{1}{100}$  of an inch in diameter, containing platina at its centre  $\frac{1}{30}$  part of the silver in diameter, was then bended so that the middle of the platina could be freed of its coating of silver by immersion in dilute nitrous acid. The portion of silver remaining on each extremity served to stretch the fine filament of platina across the conductors during the operation of soldering. A little sal-ammoniac being then placed on the points of contact, the soldering was effected without difficulty, and the two loose ends were readily removed by the silver attached to them.

It should here be observed, that the two parallel conductors cannot be too near each other provided they do not touch, and that on this account it is expedient to pass a thin file between them (previously to soldering on the wire) in order to remove the tin from the adjacent surfaces. The fine wire may thus be made as short as from  $\frac{1}{10}$  to  $\frac{1}{50}$  of an inch in length; but it is impossible to measure with

\* For the method of drawing fine wires of platina, by coating them with a quantity of silver, I must refer to the description which I have formerly given of that contrivance. *Phil. Trans.* 1813, p. 114. See *Annals of Philosophy*, vol. ii. p. 233.

precision, since it cannot be known at what points the soldering is in perfect contact.

The acid which I have employed with this battery consists of one measure of sulphuric acid diluted with about 50 equal measures of water; for though the ignition effected by this acid be not permanent, its duration for several seconds is sufficient for exhibiting the phenomenon, and for showing that it does not depend upon mere contact, by which only an instantaneous spark should be expected.

Although in this description I have mentioned a wire  $\frac{1}{3000}$  of an inch in diameter, I am doubtful whether this thickness is the best. I am, however, persuaded that nothing is gained by using a finer wire; for though the quantity of matter to be heated is thus lessened, the surface by which it is cooled does not diminish in the same ratio; so that where the cooling power of the surrounding atmosphere is the principal obstacle to ignition, a thicker wire, which conveys more electricity in proportion to its cooling surface, will be more heated than a thin one, a fact which I not only ascertained by trials on these minute wires, but afterwards took occasion to confirm on the largest scale by means of the magnificent battery of Mr. Children in the summer of 1813.

I remain, dear Sir, ever very faithfully yours,

Buckingham-street, Fitzroy-square,  
Aug. 5, 1815.

WM. H. WOLLASTON.

## ARTICLE VIII.

*Objections to Sir H. Davy's Theory of Chlorine.* By J. Berzelius,  
M. D. F. R. S. Professor of Chemistry at Stockholm.

(To Dr. Thomson.)

SIR,

Stockholm, June 6, 1815.

I HAVE just received the English scientific journals for the last seven months. In one of the numbers of your *Annals* you express a wish that I should explain how the theory of Sir H. Davy respecting the nature of muriatic acid is inconsistent with the law respecting the combination of oxides with each other. I therefore give the following statement.

According to the old theory, muriate of lead is composed of 100 parts acid and 410 of oxide of lead. The submuriate of lead is composed of 100 acid +  $410 \times 4 = 1640$  oxide. This salt, when prepared by precipitation, contains combined water, which may be separated by heating the salt in a retort. The quantity of this water amounts to  $133\frac{1}{2}$  parts for every 1740 parts of the dry salt. Now the oxygen in this water is just equal to that in the oxide of lead present. You know, likewise, that in the submuriate of copper

100 parts of the acid are combined with 589 parts of oxide of copper and with  $133\frac{1}{2}$  of water. Here the oxygen in the water is likewise equal to that in the oxide.

You are aware, I presume, that neither Davy, nor the partisans of the new theory, agree with themselves in what ought to be considered as a hydro-chlorate or a chloride. Sometimes they speak of chloride of potassium, barium, copper, iron; sometimes they give the name of muriate or hydro-chlorate to these bodies. Such is the looseness of the theory, that we cannot point out any essential difference between the hydro-chlorates and chlorides. (Yet if we confine ourselves to analogy, to which these chemists, however, do not seem to attach any value, there is a decided difference between the *sulphuret of potassium* and the *hydro-sulphuret of potash*, one of which represents the *chloride*, and the other the *hydro-chlorate*.) Therefore when we wish to discuss their opinions, we must foresee all their methods of escaping from the examination; because if you prove that such a body cannot be a chloride, they answer that it is a hydro-chlorate, decomposing and forming water at the pleasure of the hypothesis, with a facility which has no other example in the whole science of chemistry; for the sulphurets, phosphurets, and tellurets, of the alkaline metals decompose likewise water; but water in these cases cannot be formed at pleasure, provided the access of air be withheld. If we ask the partisans of the new theory what is their opinion of the composition of the submuriates in question, they will immediately answer that they are real subhydro-chlorates, composed of hydro-chloric acid, oxide of copper, and water. But if the existence of such a hydro-chloric acid be real, it is to be supposed that the subhydro-chlorates in question are composed according to the same laws as all the other salts.

We must then, in order to convert the 100 parts of muriatic acid (supposed by the old theory) into hydro-chloric acid, take away the fourth part of the  $133\frac{1}{2}$  of water, the oxygen of which constitutes an integrant part of the chlorine, and the hydrogen of which added to the chlorine produces hydro-chloric acid. The weight of the metallic oxide remains the same. The 133.5 parts of water, then, which the analysis gives, do not exist wholly in the salt in the state of water. Only 100.2 parts exist in that state. The remaining 33.3 parts are produced by the operation when the hydrogen of the acid unites to a portion of the oxygen of the oxide in order to produce a chloride. But the oxygen of the metallic oxide is 117.8, while that of 100.2 parts of water only amounts to 88.6; that is to say, precisely three-fourths as much as the oxygen of the base. Here, then, we have a body composed of an acid without oxygen, of an oxide base, and of water of combination. The oxygen of the water ought to be in this case, as in all other salts, both neutral and with excess of base, a multiple or a submultiple by a whole number of that of the base. But we have just seen that it amounts only to three-fourths of it. Hence it follows that either the hypothesis of Davy, or the rule concerning the combination of oxides, is inaccu-

rate. No, it is said, the hypothesis of Davy does not consider these bodies as subhydro-chlorates. They are composed of the chloride of copper or lead, combined with the oxide of the same metal and with water, so that for one atom of chloride there are three atoms of oxide and four of water, a composition which agrees perfectly with the laws of chemical proportions. But this is a mistake. It is conformable, indeed, to the atomic theory of Dalton, which pays no attention to the relation of the oxygen of the different oxides combined; but it is contrary to the law above stated; for it supposes that the oxygen of the oxide is 88·6, and that of the water 117·8; that is, that the former is only three-fourths of the latter. I do not know whether the new hypothesis admits still other explanations; but it is obvious that the two explanations given here are contrary to the law which determines the respective quantities of bodies that combine. Therefore either that law or the hypothesis is incorrect. Sir H. Davy, in speaking of my objections to his hypothesis, says, "I cannot regard these arguments as possessing any weight;" "and there is no general canon with respect to the multiples of the proportions in which different bodies combine." I do not think that this manner of refuting is admissible in the sciences. This celebrated chemist has taken advantage of his great superiority, and has predisposed the reader to believe that six years of labour on my part to find and to establish by numerous experiments the law, which he says does not exist, have been lost without fruit. I suppose, however, that he will one day do me the justice to take the trouble to prove by experiment that I have deceived myself if he finds that I am in the wrong,

---

## ARTICLE IX.

*An Essay on the Shapes, Dimensions, and Positions of the Spaces in the Earth which are called Rents, and the Arrangement of the Matter in them: with the Definition and Cause of Stratification.*  
By Mr. John B. Longmire.

(Continued from p. 46.)

### I. ON RENTS.

#### 1. *Additional Remarks on the Positions of the Strata near Bended-Tabular Rents.*

I HAVE before laid it down as a general rule that the distance which the strata are asunder on opposite sides of bended-tabular rents is owing to a bending in the strata, which commences at the lowest extremities, increases to the middles, then decreases to, and ends at, the highest extremities of these rents. But, although this

is the general mode, and one that is subject to some modifications, there is another mode by which this difference of level is produced.

Miners often find the strata, any distance from a foot to more than 40 fathoms asunder, in point of altitude, on opposite sides of bended-tabular rents, in places where these strata are not bent; but straight, as the stratum  $abcd$ , Plate XXXVIII, fig. 1, and the stratum  $c$ , along with the strata  $BA$ , fig. 2, are represented. In the first mode, the distances which the strata are asunder, on opposite sides of these rents, are obtained by the bending of the strata, and always continue, and sometimes increase, during many temporary suspensions of this bending; but in the second mode, it takes place without any bending of the strata.

I will give one example to illustrate each mode. Let fig. 1 be representative of the first mode. The stratum  $ad$  is horizontal, notwithstanding the part  $ab$  is the distance  $bc$  below the part  $cd$ . Above this stratum, at the rent  $A$ , the strata are straight for a certain distance, and then they are bent; and below this stratum they are also bent, at first slightly, but with a gradually increasing ratio, that reaches its maximum at the stratum  $kn$ ; whose two parts  $kl$  and  $mn$  are the distance  $ml$  asunder, which is equal to the distance  $fg$ , and to the distance  $bc$ , and which is acquired by the bending of the part  $mn$  above the line  $ln$ . The strata close to the side  $pgc$  at this part of the rent are thicker than close to the side  $lfb$ : they are also thicker at  $mp$  than at  $qn$ , and that additional thickness throughout the whole of the rent, below the stratum  $kn$ , gave rise to the bending of the part  $mn$  of that stratum, in the manner which has been shown in my first communication on rents; but the strata above the stratum  $mn$  where close to the side  $mc$  of the rent, though thicker than the opposite strata on the side  $lb$ , are not so thick as they are at the line  $nd$ ; in consequence, the bending, as seen at  $mn$ , gradually decreases upwards till it ceases. Let us take, by way of illustration, the effect on the stratum  $ch$ , of this alteration in the thickness of the strata: as much as the strata which are situated between the strata  $kn$  and  $ch$  are thicker at the line  $nh$  than at  $ke$ , so much is the distance  $nh$  greater than the distance  $ke$ , (say by the distance  $ho$ ), and so much is the stratum  $gh$  bent less than the stratum  $mn$ , say by the distance  $ir$ . The bending of the strata above the stratum  $ch$  also diminishes upwards, from the same cause, till it ceases at the stratum  $ad$ , which is straight. At first sight the position of the stratum  $ad$ , considering how much one part is higher than the other, appears to be irreconcilable with that arrangement which I have considered the general one; but when its connexion with that of the strata below is traced as we have now done, its difference from that which is the common one is easily accounted for. In fact, the arrangement of the elementary matters in this part is such, that the strata have contracted less, instead of more, at the line  $nd$  than close to the side  $mc$  of the rent; and by doing so have gradually given the straight, instead of

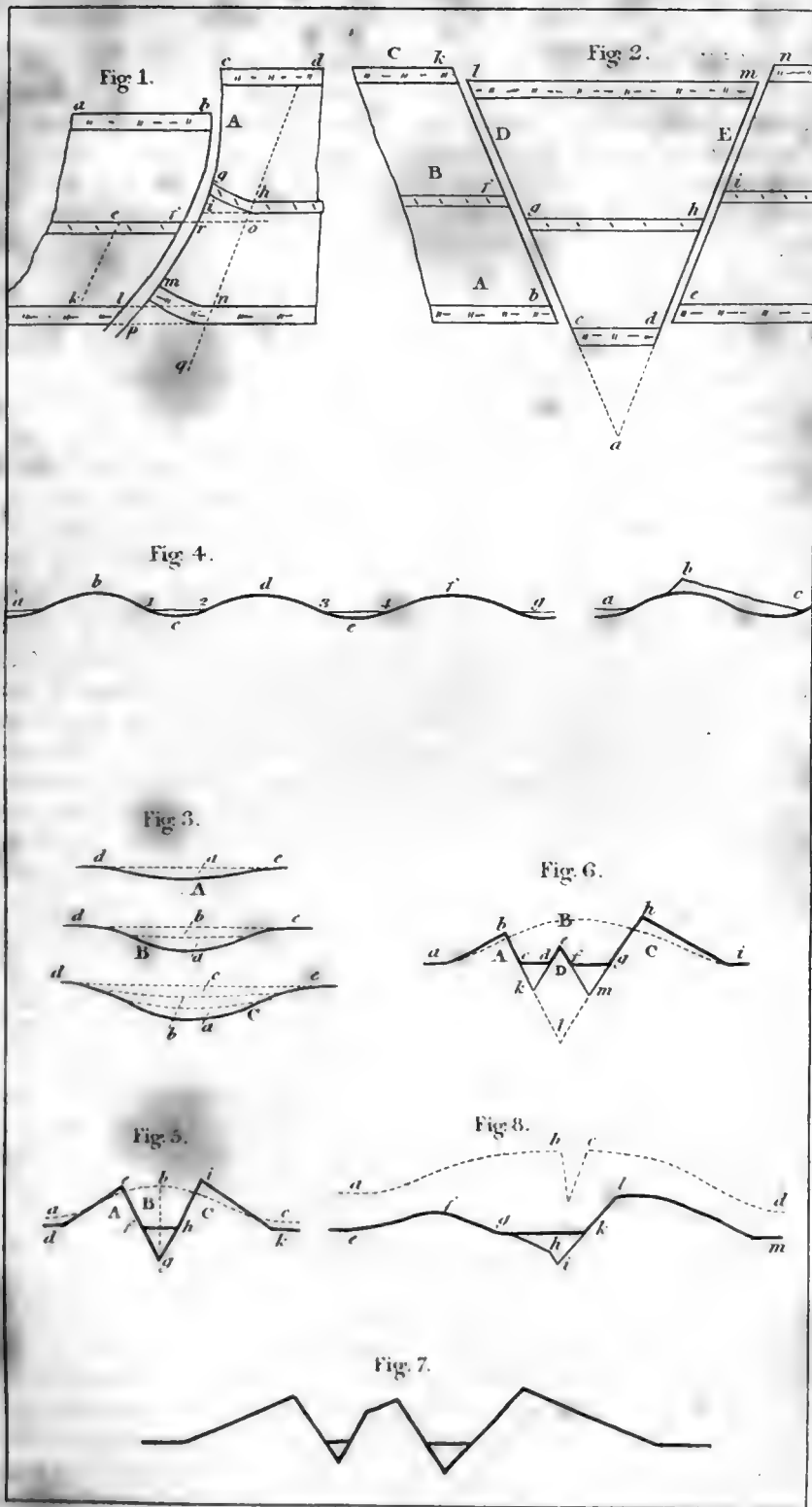

*M. Senguir on Roub...*



Faint, illegible text at the top of the page, possibly a header or introductory paragraph.



Main body of faint, illegible text, likely the primary content of the document, possibly a report or official communication.

the bended position to the strata of this part: while these strata close to the rent have contracted, as usual, less on the under side  $p c$  than on the upper side  $l b$ . Hence also the distance between the straight strata on opposite sides of this rent is equal to that between similar parts of the bent strata.

An example of the second mode is that which follows. Sometimes the strata near bended-tabular rents are all, or nearly all, straight, notwithstanding they are situated at different levels on opposite sides. Thus the strata  $A B C$ , fig. 2, and those which lie between them, are straight on both sides of the rents  $D E$ ; but the parts of the strata  $b f k$  and  $e i n$  are higher on the under sides than the parts  $c g l$  and  $d h m$  on the upper sides of these rents. The strata in this figure, as well as those near all rents of this shape, are thicker on the upper than on the under sides; and by this greater thickness the stratum  $A$  is higher at  $b e$  than at  $c d$ , the stratum  $B$  at  $f i$  than at  $g h$ , and the stratum  $C$  at  $k n$  than at  $l m$ . Now, as has been before shown, this difference in the thickness of the strata is a consequence of the unequal contraction of the stratified matter; that is to say, the strata have contracted more near the upper sides than near the under sides of these rents. But although they have contracted with different ratios on different sides, yet in the example before us *the ratio on any one side has been uniformly the same throughout the strata*, instead of being, as in general, the least near the rents, and the greatest at given distances from them. In consequence, then, of this uniformity in the ratio of contraction of the strata, *when taken on one side only*, they are straight on both sides of some rents, although they are situated at different levels on opposite sides of such rents.

It may be proper to remark here that, though the strata are straight, and higher on one side of a rent than on the other, when seen in a cross section, as in fig. 2; yet when a view is taken at right angles to this section, or when a person faces the rent, every stratum then separates at one horizontal extremity into two parts, one inclining very gently upwards, and the other downwards, till opposite the middle of the rent; then the higher part dips downwards, and the lower part rises upwards, till they meet again at the other horizontal extremity of the rent.

## 2. *Observations on the Upper Extremities of large Bended-Tabular Rents.*

The upper extremities of some rents are altogether situated in the solid rock, and at considerable distances below the surface. Many large rents extend downwards from the surface of the solid rock, or that of the solid strata, to great depths; but some of them reach above the solid, through the alluvial matter, to within a few inches of the earth's surface.

Some of the rents which reach nearly to the surface are precisely of the same dimensions in the alluvial clay, as in the solid rock.

below : and what is more remarkable in the lower half of the alluvial clay, they are sometimes filled with spar and the usual contents of the rents, and in the upper half, with clay deeply tinged with iron ; and sometimes opposite the whole height of the alluvial matter they are filled with iron tinged clay : in both instances the rents are covered with only thin strata of soil. In the Shropshire and Cumberland coal formations I have seen rents so circumstanced at the earth's surface ; and at Lead Hills in Scotland, in company with Mr. Martin of that place, I met with two such rents, that are situated in the north side of the valley and to the west of the Susannah vein. Other rents that reach to only a few inches below the surface are as wide in the alluvial clay just above the top of the hard rock as they are below ; but upwards, they increase in width in such a ratio that each side deviates from  $20^{\circ}$  to  $30^{\circ}$  from a perpendicular line. Opposite the alluvial matter they contain clay, mixed throughout with large cobbles, which last are very numerous at the bottom. The contents in these parts appear as if they had been washed into the rents. I have seen such rents in Cornwall. Rents reaching through the alluvial matter exist most abundantly in low and smooth mountainous districts, such as Cornwall and Lead Hills.

The existence of rents in alluvial matter, though new to men of science, is a very important fact. It shows us that the alluvial matter must have been formed before these rents ; otherwise, after reaching the surface of the present rocks, the rents could not have passed through the alluvial matter. It also shows us that the alluvial matter was formed from the matter below, when this matter was the least able to resist a disintegrating force : and by it we know that the alluvial matter has not been removed since then. Hence the rocks or strata underneath such parts have not been in the least wasted by the elements.

## II. ON STRATIFICATION.

I have said that the phenomenon of stratification, in one point of view, is an effect of the unequal contraction of the earth's matter. I will now give my reasons for this assertion. But perhaps it may be previously necessary to give a definition of the term. Stratification consists in that assemblage of tabular masses, *wherein any one mass is parallel to that next above, and to that next below it.* A formation that is entitled to be called stratified must have this arrangement of parts every where. According to this definition, all, or nearly all, the red and white sand-stone, and some of the limestone formations, are stratified ; but the formations of granite, mica-slate, &c. are not stratified, unless they lie in hollows, as they sometimes do, on the primitive and unstratified mass. Mountains divided, *in a few places*, into tabular distinct concretions, have sometimes been called stratified ; but to possess this structure they must be every where divided into tabular masses, which have the

same relation to one another as I have shown to be necessary to constitute stratification.

After the matter on which all stratified formations rest had assumed a small degree of solidity, it contracted unequally. Hence one part of its surface sunk lower than another, and gradually formed a number of hollows, into which as gradually entered originally fluid matter, and matter greatly comminuted and mechanically suspended in water.

Let us endeavour to follow the formation of a hollow through a few stages. Let A, fig. 3, be the first stage. Here a hollow, say of a few feet in depth, is observed, which has been gradually formed by the sinking of one part *a* lower than the part *d e*. Let B be the second stage. The hollow has now got an additional area marked *b*, and is twice the depth that it was at the end of the first stage, with an equal increase of dimensions sideways. Between this stage and the first the hollow has been gradually increasing in dimensions by the sinking of the part *a b* more than the part *d e*. C is the third stage; in which another space *c* is added to the hollow. In this manner the extension of the hollow would continue as long as the matter continued to contract unequally, or till the earth had acquired its present degree of solidity. Some hollows are filled with matter of one denomination, as white sand-stone, &c.; others with that of various denominations, as in the coal formations. The matter in the former instance has proceeded from one source; in the latter, from different sources. Some hollows, again, were filled with matter while forming; others not till after they were totally, or at least nearly, formed. But all hollows so produced, and filled, and such spaces only, except a few rents, contain matter having the stratified structure. The slow but gradual entry into hollows of matter either fluid or mechanically suspended in water, is certainly necessary to give to such matter the stratified structure; but if these hollows had not been formed by the unequal contraction of the matter below them, the present stratified matter would have remained for ever in its original situation. Stratification, then, in this point of view, is an effect of the unequal contraction of the earth's matter.

## ARTICLE X.

Magnetical Observations at Hackney Wick. By Col. Beaufoy.

Latitude,  $51^{\circ} 32' 40.3''$  North. Longitude West in Time  $6^{\text{h}} \frac{8^{\circ}}{150}$ .

1815.

Month	Morning Observ.			Noon Observ.		Evening Observ.		
	Hour.	Variation.		Hour.	Variation.	Hour.	Variation.	
July 18	8h 30'	24°	16' 35''	1h 30'	24° 26' 48''	7h 10'	24°	20' 30''
Ditto 19	—	—	—	—	—	7 00	24	20 17
Ditto 20	8 45	24	21 25	1 25	24 29 14	7 00	24	19 56
Ditto 21	8 40	24	19 06	—	—	7 05	24	20 13
Ditto 22	8 30	24	17 21	—	—	7 00	24	20 30
Ditto 23	8 30	24	17 38	1 20	24 25 16	7 00	24	20 34
Ditto 24	8 35	24	17 06	1 25	24 26 36	7 15	24	19 12
Ditto 25	8 25	24	13 15	—	—	7 00	24	19 11
Ditto 26	8 25	24	16 55	1 30	24 26 35	—	—	—
Ditto 27	8 25	24	16 04	1 45	24 25 35	7 00	24	18 53
Ditto 28	8 20	24	15 56	—	—	—	—	—
Ditto 29	8 30	24	15 58	1 30	24 26 08	7 05	24	18 53
Ditto 30	8 35	24	18 20	1 20	24 25 00	7 00	24	20 57
Ditto 31	8 30	24	16 56	1 35	24 24 20	7 00	24	18 10

Magnetical Observations continued.

1815.

Month.	Morning Observ.			Noon Observ.		Evening Observ.		
	Hour.	Variation.		Hour.	Variation.	Hour.	Variation.	
Aug. 1	8h 20'	24°	16' 43''	1h 25'	24° 24' 49''	—h —'	—° —'	—''
Ditto 2	8 40	24	17 27	—	—	—	—	—
Ditto 3	8 15	24	15 53	—	—	6 55	24	18 58
Ditto 4	8 25	24	19 18	1 20	24 27 23	—	—	—
Ditto 5	8 30	24	16 40	1 30	24 25 53	—	—	—
Ditto 6	8 25	24	16 01	1 30	24 25 09	6 50	24	19 34
Ditto 7	8 25	24	14 24	1 25	24 22 48	6 55	24	17 32
Ditto 8	8 25	24	15 46	1 25	24 25 24	6 55	24	17 38
Ditto 9	8 15	24	17 41	1 30	24 25 32	6 55	24	20 11
Ditto 10	8 15	24	13 54	1 25	24 25 00	6 55	24	17 28
Ditto 11	8 15	24	15 34	1 40	24 21 31	6 55	24	19 24
Ditto 12	8 20	24	13 42	—	—	6 55	24	18 47
Ditto 13	8 20	24	15 09	1 15	24 21 12	—	—	—
Ditto 14	8 20	24	15 12	1 45	24 23 52	6 55	24	18 58
Ditto 15	8 25	24	17 24	1 05	24 25 40	6 55	24	18 42
Ditto 16	8 35	24	17 16	1 25	24 21 10	—	—	—
Ditto 17	8 35	24	17 13	1 20	24 23 25	6 55	24	17 26

## Comparison of Observations.

		1813.	1814.	1815.
April.....	Morning .....	24° 09' 18"	24° 12' 53"	24° 16' 01"
	Noon .....	24 21 12	24 23 53	24 27 42
	Evening .....	24 15 25	24 15 30	24 17 48
May.....	Morning .....	24 12 02	24 13 12	24 16 32
	Noon .....	24 20 54	24 22 13	24 27 03
	Evening .....	24 13 47	24 16 14	24 19 12
June.....	Morning .....	24 12 35	24 13 10	24 16 11
	Noon .....	24 22 17	24 22 48	24 27 18
	Evening .....	24 16 04	24 16 29	24 19 40
July.....	Morning .....	24 14 32	24 13 29	24 15 51
	Noon .....	24 23 04	24 23 44	24 25 45
	Evening .....	24 16 43	24 17 00	24 19 42

In deducing the mean of the observations in July, the morning and noon observations are rejected, on account of the great variation.

July 30.—The needle, after being steady for several weeks, vibrated 2' 15". The wind blew fresh from the north, and the needle has continued unsteady.

Rain fallen { Between noon of the 1st July } 1.509 inch.  
 { Between noon of the 1st Aug. }  
 Evaporation during the same period ..... 3.65

Since the instrument was constructed with which these observations were made, Mr. George Dollond, of St. Paul's Church Yard, has so much improved the construction, that the instrument which he now makes combines the advantages of a theodolite, transit, and equal altitude instrument and variation compass, and is equally portable with mine.

---



---

## ARTICLE XI.

### ANALYSES OF BOOKS.

#### I. *Philosophical Transactions of the Royal Society of London for 1815, Part I.*

This volume contains the nine following papers:—

1. *Additional Observations on the Optical Properties and Structure of heated Glass and unannealed Glass Drops.* By David Brewster, LL.D. F.R.S. Edin. and F.A.S. Edin.—In a former paper the author had shown that glass, when heated, acted on light like crystallized bodies; and that Prince Rupert's drops possessed a similar property. On examining these drops carefully, lines were visible in them, forming imperfect cleavages, and rendering the

crystalline structure more evident. The specific gravity of the unannealed and annealed drops was found to be nearly the same, 3.276, allowance being made for the cavities contained in the unannealed drops. These vacuities are occasioned by the contraction of the internal parts of the drop while cooling. They disappear when the drop is heated to redness. It appears, then, that heat produces a crystalline structure in glass, which vanishes as the glass cools.

2. *Description of a new Instrument for performing mechanically the Involution and Evolution of Numbers.* By Peter M. Roget, M.D.—This instrument consists in a very convenient and ingeniously contrived sliding rule, which must be useful in a great variety of cases.

3. *Experiments on the Depolarization of Light, as exhibited by various Mineral, Animal, and Vegetable Substances, with a reference of the Phenomena to the general Principles of Polarization.* By Dr. Brewster.—In this paper Dr. Brewster gives a list of 58 substances, animal, vegetable, and mineral, which depolarize light; and of 53 substances, which have no effect in depolarizing light. He then gives what he calls a theory of the depolarization of light. The various modes in which bodies depolarize light may be reduced to seven. 1. When the crystal possesses neutral axes, and forms two images which are capable of being rendered visible, as in *calcareous spar, topaz, &c.* In this case he shows that the apparent depolarization of the pencil is nothing more than the polarizing of it in a new plane. 2. When the crystal possesses neutral axes, and exhibits only a single image, as in the *human hair*, and various *transparent films.* This he considers as exactly the same with the first case, excepting that the two images formed by the human hair, &c. being produced by the same, or nearly the same, refractive power cannot be rendered visible by any contrivance. 3. When the crystal has no neutral axes, but depolarizes light in every position, as in *gum arabic, caoutchouc, tortoise-shell, &c.* These bodies are composed of thin plates lying above each other. Each of these plates possesses neutral axes, and depolarizing axes. But as these different axes do not coincide with each other in the different plates, the consequence is, that the compound body depolarizes in every direction. 4. When there is an approach to a neutral axis, as in *gold-beaters' skin, &c.* In this case the body is composed of thin films, like the preceding; but the neutral axes of each are nearly coincident. 5. When the crystal depolarizes or restores only a part of the polarized image, as in a *film from sea weed*, and a *film from the partan (crab).* He considers that this case is owing to the bodies which possess this property being partly crystallized and partly uncrystallized. 6. When the crystal depolarizes luminous sectors of nebulous light, as the *oil of mace.* How the halo in this case is produced, he does not attempt to explain: but he conceives that it necessarily follows from the phenomena that there are two halos or nebulous images, the one lying exactly above the other, and having



every alternate sector polarized in an opposite manner. 7. When the crystal restores the vanished image, but allows it to vanish again during the revolution of the calcareous spar. Every body which possesses this kind of depolarization forms either a bright and a nebulous image, or a single image, the light of which is all polarized in the same manner.

4. *On an Ebbing and Flowing Stream, discovered by boring in the Harbour of Bridlington.* By John Storer, M.D.—In the year 1811 a boring was made in the harbour of Bridlington, in order to ascertain the thickness of the bed of clay which constitutes its bottom. The workmen having bored through 28 feet of very solid clay, and afterwards through 15 feet of a cretaceous flinty gravel of a very concrete texture, the auger was perceived to strike against the solid rock. As they were unable to make any impression upon this rock, the work was given up for that tide, without any appearance of water. But the pit gradually filled with fresh water; and when the tide rose within 49 or 50 inches of the mouth of the bore, this water overflowed, and continued to do so till the tide had ebbed so as to be 49 or 50 inches below the mouth of the bore. This pit was afterwards converted into a well, and it continues to overflow with the same regularity as at first. Mr. Milne, Collector of the Customs at Bridlington, has formed the following theory to account for this curious phenomenon. The bed of clay, he conceives, extends to Smithwick sand, which forms a bar across the opening of the bay, about four miles from the quay in a south-easterly direction. The rain water which flows below this clay cannot be discharged till it arrives at the ledge of rocks where the clay terminates. Its issue will meet with more or less resistance according to the depth of the sea water. Hence the reason why the well overflows every tide. There is a circumstance which Dr. Storer thinks militates against this hypothesis. After great rains, the column of spring water is elevated, and the discharge prolonged during each tide. He thinks the subject might be elucidated by a more perfect acquaintance with the peculiarities of the springs on this part of the coast which are called *gipsies*.

5. *On the Effects of simple Pressure in producing that Species of Crystallization which forms two oppositely Polarized Images, and exhibits the complimentary Colours by Polarized Light.* By Dr. Brewster.—The author found that calf's-foot jelly and isinglass, when first gelatinized, did not possess the property of depolarizing light; but they gradually acquired it by keeping, and immediately by pressure between two plates of glass.

6. *Experiments made with a view to ascertain the Principle on which the Action of the Heart depends, and the Relation which subsists between that Organ and the Nervous System.* By A. P. Wilson Philip, Physician in Worcester.—From these experiments it appears that the brain or spinal marrow, or both of them, may be removed from the body, or destroyed slowly, without impeding the action of the heart, provided artificial respiration be kept up;

that when stimuli (alcohol, opium, tobacco,) are applied to the brain or spinal marrow, the action of the heart is greatly increased; and that when the brain or spinal marrow is destroyed at once by crushing them, the action of the heart is destroyed or impeded.

7. *Experiments to ascertain the Influence of the Spinal Marrow on the Action of the Heart in Fishes.* By Mr. William Clift.—From these experiments it appears that the heart of a carp continues to beat for several hours after the pericardium is laid open; that if the fish be left in the water, this action ceases much sooner than if the fish be allowed to remain quiet in the open air; that the spinal marrow may be destroyed, and the brain removed, without injuring the action of the heart; but that this action is somewhat injured by suddenly destroying the brain.

8. *Some Experiments and Observations on the Colours used in Painting by the Ancients.* By Sir Humphry Davy, LL. D. F. R. S.—The author, while in Italy, had an opportunity of examining some pigments found in the baths of Titus, and some dug up from Pompeii. He made experiments also upon the fresco paintings in the baths of Titus. The following are the facts which he ascertained:—1. The *red* colours employed in these paintings were red lead, vermilion, and iron ochre. 2. The *yellows* were yellow ochre, in some cases mixed with chalk, in others with red lead. The ancients likewise employed orpiment and massicot as yellow paints. 3. The *blue* was a pounded glass, composed of soda, silica, lime, and oxide of copper. Indigo was likewise employed by the ancients, and they employed cobalt to make blue glass. 4. The *greens* were compounds containing copper; sometimes the carbonate mixed with chalk, sometimes with the blue glass. In some cases they consisted of the *green earth* of Verona. Verdigris was likewise used by the ancients. 5. The *purple* colour found in the baths of Titus was either an animal or vegetable substance, perhaps the colouring matter of the *murex* combined with alumina. 6. The *blacks* were carbonaceous matter; the *browns*, ochres often containing manganese. 7. The *whites* were chalk or clay. White lead was known likewise to the ancient painters.

9. *On the Laws which regulate the Polarization of Light by Reflection from Transparent Bodies.* By Dr. Brewster.—This paper may be considered as a treatise on the subject. The author ascertained by experiment that the *index of refraction is the tangent of the angle of polarization*. From this law he shows how all the phenomena may be deduced, and the result of all the experiments determined beforehand. But from the great conciseness of the paper, and the mathematical dress in which it has been put, it is out of our power to convey to our readers an intelligent abridgment of it.

II. *A Treatise on the Economy of Fuel and Management of Heat, especially as it relates to Heating and Drying by means of*

*Steam: in four Parts.* 1. *On the Effects of Heat, the Means of measuring it, the comparative Quantity of Heat produced by different Kinds of Fuel, Gas Light, &c.* 2. *On heating Mills, Dwelling-houses, Baths, and Public Buildings.* 3. *On drying and heating by Steam.* 4. *Miscellaneous Observations. With many useful Tables. Illustrated by Plates. With an Appendix: containing Observations on Chimney Fire-places, particularly those used in Ireland—on Stoves—on Gas Lights—on Lime-Kilns—on Furnaces and Chimneys used for rapid Distillation in the Distilleries of Scotland—on improved Boilers for evaporating Liquids.* By Robertson Buchanan, Civil Engineer.—Glasgow, 1815.

This ample title-page is sufficient to inform the reader what he may expect to find in this useful little work, which is of too miscellaneous a nature to admit of an analysis within any reasonable compass. The most valuable part of it consists in the details with which it furnishes us respecting the modes of warming buildings by steam employed by manufacturers in different parts of Great Britain.

III. *A Practical Treatise on Gas Light: exhibiting a summary Description of the Apparatus and Machinery best calculated for Illuminating Streets, Houses, and Manufactories, with Carbureted Hydrogen or Coal Gas: with Remarks on the Utility, Safety, and General Nature of this new Branch of Civil Economy.* By Frederick Accum, Operative Chemist, Lecturer on Practical Chemistry, on Mineralogy, and on Chemistry applied to the Arts and Manufactures, Member of the Royal Irish Academy, Fellow of the Linnæan Society, Member of the Royal Academy of Sciences at Berlin, &c. &c.—London, 1815.

This contains a perspicuous and popular view of the subject, and may be of considerable utility to those who, without being acquainted with chemistry, wish to have some general notion of the nature of gas lights.

---



---

## ARTICLE XII.

### *Proceedings of Philosophical Societies.*

#### ROYAL INSTITUTE OF FRANCE.

*Account of the Labours of the Class of Mathematical and Physical Sciences of the Royal Institute of France during the Year 1814.*

(Continued from p. 149.)

M. Auguste de St. Hilaire, several considerable botanical dissertations by whom we have formerly mentioned, has given us one this year on different families of plants, in which the placenta, that is

to say, the part of the fruit to which the grains adhere, is simple, and placed in the middle of the fruit, like a column or an axis.

When the summit of this column is free, the way by which the influence of the pollen is transmitted from the pistil to the seeds, appears to be very complicated, and to be by means of vessels which run along the fruit itself to penetrate the placenta at its base, and go to the seeds side by side of the nourishing vessels. Such, in fact, is the direction of these vessels in the *amarantaceæ*, according to M. de St. Hilaire. But this observer has remarked that in most plants of the category which he studies, and particularly in the *primulacæ*, the *portulacæ*, the *caryophylleæ*, fecundation takes place in a more direct way. For this purpose there exists at first very fine vessels, proceeding from the base of the style to the summit of the placenta. These filaments are destroyed after fecundation, and then only the summit of the placenta becomes free.

M. de St. Hilaire conceives also that there always exists a point or a pore different from the umbilicus, by which the fecundating vessels arrive at the grain, and to which M. Turpin, as we have mentioned in one of our preceding reports, has given the name of *micropile*.

The part of M. de St. Hilaire's memoir which is purely botanical presents many detailed observations (unfortunately scarcely susceptible of analysis) on the particular characters of certain plants of the families that he examined, some of which, in his opinion, ought to serve as types for new genera, and others ought to pass into families different from those in which incomplete observations have hitherto placed them.

The pisang plantain, or fig-tree of Adam, is an herbaceous plant of the height of a tree, very remarkable for the enormous size of its leaves, and celebrated for the utility of its fruits, which furnishes to the inhabitants of the torrid zone one of the principal articles of their food. The cultivation of it has multiplied the varieties to such a degree, that there are probably as many sorts as we possess of apples or pears; and it is equally difficult to distinguish among them the primitive species. Accordingly botanists differ very much in their enumeration of the species, and in the characters which they assign to them.

M. Desvaux, who has collected all that observers say of the different plantains, of the difference of their fruits and of their uses, thinks that there are 44 varieties in the common species, or *musa paradisiaca* of Linnæus; and three distinct species of this plant, namely, the *musa sapientum*, Lin. the *musa occinea*, pretty common at present in our green-houses, and the *ensete*, described by Bruce in his Journey to the Sources of the Nile.

The fig is a tree, the fruit of which has undergone still greater modifications by culture than the plantain. M. le Marquis de Suffren, who lives in Provence, a country anciently celebrated for the goodness of its figs, perceiving that the cultivators and proprietors are far from knowing all the good varieties, which are suit-

able to each soil and each exposure, and that they do not draw from that precious tree all the advantages which might be obtained, has undertaken to examine and describe with attention the different figs cultivated on the coasts of the Mediterranean, from Genoa to Perpignan. He has already collected coloured figures, and made an exact description, of 172 varieties; and his general review is not yet terminated, as he has not exhausted the whole of Provence, and has not yet visited the coast of Languedoc.

The part of this undertaking which has been communicated to the Class announces a work which will be very useful to our southern departments, especially if the author add the requisite details respecting the leaves and buds, and if he complete the characters by accurate comparisons of the different varieties with each other.

M. Thiebaut de Berneaux, who proposes to give a French translation of the works of Theophrastus, and who, in order to know more accurately the plants of which that celebrated successor of Aristotle has spoken, has planned, and partly executed, journeys into the countries where these vegetables grow, has presented to the Class some of the results which he has already obtained, not only respecting the species indicated by Theophrastus, but likewise respecting those about which there is question in the other Greek and Latin authors.

Thus the *chara*, which the soldiers of Cæsar discovered so happily under the walls of Dyrrachium, and the roots of which preserved them from famine, deserves to be ascertained. At present this name is given to a small aquatic plant, which certainly is not capable of nourishing any person: and respecting the *chara* of Cæsar, there are almost as many opinions as there are botanists who have attended to the subject.

M. de Berneaux, after having examined and eliminated successively all these opinions, suggests one, of which Cluvius alone had some suspicion. He shows that the *chara* must be a species of cabbage, and thinks that it was the plant known at present by the name of *crambe tartaria*. This plant grows abundantly in the environs of Dyrrachium, and in all Hungary and Turkey. Its roots are very long and large, firm, and of a good taste, which are eaten both raw and boiled in all the countries of which we have spoken, and which are of great importance in times of scarcity.

Several Latin authors distinguish by the name of *ulva* different marshy plants; but they distinguish particularly by that name one plant, which furnishes, they say, excellent food for sheep. As among aquatic plants there is scarcely any other than the *festuca fluitans*, which is sought after by sheep; and as this grass covers a great part of the marshes in Italy, M. de Berneaux conceives that it constitutes that peculiar species of *ulva*. He shows that all the passages in which it is mentioned apply very well to the *festuca*. He shows also that this is the grass which Theophrastus and the Greeks distinguished by the name of *typha*.

The ancients boast much of the useful properties of the *cytisus*;

but they describe it only imperfectly; and the moderns have formed different opinions respecting the plant to which the name should be applied. Some have supposed it to be the *medicago arborea*. M. de Berneaux, who has made an elaborate examination of the subject, thinks that it is the *cytisis laburnum*. But as Pliny speaks clearly of this tree under the name of laburnum, and as he considers it as different from the cytisis; and as some parts of the description which Dioscorides gives of the cytisis does not agree with it entirely; it would seem that M. de Berneaux' opinion on this subject is still attended with difficulties. What is always of great importance in such discussions, neither Pliny nor the other ancient naturalists were so accurate that they may not sometimes speak of the same plant under different names, or of different plants under the same name.

M. Dutrochet, a physician at Chateau-Renaud, interesting observations by whom on the egg of the viper we mentioned in 1812, has generalized his researches, and has presented the results to the Class in a memoir on the envelopes of the fœtus. We shall here communicate some of the propositions, remarking that they have not yet been constated by the Institute, because circumstances did not permit them to investigate the subject in the season which would have been suitable for the purpose; yet an extract of this memoir must be gratifying to physiologists, and may occasion new observations on a subject obscure, though interesting.

The author says that he has observed that at first the fœtus enclosed in the egg has an opening at its abdominal walls and its amnios, through which passes an extension of the bladder, which forms the chorion and the middle membrane; so that the umbilical vessels are only a production of those of the bladder. According to him, the egg of reptiles is a vitellus deprived of albumen, and in the viper the membrane of the cock of an extreme thinness disappears about the middle of the gestation, and then the naked chorion contracts adhesions with the oviducts without forming a true placenta. Thus this membrane of the cock would be analogous to the *membrana caduca* of mammiferous animals. He affirms that the tadpole does not throw off its skin in order to undergo a metamorphosis, but that the anterior feet pierce that skin, that the jaws tear it, and the openings cicatrize. The egg of the frog, and of this class of animals in general, is a vitellus, the emulsive matter of which is contained in the intestine itself, which, at first globular, is elongated by degrees in a spiral tube, such as we see it in the tadpole. M. Dutrochet has likewise very particular ideas about the respiration of the fœtus, and particularly about the bronchiæ of tadpoles, which he considers as placed in the cavity of the tympanum. We shall speak of them at greater length when it shall be in our power to verify them, and to throw some light on their nature.

Comparative anatomy had not determined the nature of the respiratory organs of the cloportæ. It was known that these animals



have an analogous structure with crustaceous animals. There was reason to believe that the plates placed under their skin were subservient to their respiration, as they are in the fresh water shrimps, which approach very nearly to the cloportæ. But the fact remained to be established, and an apparatus remained to be shown, either at their surface, or in their interior, proper for this function.

M. Latreille, Correspondent, who has been lately named a member of the Class, has filled up this gap in zoology. He has shown on four of the plates in question a little yellow part, pierced with a hole, and containing within it small filaments, a part which he compares to those which, though differently placed in the spiders and scorpions, have, however, an analogous structure, and fulfil the same function. However, notwithstanding this partial resemblance, and notwithstanding the existence of a sort of spinning apparatus, which he has observed in the cloportæ, and which is analogous to that of the spiders, M. de Latreille still leaves the cloportæ among the crustaceous animals, on account of the much more numerous relations which they have to that class.

The insects have for a long time been divided into two categories, according to the structure of their mouth; one set having jaws well developed, and capable of dividing solid food; and another having only a kind of sucker, fit only to draw in liquids. There are some insects which at different periods of their life have each of these forms of mouth, and which become suckers in their perfect state; though they were bruisers or chewers in their state of larvæ. Such, for example, are the butterflies, which employ for nourishment a double trump, usually in a spiral form, which they unroll to introduce into the bottom of the corolla of flowers, and to suck up the nectar there contained. While the caterpillars, which are merely butterflies not yet developed, have mouths armed with strong mandibles, with which they cut the hardest leaves. It was believed that the caterpillar, on assuming the wings, the long feet, the beautiful antennæ of the butterfly, assumed also its trump, and lost entirely its jaws.

M. Savigny, Member of the Institute of Egypt, has proved by delicate and long continued researches that this is not entirely the case; but that Nature in this circumstance, as in many others, confines herself to diminish certain parts, and to increase others, and that she arrives at effects entirely opposite by this simple change of proportions. He has discovered at the bottom of the trump of butterflies two organs exceedingly small, but which represent the mandibles of the caterpillars. At the back of the support of this same trump he has found two very small threads, which appear to him analogous to the maxillary palpæ; so that the two plates of which the trump is composed are, according to M. Savigny, the extremely elongated points of the maxillæ, that is to say, of the inferior pair of jaws. Finally, the great palpæ known to all naturalists are the palpæ of the inferior lip. The two small maxillary



palpæ had been already observed in some moths; but it is to M. Savigny that we owe the knowledge that they exist in the whole family. This skillful observer has likewise established a marked analogy between the silk and some other small parts which usually accompany the sucker of insects with two wings, and the mandibles and maxillæ of chewing insects; so that the structure of this numerous class of animals offers in this important part of its organization an uniformity more satisfactory than had been hitherto supposed.

M. Savigny has likewise examined the mouth of insects which join to jaws evidently discoverable as such a trump formed by the prolongation of the under lip. The most remarkable of these insects are the bees. It was supposed that the opening of the pharynx was situated below this trump and that lip, while in the ordinary chewers it is situated above. But this was a mistake. The pharynx is always on the base of the trump, and it is even environed with parts interesting to know, and of which M. Savigny has given a description. His memoir is destined for the great work on Egypt, the termination of which we shall soon owe to the generous munificence of the King.

M. Cuvier has examined another class of animals, whose mouth presents likewise, at least in appearance, numerous anomalies; namely, fishes. We find in them at bottom all the parts which belong to the mouth of quadrupeds; but some of them are more subdivided, and a part of their subdivisions are sometimes reduced to so small a size, that they cannot fulfil their functions, and that it is even difficult to perceive them. By far the greater number of fishes have intermaxillaries and maxillaries that are very visible; but these bones differ much from each other in proportion. The maxillaries especially sometimes make a part of the border of the jaw, and carry the teeth; sometimes they are placed more behind, and carry no teeth; from which circumstance ichthyologists have not recognized them for what they are, but have called them mystacea or labial bones. These differences furnish the author with generic characters very convenient for forming a more natural distribution of the species; but they cannot serve to distinguish the orders. For this last object M. Cuvier has recourse to more striking differences, such as the coalition or sector of the maxillaries to the intermaxillaries, which takes place, for example, in the *tetradons*, the *coffres*, the *balistæ*; or the disappearing of the one or the other, and the obligation in which Nature is to employ the palatine bones to form the upper jaw. This we observe in the *ray*, the *shark*, and the other *chondropterigiæ*.

The author was unable to discover other characters than these to establish a first distribution of the class of fishes. In consequence, he places among ordinary fishes the genera which, having the same structure of mouth and bronchiæ, had, however, been placed among cartilaginous fishes, on account of some singularities in their

external form, or because their skeleton hardens a little more slowly than the others. Such are the *centrisques*, the *baudroyes*, the *cyclopteres*, the *lepadogasteres*, &c.

M. Cuvier has founded on these views, and on other similar ones, the peculiar method according to which the fishes will be arranged in the work which he is preparing on comparative anatomy.

The same naturalist has presented to the Class researches on a pretty considerable number of fishes which he has observed in three journeys made at three different times on the coast of the Mediterranean. Some of them are new; some of them had been wrong placed, or wrong named, by authors. Several have offered interesting observations relative to their structure, or occasioned the establishment of new genera, or the subdivision of old genera. These details cannot enter into a report of this kind; but naturalists will find them in the first volume of the Memoirs of the Museum of Natural History, of which a part has already appeared.

### ARTICLE XIII.

#### SCIENTIFIC INTELLIGENCE; AND NOTICES OF SUBJECTS CONNECTED WITH SCIENCE.

##### I. Lectures.

*Medical Theatre, St. Bartholomew's Hospital.*—The following Courses of Lectures will be delivered at this theatre during the ensuing winter:—On the Theory and Practice of Physic; by Dr. Hue.—On Anatomy and Physiology; by Mr. Abernethy.—On the Theory and Practice of Surgery; by Mr. Abernethy.—On Chemistry; by Dr. Hue.—On Midwifery; by Dr. Gooch.—Anatomical Demonstrations; by Mr. Stanley. The Anatomical Lectures will commence on Monday, Oct. 2, at two o'clock.

*Medical School of St. Thomas's and Guy's Hospitals.*—The Autumnal Courses of Lectures at these adjoining Hospitals will commence the beginning of October, viz.:

*At St. Thomas's.*—Anatomy and the Operations of Surgery; by Mr. Astley Cooper and Mr. Henry Cline.—Principles and Practice of Surgery; by Mr. Astley Cooper.

*At Guy's.*—Practice of Medicine; by Dr. Babington and Dr. Curry.—Chemistry; by Dr. Babington, Dr. Marcet, and Mr. Allen.—Experimental Philosophy; by Mr. Allen.—Theory of Medicine, and Materia Medica; by Dr. Curry and Dr. Cholmeley.—Midwifery, and Diseases of Women and Children; by Dr. Haighton.—Physiology, or Laws of the Animal Economy; by Dr. Haighton.—Structure and Diseases of the Teeth; by Mr. Fox.

N. B. These several lectures are so arranged, that no two of them

interfere in the hours of attendance; and the whole is calculated to form a complete Course of Medical and Chirurgical Instruction.

Dr. Clutterbuck will begin his Autumn Course of Lectures on the Theory and Practice of Physic, Materia Medica, and Chemistry, on Wednesday, Oct. 4, at ten o'clock in the morning, at his house, No. 1, in the Crescent, New Bridge-street, Blackfriars.

Dr. Clarke and Mr. Clarke will commence their Lectures on Midwifery, and the Diseases of Women and Children, on Wednesday, Oct. 5. The lectures are read every morning from a quarter past ten to a quarter past eleven, for the convenience of students attending the hospitals.

## II. *New Mode of manufacturing Hemp and Flax.*

About two years ago Mr. Lee took out a patent for obtaining hemp and flax directly from the plants by a new method. He has established a manufactory for the purpose at Old Bow, on the river Lea, near London, where his method, and the result of it, may be seen. I consider Mr. Lee's invention as the greatest improvement ever introduced into the linen business, and as likely to occasion a total change in the whole of our bleach-fields. Hitherto the only way of obtaining hemp and flax has been to steep the plants in water till they begin to rot. They are then exposed for some days to the sun spread out upon the grass, after which the woody part, now become very brittle, is removed by the flax mill, the nature of which is too well known to require any description. By these processes the fibres of the flax are weakened, and a considerable portion of them is altogether destroyed and lost. The flax, too, acquires a greenish yellow colour, and it is well known that a very expensive and tedious bleaching process is necessary to render it white. Mr. Lee neither steeps his flax, nor spreads it on the grass. When the plant is ripe, it is pulled in the usual way. It is then thrashed, by placing it between two grooved wooden beams shod with iron. One of these is fixed; the other is suspended on hinges, and is made to impinge with some force on the fixed beam; the grooves in the one beam corresponding with flutes in the other. By a mechanical contrivance almost exactly similar, the woody matter is beaten off, and the fibres of flax left. By passing these through hackles, varying progressively in fineness, the flax is very speedily dressed, and rendered proper for the use for which it is intended. The advantages of this process are manifold. The expense of steeping and spreading is saved; a much greater produce of flax is obtained; it is much stronger; the fibres may be divided into much finer fibres, so as to obtain at once, and in any quantity, flax fine enough for the manufacture of lace. But the greatest advantage of all remains yet to be stated. Flax manufactured in this manner requires only to be washed in pure water in order to become white. The colouring matter is not chemically combined with the fibre, and therefore is removed at once by water. It is the steeping of the flax and hemp,

which unites the colouring matter with the fibres, and renders the subsequent bleaching process necessary. Thus, by Mr. Lee's process, flax and hemp are obtained in much greater quantity, of much stronger quality, and much finer in the fibre than by the common method, and the necessity of bleaching is altogether superseded. The great importance of such an improvement must be at once obvious to every one.

### III. *Thermometer.*

(To Dr. Thomson.)

MY DEAR SIR,

July 24, 1815.

In consequence of a bill that is coming before the House of Commons for the universal regulation of weights, I beg leave to suggest, through your Journal, my ideas for the regulation of the thermometer and pyrometer, which is so different as to require, when reading off various temperatures, some calculation before you can perfectly understand it; beside the liability of mistake that may arise from quoting different thermometers, as Fahrenheit, Reaumur, &c. My ideas on the subject are for all thermometers to begin with 0, or zero, for water just freezing (as I do not see any reason why it should be called  $32^{\circ}$ ), and continue it down to mercury freezing, and upwards to water boiling, which might be called  $200^{\circ}$ , as there would then be only  $20^{\circ}$  difference between the present nominal temperature of boiling water and the new one; and also to continue it upwards as high as mercury would admit, which, for example, say  $500^{\circ}$ . The pyrometer (Wedgwood's) might then commence by calling the first degree  $1^{\circ}$ , equal to  $501^{\circ}$  of the mercurial. The degrees of temperature would be then understood by the mere number written, without the addition of Fahrenheit or Reaumur, &c. and the higher degrees would, by comparison with the numbers of the lower, be easier, as the equivalent of Fahrenheit to any degree, say  $50^{\circ}$  of Wedgwood, is known to very few. I think it might perhaps be an improvement to make the mercurial thermometers in two scales; that is, one up to  $220^{\circ}$ , or thereabouts, for common purposes; and the other to  $500^{\circ}$ , or any other number that may be thought proper. I merely beg leave to suggest the above ideas, as I am thoroughly aware it must be a matter of courtesy whether the foreign chemists will adopt it, when made, in preference to Reaumur or Celsius; as the great use of the improvement would be materially done away with by their refusing the use of it; and I know no means so likely to bring it into use as coming from you, through the medium of your *Annals of Philosophy*. If you consider the above remarks worthy a place among a number of far more worthy papers, I shall feel myself honoured by your compliance.

I remain, Sir, yours respectfully,  
R. W.

P.S. In a paper which I sent you some time since, I promised some experiments with regard to the nature of bees, wasps, and

hornets, which I have not yet had time to complete, except with respect to hornets. Their cells I have every reason to suppose are composed of a single layer or division only; for as they are made of large pieces (about the size of a pin's head) of rotten wood, the same pieces may be seen on both sides of the cell; which refutes Dr. Barclay's ideas of their being composed of two layers stuck together by an animal glue.

The different graduation of thermometers in various countries is certainly an inconvenience; but, like the different weights and measures, it is an inconvenience hardly capable of being remedied. Fahrenheit was the first person who employed mercury in thermometers, and who made them accurately corresponding with each other. His two fixed points were, the temperature of boiling water, and the temperature produced by mixing together snow and sal-ammoniac. He conceived the mercury to be divided into 11,124 parts when surrounded with snow and sal-ammoniac. When put into boiling water, he found that it expanded so much as to be equal to  $11,124 + 212$  parts. On that account he divided the interval between the two points into 212 parts or degrees. He marked the lowest 0, and the other 212; so that the degrees of Fahrenheit denote not only the temperature, but the expansion, of mercury from his zero to the point indicated. Thus  $32^{\circ}$  is the freezing point of water, and  $\frac{32}{11124}$  is the expansion which the mercury undergoes when heated from 0 to  $32^{\circ}$ . This indication of the expansion is an advantage which no other thermometrical scale possesses; and ought, I think, to induce us to pause before we resolve to lay it aside. The decimal scale wants this advantage, though it possesses some others of considerable importance. De Luc informs us, in his *Recherches sur les Modifications de l'Atmosphere* (t. i. p. 343), that what is at present called the centigrade thermometer was in common use in London when he wrote. His book was published in 1772. If this was the case, it would be curious to know what induced the British philosophers to abandon it. I cannot find that any such thermometer is employed by the writers in the *Philosophical Transactions*.

The only possible means of changing our thermometer would be to persuade the makers to alter the graduation. If both the centigrade and Fahrenheit divisions were marked on the scale, I think it would be an improvement.

#### IV. *Chemical Nomenclature.*

(To Dr. Thomson.)

SIR,

As a philosophical journalist, you are in some degree invested with the character of arbiter of technical nomenclature; and as chemists are indebted to you for the introduction of the useful terms *protoxide*, &c. you may do some good by protesting against the introduction of similar terms leading to confusion instead of perspicuity. I mean *prosulphate*, *prochloride*, &c. Surely writers need not be

so sparing of their pens as to omit the short syllable which would give the word its true meaning: *proto* is intelligible: the other may be taken for the Latin word *pro*. In another respect, however, the term is objectionable; for even if written *protosulphate*, it would seem to denote a subsulphate, though it is meant to stand for sulphate of protoxide. A regular use of the modern self-explanatory nomenclature is extremely useful: a careless use of it renders the terms worse than arbitrary.

Are you aware that the word *complement* has sometimes the word *compliment* substituted for it in the *Annals*: also the word *radicle*, for *radical*? It would puzzle a botanist to find *radicle* applied to muriatic acid; though *radical*, an adjective, used substantively, would at once be understood to mean the radical base.

Your obedient servant,

SPECULATOR.

If my Correspondent pay the requisite attention to the present fondness for *new words*, by which chemists and mineralogists in general are actuated, he will speedily be convinced that any remonstrance on my part would have little effect in stemming the current. The terms *prosulphate*, *persulphate*, &c. do not strike me as so objectionable as they do my Correspondent. It is now well known that in a great variety of cases more than one oxide of the same metal is capable of combining with acids. Thus both the black and the red oxide of iron combine with sulphuric acid. It is necessary to distinguish each of these salts by a name; and no mode seems simpler or more natural than to prefix to the old name of the salt the first syllable of the respective names of the oxides. If the black oxide of iron be called *protoxide*, then the combination of it with sulphuric acid may be known, without ambiguity, by taking its first syllable *pro* and prefixing it to sulphate of iron. *Prosulphate of iron* means a compound of sulphuric acid and *protoxide of iron*. *Protosulphate of iron* I think more objectionable, because *proto* is not the first syllable of the word *protoxide*. In like manner, the *persulphate of iron* means a combination of sulphuric acid with the *peroxide* or *red oxide* of iron. When various proportions of an acid combine with a base, it is now known that these proportions follow a very simple law. If we suppose the quantity of base fixed, then the quantities of acid in the super salts are multiples of the quantity in the neutral salt; namely, double or quadruple. Thus in *sulphate of potash*, if we denote the base by  $a$ , and the acid by  $b$ , the composition of supersulphate of potash will be  $a + 2b$ . What is called subcarbonate of potash is composed of  $a + b$  ( $a$  being the base,  $b$  the acid), and the crystallized carbonate of  $a + 2b$ . Hence we have a simple mode of distinguishing these salts. Let the salt composed of  $a + b$  be simply designated by the old name, as sulphate of potash, carbonate of potash: let the salt composed of  $a + 2b$  be distinguished by prefixing the syllable *his*, or *bi*, or *bin*; thus *bisulphate*, *bicarbonate*, *binoxalate*. By using Latin terms for such



combinations, while Greek terms are employed for the combinations of the different oxides, all ambiguity is avoided. Both these modes of naming I have employed in the tables of the salts published in the preceding numbers of the *Annals of Philosophy*.

#### V. Howard's Nomenclature of Clouds.

The same Correspondent suggests the necessity of giving an explanation of the terms employed by Mr. Howard in his *Meteorological Journal* to denote the various modifications of the clouds. I beg leave to inform him that this has been done already. He will find it in the *Annals of Philosophy*, vol. i. p. 80.

For an explanation of the term *polarization*, which he also requests, I refer him to the *Annals*, vol. i. p. 302, where he will find one already given.

#### VI. New Amalgam of Mercury.

I lately received the following piece of information in a letter from M. Van Mons:—

“ M. Dobereiner decomposed water in contact with mercury by means of the galvanic battery. Oxygen was evolved at the positive pole, but no hydrogen from the negative pole. Instead of it there was formed a solid amalgam of mercury, not decomposed by agitation; but, when heated, resolved into running mercury and hydrogen gas. M. Dobereiner considers hydrogen gas as a metal dissolved in caloric, and constantly in a state of expansion. The absence of caloric, and the nascent state of the hydrogen, enable it in the above experiment to amalgamate with mercury.

“ M. Dobereiner has likewise made sulphur undergo considerable changes, having obtained it in the form of a blue powder, similar to ultramarine, by depriving it of its hydrogen by means of a process which he does not describe. Phosphorus changes into a scaly matter, having the brilliancy and colour of gold when burnt under a glass while exposed to the direct rays of the sun.”

#### VII. New Galvanic Experiment.

(To Dr. Thomson.)

SIR,

The following experiment on animal galvanism to me is perfectly new; if it should be so to you, perhaps you will give it a place in your *Journal*. At present I shall merely state the experiment, though the importance I attach to it arises solely from the theory by which it was suggested. After trying every experiment mentioned in most systems of animal galvanism, I made a pile of thin slices of brain and muscle, which by a single piece of metal produced the most violent agitation in the frog, inconceivably greater than any other usually exhibited. It even produced a slight effect without any metal; but I have never been able to succeed in any of Aldini's experiments without metal, as he asserts.

I am, Sir, yours most respectfully,

Edinburgh, July 20, 1815.

M. A.



## VIII. Farther Queries respecting Gas Lights.

(To Dr. Thomson.)

DEAR SIR,

Yours and Mr. Accum's reply to my queries respecting the method of producing illumination by gas, instead of lamps or candles, are very satisfactory. I possess his new treatise on the subject; but I do not find any directions for choosing pipes of a diameter suitable to produce a given effect. He gives no rule concerning the diameters; nor does he give sufficient directions concerning the lime used for purifying the gas. I hope he will be so obliging as to supply these deficiencies through the medium of your *Annals*, stating at the same time the places where pipes, &c. may be purchased on the terms mentioned in his book. Mr. Accum being a chemist, I conclude he does not supply apparatus of this magnitude. Is it Mr. A.'s opinion that lighting a private house in the country by coal gas would be less expensive than by candles or oil?

Your obliged,

A. M——к.

July 17, 1815.

## IX. Crystals of Arragonite.

It is well known that the crystalline form of the arragonite is different from that of calcareous spar. M. Stromeyer, after discovering the presence of carbonate of strontian in that mineral, conceived that the arragonite derived its crystalline forms from carbonate of strontian. But as carbonate of strontian had never been found in regular crystals, that conjecture could not be verified. Gehlen has lately announced that he and Professor Fuchs observed, among specimens of barytes from Salzburgh, crystals of carbonate of strontian having exactly the same form as those of arragonite (Schweigger's Journal, xi. 392); so that there seems to be no doubt that the crystalline figures of carbonate of strontian and of arragonite are the same. But this coincidence of form does not appear to me to clear up the difficulty. That one part of carbonate of strontian should oblige 50 or 100 parts of carbonate of lime to assume its own form of crystal appears quite inexplicable. If the shape of the crystal depends upon that of the integrant particles of the crystallizing body, the crystallization should either be confused when two different sets of integrant particles crystallize together, or they must combine and form a new integrant particle: 99 parts of carbonate of lime mixed with one part of carbonate of strontian ought, one should think, to assume the crystalline form of carbonate of lime. The *gres des Fontainblois*, which has been considered as similar, is not even analogous. In it we have crystals of calcareous spar mixed with grains of sand; but in the present case both bodies must have been in a liquid state, and both are capable of crystallizing.

### X. *Combustion of Carbureted Hydrogen Gas.*

I have been requested to explain why the steel-mills, as they are called (which consist of a piece of steel rubbing against a kind of grind-stone, and emitting a prodigious number of sparks,) do not set fire to a mixture of carbureted hydrogen gas and common air. It is not easy to assign a very satisfactory reason. The heat of the sparks is certainly sufficient for the purpose; for if you collect them you find them in globules that have undergone fusion. Now the black oxide of iron will not melt, except at a much higher temperature than is sufficient to set fire to such a mixture. I never was able to burn a mixture of carbureted hydrogen gas and common air by passing electric sparks through it; but if you bring a red-hot bar of iron in contact with the mixture, it fires immediately. These facts induce me to suspect that the effect depends upon the size of the ignited body. A very small spark is probably not capable of impelling a sufficient number of particles of oxygen against a particle of carbureted hydrogen to produce instant combination, which I conceive occasions the combustion. Sometimes it is well known that the mixture is exploded by the steel-mills. In such cases, I conceive, the sparks are uncommonly large.

### XI. *Another Accident at a Coal-Mine near Newcastle.*

On Monday, the 31st of July, another melancholy accident happened at Messrs. Nesham and Co.'s colliery, at Newbottle, in the county of Durham. The proprietors had provided a powerful locomotive steam-engine, for the purpose of drawing 10 or 12 coal-waggons to the staith at one time; and Monday being the day it was to be put in motion, a great number of persons belonging to the colliery had collected to see it; but unfortunately, just as it was going off, the boiler of the machine burst. The engine-man was dashed to pieces, and his mangled remains blown 114 yards; the top of the boiler (nine feet square, weight 19 cwt.) was blown 100 yards; and the two cylinders 90 yards. A little boy was also thrown to a great distance. By this accident 57 persons were killed and wounded, of whom 11 were dead on Sunday night, and several remain dangerously ill. The cause of the accident is accounted for as follows: the engine-man said, "as there were several owners and viewers there, he would make her (the engine) go in grand stile," and he had got upon the boiler to loose the screw of the safety valve, but being overheated, it unfortunately exploded. It will be recollected, that at the fatal blast which recently took place at this colliery, the first who arrived at the bank, holding by a rope, was a little boy, about six or seven years of age. The poor little fellow is among the number dead.

### XII. *Carbonate of Bismuth.*

A new species of ore has been lately discovered in Cornwall, the

carbonate of bismuth. From a very small specimen of it, which I have seen, I am led to suspect that it is the same mineral called by the Germans *bismuth ochre*. The colour, fracture, and lustre, are similar: The specific gravity is less, being only 3.0755; but the fragment examined was much mixed with clay.

### XIII. *Carbo-Sulphuret of Mercury.*

Dobereiner has lately announced that there exists a native compound of mercury and sulphuret of carbon. He calls it *quecksilbererz (ore of mercury)*. I should not be surprised if this were the common ore of Idria, called *quecksilber-lebererz (hepatic ore of mercury)*; for Klaproth found this ore to contain both sulphur and carbon, nearly in the proportion in which they exist in sulphuret of carbon. Dobereiner says, that when the ore is distilled, sulphuret of carbon is obtained. He informs us that sulphuret of carbon unites with all the metals, and forms a new class of bodies.

## ARTICLE XIV.

### *List of Patents.*

WILLIAM BELL, Birmingham; for a method of making and manufacturing wire of every description. April 18, 1815.

MICHAEL BILLINGSLEY, Bowling Iron Works, Yorkshire; for improvements in the steam-engine. April 20, 1815.

SAMUEL JOHN PAULEY, Charing Cross, London; and DURS EGG, Strand, gun manufacturer; for certain aerial conveyances and vessels to be steered by philosophical, or chemical, or mechanical means, and which means are also applicable to the propelling of vessels through water, and carriages or other conveyances by land. April 25, 1815.

JACOB WILSON, Welbeck-street, London, cabinet-maker and upholsterer; for certain improvements in bedsteads and furniture. April 27, 1815.

WILLIAM BUSH, Saffron Walden, Essex, surveyor and builder; for a method of preventing accidents from horses falling with two-wheeled carriages, especially on steep declivities, superior to any hitherto known or in use. April 29, 1815.

PETER MARTINEAU, Canonbury House, Islington, and JOHN MARTINEAU, Stamford Hill; for their new method or methods of refining and clarifying certain vegetable substances. May 8, 1815.

JOHN JAMES ALEXANDER MACCARTHY, Arlington-street, London, sculptor; for a method of paving, pitching, or covering, streets, roads, and ways. May 11, 1815.

CHARLES PITT, Strand, London; for his method or methods for the security and safe conveyance of small parcels, and remittances

of property of every description, and also for the security in the formation or appendage of shoes. May 11, 1815.

SAMUEL PRATT, No. 119, Holborn-hill, London, trunk-maker; for a wardrobe trunk for travellers. May 11, 1815.

ARCHIBALD KENRICK, West Bromwich, Stafford, founder; for certain improvements in the mills for grinding coffee, malt, and other articles. May 23, 1815.

JOHN PUGH, of Over, Whitegate, Chester, salt proprietor; for a new method of making salt-pans upon an improved principle, to save fuel and labour. May 26, 1815.

JONATHAN RIDGWAY, Manchester, plumber; for a new method of pumping water and other fluids. May 26, 1815.

JOHN KILBY, York, brewer; for his improvement or improvements in the art of brewing malt liquors. June 1, 1815.

## ARTICLE XV.

### *Scientific Books in hand, or in the Press.*

The New Edition of Dr. Henry's Elements of Chemistry, with very considerable Additions and Improvements, will be ready on the 1st of October.

The Rev. P. Keith, F.L.S. is about to publish a System of Physiological Botany, in 2 vols. 8vo. with Plates drawn and engraved by Mr. Sowerby.

Mrs. Bryan is printing A Compendious Astronomical and Geographical Class Book, for the Use of Families and Young Persons.

Mr. Rootsey is about to publish a Volume, entitled The Bristol Dispensatory, the object of which is to establish the Nomenclature of Pharmacy upon a permanent basis: and to explain the advantages of a new method of expressing the Composition of Medicine.

Sir F. C. Morgan, Physician, is preparing for the Press, Outlines of the Philosophy of Life: which has for its object the diffusion of a more general knowledge of the fundamental facts of philosophy.

Arthur Burraw, Esq. is preparing for the Press, Some Account of the Mediterranean, 1810 to 1815, Political and Scientific, Literary and Descriptive. The work will appear in Royal 4to with Engravings, and the first Volume will be chiefly confined to Sicily.

Mr. Accum has in the Press a Second Edition [Stereotype] of his Practical Treatise on Gas Light; Exhibiting a Summary Description of the Apparatus and Machinery best calculated for illuminating Streets, Houses, and Manufactories with Coal Gas, &c. With Remarks on the Utility, Safety, and general Nature of this new Branch of Civil Economy. Illustrated with Seven Coloured Plates showing the Construction of the large Apparatus employed for illuminating the Streets and Houses of this Metropolis, as well as the Smaller Apparatus employed by Manufacturers and Private Individuals.

## ARTICLE XVI.

## METEOROLOGICAL TABLE.

1815.	Wind.	BAROMETER.			THERMOMETER.			Evap.	Rain.
		Max.	Min.	Med.	Max.	Min.	Med.		
6th Mo.									
June 29	S W	30·17	30·11	30·140	77	46	61·5		C
30	N W	30·11	30·02	30·065	77	53	55·0		
7th Mo.									
July 1	N E	30·03	30·02	30·025	75	49	62·0		
2	N E	30·03	29·92	29·975	71	49	60·0		
3	W	29·92	29·85	29·885	67	46	56·5		
4	N	29·96	29·85	29·905	72	42	57·0		—
5	Var.	29·98	29·92	29·950	70	52	61·0		
6	Var.	29·88	29·86	29·870	70	50	60·0		·10 O
7	N E	30·00	29·88	29·940	64	42	53·0		—
8	N W	30·00	29·96	29·980	69	54	62·5		1
9	N W	30·04	30·00	30·020	70	52	61·0		
10	N W	30·05	30·04	30·045	75	51	63·0		
11	E	30·05	29·99	30·020	75	48	61·5		
12	S W	29·99	29·93	29·960	79	49	64·0	·62	
13	S W	29·97	29·87	29·920	77	57	67·0		— D
14	S W	29·97	29·92	29·945	79	61	70·0		—
15	S W	29·88	29·85	29·865	77	57	67·0		—
16	W	29·95	29·84	29·895	75	55	65·0		—
17	W	29·84	29·70	29·770	80	54	67·0		—
18	S W	29·70	29·62	29·660	75	49	62·0		—
19	N W	29·65	29·47	29·560	68	52	60·0		·69
20	N W	29·82	29·65	29·735	65	49	57·0	·70	·31
21	N W	30·00	29·97	29·985	68	47	57·5		— ●
22	N E	30·00	29·98	29·990	68	52	60·0		
23	N W	30·04	29·98	30·010	68	53	60·5		6
24	N W	30·13	30·04	30·085	69	56	62·5		—
25	N W	30·13	30·13	30·130	71	52	61·5		·21
26	N W	30·18	30·13	30·155					—
27	N W	30·19	30·18	30·185	66	42	54·0		—
28	N W	30·18	30·17	30·175	74	47	60·5	·68	
		30·19	29·47	29·961	80	42	61·36	2·00	1·38

The observations in each line of the table apply to a period of twenty-four hours, beginning at 9 A. M. on the day indicated in the first column. A dash denotes, that the result is included in the next following observation.

## REMARKS.

*Sixth Month.*—29. A very fine day: the western sky in the twilight, bright orange near the horizon, with a purple glow above. 30. Cloudy morning: after which sunshine at intervals.

*Seventh Month.*—1. Heavy *Cumulostrati*, p. m. 2. Windy, cloudy, a. m.: *Cirrus*, passing to *Cirrocumulus*, &c. p. m.: a luminous twilight, the clouds much coloured. 3. a. m. Windy, with *Cumulostratus*. 4. Cloudy: a few drops, p. m. 5. *Cumulostratus*, formed by *Cirrocumulus*. 6. The wind passed this morning by S. E. to S. W. but settled at N. W. with various clouds: rain fell in the night. 7. Wet this morning early, and windy at N. E.: p. m. fair, with *Cumulostratus*. 8. *Cumulus*, a. m. with *Cirrostratus*: cloudy evening: some rain by night. 9. *Cumulostratus*: orange twilight. 11. A very fine day: pink-coloured *Cirri* at sun-set. 12. Sultry: a. m. *Cumulostratus* by inoculation. About noon, an appearance of distant rain in the N. E., which continued till evening: the whole of our own clouds gradually disappeared, with a steady S. W. breeze. At sun-set it was clear, and somewhat orange-coloured to N. W., but obscure, with *Cirrostratus* to N. E. 13. Large ill-defined *Cirri*, with nascent *Cumuli*, and afterwards *Cirrocumulus*, at a great height, passed to the N. E. with a fresh breeze: a little rain fell in the evening. Hygr. about 40° these three mornings past. 14. Various clouds, threatening rain at intervals, which followed p. m. in quantity scarcely sufficient to lay the dust: windy. 15. a. m. *Cumulus*, beneath *Cirrostratus*: windy: some light showers, and a trace of the rainbow, at sun-set. 16. A slight shower, a. m. 17. Various clouds, a. m.: a few drops, p. m.: at evening, a tendency to the rapid formation of *Cirrostratus*, the denser clouds at the same time exhibiting a beautiful gradation of colours: twilight orange. 18. In the morning, an extensive sheet of flimsy *Cirrocumulus*, which soon moved away. Hygr. at 9 a. m. 68°. About 10 p. m. the same kind of cloud: a low murky sky. 19. A steady rain, a. m. Hygr. 70° at 9 p. m. 20. Overcast, with *Cumulostratus*: windy. 21—26. Mostly cloudy: occasional showers. 27, 28. Fine.

## RESULTS.

Prevailing Winds Westerly, and these for the most part N. W.

Barometer: Greatest height..... 30·19 inches.  
Least ..... 29·47  
Mean of the period ..... 29·961

Thermometer: Greatest height..... 80°  
Least ..... 42  
Mean of the period..... 61·36

Evaporation, (in 23 days, from the 6th inclusive,)..... 2 inches.

Rain..... 1·38 inch.

\* \* \* The observations from the 21st inclusive are those of my friend John Gibson, at the Laboratory.

ANNALS  
OF  
PHILOSOPHY.

---

---

OCTOBER, 1815.

---

---

ARTICLE I.

*Observations on the Absorption of the Gases by different Bodies.*  
By Theodore de Saussure.\*

WE possess at present no accurate experiments on the question, whether a gas, when it penetrates into the pores of a solid body, undergoes any diminution of bulk in consequence of this penetration, even when no chemical union takes place between the gas and the solid body? It is, for example, still unknown whether azotic or oxygen gas, which do not combine chemically with silica, undergo a diminution of their bulk when they penetrate into a porous silicious stone, as opal, hydrophane, or even sand-stone. If we allow that such diminution of bulk takes place, a number of other questions immediately present themselves. What influence has the size of the pores on this condensation? Are all gases equally condensed by the same bodies? And what influence has the density of the gas on this condensation? These inquiries become still more interesting when different gases are employed together. When two gases mixed equally are presented to a solid body, does it absorb them in equal quantities or not? And do the mixed gases, when condensed in solid bodies, enter into combinations which they would not form in a free state? It is obvious that such investigations may lead us to discover whether our atmosphere, when it penetrates into the interior of earthy bodies, becomes condensed merely in conse-

\* I have translated this important paper from Gilbert's *Annalen der Physik*, vol. xlvi. p. 112, July, 1814. The original was read in the Geneva Society on the 16th of April, 1812. But I do not know where it was first published. Gilbert informs us that it was translated into German by Professor Horner, of Zurich.—T.



quence of this penetration, and forms water, and nitrous or ammoniacal salts.

The experiments which I have made in order to answer some of these questions I shall arrange in three sections. The first section contains my experiments on the condensation of pure unmixed gases by solid bodies; the second, my experiments on the absorption of mixed gases by solid bodies; in the third, I shall state some observations on the absorption of gases by liquids.

### SECTION FIRST.

#### ABSORPTION OF UNMIXED GASES BY SOLID BODIES.

##### 1. *Amount of the Condensation of different Gases by Charcoal.*

Of all solid bodies, charcoal is the most remarkable in its action on the gases. It was a discovery of Fontana that red-hot charcoal, cooled by plunging it under mercury, or by any other method which precludes the contact of the air, possesses the remarkable property of absorbing more than its own volume of various gases. Count Morozzo remarked that this absorption is different according to the different gases and to the kind of charcoal used; and he made experiments which, when properly repeated, place this truth in a clear point of view. He allowed various gases, in exactly the same circumstances, to be absorbed by charcoal and other porous bodies, as pumice, brick, &c. It appeared to him that the gases absorbed by these last bodies underwent no condensation. Hence the condensation produced by charcoal was considered as a peculiar action of that body, the full clearing up of which was left to future naturalists.

Morozzo, Rouppe, and Norden, employed various methods in their experiments to cool charcoal without plunging it under mercury; but the unavoidable introduction of atmospherical air was injurious to the accuracy of their trials. It was in their power, indeed, to try the absorption of gases by charcoal over water; but the presence of water, as I shall show hereafter, diminished the condensation of the gases, and introduced some inaccuracies into their experiments.

In my experiments the red-hot charcoal was plunged under mercury, and introduced into the gas to be absorbed after it was cool, without ever coming in contact with atmospherical air. All my experiments were made with the charcoal of box-wood. Its powers of absorbing are not only very remarkable, but it absorbs so little mercury during the cooling that it still readily swims on water.

The following experiments were made between the temperatures of  $52^{\circ}$  and  $56^{\circ}$ , and under a barometrical pressure of  $28\frac{1}{2}$  inches of mercury. The numbers are almost always means of several experiments; for two pieces of the very same charcoal introduced into the same gas seldom give the same absorption. The numbers refer to the volume of the charcoal, which is considered as unity.

## Charcoal of box-wood absorbs, of

	Volumes.
Ammoniacal gas .....	90
Muriatic acid .....	85
Sulphurous acid .....	65
Sulphureted hydrogen .....	55
Nitrous oxide .....	40
Carbonic acid .....	35
Olefiant gas .....	35
Carbonic oxide .....	9.42
Oxygen .....	9.25
Azote .....	7.5
Oxy-carbureted hydrogen* .....	5
Hydrogen .....	1.75

Box-wood charcoal absorbs 38 times its volume of nitrous acid gas; but as a portion of this gas is decomposed, the result cannot be compared with those contained in the preceding table.

In all these gases the absorption terminated at the end of 24 or 36 hours, so that it was not increased by allowing the charcoal to remain longer in contact with the gas. Oxygen gas alone constitutes an exception to this general rule; for its absorption seems to continue for several years. The reason is, that a small quantity of carbonic acid is always forming, of which charcoal absorbs a much greater quantity than it does of oxygen gas. This formation goes on so slowly at the common temperature of the air, that several years elapse before as much carbonic acid gas is generated as is sufficient to saturate the charcoal. I shall state below, in a note, the facts which led me to this conclusion.† It is exceedingly pro-

\* I obtained the *oxy-carbureted hydrogen*, which I employed in all my experiments, by distilling moist charcoal. Its specific gravity, after separating the carbonic acid, was 0.3326, that of air being 1. 100 measures of this gas require for combustion 60.78 measures of oxygen gas, and form 31.5 measures of carbonic acid gas. Hence its composition is as follows:

Carbon .....	39.52
Oxygen .....	28.95
Hydrogen .....	16.90
Azote.....	14.63
	100.00

† On the Formation of Carbonic Acid Gas at the common Temperature from Charcoal and Oxygen.

It has hitherto been supposed that charcoal only unites with oxygen at a temperature not much below a red heat; but I think that I have remarked that the common temperature of the air is sufficient for this union. As this observation is important, and may be contradicted, it will be permitted to me, I presume, to state more particularly the nature of my observations.

A volume of box-wood charcoal quenched in mercury that in 24 hours had absorbed 9½ volumes of dry oxygen gas, was left for 18 months in the same gas standing over mercury. In two months the absorption was 11 volumes; in 14 months it was 13 volumes. It always became slower as the time advanced, and was not completed in 18 months. I put an end to the experiment in order to

bable that the true absorption of oxygen gas, like that of the other gases, is completed in 36 hours; that this absorption amounts to  $9\frac{1}{4}$  volumes; and that during that time no perceptible quantity of carbonic acid gas is formed. On this account, in the subsequent details into which I shall enter I shall take no farther notice of this formation of carbonic acid gas.

## *2. Influence of Water on the Absorption of Gases by Box-wood Charcoal.*

The results above stated suppose and require that the charcoal before and during its action on the gases be dry. If the charcoal, after being cooled under mercury, be moistened with water, the absorption of all those gases that have not a very strong affinity for water is distinctly diminished.\*

Box-wood charcoal cooled under mercury, and drenched in water while still under mercury, is only capable of absorbing 15 volumes of carbonic acid gas; although, before being moistened, it could absorb 35 volumes of the same gas. The moistened charcoal likewise takes a longer time to complete its absorption than the dry charcoal. Thus charcoal that when dry absorbs 35 volumes of carbonic acid gas in 24 hours, requires when moistened with water 14 days in order to absorb 15 volumes.

The effect of moistening charcoal upon its power of absorbing gases becomes more striking when we allow dry charcoal in the first place to saturate itself with a gas, and then bring it through mercury into a jar filled with mercury, and containing a quantity of water about equal to the bulk of the charcoal. In 48 hours the

examine the residual gas. I found it as pure as before the introduction of the charcoal, and containing no traces of carbonic acid gas. It is, however, probable that carbonic acid gas had been formed, and that it was contained in the pores of the charcoal. It is likely that the diminution would have gone on till the absorption of gas amounted to 35 volumes, as that is the quantity of carbonic acid gas absorbed by dry charcoal; and that, after this, free carbonic acid gas would have been formed. But as 20 years might have elapsed before a notable quantity of carbonic acid appeared, when the experiment was conducted in this way, I shortened the process, by introducing moist charcoal instead of dry. The consequence was, that in about a year part of the surrounding oxygen gas was changed into carbonic acid gas at the common temperature of the atmosphere. We shall see hereafter that one volume of box-wood charcoal quenched in water absorbs only 15 volumes of carbonic acid instead of the 35 which are absorbed by one volume of dry charcoal. A volume of wet box-wood charcoal put into oxygen gas standing over mercury diminished the volume of the gas for 10 months, and still the diminution amounted to 15 volumes, and during this time no carbonic acid could be detected in the residual gas. But after the absorption ceased, carbonic acid began to appear, and in four months amounted to half a volume. The charcoal itself being plunged into lime-water rendered it very milky. I thought I detected a trace of carbureted hydrogen gas likewise in the residual gas, but am not quite sure, as the quantity was so small as to be within the limits of error in the experiments.

\* At least with regard to charcoal, which has the property of absorbing a great deal of gas. With regard to some other bodies which have the property of absorbing but little gas, their power of absorbing gas is rather increased by moistening them with water.

charcoal gives out all the gas which wet charcoal is not able to retain.\*

In the same manner one volume of dry charcoal, which had absorbed 33 volumes of carbonic acid gas, when it was drenched in water, gave out 17 volumes of this gas, and of course retained only 16 volumes. This is nearly the same proportion as in the first experiment. A volume of dry box-wood charcoal, which had absorbed  $7\frac{1}{2}$  volumes of azotic gas, when drenched in water gave out  $6\frac{1}{2}$  volumes, and of course retained only one volume of this gas. A volume of dry box-wood charcoal, which had absorbed  $9\frac{1}{4}$  volumes of oxygen gas, gave out when put into water  $3\frac{1}{4}$  volumes; † and one volume of charcoal saturated with hydrogen gas retained, after being put into water, only 0.65 of a volume of this gas. We shall endeavour hereafter to employ these results.

If charcoal which has already given out its excess of gas by being placed in contact with water, be put into a retort filled with water, and exposed to a boiling heat, a considerable quantity of fresh gas separates from it; but this temperature is not sufficient to drive off the whole of the gas which it had absorbed.

The gas driven out by water, though it had remained for several days in the charcoal, did not appear in the least altered in its properties. In oxygen gas I observed no carbonic acid, no carbureted hydrogen gas in hydrogen gas, nor carbonic oxide in carbonic acid gas. The gases were always contaminated with a small quantity of azotic gas, which probably had previously existed in the red-hot charcoal. Oxygen gas alone, as I have already observed, when charcoal remained in it for some months, contained a small mixture of carbonic acid gas: a process which was still farther promoted by the presence of water.

### 3. *Heat which is disengaged by the Condensation of the Gases by Charcoal.*

When box-wood charcoal, or any other species which rapidly absorbs gases cooled in mercury, is introduced into any gas, there is evolved during the condensation of the gas a quantity of heat often sensible to the feeling, and sufficient to raise a thermometer whose

\* The water, by penetrating into the charcoal, drives out the gas with such force, that in close vessels, and when a sufficient quantity of charcoal is employed, the expelled gas is in a state of compression. This circumstance may be employed in a great scale in the preparation of very concentrated artificial soda-water, especially when fermenting tuns are at hand. We have only to place within these basins filled with red-hot box-wood charcoal, and when the charcoal is saturated with the gas it is to be put into thick and strong vessels, and brought in contact with water. We must take care that the charcoal does not come in contact with the atmospheric air, nor must it be mixed with the water till the vessels are made air-tight. I have myself, without attending to these necessary precautions, and at the temperature of  $66^{\circ}$ , prepared in a vessel, a fourth part of which was filled with box-wood charcoal, and two-thirds of it with water, and which I rendered air-tight, a soda-water which contained more than its own bulk of carbonic acid gas.

† La Metherie obtained a similar result when employed in these experiments. See *Journal de Physique*, vol. xxx.

bulb is in contact with about  $\frac{1}{4}$  of a cubic inch of charcoal several degrees. The heat, as might have been expected, appears to increase with the absorbability of the gas. Charcoal becomes hotter in ammoniacal than in carbonic acid gas, and hotter in this gas than in the less absorbable oxygen gas. Hydrogen gas, which is the least absorbable of all, gives out so little heat, that the methods which I employed were not sufficiently delicate to detect any. \* This evolution of heat depends much more upon the rapidity with which the absorption takes place than upon the degree of the condensation; since, according to Gay-Lussac's experiments, different gases when equally compressed give out different quantities of heat.

#### 4. *Influence of the barometrical Pressure on the Condensation of Gases by Charcoal.*

Hitherto heat only has been employed to render charcoal fit for absorbing gas. I have tried to produce the same effect by means of the air-pump, and have obtained nearly the same results.

A piece of box-wood charcoal, which had stood exposed to the air for some days, was put into a receiver fixed to a small portable plate by means of tallow, and screwed upon the plate of the air-pump, so as to be air-tight. † The air being pumped out of the receiver and charcoal by an exhaustion amounting to 0.16 inch of mercury, the transferrer with its receiver is brought into the mercurial trough, and the cock of the transferrer being opened under the mercury, that liquid flows in and fills the receiver, and the transferrer may now be removed. The charcoal is now, without coming in contact with the external air, introduced into another receiver filled with carbonic acid. The absorption at the temperature of  $53\frac{1}{2}^{\circ}$  amounted to  $31\frac{1}{2}$  volumes. Charcoal heated red-hot produces in the same circumstances an absorption amounting to 35 volumes.

I repeated the same experiment with oxygen gas. The absorption produced in this way amounted to  $8\frac{1}{3}$  volumes of the charcoal, while charcoal heated to redness absorbed  $9\frac{1}{4}$  volumes. Charcoal freed of air by the air-pump absorbed seven volumes of azotic gas in place of  $7\frac{1}{2}$  volumes which charcoal heated to redness absorbed.

As the charcoal which was employed in these experiments had

\* The bulb of my thermometer was  $2\frac{1}{2}$  lines in diameter. The tube was bent in the form of a V. † The end on which was the bulb was introduced through the mercury into the receiver. The outer arm held the scale; and served both to hold the instrument and to bring the bulb in contact with the charcoal.

† Instead of this transferrer, the following method may be employed. A small receiver containing the charcoal is tied by strings to a dish which is filled with mercury, and placed under the common receiver of the air-pump. When the air has been pumped out of the large receiver, and likewise out of the small, a communication is opened between the inside of the large receiver and the external air. The mercury in the dish is now forced into the small receiver, and fills it. The string is now untied, and the small receiver standing on the dish is conveyed to the mercurial trough. But the exhaustion produced in this way is not quite so great as in the other, on account of the resistance made by the mercury in the dish to the escape of the air from the small receiver.

absorbed some moisture from the air, which might prove injurious to the absorption, I repeated them with charcoal, which, after being dried in a red heat, was introduced into a glass receiver full of common air standing over mercury. In this case the absorption of the charcoal was somewhat greater than before; but it always remained smaller than when charcoal was used that had been heated to redness, obviously on account of the air left behind in the charcoal by the incomplete vacuum produced by the air-pump.

To ascertain what influence the density of a gas has upon the volume which charcoal is capable of absorbing, I introduced a piece of charcoal, which had been saturated with gas under the common pressure of the atmosphere into a torricellian vacuum in the top of a barometer tube, the inner diameter of which was 0.78 inch. As soon as the charcoal came into the vacuum, it allowed a portion of its gas to escape, which caused the barometer to fall a great way, from which the density of the gas set free was easily deduced. From the bulk of the portion of the tube occupied by this gas, and this bulk subtracted from the whole volume which the gas absorbed by the charcoal would occupy in this new situation, it was easy to determine the quantity of gas still remaining in the charcoal. I wished to make these experiments also under other pressures of the atmosphere; and on that account allowed determinate quantities of gas to enter into the barometer tube.

*Exper. 1.*—A piece of box-wood charcoal, which under the barometrical pressure of 28.91 inches, and in the temperature of  $65^{\circ}$ , had absorbed  $34\frac{1}{2}$  volumes of carbonic acid gas, was put into an atmosphere of carbonic acid gas, the density of which, after the separation of the gas from the charcoal, was equivalent to the pressure of 10.26 inches of mercury. Under this pressure the  $34\frac{1}{2}$  volumes of gas, supposing them completely extricated from the charcoal, would have occupied the bulk of 97.21 volumes. Of these 28.16 volumes had escaped out of the charcoal. It still retained 69.05 volumes. Hence it follows that charcoal absorbs a greater bulk of rarified carbonic acid than when it is of its usual density.

*Exper. 2.*—I left the charcoal in the barometer tube, and increased the density till it equalled the pressure of 15.9 inches of mercury. At this density the  $34\frac{1}{2}$  volumes of gas amounted to 62.74 volumes. Of these 12.83 volumes had escaped; so that the charcoal still retained 49.91 volumes.

I made several other experiments, which gave me similar results. It follows from the whole that the absorption of gases, if it be estimated by the volume, is far greater in a rare than in a dense atmosphere; but if we reckon this absorption by the weight, it is more considerable in the latter than in the former state of the atmosphere. These observations, however, apply only to those gases that are absorbed in considerable quantities. The difference is scarcely perceptible when the absorption amounts only to about one volume.

When these experiments shall have been prosecuted, it is pro-

bable that the relation between the absorption of the gases, and the height of the barometer, will be discovered. I have not prosecuted the subject; nor have I made any trials upon the change produced in the absorption by equal increments of temperature.

The same cause, which makes the charcoal become hot when it absorbs gas, must produce a diminution of temperature on the separation of this gas. A cylinder of box-wood charcoal, 3·15 inches long, and 1·57 inch in diameter, was, with a thermometer fixed in it, placed in a very small receiver; and then its air was driven off by means of the air-pump, that it might be saturated with carbonic acid gas. When I afterwards separated this gas from the charcoal by means of the air-pump, the thermometer fell in a few minutes 7·2°.\* The same experiment was repeated with common air: the thermometer fell from 5° to 7°.

5. *The Property of condensing Gases is common to all Bodies which possess a certain degree of porosity.*

That the property of absorbing gases has hitherto been observed only in charcoal is owing partly to experiments having been made with no other substance of the requisite texture, and partly to no accurate observations on the absorption having been made. I have found no body which possesses the property in so high a degree as charcoal.

In all the experiments which I have made on this subject, I have made use of the air-pump to free the porous bodies from atmospheric air, and to make them capable of absorbing gases. The method of heating to redness succeeds well only with charcoal, because, on account of its combustibility and its small specific heat, it may be taken out of the fire and plunged under mercury while still white hot. The other porous bodies, which are not combustible, suffer on that account, when they are small, very various degrees of cooling during their passage from the fire to the mercury, which have a sensible effect upon their power of absorbing gases. Besides, the air-pump put it in my power to employ animal and vegetable substances, which are totally destroyed in the fire.

*Exper. 1. Absorption of Gases by Spanish Meerschaum.†—As*

\* By the absorption of carbonic acid gas by charcoal freed from air, the temperature was raised 25°.

† The variety of meerschaum employed came from Valecas, near Madrid. The specific gravity, porosity, and proportion of water contained in it, vary in different specimens. The piece which I used lost 0·23 of its weight in a red heat. Its specific gravity, ascertained by plunging it in mercury, which did not penetrate into the pores, was 0·826. Meerschaum from Natolia, according to Klaproth, is composed of

Silica .....	50·50
Magnesia .....	17·25
Water .....	25·00
Carbonic acid .....	5·00
Lime .....	0·50
Loss .....	1·75



this stone, even when it seems perfectly dry, always contains some water, I put it first into the fire, and then introduced it under the air-pump while still warm. Having freed it from its air, I introduced it first into ammoniacal gas, and ascertained how much of this gas it absorbed. This experiment I repeated with the same piece of meerschaum for each of the other gases, first putting it into the fire, then introducing it under the air-pump, and lastly putting it into the gas to be absorbed; so that the same piece of meerschaum was brought successively in contact with all the gases. The size of the meerschaum was  $2\frac{1}{2}$  cubic inches; and this size made it possible for me to observe small variations in the absorption. A repetition of these experiments, the same way, and with the same piece of meerschaum, gave similar results. The following table exhibits the mean of these two sets of experiments, giving the number of volumes of each gas absorbed by one volume of the meerschaum at the temperature of  $59^{\circ}$ , and under a pressure of 28.74 inches of mercury.

	Volumes.
Ammoniacal gas * .....	15
Sulphureted hydrogen .....	11.7
Carbonic acid gas † .....	5.26
Nitrous oxide .....	3.75
Olefiant gas .....	3.7
Azotic gas .....	1.6
Oxygen gas .....	1.49
Carbonic oxide .....	1.17
Oxy-carbureted hydrogen .....	0.85
Hydrogen .....	0.44

As these absorptions were produced and destroyed by means of the air-pump alone, without the help of fire, this is a proof that the gases contract no union with the stone, which is equivalent to the atmospherical pressure. Besides, in these experiments, as in those with charcoal, no alterations in the temperature or barometrical took place.

I repeated these experiments with another piece of meerschaum from Valecas. It produced a smaller absorption. When dried in the air, it absorbed three volumes, and when heated to redness only  $2\frac{1}{2}$  volumes, of carbonic acid gas.

Meerschaum, like charcoal, absorbs a greater bulk of rare than dense gas. Thus a mass of meerschaum of the bulk 13.37 absorbed,

\* When the meerschaum is employed as dry as it can be procured in the common temperature of the atmosphere, but without being heated red-hot, it absorbs 15 volumes of ammoniacal gas, but requires to do that several days. On the contrary, when it has been heated to redness, the absorption is completed in five or six hours. Charcoal gives a similar result. It follows from my experiments that a very small proportion of water greatly increases the power of meerschaum to absorb carbonic acid gas, but a great proportion of water diminishes that power. The absorption of carbonic acid gas is always slower when the meerschaum contains water than when it is dry.

† When the meerschaum was not heated to redness, the absorption of carbonic acid gas amounted to 13 volumes.

under a pressure of 28·46 inches of mercury, only 42·5 of carbonic acid gas; but when the pressure was reduced to 9·37 inches, the absorption amounted to 50·5.

*Exper. 2. Absorption of Gases by the adhesive Slate of Menilmontant.\**—I did not introduce this mineral into the fire, because it splits, and contracts itself so much as not afterwards to absorb a sensible quantity of most of the gases. A volume of adhesive slate, freed from air by means of the air-pump, absorbed, at the temperature of 59°, the following proportions of the different gases:—

	Volumes.
Ammoniacal gas .....	11·3
Carbonic acid .....	2
Olefiant .....	1·5
Azotic .....	0·7
Oxygen .....	0·7
Carbonic oxide .....	0·55
Oxy-carbureted hydrogen .....	0·55
Hydrogen .....	0·48

These absorptions are still smaller than those by meerschaum, and the differences in most of the gases so small that they cannot be accurately estimated. Besides, I must remark that when two gases in these experiments appear to be equally absorbed by a solid body, this does not entitle us to conclude that they have been absorbed by it with equal force. It is much more rational to ascribe the equality to the insufficiency of the experiments, which, had they been made on a larger scale, would probably have shown some difference.

*Exper. 3, with ligniform Asbestos from the Tyrol and Rock Cork.*—The ligniform asbestos which I employed resembled splinters of nut-wood, and had a specific gravity of 1·42. When heated to redness, it lost 0·19 of its weight. The rock cork was white, of the specific gravity 0·6; and when heated to redness lost 1¼ per cent. of its weight. Both minerals were dried by exposure to a red heat; they were then deprived of air by the air-pump, and at the temperature of 59° absorbed the following proportions of gas:—

	Ligniform Asbestos.	Rock Cork.
	Volumes.	Volumes.
Ammoniacal gas .....	12·75	2·3
Carbonic acid .....	1·7	0·82
Olefiant .....	1·7	0·82
Carbonic oxide .....	0·58	0·78
Azotic .....	0·47	0·68

\* The specific gravity of this stone is 0·95. It is composed, according to Klaproth, of

Silica .....	62·5
Magnesia .....	8·0
Oxide of iron .....	4·0
Water .....	22·0

with some atoms of alumina, lime, and carbon.

	Ligniform Asbestos.		Rock Cork.
	Volumes.		Volumes.
Oxygen .....	0·47	.....	0·68
Oxy-carbureted hydrogen	0·41	.....	0·68
Hydrogen .....	0·31	.....	0·68

It is worthy of attention that rock cork, though much more spongy, shows a smaller difference in the proportion of the different gases absorbed. Amianthus squeezed forcibly together exhibited no sensible difference in its absorption.

*Exper. 4, with Saxon Hydrophane,\* and Quartz from Vauvert.†*—The Saxon hydrophane was dried in the open air, the quartz from Vauvert by exposure to a red heat. A volume of each of them freed from air by the air-pump absorbed the following proportions of gases:—

	Hydrophane.		Quartz.
	Volumes.		Volumes.
Ammoniacal gas .....	64	.....	10
Muriatic acid .....	17	.....	
Sulphurous acid .....	7·37	.....	
Carbonic acid .....	1	.....	0·6
Olefiant .....	0·8	.....	0·6
Azotic .....	0·6	.....	0·45
Oxygen .....	0·6	.....	0·45
Hydrogen .....	0·4	.....	0·37

The swimming quartz from St. Ouen, of the specific gravity 0·468, gave, when treated in the same way, no perceptible difference in its absorptions.

*Exper. 5, with Sulphate of Lime.*—It was in the state of calcined gypsum, hardened by water, and dried in the open air. Its specific gravity was 0·96. One volume of it freed from air absorbed the following quantities of gases:—

	Volume.
Oxygen gas .....	0·58
Azotic .....	0·53
Hydrogen .....	0·50
Carbonic acid .....	0·43

*Exper. 6, with swimming Carbonate of Lime, or Agaric Mine-*

\* According to Klaproth, Saxon hydrophane is composed of

Silica .....	93
Alumina .....	1·6
Water .....	5·25

The specific gravity of my specimen was 1·7, and its volume 0·2 cubic inch French. Hence the observations could not be very precise. The stone splits in a red heat; therefore it was not put into the fire.

† This quartz is found in rolled flints at Vauvert, near Nimes, and appears to be pure quartz coloured red by oxide of iron. It is at times so light as to swim in water. The specific gravity of my specimen was 1·18. 100 parts of it lost in the fire 3·35 parts.

*ral.\**—A volume of this mineral dried in the air absorbed the following proportions of gases:—

Carbonic acid gas .....	0·87
Azotic .....	0 80
Hydrogen .....	0·80
Oxygen .....	0·67

*Exper. 7, with different Kinds of Woods.*—The wood was dried in the open air, and then small pieces of it were kept for several weeks in large flasks containing muriate of lime. Yet some hygrometrical water remained in it, which became evident when the wood freed from air was introduced into ammoniacal gas, a watery vapour spreading itself during the absorption, which the heat disengaged during the process forced out. The same appearances took place when *adhesive slate, linen, wool, and silk*, were exposed to the same treatment. All these bodies again absorbed the vapour. The linen threads were firmly pressed together in bundles of the specific gravity 0·78. One volume of the following substances absorbed the following proportions of the different gases:—

	Hazel.	Mulberry.	Fir.	Linen Thread.
Ammoniacal gas .....	100	88	—	68
Carbonic acid .....	1·1	0·46	1·1	0·62
Olefiant .....	0·71	—	—	0·48
Oxy-carbureted hydrogen...	0·58	—	—	0·35
Hydrogen .....	0·58	0·46	0·75	0·35
Carbonic oxide .....	0·58	—	—	0·35
Oxygen .....	0·47	0·34	0·50	0·35
Azotic .....	0·21	0·18	0 21	0·33

*Exper. 8, with raw Silk and with Wool.*—The specific gravity of the skein of silk was 0·731, of the wool 0·6. Before the experiments both were dried over muriate of lime. The temperature was as in the preceding experiments. One volume of each absorbed the following proportions of the different gases:—

	Wool. Volumes.	Silk. Volumes.
Ammoniacal gas .....		78
Carbonic acid gas .....	1·7	1·1
Olefiant .....	0·57	0·5
Oxygen .....	0·43	0·44
Carbonic oxide .....	0·3	0·3
Hydrogen .....	0·3	0·3
Azotic .....	0·24	0·125

\* This very light variety of chalk is found on Jura, and has only the specific gravity 0·465. 100 parts of it dissolve completely in nitric acid, and give out 35 parts of carbonic acid gas, which amounts to 83 parts of carbonate of lime. The remaining 17 parts are chiefly water; which always exist in a greater or smaller proportion in all stones possessed of a certain degree of porosity.

All the bodies with which these experiments were made, excepting charcoal and hydrophane, from the way in which I treated them before the absorption of the gases, imbibed a good deal of mercury. No attention was paid to this, as it appears that the volumes absorbed of the little absorbable gases are smaller than the size of the pores of the absorbing bodies.

6. *Influence of the Affinity and Elasticity of the Gases, and of the Porosity of the solid Bodies on the Absorption.*

The rate of absorption of different gases appears to be the same in all bodies of similar chemical properties. All the varieties of asbestos condense more carbonic acid gas than oxygen gas; woods condense more hydrogen than azote. But the condensations themselves in different kinds of asbestos, or wood, or charcoal, are very far from being equal. Ligniform asbestos absorbs a greater volume of carbonic acid gas than rock cork; so does hydrophane than the swimming quartz of St. Ouen and the quartz of Vauvert; and the absorption of gases by box-wood charcoal is much greater than by fir charcoal. These differences are not in the least altered if, instead of equal volumes, equal weights of charcoal be employed.

Count Morozzo thinks he has observed that the most combustible charcoal, and that which is most proper for the preparation of gunpowder, possesses the smallest power of absorbing gases; and conceives that this may be owing to a chemical difference in the composition of charcoals. But as the analysis of charcoals of very different absorbing powers shows always the same constituents, this explanation must be renounced; and we must rather ascribe the cause of this difference to the physical state of the charcoal, as, for example, to the number and size of the pores which it contains.

To be able to determine the influence which the porosity or the state of aggregation of solid bodies has upon their power of absorbing gases, I compared with each other the quantities which the same piece of box-wood charcoal absorbed when whole, and when reduced to an impalpable powder. The piece of charcoal weighed 2.94 grammes (45.4 grains troy), and had a volume of 4.92 cubic centimetres (0.3 cubic inch English), and absorbed, when freed from air by the air-pump, 35½ cubic centimetres (2.731 cubic inches), or about 7½ times its volume of atmospherical air. It was now rubbed to an impalpable powder, and put into a glass tube, both the ends of which were shut up with gauze. In this state its weight was the same as before; but its volume was 7.3 cubic centimetres (0.445 cubic inch); and when freed from air by the air-pump, it absorbed only 20.8 cubic centimetres (1.355 cubic inch) of atmospherical air. Thus it absorbed about three times its volume in a pulverized state, and about 7½ times its volume when whole: so that by destroying, opening, and widening, the small cells of the

charcoal, its power of absorbing is distinctly weakened. The condensation of gases in solid bodies appears to us to be an analogous result with the rise of liquids in capillary tubes. Both are in the inverse ratio of the size of the interior diameters of the tubes or pores.

The absorbing power of most kinds of charcoal increases as the specific gravity increases; and it is obvious that this last must become greater in proportion as the pores become smaller and narrower. Charcoal from cork, of a specific gravity not exceeding 0.1, absorbed no sensible quantity of atmospherical air. Charcoal from fir, of the specific gravity 0.4, absorbed  $4\frac{1}{2}$  times its volume of atmospherical air. Box-wood charcoal, of the specific gravity 0.6, absorbed  $7\frac{1}{2}$  times its bulk of air; and pit coal from Russiberg, which was of vegetable origin, and of the specific gravity 1.326, absorbed  $10\frac{1}{2}$  times its volume of air. If we were to go on trying coals of always greater specific gravities, we should soon come to a limit when the pores would be too small to allow gases to enter: then all absorption would cease, though the specific gravity increased. Thus the *black lead* from Cumberland, which contains 0.96 of carbon, and may therefore be considered as a coal, though its specific gravity is 2.17, produces no alteration on atmospherical air. The same was the case with a coal of nearly the same weight: which I obtained by distilling volatile oil through a red-hot porcelain tube.

But this correspondence of the power of absorbing with the specific gravity is only accidental. More accurate experiments show remarkable deviations from this rule. The different kinds of charcoal, whether of similar or dissimilar specific gravities, always differ from each other in their organization. They cannot be considered as resembling a sponge, whose pores and density may be modified by pressure.

I expected to be able to render those bodies capable of absorbing air, which, like the black lead of Cumberland, are too dense, and have too few pores, to allow a passage for gases, by reducing them to a fine powder. But my expectations were disappointed. The pores, formed by reducing a solid body to powder, appear to be too light, too open, and in too small quantity, to be able to condense a sensible quantity of carbonic acid, azote, oxygen, or hydrogen. But they seem to act upon elastic fluids, which lose their elasticity by a small increase of pressure; for I know no body which in the state of a fine powder is not capable of absorbing moisture from the atmosphere; as is shown by the loss of weight which all powders capable of standing the action of fire undergo when heated.

From the experiments hitherto made, it appears that the power which the gases possess of being condensed in solid bodies is within certain limits in the inverse ratio of the internal diameter of the pores of the absorbing bodies.

But, besides the porosity, there are two other circumstances

which must be attended to in these absorptions: 1. The different affinities which exist between the bases of the gases and the absorbing bodies; and 2. The power of expansion of the gases, or the opposition which they make to their condensation in different degrees of heat and atmospherical pressure.

We find an example of the action of this affinity in the different orders in which the gases are absorbed by different bodies. Charcoal and meerschaum absorb more azotic than hydrogen gas; wood, on the other hand, more hydrogen than azotic gas. The influence of elasticity shows itself in this, that the condensation of the gases is not always proportional to the affinity of their bases to the absorbing bodies. Thus carbonic acid gas is absorbed in greater quantity by charcoal than oxygen gas, although the affinity of oxygen saturated with carbon to charcoal can only be weak. To the elastic fluids, absorbed most copiously by porous bodies, belong for the most part those which, by a known diminution of temperature, or increase of pressure, lose their gaseous state. Thus the vapour of water is absorbed in great abundance by all porous bodies capable of absorbing gases. *Ammoniacal gas* is always absorbed in greatest abundance; and the *vapour of sulphuric ether*, which is absorbed in great quantity, by charcoal, meerschaum, ligniform asbestos, and all bodies which have the property of absorbing gases.

When the gases have a greater inclination to retain their elastic state than to unite with porous bodies, the difference of the affinities between their bases and these bodies does not appear. This takes place in all cases when the condensation does not correspond with the known affinity. On the contrary, when the affinity of the bases of the gases for the porous bodies surpasses or destroys their elasticity, the absorption corresponds with the known affinity.

From these observations it follows, that the condensation of gases by porous bodies, abstracting from the influence of the pores, depends upon two powers: 1. The attraction, by means of which the bases of the gases and the porous bodies endeavour to unite together: and 2. The elasticity of the gases, or the affinity of their bases to heat. These two powers oppose one another; and the absorption of the gases by solid bodies is the result of their difference. These two powers have long ago been considered by Berthollet, who showed that the elasticity of the gases is a power which opposes their chemical combinations. I have here merely applied the doctrine of this celebrated chemist to the object which I had in view.

(To be continued.)



## ARTICLE II.

*An Analysis of the Mineral Waters of Dunblane and Pitcaithly; with General Observations on the Analysis of Mineral Waters, and the Composition of Bath Water, &c.* By John Murray, M. D. F. R. S. E.

(Read to the Royal Society of Edinburgh, Nov. 20, 1814.)

I PROPOSE to submit to the Society the analysis of a mineral water of the saline class, which has lately been discovered in the neighbourhood of Dunblane. The subject may have rather more interest than usually belongs to researches of this nature, from the composition of this water being such as promises to afford a spring of considerable medicinal efficacy, and from its resemblance to another mineral water of some celebrity—that of Pitcaithly, the analysis of which I have, from this circumstance, been also led to undertake. The investigation, too, may afford some illustrations of the different methods that may be employed in the analysis of waters of this class, and of the facility and precision which are given to these researches, by the results that have been established with regard to the definite proportions in which many bodies combine, and the uniformity of the relations which thus exist between the compounds they form. And it has led to some views with regard to the constitution of mineral waters of the saline class, which I have applied to the composition of some of the most celebrated mineral waters. In performing the principal experiments on the Dunblane water, I had the advantage of Mr. Ellis's co-operation.

## I.—ANALYSIS OF THE DUNBLANE WATER.

This water was discovered last summer, and was first taken notice of from the circumstance of the frequent resort of flocks of pigeons to the ground where it breaks out. It appears in two springs, at the distance of nearly half a mile from each other, in a field about two miles to the north of Dunblane, the property of the Earl of Kinnoul. This district is at no great distance from the range of the Grampians, to which it ascends; masses of the primitive rocks are spread over the surface, and are found in the beds of the streams; among which the conglomerate rock that seems to skirt the Grampians is abundant. The prevailing rock of the district itself is the red sand-stone, and it is generally covered by a bed of gravel, in many places of considerable depth. It is from this sand-stone that the water appears to issue. The spring, however, in both the places where it breaks out, has been laid open only to the depth of two or three feet from the surface, and has not been traced to any extent. Its proper source is therefore unknown, and it also remains uncer-

tain how far it may be diluted with water from the surface, or from other springs. The water from the lower, or what for distinction may be named the south spring, is weaker in taste than the water of the north spring; and from the subsequent experiments is proved to contain rather less foreign matter. The ingredients, however, are the same; and the difference therefore probably arises from the water of the lower spring being farther diluted in its course. This difference led to the analysis of the water of both springs. It is proper to remark, that both have been submitted to examination after a season unusually dry.

*Analysis of the Water of the North Spring.*

The taste of this water is saline, with some degree of bitterness. As procured from the principal pool at which it issues, it is free from smell; procured, however, from some other pools, at the distance only of a few feet, its smell is slightly sulphureous, probably owing to impregnation from matter at or immediately under the soil. Its sensible operation on the system is that of a diuretic and purgative. The former effect is usually obtained when a quantity is taken by an adult, from an English pint to a quart; the latter, when more than a quart is taken. The specific gravity of the water is 1.00475. It suffers no change in its sensible qualities from exposure to the air.

The state of the spring is at present such, that any gaseous impregnation of the water cannot be determined with precision. Bubbles of air frequently rise from the bottom of the pool, but this is merely atmospheric air: transmitted through lime-water, it produced no sensible milkiness; nor does the water appear to contain any free carbonic acid.

The usual re-agents present with the water the following appearances:—

1. The colours of litmus, violet, and turmeric, are not sensibly affected.

2. Muriate of barytes produces an immediate turbidness, and rather copious precipitation, which is very slightly, if at all, removed by nitric acid.

3. Nitrate of silver gives a very dense and abundant precipitate.

4. Water of potash produces a turbid appearance, not very considerable.

5. Carbonate of potash throws down an abundant precipitate, which disappears with effervescence on adding nitric acid.

6. Lime-water causes no change.

7. Ammonia does not cause any precipitation, nor does it even impair the transparency of the water.

8. Oxalate of potash, or of ammonia, occasions a copious precipitation.

9. Tincture of galls has no immediate sensible effect; but after an hour or two a purplish tint is exhibited, which deepens from exposure to the air, and inclines to olive-green.

These results establish the following conclusions:—

Exper. 1, proves that no free acid or alkaline matter is present, nor any alkaline carbonate.

Exper. 2, denotes the presence of sulphuric acid.

Exper. 3, indicates the presence of muriatic acid.

From Exper. 4 and 5, may be inferred the presence either of lime, or magnesia, or both.

Exper. 6 and 7, prove that magnesia is not present, nor argil.

Exper. 8, proves the presence of lime.

Exper. 9, indicates a minute portion of iron.

The saline taste of the water, and the precipitation so abundant by nitrate of silver, render probable the presence of muriate of soda, and it is accordingly obtained, when the water is evaporated nearly to dryness, cubical crystals of it forming in the saline liquid.

From the whole, therefore, the principal ingredients of this water may be inferred to be muriates of soda and lime, with a smaller portion of a sulphate, and a minute quantity of iron. These conclusions suggested the following method of analysis.

An English pint of the water was evaporated to dryness; and the solid residuum was exposed to a heat approaching to redness, until it became perfectly dry. It weighed while warm 47 grains. It quickly attracted moisture from the air, so that its surface soon became humid; and on leaving it exposed for 24 hours, a considerable portion was dissolved, forming a dense liquor, while a portion remained undissolved.

The whole solid matter, being rendered dry, was submitted to the action of alcohol, with the view of separating by solution the muriates of soda and lime, of which it was supposed to be principally composed. It is well known that this method is liable, in some degree, to two sources of error; the one, that a little muriate of soda is dissolved by the alcohol with the muriate of lime; the other, that even when a large quantity of alcohol is employed, the undissolved muriate of soda retains a small portion of muriate of lime. In estimating the quantities from the results, these errors, indeed, in some measure counterbalance each other; but still they may exist in different degrees, according to the quantity and strength of the alcohol, and it is necessary therefore to obtain perfect precision, to obviate them as far as possible.

With this view the entire matter was digested with repeated portions of alcohol, of the specific gravity of 836, until about six times its weight had been employed; the solvent action being aided by frequent agitation, and an occasional heat of about 100°. It was then lixiviated with a small portion of distilled water, to remove more effectually from the muriate of soda any adhering muriate of lime. The different liquors, being mixed, were evaporated to dryness; and this dry mass was again submitted to the action of alcohol, more highly rectified, (being of the specific gravity of 825,) and in smaller quantity, so as to dissolve only that part of it which was muriate of lime. A small portion of muriate of soda,

which had been dissolved in the first digestion, was thus obtained, and was added to the residue of that operation. The whole undissolved matter being dried at a low red heat, weighed while warm 28·5 grains: it was in small grains, having a taste purely saline. The alcoholic solution afforded, by evaporation, a matter which entered into fusion, and which, after being dried at a heat approaching to redness, weighed while warm 18·2 grains. It was highly deliquescent, so as to increase quickly in weight, and in a short time became humid on the surface.

These two products were evidently principally muriate of soda and muriate of lime. But it was necessary to ascertain if they were entirely so, as both of them might contain small portions of other ingredients.

The matter dissolved by the alcohol, supposing it to be muriate of lime, would require for its conversion into sulphate of lime about 16 grains of sulphuric acid of the usual strength: 18 grains were added with a small portion of distilled water, and heat was applied; vapours of muriatic acid were discharged: to render the mutual action more complete, small portions of water were successively added, the soft mass being frequently stirred; and when the vapours had ceased to exhale, the heat was raised to redness, to expel any excess of acid. The dry matter weighed 22 grains, precisely the quantity that ought to be obtained from 18 grains of muriate of lime.

It was diffused in a quantity of water, which it at first absorbed with a hissing noise. The water, after having been added in successive quantities, with frequent agitation, being poured off, the undissolved matter was dried at a low red heat: it weighed 18·5 grains, and formed a soft white powder, free from taste. The water poured off was very slightly acidulous. This was neutralized by ammonia; it was then evaporated to dryness, and the solid matter was heated to redness. On again submitting it to the action of a small quantity of water, a portion remained undissolved, which weighed when dried 2 grains.

There were thus obtained 20·5 grains of sulphate of lime, a quantity equivalent to 16·7 of dry muriate of lime. The small portion of liquor which remained in the last operation had a bitterish taste: by spontaneous evaporation, it formed acicular crystals; diluted with distilled water, it became slightly turbid on adding oxalate of ammonia, and more so on the addition of alcohol; but in the latter case, the transparency was restored on adding water. With a minute portion, therefore, of sulphate of lime, it appeared to be principally sulphate of soda, derived from a little muriate of soda, which, notwithstanding the precautions that were employed, had adhered to the muriate of lime.

The matter which remained undissolved by the alcohol weighed, it has been stated, 28·5 grains. It remained to ascertain if it were entirely muriate of soda.

Being agitated with about half an ounce of distilled water, the

greater part was dissolved. The portion which remained undissolved, after being washed with small quantities of distilled water, and dried, weighed 2·4 grains. To this matter a little diluted nitric acid being added, a slight effervescence was excited: a thin crust, too, adhered to the sides of the small glass globe in which the last stage of the evaporation had been performed, which was dissolved with effervescence by a weak acid. The quantity of *carbonate of lime* thus indicated may be estimated at 0·5 grain. The remainder of the undissolved residue being washed and dried, was heated with two or three drops of sulphuric acid, and was thus rendered soluble in water. When neutralized by ammonia, the solution became milky; but its transparency was restored by adding more water; it became quite turbid on adding oxalate of potash, and a precipitate was thrown down by alcohol. It was therefore *sulphate of lime*. Its quantity may be stated at two grains.

The solution had a taste purely saline. The test of oxalate of ammonia, however, showed the presence in it of a small quantity of lime; the addition of the oxalate was therefore continued as long as any precipitation took place, and the precipitate was collected and dried. It weighed 1·3 grain. This production of oxalate of lime evidently arose from the presence of a small portion of muriate of lime, which, notwithstanding the precautions that had been employed, had adhered to the muriate of soda. Supposing that this had not escaped the action of the alcohol, but had been dissolved by it, and in the subsequent stage of the experiment, been converted into sulphate of lime, it would have increased the quantity of this sulphate about 1·2 grain, making it therefore 21·7, equivalent to 17·6 grains of dry *muriate of lime*, which the pint of water contains.

The solution contained also a minute quantity of sulphuric acid; for after removing any slight excess of oxalic acid that might have been present, it still gave a precipitate on the addition of muriate of barytes. Supposing this, as well as the rest of the sulphuric acid, to have existed in the water in the state of sulphate of lime, it will increase the quantity of that ingredient (calculating from the weight of the precipitate of sulphate of barytes obtained), from the two grains formerly noticed to 2·9.

There appeared now to remain nothing but pure muriate of soda. The solution by slow evaporation afforded that salt in cubical crystals, which, dried at a low red heat, weighed 24·5 grains. Allowing 0·8 of this as the portion of product formed by the action of the muriate of barytes, it leaves 23·7 grains. And if to this be added one grain, as the equivalent of the small portion of sulphate of soda, already noticed as formed by the action of the sulphuric acid on the muriate of soda adhering to the muriate of lime after the operation of the alcohol, it gives the quantity of muriate of soda at 24·7 grains.

From these results, the solid ingredients in a pint of this water appear to be,

	Grains.
Muriate of soda .....	24·7
Muriate of lime .....	17·6
Sulphate of lime .....	2·9
Carbonate of lime .....	0·5
With a trace of iron.	—
	45·7

Having completed the analysis in this manner, I wished to confirm it by a different method. A very simple one presented itself—to reduce by evaporation to dryness—obtain the sulphate of lime as before—then, dissolving the mixed mass of muriate of lime and muriate of soda in water, decompose the muriate of lime by oxalate of ammonia, so as to find the quantity of it present, and after evaporation to volatilize the muriate of ammonia by heat, and thus obtain the muriate of soda. The results in this mode ought to correspond with those in the former; and the one, therefore, afford a confirmation of the other, or lead to the discovery of any fallacy if it exist.

A pint of the water was evaporated to dryness, and afforded, as before, 47 grains of solid matter. This being submitted to the action of a small quantity of distilled water, was dissolved, with the exception of a residue of sulphate of lime, which weighed 2·6 grains, and a little carbonate of lime, which may be estimated, as before, at 0·5 grain.

To the clear solution a solution of oxalate of ammonia was added as long as any turbid appearance was produced; and after the precipitate had subsided, the liquor was heated nearly to boiling, to render the mutual action and the precipitation more perfect. The precipitate being repeatedly washed with distilled water, was dried by the heat of a sand-bath raised gradually, and kept lower than a red heat. It weighed 21 gr. The quantity of muriate of lime which would be equivalent to this cannot be inferred with certainty from any previous analysis of oxalate of lime; for as the oxalate cannot be exposed to a red heat without decomposition, it cannot easily be subjected to a precise degree of heat, by which we can be certain of obtaining it in an uniform state of dryness.\* It is necessary, therefore, that in every case the quantity of lime should be found in the oxalate that is operated on. The above quantity of 21 grains was converted by calcination into carbonate of lime; and this being decomposed by muriatic acid, the quantity of muriate of lime obtained, dried at a low red heat, and weighed while warm, amounted to 18·3 grains.

The liquor poured off from the precipitate was evaporated to dryness; and to expel the muriate of ammonia formed by the action

\* Referring to those analyses which may be supposed to be most accurate, 21 grains of oxalate of lime will be found equivalent to various proportions, from 17·5 to 19·9 of muriate of lime.

of the oxalate of ammonia on the muriate of lime, the heat was continued while any vapours were disengaged, and at the end was raised nearly to redness. The dry mass weighed, while warm, 25 grains. Being dissolved in water, its solution was rendered very slightly turbid by the addition of muriate of barytes, showing the presence of a minute portion of sulphuric acid. A quantity of precipitate was collected, which, when dried, weighed 0·8 grain. Supposing the sulphuric acid of this to have originally existed in the water; along with the other portion of this acid, in the state of sulphate of lime, it gives a proportion of that sulphate of 0·5 grain, and of course increases the quantity of it from the 2·6 grains obtained by evaporation to 3·1 grains. An equivalent quantity must at the same time be subtracted from the proportion of muriate of lime, which may therefore be reduced to 18 grains. By evaporation of the liquor, muriate of soda was obtained, weighing, when it had been dried at a low red heat, 24·3 grains. Of this a small portion (0·4) would be formed by the muriate of barytes, which requires to be deducted; but then the sulphuric acid which existed in the mass, could, after the action of the oxalate of ammonia, and the exposure to a red heat, exist in it only in the state of sulphate of soda, in the production of which an equivalent portion of muriate of soda would be decomposed. The quantity of muriate of soda obtained, therefore, by the evaporation, may be regarded as the just proportion indicated by the analysis.

The results, then, by this method, agree very nearly with those by the other; being of solid ingredients in a pint of the water,

	Grains.
Muriate of soda .....	24·3
Muriate of lime .....	18
Sulphate of lime .....	3·1
Carbonate of lime .....	0·5
With a trace of iron.	<hr style="width: 100px; margin: 0 auto;"/> 45·9

With regard to both analyses, a small correction is to be made in the proportion of sulphate of lime. The mode of ascertaining it, by evaporation, being rather imperfect, I afterwards determined it by the more accurate method of precipitation by muriate of barytes; applying this re-agent with a slight excess of acid, so as to prevent any precipitation of carbonate. The quantity of precipitate thrown down from a pint of the water amounted, after drying at a low red heat, to 6·1 grains, equivalent to 3·5 grains of sulphate of lime. As the portion of sulphate of lime thus obtained above that obtained by the evaporation would remain principally mixed with the muriate of soda, the quantity of that ingredient falls to be reduced a little, and may therefore be stated at 24 grains.

It remained to ascertain the proportion of iron. The quantity, however, was evidently so small as to present a difficulty. Succinate



of ammonia and benzoate of soda produced little or no effect on the water in its natural state. Infusion of galls produced, after some hours, a dark colour, and a precipitate very slowly subsided. This method has been employed to ascertain minute quantities of iron, and I endeavoured to avail myself of it—adding to the water infusion of galls, in small successive portions, at the interval of a day or two, as long as the colour appeared to be rendered deeper; leaving it exposed to the air for a longer time, that the whole matter rendered insoluble might subside; and, lastly, washing the precipitate, drying and calcining it, to consume the vegetable matter, and obtain the oxide of iron. The difficulty, however, attending this method, is that of precipitating entirely the iron, the liquor never becoming colourless. In one experiment, conducted with much care, the quantity of the calcined product from two pints amounted to 0·4 grain; but it consisted partly of carbonate of lime. To remove this, pure muriatic acid diluted was added in excess, and a moderate heat was applied; the precipitate was entirely dissolved, and the liquor acquired a deep yellow colour. Being further diluted, a little pure ammonia was added to it, in a close phial, to precipitate the oxide of iron, while the lime should remain dissolved. The quantity thus obtained, when dried, amounted to 0·27 grain.

This method being liable to the above objection, I employed another: two pints of the water were evaporated: when reduced to about two ounces, a brownish-coloured sediment was deposited, which was removed; the evaporation was carried to dryness, and the dry mass was redissolved in distilled water. The insoluble residue was of a greyish colour, and to this the deposit formed during the evaporation was added. It was known by previous experiments that the greater part of the iron was separated in this way; the insoluble matter, when digested with muriatic acid, affording a liquor, when diluted with water, which gave, after neutralization with ammonia, a deep colour with tincture of galls. To ensure, however, the more perfect separation of the iron, ammonia was added to the solution of the solid matter which had been procured by evaporation, and care being taken that the ammonia was free from carbonic acid, little or no precipitation could take place but of oxide of iron. A yellowish flocculent precipitate subsided slowly, which, after being washed, was added to the insoluble residue.

The insoluble matter thus collected consisted, as the preceding steps of the analysis establish, chiefly of sulphate, with a smaller portion of carbonate of lime, with which was mixed the oxide of iron. A drop or two of sulphuric acid was added, to convert the carbonate into sulphate of lime; and heat was applied to expel any excess of acid. A little pure muriatic acid was then added to dissolve the oxide of iron, and to form with more certainty the red muriate, soluble in alcohol, a drop of nitric acid was added along with it. On applying heat, with the addition of a little water, to favour the action, a yellow colour was acquired. When the excess of acid was nearly dissipated, the mass was repeatedly lixiviated with

alcohol, in which sulphate of lime being insoluble, the muriate of iron only would be dissolved. The alcohol acquired accordingly a yellow colour. Being evaporated by a gentle heat, it gave a residuum which, on a drop of nitrous acid being added, became of a deep reddish brown colour, and after being heated strongly, weighed 0·34 grain. Redissolved in muriatic acid, it formed a rich yellow-coloured solution, and gave a deep colour with tincture of galls.

Even in this way the whole iron is not obtained; for the solution of the saline matter, though ammonia had been added to it, to precipitate the iron, still gave a weak colour with galls. The quantity therefore is rather under-rated. Taking the above, however, as the proportion, the whole composition will be, in a pint of the water of the north spring,

	Grains.
Muriate of soda .....	24
Muriate of lime .....	18
Sulphate of lime .....	3·5
Carbonate of lime .....	0·5
Oxide of iron .....	0·17
	46·17

#### *Analysis of the Water of the South Spring.*

The water of this spring has a taste similar to that of the other, but rather weaker: it produces similar medicinal effects. In the present state of the spring its strength is more variable, according to the state of the weather. From this circumstance, and from its being rather weaker, it has probably a greater intermixture of surface-water, or of the water of other springs. When taken up after continued dry weather, it afforded, by evaporation, 42 grains of solid matter from a pint; the other affording, at the same time, 47 grains. Its specific gravity was found to be 1·00419. It was in this state, the strongest in which it was found, that it was submitted to the following examination.

The application of re-agents produced the same appearances as with the water of the north spring, indicating, therefore, the presence of the same ingredients. To determine this with more precision, and to ascertain the proportions, the same methods of analysis were employed which had been used with regard to the other. It will be sufficient to state the results by one method—the second of those before described.

A pint of the water was submitted to evaporation, and afforded of dry matter, weighed while warm, 42 grains. This was redissolved in distilled water. There remained undissolved a portion which, when thoroughly dried, weighed 2·5 grains. This suffered a very slight effervescence with muriatic acid, similar to that excited in the insoluble matter of the water of the north spring; a similar thin crust, too, had formed on the sides of the glass capsule, which was removed with effervescence by a drop of muriatic acid. The

relative proportions, therefore, of sulphate and carbonate of lime may be regarded as the same: and the insoluble residue will thus consist of 0·3 of carbonate and 2·3 of sulphate of lime. By precipitation by muriate of barytes from another pint of the water, similar results were obtained.

To the clear liquor oxalate of ammonia was added as long as it produced any turbid appearance. The precipitate collected and dried, being converted by calcination into carbonate of lime, afforded, when acted on by muriatic acid, 16 grains of dry muriate of lime.

The solution poured off from the precipitate was evaporated to dryness, and the dry mass was exposed to a heat gradually raised to redness, until it ceased to exhale any vapour. The muriate of ammonia formed by the action of the oxalate of ammonia on the muriate of lime was thus expelled, and the muriate of soda of the water remained. It weighed 22·5 grains.

The results, then, by this method, are from a pint of the water,

	Grains.
Muriate of soda .....	22·5
Muriate of lime .....	16
Sulphate of lime .....	2·3
Carbonate of lime .....	0·3
Oxide of iron .....	0·15
	<hr/> 41·25

The proportion of iron I have stated as similar to that of the north spring, from the colour produced by the tincture of galls being nearly the same.

From the almost perfect similarity in the composition of the two waters, with regard to the proportions of their ingredients, there is every reason to conclude that they are from the same spring; the weaker being either mixed with surface water at the pool, or being diluted in its course.

The determination of the composition of this water suggests the question whether this is such as to account for the medicinal effects it produces. It acts, as has been stated, as a diuretic, and in a larger dose as a cathartic. This water, and the mineral water of Pitcaithly, present in some respects a peculiarity. The greater number of saline waters which have a purgative quality contain magnesian salts, to which, as they are known to act as cathartics, the effect is obviously to be ascribed. Of the ingredients of the Dunblane and Pitcaithly springs, muriate of lime is scarcely known to have any purgative power in its pure form; and if muriate of soda possess it, it is only in an inconsiderable degree. Still there can be no doubt that it is to this impregnation that their operation is owing; and they afford a proof, therefore, of what is indeed sufficiently established, that the powers of mineral waters are often much greater than could be expected from the nature and quantity

of their ingredients, and that the action of saline substances is increased, and considerably modified when they are in a state of great dilution.

Independent of its purgative operation, and its adaptation to the treatment of diseases in which this is advantageous, its composition may probably render it a remedy of efficacy in some constitutional affections, particularly in scrofula. Muriate of lime has attained some celebrity in the treatment of this disease; it is a substance of considerable activity in its effects on the living system; and it will probably operate with more effect, and more advantage, in the state of dilution in which it is presented in a mineral spring, than when given in a more concentrated form. The muriate of soda may coincide with it in efficacy, and will be of advantage from its grateful taste, and its stimulant action on the stomach: and the chalybeate impregnation will communicate some degree of tonic power. When employed in such cases, it probably ought to be given in smaller doses, than when the advantage to be derived from it depends on its purgative operation; and it may even prove more advantageous if given in a state of greater dilution. I shall in the sequel have to state a view of its composition, which connects it with some mineral springs of great celebrity, and particularly with the Bath waters.

Dunblane, as a watering place, would be possessed of considerable advantages. Situated between the range of the Ochil Hills and the Grampians, it is well sheltered, and hence enjoys a mild atmosphere; and the soil, from being a bed of gravel for a number of miles around, is extremely dry—an advantage inestimable in a moist climate.

## II.—ANALYSIS OF PITCAITHLY WATER.

The water of Pitcaithly may be regarded as the principal mineral water of the saline class in this country. Dr. Donald Monro showed that, along with a little mild calcareous earth, it contained muriate of soda, with a deliquescent salt, which he inferred to be chiefly “a calcareous marine,” that is, muriate of lime.\* An analysis of it was published a number of years ago, executed by Messrs. Stoddart and Mitchell, of Perth. There are different springs, the waters of which they found to be somewhat different in strength. The nature of the impregnation is in all of them, however, the same. Selecting the strongest, it contains, according to their analysis, the following ingredients in an English pint:—

Atmospheric air .....	0·5 cub. in.
Carbonic acid gas .....	1
Muriate of soda .....	12·5 grains
Muriate of lime .....	22·5
Sulphate of lime .....	0·7
Carbonate of lime .....	0·6 †

\* Philosophical Transactions, vol. lxii.

† Statistical Account of Scotland, vol. viii.

The composition of this water, according to this analysis, is very similar to that of the Dunblane water. No account is given, however, so far as I have been able to discover, of the manner in which it had been executed, and it is therefore uncertain to what state of dryness the ingredients had been brought to which their proportions are referred. Hence no comparative estimate can be made of it with any other mineral water; and this led me to undertake its analysis, in the same manner as that of the Dunblane water.

Pitcaithly is situated in the valley of Strathern, and though at rather a greater distance from the front range of the Grampians than Dunblane, it is not improbable that the spring may have a similar origin with the Dunblane one, and may rise from the red sand-stone which appears to form the first rock on descending from the primitive rocks, and to extend over all this district.

The taste of this water is saline, and somewhat bitter. Comparing it with the Dunblane water, both being tasted at the same time, the taste of the Dunblane water is stronger, and in particular more saline than that of the other. The medicinal operation of the Pitcaithly water, in the sensible effects it produces, is diuretic and purgative.

The gaseous impregnation of the water could be examined properly only at the spring, which I had not the opportunity of doing. But having procured a quantity of the water, I submitted it to the same examination as in the preceding analysis, to ascertain its solid contents. The usual re-agents produced the following appearances:—

1. The colours of litmus, violet, and turmeric, were scarcely affected. If there were any change, it was that of the litmus becoming more blue, and that of the violet-green; but this was so slight as to be rather doubtful. The turmeric underwent no change.

2. Muriate of barytes produced a turbid appearance and precipitation; but this was much less considerable than in the Dunblane water. The transparency was not restored by nitric acid.

3. Nitrate of silver produced a very dense and copious precipitate.

4. Water of potash gave a milkiness not very considerable.

5. Carbonate of potash threw down a copious precipitate, which disappeared with effervescence on adding nitric acid.

6. Lime-water had no sensible effect.

7. Ammonia, when perfectly free from carbonic acid, caused no turbid appearance.

8. Oxalate of ammonia produced an abundant precipitation.

9. Tincture of galls, added in a very minute quantity, did not immediately produce any effect; but after a few hours, a dark colour appeared, which gradually deepened, inclining to an olive-green.

With all these tests, the general results are the same as those from the operation of the same tests on the Dunblane water. In experiment 7th, the ammonia, if not perfectly free from carbonic

acid, produced a slight turbid appearance; and even when in its purest state, a very slight opalescent hue was perhaps apparent; but this obviously depended on the presence of a little carbonic acid; for when a drop or two of nitric acid was previously added, and the water heated, no such appearance was produced; or, if boiled strongly, without any addition of acid, on restoring the original quantity of liquid, by adding distilled water, the transparency was not in the slightest degree altered on adding pure ammonia. The slight precipitate, too, which did occur in any case was dissolved by the most minute quantity of muriatic acid with effervescence; and this solution became turbid on adding oxalate of ammonia, proving the precipitate to have been carbonate of lime.

The same general conclusions, then, with regard to the nature of the ingredients, are to be drawn from the preceding results as from the application of the same tests to the Dunblane water. They suggest of course a similar mode of analysis. I preferred the second of the methods above described, as being the most simple and easy of execution.

An English pint of the water was submitted to evaporation. Before the matter became dry, numerous cubical crystals were formed, indicating the presence of muriate of soda; when dry, the solid matter entered readily into fusion with effervescence, denoting the predominance of muriate of lime. The dry matter was highly deliquescent. After exposure to a heat inferior rather to redness, it weighed while warm 35 grains.

This dry matter was redissolved in about ten times its weight of distilled water. A small portion remained undissolved, which, being washed and dried, weighed 1.2 grain. A little diluted muriatic acid dropt upon this excited slight effervescence; but the greater part remained undissolved, and weighed, after washing and exsiccation, 0.9 grain. It was *sulphate of lime*. A very thin crust adhered to the sides of the glass globe in which the last stage of the evaporation had been performed. This was dissolved with effervescence by diluted muriatic acid, and the solution became quite turbid on adding oxalate of ammonia. The quantity of *carbonate of lime* thus indicated, adding the portion abstracted, as above, from the sulphate, cannot be estimated at more than 0.5 grain. These results were confirmed by precipitation from another portion of the water by muriate of barytes, the proportions indicated being nearly the same.

The liquor poured off from the insoluble residue being diluted with distilled water, oxalate of ammonia was added to it as long as any turbid appearance was produced; and after the subsidence of the precipitate the liquor was boiled a little, to render the decomposition and precipitation complete. The clear liquor was then evaporated to dryness, and the dry mass was exposed to heat, to volatilize the muriate of ammonia, the product of the action of the oxalate of ammonia on the muriate of lime; the heat being continued as long

as any vapours exhaled, and at the end being raised to redness. The muriate of soda thus obtained weighed 13·4 grains. By solution and crystallization it was obtained in cubes.

The precipitate of oxalate of lime having been thoroughly washed, was exposed in a sand-bath to a heat short of redness, until it had ceased to exhale any vapours, and appeared perfectly dry; it weighed 23·8 grains. The portion of muriate of lime equivalent to any quantity of oxalate of lime cannot, as has been already remarked, be exactly assigned, from the difficulty of bringing the oxalate to one uniform state of dryness. But, according to the most accurate analyses, 23·8 grains of dry oxalate are equivalent to 20 grains of dry muriate. To avoid any error, however, the oxalate was converted into carbonate of lime by calcination; and this, decomposed by muriatic acid, afforded 19·5 grains of dry muriate of lime.

The proportions, then, of the saline ingredients in an English pint of the Pitcaithly water are, according to this analysis,

	Grains.
Muriate of soda .....	13·4
Muriate of lime .....	19·5
Sulphate of lime .....	0·9
Carbonate of lime .....	0·5
	34·3

To which are to be added of ærial ingredients,

	Cubic Inch.
Atmospheric air .....	0·5
Carbonic acid gas .....	1

It also gives slight indications of the presence of iron; but as far as can be judged from the shade of colour produced by tincture of galls, the quantity is much smaller than in the Dunblane water. It does not admit, therefore, of being determined with much accuracy by actual experiment.

After I had completed the preceding analysis, a view occurred to me with regard to the composition of these waters, different from that which has been stated above; and which, if just, may lead to conclusions of some interest with regard to the constitution of mineral waters of the saline class. This I have lastly to illustrate.

(To be continued.)

### ARTICLE III.

*Some Observations on the Analysis of Organic Substances.*

By Dr. Prout.

BERZELIUS has lately extended the doctrine of definite proportions to the principles of organic nature, and has very satisfactorily



shown that it holds equally good with respect to them, with some slight modifications only, as with inorganic compounds.\* His admirable paper on this subject has thrown a new light on the constitution of natural objects, and at the same time opened a field of investigation no less difficult than interesting. My object at present is chiefly to point out the important assistance which may be derived in similar researches from the use of the invaluable scale of chemical equivalents contrived by Dr. Wollaston; a fact well known to its distinguished author, and many others; but which, perhaps, is not so generally so as it ought to be. On the supposition that this instrument be correct, or nearly so, which no one can doubt, and that organic substances be really formed on the principles of definite proportions, we are enabled by its means to approximate in most instances, with almost absolute certainty, to the number of atoms of each element entering into the composition of a ternary or quaternary compound. The data requisite for this purpose are, 1. The knowledge of the proportions of at least two of the elements entering into an organic compound; and, 2. The knowledge of the weight of its atom, or some multiple of it. Of these two, the first is by far the most important; the second is not absolutely necessary.

To render this scale adapted for our purpose, it is only necessary to extend it a little, which may be conveniently done by pasting two slips of drawing paper on its edges, which must be of such a breadth as just to lap over and cover the margins containing the names of the chemical substances, and to coincide with the graduated edges of the slide. On these slips of paper are then to be marked the multiples of an atom of oxygen, hydrogen, and carbon, from one to ten; and of azote, from one to four or five, or more. Thus prepared, it will be fit for our use; and to those who are unacquainted with the principles of the instrument, the following examples will show the mode of applying it: to others these examples will be probably unnecessary.

*Example 1.*—Suppose we had found the weight of a particle of a ternary compound to be 46·5, oxygen being 10, and that 46·5 parts of it contained 15·15 carbon, 1·34 hydrogen, and consequently 30·01 oxygen. To find the number of atoms of each of these elements, we have only to place 10 on the slide opposite oxygen; and then opposite each of the numbers respectively we have the number of atoms of each element required. Thus opposite 15·15 carbon, we have 2 carbon; opposite 1·34 hydrogen, 1 hydrogen; and opposite 30·01 oxygen, 3 oxygen. Such a compound, then, will consist of three atoms oxygen, two atoms carbon, and one atom hydrogen.

Again: supposing we were ignorant of the weight of an atom of this ternary compound, but had found that 100 parts of it contained 32·4 carbon, 2·8 hydrogen, and consequently 64·8 oxygen; to find the number of atoms of each element in this case we have only to

\* See *Annals of Philosophy*, vol. iv. p. 323, et sequent.

move the slide till the numbers representing the quantities of each element coincide with some multiple of these elements marked on the scale; and these multiples, or some submultiple of them, will represent the number of atoms required. Thus we find when 32·4 carbon stands opposite two or four atoms of carbon, 2·8 hydrogen will coincide with one or two atoms of hydrogen, and 64·3 oxygen with three or six atoms of oxygen. Of course we adopt the lesser numbers, which are the same as those obtained before.

*Example 2.*—Suppose we had found the weight of an atom of a quaternary principle to be 97·82, and that 97·82 parts of it contained 37·65 carbon, 17·52 azote, and consequently 42·65 oxygen and hydrogen: to find the number of atoms of each, we place, as before, 10 on the slide opposite oxygen: then opposite 37·65 will be found 5 carbon; opposite 17·52, 1 azote; opposite 40, 4 oxygen; and opposite 2·65, 2 hydrogen; \* the number of atoms required.

Or supposing that we had not been able to ascertain the weight of a particle of the compound in question, but had found that 100 parts of it contained 38·5 carbon, 17·9 azote, and consequently 43·6 oxygen and hydrogen: to find the number of atoms of each, we proceed just as before, and still find that 38·5 carbon will stand opposite five or ten atoms of carbon, when 17·9 azote coincide with one or two atoms of azote; † and that 40·9 oxygen will be opposite four or eight oxygen; and 2·7 hydrogen, opposite two or four hydrogen; which agree with the former results.

These examples are doubtless more than sufficient to show how this admirable instrument may be made to facilitate and verify analyses, on the practical part of which some observations now remain to be made.

1. The depriving organic substances of water without decomposing them has always constituted a great source of difficulty in the prosecution of this département of chemistry. The method adopted by Berzelius, and which is founded on the happy application of a well-known principle by Mr. Leslie, is certainly one of the best that has been proposed. This consists in exposing the substance

\* These two numbers make up 42·65, the quantity of oxygen and hydrogen present. As no solid substance, probably, will be found to contain more than six or even four atoms of hydrogen, it will perhaps be sufficient in practice to divide as often as possible the quantity of oxygen and hydrogen by the weight of a particle of oxygen, and to consider the quotient as representing the number of particles of oxygen, and the remainder as hydrogen. Thus in the present instance  $\frac{42.65}{10} = 4$ , with a remainder of 2·65 for hydrogen, and  $10 \times 4 = 40$ , the quantity of oxygen. To prevent ambiguity, however, it will be better to have recourse to experiment, which without any great nicety will enable one to decide between one and eight atoms of hydrogen, as in the above instance between 2·65 hydrogen and 12·65 hydrogen.

† It is extremely probable that azote never enters into a compound more than in one, or certainly not more than in two, proportions. The knowledge of this will facilitate the process, as the quantity of azote found may be at once placed opposite one azote.

to be dried to a temperature of 212 in a vacuum with sulphuric acid. For effecting this more easily, I had the following apparatus made, which answers the purpose very effectually, and at the same time will be found simple and convenient.—A (Plate XXXIX. fig. 1.) is the flat circular plate of an air-pump, on which is placed C, a saucer containing sulphuric acid. B a low receiver communicating with the inner vessel G by means of the pipe F. H is a brass cap, capable of being made air-tight by means of a screw and leather collar, having a square nut L adapted to a key by which it may be unscrewed, &c. when necessary. The outer vessel K contains water, which is kept at the boiling temperature by means of the lamp E, which slides upon the tube F, and can thus be raised or depressed at pleasure. The substances to be dried are put into little glass vessels I of the shape of buckets, and are placed in the vessel G, and removed from it through the aperture H by means of a hooked wire. D is a stop-cock, which, when the cap H is removed, may be turned, and thus the air prevented from entering the receiver B, and the trouble consequently saved of being perpetually obliged to exhaust the whole apparatus.

In using this apparatus it is proper to introduce as little superfluous water as possible; or if this cannot be avoided, care must be taken not to exhaust all at once, but by slow degrees, otherwise ebullition will take place, and the substances be forced out of the glass buckets.

2. For finding the weight of combination, or of an atom of an organic compound, no general rule can be given, as the process must vary with the nature of the substance. A careful study of the ingenious modes pursued by Berzelius will scarcely fail to suggest others. It may sometimes be more conveniently done after an insight has been obtained of the constitution of the substance under examination. But upon the whole, it will perhaps be found one of the most difficult steps to effect, and sometimes even impossible.

3. It is a difficult task, and requires great care and nicety, to arrive at an accurate knowledge of the quantities of the elements entering into an organic compound. The best mode at present known is undoubtedly combustion with oxymuriate of potash in an apparatus somewhat similar to Berzelius's.\* I have tried this, and found it succeed completely. The only objection to it is its being rather too complicated; and in general, perhaps, it will be found better to rest satisfied with the knowledge of the quantity of one element, and to make separate experiments for each of those whose quantity we may wish to ascertain. In a ternary compound, carbon and hydrogen are the elements whose quantities are most easily found. Perhaps, however, the real quantity of hydrogen will be always somewhat larger than indicated, because the gases extricated during combustion must necessarily be in the driest possible state,

\* I have tried also the ingenious mode adopted by Mr. Porrett in his analysis of prussic acid; namely, of adding multiples of oxygen. This, however, though it succeeded in that instance, does not seem capable of universal application.



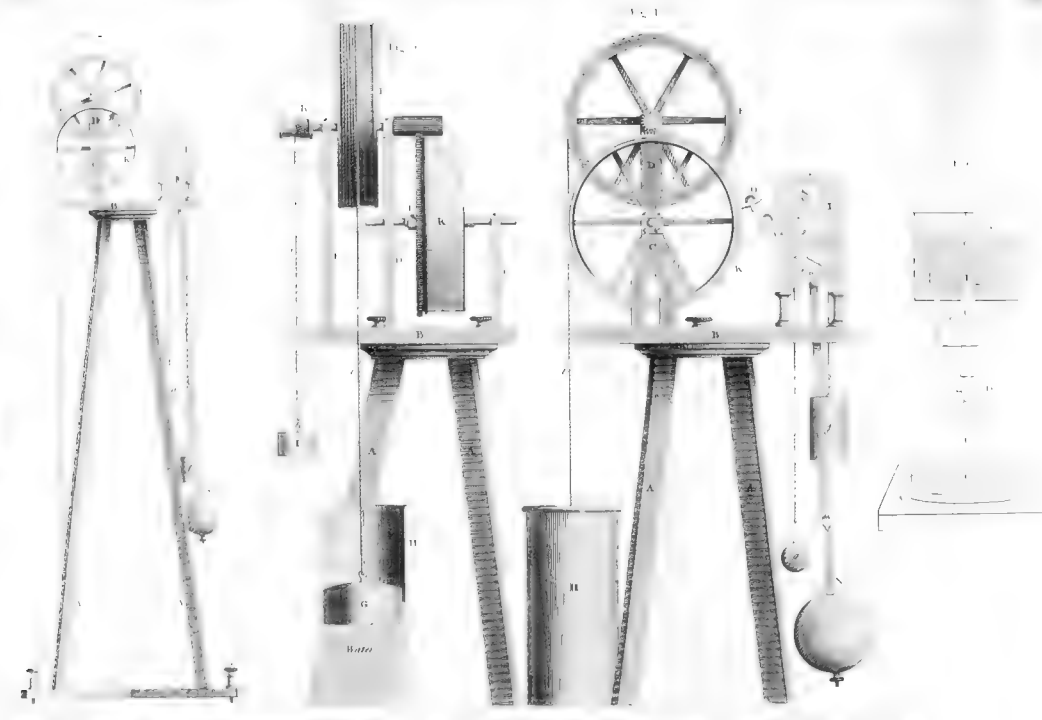

Invented by P. Thomme, Senegal, see Bulletin Inventiv. & Jour. Instrumens. Ann. October 1786.

1815  
and  
stima  
in the  
need  
a ob.  
t all  
calcu  
most

Dr. v.  
I.  
B.  
T.  
In the  
the se  
filling  
fall u  
end o  
presen  
preve  
A  
roller  
weight  
side th  
the fl  
This  
cylind  
The  
clock  
a man  
quere  
the in  
of ris  
elapse  
The  
const  
fig. 2,  
ported  
adjust  
es ap  
tance  
port  
figure  
Upon  
Vo

and in this state they will dissolve, and retain water with great obstinacy. The mode, therefore, adopted by Berzelius was probably inadequate to separate the whole of the water formed; and this may account for the small quantity obtained by him on burning oxalic acid. The remark, however, if founded in truth, applies equally to all the substances analysed by him. In a quaternary compound, carbon and azote are perhaps the elements whose quantities we can most easily arrive at a just knowledge of.

#### ARTICLE IV.

*Description of an Instrument to measure and register the Rise and Fall of the Tide throughout the whole Flow and Ebb.* By Col. Beaufoy.

THE parts of this instrument which are devoted to measuring the height of the water consists of a copper tube placed in the water of the sea or river in a vertical position, and provided with a float nearly filling its bore, at the same time that it is freely at liberty to rise and fall upon the surface of the water, which is admitted into the lower end of the tube by a small opening, or by a pipe, and will therefore preserve the same level as the external water of the sea or river, and prevent the float being affected by the undulations of the water.

A small line is attached to the float, and carried up to a wheel or roller, round which it makes several turns; and the line of a balance weight, being wrapped upon the axis of the wheel on the opposite side of the centre, will cause the wheel to turn one way or other as the float rises or falls upon the surface of the water in the tube. This motion is communicated by wheel-work to a second wheel or cylinder, upon the surface of which a sheet of paper is fastened.

The registering part of the instrument is an eight-day pendulum clock, which at every ten minutes lets fall a small hammer to make a mark on the sheet of paper wrapped upon the cylinder; in consequence, this sheet will be covered with a succession of marks, and the intervals between them will show on a reduced scale the quantity of rise or fall of the water during the interval, ten minutes, which has elapsed between the different marks made by the clock.

The general action of the machine being understood, the detail of its construction will be explained by the drawing, in which Pl. XXXIX. fig. 2, represents the whole machine mounted upon a tripod A A supported upon three feet screws *a a*, by means of which it can be so adjusted that the clock will beat correctly, or in other words, that the escape of the teeth of the swing-wheel will take place at equal distances from the perpendicular on the opposite sides; the tripod supports a mahogany table B, which is represented on a larger scale in figures 3 and 4, the first being a side view, and the other a front view. Upon this table are erected standards C D E for the support of the

wheels or cylinders: the most elevated of these, marked *F*, is that upon which the line *b* is wound to suspend the float *G* in the tube *H*: upon the extreme end of the axis of the wheel *F* is a small cylinder *R* to receive the cord *d* of the balance weight *I*, which is such as so far to balance the weight of the float as to keep the line *b* always extended: on the opposite end of the axis of the upper wheel is fixed a long pinion *k* of 30 teeth; this gives motion to the cylinder *K*, upon which the sheet of paper is wrapped, by means of a wheel of 360 teeth. As the wheel and pinion are in the proportion of twelve to one, it follows that any motion which is given by the float line *b* will be communicated to the cylinder *K* upon the scale of an inch to a foot; that is, a rise or fall of one foot in the float will produce a motion of an inch in the paper with which this cylinder is covered, or one inch of the paper will pass by the pencil, which is to mark by the hammer of the clock *L*.

This clock is mounted upon four pillars *e* from the table; *f* is the weight of the clock, and *g* a small counter-balance, which, being pulled down, will draw up the great weight to wind it up, and will then serve for eight days; the hour-hand, which is seen in the front, is carried immediately by the arbor of the barrel of the clock, and shows 24 hours; the circle above this, divided into 10, shows the minutes, as it makes its revolution in 10 minutes; and the upper circle is for the seconds.

The disposition of the train of wheel-work, for the clock not being at all essential, is not therefore shown in the drawing; but any clock-maker to whom the construction is committed will be able to make a proper clock from the number of the wheels, which are as follows.

The great wheel on the barrel, which carries the hour-hand, 96 teeth, revolves in 24 hours.

The centre wheel, pinion, eight leaves, and the centre wheel 84; these will revolve in two hours.

The third wheel, pinion, seven leaves, and the third wheel 70 teeth; they complete their revolution in ten minutes; and the arbor carries the minute-hand.

Lastly, the pinion of the swing-wheel having seven leaves, it will revolve in one minute, carrying the second-hand and swing-wheel, which having 30 teeth, and acting with two anchor pallets, they will suffer the wheel to advance  $\frac{1}{2}$  a tooth at every vibration of the pendulum *N*, which is performed in a second.

The train must be made rather stronger than usual to enable it to carry a greater weight *f*, in order that the regularity of the motion may not be deranged by the resistance of lifting the hammer *O* which makes the marks upon the cylinder *K*. This hammer is fixed upon an arbor extended between the clock plates, and has two arms or levers proceeding from it, one to reach the third wheel, and the other to the centre wheel. The former wheel, which revolves once in ten minutes, has one pin fixed in its circumference, and the latter has 12 pins. Now as it turns in two hours, it is plain that one pin



of each of these wheels will pass by their respective arms or levers of the hammer in the same period, viz. 10 minutes: they therefore produce a common effect of lifting the hammer and letting it fall at every 10 minutes. The reason for employing two motions for this purpose is, that, if it was entrusted to the third wheel to raise it with one pin, it might retard the motion of the clock, because that wheel has so slight a power; and, on the other hand, the 12 pins in the centre wheel would not be equally certain to drop the hammer exactly at the 10 minutes, because as it moves slowly any small inequality in the arrangement of the pins would make a considerable difference in the time when the hammer was let fall. The pins of the centre wheel are therefore made to act first, and the wheel has sufficient power to lift the hammer without injury to the motion of the clock; but just before this pin would let the hammer fall, the pin in the third wheel takes its lever and raises it up a very little higher, or rather holds it up at the same elevation, till the pin of the centre wheel has passed, and then at the expiration of the 10 minutes it lets the hammer fall.

The mark is made on the paper of the cylinder by a small piece of black lead pencil, which is fastened in a tube at the end of the hammer by a clamp screw: *p* is a small sliding weight upon the arm of the hammer, which can be fixed at any distance from the centre by a clamp screw, and will thus make the pencil strike with more or less force, as is found by experience to be necessary to make a clear and defined mark: one of the levers or arms of the arbor of the hammer must be made to fall upon a spring to stop the descent of the hammer. This will yield sufficiently to allow the pencil to mark when falling with the blow, but will afterwards keep up the point so that it will not streak the paper. In this manner the pencil will make a row of dots round the cylinder as the tide rises, and the same as it falls: but to prevent the two rows falling upon the same line, by which they would confuse each other, a traversing motion is given to the cylinder at the same time that it turns round: this is effected by a worm *P* fixed upon the axis of the wheel, and a cock *r* projecting from the standard *D* to carry a fixed pin which acts against the worm. By this means the row of dots, when the tide rises, is marked diagonally; but when the tide falls, the cock *r* quits the spiral, and the row of dots are marked circularly. The axis of the wheel is made with long pivots, which slide endways, to allow the side motion; but the friction is sufficient to keep one side of the spiral worm in contact with the pin which acts against it whilst the wheel turns in one direction, and quits it when it turns in the contrary direction.

As the paper must be changed about every 13 hours, the bearing at the top of the standard *C* is made to open on a joint, that the wheel may be taken out; the sheet of paper is only confined by a hoop or wire slipped over it; it is therefore easily changed; and the only care is to make the end of the slip of paper to correspond with a line drawn upon the cylinder to represent the point from which the measurement is taken, or point of commencement. The tube

H containing the float, although represented in the figure, must of course be placed beneath the floor upon which the tripod is placed : it should be as long as the greatest rise and fall which is expected. The present machine is adapted for 27 feet of rise ; the circumference of the cylinder K being rather more than 27 inches, and its diameter  $8\frac{2}{3}$  : the wheel F is the same diameter, and the line *b* must make 12 turns upon it for the whole 27 feet. For situations where a greater fall is desired, the diameters of the wheels must be proportionably increased.

The only adjustment this instrument requires is, that the clock be put in beat by levelling the feet, and regulated to keep good time, the line *b* must be lengthened or shortened until the float hangs level with the assumed fixed point from which the heights are to be measured.

If the clock wants altering, it must be stopped when the minute-hand points at 10', and the second-hand at 60''; and then the hour-hand must be set at the requisite division; for if the alteration be made at any other period, the pencil will not mark when the minute-hand arrives at 10'.

The instrument is made to take to pieces for convenience of carriage. The table B can be removed from the top of the tripod by two milled head screws; the pendulum detached from the clock, and fixed close to one of the legs of the tripod; and the weights and float to the base; in which state the whole can be put into a moderate sized packing case. I am very much indebted to Mr. Cary, mathematical instrument-maker, in the Strand, for the trouble and pains he took in executing this instrument.

It is generally admitted that theory alone affords no practical conclusions concerning the flowing and ebbing of the tides: recourse must therefore be had to numerous and accurate observations for practical rules to find the times of high and low water. This machine will register every ten minutes, with little trouble to the observer, the variation which takes place from high water to low water, and *vice versa*. As this instrument marks the ascent and descent of the water every ten minutes, sufficient datum will be given for finding the nature of the curve described by the tide: and if a register of the strength of the wind, and the point of the compass it blew from, was also kept, it might determine whether the wind most affected the velocity or the altitude of the tide. If instruments of this description were used in different parts of the world, and tables of the flux and reflux of the tide preserved for a period of 18 $\frac{1}{2}$  years; the length of time in which most of the lunar irregularities of motion take place, little doubt can be entertained but that as accurate tide tables might be made for the rest of the world as have been calculated for Liverpool by Mr. Noldens, and for the Thames by Capt. Huddart.

Expense, generally speaking, is an objection against purchasing an instrument. The one here described, being simple, is proportionably cheap: and the cost might still be reduced by making the clock and the other wheels of wood. As few persons are furnished

with instruments for measuring the force and velocity of the wind, the following remarks, the result of many observations, may serve as a guide to judge of the rate at which the wind is blowing.

When the wind blows at the rate of 12 geographical miles per hour, or 20·29 feet in a second, the power of the wind on a plane one foot square at right angles to the current is equal to 13·567 oz. avoirdupois; and the generality of vessels upon a wind blowing at this rate can barely carry top-gallant sails.

When the wind blows 24 geographical miles per hour, the force is 3·541 lbs. avoirdupois, and vessels are under close reefed topsails.

When the wind increases to 31·16 geographical miles in an hour, vessels are under their courses, and the power of the wind is equal to 6 lbs.

When the force of the wind is 8 lbs. on a square foot, its velocity is 35·931 geographical miles in an hour, and may be denominated half a storm.

When the strength of the wind is 12 lbs. on a square foot, its velocity is 43·918 geographical miles in an hour, and may be called a full storm.

Whilst on this subject, I have subjoined some experiments on the resistance of air and water, which prove how very erroneous the theory of resistance is, and the small advantage it has been to practical men.

*Experimented Resistance of Air to different shaped Bodies.*

Feet.	Plane.	Cylinder.	Cone.	Vertex.		Wedge.	Vertex.
1	0·032	0·028	0·029	0·020	0·022	0·032	0·023
2	0·129	0·116	0·120	0·086	0·090	0·129	0·089
3	0·294	0·268	0·274	0·198	0·203	0·291	0·197
4	0·525	0·485	0·492	0·358	0·364	0·518	0·346
5	0·825	0·768	0·775	0·567	0·571	0·810	0·537
6	1·191	1·118	1·122	0·826	0·825	1·168	0·769
7	1·627	1·537	1·535	1·135	1·127	1·490	1·041
8	2·131	2·024	2·013	1·491	1·476	2·070	1·354
9	2·704	2·580	2·564	1·905	1·873	2·634	1·707
10	3·345	3·206	3·167	2·268	2·317	3·253	2·100
11	4·055	3·902	3·843	3·017	2·809	3·939	2·533
12	4·834	4·668	4·586	3·610	3·348	4·690	3·005
13	5·683	5·505	5·395	4·066	3·936	5·506	3·518
14	6·601	6·413	6·271	4·737	4·572	6·389	4·069
15	7·588	7·393	7·231	5·462	5·255	7·337	4·661
16	8·644	8·445	8·295	6·239	5·988	8·351	5·292
17	9·771	9·570	9·302	7·068	6·767	9·430	5·961
18	10·966	10·767	10·447	7·952	7·595	10·576	6·670
19	12·232	12·038	11·660	8·890	8·472	11·787	7·419
20	13·567	13·378	12·940	9·882	9·397	13·064	8·207
p	2·0201	2·0611	2·0309	2·0619		2·0057	1·9·676
1	2	3	4	5	6	7	8

The area of the plane and base of each of the bodies is exactly one superficial foot; and the altitude of the cylinder, cone, and wedge, equal to half the diameter of their respective bases; conse-

quently when the cone and wedge moved with the apex foremost the air impinged at an angle of  $43^{\circ}$ .

Column 1 contains the velocity with which the air struck the different bodies.

Column 2, the resistance to the plane in ounces avoirdupois.

Column 3, the resistance to the base of the cylinder.

Column 4, the resistance to the base of the cone.

Column 5, the resistance to the vertex.

Column 6, the resistance to the plane reduced in the proportion of radius to the sign of the angle of incidence  $45^{\circ}$ .

Column 7, the resistance to the base of the wedge.

Column 8, the resistance to the vertex: and in the last horizontal line but one is set down the exponents of the resistance.

By looking at the experiments, it is evident that the bases of the cylinder, cone, and wedge, are less resisted than the plane; and that the cone and wedge, when moving with their bases foremost, are less resisted than the cylinder; therefore a mere increase of length decreases the resistance to the plane, but not so much as by altering the shape of the hinder extremity. With respect to the resistance to the apex of the cone and wedge, it is evident that the resistance to the former figure is not widely different from the resistance set down in column 6: and could experiments be made free from errors, the resistance would decrease precisely as the log. sine of half the cone's angle; but with the wedge it is otherwise, the resistance decreasing in a greater proportion.

*Experimented Resistances of Water to a Plane containing one superficial Foot immersed to the Mean Depth of 6 Feet below the Surface of the Water.*

Feet 1st	Feet. 2d.	Lbs. 3d.	Lbs. 4th.	Lbs. 5th.	Lbs. 6th.	Lbs. 7th.	Exponents. 8th.
1	0·0156	0·9750	1·2949	1·1329	0·1620	0·1579	
2	0·0621	3·3860	4·9863	4·3585	0·6278	0·9725	1·9289
3	0·1399	8·7450	10·931	9·5640	1·3670	0·8190	1·8956
4	0·2487	15·543	19·048	16·687	2·361	1·144	1·8699
5	0·3886	24·287	29·279	25·688	3·591	1·401	1·8465
6	0·5596	34·975	41·585	36·540	5·045	1·565	1·8266
7	0·7616	47·603	55·927	49·220	6·707	1·617	1·8065
8	0·9918	62·175	72·270	63·707	8·563	1·532	1·7854
9	1·2590	78·690	90·590	79·983	10·607	1·293	1·7682
10	1·5544	97·150	110·86	98·040	12·82	0·890	1·7448
11	1·8806	117·82	133·05	117·86	15·19	0·040	1·7282
12	2·2383	139·90	157·20	139·49	17·71	0·590	1·7081
13	2·6270	161·18	183·40	164·73	18·67	0·450	1·6857
14	3·0476	190·42	211·51	190·39	21·12	0·030	1·6630
15	3·4974	218·59	241·54	217·89	23·65	0·700	1·6380
16	3·9793	248·71	273·48	247·23	26·25	1·186	1·6198
17	4·4923	280·77	307·33	278·40	28·93	2·270	1·5977
18	5·0363	311·77	343·05	311·39	31·66	3·380	1·5754
19	5·6114	350·71	380·16	345·73	34·43	4·980	1·5531
20	6·2177	389·61	420·16	382·92	37·24	5·690	1·5312
			1·9243	1·9474			

Column 1 contains the velocity of the plane in feet per second.

Column 2 contains columns of water, the base of each of which was one square foot, and the respective altitude equal to the space through which a body must fall to acquire the velocity of one, two, three, four, five, six, &c. feet per second.

Column 3 contains the weights of the different columns of water in pounds avoirdupois.

Column 4, the resistance to the plane by experiment.

Column 5, the plus pressure found by subtracting the minus pressure contained in column 6th from the total resistance set down in column 4th.

Column 6, the minus pressure found by experiment.

Column 7, the difference between the calculated resistances contained in column 3d and the plus pressure in column 5th.

Column 8, the exponents of the minus pressure; and in the last horizontal column the exponents of the total resistances and plus pressure.

Wind, it appears by table 1st, when moving with a velocity of 20 feet in a second, exerts a force on a square foot placed at right angles to its direction equal to 13·567 ounces; and water, by table 2d, when running one foot per second, acts on the same surface, similarly placed, a power equal to 1·2949 lbs. or 20·718 oz. To find the velocity water must have to produce equal effect with wind,  $V m : v m :: R : r$ .  $V$  being equal to one foot or 12 inches,  $r$  to 13·567 oz.,  $R$  to 20·718 oz., and the exponent  $m$  to 1·9243, whence  $r$  is 9·6301 inches, the required velocity. Then  $\frac{20 \times 12}{9 \cdot 6301}$  is equal to 24·922, the celerity of the wind to produce the same effect as water; and  $\frac{20 \cdot 718}{0 \cdot 319}$  gives 649·48: consequently if wind and water move with equal velocity, wind has nearly 650 part less power than water. As air is 860 times lighter than water, and supposing the velocity of water to be 1, and the resistance as the square of the velocity  $V = \sqrt{860} = 29 \cdot 326$ , which by no means accords with the result deduced from experiment, and the effect of air in lieu of  $\frac{1}{860}$  part is  $\frac{1}{860}$ . Experiment also proves that the most advantageous angle for the sail of a windmill to be set in motion in is 60°, instead of 35° 16', reckoning from the plane of its motion, or the wind should strike the sail at an angle of 30°, and not 54° 44'; and the most advantageous angle for the rudder to make with the keel, when the impulse of the water is given, I believe to be 30°. After the impulse is given, and the vessel turns, the angle should be altered, if the rudder coincides with the curve described by the stern, because then it is evident the rudder would be of no use.

In the *Examen Maritime* by Don Georges Juan, traduit de l'Espagnol, the resistance of fluids is supposed to be, as their densities, as the surface opposed to their action, and as the square root of the depth to which the opposing obstacle is immersed. That the first supposition is not well founded, will, I think, appear from the

experiments stated : and that the third supposition is not, is evident from the following experiment. The plus and minus resistance of a parallelopipedon one foot square immersed to the depth of very nearly six inches, and moving with a velocity of 12 feet in a second, is 152·62 lbs. avoirdupois ; and in table 2d, the resistance of a plane containing one superficial foot immersed to the depth of six feet, and moving with a velocity of 12 feet, is 157·20 lbs., which is not widely different ; and this variation of 4·58 lbs. may partly be attributed to the longer body being less resisted than the plane.

The first column of the following table contains the velocity in feet per second ; and the second column contains the friction of water against 100 superficial feet of wood immersed to the depth of six feet ; and great pains were bestowed in rendering the surface of the wood as even and smooth as possible.

The third column contains the increase of the friction by sinking the surface one foot lower. If the friction be required for nearer the surface than six feet, the numbers in this line must be subtracted from those in the first line ; but if lower be wanted, the numbers in this line must be added. These numbers were determined from actual experiment.

By this table a judgment may be formed what is the friction of the water on the bottom of a large ship ; or, more properly speaking, what is the minimum of the friction ; for it is almost impracticable to render the immersed part of any vessel so even on the surface as that with which the experiment was made.

A second rate man-of-war has 15,000 superficial feet immersed under the water, if the draft of water be 24 feet. Supposing the vessel sails at the rate of 20 feet per second, and that the friction is calculated at the depth of 12 feet, or half the draft of water, then  $121·86 + 24·668 = 146·53$ , which, multiplied by 150, gives 21979 lbs. or somewhat more than nine tons ; but in fact this additional resistance to the division of the fluid must be far greater, as a vessel when coppered is, comparatively speaking, a very uneven surface ; and any contrivance to diminish the friction would be very desirable. Rolled or milled copper sheets being smoother than those hammered, if one of his Majesty's ships had *one* side coppered in the usual manner, and the *other* side with rolled or milled copper ; pains being taken to lay the sheets on as evenly as possible, and the heads of the nails countersunk ; if this vessel so prepared were sent to sea in company with another, and under favourable circumstances, the two vessels, by setting more or less on the same tack, had equal progressive velocity ; and the two vessels put about, and run on the other tack with the same quantity of sail ; the difference of the sailing will show the advantage of the two modes of coppering.

*Friction of the Water against 100 Feet, at the mean Depth of  
6 Feet.*

Feet.	Lbs.	Lbs.	Feet.	Lbs.	Lbs.
1	0·3716	0·0067	11	38·630	0·8451
2	1·4292	0·0253	12	45·684	1·0532
3	3·1350	0·0474	13	53·298	1·2751
4	5·4672	0·0809	14	61·462	1·5569
5	8·4284	0·1297	15	70·180	1·8771
6	11·991	0·1934	16	79·443	2·2382
7	16·154	0·2767	17	89·247	2·6420
8	20·906	0·3805	18	99·588	3·0911
9	26·238	0·5074	19	110·46	3·5817
10	32·152	0·6618	20	121·86	4·1113

From these experiments, it is evident that the resistance a body meets with when moving in water consists of three parts—the head resistance, the minus pressure, and friction.

The shape of the solid of the least resistance is still to be ascertained, which experiments alone can determine ; though perhaps no shape will answer in every velocity.

I remain, my dear Sir,

Yours very sincerely,

MARK BEAUFOY.

### ARTICLE V.

*New and important Combinations with the Camera Lucida.*

By W. G. Horner, Esq.

(To Dr. Thomson.)

SIR,

*Bath, Aug. 15, 1815.*

THE numerous inventions of Dr. Wollaston in various departments of philosophy are marked by that precision and completeness which constitute the true idea of elegance. They seldom leave to succeeding experimenters any hope of adding an improvement, and are only capable of being enhanced in estimation by multiplying the useful purposes to which they may be applied. These remarks are eminently appropriate to the Camera Lucida. As a corrective of the erroneous decisions of the eye, or a succidaneum to the labour of educating that organ, the utility of this beautiful little machine is well known. These advantages, offered by the instrument in its simple form, have been proved by the geologist, as well as by artists in miniature, landscape, and architecture ; but I am ignorant if any philosopher has been struck with the still more extensive uses to which it may be adapted in combination with the microscope and telescope.



Many circumstances occur to recommend these adaptations, without including the superior gratification of being able to copy with certain correctness the forms of minute or inaccessible and distant objects, when compared with that of retailing appearances, which are open to every beholder. The great difficulty which even an experienced artist finds, in representing with tolerable accuracy a telescopic or microscopic image viewed in the usual constrained and interrupted manner, will render this improvement highly desirable. The astronomer, and even the military officer engaged in reconnoitring, would derive important assistance from the use of the *graphic telescope*.

The patent for the Camera Lucida remains, I believe, with the illustrious inventor; and his sagacity, which has perhaps anticipated the hints conveyed in this paper, will immediately discover the best methods of applying them to experiment. Those methods which I take the liberty of noticing are simple, and such as I have partially submitted to trial.

The obvious principles which require attention in both the adaptations recommended are, to immerse the object-face of the prism into the cone of distinct rays which issue from the eye-glass of the other instrument, further than is permitted by the usual eye-piece; and to allow a close approach of the eye to the upper surface of the prism. These precautions evidently tend to secure a sufficient extent to the field of view.

The graphic microscope would perhaps be constructed in the best manner by attaching a single microscope to the object-face of the prism. The appendages of pliers, &c. might be made applicable to the shaft or style of the camera. The vertical structure, and other properties of the compound microscope, present obstacles which it would not be easy to surmount. And the solution of these difficulties is the less necessary on account of the facility afforded by the construction of the camera lucida itself, for enlarging or contracting the dimensions of the apparent image at pleasure.

In the telescope the perforated cylindrical cap, which is screwed over the eye-glass, may be exchanged for a shorter, conical, or cuneiform cap, having a larger aperture. This cap might carry an arm, perforated to admit the axis of the prism. A still preferable method is, to take off the perforated cap, and attach a hollow tube to the side of the eye-piece. In this tube, which must of course be shorter than that in which the stem of the camera slides, a similar stem must be inserted bearing the prism: in short, the original instrument, cut off at one third of its length, must be attached to the tube which contains the eye-glasses of the telescope. The telescope being adjusted to a proper focus, and the stem of the camera drawn out to a due length, and turned, to bring the prism opposite the axis of the telescope, the aperture of the eye-piece of the prism being also placed in such a manner as to exclude, if requisite, the superfluous rays; the objects toward which the instrument is directed will appear, on looking through the prism, to be

distributed over the paper which is placed to receive the design. It will be necessary to support the paper as nearly as possible parallel to the axis of the telescope.

If you judge these observations deserving of public diffusion, they are much at your service; and a candid notice of them in your Journal, will oblige,

Sir, your most obedient servant,

W. G. HORNER.

## ARTICLE VI.

*An Attempt to systematize Anatomy, Physiology, and Pathology.*  
By Alexander Walker.

(To Dr. Thomson.)

SIR,

THE value you yourself have attached to the systematization of chemistry convinces me that you will not view with disregard a similar attempt in anatomy. To you I need not say that the placing on the title-page of a work the word "System," does not convert the ill-arranged facts and reasonings of any science into a real system. That word expresses the arrangement of these facts and reasonings according to their natural relations; and in that sense there is certainly no system of Anatomy. In that science, the discovery of these natural relations has long been an object of my investigation; and the views I have taken in the present paper being to me more satisfactory than any which have hitherto suggested themselves to me, I shall be happy if they prove not unsatisfactory to your readers.

The arrangements of the present paper being intimately allied with, and in a great measure founded upon, the facts and reasonings contained in my Sketch of a General Theory of the Intellectual Functions of Man and Animals, inserted in two of your former numbers, *the simplicity, the accuracy, and the extensive applicability, of these arrangements, will afford the best and most striking proof at once of the truth and of the originality of that theory.*

It is unquestionable that a correct arrangement of anatomy and physiology, or rather of the organs and functions which they consider, ought to indicate, at a single glance, the relations of all these organs and functions to, and their dependence upon, each other. Yet is this principle uniformly violated by the best anatomical and physiological writers.

A single remark will at once point out the errors of arrangement which I deprecate, and show the originality of the plan which I propose. It is evidently unnatural to consider the brain before the organs of sense whence impressions are transmitted to it; the organs

of generation, before the glands whence they derive the generative liquid; the glands, before the arteries whence is received the liquid they transmute; the arteries, before the heart which is the source of the blood they circulate; the heart, before the absorbents whence the materials of the blood—the chyle and lymph, are derived; the absorbents, before the stomach where is digested the food whence the chyle and lymph are elaborated; or the muscles, before the ligaments, by which their motions are limited, and without which they cannot be understood. Yet are more or less of these errors committed by Soemmerring, Blumenbach, Hildebrandt, Winslow, Sabatier, Cuvier, Chaussier, Boyer, Dumas and all the best anatomical and physiological writers.

Nor is this all: not only do they, with regard to the organs and functions, reverse, often to a great extent, the order of their dependance, but they widely separate objects which are in nature closely connected, and blend together others which, belonging even to distinct classes, have little natural relation. If the arrangement of the author of the *Tables Synoptiques de l'Anatomie*, in particular, were to be considered, as all arrangement ought to be, namely, as indicating the relations and dependance of the functions, so absurd is it, that absorption, instead of the cause, would be the result, of nutrition; generation, the result of absorption; and digestion, the result of generation.

Thus by arranging effects in the place of causes do physiologists confound the relations of the functions, and reverse the very order of their dependance.

The general arrangement of the functions into external, relative, or animal, and internal, assimilating, or vegetative, as anciently proposed by Aristotle, and successively adopted by Buffon, Grimaud, and Richerand, is replete with error.

For, first, under the term external, relative, or animal functions, are thus involved, not only the intellectual actions, consisting of sensation, thought and volition, but the locomotive actions by which we move from place to place; yet these actions differ from each other in every respect. *They do not resemble each other in their intimate nature*; for the intellectual take place longitudinally,\* and are altogether invisible; while the locomotive are performed angularly by means of levers,† and are of the most conspicuous kind. *Neither do they agree in being both external*; for the locomotive can alone be considered so, while the intellectual are as internal as the animal or vital, on which these physiologists have improperly conferred that epithet. True it is that the eye and the ear, which are intellectual organs, receive impressions from external objects; but so do the absorbent surfaces, which are vital organs. If it be urged that the absorbed matter is carried inward to the heart, so must it

\* In the tubes of the neurilema.

† The bones.

be replied are the sensations to the brain; and if it be argued that from the brain volitions are propagated externally, so must it be rejoined are secretions from the circulating system.

*Thus the first error of this method is to bring under one head, organs and functions which are totally distinct. The second is to separate others which are altogether similar.* For while Richerand places in one class the organs and functions mentioned above, he places those of generation in another. Now from those which I have above termed vital, these do not differ either in their intimate nature or in their general object. The vital organs are all *tubular*, and the action of all is the *transmission* and transmutation of *liquids*: the generative organs are all also *tubular*, and all of them also are employed in similar *transmission* or transmutation. The general object of the vital actions is the maintenance of life; that of the generative is its propagation: in this only do they differ. They may therefore be different orders of the same class: they cannot form different classes.

Such, as its inspection will testify, are the great and general errors of the system of Richerand. Less important ones are numerous.



I consider the system of Bichat after that of Richerand, because, though it may have had the precedence in publication, and the merit or demerit of that peculiarity which is common to both, yet, being more detailed and minute, it involves a greater number of errors, and is moreover connected with a doctrine respecting certain simple organic textures, which demands particular consideration.

First, I may remark, that all the great and general errors—the involving in one class the intellectual and locomotive functions, and the forming a separate class of the generative ones, committed by Richerand,—are likewise committed by Bichat, by whom the internal or assimilating functions of Richerand, &c. are termed organic.

While such great and general errors as these pervade the system of Bichat, I need scarcely mention that he improperly places absorption after circulation; nor need I dwell on minuter considerations.

As to his simple organic textures, he has chiefly derived them from Malacarne, who seems first to have set the example of this ridiculous method which, by distributing the body into common systems, general systems, universal systems, and partial systems; and by dividing and subdividing these with a profusion which sets at utter defiance the most felicitous memory, has, instead of simplifying, inextricably embarrassed, the study of anatomy. This writer, Bichat has been ambitious to rival in his *Anatomic Générale*, where the mania of subdivision, guided by the most superficial reflection, and urged with the most impertinent verbiage, has made as many systems in the body as there are organs.

Not even contented with one system for a set of organs, he makes

two out of it; and has accordingly two muscular and two nervous systems! He has a *particular* system for cartilages, *another* for tendons and ligaments, and a *third*, which holds a *middle* sort of place between these two! He has not merely a system for the *bones themselves*, but a synovial system at *their extremities*, and a medullary system *within them*! He has a pilous or *hairy* system on the surface of the body, a dermal or *skinny* system, and an epidermal or *scarp-skin* system! Curiously enough this last of his *organic* systems is an *inorganic* substance, destined to preserve organic parts from the immediate contact of external objects: it possesses neither life nor sensibility; and he might as well have ranked among the number of his organic systems the layer of paint which covers the skin and envelopes *all the systems* of the native American.

Unsatisfied, however, with his imaginary simple systems, Bichat has created as many simple functions. His animal life and organic life, animal sensibility and organic sensibility, animal contractility, organic sensible contractility, organic insensible contractility, and a multitude of others, will satisfy those who believe in them that they who ascribe nine lives to some of the feline genus have only fallen short, instead of exceeding the number; and will to others afford only another proof that confusion and error never yet were separated.

Respecting his plan, I have only to add, that his *Anatomic Générale* presents the most signal abandonment of nature, and of its best characteristics—simplicity and intelligibility. If Kant had wished to do for physiology the same sort of *service* he has done for metaphysics, he could not have done it more completely than M. Bichat, who has so nicely perplexed the science as often to alarm the young for their own incapacity, and to satisfy the old of its author's.



One of the most striking ill consequences of this want of arrangement is the difficulty which not only the student, but even the experienced anatomist, feels, of obtaining for himself, or communicating to another, any short and simple notion of the animal organs and functions.

A simple notion of a complex subject can be obtained or communicated only by means of generalization; and if this be abandoned, it cannot be obtained or communicated at all. In anatomy and physiology such generalization is not even attempted; the organs and functions are enumerated in an insulated, irregular and disorderly manner; and neither the person who makes the enumeration, nor he who hears it, is often satisfied that he has enumerated the whole.

If an anatomist be asked to give a short account of the structure of the body by enumerating its various organs, he tells you that it consists of bones, and muscles, and ligaments, and arteries, and veins, and nerves, and glands, and a brain, and organs of sense, (not

perfectly recollecting any more, he perhaps adds)—and of various viscera.\* If you wish to know what these viscera are, he probably tells you that they are such parts as the heart and lungs, the stomach and the intestines; and in innumrating these intestines, which he finishes with the *rectum*, he perhaps adds, that the *brain* also, and the eye, and the ear, are called viscera—that, in short, it is a name expressing many objects of *that kind*, which it is unnecessary for him to enter into a minute detail of. Perhaps, after all, he recollects that in enumerating the organs, he *might* indeed have mentioned some such parts as absorbents, and cartilages, and membranes, and so forth—in fine, rather perplexed, and slightly ashamed—he scarce knows why—of the account he has given, he in general very properly adds, that *such* enumerations are of no great use, and that, in order to understand any thing of anatomy, it is necessary to enter into a particular study of it.

True it is, that such enumerations (and the very best which are given in books are no better) can be of no use. But it is not less true that, in fewer words, as will be seen in the sequel, a very simple and satisfactory notion may be given of the animal system.

The developement of the relations of the organs and functions to, and of their dependance upon, one another, is the basis of the system I propose.

In viewing, then, the organs in a general manner, a class at once obtrudes itself, from its consisting of an *apparatus of levers*, from its performing motion from place to place, or *locomotion*, and from these motions being of the most *obvious kind*.—A little more observation presents to us another class, which is distinguished from the preceding by its consisting of *cylindrical tubes*, by its transmitting and transmuting liquids, or performing *vascular action*, and by its motions being *barely apparent*.—Further investigation discovers a third, which differs essentially from both these, in its consisting of *nervous particles*, in its transmitting impressions from external objects, or performing *nervous action*, and in that action being *altogether invisible*.

Thus each of these classes is distinguished from another by the **STRUCTURE** of its parts, by the **PURPOSES** which it serves, and by the greater or less **OBVIOUSNESS** of its motions. The first consists of *levers*; the second, of *cylindrical tubes*; and the third, of *nervous particles*. The first performs motion from place to place, or *locomotion*; the second, transmits and transmutes *liquids*, or performs *vascular action*; and the third, transmits *impressions* from external objects, or performs *nervous action*. The motion of the first is *extremely obvious*; that of the second is *barely apparent*; and that of the third is *altogether invisible*.

Not one of them can be confounded with another: for that which

\* This is a term so absurdly applied, as to admit of no useful definition.

performs locomotion neither transmits liquids nor sensations; that which transmits liquids neither performs motion from place to place, nor is the means of sensibility; and that which is the means of sensibility neither performs locomotion nor transmits liquids.

Now the organs employed in LOCOMOTION are the *bones, ligaments* and *muscles*; those employed in transmitting LIQUIDS are the *absorbent, circulating* and *secreting vessels*; and those employed about SENSATIONS are the *organs of sense, cerebrum* and *cerebellum*, with the nerves which connect them. The first class of organs may therefore be termed locomotive or (from their very obvious action) mechanical; the second, vascular, or (as even vegetables from their possessing vessels have life) they may be termed vital; and the third may be named nervous or intellectual.

Mechanical action, indeed, appears to be only less minute than vital action; and it is probable that nervous, as well as chemical, action are only yet more evanescent. All the organs and functions, therefore, may perhaps be termed mechanical. But whether this be so or not is of little consequence in this case; since, in adopting these terms, I mean them merely to express the obvious and important distinctions which are mentioned above.

An arrangement of anatomy and physiology, however, according to a precise dependance of these systems, is not possible: for, though the nervous system, being considerably independent of the muscular and vascular, might with this view be placed first, yet we cannot, consistently with maintaining this precise order, next mention the muscular, because all muscular action is in a certain measure dependant on the action of vessels; nor can we next mention the vascular, because all vascular action is in a certain measure dependant on the action of muscles. In short, in animals all the systems influence one another, just as in vegetables the two which exist in them—the mechanical and vital, are reciprocally affected.

The order, then, of greatest independence, is that which places the mechanical organs first, because in minerals, the simplest beings, where mechanical structure alone exists, it is uninfluenced by any vital; the vital organs next, because in vegetables—the beings next in complexity, they are uninfluenced by any intellectual; and the intellectual last, because they exist only in animals. This, then, is the order of their greatest independence.

The advantages of this arrangement are, first, its enumerating the organs in the order of the obviousness of their functions: secondly, its enumerating them in the order of the three natural classes of beings—minerals having mechanical structure; vegetables, mechanical and vital; and animals, mechanical, vital and intellectual: thirdly, its connecting this portion of science with science in general; for, from the mechanical and vital organs, common to animals with the inferior classes, we pass through the intellectual which are proper to them, to the consideration of intellect itself, and of those signs of ideas which language affords. Thus we pass naturally from the last of the physical sciences, considering the



structure of beings gradually increasing in perplexity, through the portions of anatomy and physiology, to the first of the literary and moral ones.

The disadvantages which would result from the abandonment of this order of the organs would be, that we should lose sight of this natural independence, that we should reverse the order of the obviousness of the functions, and that their reference to the three natural classes of beings, and their relations to science in general, would altogether disappear—that the sciences of anatomy and physiology would at once be insulated and deranged.

The human body, then, consists of organs of three kinds. By the first kind, motion from place to place, or mechanical action, is effected; by the second, nutrition, or vital action, is maintained; and by the third, thought, or intellectual action, is permitted. ANATOMY I therefore divide into three parts; namely, that which considers the mechanical or locomotive organs, that which considers the vital organs, and that which considers the intellectual organs.

Under the mechanical or locomotive organs, I class, first, the bones, which support the rest of the animal structure; second, the ligaments, which unite them; and third, the muscles, which move them.

Under the vital organs, I class, first, the external and internal absorbent surfaces, and the vessels which absorb from these surfaces, or the organs of absorption; second, the heart, lungs, and blood-vessels, which derive their contents (the blood) from the absorbed lymph, or the organs of circulation; and third, the glands and secreting surfaces, which separate various matters from the blood, or the organs of secretion.

Under the intellectual organs, I class, first, the organs of sense, where impressions take place; second, the cerebrum, or organ of thought, where these excite ideas; and third, the cerebellum, where volition results from the last.

To some it may appear that the organs and functions of digestion, respiration and generation, are not involved by this arrangement; but such a notion can originate only in superficial observation. Digestion is a compound function easily reducible to some of the simple ones which I have enumerated. It consists of the motion of the stomach and contiguous parts, of the secretion of a liquid from its internal surface, and of that heat which is the common result of all action, whether locomotive, vital, or intellectual, and which is better explained by such motion than by chemical theories. Similarly compound are respiration and generation.

Thus there is no organ nor function which is not involved by the simple and natural arrangement I have sketched.

Compound, however, as the organs of digestion, respiration and generation, are, yet as they form so important a part of the system,

it may be asked, "with which of these classes they are most allied?" The answer is obvious. All of them consist of tubular vessels of various diameter; and all of them transmit and transmute liquids. Possessing such strong characteristics of the vital system, they are evidently most allied to it.

In short, *digestion prepares* the vital matter, which is taken up by absorption—the first of the simple vital functions; *respiration renovates* it in the very middle of its course—between the two portions of the simple function of circulation; and *generation, dependant on secretion—the last of these functions, communicates* this vital matter, or propagates vitality to a new series of beings. In such arrangement the digestive organs therefore precede, and the generative follow, the simple vital organs; while the respiratory occupy a middle place between the venous and the arterial circulation. Nothing, however, can be more improper, as the preceding observations show, than considering any one of these as a distinct class.

The preceding is a natural arrangement of the anatomy of man and the higher animals; and its peculiar simplicity is illustrated by its involving, in application, that of minerals and vegetables, and by its being capable of instant adaptation to physiological science.

In order to arrange animal **PHYSIOLOGY**, it is only necessary to substitute the term "functions" for "organs;" and that science will likewise involve, in application, the physiology of mineral and vegetable bodies, and be in its turn capable of instant adaptation to medical science.

Thus the functions also are divided into mechanical, vital, and intellectual.

The mechanical functions are subdivided into that of support, that of connexion, and that of locomotion.

The vital functions are divided into that of absorption, that of circulation, and that of secretion.

The intellectual functions are divided into that of sensation, that of mental operation, and that of volition.

A circle of functions, I may observe, thus exist in animals, which exist not in minerals or vegetables, because volition, the last of the intellectual functions, connects itself to the mechanical ones by rendering them subservient to it in locomotion. Thus the first and the last of these functions are as intimately connected as any of the intermediate ones, and a beautiful circle of organic function and organic influence is formed.

Thus, then, there are three orders both of organs and functions—the locomotive, the vital, and the intellectual; and of each of these orders there are also three genera, namely, of the first or locomotive, those organs and functions which support, connect, and move; of the second, or vital, those which absorb, circulate, and secrete;

and of the last, or intellectual, those which feel, think, and will; and by the latter of these the former is in locomotion affected.

In order to arrange **PATHOLOGY**, for the term "healthy functions," the subject of physiology, it is only necessary to substitute the term "diseased functions."

The classes of disease are, therefore, like those of anatomy and physiology, three; namely, diseases of the mechanical or locomotive functions, diseases of the vital functions, and diseases of intellectual functions.

The orders of the first class, as affecting the functions of the bones, the ligaments, and the muscles, are three, viz. diseases of support, diseases of connexion, and diseases of locomotion.

Those of the second class, as affecting the functions of the absorbent, the circulating, and the secreting, vessels, are likewise three, viz. diseases of absorption, diseases of circulation, and diseases of secretion.

Those of the third class, as affecting the functions of the organs of sense, of the brain, and of the nerves, are also three, viz. diseases of impression, diseases of judgment, and diseases of volition.

The genera under each order consist of diminished, depraved, and increased, functions.

Precisely in the same way would I class the articles of the **MATERIA MEDICA**; first, as operating upon the mechanical, vital, or intellectual, organs; and then as either increasing, rendering regular, or diminishing their action.

It is not unusual to consider the body as being divided into the head, the trunk, and the extremities; but in consequence of the hitherto universal neglect of the natural arrangement of the organs and functions into mechanical, vital, and intellectual, the beauty and interest which may be attached to this division has equally escaped the notice of anatomists.

It is a curious fact, and strongly confirmative of the preceding arrangements, that one of these parts—the extremities, consist almost entirely of mechanical organs, namely, of bones, ligaments, and muscles; that another—the trunk, consists of all the greater vital organs, namely, absorbents, blood-vessels, and glands; and that the third—the head, contains all the intellectual organs, namely, the organs of sense, cerebrum, and cerebellum. In perfect consistency with my assertion, "that though the organs of digestion, respiration, and generation, were really compound, still they were chiefly vital, and properly belonged to that class," it is not less remarkable that in this division of the body they are found to occupy that part—the trunk, in which the chief simple vital organs are contained.

This also shows the impropriety of reckoning any of these a separate system from the vital.

It is a fact not less curious, nor less confirmative of the preceding arrangements, that of these parts those which consist chiefly of mechanical organs—organs which, in the sense already explained, are common to us with the *lowest* class of beings, namely, minerals,\* are placed in the *lowest* situation, namely, the extremities; that which consists chiefly of vital organs—organs common to us with a *higher* class of beings, namely, vegetables, † is placed in a *higher* situation, namely, the trunk; and that which consists chiefly of intellectual organs—organs peculiar to the *highest* class of beings, namely, animals, ‡ is placed in the *highest* situation, namely, the head. . . . It is not less remarkable, that this analogy is supported even in its minutest details: for, to choose the vital organs contained in the trunk as an illustration, it is a fact that those of absorption and secretion, which are most common to us with plants—a *lower* class of beings, have a *lower* situation—in the cavity of the abdomen; while those of circulation, which are very imperfect in plants, § and more peculiar to animals—a *higher* class of beings, hold a *higher* situation—in the cavity of the thorax.

It is moreover worthy of remark, and still illustrative of the preceding arrangements, that in each of these three situations the bones differ both in position and in form. In the extremities they are situated internally to the soft parts, and are generally of cylindrical form; in the trunk they begin to assume a more external situation, and a flatter form, because they protect vital and more important parts, which they do not, however, altogether cover; and in the head they obtain the most external situation and the flattest form, especially in its highest part, because they protect intellectual and most important organs, which in some parts they completely invest.

The loss of such general views is the consequence of arbitrary methods. They did not present themselves to me till I had traced this outline of the natural system.

ALEXANDER WALKER.

\* The bones, moreover, contain the greatest quantity of mineral matter.

† It is the possession of vessels which constitutes the vitality of vegetables.

‡ In animals alone is nervous matter discoverable.

§ Plants have no real circulation, nor passage of their nutritive liquid through the same point.

## ARTICLE VII.

*Astronomical and Magnetical Observations at Hackney Wick,  
By Col. Beaufoy.*Latitude, 51° 32' 40.3" North. Longitude West in Time 6<sup>h</sup>  $\frac{8.2}{100}$ .Sept. 12, immersion of a small star in Sagittarii, 8<sup>h</sup> 59' 04" Mean Time at H. W.*Magnetical Observations.*

1815.

Month.	Morning Observ.			Noon Observ.			Evening Observ.		
	Hour.	Variation.		Hour.	Variation.		Hour.	Variation.	
Aug. 18	8 <sup>h</sup> 20'	24°	15' 23"	1 <sup>h</sup> 15'	24°	23' 40"	6 <sup>h</sup> 50'	24°	17' 45"
Ditto 19	—	—	—	1 50	24	23 40	—	—	—
Ditto 20	8 35	24	16 24	1 30	24	25 41	6 55	24	18 48
Ditto 21	8 15	24	16 42	1 15	24	25 47	6 55	24	18-08
Ditto 22	8 20	24	15 45	1 55	24	24 54	—	—	—
Ditto 23	8 25	24	13 16	1 55	24	23 34	6 50	24	17 15
Ditto 24	8 35	24	15 38	—	—	—	—	—	—
Ditto 25	8 35	24	15 24	1 40	24	23 32	6 55	24	17 25
Ditto 26	8 35	24	14 42	—	—	—	6 45	24	18 19
Ditto 27	8 25	24	18 08	1 30	24	23 06	6 50	24	17 53
Ditto 28	—	—	—	1 40	24	24 12	—	—	—
Ditto 29	8 35	24	15 14	—	—	—	6 50	24	19 34
Ditto 30	8 40	24	15 18	1 55	24	21 46	6 45	24	18 05
Ditto 31	8 30	24	17 18	—	—	—	—	—	—

*Magnetical Observations continued.*

1815.

Month.	Morning Observ.			Noon Observ.			Evening Observ.		
	Hour.	Variation.		Hour.	Variation.		Hour.	Variation.	
Sept. 1	8 <sup>h</sup> 20'	24°	16' 54"	1 <sup>h</sup> 35'	24°	25' 22"	6 <sup>h</sup> 45'	24°	14' 26"
Ditto 2	8 25	24	17 04	—	—	—	—	—	—
Ditto 3	8 25	24	15 15	1 25	24	22 26	6 20	24	17 31
Ditto 4	8 25	24	14 45	1 40	24	26 29	6 40	24	17 03
Ditto 5	8 20	24	13 57	1 45	24	23 17	6 25	24	18 07
Ditto 6	8 3	24	14 33	1 30	24	22 40	6 30	24	18 22
Ditto 7	8 40	24	17 06	1 35	24	22 47	—	—	—
Ditto 8	8 30	24	16 08	1 15	24	25 27	6 25	24	18 22
Ditto 9	8 30	24	15 36	—	—	—	6 30	24	19 33
Ditto 10	8 15	24	15 58	1 20	24	21 40	6 25	24	15 59
Ditto 11	8 40	24	17 42	—	—	—	6 20	24	17 42
Ditto 12	8 25	24	15 24	1 40	24	22 43	—	—	—
Ditto 13	8 25	24	15 08	—	—	—	—	—	—
Ditto 14	8 25	24	14 34	1 45	24	23 22	6 30	24	17 19
Ditto 15	8 30	24	15 50	1 40	24	21 47	6 20	24	17 39
Ditto 16	8 25	24	13 17	1 30	24	23 29	6 20	24	17 23
Ditto 17	8 30	24	15 00	1 30	24	23 17	6 15	24	17 08

## Comparison of Observations.

		1813.	1814.	1815.
April.....	Morning .....	24° 09' 18"	24° 12' 53"	24° 16' 01"
	Noon .....	24 21 12	24 23 53	24 27 42
	Evening.....	24 15 25	24 15 30	24 17 48
May .....	Morning .....	24 12 02	24 13 12	24 16 32
	Noon .....	24 20 54	24 22 13	24 27 03
	Evening.....	24 13 47	24 16 44	24 19 12
June.....	Morning .....	24 12 35	24 13 10	24 16 11
	Noon .....	24 22 17	24 22 48	24 27 18
	Evening .....	24 16 04	24 16 29	24 19 40
July .....	Morning .....	24 14 32	24 13 29	24 15 51
	Noon .....	24 23 04	24 23 44	24 25 45
	Evening.....	24 16 43	24 17 00	24 19 42
August....	Morning .....	24 15 55	24 14 13	24 16 01
	Noon .....	24 23 32	24 23 48	24 24 07
	Evening.....	24 16 08	24 16 31	24 18 22

Rain fallen { Between noon of the 1st Aug. } 1.845 inch.  
 { Between noon of the 1st Sept. }  
 Evaporation during the same period .....3.420

*Errata in the last Number of the Annals of Philosophy.*

In the remarks on the variation, after the words "the morning and noon observations," insert "on the 20th."

## ARTICLE VIII.

## ANALYSES OF BOOKS.

*The Literary and Scientific Pursuits which are encouraged and enforced in the University of Cambridge briefly described and vindicated: with various Notes.* By the Rev. Latham Wainewright, A. M. F. A. S. of Emmanuel College, in that University, and Rector of Great Brickhill, Bucks. London. Hatchard. 1815.

THE outcry which has been raised against the English universities, and the very general opinion entertained for some time past that they are rather theatres of dissipation than of learning and science, have been attended with several good effects. They have produced, it is said, a reform in Oxford, where the defects, if we believe Gibbon, and some others who have written on the subject, were great, and almost intolerable: and this reformation, if our information respecting that University be correct, might be carried still further, with considerable advantage to the young men who frequent it. They have occasioned likewise the present publication, which makes us acquainted with the mode of education followed at Cambridge, the sister University, long celebrated for the attention which she pays to mathematics and the mechanical sciences.

Though this little work was intended by its author as a full account of the mode of education followed at Cambridge, and though we have no doubt that it is written with as much candour as is consistent with the character of a professed eulogist, we regret that several circumstances are omitted which would have been requisite to convey to us, who are quite unacquainted with the forms of English Universities, an adequate idea of the value of the information which is communicated to the young men by the tutors. In the Universities of Scotland, and we believe in all those on the continent of Europe, every science taught is confined to a particular individual, who is called the *Professor* of that science, and whose business it is to collect a correct outline of the whole department of knowledge committed to his charge, and to lay the best arranged and most luminous view of it, which he can, before his pupils. But in the English Universities the case is very different. In every college a certain person is appointed under the name of *tutor*, under whose care the students at that college are placed, and to whom they are indebted for all the academical information which they receive. Now in order to form a judgment of the way in which these tutors are likely to discharge their duty (on which every thing depends), it would be requisite to know whether one tutor teaches all the sciences, or whether a particular tutor be appointed for each particular science; whether the tutor receives any fees from his pupils, and whether his emoluments depend chiefly at least upon the number of students that enter his particular college. Now upon these very material points no information whatever is communicated by Mr. Wainewright.

If every college is restricted to only one tutor, the probability, or almost the certainty, is, that he will have a stronger bias to one department of knowledge than to the others. The three great departments which constitute the range of a Cambridge education are, 1. Latin and Greek, including Belles Lettres. 2. Mathematics, and the Mathematical Sciences. 3. Metaphysics, Morals, and Theology. Now it is very unlikely that a thorough Greek and Latin scholar, or a professed poet or critic, should at the same time be a good mathematician and a profound metaphysician. Who ever heard of a poetic mathematician? Unless Halley and Bosovich are to be considered as examples. Now to whatever science the tutor has particularly attached himself, there is every reason to suppose that to it he will naturally turn the chief attention of his pupils, and that the information which he has to communicate on the other branches of knowledge will be comparatively of little value. Hence the probability is, that whatever branch of knowledge has become fashionable in the University, to that branch the attention of the students will be generally directed. I conceive this to be the reason why Greek and Latin constitute the chief objects of study at Oxford, and mathematics at Cambridge. I once met with an Oxford student in a stage-coach, a very young man, who



told me that for his part he would rather enjoy the reputation of Porson than that of Newton.

If there be a tutor appointed for every particular science at Cambridge, the objection which I have stated will be obviated; but unluckily Mr. Wainewright has given us no information whatever on the subject.

If the emoluments of the tutor depend upon the number of students attending his particular college, and if that number be determined by the reputation of the tutor, then it is obvious that a strong motive is held out to him to discharge his duty as faithfully as possible; because the higher his reputation, the greater will his income become. The salaries of the medical professors at Edinburgh (excluding two or three late appointments by the Crown) amount to 20*l.* a year divided among five individuals, or 4*l.* per annum each. Hence their whole emoluments depend upon their students. If they neglect their duty, they will be sure to lose their class, and then the Professor's chair will not be worth filling. But if the income of the Cambridge tutors does not depend upon their pupils, if they receive the same sum whether they do their duty or not, whether the number of their pupils be great or small, then in that case the powerful feeling of self-interest will be wanting to stimulate their exertion, and the chance of indolence and carelessness will be greatly enhanced. The indolence of the established clergy has long been proverbial, while the activity of the dissenting clergy has always been conspicuous, because their success in life depends upon the opinion entertained of them by their hearers.

It would have been very desirable if Mr. Wainewright had conveyed information to us upon these two most material points, because upon them the value of Cambridge as a place of education must chiefly depend.

Another piece of information scarcely less important is also wanting. We should have been told how great a portion of each year it is necessary for the student who means to reap the proper advantages of the institution to reside at Cambridge. I have known some persons keep their terms, as it is called, and yet reside but a very short part of the year at an English University. If this be a common practice, or if it may be followed by every person *ad libitum*, it is obvious that the University is converted in a great measure into a mere political establishment.

But perhaps the most important information of all is the sum of money per annum which a student at Cambridge requires to put him on a footing with his associates. I have been told by a young Gentleman, a friend of mine, a student at Cambridge, that 300*l.* a-year was the least that he could ever spend. Suppose this to be considerably above the minimum, it may serve to give us some idea at least of the style of life which the generality of the students lead. Now a moment's reflection must convince any person that if a young man resides part of the year at Cambridge, and spends during that time

300*l.*, his mind must be taken up about something else than study otherwise the fees exacted must be shamefully and improperly high. I consider the cheapness of education as the most important advantage which any nation can possess. No people can ever make a figure in science or literature if the terms of education are so high that it is necessarily confined to the higher ranks of society; because proficiency in science is the result of long and laborious exertion, which few will be capable of making who already feel themselves sufficiently distinguished by their rank or their wealth. If we take a view of the literary characters who have given lustre to Great Britain, how small a number shall we find who had either rank or wealth to boast of? Have they not in general risen from the lower ranks of society? Nature endowed them with talents, accident gave them the requisite education; and that noble emulation, that desire of distinction so strongly attached to genius and talents, urged them on to exert the requisite industry, and emerge from the obscurity in which chance had placed them.

During each of the years 1788, 1789, and 1790, I resided six months at the University of St. Andrews: my expenses during each year (including every thing) did not exceed 14*l.* The next ten years I spent at the University of Edinburgh. Here my expenses were greater, because I resided in that city during the whole year, and because I had to pay for lodgings, which was not the case at St. Andrews. But even in Edinburgh the annual expenditure did not exceed 50*l.* It will be higher at present in both places; because the prices of every thing have risen greatly since the period to which I allude. But even at present I should consider 30*l.* or 40*l.* a sufficient allowance for St. Andrews, and 100*l.* for Edinburgh.

Perhaps indeed it is of more importance that the grammar school education should be cheap and accessible to all; because here the boy of genius becomes first aware of his talents, and feels the charms that attend the acquisition of knowledge. These charms are so powerful, and the new views which education opens so efficacious, that when a boy has once felt their influence he will make wonderful exertions to enable him to advance in the same career. I know a Gentleman who at present makes a very respectable figure in the literary world, and enjoys a very handsome income. He was the son of a hind in the south of Scotland. During summer he hired himself out to the farmers, and during winter put himself to school with the money which he had thus earned. By degrees he got the situation of a parish schoolmaster; and continuing his assiduity, and rising by slow progression, he now occupies one of the most lucrative literary situations which Scotland possesses. I might mention other instances of a similar nature. A poor Berwickshire boy was in the habit of travelling during the summer as a pedlar, and during the winter he put himself to school with the fruits of his summer's earnings. In this manner he contrived to give himself an excellent education. He then set out for London to push his fortune. His first situation in that capital was that of porter to a bookseller. This

gentleman had two sons learning mathematics, and the new porter made out for them some exercises which were very much applauded. An inquiry was made, the qualifications of the porter were discovered, the bookseller recommended him to some friends whom he had in a particular University. He went, and was enabled by the kindness of those gentlemen to complete his education; and he now fills a most respectable literary situation in England.

Nor let it be supposed that the money requisite for these purposes was great. I myself was educated at one of the best grammar schools of Scotland; and the whole expense of my grammar school education amounted exactly to 30*s.*, of which I myself afterwards paid 20*s.* after I had grown up, and had begun to provide for myself. I think it will be admitted that in proportion to the population of the two countries, there is at present a greater number of literary Scotchmen than Englishmen. Now the sole reason of this difference is the cheapness of education in Scotland, and the existence of a grammar school in every parish. The meritorious exertions of the promoters of the Lancasterian schools in England will probably soon destroy this difference, at least in part; though I am apprehensive that they scarcely go far enough. The mere knowledge of reading and writing is very valuable; but the principles of morality and religion are not less so; because wherever they are wanting, knowledge proves rather a bane than an advantage. It is much to be wished, likewise, that means were taken to distinguish those children who happen to be possessed of uncommon genius, and to afford them the requisite facilities for completing their education.—But this digression has been carried far enough.

The subjects taught at the University of Cambridge are divided by Mr. Wainwright into three heads; namely, Classics and General Literature; Natural Philosophy and Mathematics; Moral and Political Philosophy, Metaphysics and Theology.

1. During that part of each term which requires attendance, the classics are regularly read. They consist of the Greek tragedies, Plato, Herodotus, Thucydides, Aristotle's Poetics, Cicero, Tacitus, &c. These books are not barely read; but the peculiarities of expression, the beauties of diction, the singularities of construction, the prosody—every thing of importance is pointed out by the tutor to the attention of the young men, so as to render them not merely accurate linguists, but scholars and critics.

There are 14 scholarships or exhibitions in Cambridge; and in filling them more regard is paid to proficiency in Greek and Latin than in mathematics. Various annual prizes exist for declamations in Latin and English, themes, poems, &c.; all of which have a tendency to excite emulation, and to promote the cause of general literature. Finally, there are examinations twice a year, which are conducted with rigour and impartiality.

2. Very particular attention is paid in Cambridge to natural philosophy and mathematics. As the young men have seldom any previous knowledge of these branches of science when they go to the

University, the tutors find it necessary to commence at the very beginning. The branches of mathematics taught are, geometry, trigonometry, algebra, conic sections, fluxions; and the four mathematical departments of mechanical philosophy, namely, astronomy, optics, hydrodynamics, mechanics. Professors Vince and Wood have drawn up text books for these different departments, which save a great deal of trouble, both to the tutors and pupils. Finally, Newton's *Principia* is thoroughly studied and explained. Mr. Wainewright explains at considerable length the nature of the public examinations which take place before the distribution of degrees, shows the prodigious emulation which they excite, and the great advantages with which they are attended. I have no doubt whatever that these disputations are of considerable service, and occasion the acquisition of much useful and important knowledge, and the development of abilities which would otherwise have lain dormant.

The present scarcity of eminent mathematicians in Great Britain has been wondered at by some persons, and Mr. Playfair has ascribed it to the mode in which mathematics is taught at Cambridge. Mr. Wainewright endeavours to refute this opinion. I have no doubt myself that it is to be assigned to another cause, or rather to a variety of other causes. One cause is the kind of education to which those taught in the great grammar schools are exclusively confined. I mean Greek and Latin. I have met with an excellent classical scholar from an English school, near 20 years of age, who could not repeat the multiplication table. Unless the drudgery of algebraic calculations is got over at an early age, we can scarcely expect the generality of mankind to acquire much dexterity in it; for my readers, I presume, are aware that it is in a great measure a mechanical art. That a knowledge of Greek and Latin is of considerable importance to every literary man, is what every person will very readily allow. They afford us the finest models of style and composition, and furnish much valuable information in history, mathematics, and moral philosophy. But to consider a knowledge of these languages as constituting the whole of a liberal education, appears highly preposterous. A knowledge of arithmetic alone is of more real service to every man than all the Greek and Latin which the most profound scholar ever possessed. Arithmetic and mathematics ought to constitute a part of every school education, as well as Greek and Latin. They ought to be as assiduously taught, and considered as an equally necessary preliminary to a course at the University as Greek and Latin. If this were the case all over England, we should soon see a change in the figure we at present make as a mathematical nation. Many individuals of the first rate mathematical genius, who at present pass through life without being aware of their powers, would acquire the requisite preliminary knowledge, would become conscious of their qualifications, and would proceed the greatest length in that career thus happily opened. I need not say that mathematics constitutes a part of the early educa-

tion in France. To this circumstance entirely is to be ascribed the greater number of mathematicians which that country has lately produced than our own.

Another circumstance wanting in this country for the flourishing of mathematical science is a proper encouragement on the part of Government. In some departments of science the number of cultivators, or at least of amateurs, is so great, that a book published on them is pretty certain of selling at least sufficiently to defray its own expenses; so that a man may cultivate these departments, and lay his discoveries and observations on them before the world, without much risk of pecuniary loss. But this is far from being the case in mathematics. The number of readers in this department has always been so small that a mathematical book, unless indeed it be a school book, cannot be expected to defray its own expenses by the extent of the sale. The consequence must be that none but the rich can venture to publish in the higher department of mathematics. But unfortunately few rich men are likely to cultivate this difficult department of science, and still fewer are disposed to dedicate their wealth to the advancement of knowledge. Mathematicians, then, will in general be deterred from publishing, and of course have but little chance of acquiring that reputation which attends the successful cultivators of the other sciences. Thus the great, the principal stimulus to exertion is withdrawn. No wonder, therefore, that but few labourers venture to cultivate so rugged and unpromising a field.

In France, in Prussia, and in Russia, this formidable objection has been obviated by the scientific academies established in these countries. In them a certain number of mathematicians receive salaries, which leave them at liberty to devote the whole of their time to their favourite science; and the expense of their respective publications is defrayed by Government. Hence the great number of mathematical papers which fill the *Memoirs* of the Paris, Berlin, and Petersburg Academies, and the various mathematical discoveries which adorn the 18th century. In England the Royal Society indeed affords the means of publishing valuable mathematical papers free of expense. To that noble institution we owe all the mathematics that still lingers in Great Britain. But as the mathematicians in this country are obliged to provide for themselves without any assistance from Government, they are compelled to devote the greatest part of their time to the laborious occupation of teaching, or to the compilation of school books, and little leisure is left them for the cultivation of the higher branches of the science.

I have some reason to suspect that but little attention is paid at Cambridge to the recent mathematical improvements made upon the Continent; for I have met with some good mathematicians from Cambridge who were quite unacquainted with these improvements. At the same time I admit that I have met with others who were acquainted with them.

3. The third department of knowledge cultivated at Cambridge is moral and political philosophy, metaphysics and theology. The

text-books employed in these departments are Paley's Principles of Moral and Political Philosophy, and Locke's Essay. Mr. Wainewright informs us that the writings of Reid, Beattie, and Stewart, especially of the last, are also frequently referred to by the tutor, though their *singular* doctrine of *common sense* is far from being admitted. This singular doctrine to which our author alludes is this, that in the *science of mind*, as well as in every other, there are certain first principles or laws of human thought which cannot be proved, but must be taken for granted; otherwise the science itself cannot be established. One of these first principles is, that the *external world exists*. Dr. Reid, to whom alone we are indebted for this doctrine, gave these first principles the name of *common sense*, because they have been always admitted by the common sense of all mankind, while every person who rejects them is considered as a lunatic or madman. Say the English metaphysicians, we will not admit the existence of the external world as a first principle. We cannot indeed prove its existence, but we think it ought to be proved. If it cannot, the doctrine of Berkeley and Hume must be allowed to be sound. For my own part I want no evidence whatever of the existence of an external world, and would consider any attempt to prove it as silly trifling. We are so constituted that we must, whether we will or nor, give credit to the senses, and admit the information which they communicate as first principles. Such is the doctrine of Dr. Reid; and instead of being a singular doctrine, I will venture to affirm that it has been maintained by 999 thousandth parts of all mankind in every age. It is singular enough that, though I never met with any Englishman that would admit the truth of Dr. Reid's principles, I never found any one who seemed to be acquainted with these principles, or to have perused the works of this acute philosopher. Mr. Wainewright shows us that at Cambridge this ignorance is universal; for he says that the tutors refer especially to the writings of Dugald Stewart. Now Mr. Stewart is an elegant writer, and has illustrated the philosophy of Reid in a very beautiful manner; but he has made very few additions to it. In point of arrangement he is rather deficient, which injures considerably his writings as a whole. Tutors acquainted with the subject would rather refer to the original discoverer than to his illustrator and commentator.

Besides the knowledge communicated by the tutors, there are likewise lectures on the following subjects, which I presume the students are all at liberty to attend:—

On modern history.

On the laws of England.

On the Roman civil law.

On experimental philosophy.

On chemistry.

On the application of chemistry and natural philosophy to manufactures, agriculture, and the arts.



On mineralogy.

On anatomy.

On domestic medicine.

On theology.

Such, then, is a view of the knowledge which may be acquired at Cambridge: and every person will readily acknowledge that it is very considerable, and that a young man in such an University may very well lay a sufficient foundation for future eminence. One advantage must be still added, which I consider as more important than all the rest put together. Every student has free access to a library containing above a hundred thousand volumes, from which he may borrow ten books at once, merely by obtaining a Master of Arts' order. This advantage must give Cambridge a prodigious superiority over Oxford.

Had I not already extended this article beyond the requisite length, I should have wished to have noticed a few particulars which have always struck me as disadvantages attending the English Universities, though it would scarcely be possible to remove them, without introducing changes which could not easily be acceded to. I shall barely hint at one or two circumstances.

The English Universities were established during the dark ages when learning was confined entirely to the clergy. The consequence was, that the sole object in view seems to have been to form clergymen. Hence the numerous regulations which assimilate these Universities to Monasteries. A dissenter, I understand, cannot be admitted into them. Now though I admit that the education of the clergy is a very important point, yet I think that the education of the rest of the community is of at least equal importance. It is preposterous to give all mankind the same education exactly, because they are intended for different professions; and what is of first rate importance to one man is of no use whatever to another. Human life is too short to enable every individual to run the complete career of the sciences; yet it is of infinite importance that a young man should be made acquainted with the first principles of the profession to which he is to devote himself. The lawyer requires one education, the physician another, the clergyman a third. Where in England can a merchant or manufacturer go to acquire those branches of knowledge which he ought to possess?

At the University of Edinburgh there are lectures delivered on the following subjects, which I divide into sets for the greater perspicuity:—

### *I. General Literature and Science.*

- |                      |                        |
|----------------------|------------------------|
| 1. Greek.            | 6. Mathematics.        |
| 2. Latin:            | 7. Natural philosophy. |
| 3. Logic.            | 8. Astronomy.          |
| 4. Rhetoric.         | 9. Natural history.    |
| 5. Moral philosophy. | 10. Agriculture.       |



II. *Medicine.*

- |                    |                            |
|--------------------|----------------------------|
| 1. Chemistry.      | 6. Theory of physic.       |
| 2. Anatomy.        | 7. Practice of physic.     |
| 3. Botany.         | 8. Surgery.                |
| 4. Materia medica. | 9. Clinical surgery.       |
| 5. Midwifery.      | 10. Medical jurisprudence. |

III. *Law.*

- |                       |                |
|-----------------------|----------------|
| 1. Universal history. | 3. Civil law.  |
| 2. Scots' law.        | 4. Public law. |

IV. *Theology.*

- |                    |            |
|--------------------|------------|
| 1. Divinity.       | 3. Hebrew. |
| 2. Church history. |            |

Now any individual that chooses may attend any one of these classes without paying attention to the rest; so that every person has it in his power to select those subjects that are most likely to be of service to him. The consequence is, that in Scotland every country gentleman, every merchant and manufacturer, has enjoyed the advantage of a University education. In England, on the contrary, this advantage is confined to a comparatively small number. You will find more profound scholars, and perhaps men of deeper science, in England than in Scotland. But in the latter country every person has a little, and there is therefore more knowledge upon the whole. It would be a prodigious advantage to England if this eclectic mode of acquiring knowledge were to be introduced into the Universities. But I am sensible that as long as they are powerful political engines, and possessed of such prodigious patronage and power, this can never be the case. Science can never thrive where it is united to politics: the union is unnatural, degrading, and destructive.

\*\*\* We cannot dismiss this article without reprobating, in the strongest terms, the manner in which the Universities, and other Public Libraries, have availed themselves of an Act of Parliament passed in the session before last, reviving an obsolete law, whereby authors and publishers are compelled to give 11 copies of every book, and of every new edition to which there is any alteration or addition. We forbear to notice the injustice of a law which inflicts a severe tax on one set of individuals for the exclusive advantage of another. We shall merely speak of the extent to which these public bodies avail themselves of the power vested in them; and particularly the richly endowed University of Cambridge, to which more particularly literary men are indebted for the revival of this tax. We are informed that, with the exception of one or two of the libraries, which affect to omit *Novels*, every book is demanded, however expensive, or useless, or unfit to be placed on the shelves for which they are destined. New editions are demanded, however small the alteration from the former. We know an instance in which the 11 copies of a book, price 17. 10s., were demanded and received in April of the present year, and another 11 copies of a new edition in August. There is every reason to believe that the parties who are entrusted to make the demands do not know

what books they order, being satisfied with returning signed the very lists which they receive from the clerk of the Stationers' Company. Had the Universities been required to pay a sum however small, even a tenth of the price of each book, this tax upon literature would have been exacted with much less severity.

## ARTICLE IX.

### SCIENTIFIC INTELLIGENCE; AND NOTICES OF SUBJECTS CONNECTED WITH SCIENCE.

#### I. *Lectures.*

The Lectures on Midwifery, and the Diseases of Women and Children, at the Middlesex Hospital, by Mr. Merriman, Physician Accoucheur to that Hospital, and Consulting Physician Accoucheur to the Westminster General Dispensary, will recommence on Monday, Oct. 9.

A Course of Lectures on Chemistry will be commenced at the Chemical Theatre, No. 42, Windmill-street, on Tuesday, Oct. 8, at nine o'clock in the morning, by Wm. T. Brande, F.R.S. L. and E. Prof. Chem. R. I. &c.

The Winter Courses of Lectures at the School of Medicine in Ireland, on Anatomy, Physiology, Pathology, Surgery, Chemistry, Materia Medica, Institutes, and Practice of Medicine, will commence on the 6th of November, at their respective hours.—Anatomical Demonstrations will commence the 1st of December.

Dr. Gordon's Lectures on Anatomy and Surgery commence at Edinburgh on Wednesday, Oct. 25, at eleven o'clock forenoon; and his Lectures on Institutions of Medicine, consisting of Physiology, Pathology, and Therapeutics, on Monday, Oct. 30, at one o'clock afternoon. Both Courses will be continued till April, five Lectures being delivered weekly in each.

#### II. *Substance sublimed during the Burning of London Bricks.*

Many of my readers are probably aware that the method of burning bricks in the neighbourhood of London is different from what is practised in any other part of Great Britain, and probably of Europe. The fuel employed is the ashes or cinders which fall from the common fires in the different houses in London, and which are collected daily by the dust-carts. The greatest part of this fuel is mixed with the unburnt bricks; the remainder is strewed between the layers of brick. The kilns are built so as to exclude as much of the air as possible. The consequence is, that the combustion goes on very slowly; three months being frequently requisite to complete the burning of a single kiln. It is to this exclusion of the air that the yellow colour of the London bricks is owing: the outermost row of bricks is always red.

I mentioned in a preceding volume of the *Annals of Philosophy* that Mr. Trimmer had given me a salt which commonly sublimes during the burning of the London bricks. This salt I found to be sal-ammoniac. The same Gentleman lately put into my hands another substance, which sublimes likewise during the same process, though in much smaller quantity. This substance is usually crystallized in long slender needles. It has the metallic lustre, and a bluish-white colour; but is so delicate in its texture that it can scarcely be collected without falling to powder. In its common state this substance has a blue colour somewhat resembling that of watch-springs, and it has but little of the metallic lustre.

It possesses the following properties. When heated in nitric acid, it effervesces, and is converted into a white powder. Before the blow-pipe it readily melts; and if in a state of purity, is speedily reduced into a white metallic globule. This globule is soft and malleable; it dissolves with effervescence in dilute nitric acid. The solution is colourless; it crystallizes, and throws down a white powder when mixed with sulphuric acid or with prussiate of potash. The globule is therefore lead. When the substance in question is not pure, but mixed with earthy matter, it readily melts before the blow-pipe into a dark-coloured glaze; but no metallic globule of lead separates from it, though the heat be kept up a considerable time upon charcoal. These facts are sufficient to demonstrate that this substance sublimed during the burning of London bricks is galena, or sulphuret of lead. Indeed, it has exactly the appearance of the galena after it has been roasted.

This galena must be derived from the cinders of the coals used for burning the bricks. It is very common to observe small strings of galena running through coal beds; and unless I am misinformed, such strings have been frequently observed in the beds of Newcastle coal. As galena is not volatile, at least at the temperature at which bricks are burnt, we must ascribe its sublimation in the present case to the sal-ammoniac, which no doubt carries it along with it. This salt is well known to have the property of carrying along with it those metallic bodies with which it happens to come in contact.

### III. *Queries respecting Valves, with a Description of the Valves in the Human Body.*

(To Dr. Thomson.)

SIR,

In this age of improvement and discovery, every mite that is contributed to a public journal, if it is only to open the eyes, and afford any degree of stimulus for others to improve from, must be generally considered worth acceptance; and it is principally with this latter hope that I submit the following remarks to your readers.

What I am about to communicate has considerably engaged my attention for some time past, and has been the means of my consulting every author on hydrostatics possibly within my command, but wholly without affording me the least satisfaction as to what I

sought after, which consists in the construction of a valve applicable to this part of science, that must be in a great measure very complete. I mean those after the manner of the valves of the human body. I believe it is an indisputable maxim that the nearer we approach to the mechanism of the vital frame, and to the operation of nature, in all of our endeavours, the nearer we conceive and find we reach to perfection.

The valves of the human body every anatomist must be fully aware are constructed on an inimitable principle; and for what an infinite space of time do we often behold those most important organs performing their office uninterrupted and unimpaired. I cannot but imagine that this plan must have been contemplated by many, and even put into practice; but being unable to discover any account of its being attempted, I should feel myself under a great obligation to you, or any of your correspondents, that would give me the necessary information.

A few weeks since I constructed a temporary model of a pump on the plan alluded to, by fixing the valve within a piece of large barometer tube, by which means its action could be plainly perceived: and as I conceive many of your ingenious readers may not perfectly comprehend the manner in which the valves I alluded to are constructed in the human body, I have subjoined a slight sketch of them, and hope it may prove sufficiently illustrative. It is greatly with the hope that some more able mechanic than myself will devise a proper plan for securing the valve, and discover those materials that will best answer the purpose, and erect one on a large and useful scale.

Fig. 1.

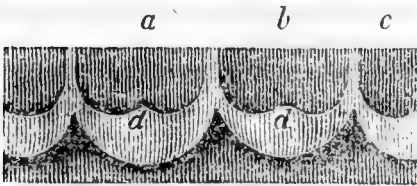

Fig. 2.



The materials of which the valve itself must be composed appears to be the greatest obstacle to their general employment. I firmly hope that this is within the reach of many: and if this paper should be the means of drawing any able person's attention to the subject, I doubt not but their labours would be deservedly crowned with success.

The substance I used was that of a bullock's bladder, as being the strongest and most flexible substance capable of being moulded to the proper form, that I could then procure to make my experiments; but this substance we know is subject to a very rapid decay, especially when immersed in many fluids.

Fig. 1 shows the valve as supposing the cylinder to be slit open and laid flat, and which may be supposed to be three bags, *a*, *b*, and *c*, the latter of which is here divided: one side of each bag is fixed to the side of the cylinder, and the edges of each bag meet, or are even allowed to lap over each other, to be certain of their being in contact. The opposite side of the bag to that fixed to the side of the cylinder is not so deep, as seen at *d*, with a small projection or looseness of substance in the centre of each. Indeed, the three parts must be made a trifle more than sufficiently large to fill the diameter of the tube, as it will thereby be strengthened, and be more able to surround and inclose any foreign substance that may happen to stop between it, and not be so liable to be stretched.

Now when the water rises in the pump by the action of the piston, which has another valve of the same construction attached to it, the bags of the lower valve contract and become empty, and allow the water to pass freely; while those of the upper valve in the piston are full and distended, and put on the appearance of fig. 2, and *vice versa*. I proved in one of my experiments the great utility of these valves over those in general use. I put a quantity of sticks, straws, &c. into the water, and observed that on the action of the piston a large piece stuck between the valve, but it so completely inclosed it that not a drop could possibly escape. This happened several times, and as often was it perfectly secure.

The astonishing strength it possessed was beyond what I should have conceived. For the trial of this I inversed the valve in the piston; and after raising it, I did not possess sufficient muscular power to burst or even displace either of the valves, though only luted to the sides of the cylinder by a strong gum water, which of course became after a time dissolved.

From the little I have seen of its operation, I am persuaded that its erection on a large scale, with proper materials (whether leather would answer the purpose I am not competent to decide), would be attended with infinite benefit and utility to mankind.

I am, Sir, your most obedient,

Helston, Sept. 1, 1815.

M. MOYLE.

#### IV. Regulations for the Examination of Apothecaries.

The Court of Examiners chosen and appointed by the Master, Wardens, and Assistants, of the Society of Apothecaries, of the City of London, in pursuance of a certain Act of Parliament, "For better Regulating the Practice of Apothecaries throughout England and Wales," passed in the 55th year of the reign of his Majesty King George the Third, has determined:

That every person who shall be admitted to an examination for a certificate to practise as an apothecary, shall be required to produce

Testimonials of having served an apprenticeship of not less than five years to an apothecary; of having attained the full age of 21 years, and being of a good moral conduct.

He is expected to possess a competent knowledge of the Latin language, and to produce certificates of having attended not less than

- Two Courses of Lectures on Anatomy and Physiology :
- Two Courses of Lectures on the Theory and Practice of Medicine :
- One Course of Lectures on Chemistry : and
- One Course of Lectures on *Materia Medica*.

A certificate of attendance for six months at least on the medical practice of some public Hospital, Infirmiry, or Dispensary.

The Court has also determined that the examination for a certificate to practise as an apothecary shall be as follows :—

1. In translating parts of the *Pharmacopœia Londinensis*, and Physicians' Prescriptions.
2. In the Theory and Practice of Medicine.
3. In Pharmaceutical Chemistry.
4. In the *Materia Medica*.

*Regulations for the Examination of Assistants.*—That every person who shall be admitted to an examination for a certificate to act as an assistant to any apothecary, in compounding or dispensing medicines, shall be required to translate parts of the *Pharmacopœia Londinensis*, and Physicians' Prescriptions ; and shall be examined as to his knowledge of Pharmacy and *Materia Medica*.

*Notice.*—Every person intending to qualify himself under the regulations of this Act to practise as an apothecary, or to act as an assistant, must give notice in writing (post paid) addressed to the Clerk of the Society of Apothecaries, Apothecaries' Hall, London, at least six days previously to the day of examination.

The Court will meet in the Hall on Thursday the 3d of August, at two o'clock of the afternoon precisely, and on every following Thursday at the same hour.

By order of the Court,

London, July 31, 1815.

JOHN WATSON, Secretary.

It is expressly ordered by the Court of Examiners that no gratuity be received by any officer from any person applying for information relative to the business of this Court.

#### V. *Extracts from the Act for better Regulating the Practice of Apothecaries throughout England and Wales.*

That from and after the 1st day of August, 1815, it shall not be lawful for any person or persons (except persons already in practice as such) to practise as an apothecary in any part of England or Wales, unless he or they shall have been examined by the Court of Examiners, or the major part of them, and have received a certificate of his or their being duly qualified to practise as such from the said Court of Examiners ; who are authorised and required to examine all person and persons applying to them, for the purpose of ascertaining the skill and abilities of such person or persons in the

science and practice of medicine, and his or their fitness and qualification to practise as an apothecary.

That from and after the 1st day of August, 1815, it shall not be lawful for any person or persons (except the persons then acting as assistants to any apothecaries, and excepting persons who have actually served an apprenticeship of five years to an apothecary) to act as an assistant to any apothecary, in compounding or dispensing medicines, without undergoing an examination by the Court of Examiners, or by five apothecaries, so to be appointed as hereinafter is mentioned.

That it shall and may be lawful to appoint five apothecaries in any county or counties respectively throughout England and Wales (except within the said city of London, the liberties or suburbs thereof, or within 30 miles of the same,) to act for such county or counties, or any other county or counties near or adjoining; and such five apothecaries are authorized and empowered to examine all assistants to apothecaries throughout the county or counties in regard of which such apothecaries shall have been so appointed as aforesaid.

That if any person (except such as are then actually practising as such) shall, after the said 1st day of August, 1815, act or practise as an apothecary in any part of England or Wales, without having obtained such certificate as aforesaid, every person so offending shall for every such offence forfeit and pay the sum of 20*l.*; and if any person (except such as are then acting as such, and excepting persons who have actually served an apprenticeship as aforesaid) shall, after the 1st day of August, 1815, act as an assistant to any apothecary, to compound and dispense medicines, without having obtained such certificate, every person so offending shall for every such offence forfeit and pay the sum of 5*l.*

That no apothecary shall be allowed to recover any charges claimed by him in any Court of Law, unless such apothecary shall prove on the trial that he was in practice as an apothecary prior to, or on the said 1st day of August, 1815, or that he has obtained a certificate to practise as an apothecary.

That the said Master, Wardens, and Society of Apothecaries, do make annually, and cause to be printed, an exact list of all and every person who shall in that year have obtained a certificate to practise as an apothecary, with their respective residences attached to their respective names.

## VI. *Further Observations on Mr. Lockhart's Extraction of the Cube Roots of Binomials.*

(To Dr. Thomson.)

SIR,

ON examining my letter of June 16, I observe that I have omitted to state that the correction which is there pointed out is only applicable to equations which are reducible by Cardan's rule, Mr. Lockhart's roots being correct if the equation belong to the irreducible case. In my letter, instead of saying "Mr. Lockhart



seems to have made a mistake in one of the signs of the root connected with  $t$ : when corrected, &c." I should have said, "Mr. Lockhart seems to have made a mistake in one of the signs of the root connected with  $t$ , when the equation is reducible by Cardan's rule: when corrected, &c." So that the roots of

$$\sqrt[3]{\frac{c}{2}} \pm \sqrt{\frac{c^2}{4} - \frac{b^3}{27}}, \text{ if the given equation } x^3 - bx = c, \text{ be}$$

reducible, will be

$$\begin{aligned} \frac{x}{2} &\pm \sqrt{\frac{x^2}{4} - \frac{b}{3}} \\ -\frac{t}{2} &\mp \sqrt{\frac{t^2}{4} - \frac{b}{3}} \\ -\frac{v}{2} &\mp \sqrt{\frac{v^2}{4} - \frac{b}{3}} \end{aligned}$$

but if irreducible, the roots will be

$$\begin{aligned} \frac{x}{2} &\pm \sqrt{\frac{x^2}{4} - \frac{b}{3}} \\ -\frac{t}{2} &\pm \sqrt{\frac{t^2}{4} - \frac{b}{3}} \\ -\frac{v}{2} &\mp \sqrt{\frac{v^2}{4} - \frac{b}{3}} \end{aligned}$$

You will perceive that, when the above omission is supplied, the observations in Mr. L.'s last letter lose all their weight, and the conclusions I have come to in my former letter remain in full force.

I am afraid, however, that I have not expressed myself with that perspicuity which I ought to have done, when pointing out the part of Mr. Lockhart's demonstration, where the error appears to have originated; for if I had expressed myself properly, Mr. L. must have seen that there was to be a distinction between equations which are reducible by Cardan's rule, and those belonging to the irreducible case: but that he did not perceive it, is manifest from the observations in his last letter.

In endeavouring to supply the above defect, I shall begin by premising, that in equations belonging to the irreducible case,  $t^2$  is always greater than  $\frac{b}{3}$ , but less when the equation can be reduced by Cardan's rule. Hence in irreducible equations the quantity  $(t^2 - \frac{b}{3})$  is always *positive*; but in reducible equations, *negative*.

Mr. L., in No. 30 of your *Annals*, has shown that  $\frac{b^2 t^2}{4} - \frac{b t^4}{27} + \frac{t^6}{4} - \frac{b^3}{27} = \frac{c^2}{4} - \frac{b^3}{27}$ , or, which is the same thing,  $(\frac{b^2}{9} - \frac{2bt^2}{3} \pm t^4) \times (\frac{t^2}{4} - \frac{b}{3}) = \frac{c^2}{4} - \frac{b^3}{27}$ . Now in extracting the square root of these equal quantities, it is plain that the roots on both sides of the equation must be of the same kind; that is, if one be a positive quantity, the other must be positive also; or if one be negative, the other must be negative likewise. Now the roots are  $\pm (t^2 - \frac{b}{3}) \times \pm \sqrt{\frac{t^2}{4} - \frac{b}{3}}$  and  $\pm \sqrt{(\frac{c^2}{4} - \frac{b^3}{27})}$ . But it has been noticed before, that the quantity  $(t^2 - \frac{b}{3})$  is in itself a

negative quantity whenever the equation can be reduced by Cardan's rule. Hence, that the roots may be both positive or both negative, we must take the sign of  $(t^2 - \frac{b}{3})$  contrary to the sign of

$(\sqrt{\frac{t^2}{4} - \frac{b}{3}})$ ; so that the equation in this case will be  $\mp (t^2 - \frac{b}{3}) \times \pm \sqrt{(\frac{t^2}{4} - \frac{b}{3})} = \pm \sqrt{(\frac{c^2}{4} - \frac{b^3}{27})}$ : but if the equation be-

long to the irreducible case, the quantity  $(t^2 - \frac{b}{3})$  being then positive in itself, both parts of the roots on the left hand must have the same signs. Hence the equation will be  $\pm (t^2 - \frac{b}{3}) \times \pm \sqrt{(\frac{t^2}{4} - \frac{b}{3})} = \pm \sqrt{(\frac{c^2}{4} - \frac{b^3}{27})}$ : and by proceeding with these two

equations as Mr. L. has done in the letter alluded to, we obtain from the first of them,  $-\frac{t}{2} - \sqrt{\frac{t^2}{4} - \frac{b}{3}} =$

$$\sqrt[3]{\frac{c}{2} + \sqrt{\frac{c^2}{4} - \frac{b^3}{27}}}, \text{ the same as the root given in my former}$$

letter; and from the second we get  $-\frac{t}{2} + \sqrt{\frac{t^2}{4} - \frac{b}{3}} =$

$$\sqrt[3]{\frac{c}{2} + \sqrt{\frac{c^2}{4} - \frac{b^3}{27}}}, \text{ the same with Mr. L.'s root.}$$

With respect to the two roots connected with  $x$  and  $v$ , I have only to observe, that they are obtained in the very same manner as that connected with  $t$ , only there is no ambiguity in the two quantities  $(x^2 - \frac{b}{3})$  and  $(v^2 - \frac{b}{3})$ , the former being always a positive, and the latter a negative, quantity.

Before I take leave of this subject, it may not be amiss to observe, that by inspecting the formulæ for the cubic roots of the two imaginary quantities  $\sqrt[3]{\frac{c}{2} + \sqrt{\frac{c^2}{4} - \frac{b^3}{27}}}$  and  $\sqrt[3]{\frac{c}{2} - \sqrt{\frac{c^2}{4} - \frac{b^3}{27}}}$  when the given equation  $x^3 - bx = c$  is irreducible, it is manifest that their sum will always be a real quantity; for the imaginary parts in the roots of the first of these quantities are the very same as the imaginary parts of the roots belonging to the second, but having contrary signs. It likewise appears that the real quantities arising from taking their sum will always be the three roots of the given cubic equation,

This appears to me to be a more direct and satisfactory demonstration, that Cardan's theorem, though apparently an imaginary quantity, exhibits truly the roots of equations belonging to the irreducible case, than the one generally had recourse to, viz. to expand each part of the root in an infinite series by means of the binomial theorem.

It likewise appears from these formulæ that whenever any one of the roots of a cubic equation admits of a finite value, the two parts of Cardan's theorem are both perfect cubes.

I flatter myself that your Correspondent Mr. L. will now perceive that he was rather too hasty in concluding that "all numbers have four imaginary cube roots." And further, as it appears that it was not impossible or imaginary quantities which led "to such difference of sentiment" in this case, Mr. L. will *not* now perhaps think it "wise to abandon them altogether," particularly as it is known that in some cases they lead very readily to results which are very troublesome to obtain by any other method yet discovered.

I am, Sir, your obedient servant,

Newcastle, Aug. 12, 1815.

H. ATKINSON.

P. S. In my letter of June 16, p. 73, line 6 from the top, for  $\sqrt[3]{\frac{c}{2}} - \sqrt{\frac{c^2}{4} - \frac{b^3}{27}}$  read  $\sqrt[3]{\frac{c}{2}} + \sqrt{\frac{c^2}{4} - \frac{b^3}{27}}$ ; and line 14 from the top, for  $\sqrt[3]{36} \pm \sqrt{784} = \sqrt[3]{64} \sqrt[3]{8}$ , read  $\sqrt[3]{36} \pm \sqrt{784} = \sqrt[3]{64}$  or  $\sqrt[3]{8}$ .

#### VII. Test of Iodine.

Stromeyer has announced that starch is so delicate a test of iodine when in an uncombined state, that it assumes a perceptible blue tinge when no more than  $\frac{1}{450000}$ th part of iodine is present in the liquid examined. I have not tried this test myself; but suppose that in most cases it will be requisite to add an acid to the liquid in order to disengage the iodine from its combination. The blue compound of iodine and starch was first made known to chemists by MM. Colin and Gaultier de Claubry.

#### VIII. Rapid Intercourse through Great Britain.

The rapid intercourse which at present exists between every part of Great Britain and the capital must have struck every person who has travelled through this country. We meet with no marked distinctions in the dress or manners of the different provinces. The fashions in the most remote parts of the country are quite the same as in London. This rapid intercourse began during the seven years war when Britain first became a great commercial country, and it has been increasing ever since. It is owing in a great measure to the goodness of the roads, which have been made over the whole of Great Britain, and to the navigable canals, which have in some measure united the most distant manufacturing towns with each other and with the capital. Before the year 1760, the inland towns of Great Britain, such as Manchester, Leeds, Halifax, &c. chiefly carried on their business through the medium of travelling pedlars, and afterwards on pack-horses. The journey in this manner from Manchester to London occupied a fortnight; and it was not unusual for a trader going for the first time on this expedition to take the precaution of making his will. At present the stage coaches perform the journey in about a day and an half.

In the year 1725 there was not a cart in the whole county of Mid Lothian. The farmers in the neighbourhood of Dalkeith carried

out the stable manure from Edinburgh on the backs of horses; and a journey from Dalkeith to Edinburgh (six miles) for this manure, and back again with the load, occupied a whole day. I myself remember when the vessels trading between Leith and London took up two months in the voyage, and they were constantly laid up during the winter. At present an average passage is less than a week, and they sail regularly twice every week all the year round. For this very great improvement in the coasting trade, we are indebted to the inhabitants of Berwick-upon-Tweed. They first employed smacks, and were thus enabled to perform their voyage in a short space of time. The consequence was, that almost the whole carrying trade between Edinburgh and London fell into their hands; and about 50 waggons were constantly employed in carrying the goods between Berwick and Edinburgh. The proprietors of the Berwick smacks, in order to save the expense of this land carriage, made their vessels sail directly from London to Leith, and from Leith to London. This continued for several years; till at last the inhabitants of Leith and Edinburgh built smacks of their own, and drove the Berwickers out of the trade.

IX. *Description of the Woaps: and Observations on the Size of the Whale.*

(To Dr. Thomson.)

SIR,

Whitby, Aug. 17, 1815.

Your publication being peculiarly adapted for the dissemination of facts which are not of sufficient importance to be expanded into a distinct volume, I beg leave to present to you the following, which, if new, you will oblige me by inserting in the *Annals of Philosophy*.

There is a phenomenon familiar to the fishermen of the east coast of England, resembling a distant cannonading, which I do not recollect of ever seeing noticed in any scientific work. It consists of distinct reports, like those of guns, which sometimes are heard singly, or at distant intervals; at others they follow each other so regularly and closely as to resemble a ship saluting. It cannot be distinguished from distant cannon, but that it often occurs when no vessel whatever is within sight, though the horizon be perfectly clear. It is most commonly heard by the crews of the *farm* boats or *cobbles*, when anchored upon the Doggerbank, or other situations at a distance from the shore. It is never observed but in the summer season: it then occurs most frequently in cloudy weather, and about the time of sun-rising. It is not attended by any light, flash, smoke, or other visible consequences. It is occasionally heard from the shore, but by no means so frequently as at sea. The phenomenon is probably electrical. Our Yorkshire fishermen attribute it to *foul air*, and distinguish it by the name of *woaps* or *whops*.

I consider it my duty at this opportunity to offer a few remarks upon the size of the whale, in reference to some observations pub-

lished in No. 31 of the *Annals*. There is doubtless no branch of zoology so much involved as that which is now entitled Cetology. To the world at large several genera of this class of animals bear the general name of whales: and from the circumstance of many of the species being rarely, if ever, caught, they are in a great measure unknown. Thus it is that the mysticetus physalis, and musculus, of Linnæus, are generally confounded. The first is probably the most bulky animal of the creation, but the second is undoubtedly the longest. The *balæna physalis*, or *razor-back* of the whale-fishers, is often seen apparently of the length of a ship; that is, from 90 to 110 feet: and of this species, most probably, was the skeleton alluded to by Capt. Clarke. From the quantity of mysticeti which I have seen caught, and the immense number which I have seen at liberty in the Greenland seas, I feel the greatest confidence in asserting that the northern whale fishery has not afforded, during the last 15 years at least, a single individual of the species of the length of 80 feet.

I am, Sir, your humble obedient servant,

WILLIAM SCORESBY, jun.

### X. On Spring Carriages.

(To Dr. Thomson.)

SIR,

Edgeworthstown.

In your *Annals of Philosophy*, No. 32, for August, 1815, there is an account of some experiments which were shown by me before a Committee of the Dublin Society, on the 22d of last April.

I beg that you will have the goodness to notice at your leisure a mistake which occurred in that Report. In the experiment No. 1, tried with two furniture carts that were sustained on grasshopper springs, the result is stated to be in favour of the spring carriage, viz. as one-fourth of the weight that was laid upon it. This statement was inaccurate, because the experiments were exhibited before 500 spectators, whose remarks and inquiries prevented a minute attention to the summing up the results with accuracy. The weight of the furniture carts was forgotten, which should have been included in the comparison which was made of their drafts. These experiments, however, were announced as the means of making a general impression upon the public to remove the mistaken predilection for high and short carriages, and to recommend the use of springs for carriages of burden, but not with a view of establishing the exact ratio of advantage that might be gained by different constructions of carriages.

The Dublin Society had most handsomely appropriated 100*l.* for trying, before the Committee of Natural Philosophy, experiments upon wheel carriages under my conduct. I have ever since that time been employed unremittingly in preparing a set of accurate experiments to be submitted to them, when I have satisfied myself of their being worthy their attention. When they have been com-

pleted, the Report of the Committee shall be transmitted to your Journal.

I am, Sir, your obedient servant,  
RICHARD LOVELL EDGEWORTH.

### XI. On Carbonate of Bismuth.

(To Dr. Thomson.)

SIR,

I observe in the last number of your *Annals* a notice relating to the discovery of the carbonate of bismuth in Cornwall. I am induced to trouble you with a few words upon the subject, because I find it mentioned nearly six years ago, and some particulars relative to it, with a coloured engraving, given in a work which, notwithstanding its general utility, and the encouragement it has met with, has perhaps in scarcely any instance been cited by mineralogical writers: I mean Sowerby's *British Mineralogy*, containing coloured engravings of the minerals of Great Britain, accompanied by descriptions and remarks. From the account given of the substance in question in that work,\* it appears to have been detected by the Rev. W. Gregor, and that it was brought from St. Agnes. It is a white earthy substance, rather harsh to the touch, with scarcely any lustre; and the specimen sent to Mr. Sowerby was considered by Mr. Gregor, from his chemical examination of it, to be mixed with oxide of iron and stony matter. The following passage, taken from Sowerby's account, will serve as a reason that this substance should have escaped detection before the latter part of the year 1809, the period at which the specimen was forwarded to Mr. S. "We think it of much consequence to figure such a substance as the present; for by remembering the figure we shall not too hastily pass over things which at first have common appearances, but examine them with attention, which will habituate the judgment to the easy discrimination of obscure characters, and teach us to suspect what is not quite usual, and therefore to examine it, if necessary, by means of chemical agents."

Sept. 9, 1815.

G. B.

### XII. Table Mountain at the Cape of Good Hope.

From a description of this mountain by Capt. Hall, published in the last volume of the *Edinburgh Transactions*, it appears that the lower part of it is composed of granite, that the granite at the bottom is covered with clay-slate, and that veins of granite pass through this slate. The summit of the mountain consists of red sand-stone.

\* Vol. iv. p. 77, pl. 344, published Dec. 1, 1809.

## ARTICLE X.

*List of Patents.*

JOHN LINGFORD, Woburn-place, London; for his anatomical self-regulating truss, consisting of a three quarter or circular spring, with an angular moveable joint and end piece, with joint and additional spring, to act occasionally with a moveable pad of various shapes, agreeable to the form of the afflicted part of the body, and with elastic spring covering. June 1, 1815.

BENJAMIN STEVENS, No. 42, Judd-street, St. Pancras, London; for his improved method of making marine and domestic hard and soft soap. June 3, 1815.

RICHARD TREVITHICK, Camborne, Cornwall, Esq.; for certain improvements on the high pressure of steam-engines, and the application thereof, with or without other machinery, to useful purposes. June 6, 1815.

JULIEN JORETT, Wells-street, sweep-washer; JOHN POSTEL, Great Suffolk-street, Charing Cross; and LEWIS CONTESSÉ, Bate-man-buildings, London, jeweller; (in consequence of a communication to them by a foreigner residing abroad) for a method of extracting gold and silver from the cinders of gold refiners and other substances, by means of certain curious machinery. June 8, 1815.

JOHN TAYLOR, of Stratford, Essex, manufacturing chemist; for a mode or means of producing gas to be used for the purpose of affording light. June 14, 1815.

CHARLES WHITLOW, New York Coffee-house, Sweetings Alley, London, botanist; for working or making of certain manufactures from certain plants of the *genus urtica* and *asclapius*, growing in North America, and not heretofore used in this realm, whereby the fabrics or products usually had, made, or obtained, from hemp, flax, cotton, silk, and other fibrous materials, or the seeds or the parts thereof, may be beneficially had, made, or obtained. June 14, 1815.

ROBERT BROWN, Burnham Westgate, Norfolk, ironfounder; for certain improvements upon the swing of wheel ploughs, plough carriages, and plough shares. June 14, 1815.

JAMES GARDNER, Banbury, Oxford, machine maker; for improvements on a machine for cutting hay and straw. June 14, 1815.

WILLIAM POPE, St. Augustin's place, Bristol, perfumer; for certain improvements in or on wheeled carriages, and also the method or methods of making the said carriages go with or without the assistance of animals, which method or methods may be applied to other purposes. June 14, 1815.

GRACE ELIZABETH SERVICE, Arnold-place, Newington, London, spinster; for her new methods of manufacturing straw with gauze, net, web, and other similar articles, for the purpose of making into hats, bonnets, work-boxes, work-bags, toilet-boxes, and other articles. June 17, 1815.



## ARTICLE XI.

*Scientific Books in hand, or in the Press.*

A New Edition of Dr. Wells's Essay on Dew is in the Press, and will appear in October.

Mr. Sowerby has announced his intention to sell separately Coloured Prints of such British Plants as are introduced into the last Edition of the *Materia Medica*. A great part of the plants recommended in the *Materia Medica* of the last edition of the *Pharmacopœia Londinensis* are indigenous to Great Britain, and are described in Sir J. E. Smith's *Flora Britannica*, and figured in *English Botany*. Many of these by experience are understood to supersede the use of some of the Foreign ones, the identity of which must be certainly more dubious. The Royal College of Physicians have very commendably decided upon the propriety of medical practitioners having a sufficient knowledge of Botany to distinguish those plants which are more particularly useful in medicine: wherefore it has been thought desirable by some to procure such figures of medical plants as are published in *English Botany*; and Mr. Sowerby considers it his public duty to say, that he will furnish to those professional persons who desire it, plates only of the 54 medical plants figured in *English Botany*.

Mr. Anderson, of West Smithfield, has announced a Catalogue of an extensive Collection of Books in Anatomy, Surgery, Medicine, Midwifery, Chemistry, &c. New and Second Hand, including a valuable assortment of Medical Works recently imported from the Continent. To which is added a List of the Lectures delivered in London, with their terms, hours of attendance, &c.

Mr. Hanson, of Manchester, will shortly publish a Folio Chart, entitled, *The Meteorologist's Assistant*, accompanied with a Card, explanatory of the Mode of Notation. The chart will serve for any year and place required: but the principal object of it is to bring into one view a year's observations of the weather, by means of curves and characters. Of course it will facilitate a comparison of cotemporary notations of remote places.

Mr. Crowe, Surgeon in the Royal Navy, will publish in a few days a Chemical Table, exhibiting an elementary view of Chemistry, intended for the use of Students and young Practitioners in Physic, also to revive the Memory of more experienced Persons, being very convenient for hanging in Public and Private Libraries.

Mr. Carpue's Work on the Nasal Operation, with Plates, will appear in a few days.

During the ensuing month will be published the Ninth Volume of *General Zoology*, being a continuation of the *Birds*, by I. Stephens, Esq. who will finish the history of that class. The *Mollusca* will be written by Dr. Blainville, of Paris, who has devoted a considerable portion of his time to the study of that interesting type of animals: and the *Crustacea* by Dr. Leach, who is now gone to Paris for the purpose of obtaining a more perfect knowledge of the species. Thus the completion of this interesting work, commenced, and carried as far as the eighth volume, by the late Dr. Shaw, may be speedily expected.

## ARTICLE XII.

### METEOROLOGICAL TABLE.

1815.	Wind.	BAROMETER.			THERMOMETER.			Hygr. at	
		Max.	Min.	Med.	Max.	Min.	Med.	9 a.m.	Rain.
8th Mo.									
Aug. 11	N W	29.44	29.35	29.395	69	44	56.5	50	
12	N W	29.68	29.44	29.560	67	50	58.5	50	
13	S W	29.93	29.68	29.805	71	49	60.0	50	
14	S W	29.94	29.93	29.935	78	59	68.5	47	7
15	S W	29.94	29.64	29.790	75	59	67.0	48	2
16	N W	29.77	29.51	29.640	78	50	64.0	49	35
17		29.89	29.87	29.880	70	50	60.0	42	
18	Var.	29.87	29.60	29.735	72	54	63.0	65	28
19	W	29.77	29.58	29.675	67	45	56.0	49	
20	N W	29.86	29.77	29.815	68	47	57.5	43	
21	Var.	29.86	29.70	29.780	69	49	59.0	45	
22	Var.	29.70	29.58	29.640	73	59	67.0		
23	N W	29.91	29.58	29.745	72	58	65.0	52	86
24	S W	30.02	29.99	30.005	79	55	67.0	53	
25	S W	29.99	29.89	29.940	76	63	69.5	46	
26	S W	30.00	29.89	29.945	75	50	62.5	53	16

#### REMARKS.

*Eighth Month.*—11. Windy: *Cumulostrati*: and in the evening *Nimbi*, with a little rain. 12. Much wind, with *Cumulostratus*: thunder and rain from N. twice, p. m. after which more calm. 13. Fine: much wind, with *Cumulus*: coloured *Cirri*, evening. 14. Cloudy morning: temp. 71° at nine: hyg. at eight, 60°: windy: a smart shower by night. 15. Windy; *Cumulus* capped, and *Cumulostratus*: lunar corona at night, followed by rain. 16. Fair and windy, a. m. with clouds. About four, p. m. at the precise time of the barometer's turning to rise, came a very heavy shower, with two claps of thunder. 17. Fair: somewhat windy: large *Cumulostrati*. 18. Rain till nine a. m. after which fair: brilliant sun-set and moonlight. 20. *Cumulostratus*, low and stationary. 21. *Cumulus*, with *Cirrus* above, having little motion: p. m. the wind went to N. E., and the clouds descended, showing a corona round the moon. 22. Overcast, a. m. with thunder clouds, the wind S. E.: very heavy sudden shower before one: wet, p. m. 23. Rain and wind early this morning, with thunder, the wind S. E.: after which sweeping showers from N. W., and much wind by night. 24. Fair, with N. W. wind, and *Cumulus*: then S. W., with *Cirrocumulus*. 25. Fine day: *Cumulus*, with *Cirrus*: strong breeze. 26. A little rain early: heavy showers, evening.

#### RESULTS.

Barometer: Greatest height (in 16 days) ..... 30.02 inches.  
 Least ..... 29.35  
 Thermometer: Greatest height (in 16 days) ..... 79°  
 Least ..... 44  
 Rain (in 16 days) ..... 1.74 inch.

About 0.75 inch of rain appears to have fallen in the 13 days during which the observations have been interrupted. The column heretofore given to the results of the evaporation gauge will now be allotted to the whalebone hygrometer of De Luc, noted at nine a. m. The instrument employed was previously adjusted, so that its zero represents the hygrometric state of air long exposed in a close vessel to quick-lime, and 100° that of air similarly exposed to water. It is found to range at present 15° or 20° from the mean state, in which it is noted, towards the moist extreme in the night, and the dry in the day.

## METEOROLOGICAL TABLE (continued).

1815.	Wind.	BAROMETER.			THERMOMETER.			Hygr. at 9 a. m.	Rain.
		Max.	Min.	Med.	Max.	Min.	Med.		
8th Mo.									
Aug. 27	S	30·00	29·75	29·875	76	54	65·0	65	C
28	N W	29·81	29·72	29·765	71	50	60·5	55	5
29	S W	29·97	29·81	29·890	68	43	55·5		
30	S W	29·97	29·97	29·970	70	51	60·5	47	
31	S W	30·05	29·97	30·010	72	49	60·5	56	
9th Mo.									
Sept. 1		30·02	29·98	30·000	73	50	61·5	65	
2		29·96	29·86	29·910	76	54	65·0	52	—
3	W	29·96	29·88	29·920	72	56	64·0	54	—
4	N W	29·95	29·86	29·905	73	40	56·5	51	6
5	N W	29·97	29·95	29·960	63	40	51·5	48	
6		30·06	29·97	30·015	62	31	46·5		
7	N E	30·11	30·06	30·085	61	32	46·5		
8	S W	30·11	30·08	30·095	65	38	51·5	60	
9	S W	30·08	30·04	30·060	68	36	52·0		
10	N W	30·05	30·00	30·025	72	47	59·5	59	D
11	N W	30·07	30·00	30·035	74	46	60·0	55	
12	S E	30·07	29·92	29·995	70	42	56·0	67	
13	S	29·92	29·80	29·860	78	39	58·5		
14	S E	29·80	29·75	29·775	79	45	62·0		
15	S E	29·75	29·67	29·710	77	54	65·5	62	
16	Var.	29·80	29·67	29·735	75	47	61·0	65	9
17	S W	30·01	29·80	29·905	70	50	60·0	58	
18	S	30·05	30·04	30·045	74	51	62·5	56	O
19	Var.	30·04	29·94	29·990	68	43	55·5		
20	S E	29·94	29·87	29·905	60	34	47·0		
21	S	29·87	29·69	29·780				49	
22	S	29·69	29·57	29·630	71	50	60·5	60	·11
23	N W	29·57	29·50	29·535	59	38	48·5	68	
24	S W	29·77	29·46	29·615	58	37	47·5	72	·26
25	S W	29·80	29·75	29·775	61	43	52·0		
		30·11	29·46	29·892	79	31	57·0	58	·57

The observations in each line of the table apply to a period of twenty-four hours, beginning at 9 A. M. on the day indicated in the first column. A dash denotes, that the result is included in the next following observation.

## REMARKS.

*Eighth Month.*—27. *Cirrus*, passing to *Cirrocumulus* and *Cirrostratus*. 28. Shower early, and again p. m. 29. Lightning, in clouds to the E., between three and four, a. m. with moonlight westward; a fair day, with *Cumulus*. Hygr. at seven, a. m. 70°. 30. Much dew; *Cumulostratus* during the day. 31. Grey morning: then heavy *Cumulostratus*: very clear night.

*Ninth Month.*—1. Misty morning: *Cumulostratus*, which gave place at night to the *Stratus*. 3. A little fine rain early: various clouds followed, and some drops, p. m.: a *Cirrostratus* exhibited the prismatic colours at sun-set, and some elevated *Cirri* remained long red after it. 4. *Cumulostratus*, after large *Cirri*: showers at evening: rainbow: brilliant twilight. 5. Strong breeze: in the evening the new moon appeared with a well defined disk, and a pale phosphoric light, becoming afterwards gold coloured. 7. Hoar frost: hygr. 78° at seven, a. m. 8. After a fine day, nearly calm and cloudless, the smoke settled over the opposite valley, which was soon afterwards filled with a *Stratus*. 10. A veil of light clouds, a. m.: somewhat hazy air, with a smell of electricity. 12. A *Stratus*. 13. Much dew: the evening twilight of late has been generally coloured, and at times streaked with converging shadows, the origin of which could not be traced to clouds intercepting the light. 14. *Cirrus* only, which increased during the day, and mostly disappeared in the night: the extremes of temp. near the ground were 83° and 45°: the hygr. receded nearly to 22°. 15. Clear, a. m.: in the evening *Cirri*, and obscurity to the W.: after which *Cirrostratus*, and a very distant flash of lightning in the S.W. 16. A little rain, a. m.: much more cloud than of late has been usual: a *Nimbus* forming in the S.W.: in the evening steady rain. 17. Large *Cirrus*, passing to *Cirrocumulus*: at sun-set a sheet of compound *Cirrostratus*, while increasing by rapid propagation from N.W. towards S.E. was most beautifully kindled up, for a short time, with flame colour and orange on a purple ground. 18. Fair, with the lighter modifications. 19. Much wind at E. N. E. this morning: hygr. 40° at half-past ten, a. m. 20. Hoar frost: strong breeze: hygr. 30° at three, p. m. 21. *Cirrus*, followed by the intermediate modifications. 22. The sky filled gradually with clouds, both above and below: in the evening they grew black, but the rain came on without any explosion of electricity here. A *fire-balloon*, which I discovered near the S.W. horizon this evening, appeared to be impelled by different currents in rising, but passed the zenith going at a great rate and elevation towards the E. 23. Cloudy: wind N.W.: then N.: small rain. 24. Early overcast with *Cirrostratus*: the swallows went off, as it appears, this morning: after a murmuring sound in the wind, usual before southerly showers, we had a drizzling day till evening: the hygr. did not recede past 68°. 25. A fine day: hygr. went to 87° in the night.

## RESULTS.

Winds light and variable.

Barometer: Greatest height.....	30·11 inches;
Least .....	29·46 inches;
Mean of the period .....	29·892 inches.
Thermometer: Greatest height .....	79°
Least.....	31°
Mean of the period .....	57·00°

Hygrometer, mean degree, 58°. Rain, 0·57 inch.

\* \* \* A fiery meteor of the first magnitude was seen here to pass from the N. E. to the N. on the 29th ult. near eight, p. m.: of which a further account from an accurate observer will be acceptable.

ANNALS  
OF  
PHILOSOPHY.

---

---

NOVEMBER, 1815.

---

---

ARTICLE I.

*On the Relation between the Specific Gravities of Bodies in their Gaseous State and the Weights of their Atoms.*

THE author of the following essay submits it to the public with the greatest diffidence; for though he has taken the utmost pains to arrive at the truth, yet he has not that confidence in his abilities as an experimentalist as to induce him to dictate to others far superior to himself in chemical acquirements and fame. He trusts, however, that its importance will be seen, and that some one will undertake to examine it, and thus verify or refute its conclusions. If these should be proved erroneous, still new facts may be brought to light, or old ones better established, by the investigation; but if they should be verified, a new and interesting light will be thrown upon the whole science of chemistry.

It will perhaps be necessary to premise that the observations about to be offered are chiefly founded on the doctrine of volumes as first generalized by M. Gay-Lussac; and which, as far as the author is aware at least, is now universally admitted by chemists.

*On the Specific Gravities of the Elementary Gases.*

1. *Oxygen and Azote.*—Chemists do not appear to have considered atmospheric air in the light of a compound formed upon chemical principles, or at least little stress has been laid upon this circumstance. It has, however, been long known to be constituted by bulk of four volumes of azote and one volume of oxygen; and if we consider the atom of oxygen as 10, and the atom of azote as 17.5, it will be found by weight to consist of one atom of oxygen and two atoms of azote, or per cent. of

Oxygen .....	22·22
Azote .....	77·77

Hence, then, it must be considered in the light of a pure chemical compound; and indeed nothing but this supposition will account for its uniformity all over the world, as demonstrated by numerous experiments. From these data the specific gravities of oxygen and azote (atmospheric air being 1·000) will be found to be,\*

Oxygen .....	1·1111
Azote .....	·9722

2. *Hydrogen.*—The specific gravity of hydrogen, on account of its great levity, and the obstinacy with which it retains water, has always been considered as the most difficult to take of any other gas. These obstacles made me (to speak in the first person) despair of arriving at a more just conclusion than had been before obtained by the usual process of weighing; and it occurred to me that its specific gravity might be much more accurately obtained by calculation from the specific gravity of a denser compound into which it entered in a known proportion. Ammoniacal gas appeared to be the best suited to my purpose, as its specific gravity had been taken with great care by Sir H. Davy, and the chance of error had been much diminished from the slight difference between its sp. gr. and that of steam. Moreover, Biot and Arrago had obtained almost precisely the same result as Sir H. Davy. The sp. gr. of ammonia, according to Sir H. Davy, is ·590164, atmospheric air being 1·000. We shall consider it as ·5902; and this we are authorized in doing, as Biot and Arrago state it somewhat higher than Sir H. Davy. Now ammonia consists of three volumes of hydrogen and one volume of azote condensed into two volumes. Hence the sp. gr. of hydrogen will be found to be ·0694,† atmospheric air being 1·0000. It will be also observed that the sp. gr. of oxygen as obtained above is just 16 times that of hydrogen as now ascertained, and the sp. gr. of azote just 14 times.‡

3. *Chlorine.*—The specific gravity of muriatic acid, according to Sir H. Davy's experiments, which coincide exactly with those of

$$\begin{aligned} * \text{ Let } x &= \text{sp. gr. of oxygen. } 22\cdot22 = a \\ y &= \text{sp. gr. of azote. } 77\cdot77 = b \end{aligned}$$

$$\text{Then } \frac{x + 4y}{5} = 1.$$

$$\text{And } x : 4y :: a : b.$$

$$\text{Hence } 5 - 4y = \frac{4ay}{b}$$

$$\text{And } y = \frac{5b}{4a + 4b} = \cdot9722. \quad \text{And } x = 5 - 4y = 1\cdot1111.$$

$$\dagger \text{ Let } x = \text{sp. gr. of hydrogen.}$$

$$\text{Then } \frac{3x + \cdot9722}{2} = \cdot5902.$$

$$\text{Hence } x = \frac{1\cdot1804 - \cdot9722}{3} = \cdot0694.$$

$$\ddagger 1\cdot1111 \div \cdot0694 = 16. \quad \text{And } \cdot9722 \div \cdot0694 = 14.$$

Biot and Arrago, is 1.278. Now if we suppose this sp. gr. to be erroneous in the same proportion that we found the sp. gr. of oxygen and azote to be above, (which, though not rigidly accurate, may yet be fairly done, since the experiments were conducted in a similar manner), the sp. gr. of this gas will come out about 1.2845;\* and since it is a compound of one volume chlorine and one volume hydrogen, the specific gravity of chlorine will be found by calculation to be 2.5.† Dr. Thomson states, that he has found 2.483 to be near the truth, ‡ and Gay-Lussac almost coincides with him. § Hence there is every reason for concluding that the sp. gr. of chlorine does not differ much from 2.5. On this supposition, the sp. gr. of chlorine will be found exactly 36 times that of hydrogen.

*On the Specific Gravities of Elementary Substances in a Gaseous State that do not at ordinary Temperatures exist in that State.*

1. *Iodine.*—I had some reason to suspect that M. Gay-Lussac had in his excellent memoir rated the weight of an atom of this substance somewhat too high; and in order to prove this 50 grains of iodine, which had been distilled from lime, were digested with 30 grs. of very pure lamellated zinc. The solution formed was transparent and colourless; and it was found that 12.9 grains of zinc had been dissolved. 100 parts of iodine, therefore, according to this experiment, will combine with 25.8 parts of zinc, and the weight of an atom of iodine will be 155,|| zinc being supposed to be 40. From these data, the sp. gr. of iodine in a state of gas will be found by calculation to be 8.611111, or exactly 124 times that of hydrogen.\*\*

2. *Carbon.*—I assume the weight of an atom of carbon at 7.5. Hence the sp. gr. of a volume of it in a state of gas will be found by calculation to be .4166, or exactly 12 times that of hydrogen.

3. *Sulphur.*—The weight of an atom of sulphur is 20. Hence the specific gravity of its gas is the same as that of oxygen, or 1.1111, and consequently just 16 times that of hydrogen.

\* As 1.104 : 1.1111 :: 1.278 : 1.286.

And as .969 : .9722 :: 1.278 : 1.283. The mean of these is 1.2845.

† Let  $x$  = sp. gr. of chlorine.

$$\text{Then } \frac{x + .0694}{2} = 1.2845.$$

And  $x = 2.569 - .0694 = 2.5$  very nearly.

‡ *Annals of Philosophy*, vol. iv. p. 13.

§ Ditto, vol. vi. p. 126.

|| As 25.8 : 100 :: 40 : 155. According to experiment 8th, stated below, the weight of an atom of zinc is 40. Dr. Thomson makes it 40.9, which differs very little. See *Annals of Philosophy*, vol. iv. p. 94.

\*\* One volume of hydrogen combines with only half a volume of oxygen, but with a whole volume of gaseous iodine, according to M. Gay-Lussac. The ratio in volume, therefore, between oxygen and iodine is as  $\frac{1}{2}$  to 1, and the ratio in weight is as 1 to 15.5. Now .5555, the density of half a volume of oxygen, multiplied by 15.5, gives 8.61111, and  $8.61111 \div .06944 = 124$ . Or generally, to find the sp. gr. of any substance in a state of gas, we have only to multiply half the sp. gr. of oxygen by the weight of the atom of the substances with respect to oxygen. See *Annals of Philosophy*, vol. v. p. 105.



4. *Phosphorus*.—I have made many experiments in order to ascertain the weight of an atom of this substance; but, after all, have not been able to satisfy myself, and want of leisure will not permit me to pursue the subject further at present. The results I have obtained approached nearly to those given by Dr. Wollaston, which I am therefore satisfied are correct, or nearly so, and which fix phosphorus at about 17.5, and phosphoric acid at 37.5,\* and these numbers at present I adopt.

5. *Calcium*.—Dr. Marcet found carbonate of lime composed of 43.9 carbonic acid and 56.1 lime. † Hence as 43.9 : 56.1 :: 27.5 : 35.1, or 35 very nearly; and 35 - 10 = 25, for the atom of calcium. The sp. gr. of a volume of its gas will therefore be 1.3888, or exactly 20 times that of hydrogen.

6. *Sodium*.—100 grains of dilute muriatic acid dissolved 18.6 grs. of carbonate of lime, and the same quantity of the same dilute acid dissolved only 8.2 grs. of carbonate of lime, after there had been previously added 30 grs. of a very pure crystallized subcarbonate of soda. Hence 30 grs. of crystallized subcarbonate of soda are equivalent to 10.4 grs. of carbonate of lime, and as 10.4 : 30 :: 62.5 : 180. Now 100 grs. of crystallized subcarbonate of soda were found by application of heat to lose 62.5 of water. Hence 180 grs. of the same salt contain 112.5 water, equal to 10 atoms, and 67.5 dry subcarbonate of soda, and 67.5 - 27.5 = 40 for the atom of soda, and 40 - 10 = 30 for the atom of sodium. Hence a volume of it in a gaseous state will weigh 1.6666, or exactly 24 times that of hydrogen.

7. *Iron*.—100 grs. of dilute muriatic acid dissolved as before 18.6 grs. of carbonate of lime, and the same quantity of the same acid dissolved 10.45 of iron. Hence as 18.6 : 10.45 :: 62.5 : 35.1, or for the sake of analogy, 35, the weight of an atom of iron. The sp. gr. of a volume of this metal in a gaseous state will be 1.9444, or exactly 28 times that of hydrogen.

8. *Zinc*.—100 grs. of the same dilute acid dissolved, as before, 18.6 of carbonate of lime and 11.85 of zinc. Hence as 18.6 : 11.85 :: 62.5 : 39.82, the weight of the atom of zinc, considered from analogy to be 40. Hence the sp. gr. of a volume of it in a gaseous state will be 2.222, or exactly 32 times that of hydrogen.

9. *Potassium*.—100 grs. of the same dilute acid dissolved, as before, 18.6 carbonate of lime; but after the addition of 20 grs. of super-carbonate of potash, only 8.7 carbonate of lime. Hence 20 grs. of super-carbonate of potash are equivalent to 9.9 carbonate of lime; and as 9.9 : 20 :: 62.5 : 126.26, the weight of the atom of super-carbonate of potash. Now  $126.26 - 55 + 11.25 = 60$ , the

\* Some of my experiments approached nearer to 20 phosphorus and 40 phosphoric acid.

† I quote on the authority of Dr. Thomson, *Annals of Philosophy*, vol. iii. p. 376. Dr. Wollaston makes it somewhat different, or that carbonate of lime consists of 43.7 acid and 56.3 lime. *Phil. Trans.* vol. civ. p. 8.

weight of the atom of potash, and  $60 - 10 = 50$ , the weight of the atom of potassium. Hence a volume of it in a state of gas will weigh 2·7777, or exactly 40 times as much as hydrogen.

10. *Barytium*.—100 grs. of the same dilute acid dissolved exactly as much again of carbonate of barytes as of carbonate of lime. Hence the weight of the atom of carbonate of barytes is 125; and  $125 - 27\cdot5 = 97\cdot5$ , the weight of the atom of barytes, and  $97\cdot5 - 10 = 87\cdot5$ , the weight of the atom of barytium. The sp. gr. therefore, of a volume of its gas will be 4·8611, or exactly 70 times that of hydrogen.

With respect to the above experiments, I may add, that they were made with the greatest possible attention to accuracy, and most of them were many times repeated with almost precisely the same results.

The following tables exhibit a general view of the above results, and at the same time the proportions, both in volume and weight, in which they unite with oxygen and hydrogen: also the weights of other substances, which have not been rigidly examined, are here stated from analogy.

TABLE I.—Elementary Substances.

Name.	Sp. gr. hydr. being 1.	Wt. of atom, 2 vols. hydr. being 1.	Wt. of atom, oxygen being 10.	Wt. of atom, oxygen being 10, from experiment.	Sp. gr. atmospheric air being 1.	Sp. gr. atmospheric air being 1, from experiment.	Wt. in grs. of 100 cub. inches. Barom. 30, Therm. 60.	Wt. in grs. of 100 cub. in. from exper.	Observations.
Hydrogen ..	1	1.25	1.32	.073 <sup>1</sup>	.06944	2.118	2.23	<sup>1</sup> Dr. Thomson. See <i>Annals of Philosophy</i> , i. 177.	
Carbon .....	6	7.5	7.54 <sup>2</sup>	—	.4166	12.708	—	<sup>2</sup> Dr. Wollaston, from Biot and Arrago. <i>Phil. Trans.</i> civ. 20. Dr. Thomson makes it 7.51. <i>Annals of Philosophy</i> , ii. 42.	
Azote .....	14	17.5	17.54	.969 <sup>3</sup>	.9722	29.652	29.56	<sup>3</sup> Dr. W. from Biot and Arrago.	
Phosphorus..	14	17.5	17.4 <sup>4</sup>	—	.9722	29.652	—	<sup>4</sup> Dr. W. from Berzelius and Rose.	
Oxygen.....	16	8	10	1.104 <sup>5</sup>	1.1111	33.888	33.672	<sup>5</sup> Dr. Thomson, from a mean of several experiments.	
Sulphur.....	16	20	20 <sup>6</sup>	—	1.1111	33.888	—	<sup>6</sup> Dr. W. from Berzelius.	
Sodium .....	20	25	25.467	—	1.3888	42.36	—	<sup>7</sup> Dr. W. from experiment.	
Potassium ..	24	30	29.1 <sup>8</sup>	—	1.6666	50.332	—	<sup>8</sup> Dr. W. from Davy.	
Iron .....	28	35	31.5 <sup>9</sup>	—	1.9444	59.302	—	<sup>9</sup> Dr. W. from Thenard and Berzelius.	
Zinc .....	32	32	41 <sup>10</sup>	—	2.222	67.777	—	<sup>10</sup> Dr. W. from Gay-Lussac.	
Chlorine ....	36	45	44.1 <sup>11</sup>	2.483 <sup>12</sup>	2.5	76.248	—	<sup>11</sup> Dr. W. from Berzelius.	
Potassium ...	40	50	49.1 <sup>13</sup>	—	2.7777	84.72	—	<sup>12</sup> Quoted from Dr. Thomson, <i>Annals of Philosophy</i> , iv. 13.	
Barytium ...	70	87.5	87 <sup>14</sup>	—	4.8611	148.26	—	<sup>13</sup> Dr. W. from Berzelius.	
Iodine ....	124	155	156.21 <sup>15</sup>	—	8.6111	262.632	—	<sup>14</sup> Dr. W. from Berzelius and Klaproth. <sup>15</sup> Gay-Lussac. <i>Ann. de Chim.</i> xci. 5.	

TABLE II.—Combinations with Oxygen.

Name.	Wt. sp. hydro. being 1.	Wt. of atom, being 1.	Wt. of atom, being 10.	Wt. of atom, being 10, from exper.	Sp. gr. atmos. air being 1.	Sp. gr. atmos. from exper.	Wt. of 100 cu. in. Bar. 30.	Wt. of 100 cu. in. from exp.	Elements by volume.	No. of vol. after combi. nation.	Elements by weight.	Observations.
Water .....	9	11.25	11.32	.625	.6896 <sup>1</sup>	19.062	21.033	.5 ox + 1 hyd	1	1 ox + 1 hy		<sup>1</sup> Trales, Dr., Thomson, <i>Annals</i> , i. 177.
Carbonic oxide ..	14	17.5	17.54	.9722	.956 <sup>2</sup>	29.652	29.10	.5 ox + 1 ca	1	1 ox + 1 car		<sup>2</sup> Cruikshanks, quoted by Thomson.
Nitrous oxide.....	22	27.5	—	1.5277	1.611 <sup>3</sup>	46.596	49.227	.5 ox + 1 az	1	1 ox + 1 az		<sup>3</sup> Sir H. Davy.
Atmospheric air..	36	45	—	1.000	1.000	30.5	50.5 <sup>4</sup>	.5 ox + 2 az	2.5	1 ox + 2 az		<sup>4</sup> Sir G. S. Evelyn.
Phosphorous acid								.5 ox + 1 ph?		1 ox + 1 ph?		
Oxide of sulphur?	44	55		3.0555	2.409 <sup>5</sup>	93.192	73.474	.5 ox + 1 ch	1?	1 ox + 1 ch		<sup>5</sup> Sir H. Davy.
Iochlorine .....	28	35	35.46	1.9444	—	59.304	—	.5 ox + 1 iod		1 ox + 1 iod		
Lime .....								.5 ox + 1 cal		1 ox + 1 cal	&c.	
Carbonic acid ..	22	27.5	27.51	1.5277	1.5187	46.596	46.313	1 ox + 1 hy <sup>6</sup>	1	2 ox + 1 hy		<sup>6</sup> This and all higher combinations of hydrogen with oxygen are unknown.
Nitrous gas .....	15	37.5	37.5	1.0416	1.0388 <sup>8</sup>	31.77	31.684	1 ox + 1 az	2	2 ox + 1 az		<sup>7</sup> Saussure.
Phosphoric acid..	30	37.5	37.4	2.0832	—	63.54	—	1 ox + 1 ph	1	2 ox + 1 ph		<sup>8</sup> Berard.
Sulphurous acid ..	32	40		2.2222	2.193 <sup>9</sup>	67.777	66.89	1 ox + 1 sul	1	2 ox + 1 sul		<sup>9</sup> Sir H. Davy.
								1 ox + 1 ch		2 ox + 1 ch		
								1 ox + 1 iod		2 ox + 1 iod		
								&c.		&c.		
Nitrous acid .....	38	47.5		2.6888	2.427 <sup>10</sup>	80.484	74.023 <sup>4</sup>	1.5 ox + 1 car	1	3 ox + 1 car		<sup>10</sup> Sir H. Davy.
Sulphuric acid....	40	50	50	2.7777	—	84.72	—	1.5 ox + 1 az	1	3 ox + 1 az		
								1.5 ox + 1 ph		3 ox + 1 ph		
								1.5 ox + 1 sul		3 ox + 1 sul		
								1.5 ox + 1 ch		3 ox + 1 ch		
								1.5 ox + 1 iod		3 ox + 1 iod		
								&c.		&c.		
Nitric acid .....	54	67.5	67.54	3.75	—	114.372	—	2.5 ox + 1 car	1	5 ox + 1 car		See Gay-Lussac's memoir on iodine above referred to.
								2.5 ox + 1 az		5 ox + 1 az		
								2.5 ox + 1 ph		5 ox + 1 ph		
								2.5 ox + 1 sul		5 ox + 1 sul		
Chloric acid .....	76	95		5.2777	—	160.968	—	2.5 ox + 1 ch	1	5 ox + 1 ch		
Iodic acid. ....	164	205		11.3888	—	347.352	—	2.5 ox + 1 iod	1	5 ox + 1 iod	&c.	

TABLE III.—Compounds with Hydrogen.

Name.	Sp. gr. hydro. being 1.	Wt. of atom, 2 vol. hydr. being 1.	Wt. of atom, oxygen being 10.	Wt. of atom, oxygen being 10, from experiment.	Sp. gr. atmospheric air being 1.	Sp. gr. atmospheric air being 1, from experiment.	Wt. of 100 cub. inch. Bar. 30. Ther. 60.	Wt. of 100 cub. inch. from exper.	Elements by volume.	No. of vol. after combination.	Elements by weight.	Observations.
Carburated hydrogen....	8	8.75	8.86	.5555	.5555 <sup>1</sup>	16.999	16.999	2 hy + 1 car	1	1 hy + 1 car	1 Dr. Thomson.	
Olefiant gas .....	14	16.25	16.4	.9722	.974 <sup>2</sup>	29.652	29.72	2 hy + 2 car	1	1 hy + 2 car	2 Ditto.	
Hydro-phosphorus gas ..								1 hy + 1 az			.5 hy + 1 az	I have omitted these from the uncertainty that still hangs over phosphorus. This compound is at present unknown, but it probably exists in fulminating gold, silver, &c. united to these metals.
Pho-phoreted hydrogen..												
Ammonia .....	8.5	19.375	21.53	.5902	.593	18.003	18.00	3 hy + 1 az	2	1.5 hy + 1 az	3 Dr. Wollaston.	
Sulphureted hydrogen....	17	20.625	20.66	1.1805	1.1774	36.006	35.89	1 hy + 1 sul	1	.5 hy + 1 sul	4 Sir H. Davy.	
Muriatic acid .....	18.5	45.625	45.66	1.284	1.2785	39.183	38.979	1 hy + 1 ch	2	.5 hy + 1 ch	5 Ditto.	
Hydriodic acid .....	62.5	155.625	155.66	4.3402	4.3463	132.375		1 hy + 1 iode	2	.5 hy + 1 iod	6 Gay-Lussac.	

TABLE IV.—*Substances stated from Analogy, but of which we are yet uncertain.*

Name.	Sp. gr. hydr. being 1.	Wt. of atom, 2 vol. hydr. being 1.	Wt. of atom, oxygen being 10.	Wt. of atom, ox. being 10, from exper.	Observations.
Aluminium . . . . .	8	8	10	10·68 <sup>1</sup>	<sup>1</sup> Berzelius.
Magnesium . . . . .	12	12	15	14·6 <sup>2</sup>	<sup>2</sup> Henry. Berzelius makes it 15·77.
Chromium . . . . .	18	18	22·5	23·6 <sup>3</sup>	<sup>3</sup> Berzelius.
Nickel . . . . .	28	28	35	36·5 <sup>4</sup>	<sup>4</sup> Ditto.
Cobalt . . . . .	28	28	35	36·6 <sup>5</sup>	<sup>5</sup> Rolhoff.
Tellurium . . . . .	32	32	40	40·27 <sup>6</sup>	<sup>6</sup> Berzelius.
Copper . . . . .	32	32	40	40·7	<sup>7</sup> As deduced by Dr. Thomson.
Strontium . . . . .	48	48	60	59 <sup>8</sup>	<sup>8</sup> Klaproth.
Arsenic . . . . .	48	48	60	60·9	<sup>9</sup> Berzelius.
Molybdenum . . . . .	48	48	60	60·13 <sup>10</sup>	<sup>10</sup> Bucholz and Berzelius.
Manganese . . . . .	56	56	70	71·15 <sup>11</sup>	<sup>11</sup> Berzelius.
Tin . . . . .	60	60	75	73·5 <sup>12</sup>	<sup>12</sup> Ditto.
Bismuth . . . . .	72	72	90	89·94 <sup>13</sup>	<sup>13</sup> Ditto.
Antimony . . . . .	88	88	110	111·11 <sup>14</sup>	<sup>14</sup> Ditto. Dr. Thomson makes it 112·49.
Cerium . . . . .	92	92	115	114·87 <sup>15</sup>	<sup>15</sup> Hisinger.
Uranium . . . . .	96	96	120	120 <sup>16</sup>	<sup>16</sup> Bucholz.
Tungsten . . . . .	96	96	120	121·21 <sup>17</sup>	<sup>17</sup> Berzelius.
Platinum . . . . .	96	96	120	121·66 <sup>18</sup>	<sup>18</sup> Ditto.
Mercury . . . . .	100	100	125	125 <sup>19</sup>	<sup>19</sup> Fourcroy and Thenard.
Lead . . . . .	104	104	130	129·5 <sup>20</sup>	<sup>20</sup> Berzelius.
Silver . . . . .	108	108	135	135 <sup>21</sup>	<sup>21</sup> Wenzel and Davy.
Rhodium . . . . .	120	120	150	149·03 <sup>22</sup>	<sup>22</sup> Berzelius.
Titanium . . . . .	144	144	180	180·1 <sup>23</sup>	<sup>23</sup> Ditto.
Gold . . . . .	200	200	250	249·68 <sup>24</sup>	<sup>24</sup> Ditto.

*Observations.*

*Table I.*—This, as well as the other tables, will be easily understood. In the first column we have the specific gravities of the different substances in a gaseous state, hydrogen being 1: and if we suppose the volume to be 47·21435 cubic inches, the numbers will at the same time represent the number of grains which this quantity of each gas will weigh. In the third column are the corrected numbers, the atom of oxygen being supposed, according to Dr. Thomson, Dr. Wollaston, &c. to be 10: and in the fourth, the same, as obtained by experiment, are stated, to show how nearly they coincide. Of the individual substances mentioned, I have no remark to make, except with respect to iodine. I made but one experiment to ascertain the weight of the atom of this substance, and therefore the results stated may be justly considered as deserving but little confidence; and indeed this would be the case, did not all the experiments of Gay-Lussac nearly coincide in the same.

*Table II.*—This table exhibits many striking instances of the near coincidence of theory and experiment. It will be seen that Gay-Lussac's views are adopted, or rather indeed anticipated, as a good deal of this table was drawn up before I had an opportunity of seeing the latter part of that chemist's memoir on iodine. That table also exhibits one or two striking examples of the errors that have arisen from not clearly understanding the relation between the doctrine of volumes and of atoms. Thus ammonia has been stated to be composed of one atom of azote and three of hydrogen, whereas it is evidently composed of one atom of azote and only 1.5 of hydrogen, which are condensed into two volumes, equal therefore to one atom; and this is the reason why this substance, like some others, apparently combine in double proportions.\*

*Table III.*—This table likewise exhibits some striking examples of the coincidence above noticed. Indeed, I had often observed the near approach to round numbers of many of the weights of the atoms, before I was led to investigate the subject. Dr. Thomson appears also to have made the same remark. It is also worthy of observation, that the three magnetic metals, as noticed by Dr. Thomson, have the same weight, which is exactly double that of azote. Substances in general of the same weight appear to combine readily, and somewhat resemble one another in their nature.

On a general review of the tables, we may notice,

1. That all the elementary numbers, hydrogen being considered as 1, are divisible by 4, except carbon, azote, and barytium, and these are divisible by 2, appearing therefore to indicate that they are modified by a higher number than that of unity or hydrogen. Is the other number 16, or oxygen? And are all substances compounded of these two elements?

2. That oxygen does not appear to enter into a compound in the ratio of two volumes or four atoms.

3. That all the gases, after having been dried as much as possible, still contain water, the quantity of which, supposing the present views are correct, may be ascertained with the greatest accuracy.

Others might doubtless be mentioned; but I submit the matter for the present to the consideration of the chemical world.

\* See Gay-Lussac's memoir on iodine, *Annals of Philosophy*, vi. 189.



## ARTICLE II.

*Observations on the Absorption of the Gases by different Bodies.*  
By Theodore de Saussure.

(Concluded from p. 255.)

## SECTION SECOND.

## SIMULTANEOUS ABSORPTION OF DIFFERENT GASES BY A SINGLE SOLID POROUS BODY.

THE experiments hitherto made relate to the absorption of a single gas not mixed with any other. I come now to the more intricate problem, to examine whether when various gases have been absorbed by a porous solid body, their absorption corresponds with that which takes place when the gases are in a separate state. I have made these experiments two different ways: 1. I put the solid body freed from air into a mixture of two gases. 2. I brought the solid body first in contact with a single gas; and when it was saturated with this gas, I transferred it into a second gas. The eudiometrical examination of the air remaining behind after this second absorption enabled me to know the proportion in which both gases had been absorbed.

7. *Condensation of mixed Gases by Charcoal.*

Messrs. Rouppe and Norden have informed us (Ann. de Chim. t. 34) that when charcoal, saturated at the common temperature with hydrogen, is put into oxygen gas, water is seen condensing itself on the sides of the receiver in drops, whereby heat is disengaged, and oxygen gas absorbed. The same thing takes place, according to their statement, when the experiment is reversed, by introducing charcoal saturated with oxygen gas into hydrogen gas. In these assertions, which have never been contradicted, there is nothing contrary to the generally received opinions. It is reasonable to think that the condensation which the gases experience in the charcoal facilitate the union of their bases. It is therefore quite contrary to my expectation that I see myself obliged to call in question the statement of these Dutch chemists.

I made my experiments with *oxygen gas, hydrogen gas, azotic gas, and carbonic acid gas*, mixed together two and two. For the sake of perspicuity, I shall first state the general results which I obtained, and then enter into more particular details, in order to show which of the gases in these experiments was absorbed in the greatest quantity.

(A)—When a piece of charcoal saturated with one of these gases is put into another, it allows a portion of the first gas to escape, in order to absorb into its pores a portion of the second gas.

According as the condensation of the gas first absorbed by the

charcoal is greater or smaller than that of the gas into which it is put, the atmosphere surrounding the charcoal is increased whereby cold is produced, or diminished whereby heat is disengaged. We have seen, for example, that charcoal absorbs much more carbonic acid gas than hydrogen gas. When a piece of charcoal saturated with carbonic acid is put into hydrogen gas, the bulk of the gas increases very remarkably, and the charcoal becomes colder. There is absorbed only a very small quantity of hydrogen gas into the pores of the charcoal, while a far greater proportion of carbonic acid gas is disengaged; and this small quantity of hydrogen occupies in the pores of the charcoal exactly the same space as the carbonic acid gas disengaged did. Suppose, on the contrary, that a piece of charcoal saturated with hydrogen gas is put into a receiver filled with carbonic acid gas, the bulk of the gas is diminished, and the charcoal becomes warmer. A considerable proportion of carbonic acid gas is absorbed by the charcoal, while only a very small quantity of hydrogen gas is disengaged; and the former occupies exactly the space which the latter left. Oxygen gas (according to paragraph 1) is absorbed in greater proportion by charcoal than hydrogen gas. These two gases, therefore, exhibit the same phenomena. A piece of charcoal saturated with oxygen gas being put into hydrogen lets a greater proportion of the former gas go than it absorbs of the latter. Hence the bulk of the gas is increased, and cold produced. On the other hand, when charcoal saturated with hydrogen is put into oxygen gas, the volume of air is diminished, and heat produced. In this way, from the table given in paragraph 1, of the rate of condensation of the pure gases by charcoal, the consequence may always be foretold in every one of these experiments. The absorbed gas in these cases separates itself from the charcoal precisely as it does from water impregnated with the gas, when that liquid is placed in contact with another species of gas.

(B)—The volume of gas expelled from charcoal by another gas varies according to the proportion in which both gases exist in the unabsorbed residue. The quantity expelled is always the greater, the more there is an excess of the gas which produced it. Yet it is not possible in close vessels to expel the whole of one gas out of charcoal by means of another; a small quantity always remains in the charcoal.

(C)—Two gases united by absorption in charcoal often experience a greater condensation than each would in a separate state. For example, the presence of oxygen gas in charcoal facilitates the condensation of hydrogen gas; the presence of carbonic acid gas, or of azotic gas, facilitates the condensation of oxygen gas; and that of hydrogen gas, the condensation of azotic gas. Yet this effect does not take place in all cases with the four gases now mentioned; for the presence of azotic gas in charcoal does not promote the absorption of carbonic acid gas.

(D)—When the absorption of one of the four named gases has been facilitated by another of them, no perceptible combination

between the two takes place, at least within the interval of some days. So, for example, notwithstanding the assertion of Rouppe and Norden, no separation of water appears when charcoal saturated with hydrogen at the common temperature is put into oxygen gas, or when the experiment is reversed. As little was it in my power in this way to unite azotic and hydrogen gases into ammonia, or azotic and oxygen gases into nitric acid.

I shall now give a more particular account of some of these experiments, which all gave me analogous results, differing from each other only in degree.

*Introduction of a piece of Charcoal saturated with Hydrogen into a Receiver full of Oxygen Gas.*

A volume of box-wood charcoal, which had absorbed 1.75 times its bulk of hydrogen, was at the temperature of  $52^{\circ}$  put into 20.45 times its bulk of oxygen gas, which contained  $\frac{2}{100}$  of azote. The charcoal reduced this atmosphere 6.5 volumes.\* A thermometer brought in contact with the charcoal, when the absorption was at its greatest rapidity, rose  $4.4^{\circ}$ .† This elevation of temperature is smaller than that which is produced by the absorption of oxygen gas. In vain did I endeavour in these experiments, and in others made with a larger piece of charcoal, to perceive some of the water which, according to Rouppe and Norden, ought to be formed.

The gas remaining in the receiver was no longer pure oxygen gas, but contained, when examined by Volta's eudiometer, a volume of hydrogen gas. Oxygen gas, at the same time, had been absorbed by the charcoal, and had driven off more than the half of the hydrogen formerly contained in the charcoal. Notwithstanding this, the gas in the receiver was diminished  $6\frac{1}{2}$  volumes. Hence the charcoal had absorbed  $6\frac{1}{2} + 1 = 7\frac{1}{2}$  volumes of oxygen, and one volume of hydrogen had been driven off.

It may be asked now, whether these changes of space are in the

\* The change of volume was ascertained 24 hours after the charcoal had been put into it. The receiver in which the absorption took place was a wide glass tube, not much larger than the diameter of the charcoal, the bulk of which was about 2.5 cubic centimetres (0.152 cubic inch English).

† Rouppe and Norden have ascribed this elevation of temperature to the combination of the oxygen and the hydrogen, and the formation of water, of which, according to them, a perceptible quantity is evolved. They did not perceive that this heat was occasioned by the condensation of the oxygen gas. Both reason and experiment are against the possibility of the water being visible, even if it were formed; for in my experiments, as well as in those of these chemists, the charcoal had absorbed less than twice its bulk of hydrogen: now that at most could form no more water than the five-thousandth part of the weight of the charcoal. But experiment informs us that a well dried charcoal, like that which I employed in my experiments, can absorb more than the tenth part of its weight of water, and yet remain dry, and allow no perceptible portion of that liquid to escape, at the temperature of  $122^{\circ}$  or  $140^{\circ}$ . Besides, I obtained the same result when I operated upon pieces of charcoal ten or twelve times larger. The heat was indeed somewhat greater; but always less than what was generated by the absorption of oxygen alone by the same piece of charcoal.

same proportion in which the bulks stand, which the single gases occupy in the charcoal? According to paragraph 1, one volume of box-wood charcoal freed from air absorbs 9·2 volumes of oxygen and 1·75 of hydrogen gases. According to these proportions, 7·5 volumes of oxygen ought to have expelled 1·42 volumes of hydrogen. But as the quantity expelled was only one volume, we see that the presence of hydrogen gas increases the condensation of oxygen gas in charcoal, which retains at the same time 0·75 of hydrogen and 7·5 volumes of oxygen gas. It will be obvious, without my pointing it out, that the bulks 0·75 and 7·5 are by no means in the requisite proportion to one another for forming water.

To follow out this subject still further, I put a piece of charcoal saturated with the two gases (without allowing it to come in contact with the air) into a jar filled with mercury, and containing a little water. The charcoal absorbed this water; and in 48 hours allowed 3·11 volumes of oxygen and 0·13 of hydrogen gas to escape. Now according to paragraph 2, charcoal which has absorbed 9·2 volumes of oxygen when placed in contact with water lets go 3·2 volumes, and still therefore retains six volumes. While in the present case, in consequence of the presence of hydrogen in charcoal of the 7·5 volumes of oxygen, 3·11 volumes are disengaged by the water, and only 4·39 volumes remain behind. These two gases, therefore, have not united in the proportions which constitute water. Besides this, I have extricated an additional quantity of oxygen and hydrogen gases out of the same charcoal, by boiling it in water. It is true that the temperature is not sufficiently high to expel the whole of the gases: but this is the case likewise when only one gas is present.

The following experiment, which is the reverse of the preceding, still further increases the doubts about the formation of water by the union of oxygen and hydrogen in charcoal at the ordinary temperature of the atmosphere.

*Introduction of a piece of Charcoal saturated with Oxygen into a Receiver containing Hydrogen Gas.*

According to Messrs. Rouppe and Norden, the appearances which they describe take place likewise in this case. There is the same diminution of the bulk of the gas in the receiver, the temperature of the charcoal increases, water is formed, which first appears in vapour, and then falls upon the sides of the receiver in drops. But I have obtained quite different results. The quantity of gas round the charcoal increased, the thermometer sank, and no formation of water was perceptible.

A volume of box-wood charcoal, which, after exposure to a red heat, had absorbed 9·2 volumes of oxygen at the temperature of 52°, was put into 15·6 volumes of hydrogen gas. The bulk of the gas increased 3·21 volumes; so that it amounted to 18·81 volumes: and a thermometer, which at the beginning of the process had been

placed in contact with the charcoal, fell  $0.9^{\circ}$ .\* By a chemical analysis of the gas, I found that the receiver contained hydrogen and 4.55 volumes of oxygen gas, which, subtracted from 18.81 volumes, leaves 14.26 volumes of hydrogen. Hence there was absorbed by the charcoal  $15.6 - 14.26 = 1.34$  volumes of hydrogen gas: and this quantity had expelled 4.55 volumes of oxygen gas.

As we have seen above that charcoal free from air absorbs 9.2 volumes of oxygen, or 1.75 of hydrogen gas, it is evident from the rate of absorption that 1.34 volume of hydrogen occupies the same space in the coal as 7.03 volumes of oxygen gas; instead of which only 4.55 volumes of oxygen gas were expelled by the hydrogen. In the present, as well as in the reverse experiment, the condensation of the hydrogen gas was promoted by the presence of the oxygen.

When the same piece of charcoal, containing 1.34 volume of hydrogen and 4.75 volumes of oxygen gas, was put into a receiver filled with mercury, and containing some water, it gave out 0.74 volume of hydrogen and 0.23 volume of oxygen gas. But out of a piece of charcoal saturated with hydrogen (1.75 volume) alone, water disengages 1.1 volume, and of course 0.65 volume remains behind. Our charcoal, on the contrary, saturated with both gases, left only  $1.34 - 0.74 = 0.60$  volume of hydrogen behind. The oxygen gas present in it prevented it from retaining the whole hydrogen, which it otherwise would have done. The oxygen, therefore, could not be present in the state of water.

As we have no method of separating the whole of either a single gas or of two gases absorbed by charcoal without destroying it, I cannot show decisively that a very small quantity of water is not formed in these cases; but all appearances, as we have seen, are against that supposition. 1. The absorption of the oxygen and hydrogen are in quite different proportions from those that form water. 2. The temperature sinks when the hydrogen is absorbed last. 3. Both gases are driven off by water in very different proportions from what would be requisite to form water.

I must now observe that the quantities of oxygen and hydrogen gases which a piece of charcoal absorbs, vary according to the proportions of both which remain behind in the receiver, and that both of these stand to each other in a determinate ratio. Thus when a piece of charcoal saturated with oxygen is put into 15.6 volumes of hydrogen gas, 4.55 volumes of oxygen are disengaged, in place of which 1.34 volume of hydrogen is absorbed. But if the same charcoal be put into 11 volumes of hydrogen gas, only 3.12 volumes of oxygen is evolved, and 0.76 volume of hydrogen absorbed. The residual gas in this case contains a greater proportion of oxygen than

\* The charcoal had nearly the same bulk as in the preceding experiment. If larger pieces be employed, the change of temperature is more remarkable. But the experiments are made more easily, and with more accuracy, with small portions of gas, and small pieces of charcoal.

in the former. This free communication between the gases in the charcoal, and those surrounding it, is a proof that the gases mixed in the charcoal do not form any lasting combination, as would be the case if water were formed; but that, in consequence of their mutual contact in the charcoal, they are merely a little condensed.

If charcoal free from air, but drenched in water, be brought in contact with oxygen gas, carbonic acid gas, or azotic gas, these gases, while they penetrate into its pores, drive out a portion of the water. It is to be presumed that Messrs. Rouppe and Norden took this disengaged water for new formed water. This is the more probable, as in their experiments the gases stood over water, of which the charcoal, while it absorbed the gases, must have imbibed a certain portion.

I pass over the detail of the experiments which I made respecting the mutual expulsion of gases from charcoal with hydrogen and azotic gases, oxygen and azotic gases, and oxygen and carbonic acid gases. They were made with the same care as those with oxygen and hydrogen gases; and they furnished similar results, with the exception that azotic and carbonic acid gases, when in contact in charcoal, do not appear to increase the condensation of each other. In all other respects, as may be easily conceived, these mutual expulsions are so much the more conspicuous, the greater the difference of condensation is which both gases undergo when absorbed by charcoal. Hence it is very striking when the gases are hydrogen and carbonic acid; and most of all, when they are ammonia and hydrogen.

From this action of the gases on each other, which expel each other from a porous body, it is evident that a porous body which has saturated itself with atmospherical air, and which is put into a gas without being deprived of air, may either increase or diminish the volume of that gas, according as it is absorbed in greater or smaller quantity than common air. In like manner, a piece of charcoal or of meerschaum saturated with common air will perceptibly diminish a given volume of carbonic acid, and increase that of hydrogen gas, in which it is put. It is highly probable that the odoriferous vapours of bodies rendered evident by moist air, and likewise the smells of flowers, depend upon such mutual expulsions of gaseous bodies.

If a piece of charcoal free from air be put into a mixture of oxygen and hydrogen gases, an absorption takes place, which holds the same proportion with respect to the two gases as when the charcoal is first saturated with the one, and then placed in the other. I placed, for example, a piece of box-wood charcoal free from air into 16 volumes of a mixture containing  $\frac{1}{3}$  oxygen and  $\frac{2}{3}$  hydrogen gases; so that both gases were in the proportions requisite for the formation of water. Of this mixture, very nearly three volumes of oxygen and one volume of hydrogen were absorbed. This result corresponds very well with the proportion of single gases that would have been absorbed, and likewise the relative proportion in which they were mixed before absorption.

When a piece of box-wood or beech charcoal free from air is exposed to common air, it absorbs more oxygen than azote, so that the air is injured by it; but not much, as the difference between the quantity of these gases absorbed by charcoal is not great. Hence that this consequence, which Messrs. Rouppe and Norden deny, may take place, the volume of residual air, in comparison of that of the charcoal, must be small.

#### 8. *Simultaneous Absorption of various Gases by different Bodies.*

In general all porous bodies exhibit the same appearances in respect to the mutual expulsion and condensation of the gases coming in contact with them as charcoal does. Yet these expulsions may take place in an opposite order when the affinity of the body for the gases is different. In this respect the results are striking which *meerscham*, *ligniform asbestus*, *adhesive slate* of Mesnil Montant, and Saxon *hydrophane*, give when they are brought in contact with mixtures of carbonic acid \* or ammoniacal gas with oxygen, hydrogen, or azotic gas. A mixture of the two or three last gases requires more attention, and the consequence is not always perceptible. As in these experiments it appears of no consequence whether the porous body be first saturated with one gas, and then put into the other; or whether it be put into a mixture of the two gases; I shall describe here only the results which I obtained in the last way, as it is the shortest. The experiments were made in temperatures between 59° and 62°. The same pieces were employed in all of them; and each porous body was allowed to remain 24 hours in the mixture before the residual gas was examined.

#### *Meerscham in a mixture of Oxygen and Hydrogen Gases.*

A volume of *meerscham* freed from air was put into  $2\frac{1}{2}$  volumes of gas, one half of which was oxygen, and the other hydrogen. It absorbed 0.57 volume of oxygen and 0.44 of hydrogen; therefore more of the first than of the last. This is conformable to the order of absorption of the gases when not mixed. When we compare the bulk which both gases occupy in the *meerscham*, with the sum of their bulks when single, we perceive that the presence of the oxygen has promoted the condensation of the hydrogen gas.

The same experiment was made with the adhesive slate of Menil Montant. A volume of this stone absorbed 0.7 of the mixture. The proportion of each gas absorbed was the same, though the stone absorbs more oxygen gas when alone than it does of hydrogen gas. The difference was either too small to be perceptible, or the presence of the oxygen had promoted the condensation of the hydrogen to such a degree as to make its bulk equal to that of the

\* Perhaps the small quantity of carbonic acid which some porous stones, as the *meerscham* of Natolia, contain, is only accidental, or what the water in them is able to retain by means of capillary attraction.



oxygen. In the same way, meerschaum did not sensibly alter the composition of atmospherical air.

*Meerschaum, Charcoal, and Wood, in a Mixture of equal Volumes of Azotic and Hydrogen Gases.*

A volume of meerschaum free from air absorbed, from 2·5 volumes of such a mixture, 0·61 volume of azote and 0·42 volume of hydrogen; therefore more of the first than of the last. These two gases seem to have been rendered somewhat denser by their contact in the stone. A volume of box-wood charcoal free from air absorbed, from 16 volumes of such a mixture, 3·5 volumes of azote and 0·9 of hydrogen.\* A volume of fir-wood free from air absorbed, from four volumes of the mixture, 0·34 volume hydrogen and 0·11 azote. Wood, then, produces just the opposite effect upon these gases that meerschaum does; yet the absorption of the mixture by the wood agrees with its absorption of the gases separately.

All my attempts, in these experiments, and in others which I do not mention, to detect the formation of water, ammonia, or nitric acid, were entirely abortive. I employed no other heat to assist me but what was disengaged by the absorption of the gases; yet my experiments were not sufficiently varied, nor continued long enough, to destroy all hopes of meeting with cases in which such a formation may take place; especially when we employ the intermediate action of water, and such absorbing bodies as have a chemical affinity for these products.

### SECTION THIRD.

#### ABSORPTION OF THE GASES BY LIQUIDS.

##### 9. Dalton's Theory.

That all gases are absorbed by liquids, and that most of them are again separated by heat or the diminution of external pressure, has been long known. We now possess accurate results respecting the rate of this absorption. For a set of careful and regular experiments on this subject we are indebted to Dr. Henry, of Manchester. Mr. Dalton has a little altered some of these results; and by means of them has contrived a theory which not only explains the absorption of gases by water, but by all other liquids; but it is in opposition to most of the results which I have obtained by means of solid porous bodies.

According to him, those gases which separate from liquids when the pressure of the atmosphere is removed are merely held in mechanical union, and are by no means in chemical combination with these liquids. He affirms, further, that water, at a medium temperature, and under a medium pressure of the atmosphere, can

\* In this experiment the gases and charcoal remained in contact five weeks; but after the first day the volume of the mixture was not altered in the least. On immersing the charcoal in cold water, 2·55 volumes of azote and 0·64 of hydrogen were driven out.

only absorb gases according to the following law. It absorbs either a volume of the gas equal to its own volume, as is the case with carbonic acid, sulphureted hydrogen, and nitrous oxide; or to  $\frac{1}{8}$  of its volume, as is the case with olefiant gas; or to  $\frac{1}{7}$  of its volume, as is the case with oxygen and nitrous gas; or to  $\frac{1}{4}$  of its volume, as is the case with azote, hydrogen, and carbonic oxide: so that the volumes of absorbed gas in these four divisions may be represented by the series  $(\frac{1}{1})^3$ ,  $(\frac{1}{2})^3$ ,  $(\frac{1}{3})^3$ ,  $(\frac{1}{4})^3$ , the volume of water being represented by 1.\* The same law holds, according to Dalton, for all liquids that are not glutinous, as for alcohol, acids, and solutions of salts in water; though between the solution and some gases an affinity may perhaps exist, as between a solution of an alkaline sulphuret and oxygen gas. Finally, he establishes, from some experiments of Dr. Henry, that water which has absorbed one gas, and is placed in contact with another, always allows as much of the first to escape, and absorbs, on the contrary, so much of the other, that the mixture of gases, which after this exchange remains behind in the water, is exactly in the same proportion as would have been produced by the absorption of each of them singly by the water, supposing each of the density which it has in the gaseous mixture. According to this, water would absorb, from a mixture of two gases in equal proportions, only one half of the volume of each which it would absorb if the gas were in a separate state.

The following experiments will enable us to examine the accuracy of these propositions.

#### 10. *Absorption of unmixed Gases by different Liquids.*

I endeavoured to free the liquids which I used in my experiments from air as completely as possible, by long and violent boiling. Those which would have been altered or dissipated by the application of such a heat, as oils and some salt solutions, were freed from air by means of the air-pump. Neither of these methods is capable of freeing liquids completely from air; and the more volatile the liquid is, they succeed the more imperfectly, because they can only be exposed to a lower temperature, and the pressure of the vapour which rises from them under the air-pump prevents the escape of their air.

To produce a speedy and complete absorption, I put a large quantity of those gases which are absorbed only in small quantity by liquids, as of azote, oxygen, and hydrogen, with a small quantity of the liquid, into a flask, which was furnished with an excellent ground stopper, and agitated the flask for a quarter of an hour. This is a difficult method, and requires much attention.† With respect to all the gases of which the liquid absorbs more than  $\frac{1}{4}$  of

\* According to him, 100 volumes of water, at the temperature of 61°, absorb 100 volumes of the first three gases, 12.5 volumes of olefiant gas, 3.7 of oxygen and azote, and 1.56 of the last three gases.

† More will be said on this subject in the Appendix.

its bulk, I proceeded, on the contrary, in the following manner. I placed them over mercury in a tube four centimetres (1·575 inch) of internal diameter, and let up a column of the absorbing liquid five or six centimetres (1·79 to 2·36 inches) in length. The absorption was promoted by agitation, and its quantity was not determined till the gas and the liquid had been in contact for several days.

The following table exhibits the quantity of the different gases absorbed, according to these experiments, by water and alcohol.

	100 volumes of Water.	100 volumes of Alcohol. Sp. Gr. 0·84.
	Volumes.	Volumes.
Sulphurous acid gas .....	4378	11577
Sulphureted hydrogen* .....	253	606
Carbonic acid .....	106	186
Nitrous oxide .....	76	153
Olefiant gas .....	15·3	127
Oxygen gas .....	6·5	16·25
Carbonic oxide .....	6·2	14·5
Oxy-carbureted hydrogen.....	5·1	7·0
Hydrogen .....	4·6	5·1
Azote .....	4·1	4·2

A hundred volumes of water absorb about five volumes of atmospheric air, when the mass of air is very great, in comparison of that of the water.

From these experiments it appears, contrary to Dalton's assertion, that the absorption of gases by different, not glutinous liquids, as water and alcohol, is very far from being similar. The alcohol, as we see, often absorbs twice as much of them as water does. In gases which are absorbed in small quantities, this difference is not so striking; because with respect to them the absorptions of the alcohol can be less accurately determined, on account of the air which still remains in it after being boiled. Those gases which are absorbed in great quantity suffer but little opposition from this air. In the remaining gases, its influence becomes the more striking the more nearly the absorbability of the gas and the air approach to a state of equality.

These experiments agree no better with the law, which Dalton thinks he has ascertained in the absorption of different gases by one and the same liquid; for I find too great a difference between the quantity of carbonic acid, sulphureted hydrogen, and nitrous oxide gases, absorbed by the same liquids (which Dalton considers as completely equal), to be able to ascribe it to errors in the experiments.

\* It was, according to the direction of Gay-Lussac and Thenard, prepared from sulphuret of antimony by means of muriatic acid, and in the absorption all mercury was kept out of play.

11. *Influence of Chemical Affinity on the Absorption of Gases.*

If such an influence did not exist, the gases would be absorbed by all liquids in the same order. As I had not perceived any distinct difference between water and alcohol in this respect, I tried other liquids, and I confined my experiments to four gases, namely, carbonic acid, nitrous oxide, olefiant gas, and carbonic oxide. I excepted oxygen gas from these experiments, because it forms permanent compounds with most of the liquids to be employed, which are not modified by the pressure of the atmosphere. Azotic and hydrogen gas were also excluded, because they are absorbed in such small quantities that the difference in the rate could not be accurately ascertained. The experiments were made at the temperature of  $64\cdot5^{\circ}$ .

A hundred volumes of rectified white and transparent native naphtha, of the specific gravity  $0\cdot784$ , absorbed

	Volumes.
Olefiant gas .....	261
Nitrous oxide .....	254
Carbonic acid .....	169
Carbonic oxide .....	20

A hundred volumes of fresh distilled essential oil of lavender, of the specific gravity  $0\cdot88$ , absorbed

	Volumes.
Nitrous oxide .....	275
Olefiant gas .....	209
Carbonic acid .....	191
Carbonic oxide .....	15\cdot6

A hundred volumes of olive oil,

	Volumes.
Carbonic acid .....	151
Nitrous oxide .....	150
Olefiant gas .....	122
Carbonic oxide .....	14\cdot2

A hundred volumes of a saturated solution of muriate of potash in water,

	Volumes.
Carbonic oxide .....	61
Nitrous oxide .....	21
Olefiant gas .....	10
Carbonic oxide .....	5\cdot2

It follows from these experiments, that in liquids, as well as in solid bodies, great differences take place in the order in which gases are absorbed by them, and that in consequence these absorptions are always owing to the influence of chemical affinity.

Solid bodies appear, under the same circumstances, to produce a greater condensation of all gases in the contact of which they are placed than liquid bodies do. I have met with no liquid which absorbs so great a volume of carbonic acid, olefiant gas, azotic gas, carbonic oxide, and nitrous oxide, as charcoal and meerschaum do. The difference is probably owing to this circumstance, that liquids, in consequence of the great mobility of their parts, cannot compress the gases so strongly as is necessary for greater condensation; certain cases excepted, where very powerful chemical affinities come to their assistance; as, for example, the affinity of ammonia and muriatic acid for water. Only in these rare cases do liquids condense a greater quantity of gases than solid bodies.\* While in these last bodies the size of the pores determines the space occupied by the absorbed gas, the parts of liquid bodies, in consequence of their separation from each other, have a disposition to increase their distance, in proportion as the gases are absorbed. †

12. *Influence of the Viscidity and of the Specific Gravity of Liquids on their Absorption of Gases.*

In my experiments on the influence of the physical state of the liquid upon its power of absorbing, I have employed carbonic acid gas, which I have placed in contact with a great number of liquids, very different both in their liquidity and in their specific gravity. The following table exhibits the result of these experiments: they were performed at the temperature of 62·5°: and likewise the bulk of carbonic acid gas absorbed by one volume of the different liquids:—

Liquids.	Sp. Gr.	Volume of gas absorbed.	100 parts of the solution contain
Alcohol .....	0·803	2·6	
Sulphuric ether .....	0·727	2·17	
Oil of lavender .....	0·880	1·91	
Oil of thyme .....	0·890	1·88	
Spirit of wine .....	0·84	1·87	
Rectified naphtha .....	0·784	1·69	
Oil of turpentine .....	0·86	1·66	
Linseed oil .....	0·94	1·56	
Olive oil .....	0·915	1·51	
Water .....	1·000	1·06	
Sal-ammoniac .....	1·078	0·75	27·53 cryst. salt. Sat. solution.
Gum-arabic .....	1·092	0·75	25 gum.

\* According to Thomson, water in the mean temperature of the atmosphere absorbs 516 times its bulk of muriatic acid gas, and 780 times its bulk of ammoniacal gas.

† Water by absorbing gases increases in volume, and a perceptible heat is evolved, when the quantity absorbed at least equals the volume of the absorbing liquid. The specific gravity of a liquid saturated with gas is therefore smaller than it ought to be, calculating from the quantity of gas absorbed. Thomson draws an argument from this against the opinion of mere mechanical penetration.

Liquids.	Sp. Gr.	Volume of gas absorbed.	100 parts of the solution contain
Sugar .....	1·104	0·72	25 sugar.
Alum .....	1·047	0·7	9·14 cr. al. Sat. sol.
Sulphate of potash....	1·077	0·62	9·42 c. s. Sat. sol.
Muriate of potash ....	1·168	0·61	26 c. s. Sat. sol.
Sulphate of soda .....	1·105	0·58	11·14 * s. Sat. sol.
Nitre .....	1·139	0·57	20·6 c. s. Sat. sol.
Nitrate of soda .....	1·206	0·45	26·4 c. s. Sat. sol.
Sulphuric acid .....	1·84	0·45	
Tartaric acid .....	1·285	0·41	53·37 c. acid. Sat. sol.
Common salt .....	1·212	0·329	29 s. Sat. sol.
Muriate of lime .....	1·402	0·261	40·2 salt dried in a red heat. Sat. sol.

*Influence of Viscidity.*—When a liquid body passes into the state of a solid body quite filled with matter, or having all its sensible pores filled up, it loses the power which it had of absorbing gas in a liquid state. Viscidity, therefore, is nothing else than a more or less complete transition from a liquid to a solid state. It is to be presumed, therefore, that the different degrees of liquidity will always have an obvious influence on the condensation of the gas. But how important soever this conclusion may be at the limit between solidity and liquidity, it has but very little influence, according to my experiments, in the middle states of liquids of different kinds. Thus we see that the fat oils, though much less liquid, absorb a much greater portion of carbonic acid than water. The absorption, likewise, of carbonic acid by gum and sugar water, exceeds in quantity that produced by the much more liquid solutions of sulphate of soda and muriate of potash. The solutions of muriate of potash, sal-ammoniac, and nitre, possess as much, or nearly as much, liquidity as pure water; yet this last liquid absorbs a much greater proportion of carbonic acid gas than they do. On the other hand, we find likewise liquids which absorb more of this gas than others possessed of smaller liquidity; as is the case, for example, with alcohol and ether when compared with water, and with this liquid when compared with several saline solutions.

Though the influence of the visoidity of a liquid upon the greatness of its absorption appears to be small, yet it is striking, as far as the time is concerned which is required that the liquid may be fully saturated with the gas. Viscid liquids, as the fat oils, the solution of muriate of lime, gum-water, &c. require, supposing their power of absorbing the same, a much longer time to be saturated with a gas than the more perfect liquids, such as water, naphtha, alcohol, ether, and the essential oils.

*Influence of Specific Gravity.*—The density of liquids appears to have a great influence on their power of absorbing gases. My experiments, as stated in the preceding table, show that in general

\* The salt was dried in a red heat.

the lightest liquids possess a greater power of absorbing gases than those the specific gravity of which is greater. Scarcely any other liquids are excepted from this rule but those the specific gravities of which differ but little; and these exceptions are, without doubt, the consequence of peculiar affinities.\*

Probably the specific gravity of the gases themselves has an influence on the quantity of them which a liquid is capable of absorbing, and on the time requisite for that purpose; for all gases which are evidently heavier than atmospherical air are absorbed in greater quantity by water than azote, hydrogen, oxygen, and carbonic oxide: and of two gases which are absorbed in equal volumes by a liquid, the lighter requires a much longer time than the heavier. Thus naphtha absorbs olefiant gas much more slowly than it does nitrous oxide.

### 13. *Influence of Barometrical Pressure on the Absorption of Gases by Liquids.*

Dr. Henry caused carbonic acid in different states of density to be absorbed by water, and found that in all cases the liquid absorbed its own bulk of the gas, whatever its density might be. He concluded from this that the space which a gas occupies in water is in the direct (inverse?) ratio of the pressure. I have ascertained the accuracy of this conclusion by means of the contrivance described in paragraph 4, not only with respect to carbonic acid, the most absorbable gas employed by Dr. Henry, but likewise with respect to sulphurous acid gas, the absorption of which is nearly 50 times greater. A volume of water which, under a barometrical pressure of 28·74 inches, and at the temperature of  $62\frac{1}{2}^{\circ}$ , absorbed 44 times its bulk of sulphurous acid gas, still absorbed the same volume of that gas when the barometrical pressure was reduced to 14·33 inches, while the temperature continued the same. Oil of lavender, under a barometrical pressure of 6·89 inches, absorbed 1·9 volume of carbonic acid: it absorbed the same bulk when the barometrical pressure was 28·74 inches. Olive oil gave the same results with carbonic acid gas under different degrees of barometrical pressure. Probably the same law holds with respect to all liquids. It deserves attention that in liquids the quantities of gases absorbed are as the compressions; while in solid bodies, as the gases become less dense, the absorption seems to increase.

\* Metallic solutions of great specific gravity must be capable of absorbing a still smaller quantity of gas than the liquids employed in my experiments. It follows from this that in pneumatic experiments, when it is our object to measure the production of great quantities of carbonic acid, or any other pretty absorbable gas, it will be advantageous to employ saline solutions, and particularly solution of common salt, which differs most from pure water of all that can be easily used. Common sea salt will answer still better than pure salt. A saturated solution of it absorbs not quite the third of its bulk of carbonic acid, and requires for that a far longer time than pure water does to absorb its own volume of the gas.



14. *Simultaneous Absorption of several Gases by Water.*

Probably the absorption of different gases at the same time by liquids is analogous to what I observed with respect to solid bodies. Henry, Dalton, Von Humboldt, and Gay-Lussac, had already remarked that water saturated with one gas allows a portion of that gas to escape as soon as it comes in contact with another gas. It is indeed evident, according to Dalton's theory, that two gases absorbed into a liquid should really always occupy the same room as they would occupy if each of them had been absorbed singly at the degree of density which it has in the mixture. To obtain results on this subject approaching to accuracy, I was obliged to make mixtures of carbonic acid with oxygen, hydrogen, and azotic gases; for the last three gases are absorbed by water in so small a proportion, that the different condensations which take place cannot be confounded with errors in the experiments.\*

*Water and a Mixture of equal Measures of Carbonic Acid and Hydrogen Gas.*—I brought 100 measures of water, at the temperature of  $62\frac{1}{2}^{\circ}$ , in contact with 434 measures of equal volumes of carbonic acid and hydrogen. The absorption amounted to 47.5 volumes, of which 44 were carbonic acid, and 3.5 hydrogen. If we compare, in the same way as we did with the charcoal in paragraph 7, the space which the absorbed gases occupy in the water, with that which they would occupy according to paragraph 10, we find that the presence of one of the gases has favoured the absorption of the other, as far as the relative space goes which each would occupy separately in the water.

*Water and a Mixture of equal Parts of Carbonic Acid and Oxygen Gas.*—100 volumes of water at  $62\frac{1}{2}^{\circ}$  absorbed from 390 volumes of this mixture 52.1 volumes, of which 47.1 volumes were carbonic acid and five volumes oxygen gas. Here also the condensation is greater than when the gases are separate.

*Water and a Mixture of Carbonic Acid and Azotic Gas.*—100 volumes of water absorbed, from 357.6 volumes of this mixture, at the same temperature, 47.2 volumes, of which 43.9 volumes were carbonic acid and 3.3 azote.

The results of these experiments, as we perceive, agree completely with each other;† but none of them correspond with

\* Von Humboldt and Gay-Lussac have found that when they left a mixture of oxygen and hydrogen gas standing over water in a receiver, the absorption of the hydrogen was far greater than it would have been had it not been for the presence of the oxygen gas. I believe that this remarkable result was owing to the filtering of the hydrogen through the water into the external air, hastened by the action of the oxygen gas, or any other more absorbable gas; for according to my experiments pure water in vessels standing over mercury always absorbs from mixtures of oxygen and hydrogen a smaller absolute volume of the last than of pure hydrogen, in proportion to the space which the oxygen occupies in the water. However, it is not the less probable that both gases undergo a certain increase of density from their mutual contact.

† Carbonic acid does not appear to favour the absorption of azote by charcoal. The contrary seems to be the case in water. Yet I cannot depend upon this differ-

Dalton's theory, according to which the volume of carbonic acid absorbed should be just one half that of the absorbing liquid, and likewise the volumes of the other gases absorbed should be much smaller than I found them to be.

If oxygen and hydrogen gases, mixed in the proportions necessary for forming water, were capable, by the increase of density produced in them by the liquid, of combining and constituting water, their absorption could not be determined. But we are able by strong agitation to bring the absorption of these gases by water to a conclusion in a few minutes, so that it shall not be increased by continuing the agitation much longer. In my trials it did not exceed  $5\frac{1}{4}$  hundred parts of the volume of the liquid.

We obtain similar results with the gaseous constituents of ammonia and nitric acid. Even the addition of an alkali or an acid to the water is not capable of making the gases combine. But we do not yet know the effect which would be produced by a contact of several months or years between these gases and the liquid. As little are we aware of the effect of atmospherical influence upon common air in a state of liberty. Perhaps the experiments which I have related in this paper may throw some light on the subject. They show that the absorption of gases depends partly upon the physical properties, and partly upon the chemical affinities, of the bodies in contact, and penetrating each other; and that in this respect solid bodies and liquids are in general subjected to the same law.

#### APPENDIX.

##### *Method of uniting with Water those Gases which are absorbed only in small Quantity.*

As the quantity of gases absorbed by water, according to my experiments, often differs from that obtained by Henry and Dalton, I think it necessary to state the degree of care which I took to make my experiments as accurate as possible. The description of these artifices, however, can only interest those who wish to repeat the experiments.

1. In order to free the water from air, I employed the following method. A small flask was filled with distilled water, and placed open under water in a bason, filled with that liquid, and the whole water was kept boiling violently for at least three hours. That the water had been freed from its air as completely as possible\* this way, I knew by bending down the flask during the boiling, and

ence, as the whole depends upon estimating  $1\frac{1}{2}$  hundred parts of azote, which are within the limits of errors in the experiments.

\* It does not appear possible to deprive water of the whole of its air by long continued boiling; for when the small flask, in the experiments described in the text, was fitted with its stopper under the boiling water, a small space was left in it empty, in consequence of the contraction of the water by cooling. When the flask was opened under mercury, after standing for some days over that liquid, this empty space did not completely disappear by the rushing in of the mercury. A small air bubble always remained, which was speedily absorbed. This air bubble was obviously larger in alcohol and ether than in water.

perceiving that no more air collected in it. It was then completely filled, shut with a glass stopper under the boiling water, and placed inverted over mercury.

2. I filled over the pneumatic water-trough a flask, M, capable of holding 250 cubic centimetres, with the gas to be absorbed, held it inverted for half an hour under the water of the trough, that it might acquire the same temperature with this liquid, which ought to be nearly that of the atmospherical air. I then shut its mouth under the surface of the water with a glass stopper. This stopper must be carefully wiped, that no air bubbles be left on it; and it ought to be conical, that it may not compress the gas when introduced. The weight of this flask empty and full of water was accurately determined.

3. From this flask I poured over the mercurial trough about the sixth part of the gas into a receiver filled with mercury. This portion of gas was then poured over the water trough into a flask, N, filled with water. This flask, being weighed before and after the introduction of the gas, gave the volume of this last. This volume being abstracted from that in the flask M originally, gave the quantity of gas still remaining in that flask.

4. I now opened under mercury an inverted flask full of well boiled water, and poured as much of this water through the mercury into the flask, M, as expelled all the mercury which had been introduced into it by the third operation. The flask, M, was now shut at the surface of the mercury, and weighed. This gave the volume of water introduced into the flask.

5. The gas with the water was now strongly agitated for 15 minutes, while the flask, M, was held by a pair of pincers, to prevent the introduction of any heat from the hand. It was then plunged under the water of the trough, to bring it exactly to its original temperature, opened in an inverted position, and shut again under water. Now the water which occupied the place of the absorbed gas, and the difference between the weight of the flask, M, now and when it was full of water, enabled me to know the volume of gas absorbed.

---

### ARTICLE III.

*An Analysis of the Mineral Waters of Dunblane and Pitcaithly; with General Observations on the Analysis of Mineral Waters, and the Composition of Bath Water, &c.* By John Murray, M.D. F.R.S.E.

(Continued from p. 269.)

#### III.—OBSERVATIONS ON THE COMPOSITION OF SALINE MINERAL WATERS.

It is a question not unequivocally determined, and perhaps not capable of being determined, in what state the saline ingredients of

a mineral water exist—whether the acids and bases are in those binary combinations which constitute the different neutral salts, or whether they exist in simultaneous combination, the whole acids being neutralized by the whole bases. If the former, which is the more common, and perhaps the more probable opinion, be adopted, it is at least certain that the state of combination may be modified by the analytic operations, and that the binary combinations obtained by these may not be precisely those which existed in the water. In the case of the Dunblane water, for example, the ingredients obtained are muriate of soda, muriate of lime, and sulphate of lime. Now it is possible that the sulphate of lime may be a product of the operation, not an original ingredient. The sulphuric acid may exist rather in the state of sulphate of soda, and when, in the progress of the evaporation, the liquor becomes concentrated, this salt may act on a portion of the muriate of lime, and by mutual decomposition form corresponding portions of muriate of soda and sulphate of lime.

A question of this kind is not merely one of speculation, but the solution of it may sometimes throw light on the properties of mineral waters, particularly on their powers of affecting the living system. The present affords a very good example of this. Sulphate of lime is a substance apparently inert. If it exist, therefore, as such in the water, it can contribute nothing to its efficacy. But in the other state of combination which is supposed, both the quantity of the muriate of lime, the more active ingredient, will be greater, and the presence of sulphate of soda will in part account for the purgative operation which the water exerts.

There is no very direct, and perhaps no decisive, experiment by which this question may be determined; for any method which would cause the *separation* of either substance as a binary compound, may also be conceived to operate by causing its *formation*. Thus, though sulphate of lime is obtained by evaporation, this is no proof of its prior existence, since the concentration of the solution might equally cause its formation, by favouring the action of the sulphate of soda, if it exist, on the muriate of lime. Its separation by a precipitant, by alcohol for example, even if it were obtained, is liable to the same ambiguity; a certain degree of concentration of the watery solution would be necessary for the effect, and the further operation of the alcohol might be precisely on the same principle—diminishing the solvent power of the water, and thus aiding the force of cohesion, in determining the combination of the ingredients which form the least soluble compound. If a different mode of analysis were had recourse to, if the whole lime, for example, were precipitated by any re-agent, there would still remain the uncertainty with what it had been combined, whether entirely with muriatic, or partly with sulphuric acid; and there is no mode of determining this, by obtaining the other product of the action of the re-agent, which would not be liable to equal ambiguity; or, if the sulphuric acid were abstracted by a re-agent, there would

equally be the uncertainty, whether it had been previously combined with soda or lime.

If sulphate of lime did not separate when the water was reduced by evaporation so far that, from the known solubility of the sulphate, the precipitation of it ought to take place to a certain extent, it might be concluded that it did not exist. Yet even this conclusion, were the fact found to be so (which it is on making the experiment), is invalidated by the result, sufficiently established, that salts, by their mutual action, often increase the solubility of each other, and the sulphate of lime might, from this cause, be retained dissolved in a smaller quantity than it would require by itself for its solution.

One kind of proof may be given, that of showing that a much larger quantity of sulphate of soda than what analysis indicates in this water may exist in it, without any precipitation of sulphate of lime. I added to different portions of the water (four ounces each) 5, 10, 15, 20, and 30, grains of sulphate of soda. In none of the experiments was there any immediate effect; and even after 24 hours, there was no turbid appearance, or apparent change. In the greater number of these proportions, the quantity of sulphate of soda was more than sufficient to convert the whole muriate of lime in the water into sulphate; and, according to the known solubility of this sulphate, the quantity of water was not sufficient to retain it all dissolved. This quantity was even reduced to a certain extent by evaporation, without any precipitation. The result seems therefore to prove, that sulphate of lime had not been formed, and that sulphate of soda may exist with muriate of lime in solution without decomposition, in the state of dilution which this mineral water affords.

Another result which I obtained, and which so far favours the opinion that the sulphate of lime is formed in the progress of the evaporation by the reciprocal action of sulphate of soda and muriate of lime, is, that when a small portion of sulphate of soda has been added, the quantity of sulphate of lime obtained is increased: when 10 grains, for example, of crystallized sulphate of soda were added to a pint of the water, after evaporation to dryness, four grains of sulphate of lime, which is double the proportion that the water would otherwise have yielded, were obtained—affording a proof that when sulphate of soda is dissolved in the water, it produces, in the progress of the evaporation, a corresponding portion of sulphate of lime, and of course also of muriate of soda.

These results do not absolutely establish the conclusion, that the sulphuric acid exists in this water in the state of sulphate of soda; yet on the whole this is the more probable opinion. If it be admitted, the preceding statement of the ingredients, and their proportions, must be altered. The sulphate of lime is of course to be omitted. The sulphate of soda, which is to be substituted for it, cannot be obtained by any method; but the quantity of it may be inferred, from the quantity of sulphate of lime which is formed by

its action on the muriate of lime. Real sulphate of lime and real sulphate of soda are very nearly equivalent to each other with regard to the proportions of their acid and base; so that the quantity of the one may nearly be substituted for that of the other; 3·5 of sulphate of lime being equal to 3·7 of sulphate of soda. But this sulphate of lime is formed at the expense of a portion of muriate of lime, and its formation is accompanied with the production of a little muriate of soda; hence the proportion of the former must be a little larger, and that of the latter a little smaller, than have been before stated. 3·5 grains of sulphate of lime are equivalent to 2·8 of muriate of lime, which quantity, therefore, is to be added to the proportion above assigned. The equivalent portion of muriate of soda to be subtracted is 3. The whole proportion, therefore, will be the following:—

	Grains.
Muriate of soda .....	21
Muriate of lime .....	20·8
Sulphate of soda .....	3·7
Carbonate of lime .....	0·5
Oxide of iron .....	0·17
	46·17

The quantity of sulphate of lime obtained in the analysis of the Pitcaithly water being so much smaller than that in the Dunblane, it may perhaps be considered as an original ingredient; or if even the opposite view be adopted, the change in the proportions, as indicated by the analysis, is much less. They may be stated as follows:—

	Grains.
Muriate of soda .....	12·7
Muriate of lime .....	20·2
Sulphate of soda .....	0·9
Carbonate of lime .....	0·5

The carbonate of lime contained in both waters may, it is obvious, according to the same view, be a product of the operation, and may exist in the water in the state of carbonate of soda. Yet the quantity is so small, and carbonate of lime is so generally diffused in the mineral kingdom, that it may perhaps be regarded as an original ingredient. On the other hand, it seems to be nearly insoluble in water, and this favours the supposition that it is a product of the analysis. It is unquestionably so in the mineral waters, in which it has been stated to exist in much larger quantity, and in which there is not, at the same time, any excess of carbonic acid, by which it might be retained dissolved.

The view of the constitution of this mineral water which I have now explained, suggested a method of analysis which I may state, both as it accords with, and in some measure confirms it, and illus-



trates some circumstances connected with the mutual action of the sulphate of soda, and muriate of lime, to which I shall afterwards have to refer. It affords, too, an excellent illustration of the definite proportions in which many bodies combine, and the uniformity of results which are obtained from their action on each other, in consequence of this law.

Supposing the sulphate of lime obtained from this water by evaporation to be formed by the action of sulphate of soda on a portion of its muriate of lime, it might be inferred, that by adding the due proportion of sulphate of soda, the whole muriate of lime it contains may be converted into sulphate of lime; and this, from its insolubility, being easily separated from the muriate of soda, the quantity of it, and of course the quantity of muriate of lime, will be ascertained. From the preceding analysis, 18 grains of muriate of lime appear to exist in a pint of the *Dunblane* water. Now this quantity requires for its decomposition 23·1 of real sulphate of soda; and the products of this decomposition are 22·1 of real sulphate of lime, and 19 of muriate of soda.\* The former of these products being collected and dried, may be weighed, and the latter being deducted from the whole quantity of muriate of soda obtained by evaporation, the remainder will be the quantity originally contained in the water. The obtaining of these quantities, therefore, or near approximations to them, will be at once a confirmation of the preceding analysis, and of the accuracy of these proportions.

A pint of the water was evaporated to about one-fourth; the quantity of real sulphate of soda required for the decomposition of its muriate of lime, it has been just stated, is 23·1 grains. But by previous trials I had found that a small excess of sulphate of soda renders the decomposition more complete; 24 grains, obtained by exposing crystallized sulphate of soda to a red heat, were therefore added. The liquor soon became turbid and thick. I had also found, that to render the decomposition more complete, it is of advantage not to evaporate at once to dryness, but to add small quantities of water occasionally for some time during the boiling. The experiment having been conducted in this manner, a precipitate of sulphate of lime was collected, which, when washed and dried, weighed 19 grains. The liquor being evaporated, afforded of dry salt 51·6 grains. But on dissolving this salt in water, a deposite of sulphate of lime remained undissolved; and even on again evaporating to dryness, and re-dissolving in water, a small portion was deposited for three successive times. The whole quantity of sulphate of lime thus collected amounted to 5·8 grains, and of course increased the former quantity of 19 to 24·8 grains. Supposing the quantity of sulphate of lime originally contained in the water, or what is the same thing, capable of being produced in its evaporation

\* The inspection of the scale of chemical equivalents gives at once these numbers; and this highly useful instrument, lately invented by Dr. Wollaston, facilitates greatly all such researches by the number of results it presents without the necessity of calculation.



from its own ingredients, to amount to 3·8 grains, this leaves 21 grains formed by the action of the sulphate of soda which had been added on the muriate of lime; and this is equivalent to 17·1 grains of muriate of lime. The saline matter obtained by evaporation of the solution weighed, after exposure to a red heat, 44·4 grains. Of this, supposing it to be all muriate of soda, 18 grains would be formed by the action of the sulphate of soda on the muriate of lime; and there remain 26·4 grains as the quantity which the water had contained. This quantity is rather larger, and that of muriate of lime rather smaller, than what are obtained by the other analyses. But the saline matter was found not to be entirely muriate of soda; its solution became turbid on the addition both of muriate of barytes and of oxalate of ammonia, indicating the presence of sulphuric acid and of lime, either in the state of sulphate of lime retained in solution, or of muriate of lime and sulphate of soda remaining undecomposed. An excess of sulphate of soda of 0·9 grain, it has already been stated, had been employed, which reduces the weight of the salt to 25·5 grains; and if a little more be subtracted on account of the lime it contained, and be added to the muriate of lime, it will give proportions nearly the same as those before assigned; and the results by this method will thus correspond with those by the others.

Having stated this view of the composition of this water, I have now to consider it under a more general light, and to point out a few applications which follow from it, connected with the chemical constitution of waters which contain similar ingredients.

---

Sulphate of lime has been often stated as an ingredient existing in mineral waters with muriate of soda and muriate of lime. It is almost superfluous to remark, that it is probable the original ingredients in all such cases are sulphate of soda and muriate of lime, and that the sulphate of lime is a product of the operation, or rather that the portion of it equivalent to the quantity of muriate of soda has this origin.

It is a curious fact, which strongly confirms this, that in almost all the analyses of mineral waters since the time of Bergman, when they can be presumed to have been executed with any precision, where sulphate of lime is an ingredient, muriate of soda is also present. It is obvious that if the sulphate of lime has this origin, muriate of soda must also be formed. On the other hand, in the greater number of those analyses in which muriate of soda is an ingredient, we find also sulphate of lime; and, with the exception of the water of Harrowgate, sulphate of lime is always present, where muriate of soda and muriate of lime are conjoined.

But the principal interest belonging to this view is derived from its relation to a question which has often been brought under discussion—whether chemical analysis is capable of discovering the sources of the medicinal virtues of mineral waters? This question

some have been disposed to decide in the negative, from finding examples of waters possessed of active powers, in which analysis does not detect any ingredients of adequate activity.

On the general question, the remark by Dr. Saunders is perfectly just, that, "considering the comparative accuracy to which chemists are at present able to carry their inquiries, we can hardly suppose that, whatever slight error might occur in the estimation of minute quantities, the actual existence of any powerful agent on the human body in any mineral water should escape the nicety of research." Yet though this is just, and though we can have no hesitation in rejecting the opinion which would ascribe the medicinal qualities of mineral waters to unknown or mysterious causes, or which would deny all power to those in which an active chemical composition cannot be discovered, difficulties on this subject undoubtedly exist, and there is some room for that scepticism which has been extended to this department of the *Materia Medica*.

Of this no better example can be given than the celebrated Bath water. It has always been found difficult to account for its powers, the ingredients which are obtained in its analysis being substances of little activity, and the principal ones, indeed, being apparently inert. It contains in an English pint, along with a slight impregnation of carbonic acid, about nine grains of sulphate of lime, three grains of muriate of soda, three grains of sulphate of soda,  $\frac{3}{10}$ ths of a grain of carbonate of lime,  $\frac{1}{5}$ th grain of silica, and  $\frac{1}{70}$ th grain of oxide of iron. Now from these ingredients unquestionably no medicinal power of any importance could be expected. They are either substances altogether inert, or are in quantities so minute, as in the dose in which the water is taken to be incapable of producing any sensible effect. Some have from this circumstance been disposed to deny altogether any virtues to these waters; but the reverse of this appears to be established by sufficient evidence, and what is still less equivocal, the injurious effects they sometimes produce, and the precautions hence necessary in their use, sufficiently demonstrate their active powers. To account for these, therefore, various hypotheses have been proposed. The observation has been urged, which to a certain extent is undoubtedly just, that substances given in small doses in a state of great dilution may from this dilution produce more effect on the general system than the quantity given would lead us to expect. The temperature of the water, too, it has been supposed, may have a considerable share in aiding the effect; and these two circumstances in particular, it has been imagined, may favour the action of the iron. This is the view of the subject given by Dr. Saunders, in his *Treatise on Mineral Waters*. Some of the other ingredients, too, it has been supposed, may exert unknown powers. Thus some effect has been ascribed to the agency of the nitrogen gas which rises through the water: and Dr. Saunders himself, apparently not very well satisfied with the reasoning he had employed, allows some weight to the opinion suggested by Dr. Gibbes, that the siliceous earth assists in the gene-

ral effect of the Bath waters ;—remarking, that though there is only a grain of it in half a pint of the water, this forms no objection, when the great powers of very minute quantities of active substances are considered ; that neither is its insolubility in the animal fluids an objection, as it exists in the water in a state of solution ; and that though it has neither taste nor smell, it may be an active substance, since there are indisputably powerful medicines which have little of either of these qualities.

All this, it is superfluous to observe, is extremely unsatisfactory. With regard to the iron, the only active substance—allowing full weight to the observations that small quantities of active medicines under great dilution operate with increased power, and that a high temperature may aid their operation on the stomach—still we cannot believe that one-sixtieth of a grain, the quantity in a pint of this water, can produce any important medicinal effect : and with regard to the other substances, the reasoning whence their possible operation has been inferred, instead of removing the difficulty, rather places it in a clearer light.

The view of the constitution of mineral waters stated above enables us to assign to the Bath water a much more active chemical composition. There is every probability that muriate of lime is its powerful ingredient. The principal products of its analysis are sulphate of lime, muriate of soda, and sulphate of soda. The proportion of sulphate of lime is such, that part of it must pre-exist in the water, but part of it, there is reason to conclude, is a product of the analysis ; the muriate of soda is entirely so, and the quantity of sulphate of soda is larger than what the analysis indicates. In other words, there exist in it muriate of lime, sulphate of soda, and sulphate of lime ; and during the evaporation, the muriate of lime being acted on by a portion of the sulphate of soda, muriate of soda and a corresponding portion of sulphate of lime are formed.

On the probability of this view I need not, after the preceding illustrations, offer any observations. The obtaining certain saline compounds from a mineral water by evaporation leads no doubt at first to the conclusion that they are its ingredients ; it is the conclusion, accordingly, which has hitherto been always drawn, and we are disposed to regard this as evidence establishing this conclusion, in some measure, in opposition to any different view of the composition. But this is merely oversight or prejudice. If it can be shown that the elements of these compounds may equally exist in the water in a different state of combination, which the evaporation must change, the conclusion that they do exist in such a state is *à priori* as probable as the conclusion that they exist in the state in which they are actually obtained. It is demonstrable that if muriate of lime and sulphate of soda exist in a mineral water, or, what is even less ambiguous, if they be dissolved together in pure water, they must by evaporation be obtained, as muriate of soda and sulphate of lime. The actual obtaining, therefore, of these latter compounds is no proof that they pre-existed as such in the water,

to the exclusion of the opposite view. Which conclusion is to be adopted, must be determined on other grounds; and from the various facts I have stated, I believe it may be regarded as the more probable opinion in such cases, that the original ingredients are sulphate of soda and muriate of lime. Since sulphate of soda exists in the Bath water, and since muriate of soda and sulphate of lime are obtained in its analysis, it is scarcely possible to refuse assenting to the conclusion that these are formed by the action of sulphate of soda on muriate of lime.

On this view of the composition of the Bath water, it is easy to assign the proportions of the ingredients, from the products which are obtained in its analysis. In the formation of 3·3 grains of muriate of soda, which is the quantity obtained from a pint of the water, 3·1 grains of muriate of lime must be decomposed: four grains of sulphate of soda would be required to produce this decomposition; and at the same time 3·8 grains of sulphate of lime would be formed.

The latest, and no doubt the most accurate, analysis of the Bath water, that by Mr. Phillips, gives the following view of its composition.

In an English pint—

Carbonic acid	1·2 inches
Sulphate of lime	9 grains
Muriate of soda	3·3
Sulphate of soda	1·5
Carbonate of lime	0·8
Silica	0·2
Oxide of iron	$\frac{1}{68}$

But, considering the composition according to the preceding view, the ingredients and their proportions will be,

Carbonic acid	1·2 inch
Sulphate of lime	5·2 grains
Muriate of lime	3·1
Sulphate of soda	5·5
Carbonate of lime	0·8
Silica	0·2
Oxide of iron	$\frac{1}{68}$

The peculiarity in the composition of the Bath water, compared with the greater number of saline mineral waters, is that it contains a larger quantity of sulphate of soda than is necessary to convert its muriate of lime into sulphate of lime. Hence no muriate of lime is obtained after evaporation in its analysis; hence even a portion of sulphate of soda is indicated; and hence the large proportion of sulphate of lime which that analysis yields. In the Dunblane and Pitcaithly waters the sulphate of soda is deficient, the muriate of lime is in large quantity, and is accompanied with muriate of soda: hence the entire want of sulphate of soda, the small quantity of

sulphate of lime, and the large proportion of muriate of lime in their analyses.

Muriate of lime, it is well known, is a substance of considerable power in its operation on the living system; in quantities which are even not large, it proves fatal to animals. When taken to the extent of six grains, the quantity of it which, according to the preceding view, exists in a quart of the Bath water, it cannot be inactive. It is very probable, too, that a given quantity of it will prove much more active in a state of great dilution in water than in a less diluted form, as in this diluted state it acts, when received into the stomach, over a more extended surface; and besides this, whatever effect may be due to the high temperature of the Bath water in aiding the operation of the minute portion of iron it contains, the same effect must be equally obtained in aiding the operation of the much larger quantity of muriate of lime. The conclusion, indeed, as to the importance of this effect, is much more probable with regard to the muriate of lime than to the iron; for supposing the quantity of the former to exist in the Bath water which has been assigned, the dose of it taken in a quart of the water is not far from its proper medium dose, and is at least equal to one-half the largest dose which can be given, and continued without producing irritation; while the dose of the iron is not the one-hundredth of that which is usually prescribed. Under the circumstances, therefore, in which the muriate of lime is presented in the Bath water, it is reasonable to infer that it must be productive of considerable immediate effect.

The speculation is further not improbable, that, to produce its more permanent effects on the system as a tonic, it is necessary it should enter into the circulation. In a dilute state of solution it may pass more easily through the absorbents; while in a more concentrated state it may be excluded, and its action confined to the bowels. Hence the reason, perhaps, that in some of the diseases in which it is employed, scrofula particularly, it has frequently failed, its exhibition having been in doses too large, and in too concentrated a form. And hence it is conceivable that in a more dilute state, as that in which it may exist in the Bath water, besides its immediate operation, it may produce effects as a permanent tonic more important than we should otherwise expect.\*

I may add that the iron in the Bath water is probably not in the state of oxide or carbonate, as has been supposed, but in that of muriate. The muriate is the most active preparation of iron, and so far increased activity may be given to the slight chalybeate impregnation; and some modification of power may even be derived

\* I may mention in confirmation of this that I found a mineral water of considerable celebrity in Yorkshire, that of Ikley, and which in particular was held in high estimation as a remedy in scrofulous affections by several eminent medical practitioners to be water uncommonly free from all foreign matter, with the exception of very minute quantities of muriate of soda and muriate of lime. I had the opportunity of observing, at the same time, proofs of its medicinal efficacy.

from the combined operation of muriate of lime and muriate of iron.

It deserves to be remarked, that in the most essential ingredients, the muriate of lime and the iron, the *Dunblane* and *Pitcaithly* waters are similar to the *Bath* water, only with regard to the former ingredient much stronger; the other differences are unimportant; the larger quantity of sulphate of lime, and the small quantity of silica in the latter, cannot be supposed to contribute any thing to its medicinal operation; the difference in the proportion of sulphate of soda is trivial, and the larger proportion of muriate of soda in the other waters may rather be an advantage, rendering them more agreeable to the taste and to the stomach. The principal difference will therefore be that of strength with regard to the most active ingredient, the muriate of lime. The quantity of this is so large that the tonic quality of the *Dunblane* or the *Pitcaithly* waters can scarcely be observed, and perhaps even scarcely obtained, their action being more peculiarly on the bowels. It is accordingly as a saline purgative that the *Pitcaithly* water has been celebrated; and it is principally in those diseases in which this effect is sought to be obtained that it has been used. The *Dunblane* water, from the similarity of its operation, would no doubt be employed in diseases of a similar kind. But whatever advantage might be derived from this purgative effect, it cannot fail to be perceived that a different operation, not less useful, may be obtained from them. If sufficiently diluted, so as to avoid altogether the operation on the bowels, the stimulant operation on the stomach and general system might be exerted by these waters, similar to that of the *Bath* waters, and under this form they might prove useful in diseases very different from those in which they might otherwise be employed. As they would require, too, large dilution to reduce them to this state, the temperature of the *Bath* water might easily be given, by adding the requisite proportion of hot water, by which a greater similarity of operation would be obtained. And the *Dunblane* water in particular, containing so much larger a proportion of iron than the *Bath* water does, the dilution requisite to give it the same strength, with regard to the muriate of lime, would still leave an equal degree of chalybeate impregnation. If the preceding observations, therefore, are just, the *Dunblane* and *Pitcaithly* waters may be converted, in all the essential parts of the chemical composition, into a water similar to that of *Bath*.

From the preceding statement of their composition, it is easy to discover how this may be done. To give the same proportion of the principal ingredient, the muriate of lime, the *Dunblane* water would require to be diluted with from six to seven parts of pure water; the same degree of dilution would bring it to nearly the same strength with regard to the iron; if a pint of it were diluted with this portion of water, about 35 grains of sulphate of soda would require to be added, to render the composition, with regard to this ingredient, perfectly alike, if this were thought essential.



The only remaining differences would then be the presence of about 2·8 grains of muriate of soda in each pint of the reduced Dunblane water, the deficiency of 5·5 grains of sulphate and 0·7 grain of carbonate of lime, and the absence of 0·2 grain of siliceous earth, differences in all respects probably of no importance whatever. The simple expedient, indeed, of diluting one part of the Dunblane water with from six to seven parts of warm water (or if the sulphate of lime in a state of solution should be supposed to be possessed of any active power, with four or five parts) and adding, if the chalybeate impregnation were not found sufficiently active, a few drops of tincture of muriate of iron, would probably serve every purpose. And if sufficient confidence could be given to the substitution on the part of those employing these waters medicinally, the Dunblane water, thus altered, might probably be taken with as much advantage as the Bath water in the diseases in which it has been found useful.

It is obvious, too, that <sup>\*</sup>if the artificial preparation of the Bath water were attempted, it could be done much more easily according to this view than by endeavouring to dissolve the actual products of its analysis, which indeed it would be impracticable to do. Muriate of lime and sulphate of soda dissolved in water of the due temperature, with the addition of a minute portion of muriate of iron, would probably afford a composition approaching as nearly to the natural composition as is either practicable or necessary in the imitation of any mineral water.

A similar view may be taken of the composition of Cheltenham water. Its analysis affords sulphate of soda, sulphate of magnesia, and sulphate of lime, with muriate of soda, muriate of magnesia, carbonate of magnesia, and oxide of iron. There is no just reason, however, to infer with certainty that all these are its real ingredients. It is as probable, and indeed more so, that previous to the evaporation by which they are obtained it contains muriate of lime, which being acted on by the sulphate of soda forms muriate of soda and sulphate of lime. It is even not improbable that the carbonate naturally existing in the water is not carbonate of magnesia, but carbonate of soda, which re-acting, from the concentration by the evaporation, on sulphate or muriate of magnesia, causes the production of the carbonate of magnesia with a corresponding portion of sulphate or muriate of soda; or what is equally probable, and presents the same ultimate results, <sup>\*</sup>the sulphate of magnesia may in the progress of the evaporation be first acted on by the carbonate of soda, forming carbonate of magnesia and sulphate of soda; and the sulphate of soda, during the further concentration, may act on the muriate of lime, and form muriate of soda and sulphate of lime. It is much more probable, indeed, from the known insolubility of carbonate of magnesia, that it is produced in this way, than that it should exist in a state of solution in so large a quantity as that in which it is afforded by the evaporation. And thus this water will present a striking example that the real ingredients of a mineral



water and their proportions may be very different from those obtained by the direct analysis; for it is too obvious, after the preceding observations, to require illustration, that the actual production of certain ingredients by evaporation, or any other analytic process, is no certain proof that they pre-existed in the water. It is obvious, too, that if it were proposed to imitate the Cheltenham water by artificial preparation, it could be done much more easily according to this view than by attempting to dissolve the ingredients obtained by the analysis—an attempt, indeed, which would not succeed. The Dunblane or Pitcaithly water might be converted, so far as regards the saline ingredients, into a water similar to that of Cheltenham, by the addition of a little sulphate of magnesia, or more nearly by the addition of a little of the bittern of sea water; and where in the use of these waters a continued purgative operation is required, such an addition might always be made with advantage. They might even be made to receive the impregnation of carbonic acid of the Cheltenham water, by adding the magnesia in the state of carbonate, with the due proportions of sulphuric and muriatic acids in a close vessel.

The water of Harrowgate affords in its saline ingredients another illustration of the same views. The principal ingredient is muriate of soda, with which are present muriate of magnesia, muriate of lime, sulphate of magnesia, carbonate of magnesia, and carbonate of lime. Now nothing is more probable than that the last two substances are not original ingredients, but are products of the analysis formed by the action of carbonate of soda existing in the water on portions of its muriate of magnesia and muriate of lime, whence also the quantity of muriate of soda is increased.

Lastly, a similar view may be extended to some of the most celebrated foreign mineral springs. Those of Spa, Pyrmont, and Seltzer, form a very valuable order of mineral waters, to which we have none analogous in this country—what have been called the alkaline carbonated waters, distinguished by the leading character of being largely impregnated with carbonic acid gas, and containing a considerable proportion of carbonate of soda. With this are associated carbonate of magnesia, carbonate of lime, and muriate of soda. Now this association of muriate of soda with these earthy carbonates, while there is also carbonate of soda present, leads almost necessarily to the belief that the real ingredients are carbonate of soda, muriate of magnesia, and muriate of lime; that the carbonate of soda is in larger proportion than what is indicated by the analysis; that it acts during the evaporation of the water on the muriates of magnesia and lime, and forms the carbonates of these earths which are obtained with corresponding portions of muriate of soda: and that it is only what muriate of soda there may be above this that exists as an original ingredient.

The Seltzer water, which is the purest of this order of waters, as containing neither iron nor any sulphate, affords in particular a very

excellent illustration of this. It contains, according to Bergman's analysis, in an English pint,

Carbonic acid gas .....	17 cub. in.
Carbonate of lime .....	3 grains
Carbonate of magnesia .....	5
Carbonate of soda .....	4
Muriate of soda .....	17·5

But adopting the opposite view, the composition, so far as the uncertainty of the state of the products, to which Bergman's estimate is referred, admits of calculating the proportions, will be,

Carbonic acid gas .....	17 cub. in.
Muriate of lime .....	3·3 grains
Muriate of magnesia .....	5
Muriate of soda .....	7·8
Carbonate of soda .....	10·3 dry, or 18 crystallized.*

It might be supposed that so large a proportion of carbonate of soda could not exist with the muriates of magnesia and lime without decomposing them, that this view of the constitution of this water is therefore precluded, and that Bergman's is just. And in this case the non-precipitation of the carbonates of magnesia and lime may be supposed to be owing to the solvent power of the excess of carbonic acid; to which cause, accordingly, it has been ascribed. But on making the experiment, I found that the above quantities might be dissolved in a pint of water, independent of the presence of the excess of carbonic acid, without any apparent decomposition, the solution being transparent, and remaining so on exposure to the air. The same fact has even been observed with regard to the natural water; for although on exposure to the air it becomes vapid, and its taste is merely sensibly alkaline, the carbonates are not precipitated; the precipitation takes place only when heat is applied, so as to evaporate the water to a certain extent: and with regard to this, a fact is mentioned by Bergman not less conclusive. The carbonate of lime is first deposited, with scarcely any mixture of carbonate of magnesia; the latter separates only by continued evaporation; and it is even necessary to evaporate to dryness, and redissolve in hot

\* The following is the calculation from which these proportions are assigned. Three grains of carbonate of lime are equivalent to 3·3 of real muriate of lime: five grains of carbonate of magnesia in the state in which it was obtained by Bergman, that is, the powder precipitated and dried, are equivalent to five grains of real muriate of magnesia. In converting the first of these muriates into carbonate, 3·2 grains of dry common carbonate, or subcarbonate of soda, would be expended; and in the conversion of the second muriate, 5·7 grains, making 8·9 grains, to which are to be added 1·4 grain, the quantity contained in the four grains of the crystallized carbonate obtained as the direct product of the analysis, making in all, as stated above, 10·3 grains. Lastly, in these decompositions of the earthy muriates, 9·7 grains of muriate of soda would be formed, which, deducted from the 17·5 obtained in the analysis, leaves 7·8 as the quantity which the water really contains.

water, to obtain it entirely—proving that it does not pre-exist in the water dissolved by an excess of carbonic acid, but that it is produced during the evaporation, and must therefore be formed by the action of carbonate of soda on muriate of magnesia.

This view of the composition of this water accords much better than the other both with its sensible qualities and its medicinal powers. Its taste after the carbonic acid has escaped from it, on exposure to the air, is rather strongly alkaline, which would scarcely be the case if it contained only four grains of crystallized carbonate of soda in a pint, but which is to be expected if it contain 18 grs. It operates as an antacid and diuretic, and is productive of much benefit in all dyspeptic affections, in diseases of the urinary organs, and in those general affections of the system which require a mild tonic power. There are few mineral waters, Dr. Saunders observes, which have acquired a higher reputation; and there are few, he adds, that deserve greater consideration, from the real medicinal virtues it possesses. It will be difficult to give a satisfactory account of the origin of these virtues if we regard it as water impregnated with carbonic acid, holding in solution so minute a portion of carbonate of soda, with the larger proportions of muriate of soda and carbonates of magnesia and lime. But if we consider it as containing along with its free carbonic acid a considerable quantity of carbonate of soda, with smaller proportions of muriate of soda, muriate of magnesia, and muriate of lime, we assign to it a composition of much greater power, and adequate to account for the effects it produces. Such is the activity of this water, that its medium dose is only half an English pint, a degree of power which accords much better with the one view of its composition than with the other.\*

Large quantities of Seltzer water have been imported into this country, and artificial preparations of it are in frequent use. If these are founded on Bergman's view of its composition, they can scarcely succeed; probably, therefore, this is not attempted. The view which I have suggested renders its artificial preparation much more easy. The ingredients may be dissolved in water, and the solution impregnated with carbonic acid gas; or, what is easier,

\* The water of Malvern may be regarded as of similar composition, only much weaker, and without any free carbonic acid. Dr. Wilson's analysis gives the following ingredients, and their proportions in a gallon:—

	Grains.
Carbonate of soda .....	5.33
———— lime .....	1.6
———— magnesia .....	0.9199
———— iron .....	0.625
Sulphate of soda .....	2.896
Muriate of soda .....	1.553
Residuum .....	1.687

The muriate of soda, there is every probability, is a product of the operation, formed by the action of carbonate of soda on muriate of lime; or if sulphate of lime formed part of the residuum, as is probable, by the action of sulphate of soda on muriate of lime.

these steps of the process may be conjoined. The muriate of lime may be formed by adding the requisite quantity of carbonate of lime to the due proportion of muriatic acid diffused in water, and the vessel being closed, the escape of the carbonic acid gas may be prevented. The muriate of magnesia and the muriate of soda may be formed in a similar manner from the carbonates of magnesia and soda. And the quantity of carbonic acid thus afforded will be very nearly that which is required. To form the muriate of lime, three grains of carbonate are to be used; to form the muriate of magnesia, five grains of the carbonate of that earth; and to form the 7·8 grains of muriate of soda, 12·3 grains of crystallized carbonate of soda. These quantities contain 6·2 grains of carbonic acid, or 13 cubic inches, a quantity not much beneath that which the Seltzer water contains. The neutral carbonate of soda, or bicarbonate, as it is named, may even be substituted in the preparation; and if the due proportion of this be used (11 grains), it will yield six cubic inches additional, making the whole quantity 19 cubic inches, two more than the quantity in the water.\*

I might apply the same view to a number of other analyses of mineral waters, even the most recent. But though this would not be altogether uninteresting, it is scarcely necessary to extend the illustration further. The general conclusion may, I believe, be drawn, that in the analysis of saline mineral waters, the actual products of the analytic operation are not always to be regarded as the real ingredients. A different view of the composition is often to be taken, and may in many cases be applied, so as to afford a more satisfactory solution of their active powers.

I may only further remark, that a view somewhat different may also be applied, founded on the doctrine that the primary ingredients of the compound salts, obtained by the analysis of mineral waters, are in simultaneous combination, and not in the state of binary compounds. Even this view, were it adopted, would afford a better explanation of their active powers than the view of their composition which is usually received, since it could not at least be affirmed that such a combination must be inactive. The opinion itself, however, is much less probable; for if fairly followed out, it leads to the conclusion that all combinations of compound bodies are simultaneous combinations of the primary elements—a conclusion from which no inference with regard to specific qualities could

\* The following is the easiest method of conducting the process. About 35 grains of muriatic acid, of the strength usually met with in the shops, are put into a strong bottle with a pint of water; the acid being introduced at the bottom of the water by a long funnel. Three grains of pure white marble, in coarse powder, are dropped in, and the bottle is closed. When these are dissolved, five grains of the common carbonate of magnesia in powder are added, and after the solution of this, 32 grains of crystallized carbonate of soda, or what is equivalent to this, and preferable, as affording more carbonic acid, 27 grains of bicarbonate of soda, are put in. The bottle is closed accurately, shaken, and inverted. In a short time a perfect solution takes place, and a liquor is obtained transparent, which sparkles when poured out, and has a pleasant taste.

be drawn, and which is inconsistent, therefore, with the conclusions which in many cases we are able actually to form. We are led, therefore, to the admission, that the state of binary combinations exist; and it is only necessary to guard against the error of supposing that the products of the analysis are always the original ingredients.

The importance of the subject, and its relation to the question how far chemical analysis is capable of accounting for the medicinal efficacy of mineral waters, will, I hope, afford an apology for the introduction of some of the preceding observations, though they may not fall strictly under the objects usually submitted to the Society.

In a succeeding paper I shall have to offer some remarks on the analysis of sea-water and salt-brines, suggested by the view which I have explained in this: and the same view may perhaps lead to the illustration of a geological problem, hitherto involved in considerable difficulty, the origin of rock salt, and the relation of this mineral to the saline impregnation of the ocean.

---

#### ARTICLE IV.

*Geological Observations on North Wales.* By I. C. Prichard, M.D. F.L.S. F.W.S. &c.

(To Dr. Thomson.)

SIR,

IN traversing North Wales during the present summer, I observed some facts which induce me to suspect that the transition formation prevails more extensively in that country than is commonly supposed. The time which I had it in my power to spend there being very limited, I had no opportunity of resolving some interesting questions which presented themselves to me; but as the solution of them would establish an inference important with respect to the geology of our island, and as they might be easily determined by any person who could examine at leisure a district of no great extent, I venture to suggest them, and to offer my remarks to the public through the medium of your Journal.

The greater part of North Wales is occupied by clay-slate, which has all the characteristics of primitive clay-slate. Nearly the whole of the tract through which this rock extends may be surveyed in clear weather from the tops of the three principal mountains of Wales, viz. Plinlimon, Cader Idris, and Snowdon, and a general idea of the geological structure of the country may be thus obtained. It consists chiefly of ranges of mountains, which run from E. to W., or from N. E. to S. W. These mountains are generally more abrupt

towards the north than the south side. The declivity towards the south is often gentle, while the northern face is precipitous. This remark, however, is not universal.

The inclination of the strata is various. In many places they are vertical; but the dip most prevalent through the country appears to be towards the S. and S.W. This circumstance, compared with the position of the escarpments of the hills, indicates that in advancing from S. to N. you pass continually from newer to older formations.

On passing from the tract of the old red sand-stone in Herefordshire, the first rocks which present themselves are decidedly of the transition formation. Near Ludlow, in Shropshire, beds of clay-slate first occur alternating with thin beds of blue lime-stone, containing numerous impressions of small shells. From this place to Montgomeryshire clay-slate abounds. This I observed on my return. I entered North Wales through Brecknockshire; and the first transition rock which attracted my notice, and which appears immediately to succeed the old red sand-stone, is greywacke-slate, which about ten miles S. of Buallt forms magnificent cliffs on both sides of the river Wye. It splits into slates half an inch thick, and contains a large portion of mica. The beds dip at a considerable angle towards the S. E., and the hills form bold escarpments fronting the N. W.

Near Buallt the hills consist of a crumbling clay-slate resembling slate-clay. In the bed of the Wye, about three miles N. of Buallt, I found greywacke in mass alternating with a hard clay-slate. The former consisted of small fragments of quartz and clay-slate imbedded in a basis of clay-slate.

From Rhaiadyr to Hafôd, and to Plinlimmon, clay-slate prevails. At the Devil's Bridge it is quarried, and furnishes a fine blue roof slate, very hard, and of considerable lustre. The Plinlimmon chain consists of the same rock. Large veins of snow-white quartz traverse it in all directions, loose blocks of which are scattered on the tops of the mountains.

The chain of Cader Idris bears a great resemblance in the composition of its rocks to that of Snowdon. I ascended the former from Tal y Llyn by the side of Llyn y Cae. About half way up the mountain I found beds of clay-slate and of flinty-slate dipping at an angle of  $75^{\circ}$  to the S. The top of the hill consists of a beautiful clay-stone porphyry, containing crystals of felspar and some quartz imbedded in a basis of hard clay-stone, which passes into horn-stone. In some places the form of the felspar crystal is wanting, and the porphyry is amygdaloidal. It forms large tabular masses and columnar rocks, which affect a pentagonal form. I should have considered the upper part of this hill as an example of the overlying formation, if I had not found some facts in Snowdon which dispose me to a different opinion. The northern side of Cader Idris presents a bold precipice, in which the porphyritic rock forms beautiful

ranges of columns. It appeared to me to lie in strata which dip towards the S.

North of the Cader Idris chain a lower range of hills runs nearly parallel with it. The river Mowddach flows through the intervening valley. These hills consist, at least along the banks of the Mowddach, of a rock composed of felspar, and containing in some places large crystals of green hornblende, which alternates with clay-slate. At Rhaidyr dû a section of the rock has been formed by a torrent, where many of these alternations present themselves. These beds dip to the S., towards the direction of the Cader Idris chain. The same rock alternating with slate prevails very extensively between this place and the Snowdon range. The hornblende is often wanting.

I ascended Snowdon from Capel Curig, but on that side could distinguish nothing with respect to the disposition of the rocks. The porphyritic rock, resembling that of Cader Idris, extends quite to the base on the south-eastern declivity. But on going up on the northern side from Llanberris, I found a tolerably distinct appearance of strata, with an inclination towards the S. From the foot of the mountain to about half way up, I traced frequent alternations of clay-slate and porphyry. About two-thirds of the way up a precipice of considerable extent fronts the N., where the rock, though split by fissures in all directions, appears to be stratified, as before mentioned. The top of the mountain consists of porphyry.

In several other parts of the Snowdon chain, which I traversed in various directions, the appearance of stratification was more distinct than in the mountain which is properly called Snowdon. This I observed particularly between Capel Curig and Llyn Idwal. There are many quarries of roof slate in this range; and one of considerable extent, in a hill which is separated from Snowdon by the narrow valley of Llanberris.

This valley presents a beautiful section of the chain. Magnificent ranges of porphyritic rocks strike the eye on both sides, and by their columnar forms have given rise to the mistaken idea that these hills, as well as Cader Idris, are covered by basaltic rocks. I saw no trace of basalt on any part of them, neither could I discover any granite or mica-slate.

A question here presents itself whether the porphyritic rock which forms the top of Snowdon belongs to the overlying formation, or is conformable with the strata of clay-slate which constitute the base of the hill. This inquiry is, as it will presently appear, of considerable importance in assisting to determine the era to which a great part, if not the whole, of the slate formation in North Wales must be referred. From the huge tabular and columnar masses into which the porphyry is divided, and from its occupying more remarkably the tops of the mountains, I was at first led to refer it to the overlying formation; but the frequent alternations of the same porphyry with the clay-slate at the base of Snowdon, and other hills in the range, seem to countenance the opinion that it holds a position conformable with the clay-slate. Any person who would



examine the Snowdon and Cader Idris chains deliberately might easily determine this point with respect to both of them.

If it should turn out as I suspect, that the porphyry and clay-slate are conformable, the whole mountainous tract of North Wales must be considered as a transition country; for the former rock on Snowdon, and in other parts of the chain, *abounds in organic remains*. I found on the highest summit numerous impressions of shells, which appeared to be pectenites and terebratulites. There were several impressions of organic bodies, which I have not seen described, and some appearances resembling, though indistinctly, turbinated madrepores. I observed similar impressions on some blocks near Lake Ogwen.

If the Snowdon chain be not primitive, there is no part of North Wales which can with any degree of probability be referred to that formation.

I remain, Sir, your obedient servant,

Bristol, Sept. 15, 1815.

I. C. PRICHARD.

## ARTICLE V.

*Register of the Weather in Plymouth for the first Six Months of 1815.* By James Fox, jun. Esq. With a Plate.

### JANUARY.

Date.	Wind.	Rain.	Observations.
1815.			
Jan. 1	N		Fair morn; cloudy eve.
2	NNW to E		Cloudy and fair.
3	E		Ditto; fair at night.
4	ENE		Ditto morn; cloudy and fair afternoon.
5	ENE to N		Fair.
6	ENE		Cloudy and fair.
7	NNW	0.26	Fog morn; occasional showers.
8	NW		Snow showers.
9	E to WNW		Fog morn; cloudy day; showers at night.
10	WNW	0.10	Showers early in morn; cloudy day.
11	NW		Slight showers.
12	NW	0.16	Hail ditto, morn; fair afternoon.
13	WSW to WNW		Misty day.
14	N		Showers, morn; cloudy and fair afternoon.
15	NE		Cloudy morn; fair afternoon.
16	NNW		Cloudy and fair.
17	NNE		Hoar frost; cloudy morn; fair day.
18	NNE		Ditto; cloudy and fair.
19	NE		Snow showers.
20	N		Ditto.
21	NE		Fair morn; cloudy eve.
22	N		Cloudy morn; cloudy and fair eve.
23	N		Snow showers, morn; cloudy and fair eve.
24	E to ESE	0.02	Cloudy, and a shower.
25	NE		Snow showers.



Scale of the BAROMETER and THERMOMETER at Plymouth, January to June 1815.

*Place of Observation 33 feet above the level of the Sea*

*Page 406*

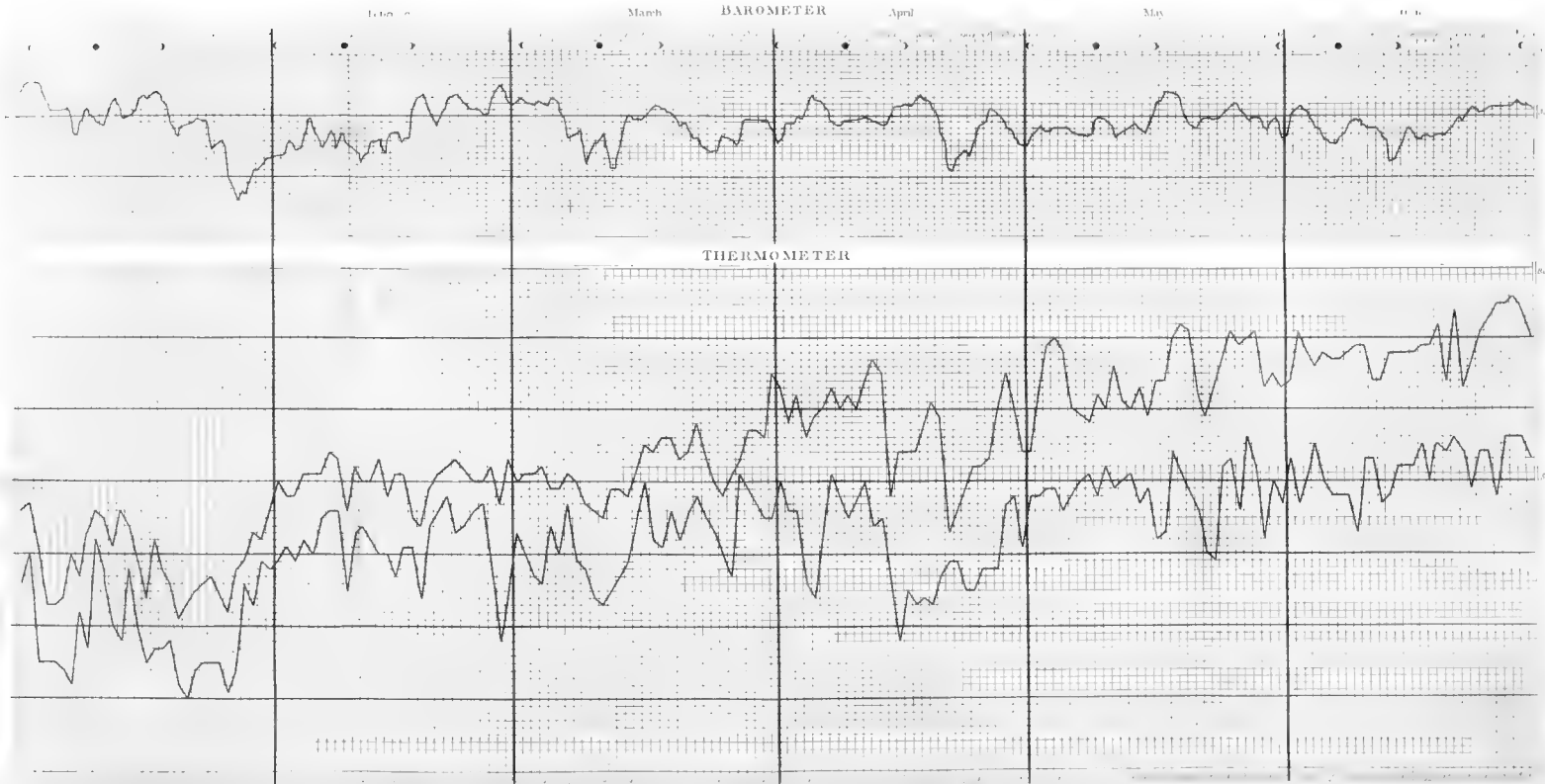

Date.	Wind.	Rain.	Observations.
1815.			
Jan. 26	E N E	} 0.35	Fair morn; snow showers, afternoon. Snow showers, and a gale of wind, morn; heavy showers, afternoon.
27	E N E		
28	S S W to W	0.40	Gale of wind, and heavy showers.
29	S S W to E	0.15	Heavy showers.
30	E N E	} 0.34	Thick weather. Ditto.
31	E N E to N N E		
		1.78	Inch rain.

Barometer: Greatest height.....	30.47 inches	Wind. E
Lowest .....	28.61	E N E
Mean .....	29.85	
Thermometer: Greatest height.....	47	E
Lowest .....	20	N E
Mean .....	34.39	

FEBRUARY.

Feb. 1	E N E		Fair morn; cloudy afternoon.
2	E N E		Light rain, morn; cloudy day.
3	E to S W	0.55	A wet day.
4	S W to W N W		Cloudy and fair.
5	S W to S	0.40	Cloudy morn; thick rain, and squally, at night.
6	S to S E	} 0.17	Light rain; high wind at night. Fine day; light rain at ditto.
7	W N W to S		
8	S S E to W N W	0.35	A stormy day.
9	W N W to E	0.25	High wind, and thick weather.
10	E to S	0.09	Thick weather, morn; cloudy and fair afternoon.
11	S S E to S W	0.28	Ditto, ditto.
12	S W		Stormy.
13	S W to E		Cloudy and fair; high wind.
14	E N E to W N W	0.27	Showery day.
15	S W	} 0.33	Misty day; -squally at night. High wind; heavy showers.
16	S W to W N W		
17	W N W to N N W	0.25	Ditto, ditto, morn; fair afternoon.
18	E to S W		Cloudy and fair.
19	S W to S S W	} 0.17	Showers; high wind at night. A heavy gale.
20	S W to W N W		
21	W N W		High wind; misty.
22	W N W to S W		Cloudy and fair.
23	S W		Ditto; at intervals misty.
24	S W		Ditto, ditto.
25	S S W		Misty.
26	N W		Cloudy morn; fair afternoon.
27	Var.		Fair.
28	E		High wind; fair.
		3.11	Inches rain.

			<i>Wind.</i>
Barometer: Greatest height.....	30.49 inches		Var.
Lowest .....	29.24		S S E
Mean .....	29.83		
Thermometer: Greatest height .....	54		S
Lowest .....	28		Var.
Mean .....	46.05		

MARCH.

Date.	Wind.	Rain.	Observations.
1815.			
March 1	S W	0.08	Misty; small rain.
2	Var.		Fair.
3	Var.	0.03	Ditto, day; misty at night.
4	S		Ditto, ditto.
5	S to W N W	0.11	Very misty day; fair at ditto.
6	E N E to S		Cloudy and fair.
7	S	0.85	Thick weather; a gale, and heavy rain, at night.
8	W N W		
9	W	0.67	Showers (heavy).
10	W N W	0.40	Ditto of snow, hail, and rain.
11	W N W	0.15	Showery day.
12	W by N	0.53	Ditto, and stormy.
13	W	0.46	Ditto, ditto.
14	N W		High wind; fair.
15	W	0.12	Misty.
16	W		
17	N W		Cloudy and fair.
18	W N W		Misty.
19	N W		Fair day; cloudy at night.
20	E S E		Cloudy and fair.
21	S to S S W	0.35	Cloudy morn; high wind and showers, afternoon.
22	W S W		
23	W	1.15	Ditto, and hail ditto.
24	W		
25	W	0.56	Ditto, ditto.
26	S W		
27	S W	0.60	A storm, and heavy rain.
28	W		High wind; cloudy and fair.
29	S E to S		Cloudy and fair.
30	S S E		Misty.
31	E S E		Fair.
		6.06	Inches rain.

			<i>Wind.</i>
Barometer: Greatest height.....	30.29 inches		Var.
Lowest .....	29.11		W
Mean .....	29.82		
Thermometer: Greatest height .....	65		E S E
Lowest .....	33		W N W
Mean .....	47.14		

APRIL.

Date.	Wind.	Rain.	Observations.
1815.			
April 1	ESE to SSE		Fair day; cloudy at night.
2	S W		Cloudy and fair morn; fair afternoon.
3	W		Fair.
4	W to W N W		Cloudy morn; fair afternoon.
5	W to W S W		Cloudy and fair.
6	W S W		Cloudy.
7	E		High wind; fair.
8	E		Ditto, ditto.
9	W		Cloudy and fair.
10	E	0.03	Ditto, and a shower.
11	Var.		Ditto.
12	Var.		Ditto; fog, morn.
13	Var.	0.23	Fog, morn; showers hail, afternoon.
14	N N E to N N W		Cloudy day; snow shower at night.
15	Var.		Cloudy and fair.
16	W S W		Ditto, ditto.
17	S W to E		Ditto, ditto, and a hail shower.
18	N N W		Fair.
19	N W		Ditto.
20	N by W		Cloudy morn; fair afternoon.
21	N by W	0.21	Squally, with showers.
22	W	0.48	Ditto, ditto.
23	W	} 0.36 {	Showers.
24	W		Ditto.
25	N by W	0.03	Very light ditto.
26	N E to E		Fair.
27	E		Ditto.
28	E		Ditto.
29	E		Misty morn; cloudy day.
30	E		Cloudy day; showers at night.
		1.34	Inch rain.

			<i>Wind.</i>
Barometer: Greatest height.....	33.33 inches		W
Lowest .....	29.10		W
Mean .....	29.89		
Thermometer: Greatest height.....	67°		Var.
Lowest .....	28		N W
Mean .....	49.37		

MAY.

May 1	E	1.24	Heavy rain.
2	S W		Cloudy and fair.
3	W		Cloudy morn; fair afternoon.
4	N to W N W		Fair.
5	W N W		Ditto; cloudy at night.
6	SSE	} 0.68 {	Cloudy day; rain at night.
7	S		Heavy showers.
8	S	} 0.17 {	Ditto, ditto.
9	S W		Fair day; showers at night.
10	S S W		Thick weather.

Date.	Wind.	Rain.	Observations.	
May 11	SE to SSW	0.13	Cloudy and fair morn; high wind and showers, afternoon.	
12	SW to SSW			
13	WSW	0.44	Showers, and high wind. Ditto, ditto. Ditto, ditto. Ditto early, morn; cloudy and fair day.	
14	S			
15	S			
16	WNW			
17	Var.	0.18	Cloudy and fair.	
18	NW		Ditto.	
19	NW to NNW		Fair.	
20	WNW		Ditto; cloudy and high wind at night.	
21	NW		High wind, and hail showers.	
22	NW		0.11	Ditto, and showers. Light ditto.
23	WNW			
24	W by N		Cloudy and fair.	
25	S to NW		Fair.	
26	W to E		Fog morn; fair day.	
27	E	High wind; fair.		
28	Var.	Cloudy and fair.		
29	ESE to S	0.10	Showers; high wind, afternoon. High wind, and showers.	
30	WNW			
21	E to SE			0.75
		3.80	Inches rain.	

Barometer: Greatest height.....	30.40 inches	Wind.
Lowest .....	29.54	Var.
Mean .....	29.90	E
Thermometer: Greatest height.....	72	NNW
Lowest .....	39	WNW
Mean .....	56.30	

JUNE.

1	E to NNE	0.07	Fog morn; light showers, afternoon.
2	Var.		Cloudy and fair.
3	WNW		Cloudy.
4	W to S		Misty.
5	NW	0.17	Showers.
6	SW		Cloudy and fair.
7	S	0.31	Heavy showers.
8	NW	0.25	Ditto.
9	W to SW		Fog; cloudy and fair.
10	S		Cloudy and fair.
11	SE to S	0.32	Heavy rain, morn; cloudy and fair afternoon.
12	ESE	0.15	Showers.
13	S to ESE	0.25	Cloudy day; high wind and rain at night.
14	S to WNW	0.15	High wind, and showers.
15	Var. at E		Cloudy and fair.
16	E	0.69	Cloudy morn; heavy rain, afternoon and eve.
17	S to WNW		Cloudy and fair.
18	Var.	0.10	Ditto, ditto, morn; showers, afternoon.



Date.	Wind.	Rain.	Observations.
1815.			
June 19	S to E	} 0.54 {	Ditto, ditto, ditto.
20	E N E to W N W		Heavy showers.
21	W N W to N W		Fair day; cloudy at night.
22	S		Cloudy and fair.
23	N W	0.09	Ditto, ditto, day; light rain at night.
24	N to N W		Misty.
25	N W		Cloudy and fair.
26	N W		Ditto, ditto.
27	Var.		Ditto, ditto.
28	Var.		Fair.
29	E		Ditto; high wind.
30	E		Ditto, ditto.
		3.09	Inches rain.

Barometer: Greatest height .....	30.21 inches	<i>Wind.</i>
Lowest .....	29.25	Var.
Mean .....	29.885	E S E
Thermometer: Greatest height.....	76°	Var.
Lowest .....	43	W
Mean .....	60.15	

## ARTICLE VI.

*Observations on Mr. Dalton's Theory of Chemical Composition.*

By Peter Ewart, Esq.

(Read to the Philosophical Society of Manchester, Sept. 1812.)

It has long been observed that chemical compounds contain their elements in limited proportions; and it has at all times been a chief object with chemists to ascertain these proportions in bulk, as well as in weight. Various attempts have been made, also, to trace some general principle of agreement in the phenomena of chemical composition. In this field of investigation Mr. Dalton has been eminently successful. About ten years ago, observing a remarkable coincidence in the proportions of the elements contained in some chemical compounds, he was led to believe that this coincidence could not be partial or accidental, but that it might form part of a general system, comprehending every chemical combination. Under this impression, he examined and compared, with great skill and ingenuity of research, a prodigious number of compounds; and he has published a valuable collection of facts, established by others as well as by himself, throughout the whole of which the principle of

composition, which he first observed only in a few instances, is found to prevail.\*

A small number of facts are sufficient to explain the nature of this principle; and in the following it appears very distinctly.

1st. 100 grains of olefiant gas contain 85 of carbon and 15 of hydrogen; † that is, in the proportion of 5·6 carbon to 1 hydrogen.

2d. 100 grains of carbonic oxide contain  $44\frac{1}{2}$  carbon and  $55\frac{1}{2}$  oxygen; ‡ that is, in the proportion of 5·6 carbon to 7 oxygen.

3d. 100 grains of water contain  $12\frac{1}{2}$  hydrogen and  $87\frac{1}{2}$  oxygen; § that is, in the proportion of 1 hydrogen to 7 oxygen.

4th. 100 grains of carbureted hydrogen contain 74 carbon and 26 hydrogen; || that is, in the proportion of 5·6 carbon to 2 hydrogen.

5th. 100 grains of carbonic acid contain 28·6 carbon and 71·4 oxygen; \*\* that is, in the proportion of 5·6 carbon to 14 oxygen.

Now it is very remarkable that the last terms, in the first and second of these proportions, are the same as the first and second terms, representing the proportions of the same elements, in the third compound.

In the fourth and fifth compounds we have a further coincidence of a different kind. Here we have the same elements as in the two first compounds; and the last terms of the proportions in the first and second, multiplied by two, are respectively equal to the last terms of the fourth and fifth.

Presuming that something more than an accidental coincidence is indicated by such agreements as these, Mr. Dalton proposes to explain them as follows.

If we suppose the ultimate divisions, or atoms, which unite in chemical compounds of carbon, hydrogen, and oxygen, to be of different relative weights, in the proportion of 5·6, 1, and 7, we shall have equal numbers of atoms of each of their elements in each of the first three compounds; and if the compounds be homogeneous, each atom of carbon in the first compound must be united to an atom of hydrogen; and in the second, each atom of carbon must be united to an atom of oxygen; in the third compound, each atom of hydrogen must be united to an atom of oxygen; each atom of carbon in the fourth compound must be united to two atoms of hydrogen; and in the fifth, each atom of carbon must be united to two atoms of oxygen. Upon this principle, then, we have the ex-

\* It is not a little remarkable, that the labours of some of the principal modern chemists in Europe, where *quantity* was the object of research, have given results uniformly favourable to the establishment of this principle, though they have been in some instances unacquainted with it. Witness those of Clement and Desormes, Wollaston, Davy, Henry, Berthollet, Berard, Gay-Lussac, Berzelius, &c. &c.

† Thomson, Nich. Jour. xxviii. 332. Davy, 309.

‡ Clement and Desormes, Ann. Chim. tom. 39.

§ Humbolt, Gay-Lussac, Ann. Chim. 1805. Nich. Jour. xxx. 270.

|| Henry, i. 355, a deduction. Davy, 307.

\*\* Allen and Pepsy.

planation of a connected agreement in these five compounds, which would be destroyed by a small variation in the composition of any one of the five.

In the following nine compounds, seven of which are solids, the same principle is found to prevail with as much uniformity as in the gaseous fluids and water, which we have been comparing.

1. 100 grains of sulphurous acid contain 50 grains of sulphur\* and 50 grains of oxygen; that is, nearly in the proportion of 14 sulphur to 14 oxygen.

2. 100 grains of sulphuric acid contain 40·6 grains of sulphur† and 59·4 grains of oxygen; that is, nearly in the proportion of 14 sulphur to 21 oxygen.

3. 100 grains of black oxide of iron contain 78 grains of iron‡ and 22 grains of oxygen; that is, nearly in the proportion of 50 iron to 14 oxygen.

4. 100 grains of red oxide of iron contain  $70\frac{1}{2}$  grains of iron‡ and  $29\frac{1}{2}$  grains of oxygen; that is, nearly in the proportion of 50 iron to 21 oxygen.

5. 100 grains of sulphuret of iron contain 78 grains of iron§ and 22 grains of sulphur; that is, nearly in the proportion of 50 iron to 14 sulphur.

6. 100 grains of magnetic pyrites contain 64 grains of iron|| and 36 grains of sulphur; that is, nearly in the proportion of 50 iron to 28 sulphur.

7. 100 grains of pyrites of Soria contain 54·3 grains of iron || and 45·7 grains of sulphur; that is, nearly in the proportion of 50 iron to 42 sulphur.

8. 100 grains of common pyrites contain 47 grains of iron || and 53 grains of sulphur; that is, nearly in the proportion of 50 iron to 56 sulphur.

9. 100 grains of sulphate of iron contain 49·78 grains of red oxide of iron\*\* and 50·22 grains of sulphuric acid; that is, nearly in the proportion of 71 red oxide of iron to 70 sulphuric acid.

If we suppose, as before, the relative weight of an atom of oxygen to be as 7, and if we further suppose those of sulphur and iron to be respectively as 14 and 50, we shall have,

1st. In sulphurous acid, each atom of sulphur united to two atoms of oxygen.

2d. In sulphuric acid, each atom of sulphur united to three atoms of oxygen.

3d. In black oxide of iron, each atom of iron united to two atoms of oxygen.

4th. In red oxide of iron, each atom of iron united to three atoms of oxygen.

\* Davy, 274.

† Berzelius, *Ann. de Chim.* lxxviii. 44.

‡ Davy, 110.

§ Vauquelin.

|| Hatchett and Proust, *Nich. Jour.* x. and xi.

\*\* Berzelius, *Ann. de Chim.* lxxviii. 218.

5th. In sulphuret of iron, each atom of iron united to one atom of sulphur.

6th. In magnetic pyrites, each atom of iron united to two atoms of sulphur.

7th. In pyrites of Soria, each atom of iron united to three atoms of sulphur.

8th. In common pyrites, each atom of iron united to four atoms of sulphur.

9th. In sulphate of iron, each atom of red oxide of iron united to two atoms of sulphuric acid.

In the ninth compound we have an example of the union of two compound atoms; and in the same manner various other compound atoms are found to be united in compounds which contain more than two elements.

Indeed any atom at present supposed to be simple may afterwards be found to be compounded of others more simple; for upon this principle it is not concluded that an atom of any known element is in its smallest *possible* state of division. The word atom is intended to express merely the smallest division which is found of any element *without decomposition*.\*

Thus an atom of carbonic acid, one of the elementary particles constituting that elastic fluid, is only capable of division into oxygen and charcoal. It is possible that atoms of oxygen and charcoal may be further divided, but we do not yet know that the division is practicable. Neither is it understood that the relative weights of the atoms of the five elements, the combinations of which we have been comparing, are *precisely* as 1, 5.6, 7, 14, and 50. It is obvious that their relative weights can, upon Mr. Dalton's principle, be determined only by the agreement of a great number of nice, and often difficult, analyses; and in proportion as more accurate analyses are

\* It is not assumed that the ultimate elementary particles or atoms of matter are absolutely *indivisible*. But in support of the opinion that they have remained *undivided* since the creation of the world, and that the permanence of the specific properties of all material objects depends upon their atoms remaining *undivided*, Mr. Dalton has referred to the following observations of Sir Isaac Newton:—

“It seems probable to me that God in the beginning formed matter in solid, massy, hard, impenetrable, moveable, particles, of such sizes and figures, and with such other properties, and in such proportion to space as most conduced to the end for which he formed them; and that these primitive particles being solids, are incomparably harder than any porous bodies compounded of them; even so very hard, as never to wear or break in pieces, no ordinary power being able to divide what God himself made one in the first creation. While the particles continue entire, they may compose bodies of one and the same nature and texture in all ages; but should they wear away, or break in pieces, the nature of things depending on them would be changed. Water and earth, composed of old worn particles and fragments of particles, would not be of the same nature and texture now with water and earth composed of entire particles in the beginning. And therefore that nature may be lasting, the changes of corporeal things are to be placed only in the various separations and new associations, and motions of these permanent particles; compounded bodies being apt to break, not in the midst of solid particles, but where those particles are laid together, and trusts only in a few points.”—*Horsley's Newton*, iv. 260.

obtained, these relative weights may be determined with greater precision.

Some objections, however, have been made to this explanation of the phenomena of chemical composition.

1. It is said that we have no means of ascertaining or judging of the weight or the magnitude of an atom of any element, and that any supposed relative weight of their atoms must therefore be a mere hypothetical assumption, from which no satisfactory conclusion can be drawn.

It is true we can never expect to produce any of these minute divisions, so as to ascertain their relative weights by balancing them separately in scales. But if we may be allowed to compare great things with small, may not the same objection be made to the manner in which the relative masses of the planets are determined? These are by their great magnitude as much as the ultimate divisions of chemical elements are by their extreme minuteness, beyond the reach of the ordinary means of comparison. The means, however, by which the relative masses of the heavenly bodies have been determined, are quite as satisfactory as if they had been weighed in scales. They are determined by the observed phenomena of the heavens, on the principle that these phenomena may be distinctly explained by supposing the masses, distances, and attractions, of the different bodies in question to bear certain relations to each other. And if the observed phenomena of chemical composition can be explained by supposing the weights of the ultimate divisions of chemical elements to bear certain relations to each other, we may be equally well satisfied that such relations exist.

2. But it has been said that the phenomena of chemical composition require no such supposition, that we may with as much consistency suppose the ultimate divisions of all elements to be of equal weight, or that we may suppose their weights to bear any imaginable proportion to each other. Let us examine how far such suppositions are consistent with the observed phenomena.

If we suppose the atoms of all elements to be of equal weight, we may suppose 28 atoms of carbon to be united to five of hydrogen in the composition of olefiant gas; four of carbon to five of oxygen in carbonic oxide; and one of hydrogen to seven of oxygen in the composition of water.

But in this way we should leave the agreement in the proportions observed by Mr. Dalton quite unaccounted for. And if the phenomena of chemistry are ever to be reduced into a system, like those of astronomy, surely such a series of remarkable agreements must be considered as a promising clue to lead to the true theory.

We may indeed suppose 28 atoms of carbon to be united to 35 of oxygen in carbonic oxide, and five of hydrogen to 35 of oxygen in the composition of water, and thus exhibit the same agreement which Mr. Dalton observed; but still we cannot show by these combinations any *reason* for this agreement.

Besides, if we attempt to form an idea of the position and

arrangement of 28 atoms of carbon combined with 35 of oxygen, we find it very confused; and hence we may reasonably doubt whether nature ever forms such combinations. Upon Mr. Dalton's supposition, however, the *reason* for the agreements, which he has pointed out, is obvious. It should be observed; that the agreement in the first stated combination of three elements, in three different compounds, is quite of a different kind from that of the combination of multiples of the same elements. If no two combinations of the same elements had ever been found, the combination of three elements, as observed in the first three compounds, might still have existed; and Mr. Dalton's explanation appears to be the only one to which such phenomena can be referred. Respecting the fourth and fifth compounds, it may be questioned whether the relative weight of an atom of carbon may not be 2.8 instead of 5.6, and one atom of carbon be united to one of hydrogen in the composition of carbureted hydrogen, and one atom of carbon to one of oxygen in carbonic acid. Upon this supposition, then, we must have two atoms of carbon united to one of hydrogen in olefiant gas, and two atoms of carbon to one of oxygen in carbonic oxide.

To this arrangement Mr. Dalton offers the following objections: 1. It is almost universally observed in chemical compounds, that the most simple are the most difficult to be decomposed; and carbonic oxide being much more difficult to be decomposed than carbonic acid, we cannot consistently suppose the latter to be the most simple in its composition. If we attend to the probable mechanical actions of the elementary atoms on each other, we may receive additional confirmation of this principle of composition. In the compression of elastic fluids, it is found that their expansive force is nearly in proportion to their density; and Sir Isaac Newton has demonstrated (*Principia*, lib. 2, prop. 23,) that if such fluids are composed of particles mutually repelling each other, the central distances of the particles are reciprocally as the cube roots of the densities of the fluids, and the repelling forces of the particles are reciprocally as their central distances. If we suppose this law of repulsion to continue the same after chemical union as before, the union of two or more particles of atoms of one element to one atom of another, cannot be so strong as when they are united one to one. For if H H be two atoms of hydrogen attracted by C, an atom of carbon; and if H and H mutually repel each other, they will assume positions diametrically opposite to each other, and their attraction to C will be diminished by their mutual repulsion. Now if we suppose A, B, D, to be three atoms of hydrogen united to C, they will assume positions at equal distances from each other round C. Draw the diameter D E, join C A, E A, and A D, and draw C F perpendicular to A D. The repulsion of A from D will be greater

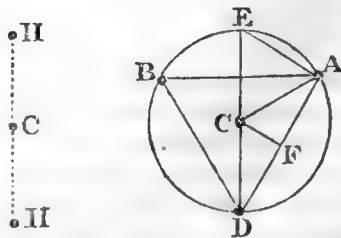

than it would be if A were at E, in the ratio of D E to D A ; and by the composition of forces, it will be less in the direction of C A than in that of D A, in the ratio of A F to A C. But A D E and F A C being similar triangles,  $AC : AF :: DE : DA$ . The repulsion of A from D, in the direction C A, will therefore be the same at whatever point in the circle A be placed ; and the repulsion of A from B in the direction C A being the same also, each of the three atoms A, B, D, will be repelled from C with twice as much force as when only two atoms are united to C. For the same reason, when four atoms are united to C, they will be repelled with three times as much force ; and so on for any greater number of atoms united to C.

2. In chemical compounds it is generally, if not universally, observed, that an increase of specific gravity is a consequence of chemical union ; and the specific gravity of carbonic acid being greater than that of carbonic oxide, we cannot consistently suppose the latter to be twice, and the former only once, compounded.

3. It rarely happens that bodies of low oxidation are acid, and those of high oxidation not acid. The first combination of a body with oxygen produces an oxide ; and it is not till a second or third addition of oxygen is made that the characters of an acid are found in the compound. We cannot, therefore, consistently suppose carbonic acid to be the first, and carbonic oxide the second, combination of oxygen with carbon.

4. In comparing the various compositions of carbon with other elements, Mr. Dalton finds that the combinations of the different atoms would be much more complicated, as well as inconsistent with each other, if the relative weight of an atom of carbon were supposed to be 2.8 instead of 5.6.

It is obvious, indeed, that the agreements, which Mr. Dalton has pointed out, cannot be explained by any arbitrary assumption of the relative weights of the ultimate divisions of chemical elements, which enter into composition with each other.

The same reasoning applies to all compounds where the same agreements are observed ; and the number of these, established by some of the best chemists of the present and former times, is so great that it is not easy to refuse assent to the generalization of Mr. Dalton's principle of chemical composition.

It is true there are several compounds which appear to be at variance with this principle. But if we consider the extreme difficulty of separating the elements of some chemical compounds, and the uncertainty which must in many cases remain respecting what is or is not elementary, we cannot in the present state of the science reasonably expect all the appearances to be distinctly explained.

When these things are considered, I think it is most to be wondered that there are so few apparent exceptions to the law which has been unfolded by Mr. Dalton.

This principle, and the facts on which it is founded, are directly



in opposition to the explanation which Berthollet has attempted to give of chemical affinity. But if Berthollet's opinions with regard to the effect of quantity on what he understands to be the relative forces of chemical affinity were established, not only Mr. Dalton's observations, but almost all the conclusions of chemists, respecting composition, would be overturned. The errors of Berthollet, however, have been distinctly pointed out by Proust (*Jour. de Phys.* lix. 1804); and it is surprising that so good a chemist, and so accurate a reasoner, as Berthollet, should have mistaken so many mechanical mixtures for chemical compounds.

The agreements observed by Gay-Lussac in the relative bulks of gases which enter into combination with each other are in some instances in conformity with Mr. Dalton's observations respecting their relative weights. In other instances, when he states certain relations to exist between the bulk of the compound and its elements, he is at variance with Mr. Dalton; and the question between them can be determined only by repeated experiments.

It is obvious, however, that whatever agreements may be traced in the relative bulks of the elementary gases, all such proportions must be lost when the gases are changed into fluids or solids.

Mr. Dalton's explanation has the advantage of not being affected by the specific gravities of the elements or of the compound; and it applies equally to gases, fluids, and solids.

---



---

## ARTICLE VII.

### *Magnetical Observations at Hackney Wick.* By Col. Beaufoy.

Latitude,  $51^{\circ} 32' 40.3''$  North. Longitude West in Time  $6^{\text{h}} \frac{8.2}{10.0}$ .

1815.

Month.	Morning Observ.			Noon Observ.			Evening Observ.		
	Hour.	Variation.		Hour.	Variation.		Hour.	Variation.	
Sept. 18	8h 20'	24°	15' 41''	1h 55'	24°	18' 51''	6h 15'	24°	17' 17''
Ditto 19	8 15	—	15 48	—	—	—	—	—	—
Ditto 20	8 25	24	14 43	1 30	24	21 43	6 05	24	17 33
Ditto 21	8 30	24	18 32	1 35	24	23 01	6 15	24	16 30
Ditto 22	8 20	24	14 17	1 50	24	21 30	6 00	24	19 10
Ditto 23	8 40	24	15 06	1 40	24	21 03	6 05	24	16 43
Ditto 24	8 25	24	14 15	—	—	—	6 05	24	18 26
Ditto 25	8 25	24	13 25	1 40	24	23 28	6 05	24	18 02
Ditto 26	8 20	24	15 00	1 35	24	29 46	6 00	24	15 33
Ditto 27	8 20	24	16 00	1 20	24	18 00	6 00	24	20 24
Ditto 28	8 00	24	23 20	1 15	24	24 31	5 50	24	24 08
Ditto 29	8 25	24	22 36	1 20	24	25 31	5 50	24	23 11
Ditto 30	8 35	24	20 06	1 25	24	26 54	5 55	24	21 22

## Comparison of Observations.

		1813.	1814.	1815.
April.....	Morning .....	24° 09' 18"	24° 12' 53"	24° 16' 01"
	Noon .....	24 21 12	24 23 53	24 27 42
	Evening.....	24 15 25	24 15 30	24 17 48
May .....	Morning .....	24 12 02	24 13 12	24 16 32
	Noon .....	24 20 54	24 22 13	24 27 03
	Evening.....	24 13 47	24 16 44	24 19 12
June.....	Morning .....	24 12 35	24 13 10	24 16 11
	Noon .....	24 22 17	24 22 48	24 27 18
	Evening.....	24 16 04	24 16 29	24 19 40
July.....	Morning .....	24 14 32	24 13 29	24 15 51
	Noon .....	24 23 04	24 23 44	24 25 45
	Evening.....	24 16 43	24 17 00	24 19 42
August....	Morning .....	24 15 55	24 14 13	24 16 01
	Noon .....	24 23 32	24 23 48	24 24 07
	Evening.....	24 16 08	24 16 31	24 18 22
September.	Morning .....	24 15 46	24 14 33	24 15 58
	Noon .....	24 22 32	24 23 17	24 23 01
	Evening.....	24 16 04	24 16 50	24 17 25

In deducing the mean, the observation on the noon of the 30th and 26th, and the observations on the evening of the 27th, 28th, 29th, and 30th, are rejected. On Sept. 26, rain fell. On the 27th, hard rain, with thunder and strong wind. Sept. 29, the sky was very black in the west, and hard rain fell afterwards. Sept. 30, rain.

Rain fallen { Between noon of the 1st Sept. } 1·100 inch.  
 { Between noon of the 1st Oct. }  
 Evaporation during the same period ..... 2·600

## ARTICLE VIII.

*Some Remarks on the Theory of the Equilibrium of Radiant Heat, and on some Difficulties started against that Theory.* By M. P. Prevost, Professor of Philosophy at Geneva.\*

I. In the *Annals of Philosophy* for May, 1815, vol. v. p. 338, there is a very good refutation of some objections to the theory of the equilibrium of radiant heat. The objections mentioned by the author of that memoir (Mr. Richard Davenport) are three in number.

The first, extracted from the new *Edinburgh Encyclopædia*, is announced in these terms: "On this hypothesis a hot body ought to cool more slowly when it is placed near a large body of inferior

\* It may be proper to state, that this paper was drawn up by the author in the French language, and that I have translated it into English.—T.

temperature than when near a small one; because in the former case it must receive more calorific emanations than in the latter."

The second is repeated in the same work from Mr. Murray. It is drawn from the difference in the radiation of two bodies, whose surfaces are different; such, for example, as a metallic surface and a blackened surface. "Of different surfaces which at a given temperature radiate different quantities of caloric, that which radiates least must be least powerful in returning caloric to the thermometer, and must therefore have least effect in counteracting the reduction of temperature." And in applying this general remark, the author of the objection concludes from it, that if the theory of the equilibrium were true, it would follow that the blackened surface (which radiates most) ought to produce a less degree of cold than the metallic surface (which radiates least).

I may attempt shortly to explain what is merely hinted at in the objection such as I have transcribed it. Two bodies colder than the room are supposed, I conceive, to be presented to a thermometer, one of them terminated by a metallic surface, the other by a blackened surface. It is known that the blackened body will soonest acquire the temperature of the place, and therefore will sink the thermometer most powerfully during the time of its heating.

The author of the objection seems to think that, according to the theory of equilibrium, the contrary ought to happen, because the black body radiates more powerfully than the metallic surface; and because this radiation, in part compensating the loss which the thermometer experiences from its own radiation, ought to be most efficacious in that of the two bodies, which radiates most abundantly.

The third objection is likewise by Mr. Murray. It is drawn from the following experiment. A conical metallic tube, about 18 inches long, one inch in diameter at its narrowest extremity, and five inches at its widest, polished internally, so as to make a good reflector, is placed in a horizontal situation. A very sensible thermometer is placed at the widest end, and a matráss full of ice at the other. The thermometer sinks a very little. The experiment is now reversed; so that the thermometer occupies the narrow end, while the matráss is placed at the widest extremity. In this case the thermometer sinks much more rapidly than in the preceding. This appears to the author of the objection incompatible with the theory of the equilibrium; doubtless because he conceives that the calorific rays ought to be condensed in the second situation of the tube, and thereby render the cooling of the thermometer less sensible.

This experiment originated with Count Rumford (*Memoir on Heat*, 1804, p. 146); and he proposed it as a proof of the frigorific undulations, which he admitted, and which he compared to the sonorous waves. This objection may be proposed in a much more simple form. In a place where the temperature is uniform, let a thermometer be presented to the narrow end of the tube: no rise

whatever will ensue. Those who make the preceding objection ought to be astonished at this result, and to blame the theory for not explaining it.

Many other objections may be started, and have indeed been raised, in consequence of the same imperfect and erroneous conceptions. I shall only mention one, which, like the preceding, has only become known to me by means of a good refutation.

The refutation is by M. Tremery, who has inserted it in the *Nouveau Bulletin des Sciences* (Août, 1813, No. 71, p. 323): and the objection, the author of which he does not name, is relative to the reflection of cold by means of two concave mirrors. It is known that the theory of the equilibrium explains the result of this experiment respecting the reflection of cold with the same facility as it does the reflection of heat. It is needless to state this part of the theory, which is, I believe, pretty generally known.

To this explanation it is objected, that the matrass of ice or snow placed at one of the foci, being supposed to radiate, ought to send by double reflection some rays to the thermometer placed in the other focus. If the mirrors were withdrawn, these rays would be dissipated, and would not come to the thermometer. Therefore when the mirrors are removed, the thermometer ought to sink, and it ought to rise again when the mirrors are replaced, which is contrary to the matter of fact.

II. These objections have been foreseen and refuted long ago, in a work entitled *Du Calorique Rayonnant*, which I published in 1809 (at Geneva and in Paris; Paschoud). Some of them are even peculiarly answered, particularly that one drawn from the experiment with the conical tube (*Du Calorique Rayonnant*, § 113). I have therefore only to refer to that work. But as philosophers occupied with this subject have been obliged to enter into considerable details in order to get rid of these difficulties, started frequently without any regard to the previous solutions of them, it will not be without utility to state here as simply as possible the principles on which the theory depends, and on which the answers to these objections depend. These principles are at bottom the same as those explained by Messrs. Tremery and Davenport; and I shall state them more shortly, and perhaps more generally.

1. I suppose that constitution of caloric which agrees best with the phenomena of radiation to be known and admitted. It is a discrete fluid, every particle of which moves rapidly in a straight line. These particles go, one in one direction, and another in another; so that every sensible point of the hot space is a centre, from which depart, and to which arrive, rows of particles or calorific rays.

2. A reflector in a place of uniform temperature sends neither more nor fewer calorific rays than another body.—In fact, the reflector will not be called of the temperature of the place till the assertion which I have just made be verified; and in a short time this cannot fail to happen from the laws of the equilibrium of heat.

As to the thermometrical effect, it is of no consequence whether

the rays passing from the body be transmitted (that is to say, emanated from the interior of the body,) or reflected. If the reflector is perfect, the whole current is composed of reflected rays; if it is imperfect, it is composed of reflected and transmitted rays.

The most convenient way of representing to oneself an imperfect reflector is to conceive its surface decomposed into two parts, one of which is a perfect reflector, while the other does not reflect at all.

We must here apply the laws of the reflection of light. In particular we must observe that the surface reflects inwards as well as outwards.

3. Every calorific ray which a body sends by emission or by reflection, only replaces another ray, which would take the same direction if the body were withdrawn.\* This is a necessary result of the constitution of caloric; for whatever be the direction of the rays emitted or reflected, there is one which follows the same route, and which the body intercepts.

4. It follows from this, 1. That in a place of uniform temperature, a reflector of whatever form does not affect a thermometer subjected to its influence. 2. That if it reflect rays emanated from a body more or less hot than the place, it will raise or depress respectively the thermometer subjected to its influence.

III. The application of these principles to the objections detailed offers no difficulty. Let us take for an example the first two objections stated in the *New Edinburgh Encyclopædia*.

1. A hot body, it is said, ought to cool slower before a large cold body than before a small.

The objector forgets that each of the rays which the cold body sends merely replaces the ray which the cold body intercepts. The intercepted ray being hotter than that which comes in its place, it is easy to see that the more of these substitutions take place (or, in other words, the larger the cold body is) the greater will the cooling effect be.

2. Two bodies, the one with a metallic, the other with a blackened, surface, are presented to a thermometer. It is alleged that the blackened body ought to cool the thermometer least, because it radiates most.

Here the objector has not thought of the portion of radiant heat which these bodies give out by reflection. This portion is not changed by the change of temperature of the body. It subsists quite entire. The portion emitted only is diminished. Therefore by the same diminution of temperature, that one of the bodies which emits the most (the blackened surface) ought to radiate least; that one, on the contrary, which is the best reflector (the metallic surface) ought to radiate most, which is conformable to experience.

\* It is to be understood that we speak of a hot place, that is to say, where caloric radiates. If the intercepting body is of the same temperature with the place, the ray which it replaces is equal to itself. If not, this ray or row of particles, is more or less abundant in caloric.

This is explained in the work cited above. (*Du Calorique Rayonnant*, § 121.)

A good method of judging of this effect is to take an extreme case. Let us suppose the body to be a perfect reflector. In this case the internal cooling of the body would make no alteration in its radiation. The thermometer exposed to its influence would not be affected by it. In fact, before the cooling, the temperature being uniform, the body would radiate by reflection, and this radiation would be precisely equal to that of all the bodies in the same place : and since it is supposed a perfect reflector, it would not emit any heat. Every thing continues the same after the interior cooling of this reflecting body.

I confine myself to these two objections. They are sufficient for pointing out the method of answering all the others.

Thus it appears that in order to be able to refute objections of this nature, nothing more is necessary than to understand well the theory against which they are made. Those who have been struck with these objections without sufficiently examining this theory ; and in particular the celebrated philosophers who have given them weight by inserting them in their works, will probably find it just and useful to insert also the answers to them, if they appear to them, as they do to me, perfectly satisfactory.

IV. It is doubtless very useful that the objections which occur to philosophers against a probable theory should be explained at some length, and laid before those who are examining that theory. The consequence is a discussion which must be of advantage to the side of truth. It is therefore always with a kind of gratitude that I meet with such objections against the equilibrium of heat : and I experience a kind of dissatisfaction when I meet with mere indications of some difficulty, without its being possible for me to divine in what they consist. Time is lost in seeking for them. One runs the risk of being deceived ; and it may easily happen that when we think we are untying the knot, we are only pursuing useless researches without an object. In my *Treatise on Caloric* (p. 93, note) I have given an example of this kind of uncertainty.

More recently I have been in an equal state of uncertainty on reading a note in p. 105 of the excellent work of Dr. Wells on Dew. Few works have so much interested me ; few, I believe, show more completely the genius for observation and the love of truth. I could not, therefore, be indifferent to the opinion of so distinguished an author respecting an explanation connected with the theory of the equilibrium of heat, which I still consider as correct. The note to which I allude is as follows :—

“ I once intended to add here an explanation of some curious observations by M. Prevost, of Montauban,\* on dew, which were published first by himself in the 44th No. of the French Annals of

\* The author has inserted here Beaunon instead of Montauban. I have corrected this slight mistake.

Chemistry, and afterwards by M. Prevost, of Geneva, in his *Essay on Radiant Heat*; but, fearing to be very tedious, I have since given up the design. I will say, however, that if to what is now generally known on the different modes in which heat is communicated from one body to another, be added the two following circumstances, that substances become colder than the air before they attract dew, and that bright metals when exposed to a clear sky at night become colder than the air much less readily than other bodies, the whole of the appearances observed by M. Prevost may be easily accounted for."

Dr. Wells having under his inspection my treatise on radiant heat, the principles of which he has adopted, could not but have read my explanation of the curious phenomena observed by my relation, and which this last Gentleman has adopted. Since, then, in the above note, the author speaks of the explanation of these phenomena as still to seek for, it would seem that mine did not appear satisfactory to him. It is impossible for me to divine what fault he finds with it; and I mention the subject here in order to be informed of this particular, and to draw the attention of philosophers to it. What embarrasses me most is, that my explanation is founded on the very same principles which the author announces would have been his own. Though this subject be known and explained in works within the reach of every man of science, I trust I shall be excused for dwelling upon it a little here.

The phenomenon is this. Two masses of air of unequal temperatures being separated from each other by a plate of glass, if we apply a leaf of metal on one of the faces of the glass plate, the face opposite to this leaf attracts or repels humidity according as the metallic leaf is on the hot or the cold side respectively. The explanation consists in conceiving the naked side of the glass thus covered as a vessel (*un poële*) destined to be dried, and the metal as a screen. If the screen is put upon the hot side, the vessel cools, and humidity accumulates on the naked glass on the cold side. If the screen is on the cold side, it prevents the heat from being dissipated after traversing the glass, and consequently the vessel becomes hot, and the humidity disappears from the naked glass on the hot side. I found this explanation on the property which metal has of reflecting seven or eight times more caloric than glass. (*Du Calorique Rayonnant*, §§ 195, et suiv.) If any attention be paid to this subject, it will be seen that the principles of this explanation differ in nothing from those of Dr. Wells. But no doubt he employs them in a different way from me; and I am really impatient to know in what this difference consists.

V. I have nothing further to say on the principal object of this memoir, which was to reduce to very simple principles the answer to some objections against the equilibrium of heat. But I shall take an opportunity of making a remark on a set of experiments connected with this theory, published by M. Ruhland in the *Jour. de Phys.* for Nov. 1813. A part of these experiments proves directly



the equilibrium of heat in a state of uniform temperature, as the author himself has observed. In fact, these experiments show us the evaporation of camphor by the radiation of different bodies proportional to the greater or smaller disposition of these bodies to radiate, even when the temperature is uniform; or, in other terms, even when the equilibrium of caloric exists. Hence it follows that radiation exists even in this state of equilibrium. This direct experiment seems to confirm in a satisfactory manner the numerous arguments in favour of the theory of the equilibrium of heat.

The memoir of M. Rubland contains several other interesting facts, which appear to me to flow directly from the general laws of heat. For example, lamp-black, which is known to be one of the most powerful radiators of heat, sublimes or evaporates camphor very rapidly. But if a metallic plate is placed over the lamp-black, the evaporation is immediately retarded. The caloric of the inferior strata is intercepted by this screen, or by this change of medium.

I do not choose to enter into further details on this subject, which is beyond the particular point of theory that I was anxious to illustrate.

## ARTICLE IX.

### ANALYSES OF BOOKS.

*Hints for establishing an Office in Newcastle for collecting and recording authentic Information relative to the State of the Collieries in its Neighbourhood, and the Progress that has been made towards ascertaining the Nature and Constitution of the Strata below those Seams to which the Workings in this Country have been confined.* By Wm. Thomas, Esq. *To which are added Observations on the Necessity of adopting legislative Measures to diminish the probability of the recurrence of fatal Accidents in Collieries, and to prolong the Duration of the Coal Mines of the United Kingdoms.* By Wm. Chapman, Esq. Civil Engineer. *Being two Essays read at a Meeting of the Literary and Philosophical Society of Newcastle-upon-Tyne, and published by order of the Society.* 1815.

THIS pamphlet contains a proposal to establish a Society in Newcastle-upon-Tyne, by whom all the facts respecting the collieries on the Tyne and Wear are to be collected and registered. When a colliery is abandoned, an exact plan of it is to be constructed, exhibiting those parts in which the coals have been wrought out, and those in which they have been abandoned. The consequence of this plan would be that by degrees a complete knowledge of all the underground workings would be acquired. It is obvious that all the abandoned collieries must be filled with water, and that unless an exact knowledge of them is obtained, it must become more and more difficult every year to sink new pits. Indeed the time must

come when the mining for coals must be abandoned altogether, for want of such knowledge. Mr. Chapman gives examples of great expense already incurred in vain, merely from not knowing what part of the coal-bed had been wrought out. But when the whole *high main* shall have been exhausted, it will be necessary to have recourse to the low main. Now this will be hardly possible without an exact knowledge of the workings of the high main. Here and there considerable bodies of coal are left for the safety of the miners and the good of the mine. Through these bodies it would be possible to penetrate to the low main without the risk of being inundated by water; but this cannot be done unless the exact position of these bodies of coal be known.

Mr. Chapman has shown that such a plan, though absolutely necessary for the good of the country, can never be executed without the interference of the Legislature. Indeed this is sufficiently obvious. The proprietors of the collieries, from mistaken views of self interest, are anxious to conceal every fact which they observe from the public. Hence it is quite obvious that they will never of their own accord form such a society as is described in the pamphlet before us; and that if such a society be formed by others, they will communicate no information to it unless compelled by an Act of Parliament. As to the coal viewers, they appear to be averse to all publicity and all changes in the present mode of working the collieries. This I conclude from a fact which I certainly should not have believed *a priori*. Though several hundred colliers lose their lives every year by explosions of carbureted hydrogen, and though they have been expressing a great anxiety to discover a mode of destroying this gas, not one of them has ever thought of trying the lamp of Dr. Reid Clanny, of Sunderland, though a model of it has been within their inspection for several years, and though there cannot be the least doubt that it would effectually prevent all such accidents. They may perhaps allege that it is more expensive than the present mode of lighting the mines. I should like to know at what they estimate the lives of 300 or 400 men; or what additional expense to the country it is to support the widows and children of so many workmen that have perished in their service, because they did not choose to increase the expense of lighting their mines. But setting this aside, if we consider the damage often done by these explosions, and the money requisite to put the mine in order again, I am not sure if the difference of expense would not be in favour of Dr. Clanny's lamp. Besides, nothing would be more easy than to substitute coal gas for oil; and a small steam-engine might easily be made to supply all the lamps with the requisite quantity of air. Such a substitution would make the lamps cheaper than the present mode of lighting the mines; and it would have the unspeakable advantage of preventing all deaths from the explosion of carbureted hydrogen gas. What excuse or apology can the proprietors of the mines and the coal-viewers make for never having made a single attempt to improve the present wretched and absurd mode of light-

ing their mines after other and better methods have been suggested to them? One would be tempted to suppose them entirely regardless of the lives of their workmen.

The Literary and Philosophical Society of Newcastle-upon-Tyne should apply to the county members of Northumberland and Durham, and to the different members for boroughs within these counties, to lay the case before the House of Commons, and represent the necessity of legislative interference in order to preserve to the country the great benefits arising from the collieries on the Tyne and Wear. There can be no doubt that an Act of Parliament would be readily procured, establishing an institution similar to that proposed in the pamphlet before us. It would be better that no fees were exacted for liberty of inspecting the plans, or at least they should be trifling; for such things are extremely liable to be abused, and to destroy the object in view.

In all parts of Europe, where mining has been carried to a great degree of perfection, it has been under the inspection and controul of Government. That coal-mines should be in this predicament, and that exact plans should be preserved of all the excavations, and of all the coals left, is too obvious to require any illustration.

## ARTICLE X.

### *Proceedings of Philosophical Societies.*

#### ROYAL INSTITUTE OF FRANCE.

*Account of the Labours of the Class of Mathematical and Physical Sciences of the Royal Institute of France during the Year 1814.*

I. *Physical Department.* By M. le Chevalier Cuvier, Perpetual Secretary.

(Continued from p. 229.)

M. Risso, author of the *Ichthyology of Nice*, has sent to the Class a supplement to that work, in which he describes several fishes that he was not acquainted with when he published his work. Some of these are very interesting, by the peculiarities of their character.

M. Lamouroux has extended and completed his great work on the polypi history, of which we have spoken two years ago, and it is to be hoped that he will soon publish it.

M. Magendie's fine experiments on vomiting will be recollected, and the invitation by the Class to examine the part which the œsophagus may have in this disorderly movement of the stomach. Though these researches have not yet led to a decisive result, they appeared to him sufficiently interesting to be communicated.

The alternate contractions and relaxations of the œsophagus

appear to him to take place only in the lowest third of it, where it is chiefly excited by the nerves of the eighth pair. The contraction increases much, and continues a long time, when the stomach is full. When the œsophagus is cut and detached from the diaphragm, the injection of tartar emetic into the veins does not produce vomiting : its introduction into the stomach becomes necessary.

M. Delpech, Professor of Surgery at Montpellier, has sent a memoir to the Class on the hospital sore, a kind of gangrene which affects the sores when the wounded patients are too numerous. He has ascertained that this dreadful malady, of which few practitioners have spoken, is produced by a local contagion. It is propagated by the linen, the charpee, and the instruments. Its progress is slower when the patients can be exposed to a current of air. The most minute attention to cleanliness is necessary to prevent it from spreading. But the only true remedy, according to M. Delpech, is the application of the actual cautery to the parts affected with it.

Some years ago M. Maunoir, surgeon in Geneva, sent a memoir on the advantages of the method of amputation invented in England, and which consists in cutting the skin lower down than the bone and the muscles, so as to preserve a sufficient quantity to cover the stump, by bringing it immediately in contact.

M. Roux, surgeon at Paris, has presented a memoir on the same subject, in which he has shown from his own experiments that this method diminishes the sufferings of the patient, that it prevents hæmorrhages and suppuration, that it greatly accelerates the cure of the sore, and that it leaves the stump in a more convenient state, and subject to fewer accidents. He points out the precautions necessary to avoid some inconveniences ascribed to it by those who performed it ill, and particularly to afford the blood and pus, if any be formed, a sufficient passage. M. Percy, our associate, who employed it since his youth, and who, as he informs us himself, has had the melancholy advantage of amputating more limbs than perhaps any surgeon that ever existed, expresses strongly in his report his wish that the memoir of M. Roux may soon render so useful a process general.

Two young surgeons of Paris, MM. Lisfrand and Champenne, have made known their method of amputating the arm at its upper joint, one of the most difficult operations in the surgical art. By making the instrument penetrate under the two eminences of the *omoplate*, called acromion and coracoid process, they reach directly the capsule of the joint, and terminate the operation more quickly than by any of the methods employed before them.

M. de Saissy, surgeon at Lyons, has cured several deaf people by injections into the cavity of the tympanum, through the tube of Eustachius. He has sent to the Class an account of his method, and the history of the cures which he has performed.

The treatise on poisons by M. Orfila, of which we announced the first volume in our last year's report, has been continued, and the second volume submitted to the Class in manuscript. It treats of

the deleterious effects of preparations of tin, zinc, silver, gold, of the concentrated mineral acids; the caustic alkalies, phosphorus, cantharides, lead, and iodine; together with an appendix on the antidotes of corrosive sublimate and arsenic. The author explains with care, and from new and exact experiments, the physiological effects of these substances, whether swallowed, or injected into the veins.

Milk, according to M. Orfila, is the antidote to muriate of tin; common salt, to nitrate of silver or lunar caustic; calcined magnesia, to the acids, provided it be administered very quickly; the sulphates of soda and magnesia, when taken in great quantity and repeatedly, stop the effects of the salts of lead and barytes; and acetic acid is the remedy against the action of the alkalies.

M. Orfila shows that charcoal, which had been recommended against corrosive sublimate and arsenic, has no effect. It is of great importance to know the inefficacy of a remedy against evils so rapid that there is no time to bestow upon them any thing useless.

M. Huzard has carefully informed the Class of the progress and termination of that terrible disease which has destroyed most of the horned cattle in those provinces into which the war brought its ravages. It is a bilious and putrid fever, very contagious, which, though it does not exist in Hungary, is always produced when the cattle of that country are carried to a distance in the train of armies. The total interruption of communication was the only efficacious preservative; but no remedy was capable of saving the individuals attacked. Fortunately their flesh was not unhealthy, which diminished a little the ruin of their proprietors.

The same member has read a notice on a disease which had broken out among the cattle in the village of Rosny, and which different circumstances led the people to consider as hydrophobia. He ascertained that it was only a gangrenous quincy.

M. le Marquis de Cubieres, correspondent, has composed a work, the manuscript of which he has submitted to the Class. It treats of the culture of those gardens which we call improperly English gardens, though the celebrated comic actor Dufresny passes for having presented the first model of them to France towards the end of the seventeenth century. The author collects all the aids of botany and natural philosophy to an art, which has long amused his leisure hours, and explains them in the elegant style naturally inspired by his subject, and suitable to those to whom chiefly he destines his book.

M. Tollard, farmer and merchant at Paris, has proposed some compositions of artificial meadows, formed of certain plants which he associates in consequence of the habit that they have of growing together, and with a view to the different soils, and to the qualities which these plants communicate to the hay. These groupes require to be tried for some years before they can be recommended for practice.

The same author has presented a history of the useful vegetables,

which have been introduced within these ten years into French agriculture; and a particular memoir on the *dahlia*, a plant newly spread over our gardens. Its flower constitutes a fine ornament, and its roots are larger, and almost as good for food as those of the potatoe.

Among the buds of trees there are some which do not spread out with the others, and which are called *dead eyes*, but which should rather be called *sleeping eyes*; for they may be brought out of that lethargy even after it has continued for several years. It is generally owing to the tendency of the sap to go to the superior buds, and to elongate them into great branches. The lower buds by this means are deprived of the nourishing fluid. This is no inconvenience in the trees destined merely to produce wood or to furnish shade. But in fruit-trees in which we wish to dispose of the branches in a certain order, we are sometimes obliged to put grafts in the places which the *dead eyes* occupy, a method both tedious and uncertain. M. Marion de la Martiniere has practised a simpler and more successful method. It is to make a small cut above the *dead eye* in form of a V reversed, and as deep as the alburnum. By thus stopping the progress of the ascending sap, it is obliged to develope the bud, or to produce others.

We may likewise reckon among the labours of the Class in agriculture the memoirs on the Spanish sheep called merinos, by MM. Tessier and Yvard; the description of the practical school of agriculture, by M. Thouin; and the essay of a rural code, by M. de la Bergerie, correspondent. But as these books have been published for several months, it is only necessary to mention their titles.

A contrary reason induces us to make some observations on a considerable work which M. de Lasteyrie du Saillant has presented to the Class, on all the branches of agriculture, and of the rural and domestic economy of the Chinese. It is collected from all the authors who have written on China, and embellished by a great number of figures drawn in China, and by Chinese, in which are represented all the proceedings of their industry, and all the instruments which they employ. This great empire, in which an immense population is entirely supported by agriculture, and in which this art has been uninterruptedly honoured and protected since the first establishment of the monarchy, cannot but have made great progress in it: and in fact M. de Lasteyrie makes us acquainted with different instruments, more simple and commodious than those which we employ for the same purposes, and points out to us processes which might be advantageously followed here, principally in the culture of fruit-trees. We might even imitate the Chinese in their dyeing processes. Thus they prepare a blue with some species of *renouées*, very common here; which, if adopted by us, might diminish the consumption of indigo.

M. Yvard, become lately an associate, had presented while a correspondent a large treatise on the plants injurious to corn, and on the method of keeping cultivated land free from them. What



are usually called weeds, are children of nature, wild plants whose territory is daily invaded by cultivated plants, but which endeavour by all the means in their power to maintain their ground. They soon recover their soil if man neglect them. The wind, water, and animals, transport their seeds; the earth conceals them for a long time, and they vegetate when the favourable moment comes. The imprudent farmer often sows them himself in the manure which he lays on the fields. M. Yvard, who mentions more than 300 species, describes all the care and all the stratagems which must be employed in the kind of war which the farmer must carry on against them, and he treats his subject from actual experience.

This skilful farmer has done a still greater favour to agriculture by publishing last spring, through the medium of the journals, the methods which his experience has suggested as the most proper to repair the losses occasioned by the events of war among the corn and the grass. He has had the happiness to see his counsels fructify. It could not be perceived by the price of corn that our finest provinces have been the fields of battle. It is by such applications of agriculture and art, perfected by the spirit of the sciences, that France has for twenty years contended with the disasters always renewed of a cruel war, and that she has been able to bear without sinking the painful operation on which depended the end of her ills.

(To be continued.)

## ARTICLE XI.

SCIENTIFIC INTELLIGENCE; AND NOTICES OF SUBJECTS  
CONNECTED WITH SCIENCE.

### I. Lectures.

A Course of Lectures on the Elements of Electrical Science, comprehending Galvanism and Electro-Chemistry, will be commenced by Mr. Singer, on Monday, Nov. 6, at No. 3, Princes-street, Cavendish-square.

### II. Largest Diamond.

The largest diamond hitherto found is in the possession of the Rajah of Mattan, in the Island of Borneo, in which island it was found about 80 years ago. It is shaped like an egg, with an indented hollow near the smaller end. It is said to be of the finest water. It weighs 367 carats. Now as 156 carats are equal to 1 oz. Troy, it is obvious that this diamond weighs 2 oz. 169.87 gr. Troy. Many years ago the Governor of Batavia tried to purchase this diamond. He sent a Mr. Stuvart to the Rajah, who offered 150,000 dollars, two large war brigs with their guns and ammunition, together with a certain number of great guns, and a quantity of powder



and shot. The Rajah, however, refused to deprive his family of so valuable an hereditary possession, to which the Malays attach the miraculous power of curing all kinds of diseases, by means of the water in which it is dipped, and with which they imagine that the fortune of the family is connected.—See Dr. Leyden's account of Borneo, in the seventh volume of the *Transactions of the Batavian Society*.

### III. *Voyage of Discovery to Africa.*

The gentlemen appointed by Government to prosecute the discoveries of the late unfortunate Mungo Park have at last sailed from England for the coast of Africa. They are Major John Peddie, Capt. T. Campbell, and Mr. Cowdery, staff surgeon. They are said to be very well qualified for the task which they have undertaken. They are to be attended by a company of Negroes. The object of the expedition is to trace the Niger from the place at which Mungo Park left it to the sea, and to determine whether or not it be the same with the Zayr.

### IV. *Death of Gëhlen.*

Adolph Ferdinand Gëhlen, whose name has occurred repeatedly in the *Annals*, died at Munich last summer; or perhaps it would be more proper to say that he destroyed himself, since he persisted in a set of experiments in which he was daily exposed to the fumes of arsenic, though warned by his friends of the fatal consequences that would ensue. He became first generally known to the chemical world in 1803 by the publication of a new monthly chemical work, which he entitled, *Neues Allgemeines Journal der Chemie* (New Universal Journal of Chemistry). Of this journal he published six volumes, which contain a great deal of valuable and original matter. In 1806 he changed the title to *Journal für die Chemie und Physik* (Journal of Chemistry and Natural Philosophy). About this time he was chosen a Fellow of the Academy of Sciences of Munich, to which capital he repaired. Yet he still continued to publish his journal at Berlin. But it was infinitely inferior to what it had been, consisting chiefly of translations from foreign journals, and of long papers by Ritter, often highly absurd and ridiculous. He continued it, however, till 1810, when he stopped: no doubt because the sale had diminished so much as not to be equivalent to the expenses of the publication. His principal discovery was the mode of precipitating red oxide of iron by succinate of soda or of ammonia. This discovery has been of considerable use in the chemical analysis of minerals.

### V. *Confirmation of Mr. Rose's Discovery of the Absence of Urea from the Urine in Hepatitis: being an Extract of a Letter from Dr. Henry, of Manchester.*

Soon after the publication of Mr. Rose's paper, in your number for June, a medical friend (Dr. Holme) gave me a specimen of the

urine of one of his patients, a female labouring under chronic hepatitis. He had been struck with the absence of most of the usual qualities of that fluid, such as colour and smell, of both which it was nearly destitute. I found its specific gravity to be only 1.0033 (the average of healthy urine being 1.0200); and its solid contents, not perfectly dried, did not exceed 25 grs. from the wine pint. Finding that no precipitate was occasioned by adding nitric acid to the extract dissolved in a little water, I tried to discover urea in another portion of the same urine by the more accurate test, which I have proposed, of distillation. The distilled fluid very slowly restored the colour of reddening litmus paper, but did not precipitate muriate of lime. It could, therefore, have contained nothing more than a mere trace of carbonate of ammonia, which is always abundantly produced by the distillation of natural urine. As the patient recovered, the urea was very gradually and slowly restored to the urine. These experiments confirm the curious discovery of Mr. Rose; to which it may be added, that the urine of Dr. Holme's patient did not contain an appreciable quantity of uric acid. I was sorry that other engagements interfered at the time, and prevented me from determining exactly the nature of its other contents.

An opportunity lately occurred to me of ascertaining precisely the proportion of urea in the urine of a patient labouring under diabetes mellitus in its most perfect form, before the disease was influenced either by diet or medicines. A wine pint gave 651 grains of solid extract; and of this only 16 grs., or  $\frac{1}{41}$  part, were urea. No urea could be discovered by the action of nitric acid. The processes employed in detecting it were those which I have described in the *Medico-Chirurgical Transactions*, ii. 123; and in your *Annals of Philosophy*, i. 31.

P. S. I have often been applied to of late to know where the hydrometer for taking the specific gravity of urine may be purchased. It may be acceptable, therefore, to some of your readers, to know that a more easy method (and a preferable one, as it requires a much less quantity of urine, and no calculation) is to weigh the urine in a bottle which holds exactly 1000 grs. of distilled water at 60° Fahr. up to a mark on the neck. Bottles of this sort, with a proper counterpoise, and decimal weights in a case, may be had in London of Mr. Knight, 41, Foster-lane, Cheapside; and, I dare say, of Mr. Accum, in Compton-street, and other makers of chemical apparatus.

#### VI. *Atmospheric Phenomenon.*

About a quarter before ten o'clock on Tuesday evening, Sept. 26, Fomalhaut being a little to the east of the meridian, the barometer being 29.62, and the thermometer 62°, a luminous band appeared near the western horizon, and extended itself gradually towards the east, until it occupied a line beginning at the sixth of the Eagle, passing through the Fox and Goose, between the fifth and sixth of the Swan, across Almaac, in Andromeda, and Medusa's Head, and

terminating a little to the north of the Pleiades. It was very bright, and well defined near its western extremity; broader, fainter, and of shorter duration, towards the east. Its medium breadth was about five degrees, and it continued about 20 minutes.

The afternoon of Tuesday was very wet, with violent gusts of wind; for some time before this luminous appearance the sky was nearly covered with large dark *Cumulous* clouds, which passed away rapidly towards the N. E. and occasionally shot forth faint coruscations. The barometer and thermometer had been very variable for some days.

At eleven *p. m.* the sky was very bright near the northern horizon for about a quarter of an hour, but no *Aurora Borealis* appeared.

No opportunity of observing the magnetic variation occurred at the time.

### VII. *Queries respecting Fluxions.*

(To Dr. Thomson.)

SIR,

As your correspondent Mr. Christison recommends the study of fluxions after the pupil has become acquainted with the second book of Euclid, he would render me an essential service if he would have the goodness to mention what work of this kind he thinks is best adapted to those who are already acquainted with the first six books of the Elements. Maclaurin's is the only one I have seen, but this appears too tedious and abstruse for a beginner, otherwise it appears to have great commendation, from the geometrical manner in which he introduces the subject. Should you, Sir, be so obliging as to notice this application, you will confer a favour on

Your most obedient servant,

Sept. 21, 1815.

A SUBSCRIBER TO THE ANNALS.

### VIII. *Connaissance des Temps, 1815.*

(To Dr. Thomson.)

SIR,

I have felt some disappointment at finding that, in the last number of our Nautical Almanac, the phenomena and observations (occultations, &c.) have been almost entirely omitted. What is the cause of this serious omission? In the number for this year there are about 57 set down, in the column alluded to, for the twelve months; but in the *Con. des Temps* for this year, published in Nov. 1812, there are 218. Surely our ephemeris is not to become less valuable and interesting than that of the French in any respect. I have not great confidence in the accuracy of French printing, or I should prefer theirs. "Les occultations d'étoiles par la lune étant les phénomènes les plus utiles pour déterminer avec précision les longitudes géographiques, les voyageurs ne doivent pas négliger de les observer; les conjonctions qu'on indique ici serviront à les guider pour prévoir les occultations qui pourront avoir lieu dans les

pays où ils se trouveront. On peut encore faire usage du *Zodiaque*, publié par Lemonnier (à Paris chez Dezauche): en y suivant la route de la lune, au moyen de ses longitudes et latitudes, et ayant égard à l'effet de la parallaxe, on trouvera à très-peu près le tems des occultations qui pourront avoir lieu." P. 207.—Is any such zodiac published in England? On p. 206, they mention a parallaxic machine for giving the point or place of *emersion*. Where shall I find a description of it? On p. 7, it is erroneously set down that there will be a total eclipse of the moon on the 26th of December, *visible* at Paris; and no notice is taken of an eclipse of the sun, Jan. 10; another, Dec. 30; nor of one of the moon, Dec. 15; all invisible here. On p. 5, the Julian period is stated as 6530; in the English ephemeris, at 6528: and the apparent obliquity of the ecliptic, Oct. 1, according to Delambre's new tables, =  $23^{\circ} 27' 43.3''$ : the seconds in the English are  $49.3''$ ! In a meteorological journal for 1810, given at p. 214, the magnetic needle was  $22^{\circ} 16'$  on the 13th March, at the imperial observatory of Paris. This number contains copious tables of the longitudes and latitudes of places, and of the R. A. and declinations of stars.

I am, Sir, your obliged servant,

A. M.

### IX. *Weather in Iceland during 1814.*

(To Dr. Thomson.)

SIR,

As it may not perhaps be uninteresting to some of your readers to know the general state of the weather in Iceland during the past year, I beg leave to subjoin an extract of a letter on that subject, which I lately received from Mr. Magnus Stephenson, Chief Justice in that island, dated Rechiavig, July 26, 1815.

I am, Sir, respectfully, your most obedient servant,

Liverpool, Aug. 16, 1815.

D. G.

“ A remarkably fine summer (1814) was succeeded by a very stormy autumn, attended with much rain and raw weather. From the beginning of October to the end of December followed much snow and sharp frost, the stormy state of the weather still continuing. From thence to the middle of March succeeded very fine mild weather, *without frost*; yet often so windy that the fishing could not begin during all that period. Afterwards the weather became calm and agreeable, which continued; and we have scarcely had any frost in 1815 here in the south and the eastern parts of the island; but in the northern part, the winter being milder from September to January, afterwards changed to very stormy, with snow. It continued thus until far in the spring; the consequence of which has been a great loss of sheep in the north country, where the grass came late, and was very scarce every where; besides which it was in some parishes eaten quite away by a caterpillar last spring, which was exceedingly cold, although no drift ice has appeared this year on the northern coast.”

## X. Population of the Canaries.

Islands.	Surface in nautical square leagues.	Absolute Population.				Number of inhabitants to each square league in 1790.
		1678.	1745.	1768.	1790.	
Teneriffe .....	73	49,112	60,218	66,354	70,000	958
Fertaventura .....	63	—	7,382	8,863	9,000	142
Grand Canary .....	60	20,458	33,864	41,082	50,000	838
Palma .....	27	13,892	17,580	19,195	22,600	837
Lanzerota .....	26	—	7,210	9,705	10,000	384
Gomera .....	14	4,373	6,251	6,645	7,400	528
Ferro .....	7	3,297	3,687	4,022	5,000	714
Total .....	270		136,192	155,866	174,000	644

Humboldt's Personal Narrative, i. 284.

## XI. Temperature of the Atlantic.

The following table is given by Humboldt from observations made by him of the temperature of the Atlantic Ocean during his voyage to South America:—

North Latitude.	Longitude.	Temperature of the Surface of the Sea.
39° 10' .....	18° 38' .....	59°
34 30 .....	19 15 .....	61·34
32 16 .....	19 24 .....	63·86
30 36 .....	19 14 .....	65·48
29 18 .....	19 00 .....	66·74
26 51 .....	21 33 .....	68·00
20 8 .....	31 11 .....	70·16
17 57 .....	35 34 .....	72·32
14 57 .....	47 00 .....	74·66
13 51 .....	52 3 .....	76·46
10 46 .....	63 14 .....	78·44

Humboldt's Personal Narrative, ii. 59.

XII. *Fucus Vesiculosus*.

Professor John, in order to obtain iodine, burnt four ounces of the fucus vesiculosus: the white ash remaining weighed  $4\frac{1}{2}$  drams. He found in it manganese and magnesia, but did not succeed in obtaining from it any iodine. This was chiefly owing to the small quantity of ash on which the experiment was made, and partly also to the imperfect method which he followed; for he seems to have been in possession of no other directions except those contained in Davy's first paper on iodine, and they are quite inaccurate.

XIII. *Animal Concretion.*

Professor John has lately examined a concretion from the uterus of a woman. From the description which he has given of it, there is reason to consider it as precisely similar to a concretion from the vagina, which I described and analyzed in a preceding volume of the *Annals of Philosophy*. Accordingly Dr. John found its composition quite analogous. It was composed of phosphate of lime and an animal membranous matter. He detected in it, likewise, traces of carbonate of lime and of muriatic acid.

XIV. *Saliva.*

I have lately had an opportunity of making some experiments on saliva, thrown out of the system during a mercurial salivation. The following is the result. Saliva, when first emitted, is an opal liquid, which speedily lets fall a white matter, and then becomes transparent. The white matter thus deposited possesses the characters of coagulated albumen. As mercury is known to act very powerfully as a precipitant of albumen, I thought it possible that in the present case it might have been thrown down by the mercury with which the system was known to be loaded. But I did not succeed in detecting the presence of any of that metal. The specific gravity of the saliva at 60° was 1·0038. It was a ropy liquid, and could be drawn out into fine threads; yet it could not be employed to paste together pieces of paper, not having the property of a cement. This liquid was not altered by prussiate of potash nor infusion of nutgalls. With nitrate of lead it deposited a copious white coagulum. It precipitated likewise with nitrate of mercury. 1050 grs. of it, being evaporated to dryness, left a residue of 7·5 grs. This residue was composed of

Coagulated albumen .....	2·70
Mucus (with a little albumen) .....	3·85
Common salt .....	0·95
	7·50

## ARTICLE XII.

*New Patents.*

JOHN TAYLOR, Stratford, Essex, manufacturing chemist; for certain methods of purifying or refining sugar. June 22, 1815.

CHARLES SYLVESTER, Derby, engineer; for various improvements in the texture of bobbin lace. June 22, 1815.

ROBERT BAINES, Myton, Kingston-upon-Hull, glue manufacturer; for his improvements in the construction of vertical windmill sails. June 22, 1815.

**ROBERT DICKINSON**, Great Queen-street, London, Esq. ; for means for facilitating the propulsion, and for the safety of boats and other vessels through the water. June 22, 1815.

**SAMUEL BALDEN**, Reddich, Worcester, miller; and **JOHN BURTONSHAW**, Blackfriars Road, London, oven builder; for a machine or instrument for the better heating ovens. June 24, 1815.

**WILLIAM MADELEY**, in the parish of Yardley, Worcestershire, farmer; for an improved drilling machine, for drilling beans, turnips, peas, pulse, corn, and seeds of every description. July 27, 1815.

**JOHN LEWIS**, of Brimscomb, Gloucestershire, clothier; for an improved shearing machine. July 27, 1815.

**DAVID MUSHET**, of Coleford, Gloucestershire, iron-master; for an improvement or improvements in the process or processes of making or manufacturing iron. July 27, 1815.

**WILLIAM EDRIDGE**, of Rotherhithe, Surrey, brass-founder; for an engine, pump, or fire-engine. Aug. 4, 1815.

**JOSEPH HARVEY**, of Long-lane, Bermondsey, Surrey, turner; for a machine for better striking and finishing of leather. Aug. 4, 1815.

**RICHARD DIXON**, of High Holborn, Middlesex, trunk-maker; for an improvement or improvements in the construction of trunks or portmanteaus of various descriptions, and in the application of materials hitherto unused in the construction thereof. Aug. 11, 1815.

**JOHN STREET**, of Clifton, Gloucestershire, Esq. ; for certain further improvements in the mode of making and working bellows. Aug. 11, 1815.

**JOHN EDWARDS**, of Canterbury-buildings, Lambeth, Surrey, Gentleman; for a method or means of preventing leakage in ships, boats, and other vessels. Aug. 15, 1815.

**JOHN CHESHOLMS**, of Edinburgh; for a method of constructing register and other stoves. Aug. 21, 1815.

**STEPHEN PRICE**, of Stroud, Gloucestershire, engineer; for a machine for shearing or cropping woollen and other cloths that may require such a process. Aug. 21, 1815.

**THOMAS FIELD SAVORY**, of New Bond-street, Middlesex, chemist; for a combined neutral salt or powder, which possesses all the properties of the medicinal spring at Sedletz, in Germany; and which invention is sold under the name of Sedletz powder. Aug. 23, 1815.

**JAMES CARPENTER**, of Wellenhall, Staffordshire, curry-comb-maker; for an improvement to a curry-comb. Aug. 23, 1815.

**WILLIAM BEMMAN**, of Eldersfield, Worcestershire, tanner; for various improvements in ploughs. Aug. 23, 1815.

**THOMAS ASHMORE**, now resident at Portland Hotel, Portland-street, Middlesex; for a new mode of making leather. Sept. 9, 1815.



## ARTICLE XIII.

## METEOROLOGICAL TABLE.

1815.	Wind.	BAROMETER.			THERMOMETER.			Hygr. at 9 a. m.	Rain.
		Max.	Min.	Med.	Max.	Min.	Med.		
9th Mo.									
Sept. 26	S	29.79	29.63	29.710	66	42	54.0	72	.23 C
27	S W	30.06	29.79	29.925	61	34	47.5	80	.13
28	S E	30.06	29.46	29.760	59	42	50.5	81	—
29	W	29.51	29.28	29.395	65	44	54.5	60	.34
30	S W	29.49	29.45	29.470	58	45	51.5	71	.17
10th Mo.									
Oct. 1	S W	29.72	29.49	29.605	62	39	50.5	77	.13
2	N W	30.11	29.72	29.915	60	33	46.5	83	—
3	S	30.11	29.93	30.020	61	43	52.0	65	—
4	S	29.97	29.95	29.860	62	37	49.5	80	—
5	S	29.95	29.31	29.880	66	50	58.0	90	—
6	N	30.08	29.81	29.945	63	34	48.5	79	.50
7	N W	30.20	30.08	30.140	59	37	48.0	85	—
8	N E	30.22	30.19	30.205	56	39	47.5	80	—
9	E	30.19	30.02	30.105	57	39	48.0	63	—
10	E	30.02	29.72	29.870	55	39	47.0	56	—
11	E	29.72	29.62	29.670	55	45	50.0	75	.54 D
12	N W	29.73	29.62	29.675	57	37	47.0	70	—
13	Var.	29.73	29.65	29.690	62	51	56.5	60	—
14	S W	29.76	29.65	29.705	60	42	51.0	73	—
15	S W	29.82	29.79	29.805	60	47	53.5	75	.5
16	S	29.73	29.71	29.720	62	46	54.0	73	—
17	S W	29.85	29.73	29.790	59	35	47.0	77	—
18	S E	29.85	29.52	29.685	56	46	51.0	83	.18 O
19	S W	29.52	29.25	29.385	63	49	56.0	60	.16
20	S W	29.45	29.25	29.350	61	45	53.0	70	—
21	S W	29.82	29.45	29.635	59	33	46.0	77	—
22	S	29.85	29.57	29.710	57	42	49.5	65	—
23	S	29.57	29.47	29.520	59	50	54.5	89	.39
24	S W	29.47	29.42	29.445	59	42	50.5	80	.10
		30.22	29.25	29.747	66	33	50.79	74	2.92

The observations in each line of the table apply to a period of twenty-four hours, beginning at 9 A. M. on the day indicated in the first column. A dash denotes, that the result is included in the next following observation.

## REMARKS.

*Ninth Month.*—26. A rainy sound in the trees this morning, from a gale at S. : this was followed by rain, during which the wind veered westward. 27. a.m. Damp, somewhat misty air: *Cirrus*, with *Cirrostratus*: much wind and a heavy shower by noon, with a suspicious sound, like thunder, at a distance: p. m. a second shower, after which a fine bow in the E., and some distinct *Nimbi*, the elevated crowns of which continued to reflect the light for 30 minutes after sun-set. 28. a.m. A wet mist, very little wind, the vane, which stood to N., turning to S. E.: sunshine, with *Cumulus* at noon: large *Cirri*, p. m. which were permanent. 29. a. m. Rainy appearances in the sky, soon followed by a shower, which came over from S.W. : much *Cirrostratus* followed, with more rain. 30. a. m. Clear: wind N.W. : p. m. a veil of *Cirrostratus* advancing from W. completely obscured the sky: in the night a beating rain from the southward.

*Tenth Month.*—1. a. m. As yesterday: showers, with rainbow, p. m. : rain by night. 2. Misty morning: much dew: *Cumulostratus*, and a few drops: luminous twilight. 3. Hoar frost: misty air: *Cumulus*, capped with a delicate double sheet of *Cirrostratus*: *Cirrocumulus* and inosculation followed. 4. *Cirrostratus* in a close veil most of the day. 5. Misty morning: then large *Cirri*, arranged from S. E. to N. W., and passing to *Cirrocumulus*, &c. : rain at night. 6. Wet morning: fair, p. m. 7. Hoar frost: slight *Stratus*: a serene day: much dewy haze at sun-set, coloured red, first in the E., then in the W. above an orange tint. 8. Cloudy, a. m. 14. A lunar halo of moderate diameter, which, disappearing, gave place to a portion of a very large one. 15. Rain: the wind fresh at night from S. S. W. 16. a. m. *Cumulus*: fine day: a number of swallows, which re-appeared at the end of last month, have kept about our neighbourhood to the present time. 17. Large *Cirri*, passing to *Cirrostratus*: a little rain, p. m. : *Nimbi*. 18. a. m. *Cirrostrati*, with obscurity gradually increasing: wet, p. m. : much wind, evening. 19. Coloured sun-rise: calm, overcast, a. m. : then windy, with driving showers, the sky filled with cloud: a tempestuous night. 20. Coloured sun-rise, and much wind: a few drops of rain: cloudy night. 21. a. m. Clear: then *Cumulus* in a very blue sky, passing to *Cumulostratus*, which, with some beds of *Cirrus* above, was finely coloured at sun-set: I suspected thunder and rain far to the S. this afternoon. 22. Misty: much dew: *Cirrostratus*, *Cumulostratus*, *Cirrus*. 23. Maximum of temp. at nine this morning: little dew: cloudy: windy: rain. 24. a. m. Misty sun-rise, with *radii* through broken clouds: a *Nimbus* in S.W. : rain: about sun-set *radii* again, followed by many distinct *Nimbi*.

## RESULTS.

Winds chiefly from the S. and W.

Barometer: Greatest height.....	30·22 inches;
Least .....	29·25 inches;
Mean of the period .....	29·747 inches.
Thermometer: Greatest height .....	66°
Least.....	33°
Mean of the period .....	50·79°
Mean of the hygrometer, 74°.	Rain, 2·92 inches.

# ANNALS

OF

# PHILOSOPHY.

---

DECEMBER, 1815.

---

## ARTICLE I.

*Biographical Account of Charles Bossut.* By M. le Chevalier Delambre, Secretary of the Institute.

CHARLES BOSSUT, Member of the Academy of Sciences, and afterwards of the Institute, of the Academies of Bologna, Lyons, and Utrecht, Examiner of the Pupils of the Military Corps of Engineers, and of the Polytechnic School, and Member of the Legion of Honour, was born at Tartaras, in the department of the Rhone-and-Loire, on the 11th of August, 1730, and was the son of Barthelemi Bossut and Jeanne Thonnerine. His family belonged originally to the country of Liege, from which some misfortunes had obliged them to emigrate about the year 1542. At the age of six months he lost his father. A paternal uncle taught him the principles of grammar and the languages, and made him early acquainted with the Latin and French classics. At the age of 14 he was sent to the College of Jesuits at Lyons to finish his studies. Here he was soon distinguished by his masters, for the ease with which he carried off all the prizes; and by his class-fellows, for his amiable and sensible disposition which interested them in his success. Here he soon acquired a kind of reputation which in a short time extended beyond the limits of the College.

The *Eloges of Fontenelle* having fallen into his hands, raised in him the most violent passion for mathematics. He was eager to follow the footsteps of those great men, whose discoveries inflamed his imagination; and finding nobody at Lyons who could guide his first steps, he ventured to write directly to Fontenelle to request his advice. He received an encouraging answer. "I request of you," said the old man, more than 90 years of age, "to give me from time to

time news of your progress. I have a feeling which informs me that you will go far; but I cannot live long enough to enjoy your success."

Nothing more was necessary to induce Bossut to go to Paris. Fontenelle received him kindly, and recommended him to Clairaut and d'Alembert, who were prodigal in their encouragements. D'Alembert in particular chose him more especially for his pupil, and took a pleasure in removing the difficulties which might have retarded his progress. Time cemented this union, founded on the one hand on the attachment which results from benefits conferred, and on the other from the justest and most lively gratitude. This friendship subsisted, without interruption, till the death of d'Alembert. Bossut had particularly studied the writings of his master; and when any person applied to d'Alembert for explanations of a difficult passage, which would have obliged him to read over again his memoir with attention, he sent him to his disciple and confident, saying to him, "Call upon Bossut."

Camus, another academician, Examiner of the Pupils of Artillery and Engineers, conceived for him the same affection, and introduced him to Comte d'Argenson, Minister at War, who named him Professor of Mathematics in the School of Engineers at Mezieres. This was in 1752, when Bossut was scarcely 22 years of age.

About the end of the same year the Academy admitted him into the number of its Correspondents. A memoir of his had been read, entitled, Uses of the Differentiation of Parameters for the Solution of different Problems in the inverse Method of Tangents. In giving an account of this memoir, inserted in the second volume of the *Savans Etrangers*, the historian of the Academy says, that we find in it the solution of divers problems proposed by John Bernoulli, the first of which had not hitherto been resolved by any person. In speaking of the methods of Bossut, he adds, that they appear short and elegant. He gives the same opinion of two other problems, constituting a second memoir published in the same volume.

The Leipzig Acts had in 1752 announced a theorem of Euler on the rectifiable difference of certain elliptic arcs. Bossut, in demonstrating it, joined a simple and direct method for discovering this theorem *a priori*. In the same volume (iii.) he applied to different problems concerning the cycloid, a method which was then judged *so much the more ingenious that it is not confined to problems alone, but may serve likewise on many other occasions.*

The duty of Professor of Mathematics, to which he devoted himself for 16 years, without interruption, and with a success always increasing, at the school of Mezieres, did not prevent him from making himself known by a number of works, the subjects of which were either pointed out to him by his lectures, or by the labours of contemporary mathematicians, or by the prizes of the Academy. Thus he drew up at first his *Elements of Mechanics*,

which he afterwards converted into a complete course of mathematics. He shared with a son and pupil of Daniel Bernoulli a prize proposed by the Academy of Lyons on the Best Form of Ores; with the son of Euler, and probably with Euler himself, a prize on Stowing Goods in Ships, proposed by the Academy of Sciences. "Complete success would have been less brilliant," wrote to him Clairaut, one of the judges, "because in that case it would have been unknown over whom you had triumphed."

He obtained alone the prize of the Academy of Sciences on the question, *whether the planets move through a medium, the resistance of which produces any sensible effect on their motions.* Albert Euler had undertaken an examination of the same subject. The two authors agreed perfectly in every thing regarding the principal planets. But Albert acknowledges that he had not ventured to enter upon the part which regards the moon. He congratulates Bossut upon having overcome difficulties which appeared to him so great as to induce him to abandon the task. It appeared to result from the memoir of Bossut that the acceleration observed in the motion of the moon might be explained by the resistance of the ethereal matter. But one of the great mathematicians of whom France has to boast found afterwards a more natural cause, which explains this acceleration, and the ethereal resistance has become a very problematic cause, the effects of which, if they are not absolutely null, are at least very little sensible.

The same year, 1762, Bossut, in conjunction with Viallet, obtained the quadruple prize proposed by the Academy of Toulouse for the most advantageous construction of dykes. Three years after he divided a double prize proposed by the Academy of Sciences on the Methods of Stowing Ships; and he obtained alone at Toulouse two successive prizes for his researches respecting the laws of motion which fluids follow in conduits of all kinds.

He owed to the friendship of Camus the place of Mezieres, which had enabled him to turn his undivided attention to mathematics. The way in which he had filled his situation and employed his intervals of leisure determined in his favour all the votes when a successor was to be appointed to his protector and friend. The Government named him Examiner of Engineers, and the Academy gave him the place which Camus had left vacant. It was at that time that he gave his method of summing series, the terms of which are similar powers of the sines and cosines of arcs, which form an arithmetical progression.

Euler in his introduction to the Analysis of Infinites had already given the sum of those series, which he referred to recurrent series. Bossut, in order to arrive at the same result, employs only the most elementary formulas of trigonometry, and some rules equally simple of the theory of progressions. This method has the advantage of being more clear, and therefore intelligible to a much greater number of readers. If the glory of a discovery belongs incontestibly to him who first made it known, we cannot refuse a great

deal of esteem to him who renders more popular notions seemingly at first destined to be confined to philosophers.

The same advantage is evident in his method for the reversion of series. This subject has occupied the greatest mathematicians. It was afterwards treated in a more philosophical and more profound way in a fine memoir of Lagrange. But if the method of Bossut has not the same generality, if it is not comprehended in a formula so singularly remarkable, it is distinguished by other advantages. It depends upon the most elementary theorem of differentiation; it requires only ordinary and uniform calculations, though a little long; it fixes itself in the memory, so that it is impossible to forget it; and the calculator who wishes to make use of it carries it always with him, and has no occasion to consult a book on the subject.

Parent had formerly given, in order to estimate the effect of wheels moved by a fall of water, a very simple method, but very inaccurate. Bossut undertook to introduce into the calculation all the considerations neglected by Parent, and by all those who had adopted the rule of this mathematician with too much confidence. The problem in all its generality may be insoluble; but in the application of it we are at liberty to neglect the circumstances which do not occur in any of the machines used, or which can only produce insensible effects. By this means Bossut arrives at a formula which may be adapted to all possible cases, either by varying some terms, or by suppressing them altogether. He obtains in this manner, if not the rigid accuracy which belongs exclusively to pure analysis, that degree at least with which the arts may be satisfied.

These particular memoirs, and various others which we have not room to analyze, are to be found in the *Encyclopedie Methodique*, of which he was one of the editors, or in the *Course of Mathematics* which he composed for the use of the pupils whom he examined, or in his *Treatise of Hydrodynamics*, a more recent work, in which he had introduced his different experiments on the motions of fluids.

“It is only a mathematician,” said on that occasion Condorcet in the *History of the Academy*, “It is only a mathematician well skilled in the theory and practice who can give to experiments the form which they ought to have in order to be compared with the theory. It is only a mathematician who can know either what precision in the theory an experiment may produce, the accuracy of which is known, or with what precision experiments ought to be made in order to be employed in constructing or verifying a theory.”

“Experiments made by a mathematician like Bossut,” continues Condorcet, “ought then to be very precious in the eyes of mathematicians who wish to understand the theory of fluids, and of mechanics who occupy themselves with hydraulics.”

In this first essay Bossut had considered the motion of fluids in general. Four years afterwards Government charged him with a new set of experiments on the resistance of fluids in narrow and shallow canals. He made them the subject of a work published in

1777. Next year he inserted new experiments into the volume of the Academy, the object of which was to discover the law according to which the resistance of an angular prow diminishes in proportion as it becomes more acute.

The Course of Mathematics of Bossut, at the time when the different treatises were composed, were successively published, received much praise for the order, clearness, method, and philosophical spirit, observed in it. The historical prefaces which commence each volume were particularly praised. This book long shared equal popularity with that which Bezout had composed for the artillery and marine. Both of them were of great service to the pupils for whom they were destined. They have of necessity lost a part of their celebrity, since a single establishment has been formed for the instruction of those destined to serve the state in all the corps which had formerly their particular books and examiners. But this popularity continued long enough to reward the author for so many labours, and made him nearly independent at the time when the political storms threw the fortunes of all into confusion. Bossut was then deprived of the chair of hydrodynamics established for him, and which had existed only for a few years. He had been previously deprived (not without murmuring at the injustice of mankind) of that place of Examiner which he had filled with probity, and to the general satisfaction of the pupils of Government. In lieu of these places of Examiner, Professor, and Academician, Bossut obtained only some transitory aid voted by the advice of the Board of Consultation, and a lodging in the Louvre, which he enjoyed only a few years. It was then that he buried himself in that retirement which his age and the state of his income rendered necessary for him. Here he received some consolations. The Institute restored to him a part of what he had enjoyed as a Member of the Academy of Sciences. He was named one of the Examiners of the Polytechnic School, and when after more than 50 years of services age and infirmities obliged him to retire, his salary was continued, which he so well deserved not to lose.

It was in this solitude and absolute separation from society that he wrote his history of the mathematics, of which two editions were sold in less than six years. Two volumes are very little for so vast a subject. Mathematicians accordingly will find the work too incomplete and superficial. But it was not for them that he had written it. We see by the reflections which he made on the History of Montucla that he was sensible of the spirit and manner in which such a work should be composed. But he adds immediately, that his design is not to give that profound history in which all the parts of mathematics should be analyzed, and which may to a certain amount save the trouble of reading the authors themselves, especially those whose methods are antiquated. "He attempts only to give a general sketch of the progress of mathematics from their origin to the present time, to honour the memory of the great men who have extended its empire, and especially to inspire youth with



a taste for these sublime studies." He remembered doubtless what he himself had felt on reading the writings of Fontenelle.

The first edition only bore the modest title of *Essay*. He acknowledged afterwards that he was satisfied with its success. His *Essay* had been translated into different languages. It was well arranged, clear, and well written. He acknowledges at the same time that the second edition, entitled *General History*, was less fortunate, and had been very severely criticised. The cause which he assigns for this difference is, that in the *Essay* he had refrained from speaking of living authors, whereas when he continued his history to our own time he could not but find judges more difficult to satisfy. Without denying absolutely the justice of this remark, we must acknowledge likewise that the reasons which he assigns for certain omissions appear very weak. The most disinterested readers must see that different modern works are not appreciated with a care and details proportional to their importance. The author, who had given an interesting account of the discussions between Newton and Leibnitz, and the more recent disputes of the two protectors of his youth, Clairaut and d'Alembert, was more sparing in speaking of authors whom he had studied with more care, and for whom perhaps he had not the same affection. This restriction is equally apparent in what he says, and in what he suppresses; and this part of the work requires to be done over again. "His great age and his infirmities deprived him of the hope of doing better, or being more happy." But he thinks that "his work is of a nature to be perfected by successors more capable of fulfilling his intentions."

These intentions were to be just and impartial; but he wished that others should be with respect to him what he wished to be with respect to others. He acknowledges in a posthumous manuscript which has been sent us "that he always had a harshness of character, which often injured him with those who only knew him superficially. He did not easily grant his confidence; he believed all mankind in general dissemblers and deceivers; but when he gave himself up to the natural frankness of his soul, he brought into the commerce of life an effusion of true feeling, which procured him a great number of devoted friends, especially in the *Military Corps of Engineers*."

"He abhorred impostors of all kinds," said he, likewise; "he had often the imprudence to make them acquainted with his opinions; but he was always in search of true merit."

"He was obliging; and he complains bitterly of ungrateful persons."

"He was persuaded that men who owed every thing to him had shown the greatest rancour against him, and had given themselves a great deal of trouble to prevent him from obtaining places to which he had never aspired."

It is not surprising that with such opinions, embittered by solitude, and strengthened by the kind of abandonment in which he thought himself placed, after having enjoyed a rank and influence

the diminution of which he exaggerated, he was not very anxious to point out the merit of contemporaries, whom he thought in general unfavourably disposed towards himself. We find the effect of these opinions in a very bad-humoured preface to his *Mathematical Memoirs*, published in 1812. These memoirs are those which had gained prizes, and been published at the time by the Academy of Sciences. He adds to them some notes on his *History of Mathematics*. He there explains or demonstrates theorems which he had too much abridged; but he adds nothing to fill up the blanks which had excited the outcries of which he was so sensible.

We must lament that he was so long the dupe of a cloudy imagination, which rendered the last years of his life unhappy. Before age, infirmities, and the loss of his places, had laid open this disposition to misanthropy, he appeared to us to be filled with benevolence. I shall always recollect with gratitude the notice which he paid as Director of the Academy of Sciences to the first essays which I presented to that body; and yet he knew that I was particularly connected with an astronomer whose friend he was not, and of whom he must have considered me to be the pupil and protégé. I may add that I never found the least change in his disposition towards me, though I ventured to express an opinion opposite to his with regard to some points of ancient astronomy.

We may place his omissions in a more favourable point of view, though we cannot pretend to excuse them entirely. A great work on transcendental mathematics is not read with the same facility as a work of history or literature. To understand its merit, to be able to explain its plan, and to point out the most interesting parts of it, a degree of labour and attention is requisite of which old age is no longer capable. A mathematician possessed of the true genius of invention may astonish us by new productions at an advanced period of life. These productions will be the developements of former ideas, to draw the consequences from which no opportunity had previously occurred. But he would be terrified at the thoughts of following for a long time the steps of another mathematician. It was in town that Lagrange composed his last works, and at the same time he avowed the necessity of going to the country to form an exact idea of the new methods of M. Gauss.

Bossut wished to be just and impartial; and he wished it in consequence of that harshness of character of which he accuses himself, and of which he had given numerous proofs. We shall only notice one.

At the time that he was Examiner of Engineers, the Comte de Mury, at that time Commander of the Order of the Holy Ghost, and Governor of the Province, and afterwards Marshal of France and Minister at War, had personally recommended to him a number of pupils, who, by a singular fatality, were almost never worthy of being admitted, and who were in fact rejected. The Comte de Mury had expressed some dissatisfaction at this. When afterwards he became Minister at War, and when, according to the

custom, Bossut went to him for the first time with a statement of the examination which had been made, the Minister signed the promotion without hesitating, addressing to Bossut these words, equally honourable to the Minister and the philosopher: "I subscribe blindly, for I have already experienced that it is not necessary to examine after you."

Bossut was a great admirer of Pascal, whose works he published in 1779. He had collected with the greatest care all the Thoughts and other unpublished pieces furnished him by manuscripts and authentic copies. For the first time, Pascal appeared in a complete form. The editor did not wish to conceal or suppress any thing, not even the note written about a month after the accident at Neuilly. It was for this edition that Bossut composed his discourse on the life and writings of Pascal, which he republished afterwards as soon as an opportunity occurred. It was of all his works that which had been written with most attention to the style, and in which he had given his own opinions on subjects of literature, science, and religion. He saw in Pascal "a singular phenomenon that deserved to be often recalled to memory. This profound reasoner was at the same time a rigid and submissive Christian." We see that Bossut wished here to draw his own character. Destined in his youth for the church, known till 1792 under the title of Abbé, if his passion for mathematics, and his duties as a Professor, to which he was called so young, did not permit him to devote himself entirely to the ecclesiastical state, he preserved at least its manners for a long time, and maintained the opinions belonging to it all his life long.

He died on the 14th January, 1814. His place in the Institute has been filled up by M. Ampere.

---

## ARTICLE II.

*On Septaria.* By Dr. C. Wilkinson, of Bath, M. G. S.

(To Dr. Thomson.)

DEAR SIR,

DURING a visit I made at Harwich last May in company with my learned friend the Hon. Gen. Sir B. Henniker, Bart. I had frequent opportunities of examining the cliffs, and the progressive formation of septaria. These cliffs are about 30 or 40 feet above the level of the sea, and consist of a large proportion of ferruginous clay, some silex, and carbonate of lime. After every shower of rain, if the water absorbed be removed by evaporation, or expanded by frost, large portions of the cliff become detached, fall on the shore, and become exposed to the influence of spring tides. During the period of my residence in that sea port, I observed that in the

space of two or three weeks the detached portions acquired in many instances almost a flinty hardness. These are broke into small pieces of about 2 lb. weight, placed in a kiln similar to a lime-kiln, and exposed nearly to the same degree of heat: when removed from the kiln, they are reduced to a fine powder in a grinding mill, and then constitute the same cementing material as what is known under the name of Larkin Cement.

The cliff, when examined in situ, has all the appearance of an uniform argillaceous mass, except in some parts, separated by a whitish thin horizontal layer, which consists principally of carbonate of lime. Most of the portions at the period of being detached have an homogeneous appearance. During the period of desiccation a very curious change takes place. The exterior part hardens first, to a certain extent; and as this change is advancing towards the central portion, a fissure is produced, and the carbonate of lime, which retains its soft state much longer than the argillaceous portion, is mechanically separated from the clay, and pressed into this divided part. In its first stage I have remarked it to be near half an inch below the surface of the detached portion. In this state it is soft, but not fluid. After two or three days the calcareous matter becomes level with the surface, and in many instances projecting above. As the carbonate of lime hardens, a species of crystallization takes place, from which cause there is an additional protrusion of the substance. During these processes there are transverse fissures in different directions, considerably smaller than the first separation. These smaller clefts are filled in a similar manner. When perfectly hardened, and cut through, a complete septarium is observed to have been formed. It appears that the carbonate of lime is mechanically mixed with the other portions; and when it exists beyond a certain proportion, from remaining softer longer than the other parts, becomes mechanically pressed in that direction where it meets with the least resistance, viz. the central part: when the proportion of carbonate of lime is small, it remains intermixed with the clay. From this circumstance we observe many of the hardened portions without any calcareous septa.

It appears probable that metallic veins may be formed by a similar process; in the first instance an apparently homogeneous soft mass; and that during the subsequent periods of consolidation, the metallic mass, undergoing this change more slowly, may be similarly determined in any fissure formed by the desiccation of the other materials. If different metallic substances should require different periods for consolidation, we may form some idea of the formation of cross courses.

I moulded into an oblong form some of the detached portions of the cliff; the first-formed fissure was longitudinal; such was to be expected, as the resistance in that direction would be the least.

In Cornwall we observe the principal metallic veins are copper, and these are generally in the direction E. and W. If we consider Cornwall as a large oblong mass, the longitudinal diameter will be

in that direction, while the cross courses are generally filled with some other material. We may hence conceive why the metaliferous lime-stone of Derbyshire may be separated by amygdaloidal strata called toad-stone. The metallic vein in the upper stratum of mountain lime-stone is cut off, and again appears in the calcareous bed below the toad-stone stratum. Upon the foregoing principles we may explain the formation of veins without having recourse to the Huttonian or the Wernerian theories; and Professor Playfair has adduced the septarium as a strong illustration of its arrangements depending upon its previous fluid state by the agency of heat.

The carbonate of iron nearly constitutes one-third of the argillaceous mass; and its cementing powers depend upon the large proportion of this metallic matter. With the portions of the cliff are found great quantities of pyrites in thin flattened portions, which have all the appearance of having been previously in a softened state, as they bear the marks of impression from the surrounding materials: and it is not uncommon to find portions of wood strongly indented in them, and in that condition as to render it impossible that they could ever have been exposed to the agency of heat. In such abundance this sulphuret of iron exists, as to largely contribute to the supply of a copperas work in the vicinity of Harwich. Although the quantum of pyrites is so considerable, yet no traces of the sulphuret of iron are discoverable in the argillaceous mass. The formation of these pyritical masses favour the opinion I have ventured to offer relative to the formation of veins. If we regard all the substances which constitute the cliff to have been in a very softened state, and to have been formed of a general admixture of alumina, silex, carbonates of lime and of iron, and of the sulphuret of iron; in the first stage of desiccation the sulphuret of iron appears to be the first portion thus mechanically separated. As the complete consolidation cannot take place in situ, on account of the retentive power of the large proportion of alumina for water, as soon as portions of the cliff are detached and exposed to the air, the hardness above noticed takes place, with the changes already particularized.

In the vicinity of Bath we have frequent opportunities of observing in our rocks vegetable and animal remains in such conditions as to favour the supposition that the surrounding mass has been in a similar softened state. Lately a stratum of blue lias at Twyerton has been worked for the purposes of repairing the roads. In this rock some ammonites of nearly 12 inches in diameter have been discovered, most curiously compressed out of their usual spiral direction, without any destruction of the general characters of the cast of the shell of this supposed sea snail. In the fissures of this lias bed there are numerous beautiful octohedral crystals of pyrites, and in the same clefts are found large portions of wood, which have all the appearance of having been softened and flattened, the ligneous character in many parts well preserved, while the greater portions are converted into beautiful jet. I have one of these pieces,

nearly 2 lb. in weight, one end of which has the colour and properties of the Bovey coal, and the remaining portion in the state of jet. These ligneous portions have, in their drying, split in different directions, and into these divisions sulphuret of iron has been pressed.

It is a circumstance remarked by agriculturists, that when stiff clay lands are well limed, however carefully mixed and ploughed into the clay, in the course of time a series of hardened calcareous masses are formed, evincing that during the changes of the conditions of the argillaceous part, in its softening and in its drying stages, the lime becomes mechanically separated.

I shall take the liberty of troubling you for a future number with some remarks on the results of the analyses I have made on the substance of this cliff, before and after its calcination.

I am, dear Sir, yours respectfully,

C. H. WILKINSON.

### ARTICLE III.

*An Essay on the Shapes, Dimensions, and Positions of the Spaces in the Earth which are called Rents, and the Arrangement of the Matter in them: with the Definition and Cause of Stratification.*  
By Mr. John B. Longmire.

(Continued from p. 217.)

#### *On Surface Rents.*

I HAVE said that the earth's features are owing to the unequal contraction of its matter: the object of the following essay is to prove this assertion.

The dry land is generally divided into mountainous and flat ground. Mountainous ground consists of many long elevations and depressions, or mountains and valleys, which are generally situated in the following order: one range of mountains divides the mountain ground into two parts; both of which last contain ranges that make with the principal ranges either right or acute angles; and sometimes either or both of them contain small ranges similarly disposed towards them as they are to the principal range. A range of vallies lies between two ranges of mountains. If a line be drawn round the principal range, that for the greatest part is parallel to it, but that shall cross all the secondary ranges at right angles. The surface line of these ranges in this direction will be well represented by the undulating line *a b c d e f g*, fig. 4, Plate XXXVIII. which line encloses three mountains, *b, d, f*, and leaves two valleys, *c, e*, between them. This alternation of mountain and valley is thus accounted for. The earth's matter, before it had assumed its present degree of solidity, diminished considerably in bulk; and as its



elementary substances are not the same, nor their proportions to one another equal, in every part, the parts which differed from others diminished in bulk more or less than they. Hence some parts have sunk much lower than others; but as in general that difference in the component parts of matter reached its maximum progressively, it is productive of the undulated surface before described, under which the matter at *a, c, e*, sunk lower than at *b, d, f*.

The shape of mountain and valley just mentioned appears to be the most general, though not the only, one: for when the matter under valleys sunk below the tops of mountains above a certain distance, it appears to have separated the mountains into two or more parts. Let fig. 5 be the cross section of a mountain that is broken into two parts, *A, C*. Let *a b c* be the general surface line of a mountain when it preserves the ordinary figure. But the matter under the vallies *a, c*, sunk lower than this line by the depths *ck* and *ad*; and in doing so it forced the mountain *A C* to separate in the middle at *bg*; and one side to pass from *bg* to *eg*, and the other from *bg* to *ig*. The valley *B*, therefore, is formed by the separation of the mountain; and the sides *eg* and *gi* are not natural, but forced, surfaces. As all valleys similar to the valley *B* are filled up to certain heights, say equal to the height of the line *fh*, doubts may be entertained if the sides *ig* and *eg*, as seen on the surface, really continue to, and meet at, the point *g*; but sufficient proofs are found in the appearance of the sand and gravel, and in the water of lakes, by which such parts as the part *fgh* are filled. In the middle of the last described valley we sometimes meet with a rock, *D*, fig. 6, rising, as it were, out of the body of sand. Such a rock continues downwards till it meets the sides *bk* and *hm*, at *m* and *k*, and the hollows *kcd* and *fgm* are filled with gravel and sand, or with the water of lakes. The pass between Ambleside and Cockermouth, and probably that between the east and west seas, which contains the lakes Linnhe, Locky, and Ness, consist of a succession of valleys like that valley just described. Sometimes a mountain is separated into three parts, as fig. 7 represents. In all these separations the opposite sides of valleys are seldom of the same height; and sometimes one side of a valley is so much lower than the other, as to be totally covered with alluvial matter, or with lakes. The valley of Windermere has this appearance: *ghi*, fig. 8, is the lake, *kl* the steep side of the mountain on the west,\* and *gf* the flat mountain on the east side of the lake. The part *efh* was once as high as the part *lm*; at that time they would appear like the pricked sectional lines *a, b, c, d*; but the former part having a tendency to sink lower than the latter, a separation took place between them, and left them at liberty to contract independent of each other; accordingly the part *ab* sunk to *efh*, and the part *cd* to *lm*; but the part *ghi* of the side *fh* is

\* The steep rented surface of this mountain is between the Bellgrange and the Ferry. Above and below these places the mountain has its natural surface.



covered with the lake and alluvial matter, so that the steep side *hi*, which corresponds with the steep side *il*, cannot be seen.

All the rents in a group of mountains are resolvable into some of the foregoing rents: and all mountains and vallies are composed of some one, or combinations of two or more of, or all, these natural or rented inequalities. When a mountain is separated into parts by surface rents, the common, or undulated figure, is often disguised, or rather altered; but a sufficient resemblance still remains between its figure as it appears at present, and what it was before these rents happened, to distinguish the original extent and shape of every mountain. Where mountains and valleys are small undulated inequalities, as in the primitive district of Cornwall and Devonshire, surface rents are wanting; and from this circumstance arises the tameness of the scenery in these parts; but in the mountains of the northern parts of England and Scotland the undulations are much higher, and of course surface rents abound, and give the characteristic sublimity to these mountains.

I have hitherto confined my remarks to the primitive mountains. The mountains of transition lime-stone have steep sides which generally face the primitive mountains, and flat sides next the floetz or stratified countries; but sometimes the steep side faces the stratified formations, and occasionally any point between the primitive and stratified formations. This difference in the position of the mountain masses of lime-stone is thus accounted for. When the lime-stone lies on the remote side of a mountain range, whose long direction is parallel to that of the principal mountain range, the steep side faces the centre of the mountains: and when it lies on that side of such a mountain which is nearest the centre of the primitive group, its steep side then faces the stratified formations; but if it lie on either side of a mountain whose position is at right angles to that of the principal range, its steep side neither faces the centre of the group, nor directly the stratified formations, but a place half way between these extremes. The reason why mountain masses of lime-stone, lying only on one side of primitive mountains, must have steep and flat sides, will appear on examining the diagram attached to fig. 4. The floetz formations have undulated inequalities also, but they are much smaller than those of the primitive matter. The smallness of these inequalities is owing to the following circumstances: a collection of the floetz formations lies in very large hollows of the primitive and transition matter. Hence as this hollow was forming and filling slowly and progressively, the lower half had time to acquire a considerable degree of solidity, so that when the hollow was filled it was mostly the unequal contraction of the matter in the upper half of the formations that could affect the surface; and the inequality in the contraction of this part would give rise to only small elevations and depressions. When either the tops of *isolated*, underlying, unstratified, mountains, which are composed either of primitive matter, such as clay-slate,

&c. or lime-stone, or the tops of underlying, stratified mountains, such as some of the newest floetz trap formations of Werner, appear above the general stratified formations which surround them, they have individually one steep and one flat side, and are much larger, than any other inequalities that are found among the stratified formations.

The undulated figure of the earth's inequalities, as has been shown, took its rise from the sinking of the ground lower in one part than in another, and the rented surfaces were formed by its sinking below natural valleys, so much that the high ground was forced to separate into parts, to permit the continuation of that sinking. Therefore all the earth's features are owing to the unequal contraction of its matter.

#### ARTICLE IV.

*On the Collision of perfectly Hard Bodies.* By Mr. John Gough.

(To Dr. Thomson.)

SIR,

BODIES are divided into elastic and inelastic, from a very obvious difference in their effects after collision : they are also distinguished by the epithets of hard and soft, from their comparative plianthness. Hardness and softness are terms with which every one is acquainted ; but the human mind constantly endeavours, in the contemplation of the qualities of things, to conceive them in a state of perfection ; for it thereby acquires precise definitions, which are afterwards used in comparing the same qualities as they occur in nature. For this reason philosophers define that body to be perfectly hard which is so constituted as to resist all change of figure when acted on by a finite force. On the contrary, those bodies are said to possess the quality of hardness in an imperfect degree which undergo any alteration in their shapes from collision or pressure ; which changes are evidently produced by an internal motion amongst their constituent particles ; and this motion is as evidently effected in time in consequence of an external force being applied to the mass. After mathematicians have divided bodies into the kinds stated above, they proceed to lay down the laws of collision by help of these definitions ; but their demonstrations do not appear to be conducted with the same perspicuity, nor even with equal correctness in all the cases ; I mean in those relating to hard bodies. For theorems have been invented, expressing the interchange of motion, arising from the collision of bodies which are perfectly elastic, and of such as are imperfectly so ; and the results are found, upon comparison, to differ essentially. But when the same interchange comes to be investigated in the case of hard bodies, no notice is taken of perfect

and imperfect hardness; but the result of the inquiry is commonly referred to bodies possessing the quality in an absolute degree, though it is manifestly derived from the properties of matter which is comparatively soft or pliant. The fundamental theorem is commonly expressed in the following manner, or nearly so. If two perfectly hard bodies impinge upon each other, they will move together after collision with the velocity due to their common centre of gravity before and after impact, or else both will remain at rest. The arguments advanced in support of the proposition may be thus stated. When a perfectly hard body, A, impinges directly on another perfectly hard body, B, part of A's motion is transferred to B, by the action of A; and an equal quantity is taken from A by the re-action of B. Thus is the velocity of B augmented, and that of A diminished, until they become equal, when action and re-action ceases: but it is the velocity of the bodies which is changed by collision, not the momentum of the system; therefore the velocity of A and B becomes equal to that of their common centre of gravity, from the force of impact; consequently if the centre of gravity be without motion, A and B are reduced to a state of rest. Such are the arguments advanced in support of the proposition: but if only part of A's momentum be transferred to B, and that gradually too until these velocities become equal, the centre of gravity of A will in the mean time approach that of B. In other words, the figures of both bodies will be changed; consequently they are imperfectly hard and inelastic.

After making the preceding remarks on the fundamental theorem relating to the doctrine of collision in general, I will endeavour to investigate the effects which really would result from the impact of bodies possessing the quality of hardness in an absolute degree. For this purpose the reader is requested to form the simple diagram for himself, which is easily done, and will spare the editor a little unnecessary trouble.

Let A, B, F, G, &c. be a row of circles touching each other externally in succession. Also let the right line, C D, pass through their centres, and the figure is complete.

*Prop. 1.*—If a perfectly hard body, A, moving in the direction C D with the momentum M, impinge upon a perfectly hard body, B, at rest, A will lose all its momentum, which will be transferred to B in the same direction, C D; for as soon as A and B come into contact, their centres of gravity will cease to approach by definition; therefore A will exert its momentum, M, collectively upon B in the direction C D, no regard being had to time; and B will re-act in the same manner with an equal force in the direction D C; *i. e.* A will be urged in opposite directions by equal forces, one of which is its own momentum; therefore A will lose all its motion: but B is urged in the line C D with the momentum of A only; therefore M, or this momentum, will be transferred to B.  
Q. E. D.

*Cor.*—If A in motion impinge upon B at rest, the first in a row

of bodies, B, F, G, &c., which are in contact; the momentum of A will be instantaneously transferred to the furthest body, G, without any change of place in F and B. This is evident from the proposition.

*Prop. 2.*—If a body, A, moving in the direction CD with the momentum M, meet another, B, moving in the direction DC with the momentum R, these bodies will interchange their directions and momenta; for the force acting upon A in the direction DC, in consequence of B's re-action to A's motion, and the exertion of its own momentum, will be  $M + R$ ; but A's momentum in CD is M; and the excess of these forces, viz. R, gives A's momentum in DC after collision: in like manner B is urged in CD with the same force,  $M + R$ , and in DC with the force R. Therefore M is B's momentum in CD after impact. Q. E. D.

*Cor.*—Two perfectly hard bodies, whose centre of gravity is stationary, are not reduced to a state of rest by collision.

*Prop. 3.*—If a perfectly hard body, A, moving with the momentum M in the line CD, impinge upon another, B, also moving in CD with the momentum R, no change of direction will take place in either; but A's momentum after impact =  $A R \div B$ , and that of B =  $M + R - A R \div B$ . For the relative velocity of A and B before collision =  $M \div A - R \div B$ ; therefore momentum of collision =  $M - A R \div B$  = re-action of B or A in direction DC; which subtracted from the greater magnitude M, or A's momentum in CD, gives  $A R \div B$  = A's momentum in that direction after collision. Again, the action of A upon B's momentum, R, in the same direction CD gives B's momentum after impact =  $M + R - A M \div B$ . Q. E. D.

*Cor.*—A and B cannot in any case move together after impact; for supposing they can, A's velocity,  $R \div B = M \div B + R \div B - A R \div B$ . Hence  $M \div A = R \div B$ , which is impossible by the proposition.

I am, yours, &c.

Fowl-Ing, Kendal, Oct. 9, 1815.

JOHN GOUGH.

## ARTICLE V.

### *Queries respecting the Ventilation of Coal-Mines.*

(To Dr. Thomson.)

SIR,

THE various accidents that have recently happened to miners are calculated forcibly to excite the attention of every friend to humanity; and the interest which these events have awakened, will, I have no doubt, induce many persons to exercise their minds upon the means of averting such fatal mischiefs from so useful a portion of the community.

The most valuable discoveries are frequently of the greatest simplicity, and have occasionally been elicited by persons whose habits were very remote from the scene of their application. Will you permit one, who is desirous of obtaining as much information as possible upon the methods at present adopted to ventilate coal-mines, to request that some of your correspondents who are conversant with the subject would state in your Journal, or refer to any other publication, in which a minute detail may be found of the whole of the contrivances employed to expel, exhaust, or counteract, the injurious effects of the carbureted hydrogen gas, which has in so many instances rendered the extremities of mines inaccessible to the workmen. I am not unacquainted with the usual method or ventilation by the atmospheric current; but should, nevertheless, wish to see a circumstantial account of the different processes, common or rare, by which it is effected, and where and in what respects they are found to fail, together with whatever expedients may have been resorted to as remedies for such defects; and where these also have been unattended with success, to what cause such failures may be attributed. It would likewise be desirable to know how far any of the ingenious persons interested and concerned in mines have proceeded in their endeavours to devise a security for miners against the effects of the eruption of gas while they are at work.

A statement of the whole of these particulars, and of any others that bear upon the points in question, might prove of service to the cause, in calling forth the efforts of some, who, wishing to employ their thoughts upon them, are, for want previously of precise information upon these matters, at a loss how to direct their attention to advantage. I need scarcely suggest that, in taking any subject of art into consideration, it is highly expedient to be informed of the advancement which others have already made in it, and the manner in which even their unsuccessful attempts have been directed. Where this cannot be obtained, invention will not have fair play, and the most sedulous endeavours may be lavished upon what has long been known. After a series of efforts, it has often appeared that only a small portion has been gained of the same ground, over which others had unprofitably passed before, and hours of application may thus be utterly lost.

I am, Sir, yours respectfully.

## ARTICLE VI.

*Description of an Instrument for ensuring the Attention of Watchmen.* By Henry Beaufoy, Esq.

(To Dr. Thomson.)

DEAR SIR,

*London, Oct. 25, 1815.*

THE losses and inconvenience to which the community are exposed through the inattention of watchmen to their nightly duties are a theme of general complaint. The depredations committed, not unfrequently within a few yards of the watchman's station, are a practical proof of the very insufficient manner in which the rounds are performed. The cause of the evil is evidently to be traced to the inability of the employers to compel vigilance by the certainty of detection.

Having occasion myself some time ago to conduct a process in which success depended on an undeviating hourly attendance throughout the day and night, it became necessary to devise some means by which the presence of those appointed to manage the operation might be insured.

The watch clock, of which I have the honour to enclose you a drawing, completely answered the purpose. It is equally adapted to civil and military as to manufacturing purposes. By placing the clock in any building at the further extremity of the round, it not only points out occasional dereliction from regularity, but registers the precise hour in which the neglect took place.

In the first wheel or register I had made, the inner or hour circle was omitted for the sake of getting rid of extraneous weight; but in the second it was introduced as combining the double purposes of the common house, as well as of the register, clock.

I am conscious that this communication is too insignificant to be worthy of a place in your Journal; but having derived advantage from the use of the register myself, I think it possible that some of your readers interested in manufacturing establishments may feel no disinclination to adopt a safe check on the confidential, and an unerring detector of the careless, in their employ.

I remain, dear Sir,

Your most obedient and obliged servant,

HENRY BEAUFOY.

The machine consists of a common eight day striking clock, the glass front of which is reduced to the diameter of the hour circle, as shown in fig. 1, Plate XLI. The hour and minute hands are removed, and the register substituted in their room. The register, being required to make but one revolution in 12 hours, is fixed to the hour arbor of the clock-work. The figures on the hour

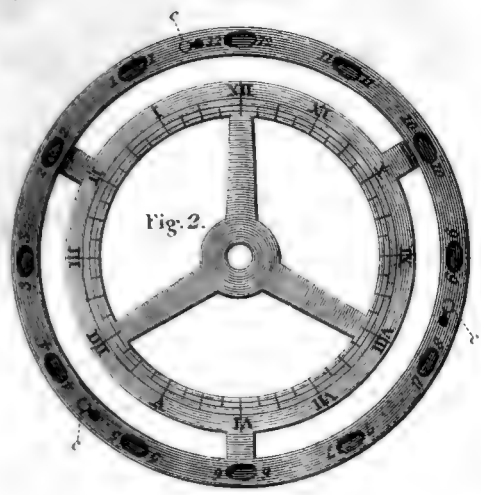

Fig. 2.

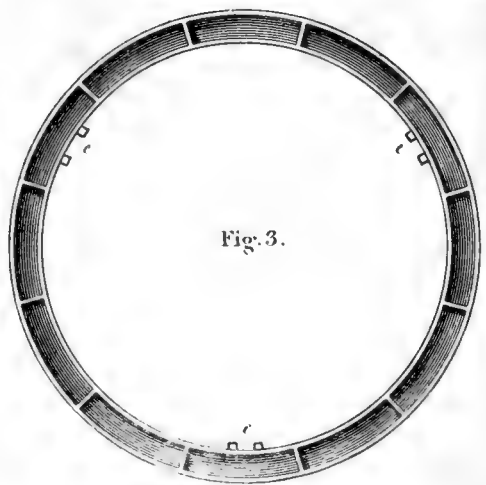

Fig. 3.

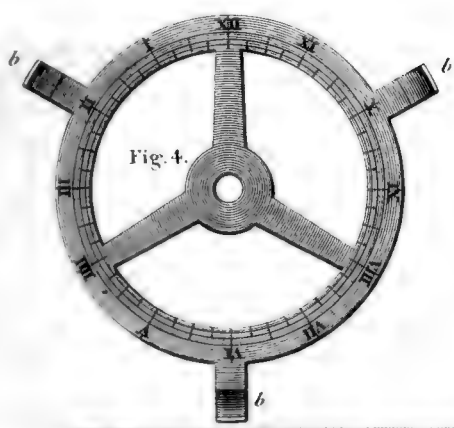

Fig. 4.

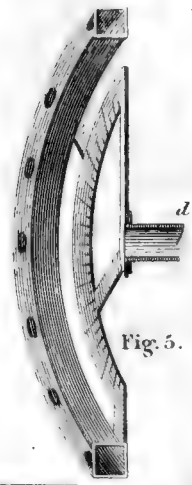

Fig. 5.



Fig. 6.

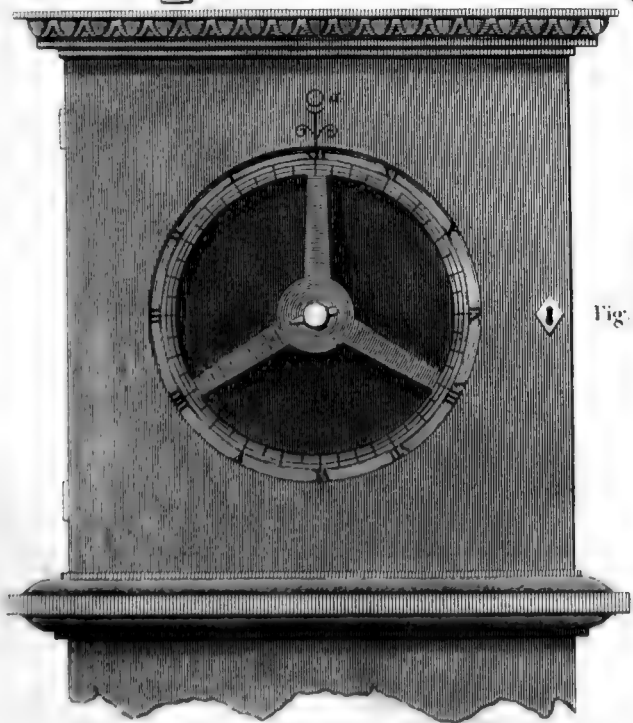

Fig. 1.

*An Instrument for insuring the attention of Watchmen.*





circle are reversed in the order in which they stand on the common clock faces, because the motion of the hours becomes reversed by making the dial revolve instead of the hands. The register is composed of three distinct parts: a light brass circular magazine, half an inch wide, and of the same depth, divided into 12 compartments; a lid or cover with the same number of elliptical perforations; and an hour circle. Fig. 4 shows the hour circle, to the outer rim of which are attached three crutches, *b, b, b*, to receive and support the magazine, which is guided into its place, and kept steady there, by six small shoulders or projections, *c, c, c*, on its inner edge, which embrace the sides of the crutches. Fig. 3 represents the magazine or outer circle, with its front plate removed, exhibiting the division into compartments. The partitions are made by two or three wires rivetted or screwed into the two sides of the circle. Fig. 2 is a front view of the register with all its parts connected: *c, c, c*, are three studs or buttons which keep the lid affixed to the magazine. In this view are shown the elliptical openings into the magazine. These openings are 10 minutes in their shortest, and 20 in their longest, diameter. The rim moves so easily in and out of the crutches, as to admit of its being detached, or put on, without affecting the going of the clock. Immediately above the meridian of the clock, fig. 1, a hole, *a*, is bored through the wooden door, of a diameter equal to 10 minutes measured on the register circle. The centre of this hole must exactly coincide with the centre of the openings in the rim of the register. It only remains to furnish the watchman with a sufficient number of light spherical wooden balls of a diameter equal to the holes in the clock front, and to instruct him to drop one into the hole, *a*, at each hourly visit. The elliptical shape of the holes in the face of the rim will allow the ball to pass into the register either five minutes before or five minutes after the exact hour stroke. At the expiration of the watch, the door is unlocked, the rim removed from the crutches, and the face or lid slipped from the studs. The absence or presence of a ball in each compartment indicates the regularity or the neglect with which the duty has been performed.

—◆—

*Reference to the Plate.*

Fig. 1, the head of the clock with the register adapted ready for use.

Fig. 2, the hour and register circles in working order.

Fig. 3, the register without its plate or cover.

Fig. 4, the hour circle with the crutches ready to receive the register, fig. 3.

Fig. 5, a section in perspective of fig. 2, fixed to the hour arbor, *d*, of the clock, as in fig. 1.

Fig. 6, one of the crutches attached to the hour circle, fig. 4, and which carry the register, fig. 3.

## ARTICLE VII.

*Further Observations on Fluxions.* By Alex. Christison, Esq.  
Professor of Humanity, Edinburgh.

(To Dr. Thomson.)

MY DEAR SIR,

Edinburgh, Oct. 13, 1815.

To some remarks on Euclid's definition of proportion, in his fifth book, to be inserted, if you choose, in your *Annals of Philosophy*, I subjoin the deduction of fluxions from the definition which you published in May.

If the equality of the products of the means and of the extremes be assumed as the criterion of proportionality, it is evident that the formula  $\frac{1st \times A}{2d \times B} = \frac{3d \times A}{4th \times B}$  demonstrates Euclid's property, in his fifth definition, book fifth, with regard both to commensurables and to incommensurables; and that the formula is applicable even to *abstract* numerical and algebraical quantities: but it will be found that the criterion above-mentioned is not so convenient as Euclid's for demonstration. We cannot, however, apply Euclid's criterion or property so universally as the other; for we cannot, in demonstration, apply it to *abstract* numerical and algebraical quantities: we can apply it to those quantities only in which, as in geometrical magnitudes, the slowest learner sees that the first and the third have a necessary dependance on each other, as also the second and the fourth. A learner understands immediately Euclid's definition if he be directed to prop. 33, book 6; for supposing the angle at the centre, the first term is an arch of the one circle, and the third term is the corresponding angle of that arch. Now it is impossible for the slowest learner to conceive that he can double, &c. the arch or first term without doubling, &c. the corresponding angle or third term. The same may be said with regard to the second and the fourth terms, which belong to the other circle. If the one circle be laid on the other, and if the multiple of the one arch be equal to the multiple of the other, the multiple of the one angle must also be evidently equal to the multiple of the other; and if greater, greater; and if less, less: consequently the quantities are, by the definition, proportional. The equimultiples of the first and third, and of the second and fourth, can be exhibited to the learner without taking any particular numbers as multipliers: but it is impossible, I think, to do so with regard to any *abstract* numerical and algebraical quantities which are to be proved proportional; and if we take parts, we abandon Euclid's definition. Euclid's definition, then, is not applicable to all proportional quantities; but it is perfect if it be limited by its proper range: it admits, but it does not need, demonstration; it includes incommensurables; and it de-

monstrates simply and rapidly where some eminent mathematicians demonstrate complexly and tediously.

As fluxions are a part of the theory of rates, I subjoin an algebraical investigation and demonstration of the fluxional problem.

*Definition.*

Fluxions is a method for finding the rate of change in a quantity and its function.

*Problem.*

To find the fluxion of  $x^n$ ;  $n$  being any positive, integral, number; and  $\dot{x}$  or 1 being assumed, as it may be, for the fluxion of  $x$ , while  $x$  varies uniformly.

$x^n$  may be represented thus,  $x \times x \times x \times x \dots$  with  $x$  as often employed as there are units in  $n$ ; and if it is only the first  $x$  that varies, the fluxion must be  $1 x^{n-1} \dot{x}$ ; but if every  $x$  varies in succession, the fluxion must be  $n x^{n-1} \dot{x}$ . Q. E. I. and D.

If  $\dot{x} = 1$   $\dot{x} = 1 \times 1$  be represented by a square whose side is  $= 1$ ,  $n x^{n-1} \dot{x}$  may be represented by an oblong with 1 for one of its sides, and  $n x^{n-1}$  for the other; consequently,

As the square : the oblong ::  $1 \dot{x} : n x^{n-1} \dot{x}$ .

If a learner find any difficulty in conceiving that if  $x$  vary uniformly,  $\dot{x}$  or 1 is the fluxion of  $x$ , he will easily learn that, in comparing the rate of variation or change, in an uniform motion of  $16\frac{1}{2}$  feet in a second, with the law of descent of heavy bodies, the rates at the end of each successive second are, as 1 : 2, as 1 : 4, as 1 : 6, &c., the space gone over by the uniform motion being represented by  $x$ .

If those ancients, such as Archimedes, who understood varying quantities, had subjoined the rate of variation, they would have taught us fluxions; but perhaps they had not a proper notation.

In your 33d number the reader may insert *&c.* after *great*, p. 179, l. 2; *reduced for referred*, p. 179, l. 33;  $\dot{x}$  *being* = 1, p. 180, l. 30, after *coefficients*; *rigour for vigour*, p. 181, l. 4; *letter for latter*, p. 182, l. 7; and he may efface the words between the first *rate* and *of*, p. 182, l. 41.

I am, my dear Sir, yours faithfully

ALEX. CHRISTISON.

## ARTICLE VIII.

*Letter from Wm. Henry, M. D. F.R.S. correcting some defective Statements in different Histories of the Introduction of Bleaching by Oxymuriatic Acid.*

(To Dr. Thomson.)

DEAR SIR,

Manchester, Oct. 1815.

The fourth volume of Mr. Parkes's useful work, lately published, contains an account of the introduction of the mode of

bleaching by oxymuriatic acid into this country, which, though correct in the main, is not altogether so. It resembles, indeed, so closely, in several respects, a statement published some years ago in Dr. Rees's Cyclopædia, that it is probable the historical information of both was derived from the same source. You will, therefore, oblige me, if you consider the subject of sufficient importance, by admitting into your Journal the substance of a representation, which I addressed several years ago, to the Rev. Dr. Rees, in behalf of the claims of a person in whose reputation I may naturally be supposed to feel some interest.\* But, independently of this interest, it does appear to me, that the public ought to be set right respecting the real history of this invention. The credit which a man of science derives from contributing to the improvement of the useful arts, is often (as in this case) the only reward he receives; and it is the duty of the historian of those arts, first to make himself thoroughly master of the facts, and then to detail them with fairness and impartiality.

I have chosen this time for bringing the matter before the public, because all the parties concerned are still living, some of them at a very advanced age, and may readily be called upon for farther evidence, if it should be thought necessary.

I am, dear Sir, yours very truly,

WM. HENRY.

(To the Rev. A. Rees, D.D. F.R.S. &c.)

REV. SIR,

Dec. 1809.

Observing that the early volumes of your Cyclopædia are about to be reprinted, I am induced to fulfil an intention, which I have long entertained, of addressing a few lines to you respecting the article BLEACHING, published in vol. iv. part 2, 1st edition. The writer of that article, in assigning to different persons their shares of merit, in the introduction of the mode of bleaching by oxymuriatic acid and its compounds, has made a distribution, which is very far from being an equitable one.

Of the part which was taken by Mr. Watt of Birmingham, in the application of Berthollet's important discovery, far too little is said; and of Mr. Henry's share in the improvement not the smallest notice is taken, though it could not fail to be known to the writer of the article, who, at that period, was himself engaged in this town in pursuit of the same object, and was in habits of occasionally communicating with Mr. Henry on the subject. The truth is, that next to Mr. Watt, Mr. Henry was at least equally early with any other person in applying the discovery to practice. In proof of this I might appeal to the general notoriety of the fact in this town and neighbourhood: but I depend chiefly for its establishment, on a number of letters from Mr. Watt to Mr. Henry, written in the year 1788, which are now before me. They form

\* The person alluded to is Mr. Thomas Henry, F. R. S., President of the Literary and Philosophical Society of Manchester,

part of a series, in which each of those gentlemen disclosed; unreservedly to the other, the progress of his experiments in this new art. In a letter dated Feb. 23, 1788, Mr. Watt states, that at that very time, 1500 yards of linen were bleaching by the new process under his directions; and he desires that the circumstance may be stated to a meeting of the manufacturers and merchants of Manchester, then called by public advertisement, 'to consider of a petition presented to Parliament by M. M. Bourbollon de Bonnueil and Co, concerning a liquid which whitens linen and cotton in a shorter time than the old method, and without the inconveniences and losses to which that method is liable.\*

At this meeting half a piece of calico was produced, which had been bleached immediately before by Messrs. Cooper, Baker, and Charles Taylor, by the new method; and at the same meeting, Mr. Henry produced, not indeed half a piece, but half a yard of calico, which he had just bleached by the oxymuriatic acid. What was wanting, however, in quantity, was made up by the quality of the work; and the smaller specimen was declared to be superior in whiteness to the larger one. It was this superiority that gave occasion to an application from one of the bleachers present (M. Ridgway of Harwich) to Mr. Henry, to be instructed in the new process. And the instructions which he accordingly received, were the first step of a series of improvements carried on by Mr. R. and his son, with an ability and spirit of enterprise, which have raised their establishment to its present great extent and importance, Mr. Henry, also, besides instructing other persons, himself established a bleaching concern, which was afterwards abandoned, from no defect, however, of the processes carried on, but in consequence of the dishonourable conduct of a partner, and of the occupation of his own time in the practice of medicine.

The event of the public meeting was, that in consequence of the facts stated in Mr. Watt's letter, and of the testimony of Mr. Cooper (now of Carlisle College, America) and Mr. Henry, who were present, the members for the county were instructed to oppose the petition when presented to Parliament; and its prayer was accordingly refused.† Having failed in this object, the next attempt

\* In this letter, Mr. Watt says "I have, for more than a twelvemonth, been in possession and practice of a method of preparing a liquor from common salt, which possesses bleaching qualities in an eminent degree; but, not being the inventor, I have not attempted to get a patent or exclusive privilege for it. And I have great reason to believe that the process of these gentlemen (Bourbollon and Co.) is the very same that I practise, and that they have learnt it from the same source, the inventor being an eminent chemist and philosopher at Paris." It is evident, therefore, that all claims for priority, that have been hitherto advanced in this country, must yield to that of Mr. Watt, whose actual employment of the oxymuriatic acid in bleaching dates from the beginning of the year 1787.

† This was the true reason of the rejection of the petition, and not, as Mr. Parkes states, (Essays, iv. 62), the opposition of a gentleman, who happened to be in the gallery of the House of Commons when the petition was brought forward. Mr. Watt, also, (who in making these efforts had no view whatever to his

of De Bonnueil and Co. was to obtain a patent. But here again they met with effectual opposition, no unavailing part of which consisted in an instrument, presented in due legal form by Mr. Henry individually, against the claim of the petitioners. This document, dated July 2, 1788, is now before me. It contains an account of the processes then actually practised by Mr. Henry, and comprehends every thing at this day known respecting the use of the oxymuriatic acid in bleaching, with the exception of the application of lime to the condensation of the gas. This application of lime was afterwards made by Mr. Henry, in a way which adapted it only to white goods. But, in consequence of a happy invention of Mr. Tennant of Glasgow, which may be considered as the last step in the improvement of the art, the use of oxymuriate of lime was extended, in the year 1798, to fabrics of the most delicate colours, and rendered more practicable and advantageous in the bleaching of white goods.

After this statement, I appeal to you, Sir, whether the history of the art of bleaching, contained in your Cyclopædia, written by one who was perfectly well acquainted with the facts which I have alleged, can be considered as any thing but exceedingly unfair and partial. And I claim from your known candour and love of justice, that the person in whose behalf I stand forward, shall receive in the subsequent editions of your work, a fair share of credit for his prompt and active zeal in furthering a most important invention, and in defeating the purposes of those who aimed at rendering it an injurious monopoly.

I am, Rev. Sir, with great respect and regard,

Your obedient Servant,

WILLIAM HENRY.

## ARTICLE IX.

*On the Conversion of Starch into Sugar.*

By M. Theodore de Saussure.\*

THE process, which Mr. Kirchof (Adjunct of the Academy of Sciences in Petersburg) has discovered, of converting starch into sugar by long boiling in very diluted sulphuric acid, has been frequently repeated by chemists, and has been enriched by several

own private advantage,) was in other respects a powerful auxiliary in preventing the monopoly of the foreigners. In another letter to Mr. Henry, dated June 8, 1788, he says, "Through the help of my friends, such parliamentary interest was made, as must in some degree have contributed to defeat the plagiary Bourboulon, whose sole pretensions are founded on his impregnating caustic alkalis with the gas, a process previously discovered and publicly mentioned by Berthollet, but laid aside, as it destroys half the efficacy of the acid.

\* Translated from Gilbert's Annalen, vol. xlix. p. 129. Feb. 1815. The paper appeared originally in the Bibliotheque Britannique for 1814.



important remarks. But hitherto nobody has explained what alterations in its composition the starch undergoes in this process, though this would throw considerable light upon vegetation, and would elucidate the change of starch into sugar in the buds of plants. Professor de la Rive of Geneva, in a paper published in the 49th volume of the *Bibliothèque Britannique*, has shown that in Kirchoff's process no gas is evolved, that the alteration of the starch goes on in close vessels without the access of air, and that the sulphuric acid is neither decomposed nor united to the starch as a constituent. M. Vogel in Paris has made the same observations, and has likewise found that long boiling in pure water does not convert the starch into sugar. Hence he concludes, conformably to the well known action of sulphuric acid, that even in this case it acts by uniting together a portion of the oxygen and hydrogen of the starch and converting them into water.

In order to elucidate these points, I have endeavoured to determine whether the sugar formed from starch by this action of sulphuric acid has a smaller weight than the starch from which it was formed. For this purpose I put into a silver vessel 400 grammes of distilled water. I then mixed it with 2·4 grammes of sulphuric acid, made it boil moderately on a charcoal fire, and put into it in different portions 100 grammes of starch, previously mixed with 200 grammes of water. During this addition the liquid was constantly stirred with a spatula, to prevent the starch from being burnt or becoming brown, which would have diminished its weight and rendered the results doubtful. In half an hour the mixture was brought from the state of dough to a complete solution.\* I now put it into a capsule with a long neck, washed with 200 grammes of water, the clammy matter left by the starch on the silver vessel, dissolved it, put the whole into the capsule, and kept it for 42 hours over an Argand's lamp in a heat never exceeding 199°. I now weighed the solution, filtered it, and weighed likewise the white dough which remained behind upon the filter, and which may be considered as a portion of starch, which from the adhesion of its parts escaped the action of the sulphuric acid. This dough being repeatedly washed and dried in the open air, weighed 4 grammes, and when examined by means of water, acids, and alkalis, exhibited all the properties of starch. We must therefore subtract these 4 from the 100 grammes of starch employed in the experiment. Upon the filter, and in this starch-

\* If it be allowed to cool at this time it becomes again partly thick, and when filtered leaves upon the filter a considerable quantity of starch still unaltered, while the solution passes readily and quite clear, through the paper. When this solution is concentrated and mixed with alcohol, there falls down a transparent dry colourless matter, not altered by exposure to the air; which, from its solubility in water, insolubility in alcohol, and its clamminess when dissolved in a little water, is similar to gum. Barytes water, when poured into the solution, occasions no precipitate, as barytes and sulphuric acid form a triple compound with gummy bodies, which is usually soluble in water. Is this gummy body similar in all its properties or not, to the brownish body obtained by roasting starch?

dough before it was washed, there remained  $\frac{1}{9}$ th of the filtered liquid. Therefore when I give the result here I increase the last by one ninth.

I poured barytes water into the filtered liquid as long as any precipitate fell. This precipitate, after being heated to redness, weighed 6·7 grammes, and was sulphate of barytes. A small quantity of it passed through the filter, and was afterwards found in the ashes of the starch sugar. Now this sulphate of barytes contains all the sulphuric acid which was employed in experiment.

The solution thus freed from sulphuric acid was reduced to the consistency of a thick syrup, and then left in a state of repose. It furnished a yellowish sugar, which, after long exposure to the open air in a temperature of 52°, and while the hair hygrometer stood at 75°, weighed 96·89 grammes. Such was the quantity of sugar obtained from 96 grammes of starch. So that 100 grammes starch will yield 100·93 grammes of sugar, supposing both dried at the temperature of the atmosphere; but this result must be brought to the temperature of boiling water before we can put much confidence in it.

100 grammes of the starch with which these experiments were made, being exposed for six hours to a heat of 212°, lost 13·4 grammes of water; and when burnt left 0·16 of ashes.

On the other hand 100 grammes of solid starch sugar treated in the same way, lost 4·93 of water, and left 0·75 of ashes, most of which was sulphate of barytes that had passed through the filter.

If according to these results we reduce the starch and its sugar to a boiling heat, and subtract from them the ashes, we find that 100 parts of starch will form 110·14 parts of sugar.

This sugar, when dissolved in half its weight of water, formed a syrup, which might be mixed with alcohol of 36° of Baume's areometer in any proportion, without the precipitation of any gum. Hence gum does not constitute a portion of starch sugar, as some have believed, except when the process has not been continued long enough, or when the starch itself has been scorched, in which case the starch sugar will be lighter than the starch from which it was obtained.

As starch boiled in water with sulphuric acid, and thereby changed into sugar, increases in weight without uniting with any sulphuric acid or gas, or without forming any gas, we are under the necessity of ascribing the change solely to the fixation of water. Hence we must conclude, that starch sugar is nothing else than a combination of starch with water in a solid state.

The sulphuric acid and other acids appear to act no other part in the process, than to promote the fluidity of the aqueous solution of the starch, and thereby facilitate its combination with water.\*

\* The attempts of Kirchof and others, to convert flour or potatoes directly into sugar by this process have entirely failed. —GILBERT.

This explanation of the change of starch into sugar will be fully confirmed by my

*Analysis of Starch and Starch Sugar.*

I burnt 57 milligrammes of starch, which had been dried in the mean temperature of the atmosphere, in oxygen gas. This combustion consumed 40.31 cubic centimetres of oxygen gas, and there were formed 43.83 cubic centimetres of carbonic acid gas and 0.13 cubic centimetre of azotic gas.\*

In another experiment, 48 milligrammes of starch dried in the same way consumed 33.99 cubic centimetres of oxygen gas, and produced 34.80 cubic centimetres of carbonic acid gas and 0.16 of azotic gas.

If we take the mean of these two experiments, we find that 100 parts of starch dried at the temperature of boiling water, and abstracting the ash which they contain, are composed as follows:

Carbon . . . . .	45.39	}	or	{	Water . . . . .	50.48
Oxygen . . . . .	48.31				Oxygen in excess . . . . .	3.76
Hydrogen ..	5.90					
Azote . . . . .	0.40					
	100.00					

On the other hand, 53 milligrammes of starch sugar prepared as above described, and dried at the temperature of 52°, consumed when burnt 34.59 cubic centimetres of oxygen gas, and there were produced 36.07 cubic centimetres of carbonic acid gas.

In a second experiment, 63 milligrammes of starch sugar consumed 37.755 cubic centimetres of oxygen gas, and produced 39.584 cubic centimetres of carbonic acid gas.

The mean of these two experiments gives the composition of starch sugar, abstracting the ash, as follows:

Carbon . . . . .	37.29	}	or	{	Water . . . . .	58.44
Oxygen . . . . .	55.87				Oxygen in excess . . . . .	4.26
Hydrogen ..	6.84					
	100.00					

When we compare together these analyses of starch and starch sugar with each other, we find that they give us the same result as the synthetical experiments, namely, that the only difference between the sugar and the starch, is that the former contains a greater proportion of water as a constituent than the latter. But in the quantity of this water the two methods of experimenting differ from each other. When 100 parts of starch, dried at the temperature of boiling water, were changed into sugar, they ap-

\* The azote did not appear as a gas, but as a constituent of subcarbonate of ammonia. But I have here stated its amount, supposing it in the gaseous state.

peared to have combined with 10 parts of water; while analysis gives 20 parts more water in the starch sugar than in the starch. It is obvious, however, that the proportion of water obtained by the first method must be too small, as in a process of that kind it is very difficult to avoid all loss, besides that which is occasioned by a commencement of roasting.

*Analysis of the Sugar of Grapes.*

I obtained the sugar, with which the following experiments were made, from Mr. Pautex, by whose labours the manufacture of sugar of grapes has been greatly improved.

100 parts of sugar of grapes, dried at the temperature of  $53.5^{\circ}$ , and when the hygrometer stood at  $75^{\circ}$ , when exposed to the heat of boiling water, lost 3.14 parts of water; and when burnt left a residuum weighing 0.513 parts.

0.55 centigrammes of the same sugar, dried at  $53.5^{\circ}$ , when burnt, consumed, according to the mean of two experiments, 34.21 cubic centimetres of oxygen gas, and formed 36.17 cubic centimetres of carbonic acid gas. Hence 100 parts of sugar of grapes, dried at the temperature of boiling water, are composed as follows:

Carbon. . . . .	36.71	}	or	{	Water . . . . .	58
Oxygen . . . . .	56.51				Oxygen in excess . . . . .	5.29
Hydrogen ..	6.78					
	100.00					

The result of this analysis of sugar of grapes does not differ farther from that of starch sugar, than is usual in two different experiments upon the combustion of the same body. These two sugars likewise approach so near each other in all their other properties, as to render it probable that they constitute only one species. They both melt at the temperature of boiling water; they have both the same sweet and fresh taste; they both undergo the vinous fermentation; they both crystallize confusedly in spherical crystals; they are both equally soluble in water and in weak alcohol; and all the differences which exist between them are analogous to those which we frequently find between sugar of grapes from two different varieties of grapes.

Sugar from the cane and from beet differs much from these two, and from all other sugars, by containing a greater proportion of carbon. According to the analysis of Gay-Lussac and Thenard, 100 parts of the sugar of the sugar-cane contain between 42 and 43 parts of carbon, and the oxygen and hydrogen are so graduated as to form water without any residue. I have obtained the same result, except a small excess of oxygen above the elementary water, which might very well be owing to an error in my experiment.

*Method of conducting my Experiment.*

In the preceding analyses I made use of the following method, which I employ in the analysis of gummy and woody bodies that contain very little or no azotic gas. I reduce the vegetable body to as fine a powder as possible, mix it with 50 times its weight of silicious sand, and put it into a glass tube bent in the middle at a right angle, close at one end, and furnished at the other with an iron stop cock. This tube is about a metre (39·37 inches) in length, and its width is such, that it is capable of containing rather more than 200 cubic centimetres (12·2 cubic inches) of gas. I weigh the vegetable substance by the way of substitution, in the tube itself, by means of a balance, which, when loaded, turns by the addition of one milligramme (0·015 gr.) The air is then extracted from this tube by means of the air pump; it is filled with oxygen gas, the stop cock is shut, and all its joints are covered over with mastich, or it is surrounded by a column of mercury during the burning of the vegetable matter, in order to be certain that no gas makes its escape while it is expanded by heat: for the stop cock, which incloses a portion of gas, is not always able to withstand the compression or dilatation which takes place within, which frequently acts as a kind of valve.

The stop cock being thus secured, I heat that part of the tube with which the vegetable body is in contact, to an obscure red; and for this purpose I employ a spirit lamp, which gives a flame at least one decimetre high (3·937 inches), and at least of such a diameter as to surround the whole circumference of the tube. Liquid and sooty matter speedily disengages itself, and is deposited in a neighbouring part of the tube, which is kept cool by being surrounded with moist paper. I afterwards heat this part of the tube to redness. The vegetable matter burns, and is partly volatilized and condensed in another part of the tube. This new portion is heated to redness in its turn. I go on in this manner, heating the condensed portion a great many times in succession, till the decomposition appears to be complete, and the liquid remaining to be nothing else than pure transparent water.

To measure the alteration of the volume, which the gas has undergone during the combustion, I fill a graduated tube one decimetre in length, and furnished with an iron stop cock at each end, with mercury and with oxygen gas, fix it on the first tube, plunge the end of it under mercury, and open both the stop cocks, which establishes a free communication between the two tubes, and observe the increase or diminution of gas which has taken place. To get the gas out of the tube, I screw upon both the tubes a balloon, furnished with a stop cock, and filled with mercury. The mercury runs into the tube, and the gas makes its way into the balloon. The quantity of it is sufficient to make four eudiometrical experiments on its nature.

In order to determine whether the vegetable substance subjected

to combustion contained azote, I wash with 30 grammes of water the large tube and the mercury with which it was filled, in order to drive out the gas, and separate this water from the mercury, by means of a funnel with a capillary tube. I then distil this water at a moderate heat over hydrate of lime. A tube moistened with neutral nitrate of mercury, dipped into a few drops of the distilled liquid, occasions a greyish black precipitate, even when the quantity of azote in the vegetable substance analysed does not exceed one thousandth part of the whole.

By means of this reagent I estimated nearly the small quantity of ammonia which existed in the products of my analyses, after having ascertained, by previous trials, how much water it was necessary to add to a known mixture of ammonia and water, to reduce it to the limit of precipitating immediately with nitrate of mercury. I found that when water has absorbed half its volume of ammoniacal gas, or, in other words, when one gramme of water has absorbed 0.0003443 gramme of ammonia, 55 times its volume of pure water may be added to it, without preventing the precipitate from immediately appearing. But this is the utmost limit of dilution; for if more water be added, the precipitate does not immediately appear; supposing that in both cases we operate upon equal doses of the liquid; and the quantity which I always take is six grammes.\* From this single datum a table may be constructed, showing the quantity of ammonia in the liquid, according to the quantity of water necessary to add to it, in order to bring it to the limit of precipitating with the nitrate of mercury. We mix determinate quantities of the liquid and water together till we come to this limit: suppose, for example, that I find that this limit takes place when I mix together equal quantities of the liquid and water, the table in that case shows me that one gramme of the liquid contains 0.000012297 gramme of ammonia. From this quantity of ammonia I determine the quantity of subcarbonate of ammonia formed during the experiment, and introduce the constituents of this salt into my calculation.

In these analyses I only burn five or six centigrammes of the vegetable body. The error, resulting from weighing, amounts only, in consequence of the accuracy of my scales, to  $\frac{1}{50}$ th of the analysed body. I endeavour to remove this error by repeating the analysis several times, and only taking the results when they are sufficiently accordant.

The uncertainties attending the eudiometrical processes are much more considerable. By means of them alone can the important question be answered, whether in saccharine, gummy, resinous, and starchy bodies the oxygen and hydrogen exist in the

\* The reagent consists of  $6\frac{1}{2}$  parts of crystallized nitrate of mercury, dissolved in 100 parts of cold water. All the results which I give are founded on such a state of the solution. But as it is probable that others may not prepare it in exactly the same manner as I do, it will be necessary for every one to determine the data respecting the solution of nitrate of mercury for himself.



exact proportion necessary to constitute water. The quantity of oxygen above this proportion, which I found in my analyses, does not appear to be sufficiently great to destroy the law established by Gay-Lussac and Thenard, that a vegetable body is acid when it contains an excess of oxygen above what is necessary to constitute water, since it may be ascribed to errors in my experiments, or in my method. But some other of my analyses have given so great an excess of oxygen, that it cannot be ascribed to errors in the experiment. Thus, for example, the analysis of gum arabic, which I repeated five times, with very little difference in the results, gives its composition as follows: 100 parts of gum arabic, dried at the temperature of boiling water, and abstracting the ash, are composed of

Carbon.....	45.84	}	or	{	Water .....	46.67
Oxygen ....	48.26				Oxygen in excess.....	7.05
Hydrogen ..	5.46					
Azote .....	0.44					
	100.00					

Gum tragacanth gave me very nearly the same result; and sugar of milk contains five or six per cent. of oxygen above what is necessary to constitute water, and 39 or 40 per cent. of carbon, which is nearly the quantity given by Gay-Lussac and Thenard.

On the other hand, I have found vegetable bodies neither of a resinous, oily, nor alcoholic nature, which yet contained no excess of hydrogen above what was necessary to constitute water. To such belong purified sugar of manna, precipitated from boiling alcohol, 100 parts of which, dried at the temperature of boiling water, contain

Carbon.....	17.82	}	or	{	Water .....	51.86
Oxygen ....	45.80					
Hydrogen ..	6.06					
Azote .....	0.32					
	100.00					

The alterations in the laws respecting the combination of the constituents of vegetable bodies resulting from my experiments are not remarkable. We see that all gummy, saccharine, and starchy vegetable bodies consist, in fact, of little else than carbon united to a portion of water reduced to its elements. However, the excess of the oxygen or hydrogen in these bodies, above what is requisite to constitute water, must be greater than is indicated by my analyses. Because the boiling heat of water, at which the vegetable bodies were dried, is not sufficient to dry them completely, and to remove all the water retained by capillary attraction: this adventitious water figures in the analyses as so much elementary water, and renders the quantity of it found in the substance too great, when compared with the other constituents.



## ARTICLE X.

*Answer to Mr. Prevost's Queries respecting the Explanation of Mr. B. Prevost's Experiments on Dew.* By Wm. Charles Wells, M.D. F.R.S.

(To Dr. Thomson.)

SIR,

HAVING seen in the last number of your Journal an indirect application to me by the acute and learned Mr. Prevost, of Geneva, I request permission to inform that Gentleman, through the same channel, that the explanation which he has given, in his work on Radiant Heat, of Mr. Benedict Prevost's observations on dew, is regarded by me as being neither referrible to the whole of them, nor altogether satisfactory with respect even to those to which it applies.

In the first place, he takes no notice whatever of a whole class of Mr. B. Prevost's observations; those, namely, which relate to what happened, when glass vessels partly filled with various substances were exposed by him to the influence of the causes of dew. In these experiments the lower parts of the vessels remained dry, though other parts of them, which were above the level of the contained substances, were covered with dew. The author adds, that the distance between the upper surface of the contained substance, and the part of the vessel at which dew began to appear, varied according to the nature of the substance; it being greater, for example, in a vessel containing mercury, than in another of the same size containing water.

In the second place, Mr. Prevost, of Geneva, supposes dew to form in circumstances, in which, I venture to say, it cannot occur. If a thin plate of a bright metal be fastened to a pane of glass in a window of a room, the air in which is warmer than that without, dew, according to his representation, will be deposited on the outside of this piece of glass, as the metal covering its inside is a screen against the heat, which is radiated towards it by the walls and contents of the warm chamber. Now it is manifest, that the utmost effect which can be produced in this way will not occasion the outside of the glass to be as cold as the external atmosphere; for the metal will admit into itself some part, however small, of the heat which is radiated to it, and will communicate this to the glass, along with that which it acquires at the same time, by conduction, from the contiguous warm air. But, if the outside of the glass be warmer than the air, dew will not form upon it; since, according to my experience, bodies will not receive dew unless they be colder than the air.

I think, Sir, that I need say nothing more in justification of the intention, which I formerly entertained, of offering an explanation of Mr. B. Prevost's observations on dew, though one had already been given of a part of them by Mr. Prevost, of Geneva. Much

of what has been written by this Gentleman upon them seems to me entirely just. But it is nevertheless my opinion, that he could not possibly have explained them completely, so long as he was ignorant that bodies become colder than the air before they are dewed; a fact, I believe, first known to myself, and not published by me until several years after the appearance of his book upon Radiant Heat.

I conclude by mentioning very shortly two other things relating to Mr. Prevost. The first is, that if he had seen my letter to you, which was printed in your Journal last April, he would probably have collected from it the information which he now desires. The second, that I feel strongly the commendation, which has been bestowed upon my meteorological labours by a person of his high rank in philosophy.

I am, Sir, your most obedient humble servant,

London, Nov. 13, 1815.

WILLIAM CHARLES WELLS.

## ARTICLE XI.

*Memoir on Iridium and Osmium, Metals found in the insoluble Residuum of crude Platinum treated by Nitromuriatic Acid.*  
By M. Vauquelin.\*

### FIRST PART.

#### § I. — *History.*

THOUGH what M. Fourcroy and myself have said in the three memoirs which we published on the insoluble residue of crude platinum treated by the acids has explained most of the principal characters of the metals which it contains, and though Mr. Tennant, who examined it after us, has added nothing in this respect to our knowledge, yet by working upon larger quantities than we were able to do at that time, and by increasing the number of experiments, I have been lucky enough to discover some new properties in these metals, to verify some conjectures thrown out in our memoirs, and in some cases to correct mistakes into which we had fallen.

I have been at great pains to endeavour to discover simple processes for obtaining these metals in a state of purity; for it was because one of them had not been obtained in that state that certain properties have been ascribed to it which belong only to a mixture of it with other matters.

Finally, I have constated, with the greatest certainty, the existence of the two metals announced by Mr. Tennant, which Fourcroy and myself had mistaken for modifications of a single species.

\* Translated from the Ann. de Chim. lxxxix. 150, Feb. 1814.

## § II. Analytic Process.

What renders the analysis of the black powder from crude platinum so complicated and difficult, is the great number of substances which it contains. That we may be able to follow the series of operations to which it is necessary to subject it, I think it necessary to point out these substances.

The black powder contains chromium, osmium, iridium, titanium, iron, sand, and even a little alumina.

50 grammes of the black powder well pulverized being mixed with 100 grammes of nitre, I introduced the mixture into a porcelain retort, to which I adapt a tube plunging into lime-water. The retort is gradually heated, and the heat continued till gas ceases to be disengaged.

### *Effects.*

The first effect is the disengagement of a gas, which is probably a mixture of oxygen and azote; the second, a light yellow precipitate in the lime-water through which the gas passes; the third, the formation of a great number of small white crystals in needles in the tube which conducts the gas to the lime-water; the fourth, the disappearance of the precipitate formed in the lime-water, and of the yellow colour of that liquid; the fifth, the disappearance of the crystals contained in the tube. From this period, to that when gas ceases to come over, no further change takes place.

## § III. Examination of the Products of the preceding Operation, and Explanation of the Phenomena.

1. The lime-water through which the gas had passed was become acid. It gave out a strong smell of osmium: accordingly nutgalls gave it immediately an intense blue colour. This proves that the crystals formed in the tube at the commencement of the operation were oxide of osmium, and that these crystals were carried to the lime-water by the hot gas which passed over them continually.

2. The yellow colour which the lime-water assumed at first was owing to its combination with osmium, which the nitrous acid that afterwards came over destroyed.

3. The water which I introduced into the retort to soften the residue assumed a very deep reddish-brown colour. This liquid had not the odour of osmium, as that has which we obtain from the residuum of crude platinum melted with potash. This might lead to the suspicion that the osmium had been entirely volatilized, which, however, is not the case, as we shall see hereafter.

4. When the excess of alkali contained in this liquid is saturated with nitric acid, a green flocky precipitate is formed, composed of iridium, titanium, iron, alumina, and sometimes of a little oxide of chromium. The liquid then assumes the yellow colour of chromate of potash, and gives out a strong smell of osmium, showing that this metal had been in combination with the alkali.

#### § IV. *Saturation and Distillation of the Alkaline Liquid.*

When the black powder communicates no longer to the alkali, either osmium or chromium, the alkaline liquids mixed together are treated in the following way:—

1. The excess of alkali is gradually saturated with nitric acid, taking great care not to add an excess of acid, least a portion of the precipitate should be redissolved. A flocky precipitate of a bottle-green colour appears, the composition of which has been already mentioned; and the liquid, which before had an orange-red colour, assumes that of a pure yellow.

2. The yellow liquid, being filtered, contains only chromate of potash and oxide of osmium. To separate them, a little nitric acid is added to the liquid, to destroy the combination of the potash with the oxide of osmium. It is then distilled till no more osmium comes over. This is easily ascertained, by separating the product from time to time, and observing when it has no smell. To collect the oxide of osmium, which is very volatile, it is necessary to surround the receiver with ice, or at least with cold water frequently renewed.

The liquid obtained is colourless, like water, but easily distinguished by the strong odour which it exhales, and the metallic taste which it possesses.

Sometimes during this distillation there forms at the neck of the retort, and even within the receiver, a black matter, having in certain aspects a coppery lustre. By means of water it may be detached in small brilliant scales. We shall return afterwards to this matter.

#### § V. *Precipitation of the Osmium.*

When we wish to separate the osmium from the water, a little muriatic acid is added, and a plate of zinc introduced. If the quantity of muriatic acid is considerable, we observe a blue substance, which detaches itself from the surface of the zinc in the form of clouds, and which, by dissolving as it spreads through the liquid, communicates a purple tint to the whole. But when the muriatic acid is diminished to a certain point, the liquid assumes a fine indigo-blue colour. The blue matter at last separates from the liquid in the form of flocks, which, when they are united together, appear black, and the liquid becomes colourless as water.

It may happen that the quantity of muriatic acid added is not sufficient to precipitate the whole of the osmium. This will be easily perceived by the effervescence ceasing before the liquid has lost its colour and its smell. In such a case a small additional quantity of acid must be poured in, to keep up a slight effervescence, and to prevent the osmium from attaching itself to the zinc, from which it would be very difficult to separate it afterwards by mechanical means.

The osmium being collected at the bottom of the vessel, the liquid must be carefully drawn off. Water is repeatedly poured upon the metal to wash it thoroughly. It is even proper in the first washings to employ water acidulated with a little sulphuric acid in order to dissolve any particles of zinc which it may contain.

Thus washed, the osmium is pure. It has only to be dried in a gentle heat, and then preserved in close vessels.

§ VI. *Separation of the Chromic Acid from the Residue from which the Osmium was distilled.*

The chromium and osmium being dissolved in the same liquid, but the one being fixed and the other volatile, we had recourse to heat to separate them from each other. The chromium of course remains in the residue combined with potash. To obtain this metal, the liquid is poured out of the retort, evaporated to dryness in a capsule, redissolved in water, and filtered, to separate any silica which it may contain.

Then proutrate of mercury is poured into the solution. A red precipitate falls, which is prochlorate of mercury. This precipitate is washed with a great deal of water. It is then dried, and calcined in a crucible, to obtain the green oxide of chromium.

When in our first experiments we employed potash to decompose the black powder from platinum, we were obliged to recommence the operation four or five times, in order to dissolve all the chromium and the osmium. But when nitrate of potash, in the proportion of two parts of the salt to one of the powder, is employed for the purpose, two operations are sufficient, because the oxygen contained in this salt is sufficient to oxidate the two metals; and the potash which becomes free is capable of dissolving them. I therefore recommend nitre instead of potash in this operation.

§ VII. *Treatment of the Black Powder from which the Chromium and Osmium have been separated by Muriatic Acid.*

After having well washed the black powder from platinum treated with nitre, a little of it is put into muriatic acid diluted with its bulk of water. If this mixture, when heated a little, gives out the smell of osmium, the powder must be treated again with half its weight of nitre, following the same process as before.

The residue, which has a bluish-black colour, is now to be digested in moderately concentrated muriatic acid. An action immediately takes place, which is announced by the elevation of the temperature of the mixture, and by the green colour which the liquid acquires.

Sometimes during this operation the smell of oxymuriatic acid is perceived, and a small quantity of it seems to be formed; for having heated the mixture in a retort furnished with a receiver, I obtained a liquid, which speedily destroyed the tincture of litmus.

When the acid in excess has remained for some days on the

black matter, and appears to act no further, it is decanted off, and the residue is washed with water, which is added to the first solution.

The liquid, though diluted with a great quantity of water, has a green colour, so deep that it intercepts the passage of light, unless it be in a very thin layer.

If, notwithstanding the precaution indicated above, this solution still gives out the smell of osmium, it must be put into a retort, and subjected to distillation. The osmium will be obtained in the water that comes over acidulated with muriatic acid. From this it is to be precipitated by a plate of zinc in the manner described above. While this liquid is kept boiling, in order to disengage its osmium, it deposits a great quantity of matter of a bottle-green colour, and the liquid assumes a very deep reddish-brown colour.

This green matter is separated by the filter, and washed with a great deal of hot water. I shall denote it by the letter B.

Black powder treated only once with two parts of nitre does not dissolve entirely in muriatic acid, however great a quantity of it we employ. There remains always at least  $\frac{1}{2}$  under the form of a bluish powder, containing white brittle metallic grains. This metallic residue, indeed, may be dissolved by boiling it for a long time in very strong nitromuriatic acid; but the process is long and expensive. The labour is greatly abbreviated by treating it with its own weight of nitre and heat. Then the matter oxidizing by means of the salt combines with the potash set at liberty, and then dissolves in muriatic acid, communicating to it a fine blue colour.

If there still remain some portions of matter which refuse to dissolve in muriatic acid, we must treat them again with nitre; and this process must be repeated till the whole be dissolved.

#### § VIII. *Examination and Properties of the above Muriatic Solutions.*

When the black powder from platinum is thus treated alternately with nitre and muriatic acid, after having separated the chromium and osmium, we observe that the first muriatic solution is of a yellowish-green colour; the second, of a bluish-green; the third, of a greenish-blue; and all the subsequent ones blue. We observe, likewise, that the last mixtures of the powder with nitre communicate to the water employed to wash it a colour equally blue.

On examining the different solutions, I found that the first contained a good deal of iron and titanium, and but little iridium. In the second there was less iron and titanium, and more iridium. In the third, still less iron, and very little titanium; but some traces of iron were always to be observed, even to the very last solution.

These effects are easily conceived, when we reflect that the first solution ought to contain all the iron coming from the chromate, and all the titanium the union of which with that metal has been de-

stroyed by the alkali of the nitre, while the last solutions contain only the iron that was united with the iridium.

From this it follows, that if we divide into three equal portions the quantity of muriatic acid necessary to dissolve the black powder, and if the first portion is sufficient to dissolve all the iron, the colour of the first solution will be yellow; of the second, blue, with a shade of green; and of the third, pure blue; supposing that we have carefully washed the residue after each portion of acid has acted on it.

This shows that the green colour of the first solution is not simple, but composed of iron, which gives a yellow and a blue matter, which, by mixing with the yellow, produces a green. This proves likewise that the iron dissolves the first; and that probably, if we were to pour on the black powder only the quantity of acid necessary to dissolve the iron, this metal almost alone would be dissolved.

Yet I must acknowledge, that though I applied the acid to the black powder in a great number of doses, I always found iron, though in small quantity indeed, even in the last solutions.

Before explaining the method which I followed in analyzing the different solutions of the black powder in muriatic acid, and in separating the iridium from them, I think I ought to point out the phenomena which they presented with certain re-actives with which I mixed them.

1. The first solution, or that which contains the most iron, and which of consequence is of a yellowish-green colour, gives with ammonia a bottle-green precipitate, and the liquid remains colourless. But if oxymuriatic acid be introduced into the filtered liquid, it assumes a fine red colour, a phenomenon which, showing that some metallic body remains in the liquid, will enable us immediately to explain several interesting facts.

2. Sulphate of iron and sulphureted hydrogen deprive this liquid almost entirely of its colour, especially if it be diluted with water.

3. If into the solution thus deprived of its colour by sulphate of iron and sulphureted hydrogen, oxymuriatic acid be put, it assumes a green colour, and then becomes violet-red, if the acid be in sufficient quantity.

4. The solution rendered violet-red by oxymuriatic acid being exposed to the air recovers its green colour in proportion as the acid evaporates.

5. The heat of boiling continued for some time produces in this solution a bottle-green precipitate (which we have denoted by the letter B), and changes its colour to a very deep red. The precipitate which ammonia afterwards forms in this liquid is red, and contains only iron.

6. If after having separated the precipitate which falls when the liquid is kept boiling, we evaporate the whole to the consistence of a syrup, it furnishes; on cooling, tetrahedral crystals of a black



salt, so deep as to be easily mistaken for charcoal in powder. On examining this salt, I found it a muriate of iridium-and-potash, of which I shall speak in another article.

7. If the solution which has thus yielded crystals be diluted with four or five times its bulk of water, if the iron be precipitated by ammonia, and the precipitate well washed, we find in it no trace of iridium. Yet the liquid is not coloured, nor does it become coloured by concentration, and the sal-ammoniac which it yields is white. One would suppose, then, that it contained nothing metallic. But if oxymuriatic acid be mixed with this liquid concentrated, it immediately assumes a red colour; and if we drive off the sal-ammoniac which it furnishes, it leaves a black powder, which is metallic iridium.

The second muriatic solution of the black powder from platinum, or that which has a greenish-blue colour, presents in general the same properties as the preceding; but all the qualities indicating iron are less distinct in it, while those indicating iridium are more so.

Thus the precipitate formed in it by alkalies is less abundant, and of a colour more inclining to blue. The diminution of colour produced in it by sulphate of iron and sulphureted hydrogen is much more complete. The red colour which it acquires by heat and oxymuriatic acid is much more pure.

The third solution, which is of a pure blue, exhibits still more distinctly the phenomena depending on the presence of iridium, while those depending on iron become always feebler.

If we pour some of that last solution into a solution of potash, taking care to have an excess of alkali, a light yellow precipitate is formed, and the liquid assumes a pure blue colour. The precipitate is occasioned by the oxide of iron, and the blue colour of the alkaline solution by the oxide of iridium. Hence it follows that if the solution of iridium was pure, it would not be precipitated by an excess of potash. This will be confirmed hereafter.

### § IX. Examination of the Precipitate B.

A portion of this matter put into muriatic acid while yet moist was speedily dissolved. The solution, which had a very intense bottle-green colour, was put to the following trials.

1. It was precipitated in green flocks by the alkalies.
2. Sulphureted hydrogen immediately deprived it of its green colour, and gave it a slight fawn colour. Some drops of alkali let fall into the liquid thus discoloured throw down green flocks, as if no sulphureted hydrogen had been used.
3. Infusion of galls destroys the green colour, and produces a brown.
4. The prussiate of potash, without occasioning a precipitate, renders the green colour more intense, giving it a slight shade of blue, which indicates the presence of iron.
5. When the solution of this substance is heated, it exhales an

odour similar to that of oxymuriatic acid, and at the same time assumes a red colour. As this production of oxymuriatic acid may serve to explain the change of the colour of the solution from green to red, a quantity of it was put into a retort furnished with a receiver, and heated till it acquired a reddish-brown colour.

The product obtained had the smell of oxymuriatic acid, and destroyed the colour of litmus, so that it could not be restored by the alkalies.

Thus the discolouration of the green liquid by sulphureted hydrogen and the sulphate of iron, and its change into violet-red by oxymuriatic acid, seems to announce that the metal is in a mean state of oxidation when it is blue, and that it descends to a minimum when it passes to white. It is not probable that the production of the oxymuriatic acid of which we have spoken is the effect of the change of the blue colour into red, since, on the contrary, this last is changed into violet-red by the addition of oxymuriatic acid. In fact, the blue liquid discoloured by sulphate of iron, by sulphureted hydrogen, by a plate of zinc, or by any other body, passes at once into blue by the addition of a small quantity of oxymuriatic acid. This seems to leave no doubt that the most oxygenated state of this substance is that which exists in the red solution.

Such are the properties of the bottle-green substance, precipitated during boiling from the first muriatic solution of the black powder from platinum, previously treated with nitre.

50 grammes of the black powder furnished 10 grammes of this bottle-green precipitate. After washing and calcination, it had a black colour, a smooth and brilliant fracture, like that of glass: then, though well pounded, it dissolved no longer entirely in muriatic acid. Of these 10 grammes, which were boiled with five parts of nitro-muriatic acid, 2.6 grammes only were dissolved, and 7.4 grammes remained under the form of a greenish-brown powder. This matter, being dried, and pulverized again, was subjected a second time to the action of a great quantity of nitro-muriatic acid, without dissolving. It had merely communicated to the acid a reddish-brown colour. The solutions, being united and concentrated by evaporation, did not furnish crystals; but muriate of ammonia being added to it, a black salt was obtained, similar to the one mentioned before, and which is an ammoniaco-muriate of iridium. If when these solutions yield no more of the salt by concentration, we dilute them with water, and add to them a sufficient quantity of ammonia to saturate all the acid, a precipitate falls, which has all the appearance of oxide of iron, and which in reality contains nothing else, except a little oxide of titanium and silica.

The liquid from which this precipitate has been separated is colourless, though it still contains ammoniaco-muriate of iridium, as is shown by the red colour produced in it by oxymuriatic acid.

Our precipitate being no longer acted upon by acids, I treated it with twice its weight of caustic potash, which rendered it soluble in muriatic acid. The solution was yellow, and presented all the pro-

properties of muriate of titanium mixed with a minute quantity of iron.

Thus the precipitate under examination is composed of iridium, iron, titanium, and silica.

It follows from this that though the liquid from which these different substances come was sensibly acid, a portion of the iron, most of the titanium and iridium at a medium point of oxidation are precipitated by means of heat. It is to be presumed that the titanium, the solutions of which are decomposed by heat, is the cause of the precipitation of the iron and iridium, which would not take place with either of them separately. These bodies seem to exert a reciprocal action on each other, which produces a compound insoluble at least in a weak acid.

Now that we know the nature of the substances contained in the muriatic acid solutions, and the way in which they are acted on by re-actives, we can trace with more accuracy the method that must be followed in order to extract the iridium in a state of purity, which is our principal object.

We have remarked that iridium, when in the state in which it gives red solutions, is no longer precipitated by heat, even when assisted by the action of titanium, nor by the alkalis, from its solutions when sufficiently diluted: that it is precipitated in the state of a triple salt by sal-ammoniac when its solutions are concentrated.

We must therefore bring iridium into this state, by adding to the solution a certain quantity of nitric acid, and boiling the mixture for a long time. When the greatest part of the superabundant acid is dissipated, the solution is diluted with a considerable quantity of water, and the quantity of ammonia is added necessary to bring the liquid nearly to a neutral state. When the liquid is now boiled, a precipitate falls, consisting chiefly of oxide of titanium with a little iron, without any mixture of iridium, if the precipitate be properly washed. The liquid, now containing only iridium and iron, is concentrated and mixed with sal-ammoniac. A black crystalline precipitate of ammoniaco-muriate of iridium falls, from which the supernatant liquid is separated by decantation. When the concentrated liquid furnishes no more salt, it is diluted with water, the iron is precipitated by ammonia, the precipitate washed with hot water, and the liquids evaporated to dryness. The residual salt being exposed to a red heat, leaves very pure iridium in the metallic state.

The ammonio-muriate of iridium being obtained in a state of purity, we have only to heat it to redness in a covered crucible in order to obtain metallic iridium in a state of powder. I ought to observe, however, that the salt of which I have just spoken containing always a small quantity of muriate of potash, the metal which it furnishes requires to be washed in boiling water before it is pure.

This muriate of potash comes from a small quantity of potash

which remains combined with the iridium and titanium after treating the black powder with nitre, and which washing with water has not been able to separate.

§ X. *Experiments on the Black Powder obtained by Washing from the Residue of Platinum.*

If we agitate in water the insoluble residue of platinum treated with nitro-muriatic acid, and decant off the liquid after an interval of a few seconds, we obtain by deposition from the liquid a brilliant black substance, soft to the touch, and staining paper like plumbago.

By repeating this process a great number of times, we deprive the residue almost entirely of this substance. What then remains is a brown coarse sand, harsh to the feel, and which does not stain paper. It is almost entirely composed of chromate of iron, oxide of titanium, quartz, and still retains a little of the brilliant matter; for it is easy to see that by this mechanical method we cannot completely separate the elements which compose the residue of platinum. Accordingly in the brilliant powder there is still a small quantity of chromate of iron, quartz, and oxide of titanium in the state of a finer powder.

I have already given the analysis of the coarse portion, and mean here to speak of the lightest and most brilliant part.

I treated 20 grammes of this powder in a porcelain retort with 40 grammes of nitre, in the way already described.

The water through which the gas was made to pass gave out a strong smell of osmium.

The washings of the matter thus treated showed other properties than those which we observed in the other powder. Instead of being yellowish-green, they were violet-red.

When the alkali was saturated with nitric acid, a reddish-brown precipitate fell, and the liquid, after the separation of this precipitate, was reddish-purple, instead of being yellow, as was the case with the coarse powder.

I distilled this liquid in order to separate from it the osmium, of which it contained a great deal. The residue of the distillation contained no sensible quantity of chromic acid, while the coarse powder furnished this acid in this solution alone. This shows that by the washing the chromate of iron was almost completely removed.

*Examination of the Precipitate formed in the Alkaline Liquid by Nitric Acid.*

This precipitate, being washed, and put into muriatic acid while still moist, dissolved entirely, communicating a very strong smell of osmium. By distilling the liquid, I obtained a considerable quantity of this metal.

This seems to prove that the osmium may be dissolved by the alkali in a state of oxidation different from that in which it is soluble

in water; for the matter from which it was extracted had been sufficiently washed. It is possible, indeed, that this oxide may form with the other matters contained in the precipitate a combination which renders it insoluble in water.

After having separated the osmium, I poured into the concentrated liquid sal-ammoniac, to form ammoniaco-muriate of iridium, which precipitated in the state of a black powder. The liquid, being evaporated to dryness, and the residue digested in water, I obtained a small additional quantity of the same salt mixed with silica. The solution had then a fine green colour of chromium, which neither sulphate of iron nor sulphureted hydrogen destroyed. It could not, therefore, be ascribed to iridium.

To discover what substance produced that colour, I poured ammonia into the solution, which threw down a brownish-green precipitate, and the liquid, though containing an excess of alkali, was colourless.

This precipitate, when fused with borax, communicated to it a fine green colour. When heated with potash, the mixture, being washed, gave a yellow liquid, possessing the properties of chromate of potash, and a little oxide of iron remained behind.

Hence the precipitate is composed of

1. Oxide of iridium.
2. ————— osmium.
3. ————— chromium.
4. ————— iron.
5. Silica.

The second water which I poured on the black powder treated by nitre did not become clear like the first. It was of a milky-green colour. Nitric acid poured into this liquid formed a precipitate in it, as in the first water; but it was more flocculent, and of a blackish-green colour. It was composed of oxide of iridium, silica, and titanium.

Water producing no more effect, I put upon the matter a small quantity of weak muriatic acid. It acquired no colour, but separated a light flocky substance, very distinct from the powder itself, which, falling quickly to the bottom in consequence of its weight, enabled me easily to separate the flocky part. It was composed of oxide of iridium, silica in great abundance, titanium, and iron.

I distilled the liquid to separate the osmium, of which it had a strong smell. I poured, for the second time, upon the powder, a considerable quantity of diluted muriatic acid. The acid assumed a violet colour, which it would have been difficult to have distinguished by the eye from a strong infusion of the flowers of violets. This second portion of acid was succeeded by a third portion of concentrated acid, which remained upon the matter for 15 hours.

The acid had a very deep and pure blue colour; but, notwithstanding its great quantity, and its concentration, all the matter was not dissolved.

I observed that at the moment I poured the concentrated muriatic acid upon the powder an effervescence was produced, accompanied by a kind of noise, and that the mixture exhaled very distinctly the odour of oxymuriatic acid.

When the muriatic acid had no further action on the black powder, I boiled it for a long time in a great quantity of nitro-muriatic acid: that solution took place, was announced by the very deep colour which the liquid assumed.

The residue, being now washed and dried, weighed only 3·2 grammes. I fused it with twice its weight of potash in a silver crucible.

The mass being dissolved in hot water communicated to it a fine blue colour. The undissolved portion was treated with muriatic acid, which dissipated a part of it, and assumed likewise a blue colour with a tint of violet.

By repeated treatments with potash and muriatic acid the whole of the black matter was at last dissolved.

I mixed together all the alkaline solutions, and after having saturated them with muriatic acid, I evaporated, in order to obtain by crystallization the muriate of iridium-and-potash.

I mixed together likewise all the acid solutions, concentrated them, and when they yielded no more muriate of iridium-and-potash, I added ammonia, in order to convert the muriate of iridium, still held in solution, into ammoniaco-muriate of iridium.

We see by the above statement, that the black powder obtained by repeated washings from the insoluble residue of crude platinum, is composed of a great quantity of iridium and osmium; that it scarcely contains any chromium, and much less titanium and iron, than the black powder which we subjected to the first analysis.

#### PART SECOND.

##### § I. *Properties of Iridium.*

The name iridium, given to this metal by Mr. Tennant, is derived from the various colours which it presents in its solutions, and which M. Fourcroy and I first made known.

But in the metallic state the colour of iridium is greyish-white, nearly like that of platinum. It appears to be brittle, and consequently hard.

I cannot give its specific gravity, because I have not yet been able to melt it completely.

It is not attacked by the simple acids, and only with great difficulty by the most concentrated nitro-muriatic acid.

Potash and nitre convert it into an oxide and then combine with it. A black powder is produced, which, being put into water, communicates to it a fine blue colour. It is a portion of the metal dissolved in the excess of alkali which produces this colour; but the portion insoluble in water is still a combination of the metal with alkali; for it is soluble in muriatic acid, to which it gives a



blue colour, and its solution furnishes, by evaporation, a black salt, which is a muriate of iridium-and-potash. Sometimes the alkaline solution of iridium is purple, because a portion of the metal has passed to a red colour, and has dissolved in the alkali at the same time with the blue portion.

Thus the fixed alkalies have a greater action on this metal than the strongest acids.

It is doubtful whether we can obtain a blue solution of iridium in the acids without the assistance of potash; for to dissolve it we must in that case employ boiling nitro-muriatic acid, and then we constantly obtain a red solution.

The red muriatic solution of iridium, sufficiently concentrated, is entirely converted by means of ammonia, in a triple salt of a purple colour so deep, that it appears black like charcoal powder.

If into 50 parts of the solution of pure platinum we put one part of concentrated muriate of iridium, and afterwards add sal ammoniac, we obtain a brick-red precipitate, instead of the lemon-yellow precipitate which pure platinum gives.

There can be no doubt then that it is iridium, as we have before remarked, which gives a red colour, sometimes very intense, to the ammoniaco-muriate of platinum, obtained from the last portions of crude platinum.

The ammoniaco-muriate of iridium crystallized and well dried, being exposed to heat in a distilling vessel, gives out azotic gas, muriatic acid, sal ammoniac, and leaves for residue 45 per cent. of its weight of pure metal. The azotic gas, which comes over, shows that part of the ammonia is decomposed.

This salt is very little soluble in cold water. At the temperature of  $57^{\circ}$ , 20 parts of water are required to dissolve one part of ammonio-muriate of iridium.

The solution of the salt has an orange-red colour, very intense, considering the small quantity of salt which it contains.

Five centigrammes (0.772 grain) were sufficient to give a very distinct colour to two litres (122.056 cubic inches) of water. Hence it follows, that one part is capable of colouring 40,000 parts of water: a property which is extraordinary for a metallic salt. The muriate of rhodium, which possesses this colour in a high degree, is, notwithstanding, four times less colouring than the muriate of iridium.

Ammonia discolours the solution of this salt in a few minutes, without, however, producing a precipitate in it.

The green sulphate of iron discolours it instantly, and renders it white like water.

Sulphureted hydrogen, iron, zinc, and tin in the metallic state, produce the same effect as the sulphate of iron; but if oxymuriatic acid be put into the liquids thus discoloured, they immediately assume their natural colour.

When we heat the ammoniaco-muriate of iridium, by means of the blow pipe, upon charcoal, it burns with a yellow flame and a



kind of fulguration, It leaves a porous metallic mass of a grey colour, but which assumes a white colour, and a strong lustre, when rubbed between two hard bodies. This colour and lustre strongly resemble those of platinum.

We have seen by what has been said, that iridium, according to the state of its oxidation, gives, when it combines with muriatic acid, a yellowish red colour.

I have endeavoured to ascertain if these two colours were due to two states of oxidation, as we thought before, and, in that case, which of the two contains most oxygen. The experiments which I have made leave me in my former opinion; but they only furnish probabilities respecting the quantity of oxygen existing in these oxides.

All the information they have given is; 1. That we cannot obtain the blue solution of iridium in acids, without having first treated this metal with potash or nitre. 2. That these blue solutions become yellowish red when long boiled; and, as the change takes place gradually, we can perceive, if we pay attention to it, the shade becoming first green, then violet purple, and finally yellowish red. 3. That the blue solutions are not precipitated in the state of triple salts by the alkalies, either fixed or volatile. 4. That the blue solutions become red when sufficiently diluted; but still are not precipitated by the alkalies, and when sufficiently concentrated, give a black triple salt, soluble in twenty parts of water. There is then a difference in the state of the iridium in these solutions, since the one forms triple salts but little soluble, and the other salts which are very soluble.

If the blue and red solutions be equally discoloured by the combustible bodies of which we have spoken above, oxymuriatic acid restores to each of them its primitive colour; but if, after restoring the blue colour, we add a new quantity of oxymuriatic acid, that colour passes into a purple red.

If we suppose that these two solutions are reduced to the same state of oxidation by the combustible substances, the sulphate of iron for example, we must see it, when we mix with it oxymuriatic acid, pass through the same shades to arrive at the maximum, which does not happen. The blue becomes blue without intermediate shade, and the red becomes immediately red without passing through blue. The purple red colour, which oxymuriatic acid in excess gives to the blue liquid, does not appear to change the state of the oxidation of the metal; for it is sufficient to leave this solution for some time in the air, to enable it to resume its blue colour, in proportion as the oxymuriatic acid exhales. Thus, though there is an obvious difference between the oxide of iridium in the blue and in the red solutions, I am obliged to acknowledge my ignorance of the relative quantity of oxygen in each. I presume, merely, that the red contains more oxygen than the blue.

We have said above that the blue solution of iridium is not precipitated by alkalies. This is true when the solution is pure; but

if it contain either iron, or titanium, or silica, or alumina, the blue oxide precipitates in a proportion relative to that of the substance which is the determining cause of the precipitation.

If it is oxide of iron or of titanium which is mixed with the solution of iridium, the precipitate formed by the alkalies is green; but if it is merely silica or alumina, the precipitate is blue, with a shade of violet. That which is obtained by barytes is green. There can be no doubt that the precipitation is brought about by the action of these bodies on the oxide of iridium. The following experiment seems to me very good, as a demonstration of this. I mixed with a blue solution of iridium a small quantity of sulphate of alumina, and then added an excess of ammonia. A deep coloured precipitate fell; but the liquid continued still more intensely coloured. The addition of a greater quantity of sulphate of alumina entirely discoloured it. These precipitates of alumina and oxide of iridium cannot be deprived of their colour by repeated washings in boiling water.

This great affinity of alumina for blue oxide of iridium, and the violet blue colour of the compound, gave me a strong suspicion that iridium is the colouring matter of the Oriental sapphire. This metal might have escaped so much the more easily from the chemists who analyzed that stone, as not more than a thousandth part of it would be wanting to form the deepest shade known in the sapphire. If this substance were common, it would perhaps be possible to make a beautiful blue colour of it for painters.

Oxymuriatic acid decomposes ammoniaco-muriate of iridium. We have only to pass the acid gas into a vessel containing the salt mixed with water. The salt disappears, and a gas is disengaged in bubbles, in proportion as the solution takes place. When the solution is complete, and when no more gas is given out even by the assistance of heat, ammonia is no longer found in the solution. At least no triple salt is obtained by condensing the liquid, and no ammonia is disengaged when the liquid is mixed with potash and distilled. We obtain merely a triple salt of iridium and potash. We may then by this operation obtain pure muriate of iridium. It has a yellowish red colour.

#### *Muriate of Iridium and Potash.*

This salt is always formed when a solution of muriate of potash is mixed with a solution of iridium; or when after exposing a mixture of iridium and potash to a red heat, the compound is dissolved in muriatic acid.

This salt has a purple colour so intense, that it appears black; but we may satisfy ourselves that it is really purple, by rubbing it upon a sheet of white paper. Though this salt, which is very little soluble in water, gives but very small crystals, yet I have ascertained that they have a very distinct octohedral shape.

A hundred parts of these crystals being long exposed to a red heat, decrepitated, and were reduced to fifty parts. They had the

form of a black powder; but it was not pure iridium. It was mixed with a certain quantity of muriate of potash, as was obvious from the taste.

This residue, being repeatedly washed with hot water, and dried, was reduced to 37 parts.

If we were certain that no muriate of potash was dissipated during the calcination, we should have from the preceding experiment two elements of the salt; namely, the metal and the muriate of potash. This metal would be to the muriate of potash as 37 : 13, or as 3 : 1. It would be only necessary after this to know the quantity of water and muriatic acid which were disengaged during the process to know that of the oxygen.

### § II. *Sulphuration of Iridium.*

A hundred parts of the ammoniaco-muriate of iridium, mixed with as much sulphur, and gradually heated to redness in a retort, furnished 60 parts of a black agglutinated powder, which burnt, when heated, like the metallic sulphurets.

We have seen above that 100 of this salt furnish from 42 to 45 of metal. They would then have absorbed 15 of sulphur, supposing the last result the most accurate. But it is evident, that if 45 absorb 15, 100 will absorb 33·3.

Mr. Tennant says, that he could not unite sulphur to iridium. Probably because he attempted the direct combination; but the case is different when we employ its triple ammoniacal salt.

### § III. *Alloys of Iridium with some other Metals.*

*Lead and Iridium.*—Eight parts of lead and one part of iridium, heated on charcoal by means of the blow pipe, united as soon as the lead became white hot.

The ductility of the lead was not destroyed by this quantity of iridium; but its hardness and whiteness had been very sensibly increased. This alloy is attacked by nitric acid, which dissolves the lead, and leaves the iridium in the state of a black powder.

*Copper and Iridium.*—Four parts of copper and one of iridium united as soon as the copper was white hot. The alloy is ductile; but much harder than pure copper. The colour is pale red, appearing white under the file. It was acted on by nitric acid in the same way as the alloy of iridium and lead. The copper dissolved, and the iridium remained; yet the acid appeared to have dissolved some particles of it, as the colour of the solution, instead of being blue, was green.

*Tin and Iridium.*—Four parts of tin and one of iridium give a dull white alloy, easily crystallized, hard, but malleable. The iridium does not combine with the tin till the latter is white hot.

*Silver and Iridium.*—Two parts of fine silver and one of iridium, heated like the others before the blow pipe, did not unite completely, probably because there was too great a quantity of iridium.

I endeavoured to bring about the combination, by means of the

blow pipe with oxygen gas. This enabled me to observe a very interesting phenomenon, the volatilization of the silver.

There rose during the operation a very copious yellowish white fume, and the flame from the charcoal formed a cone, the base of which was coloured yellow, the middle purple, and the summit blue. In a short time nothing but the pure iridium remained upon the charcoal.

This phenomenon, of which I had not before seen so remarkable an example, led me to wish to subject silver alone to the same trial.

I therefore placed four grains of this metal in a hole dug in charcoal, and heating by means of a current of oxygen gas, in less than a minute the whole was dissipated. During this operation, a portion of the smoke exhaled was collected in a glass vessel reversed above it. It formed a yellowish brown crust, which dissolved in a great measure in weak and cold nitric acid. This nitric acid was then abundantly precipitated by a solution of common salt. The greatest part of the silver burns when thus volatilized. At least the yellow colour of the flame, that of the condensed fumes, and their dissolving cold in dilute nitric acid, seems to prove it.

Chemists, assayers, and founders know that silver is volatile; but I am persuaded that they are far from thinking that it possesses this property in so great a degree. This ought to be attended to by all who refine and melt silver.

The malleability of all the alloys of iridium leads to the idea that this metal would not be brittle if its parts could be united by fusion, or at least that certain brittle metals do not much diminish the malleability of those with which they are capable of uniting. Certainly tin united to copper in the same proportion as the iridium produces a great change on its properties.\*

Mr. Tennant has remarked, that iridium does not change the colour nor the malleability of gold and silver, and that it was not possible to separate it from these bodies by the ordinary methods. This might easily have been seen beforehand, in consequence of the properties which it possesses.

The specific characters of iridium are then: 1. A greyish white colour. 2. Very difficult to fuse. 3. It forms blue, purple, yellowish red solutions in acids and alkalies, according to the state of its oxidation. 4. It is not acted upon by the ordinary acids, and even very little by nitro-muriatic acid. 5. It forms triple salts of a black colour, and very little soluble with potash and ammonia, when in solution in acids in the state of red oxide.

### THIRD PART.

#### § I. *Properties of Osmium.*

Osmium has received its name from the strong smell which its

\* Since the reading of this paper, having succeeded in fusing a certain quantity of iridium, I have found that it possesses some ductility.

oxide exhales; a property which Fourcroy and I made known in February 1804.

This metal being volatile, or rather oxidating very easily at a low temperature, it has not been possible to fuse it, and, consequently, to know its colour and its specific gravity.

As to its colour, if we can judge from some appearances, I conceive that it is blue. The following are these appearances. The instant that osmium is precipitated by zinc from its solution, the liquid assumes a purple tint, which becomes soon the finest blue. This blue matter at last separates from the liquid, and precipitates in a powder which appears black.

When we heat osmium thus precipitated from zinc, and washed and dried, we obtain, as we shall see hereafter, white oxide, which is volatilized into the neck of the retort, where it crystallizes; then a light crust of matter, which is blue by reflected light, and green by refracted. The portion not volatilized appears black. Yet it is possible that the blue colour does not belong to the metal itself, but to a suboxide.

Osmium, which has been heated in a retort, takes, when rubbed against a hard and polished body, a surface of a copper-red, like indigo rubbed.

As we have not been able to obtain osmium hitherto, except in a fine powder, it appears to us light; but if it could be melted, it would perhaps be as heavy as some of the metals known before it.

We have no experiments which show that osmium is volatile; because the little of it which we have hitherto possessed has only enabled us to heat it in glass vessels not capable of bearing much heat without melting. But it is probable that in a higher temperature it would be volatile; for we have not hitherto any examples of metals furnishing volatile oxides, which are not volatile themselves. The blue sublimate which forms in the upper part of vessels in which osmium is heated, strengthens this probability.

When we heat osmium in contact of air, it soon disappears entirely; but we ought not to consider this phenomenon as a simple volatilization of the metal. It is a true combustion, easily distinguished by the suffocating odour of oxide of osmium diffused in the air.

I exposed to heat a gramme of osmium in a luted retort, the capacity of which was about 12 cubic inches, and which terminated in a tube plunged into water, in order to collect the vapours which should not condense.

The bottom of the retort was not red-hot, before very beautiful white brilliant crystals were deposited in the neck of the vessel. Some time after, and in proportion as the heat increased, a blue crust was deposited on the upper part of the retort.

The formation of these matters, and especially of the first, soon ceased; because the contact of air was necessary for it, which soon failed in so small a vessel. The apparatus being cold, the neck of the retort was cut near the white crystals, in order to collect them

more readily. The air of the retort was so impregnated with the vapour of this metal that it almost suffocated me.

The crystals themselves had an odour so strong, that it was impossible to breathe near them without a feeling of pain.

The osmium which had not been volatilized gave out likewise a very striking odour; but I suppose that it owed this property to a portion of the air impregnated with oxide, which it had imbibed during the cooling. This residue only weighed 0·35 gramme, and the quantity of osmium sublimed was far from completing the gramme of osmium employed; because a portion of it had passed into the water of the receiver, being carried hither by the air.

From the result of this operation it appears that oxide of osmium is formed only in proportion to the quantity of air in contact with it. This is conformable to what we know of the oxidation of the other metals.

Yet I am induced to believe that the white oxide formed in this case is not entirely owing to the air of the vessel; for it is formed and volatilized at a temperature so low, that we can hardly conceive how the combination should take place.

I am rather disposed to believe that the osmium as it is precipitated by zinc, still retains a small quantity of oxygen, which when assisted by a gentle heat, unites itself to a portion of the metal and renders it more volatile.

The following observation seems to confirm this idea. When the osmium is precipitated from its solution by means of zinc, and washed several times with water, even acidulated with sulphuric acid, it exhales no odour, as long as it is cold; but if it be exposed to a heat of from  $97^{\circ}$  to  $104^{\circ}$ , it exhales the odour during some time.

But the strongest proof is, that osmium which has furnished oxide by distillation, does not furnish any more at the same temperature, although the same quantity of air be present.

### § II. *Examination of the Oxide of Osmium.*

This oxide is white, transparent, and very brilliant; its taste very strong and caustic, has some analogy with that of the volatile oils, and particularly with that of oil of cloves. Its odour is equally insupportable. It is more fusible than wax; flexible like it, and exceedingly volatile. When placed in contact with animal or vegetable bodies, it blackens them, especially if it be moist. It is very soluble in water, and the solution becomes blue by nutgalls and many other vegetable substances.

### § III. *Action of Oxymuriatic Acid.*

Into a flagon containing about half a litre (30·5 cubic inches) into which I had put a gramme of osmium, I passed oxymuriatic acid gas, the surplus of which was received in a solution of potash. Soon after the osmium came in contact with the gas, it appeared



to melt, assuming a very beautiful and intense green colour. At last it dissolved entirely, and formed a small quantity of a brownish-red liquid. The solution of potash assumed a yellow colour, and an odour of osmium mixed with that of oxymuriatic acid.

When I opened the flagon containing the solution of which I have just spoken, there issued out a dense white vapour, having an insupportable odour of osmium and oxymuriatic acid. To be able to separate this liquid from the flagon without losing much of it, I mixed it with a quantity of water, and subjected it to the following experiments.

1. A drop or two of this solution let fall into a glass of water, assumed a very deep blue colour on adding infusion of nutgalls.

2. When a plate of zinc was put into the solution, it soon passed to blue, and black flocks precipitated.

I may remark, that the green colour analogous to that of oxide of chromium, which the osmium assumed at the instant of its solution, may proceed from a mixture of the liquid, which is reddish-yellow, with a portion of the metal which I suppose to be blue. And, in fact, in proportion as the solution goes on, the green colour becomes weaker and disappears entirely, to give place to reddish-yellow.

When osmium is mixed with water, in order to be dissolved in oxymuriatic acid, it does not become green; but forms at once a yellowish-red liquid.

If ammonia be put into this solution till the acid is saturated, a brown precipitate in flocks falls down, small in quantity, and the liquid passes to a pure yellow, preserving the odour peculiar to osmium.

This precipitate consists almost entirely of iron, coming no doubt from the zinc.

#### *Action of common Muriatic Acid and Osmium.*

Osmium dissolves in muriatic acid when assisted by a gentle heat. The solution begins by being green; but it soon becomes reddish-yellow. If to the muriatic acid we add some drops of nitric acid, the solution takes place more readily, so that we scarcely perceive the transition from green to reddish-yellow.

During these solutions a great deal of osmium is always volatilized, even when they are made without the assistance of heat, as is shown by the experiment with oxymuriatic acid.

At the request of Sir H. Davy, I endeavoured, but in vain, to unite osmium with iodine. When the mixture of the two bodies was heated in a glass tube, the iodine separated in the form of violet vapours, which attached themselves to the upper parts of the tube, while the osmium remained at the bottom without having undergone any change.

The facility with which osmium dissolves in acids, is, I conceive, a certain proof that in crude platinum it is united to some substance



which protects it from the action of these menstrua. This substance can only be iridium, since it is it which resists solution most obstinately.

The combination of the oxide of osmium with the alkalies, dissolved in water, has a yellow colour.

Though the oxide of osmium does not present acid characters, yet it appears that it combines with the alkalies, and that it is in some measure fixed by this combination. In fact, if it were not so, this metal would escape entirely when the black powder is treated in crucibles with potash or nitre at a red heat.

What gives a certain degree of force to this opinion is, that the addition of any alkali whatever to the aqueous solution of osmium very much diminishes the odour, which again becomes powerful, when the alkali is neutralized by an acid.

The small quantity of osmium which I have been hitherto able to procure, and its great oxidability, have not enabled me to examine if it would unite with sulphur, phosphorus, and the other metals; but these combinations never can be any thing else than mere objects of curiosity.

The characteristic properties of osmium are to oxidate at a low heat, and to form an oxide exceedingly volatile, odorous, and fusible; crystallizable, soluble in water; the solution of which becomes blue by the infusion of nutgalls, and by the immersion of a plate of zinc: finally, the property of forming yellow combinations with the alkalies.

## ARTICLE XII.

### *Proceedings of Philosophical Societies.*

#### ROYAL SOCIETY.

On the 9th of November the Society met for the first time after the long vacation. A paper by Sir H. Davy on the fire-damp in coal-mines was read. The author had been invited by Dr. Grey to examine the subject, in order to discover, if possible, some method of preventing those explosions which of late years have proved so fatal to the lives of the colliers. He accordingly visited several of the mines, and analyzed the pure gas collected from a blower. He states, as Mr. Longmire had done before him (*Annals of Philosophy*, vi. 172), that this gas is extricated from the crevices of the coals; and he found that when a large piece of coal was broken to pieces under water, inflammable gas was given out. The result of his analysis of the gas was precisely the same with the previous result obtained by Dr. Henry (*Nich. Jour.* xix. 149), that it was pure carbureted hydrogen gas. It required twice its bulk of oxygen gas to consume it, and nearly its own bulk of carbonic acid gas.

This is characteristic of carbureted hydrogen, as both Mr. Dalton and myself have ascertained. He found the specific gravity to be 0.639, but his specimen was mixed with common air. I have shown the true specific gravity of this gas to be 0.555 (*Wernerian Memoirs*, i. 508).

He found it much less combustible than other combustible gases. Iron heated to whiteness does not set it on fire. It requires actual flame. This fact has induced him to propose a lantern made airtight, with a hole below to admit air, and one above to act as a chimney, as a complete security against the explosion of the fire-damp in coal-mines. He found that when a mixture of common air and carbureted hydrogen gas, in such proportions as to explode, is let up into such a lantern, the flame increases, so as nearly to fill the lantern, and then the lamp goes out. He conceives that whenever in a coal-mine the air is mixed with carbureted hydrogen to the exploding point, that such lamps would go out, and no explosion would follow. But such an experiment would be very hazardous. The fact is, that in such a case the gas within the lantern burns, and of course extinguishes the lamp; but in all probability the gaseous combustion would extend itself through the holes in the lantern, which are filled with gas at the exploding point, and set fire to the whole mixture in the mine. This would certainly happen sometimes, if not always; so that the lantern of Davy would furnish no certain security to the miners. The lamp of Dr. Clanny, if properly improved, is a much safer contrivance, and might be made equally cheap.

I ascertained that the limits of the explosion of this gas were 12 volumes of air and one of gas, and six volumes of air and one of gas. As far as I could understand Sir H. Davy's experiments, they led nearly to the same result. He succeeded in exploding a mixture of this gas and common air by electricity. I could not succeed in this, not having, it seems, hit upon the exploding proportions, though I tried a great many between the two limits.

Sir H. Davy constructed likewise lanterns with valves to prevent the escape of gas from the lantern when it explodes. This would certainly render the lantern safe, provided it can be constructed so as to allow the lamp to burn.

On Thursday, Nov. 16, an appendix to Sir Humphry Davy's paper was read. He found that the addition of  $\frac{1}{7}$ th of carbonic acid or of azote to the exploding mixture of fire-damp and air prevented the explosion.

A paper by Mr. Daniel on Solutions was likewise partly read. When an amorphous mass of alum was left for some weeks in water it assumed a pyramidal form, and the lower part of it was embossed by distinct octahedral crystals. Borax exhibited a similar appearance; the lower part was embossed with rhomboidal crystals. Mr. Daniel conceives that in these cases the cohesion of the solid resisted unequally the solvent power of the liquid, and that the upper part of the liquid acted more powerfully than the lower. Hence

the pyramidal form, and hence the appearance of the crystalline texture. These phenomena were observed and described long ago by Le Blanc; but he ascribed the appearance of crystals at the under part of the body to the deposition of crystals from the liquid. But the following experiments of Mr. Daniel render this opinion not so probable. He put bismuth and antimony in very diluted nitric acid; after some days the bismuth exhibited the cubic texture, which is so striking in native bismuth, and the antimony exhibited the appearance of rhomboids. A number of similar experiments with other bodies were related, all tending to prove the accuracy of the conclusion which Mr. Daniel had drawn.

On Thursday, Nov. 23, the remainder of Mr. Daniel's paper was read. He showed that the action of water and different solvents upon crystals was a much more delicate test of their structure than mechanical division. He showed that the supposition, that the integrant molecules of bodies are spheres, will explain the structure of alum crystals; the octahedral crystal, and all the other crystalline forms which it assumes being deducible from the arrangement of such spheres according to the action of gravity, merely by the abstraction or non-formation of certain angles by the removal of a certain number of molecules, while the arrangement of the rest is not altered; but the rhomboidal crystal of carbonate of lime, and the four-sided prism of sulphate of magnesia, cannot be deduced from the arrangement of spheres. Oblong spheroids, however, are capable of producing these forms. No other form of the particles but these two are capable of accounting for the structure of crystals.

#### LINNÆAN SOCIETY.

On Tuesday, Nov. 7, the Society met after the long vacation. A paper by Mr. Johnson was read, giving further information respecting the fossil remains of an animal found at Lynn, in Dorsetshire.

A notice from Mr. Sowerby was read, pointing out the advantages of watering fruit-trees.

Part of a paper by Don Felix Brotero was also read, on the genus *passiflora*.

On Tuesday, Nov. 21, the remainder of Don Felix Brotero's paper was read.

There was also read an account of a considerable number of specimens of *cinchona*, by Aylmer Bourke Lambert, Esq. They had been taken in a Spanish ship, and came into the possession of the author of the paper. He was able to distinguish different varieties of known species. Five specimens were not referable to any known species, but appeared new. The yellow bark of the shops is obtained from the *cinchona hirsuta* of the *flora Peruviana*.

There was also read part of a paper by Dr. Eric Acharius on two new genera of *lichens*.

## ROYAL INSTITUTE OF FRANCE.

*Account of the Labours of the Class of Mathematical and Physical Sciences of the Royal Institute of France during the Year 1814.*

(Continued from p. 229.)

## MATHEMATICAL PART.

*By M. le Chevalier Delambre, Perpetual Secretary.*

We have already, in a preceding notice, briefly analyzed the memoir of M. Biot on *A new Application of the Theory of the Oscillations of Light*, read to the Class at the end of 1813. The author announces in it that he has extended to substances having the most powerful double refraction, as arragonite and calcareous spar, the researches which he had at first only applied to substances whose double refraction is so feeble that the images of the luminous points seen through plates with parallel surfaces, and three or four centimetres thick, which are not sensibly separated. He has found in that manner that in these crystals, as in all the others, the luminous molecules begin by oscillating round their centre of gravity to a certain depth, after which they acquire likewise a fixed polarization, which arranges their axes in two rectangular directions.

To observe these phenomena in any crystal we must attenuate its polarizing force till the luminous molecules which traverse it make in its interior less than eight oscillations. We accomplish this either by forming with the given crystal plates sufficiently thin, or by inclining them on an incident polarized ray so as to diminish the angle which the refracted ray forms with the axis of double refraction; or, which is more convenient, by employing these two methods together.

We accomplish the same thing by transmitting first the incident ray through a plate of sulphate of lime of the requisite thickness, the axis of which forms an angle of  $45^\circ$  with the primitive plane of polarization; for when a ray is thus prepared, in order that it should be decomposed into coloured pencils, it is not necessary that the polarizing force of the second plate should be very weak; it is sufficient that it diminishes in the requisite degree the first impressions which it has received, in order that the difference of the number of oscillations produced in the two plates be less than eight.

We find, for example, that the polarizing force of Iceland spar is expressed by 18·6, if we take that of sulphate of lime for unity; or there is required a thickness of sulphate of lime amounting to 18·6, to destroy the modifications given to the rays of light by a thickness of 1 of Iceland spar. This ratio will be likewise that of Iceland spar; for rock crystal acts exactly like sulphate of lime. This ratio will only be 17·7, according to other experiments of M. Malus. The difference is insensible. M. Biot cannot decide which is accurate. All the other substances which he has been able to

subject to a similar proof have offered the same equality with respect to the polarizing forces. This would demonstrate, if it were necessary, that the theory of the oscillations of light attenuates these phenomena at their origin, and brings them to the consideration of the true forces by which they are produced.

In the work which the same author has published on the polarization of light, M. Biot was led to conclude that the luminous molecules, in traversing crystallized bodies, not only undergo geometrical deviations in the position of their axes, but that they acquire new physical properties which they retain, and which make themselves known in experiment by affections quite new. The proofs of this result depended upon a very delicate discussion. They required the aid of a great number of experiments. The author, in his memoir on the Physical Properties which the luminous Molecules acquire in traversing doubly refracting Crystals, read the 22d of May, 1814, has sought for simpler proofs to establish so extraordinary a consequence. The theory which he had deduced from it furnished him with the simplest means of establishing it directly.

He begins by polarizing a white ray by means of reflection from a mirror. He then transmits it perpendicularly across a natural plate of sulphate of lime of a thickness,  $e$ , which exceeds  $\frac{4.5}{100}$  of a millimetre, and the axis of which forms an angle of  $45^\circ$  with the primitive plane of polarization. The ordinary and extraordinary pencils which are produced proceed both in the same direction. Further, from the theory already established, these two pencils proceed white; and if the thickness does not exceed a few centimetres, they appear as if they were polarized at right angles, one in the direction of the primitive polarization, and the other in a rectangular direction.

He excludes this second pencil by transmission across a pile of plate glasses, disposed in such a way as to reflect totally without acting in the least upon the first pencil, which remains alone visible through the pile.

Then if we compare this with a ray polarized in the same direction by simple reflection from a plate glass, we see that they appear perfectly similar as to the geometrical arrangement of the particles and the direction of the polarization; for they exhibit exactly the same phenomena when examined by a prism of Iceland crystal, or by reflection from an inclined plate glass. In the first case they are resolved equally into two white images, which disappear and reappear at the same limits. In the second they are reflected in the same manner, and escape together from the reflection. Further, if we make them traverse thin plates of sulphate of lime or of rock crystal, they give equally coloured images, and coloured with the same tints; and both cease to give them when the plates have acquired a certain thickness. But with so great a resemblance, they exhibit a striking difference. Beyond these limits, the thickness always increasing, the ray polarized by simple reflection never gives colours; while the pencil that has first passed the thickness  $e$  of

sulphate of lime, begins to give colours anew when the thickness of the second plate of that substance comes within the limits  $e \pm \frac{41}{100}$  of a millimetre. It preserves, then, in this case, durable traces of the physical impressions which it had undergone in passing through the first crystallized plate, and these impressions are proportional to the thickness  $e$  of that plate; while the ray polarized by simple reflection is modified completely, as if it had passed a crystallized plate of infinite thickness. The difference between the two rays shows itself likewise in several other phenomena indicated by the theory, and which it would have been difficult, if not impossible, to divine otherwise.

In his preceding researches on doubly refracting crystals, the author has shown that we may obtain extraordinary and ordinary coloured pencils with thick plates as well as with thin plates, by opposing the polarizing actions successively exercised by the two plates on the same luminous ray. When these plates are of the same nature, the opposition always takes place when their axes of double refraction cross at right angles. But when they are of a different nature, we must in certain cases cross their axes, and in others place them parallel to each other. This last case takes place when we combine plates of beryl with those of quartz. When the axes of these two substances are placed in the same manner relatively to a polarized ray, the impressions which they communicate to it are such, that if they are successive they destroy each other. On the contrary, they continue and increase the effect if their axes are crossed at right angles, which is precisely the opposite of what we find when we combine two plates taken from the same crystal. Thus in this sort of effect which the crystals produce on luminous particles traversing them, we must distinguish two modes of impression different and opposite to each other, as is the case with vitreous and resinous electricity, or the north and south poles of a magnet. We may call them *quartzzy* and *berylly* polarization. The following is a list of some substances which arrange themselves under the one or the other of these denominations.

*Quartzzy Polarization.*—Rock crystal, sulphate of lime, sulphate of barytes, topaz.

*Berylly Polarization.*—Calcareous spar, arragonite, phosphate of lime, beryl, tourmaline.

When we combine together two crystals the polarization of which is of the same nature, we must cross their axes to obtain the differences of their actions; and on the contrary, we must place them parallel if their polarizations be different. We see that the primitive form of a crystal has no evident relation with the kind of polarization which it exercises, no more than it has with the electrical properties of minerals.

In studying the action of the tourmaline on light, M. Biot observed in it the singular property of having double refraction when thin and single refraction when thick. To show these phenomena, he polished the inclined faces of a large tourmaline, so as to form a



prism whose angle was parallel to the axis of the needle, which is likewise that of the primitive rhomboid. If we look at the flame of a candle through this prism, when we direct the eye through the thinnest part, we see two images the brilliancy of which is sensibly the same; one of which, the ordinary, is polarized in the direction of the axis of the tourmaline; and the second, extraordinary, in the direction perpendicular to that axis. But in proportion as we pass to the thicker part of the prism, the ordinary image becomes weaker, and at last disappears entirely; while the extraordinary image continues to be transmitted without undergoing any other diminution of density than what proceeds from absorption.

This property occasions various phenomena, which are easily foreseen when known, and which experiment confirms. They have much analogy with those that Dr. Brewster has discovered in the agate. In examining these, M. Biot has ascertained that they do not take place as in the tourmaline, but beyond certain limits of thickness; for when the agate is made sufficiently thin, it possesses all the properties of crystals endowed with double refraction.

The memoir of M. le Baron Ramond on the Meteorological Operations performed at Clermont-Ferrand since the Month of June, 1806, to the end of 1813, offers a general table of the observations which the author has made with the best instruments, the most assiduous care, and the precautions which a long experience had shown him to be necessary. They embrace the seven years of his residence in a department which offers so many objects interesting to the curiosity of the philosopher and naturalist. In a preceding memoir M. Ramond had shown the method of determining by the barometer the relative heights of two stations at a distance from each other. Here he gives merely the annual and diurnal heights of the barometer and thermometer, the influence of seasons and the time of the day, and the periodical oscillations observed in the height of the mercury.

The memoir is terminated by three tables, each of which offers the mean results of several thousand observations. In the first we find the mean height of the barometer for seven years, the mean heights of each season, those of each month at mid-day, with the oscillations at three other epochs, the most critical of the day: finally, the accidental variations, their extremes, and the variations for each season and each month.

The second presents with the same detail the degree of the centigrade thermometer at mid-day, with the extreme heights and the mean variations.

The third is consecrated to the meteors. We see the direction of the wind, the number of rainy and snowy days, of hail, of blight, of fog, of hoar frost, of frost, of strong wind, of thunder and lightning, of cloudy and cloudless days.

Of these three tables the first is that which furnishes the greatest number of interesting remarks. We could not give an exact idea of it except by copying the whole memoir, which is itself only an



extract drawn up with as much clearness as conciseness. We shall select the remarks which are the most interesting and the shortest. The mean results of the seven years differ very little from what might be deduced from the first two years. Hence they seem to possess all the requisite certainty; and it is not to be regretted that the author could not verify them by a longer abode at the Puy de Dome.

The mean results of the seven years interest more particularly the place that has furnished them. The variations observed in each season have a more general utility. We observe in them the action of regular causes, which subject the atmosphere to periodical modifications. Each season has its character. In summer, the mean height of the barometer is greater; in spring, it is less. The spring is the epoch of the greatest diurnal oscillations. They are least in winter. The accidental variations, on the contrary, are the greatest in winter, and the least in summer.

We remark unequivocal annual oscillations in the barometric mean, which seem analogous to the horary oscillations. The mercury is highest in the month of January. It descends till the month of April, when it is lowest. It then mounts till the month of June; and after remaining elevated for some time, it descends till November, and mounts again rapidly to the height of January.

The diurnal revolution has equally its annual phases. But phenomena so complicated would require a long continued series of good observations to determine what we cannot yet see in them.

The hygrometrical observations do not appear in these tables. The author has ascertained that the variations in moisture have no sensible effect upon the state of the barometer. They were therefore indifferent to the main object which he had in view, and of consequence he did not examine them with the same assiduity.

This new memoir offers a model which those persons will no doubt follow who devote themselves to the study of the modifications of the atmosphere. It presents facts from which they may set out, either to give more exactness to the value of the mean pressures, or to employ these means more conveniently in barometrical measurements. We find here the complement of the different inquiries with which the author has occupied the Class at different times, and of which we have given extracts in our former reports.

The memoir of M. Poisson on Elastic Surfaces is divided into two parts. The first is relative to flexible and non-elastic surfaces, of which M. Lagrange has given the equation of equilibrium in the new edition of his *Mecanique Analytique*, i. 149. M. Poisson comes to the same equation by a different method, which has the advantage of showing the particular restriction under which it is. It supposes, in fact, a condition which is not often fulfilled, and which becomes impossible in a heavy surface of unequal thickness. To resolve the question completely, we must attend to the difference of tensions which the same element experiences in two different directions. We then find equations of equilibrium, which include

that of the *Mecanique Analytique*. They are much more general, but they are at the same time more complicated.

The flexible surface presents, in a particular case, a result worthy of being remarked. If we suppose all the points of it pressed upon by a heavy fluid, we obtain for equation that which M. Laplace has found for a capillary surface, concave or convex. Hence it results that when a liquid rises or falls in a capillary tube, it takes the same form as a flexible and impermeable piece of linen filled with a gravitating fluid.

After having found the equation of equilibrium of a flexible surface, all the points of which are pressed upon by any forces, nothing more is wanting to determine the equation of an elastic surface than to comprehend among the number of forces those which proceed from elasticity. The determination of this species of force forms the object of the second part of the memoir.

Whatever be the cause of the elasticity of bodies, it is certain that it must consist in a tendency of their molecules to repel each other, and that this tendency may be ascribed to a repulsive force which they exercise according to a certain function of their distances. It is natural to think that this force, as well as all the other actions of the molecules, is only sensible at imperceptible distances. The function which expresses its law must be considered as null as soon as the variable quantity which represents the distance is not exceedingly small. We know that such functions generally disappear in the calculus, and only leave in the definitive results total integrals or arbitrary constant quantities, which are the data of the observation. This happens in the theory of refractions, and still better in the theory of capillary action, which the author of the memoir considers as one of the most beautiful applications of mathematics to natural philosophy. The same thing holds in the present question. Hence we can express the forces proceeding from the elasticity of the surface by quantities depending solely on the figure, as the principal radii of curvature and their partial differences. In this way M. Poisson obtains an equation of the elastic surface, the object of his research. It is not possible to give these formulas here, nor the details of calculations on which they are founded; we are obliged to refer to the memoir.

The principal equation supposes the thickness constant, and agrees only with an elastic surface nearly plane. It neither comprehends bells, nor other surfaces which are naturally curved. The author comes to them in another manner, which he draws from the principle of virtual velocities. This manner is even more simple than the first; but it leads to a more complicated equation, the identity of which with the former it has been impossible to verify, except by a particular artifice. But in so difficult a case, it is an additional security to have two different methods which lead to the same result.

After having considered the problem as a question in general

mechanics, M. Poisson makes an interesting application of it to one of the most extensive and curious branches of acoustics; that is to say, to the vibrations of elastic plates, to the figures which they present, and to the sounds which they emit, during their movements. We may suppose that the plate to become sonorous separates very little from a fixed plane. This consideration puts it in our power to neglect all the quantities of the second dimension with respect to one of the three co-ordinates. Abstracting, then, the weight of the plate, and supposing that each point of the plate remains during the movement in the same perpendicular to the fixed plane, the author obtains a new formula which divides itself into two others, according as the one or the other of the two constant quantities which it contains are reduced to 0. One of these particular equations had been already found by Euler; the other occurs without sufficient proof, or even without any demonstration, in a piece sent for the prize proposed by the Class of the Sciences, on the Mathematical Theory of the Vibration of Sonorous Plates, verified by a Comparison with Experience. This prize is still open till the 1st of October, 1815, the Class not having hitherto received any piece worthy of attention, except that to which it has given an honourable mention on account of this same formula. The author satisfies it by particular integrals composed of exponentials of the sine and cosine. In this he followed the example given by Euler. To each of these integrals corresponds a particular figure of the sonorous plate, and the sound which it emits depends in general on the number of nodal lines which form during these vibrations. The tones thus calculated agree in a satisfactory manner with the experiments of Chladny, and with other experiments made by the anonymous author. This conformity was the principal cause of the honourable mention made of that memoir.

M. Poisson points out another kind of comparison, much more difficult, and which would be relative to the figure produced, after a given manner of putting the plate in a state of vibration. He would wish, likewise, that the results of the calculus were deduced from the general integral, and not from some particular integrals. Unfortunately this equation cannot be integrated in a finite form except by definite integrals, which contain imaginary quantities under arbitrary functions; and if we make them disappear, as M. Plana has done in the case of vibrating cords, we obtain an equation so complicated that it appears very difficult to make any use of it.

We see, then, that the question of sonorous plates offers still to the analyst sufficient difficulties to surmount to account for the decision of the Class, who have put off the term of deciding the prize till the 1st of October, 1815. But the double demonstration of the fundamental formula is a very important step. It may be hereafter taken as a datum of the problem; so that the candidates will turn all their efforts towards the integration of the formula, and the different methods of comparing it with experience. Those who

wish for more details will find them, with the formulas themselves, in the Bulletin de la Societé Philomatique for 1814.

The memoir on the Probability of Evidence, by M. le Comte Laplace, read to the Class on the 8th of August, 1814, was not intended by the author to make a part of the collection of our memoirs. It was composed to complete a general treatise which appeared in November last, entitled *Theorie Analytique des Probabilités*, and in which M. Laplace has collected in the most natural order, and often with considerable augmentations, all that he has written at different times on this subject, with which he has been occupied since the commencement of his mathematical career. In this chapter, entirely new, which he has devoted to testimony, and which constitutes the last in the new edition, the author considers successively a single witness, or an indefinite number of witnesses, either simultaneous or successive. He estimates their probability, and the law according to which it decreases. He applies his theory to the sentences given either in the first instance, or in the courts of appeal. In another chapter, which has the title of Additions, we find a new demonstration of the ratio of the circumference of a circle to its diameter in infinite series given by Wallis, and rigorous and direct demonstrations of some formulas, which in the course of the work had only been established by induction.

We have already parabolic tables of four different forms: those of Halley, of Lacaille, of Berker, and of Saron, which may, at least the last three, claim the preference, according to the methods which we employ to determine the unknown orbit. M. Burekhardt, who has invented for this kind of calculation expeditious methods, which he frequently uses, has just given to his General Tables of the Parabolic Movement of the Planets, a form more appropriated to these same methods, and which ought still to abridge the calculations.

(To be continued.)

---



---

## ARTICLE XIII.

SCIENTIFIC INTELLIGENCE; AND NOTICES OF SUBJECTS  
CONNECTED WITH SCIENCE.

### I. *Theory of Crystals.*

In Fontenelle's *Eloge* on Guglielmini, the well-known Italian philosopher, who distinguished himself by his various treatises on hydrodynamics, he mentions a book of this philosopher published at Venice in 1705, and entitled *De Salibus Dissertatio Physica Medico-Mechanica*. Fontenelle's account of this book is as follows: "The ground of the whole work is, that the first principles of common salt, vitriol, alum, and nitre, consist, from their original creation, of fixed and unalterable principles, and are indi-

visible with respect to the determinate force or strength that is in matter. The primitive figure of the common salt is a little cube; of vitriol, a rhomboidal parallelepipedon; of nitre, a prism whose basis is an equilateral triangle; and of alum, a quadrangular pyramid. From these figures proceed those which they constantly affect in their crystallizations, provided that they are kept as free as possible from all foreign mixtures." This looks like an anticipation of Haüy's doctrine of the *primitive molecules* of bodies. Whether it be so or not, can only be determined by a perusal of the book itself, which I have never had an opportunity of seeing.

## II. Fluxions.

Want of room prevented me in the last number from making some observations in answer to the queries respecting fluxions, proposed in p. 394 of the present volume. When Professor Christison says that fluxions might be easily understood by a person who has only made himself acquainted with the first two books of Euclid, I presume he is far from recommending such a plan to be actually followed. He merely makes use of the expression to make the reader sensible that fluxions contain nothing mysterious, and that they are easily comprehended. To study fluxions with so little mathematical knowledge would be useless, because the pupil could not in that early stage of his progress apply them to any useful purpose. The mode of studying mathematics, which appears the simplest and easiest, is to learn the first four books of Euclid; then to make the pupil acquainted thoroughly with vulgar and decimal fractions, and with algebra as far as the solution of quadratic equations. With this knowledge the fifth book of Euclid or the doctrine of ratios, which is so important in mathematics, is easily comprehended by the pupil. A very perspicuous demonstration of the principal theorems in it will be found in Saunderson's Algebra. The pupil may then study the sixth book of Euclid, and make himself master of the 11th and 12th. I consider Mr. Playfair's substitution of a variety of demonstrations from Archimedes as an improvement of the 12th book. He may then return back to Algebra, learn the method of resolving cubic and biquadratic equations, the nature of equations in general, and the various modes of solving them by approximation. The properties of figurate numbers, of logarithms, and the doctrine of series may also be learned. The pupil then goes to trigonometry, and makes himself acquainted with plain and spherical, with the arithmetic of sines and tangents, and with the practical method of measuring heights and distances. He may then go to conic sections, and make himself acquainted with the properties of the parabola, ellipse, and hyperbola. After this fluxions come with propriety. The direct method occasions no difficulty whatever, and will yield much pleasure from the facility with which it enables the pupil to draw tangents to curves, to solve the questions respecting maxima and minima, &c. Here an opportunity may be taken of making

the pupil acquainted with a variety of important curves, and indeed with the doctrine of curves in general. Lastly, let him proceed to the inverse method. Let him accustom himself to resolve as many problems as possible.

We have no good elementary book on fluxions in English. The best is Thomas Simpson's fluxions; but it is very inelegant, and he has been at no pains to smooth the difficulties. The best books in existence on fluxions are three of Euler, written in Latin, his introduction to the calculus of infinitely small quantities, and his works on the differential and integral calculus. I would be disposed to make use of them; but as the notation is different from our's, that may be considered as an objection. Of the French elementary books the best that I have seen is Bossut's. Lacroix wants the art of arranging; hence his books are confused, and not very fit for students.

### III. *Account of a Meteor.*

(To Dr. Thomson.)

MY DEAR SIR,

In the last number of your *Annals of Philosophy*, Mr. Luke Howard mentions a meteor, which was seen on the evening of the 29th of last month, and requests any person having observed the same to give him what information they can. I was walking out in the evening and saw the reflection of light on the ground, much like to a large flash of lightning; on looking up, the meteor was then passing with great velocity towards the north, and also declining: it then appeared to divide into a number of stars, much like a sky rocket when bursting.

As your *Annals* generally embrace all foreign and scientific intelligence, I shall consider myself much obliged if through the *Annals* you would favour me with the description of a Portable Machine for surveying land, invented by M. Pictet, an account of which I believe is published in the Archives des Decouvertes.

I remain, dear Sir, yours truly,

R. W. B.

Oct. 23, 1815.

### IV. *Queries respecting Steam Engines and Steam.*

(To Dr. Thomson.)

DEAR SIR,

I observe by the Newspapers, that an important improvement has lately been made by employing rarified air in place of steam, as the moving power of engines; and the editor of the Monthly Magazine mentions that one of these engines is already at work, which requires only one twentieth of the fuel used by a steam engine of the like power. I am sure it would be very acceptable to your numerous readers, if you would give a particular description of the machine, and the reason how so small a quantity of heat produces so great an effect. I have never seen any account of the specific heat of steam, of different degrees of elasticity: it is



stated in the last number of the Phil. Mag. that on a trial with Woolf's engines (who uses steam of high pressure) the effect, compared with other engines, is as 46255 to 19897, with the same quantity of fuel. You mention in your *Annals of Philosophy*, &c. that Count Rumford found it decrease with heat; but do not mention the rate. Is there any method of preventing the incrustation on the inside of steam engine boilers? What quantity of sugar may be obtained from a given quantity of starch?

I am, dear Sir, your most obedient,

I. S.

Dundee, Oct. 17, 1815.

### V. Royal Geological Society of Cornwall.

*Annual Report of the Council.*—In presenting this Annual Report the Council cannot resist the pleasure of congratulating the Society upon the active zeal with which the various objects of its research have been pursued, and the eminent and unexampled success which has attended its labours: two years have not yet elapsed since its establishment, and yet how much has been effected! the cabinets are respectable, and in some departments even rich; the library is stored with many splendid and instructive works, in the various sciences connected with geology; and the laboratory has been furnished with all the apparatus necessary for the pursuit of analytical mineralogy; numerous interesting and original memoirs have been read, and a very considerable mass of materials has been collected for the construction of a Geological Map of the County; the miner too has been enlisted into our service, and has presented us with much valuable information of a practical nature, which, when digested and arranged, may tend to solve the important problems connected with the structure of our metalliferous veins, and at the same time he has enriched our portfolios by the addition of many beautiful plans and drawings.

While the objects of scientific research have been thus happily advanced, the interest of the miner has excited equal attention, and been promoted with equal zeal: the Economical Department of the collection is calculated to afford him much valuable instruction, it will teach him the characters and appearances of the different mineral substances employed in the various arts and manufactures of the kingdom, and enable him to recognize them whenever they may occur in his own districts, and thus open to him endless sources of profitable labour: the council therefore take this opportunity of soliciting the co-operation of the various mine agents, in order that they may more speedily enrich, and extend this most important part of the collection. Nor has the safety and lives of the miners been forgotten: it is with infinite satisfaction that the council are enabled to state that the Tamping Bar composed of a metallic alloy, as suggested by Sir Rose Price, for the prevention of these fatal explosions which so frequently attend the use of iron instruments, through the humane and able exertions of



Mr. William Chinalls, has been so modified as to be free from all the former objections urged against its utility, and has accordingly been introduced into general use in many of the most extensive mines.

A valuable instrument also invented by Mr. Chinalls, called the Shifting Cartridge, well deserves the attention of the mine agent, its object being to deliver any given quantity of gunpowder into a hole bored in a rock for the purpose of blasting it, without that loss and hazard which attend the ordinary method of charging.

From this report the enlightened members of the community will be enabled to appreciate the value and extent of the labours of this society, they will discover the grand objects of the institution, and be induced, it is hoped, to co-operate in extending its views; by which the obscure art of mining will be improved, the health, comfort, and life of the laborious miner ensured, and the political resources and opulence of the county augmented.

*Comparative View of the number of Members at the last and on the present Anniversary.*—First anniversary, 109; withdrawn, 1; died, 3; elected this year, 36; total, 141.

The Treasurer reports that, although our expenses have been necessarily great, the Society is free from incumbrances, and has a considerable balance in its favour.

The following papers have been read this year:—

1. On a Recent Formation of Sand-stone, which occurs on several Parts of the Northern Coasts of Cornwall. By John Ayrton Paris, M. D. F. L. S. &c.

2. An Account of the Granite Veins at Porth Just. By John Davy, M. D. &c.

3. Observations on the Gold found in the Stream Works of Ladoc. By Sir Christopher Hawkins, Bart.

4. Contributions towards a Knowledge of the Geological History of Wood Tin. By Ashurst Majendie, Esq.

5. An Account of the Relistian Mine, in Gwinear. By Joseph Carne, Esq.

6. A Sketch of the Geology of the Peninsula of the Lizard. By A. Majendie, Esq.

7. Answers to Geological Queries respecting Lodes. By Mr. John Davey, Associate.

8. Answers to Geological Queries. By Mr. John Stephens, Associate.

9. On the Granite Veins traversing Slate at Mousehole. By A. Majendie, Esq.

10. On the Geology of the Coast west of Mousehole, and on the Structure of the Scilly Islands. By A. Majendie, Esq.

11. Additional Notes to a Memoir on a recent Formation of Sand-stone. By John Ayrton Paris, M. D. &c.

12. Hints on the Geology of Cornwall. By Sir Humphry Davy, Honorary Member of the Society.

13. An Account of a Tamping Bar composed of a Metallic

Alloy; and of an Instrument termed the Shifting Cartridge. By Mr. W. Chinalls.

14. Observations on the Scilly Islands. By Henry Boase, Esq.

15. An Account of Silver Mines in general, and of those in Cornwall in particular. By Joseph Carne, Esq.

16. On the Lime-stone at Veryan. By Samuel Trist, Esq.

17. An Account of the Produce of the Copper Mines in Cornwall, Devonshire, Anglesey, North Wales, and Ireland, in Ore, Copper, and Money, for the Year ending the 30th of June, 1815, and of Tin raised in Cornwall, in the Year ending with Midsummer Coinage, 1815. By Joseph Carne, Esq.

At the Anniversary Meeting, October 10, 1815, the Right Honourable Lord De Dunstanville, &c. Vice Patron, in the Chair, the Report of the Council being read, it was resolved, That it be printed and circulated.—That the Museum of the Society be invested in the following Trustees: Lord De Dunstanville, Vice Patron; Lord Viscount Falmouth; Sir William Lemon, Bart.; Sir Rose Price, Bart.; Davies Giddy, Esq. M. P. President.

Lord De Dunstanville communicated to the Society, that Dr. Paris had been introduced to his Royal Highness the Prince Regent, the Patron, in order to present him with a Report of the Society, and that he had been most graciously received.

Thanks were voted to those Gentlemen who had contributed to the cabinet and library; to the authors of the different memoirs read before the Society; to Mr. Chinalls, and the other mine agents, who have exerted themselves in introducing the alloyed tamping bar; to John Ayrton Paris, M. D. for the zeal and ability with which he has conducted the Society, and for his Course of Lectures on Chemistry delivered before them last winter.

Sir Rose Price Bart. as the representative of those Gentlemen who had attended the Lectures, stated that he rose for the purpose of presenting Dr. Paris with a piece of plate, of 50 guineas value, as a small testimony of their esteem and regard.

It was further resolved, That a medal with an appropriate device be immediately struck, and presented to those miners who had contributed practical information to the Society, or who had by their exertions promoted its views.

## VI. Prussic Acid.

A most important set of experiments on prussic acid has been lately made by M. Gay-Lussac. I shall lay the whole of them before my readers as soon as I can find room for their insertion. In the mean time I shall give a sketch of the results which he obtained, by way of notice, that I may satisfy the impatience of British chemists, and enable them to examine the curious substances which Gay-Lussac has discovered.

Prussic acid may be obtained by putting dry prussiate of mercury into a tubulated retort, pouring upon it muriatic acid in quantity not sufficient to decompose the whole prussiate, and applying a

moderate heat. Care must be taken that none of the muriatic acid passes over, and a tube filled with dry muriate of lime should be luted to the beak of the retort, in order to absorb all the moisture. The receiver should be surrounded with ice.

Prussic acid, thus prepared, is a colourless liquid, having a strong odour, and a taste at first cooling, then hot, and violently poisonous. Its specific gravity at  $45^{\circ}$  is 0.7058; at  $64^{\circ}$  it is 0.6969. It boils at  $80^{\circ}$ , and congeals at about  $5^{\circ}$ . At that temperature it crystallizes regularly. The cold which it produces when converted into vapour, is sufficient, even in summer, to congeal it. The specific gravity of its vapour is 0.9360. This vapour was mixed with oxygen gas at  $72^{\circ}$ , and detonated in a Volta's eudiometer. 100 measures of the gas consumed 125 measures of oxygen; 100 measures of carbonic acid were formed, and there remained 50 measures of azotic gas. 100 of the oxygen went to the formation of carbonic acid, and 25 to that of water; hence the hydrogen present, if in the state of gas, would have amounted to 50 measures. It is evident from this analysis, that prussic acid is composed of

Carbon .....	1	volume
Hydrogen .....	0.5	
Azote .....	0.5	
	<hr/>	
	2.0	

condensed into one volume. Or by weight of

Carbon .....	44.39	.....	2	atoms
Azote .....	51.71	.....	1	
Hydrogen .....	3.90	.....	1	
	<hr/>			
	100.00			

Prussic acid cannot be kept. It is decomposed spontaneously, and converted into prussiate of ammonia and a black matter composed of carbon and azote. Phosphorus and iodine may be sublimed in it without alteration. Sulphur combines with it. Potassium put into the vapour of prussic acid absorbs it, while a quantity of hydrogen is disengaged equal to half the volume of the prussic vapour. The potassium is converted into a yellow substance, soluble in water, and converted by this solution into prussiate of potash. From this result it is obvious, that prussic acid, like muriatic acid and hydriodic acid, is composed of a radicle combined with hydrogen. This radicle is obviously a compound of two atoms of carbon and one atom of azote. This radicle may be obtained in a separate state. Like chlorine and iodine it unites with many bodies; hence prussic acid, like muriatic and hydriodic acids, is composed of equal volumes of a radicle and hydrogen gas united together, without any diminution of bulk. Gay-Lussac has given the name of *cyanogen* to the radicle, and of *hydrocyanic acid* to what was formerly called *prussic acid*.

VII. *Cyanogen.*

Cyanogen is easily obtained by exposing what was formerly called *prussiate of mercury*, but which Gay-Lussac has shown to be a compound of cyanogen and mercury, to the heat of a lamp. The salt should be very dry. A gas comes over, which must be received over mercury. It is cyanogen gas. This gas has a very strong and peculiar odour. Water dissolves it, and acquires a sharp taste. It is inflammable, and burns with a blueish purple flame.

Its specific gravity is 1.8064. It may be exposed to a very strong heat, without decomposition. Water dissolves  $4\frac{1}{2}$  volumes of it, alcohol 23 volumes, and alcohol and oil of turpentine at least as much as water. It reddens infusion of litmus, and combines with the salifiable bases, and therefore possesses acid properties. Phosphorus, sulphur, and iodine, may be volatilized in it without change. Hydrogen has no action on it. Copper and gold do not combine with it, but iron partly decomposes it at a red heat. Potassium absorbs just as much of it in bulk as it separates of hydrogen from water.

For combustion it requires twice its bulk of oxygen gas. It detonates with great violence, and with a bluish flame. 100 measures of cyanogen thus burn and form 200 measures of carbonic acid gas, and leave 100 measures of azote. Cyanogen combines with several of the metals. It unites also with the alkalis and alkaline earths. When these compounds are dissolved in water, the cyanogen is decomposed, and converted into carbonic acid, ammonia, and hydrocyanic acid; and what is curious, equal volumes of these three substances are formed, supposing them all in the gaseous state.

VIII. *Chloro-cyanic Acid.*

Berthollet observed long ago, that when chlorine was mixed with hydro-cyanic acid, the properties of this latter acid were altered. Its smell became much stronger, and it precipitated iron, not blue as before; but green. The new substance thus obtained was called oxy-prussic acid, because it was considered to be a compound of oxygen and prussic acid. Gay-Lussac has ascertained that it is a compound of equal volumes of chlorine and cyanogen, and on that account has given it the name of *chloro-cyanic acid*.

To obtain it, he passed a current of chlorine gas into hydro-cyanic acid, till that acid acquired the property of destroying the colour of a solution of indigo in sulphuric acid. By agitating the liquid with mercury he got rid of the excess of chlorine. The liquid was then distilled. He obtained a gas which was a mixture of chloro-cyanic acid and carbonic acid; but chloro-cyanic acid is not an elastic fluid, but a liquid. He obtained it in that state by filling two thirds of a glass jar with mercury, and the other third with the hydro-cyanic acid, saturated with chlorine. This jar was placed inverted over mercury, under the receiver of an air-pump. On producing a vacuum the mercury and liquid were driven out of

the jar. Atmospheric air being again admitted into the receiver, the mercury entered into the jar, and the elastic fluid condensed into a liquid on its surface. This liquid was chloro-cyanic acid. It possessed the following properties.

It is colourless. Its smell is very strong, exciting tears. It reddens litmus, is not inflammable, and does not detonate when mixed with twice its bulk of oxygen or hydrogen gas. The specific gravity of its vapour is 2.111. Its solution in water does not precipitate nitrate of silver nor barytes water. The alkalies absorb it completely. When an acid is poured into this solution the chloro-cyanic acid is decomposed, and converted into muriatic acid, carbonic acid, and ammonia. This acid being composed of a volume of chlorine united to a volume of cyanogen, without any diminution of bulk, is analogous to muriatic acid, hydriodic acid, and hydro-cyanic acid, only the chlorine performs the part of the hydrogen which constitutes the acidifying principle in these last acids.

IX. *Dr. Murray, of Edinburgh's, Method of preventing Explosions in Coal-Mines from Fire-Damp.*

At the second meeting of the Royal Society of Edinburgh for the winter session, a paper was read, by Dr. Murray, on a plan for lighting mines so as to guard against explosions from the kindling of fire-damp. It had been before explained to several scientific Gentlemen, and announced in the public papers; and an outline of it had been transmitted to Newcastle, where a very favourable opinion had been expressed with regard to it. The leading idea on which it is founded is, that the inflammable gas constituting fire-damp accumulates in the roof of the passages and workings of the mine, mingling with the atmospheric air, and at length forming a mixture, which is exploded by coming in contact with the candles or lamps of the miners; and that this mixture can never accumulate so as to fill the whole space, at least while the mine is worked, for the miner would become affected by breathing the carbureted hydrogen gas, independent of other appearances which would indicate its presence. The simple means of security, therefore, against its explosion, is to bring the air to sustain the flame of the lamp or candle from the floor of the mine; and this is easily done, by burning the lamp within a glass case, having a small aperture at the top to admit of the escape of the heated air and smoke, of such a size that the current shall always pass outwards, and thus prevent any of the external air from entering by it, and having attached to the under part of it a tube reaching to the floor of the mine to convey the air to the flame. In the fixed lamps this tube may be of iron or copper; and moveable lamps, which the miner can carry in the hand, may be constructed with a flexible tube of prepared leather, varnished, of such a length as to reach to the floor.

Besides the security given by this apparatus by bringing the air to support the flame from the floor of the mine, it has other means of security; one in particular, Dr. M. remarked, is the rarefaction of the air within the case; whence, if even any mixture of inflam-

mable air were to enter, there is little or no probability that it would be inflamed. He referred to the experiments of Grotthus, as proving that mixtures of inflammable gases with atmospheric air, or even with oxygen gas, cannot be inflamed if they are in a certain degree of rarefaction: and he quoted the observations of Dr. Thomson, that the exploding power of carbureted hydrogen is not considerable, that a certain proportion of it with atmospheric air is necessary to enable it to inflame, and that no mixture of fire-damp with atmospheric air can be made to explode out of the mine. In the small quantity, therefore, in which it must be within the lamp, in its rarefied state from the heat, and with a diluted atmosphere, there is no probability whatever that it would be inflamed: and by properly adjusting the size of the aperture, this might even be carried so far that, instead of inflaming, it would weaken or extinguish, the flame; and still more, if ever inflammation or detonation should take place within the lamp, there would be no chance of this being communicated to the air of the mine. If, notwithstanding all these means of security, danger should be dreaded in any particular situation, it might be effectually guarded against by conveying pure air from the bottom of the shaft through an iron tube, which by upright tubes might communicate both with the fixed and moveable lamps. This, however, would probably be seldom necessary.

The accumulation of the fire-damp, when it occurred, would be indicated by its smell, or by its effect on respiration; and if it ever proceeded to that extent, by its effect in weakening the flame of the lamp; and when suspected, could be easily ascertained by more accurate trials. Its discharge can be effected by opening a more perfect ventilation, or by the application of a steam-engine, or an exhausting machine.

This method Dr. M. suggested might even be applied with safety so as to light the mines with great economy and advantage by coal gas. The same method admits also of being used with equal effect to guard against choak-damp, the other deleterious gas which occurs in mines and other situations. His paper will be speedily published.



\* \* \* The author of the paper on the "Relation between the Specific Gravity of Gaseous Bodies and the Weight of their Atoms" thinks it proper to state, that many of the numbers in the fourth table in that paper, which are stated to be given on the authority of Berzelius, will be found to differ from those given by that chemist in the *Annals*, v. iii. p. 362, on account of their having been founded on the deductions of others, (principally of Dr. Thomson) from the experiments of Berzelius, and not upon that chemist's own deductions.



† † † The following note by Dr. Henry arrived too late to be inserted in that part of his paper where he speaks of Mr. Parkes:—

"It is but justice to Mr. Parkes to state, that I am far from suspecting him of the intentional suppression of any fact respecting the history of the new method of bleaching; and that I believe his account to be a faithful one, so far as his means of information extended."



## ARTICLE XIV.

## METEOROLOGICAL TABLE.

1815.	Wind.	BAROMETER.			THERMOMETER.			Hygr. at 9 a. m.	Rain.
		Max.	Min.	Med.	Max.	Min.	Med.		
10th Mo.									
Oct. 25	S W	29.39	29.33	29.360	57	39	48.0	71	
26	E	29.45	29.43	29.440	53	32	42.5	80	
27	N E	29.65	29.45	29.550	50	43	46.5	81	.26
28	N E	29.98	29.65	29.815	51	43	47.0	75	.35
29	N E	29.98	29.86	29.920	56	47	51.5	57	
30	N E	29.92	29.86	29.890	50	44	47.0	60	—
31	N E	29.94	29.92	29.930	51	36	43.5	65	
11th Mo.									
Nov. 1	N E	29.93	29.92	29.925	50	41	40.5	60	
2	N	30.23	29.93	30.080	51	33	42.0	61	
3	N	30.35	30.23	30.290	47	25	36.0	87	
4	S	30.35	30.25	30.300	44	30	37.0	70	—
5	S W	30.25	30.17	30.210	51	34	42.5	80	—
6	W	30.17	30.06	30.115	52	40	46.0	83	.15
7	W	30.06	29.99	30.025	53	32	42.5	85	—
8	W	29.99	29.78	29.885	53	41	47.0	75	—
9	S W	30.06	29.78	29.920	57	41	49.0		.35
10	S W	30.05	30.02	30.035	56	44	50.0	78	
11	S W	30.02	29.85	29.935	56	48	52.0	78	—
12	S	29.85	28.99	29.420	57	48	52.5	71	.75
13	W	29.07	28.95	29.010	51	35	43.0	65	3
14	N W	29.10	29.01	29.055	44	26	35.0	77	
15	Var.	29.28	29.10	29.190	41	27	34.0	75	—
16	N W	29.50	29.28	29.390	35	25	30.0	90	8
17	N W	29.90	29.50	29.700	36	21	28.5	85	—
18	N W	30.06	29.90	29.980	35	18	26.5	80	
19	Var.	30.06	29.72	29.890	35	25	30.0	80	
20	N E	29.62	29.60	29.610	42	33	37.5		
21	N E	29.80	29.60	29.700	42				
22	N E	30.09	29.80	29.945		25		80	
		30.35	28.95	29.783	57	18	41.75	76.5	1.97

The observations in each line of the table apply to a period of twenty-four hours, beginning at 9 A. M. on the day indicated in the first column. A dash denotes, that the result is included in the next following observation.



## REMARKS.

*Tenth Month.*—25. Lightning to the N. and W. last evening. 27. The wind changed to N. E. this morning: *Cumulastratus*, with inosculation, a. m.: west, p. m. 28. wet, a. m.: fair, p. m.: rain again at night: windy. 29. A brisk gale at N. E. continued through the day and night: a bank of *Cumulastratus* was visible in the morning in the S., from which quarter *Cumuli* were propagated northwards, changing the state of the superior clouds as they advanced: some *Cirri* in long lines above the whole were not affected: a solar halo appeared from one to two, p. m., and the sky was turbid beneath the sun. 30. a. m. completely overcast: windy, drizzling at intervals. 31. a. m. *Cirrostratus* tending to *Cirrocumulus*, beneath large *Cirri* pointing N. E. and S. W.: fair.

*Eleventh Month.*—1. Low *Cumulastratus* beneath *Cirrostratus*: a breeze at N. E., changing at night to N. W., without affecting the state of the clouds, which were dense, p. m. 2. Breeze at N. W.: a. m. Barometer very steady: *Cumulastratus*: much redness in the twilight. 3. a. m. clear, with *Cirrostratus*: slight hoar frost: coloured sun-set. 4. a. m. clear, with a little *Cirrostratus*: very white hoar frost, with ice: a fine day: after sun-set, a dull purple in the E., with a little orange in the W.: the moon conspicuous, the crescent indifferently defined, and pale. 5. Rain by seven, a. m.: after which low *Cumulastratus*. 6. a. m. A few drops, with the wind S.: then fine. 7. Cloudy: rain: lunar corona. 8. Some drops, a. m.: then much *Cirrostratus*: sun-set, with streaks of brown and purple on a yellow ground: moon visible, but its light peculiarly dim: wind and rain in the night. 9. Wet morning: dripping day: lunar corona: wind. 10. Fair, with *Cirrostratus*. 11. A little rain at night: *Cirrostratus*. 12. A fair warm day: various clouds passed over with a moderate wind: at evening the moon showed a lucid corona: to which succeeded, (the wind having risen and veered to S.) a continued exhibition of coloured halos varying in diameter, formed on low, rapidly passing, curling clouds, with an occasional corona, of pale green or yellow, between: a most tempestuous night followed, with rain. 13. Windy: a shower, p. m.: the moon gold-coloured. 14. Clear: wind moderate. 15. Cloudy, a. m.: windy: a sensible odour of electricity in the air, at one, p. m. 16. A snowy morning: fair, p. m. 17. a. m. White frost: little of yesterday's snow remaining: the wind S. W.; a breeze; a little rain: p. m. a waggon from the north came thickly covered with snow: wind brisk at N. at night. 18. Hoar frost: the moon looks like a map, so great is the transparency of the higher atmosphere. 19. Hoar frost and rime on the trees, bodies of thin mist, probably *Cirrostratus*, moved quickly over us this morning from the S. W. rendering the tree tops invisible: a fine day: *Cirrus* and *Cirrostratus* at night. 20. a. m. *Cumulastratus*: max. temp. at nine. 21. a. m. *Cirrus*: *Cirrostratus*: min. temp. at nine. 22. Fair, with hoar frost.

## RESULTS.

Prevailing Winds Northerly, interrupted by a Southerly current, which greatly depressed the barometer, soon after the middle of the period, and was followed by a sharp frost.

Barometer: Greatest height.....	30·35 inches;
Least.....	28·95 inches;
Mean of the period.....	29·783 inches.
Thermometer: Greatest height.....	57°
Least.....	18°
Mean of the period.....	41·75°
Mean of the hygrometer, 76·5°. Rain, 1·97 inch.	

# INDEX.

- A**ACHEN mass of native iron, recovery of, 53.  
Accum, Mr. F. on the method of illuminating the streets with coal gas, 16.  
Acharius, Dr. on two new genera of lichens, 455.  
Acidity and Alkalinity, on, 187.  
Adhesive slate, absorption of gases by, 250.  
Africa, voyage of discovery to, 392.  
Agaric, mineral, absorption of gases by, 251.  
Ailsa, craig of, structure of, 61.  
Air, resistance of, to differently shaped bodies, 277.  
Aleyonia, fossil, some new varieties of, 59.  
Amalgam of mercury and hydrogen, 234.  
Animal concretion, 397.  
Apothecaries, regulations for the examination of, 387.  
Arragonite, crystals of, 235.  
Asbestos, ligniform, absorption of gases by, 250.  
Assynt, lime-stone formations at, described, 60.  
Astronomical observations, 51, 293.  
——— circles, improved method of dividing, 136.  
Athens, climate of, 71—school of, 77.  
Atkinson, Mr. observations by, on Mr. Lockhart's imaginary cube roots, 72, 309.  
Atlantic, north, temperature of, 396.  
Auguste de St. Hilaire, M. botanical observations by, 223.  
Azotic gas, specific gravity of, 321.
- B.**
- Babbage, C. Esq. on the calculation of functions, 68.  
Bakewell, Mr. account of a coal-field near Manchester, by, 56.  
Beaufoy, Col. astronomical and magnetic observations, by, 51, 133, 218, 293, 379—description, by, of an instrument to measure and register the rise and fall of the tide throughout the whole flow and ebb, 273.
- Beaufoy, Henry, Esq. instrument, by, to ensure the attention of watchmen, 418.  
Beauvois, M. de, observations on plants, by, 148.  
Bended tabular rents, junction of, 43.  
Bennett, Hon. Henry Grey, account of Teneriffe, by, 57.  
Benzenburg, Dr. on the recovery of the Aachen mass of native iron, 53.  
Berneaux, M. Thiebaud de, botanical observations, by, 225.  
Berzelius, Professor, letter from, to Professor Gilbert, 47—objections, by, to Davy's theory of chloriae, 211.  
Blackfriars bridge, numbers that pass it in a day, 71.  
Blumenbach's arrangement of the human species, 151.  
Boracic acid, native, 71.  
Bossut, Charles, biographical account of, 401.  
Brain, on the functions of, 136.  
Brewster, Dr. on the multiplication of images and colours which accompany them in some specimens of Iceland spar, 68—on the new properties of light exhibited in the optical phenomena of mother-of-pearl, and other bodies to which the superficial structure of that substance can be communicated, 135—on the effect of heated and cooled glass on light, 136; 219—on the depolarization of light, 220—on pressure, 221—on the polarization of light by reflection from different transparent bodies, 222.  
Brotero, Don Felix, on the genus *passiflora*, 455.  
Bucholz, Professor, experiments on tungsten, by, 198.
- C.**
- Cambridge, objects of study at that University, 294.  
Camera lucida, new and important combinations with, 281.  
Canaries, population of, 396.  
Carbonate of bismuth, 236, 315.

Carbo-sulphuret of mercury, 237.  
 Carbureted hydrogen gas in coal-mines, origin of, 172—why not kindled by sparks, 236.  
 Carlisle, Anthony, Esq. on the connexion between the extra-vascular and vascular parts of animals, 68, 174.  
 Chalcedony, on vegetable remains in, 65.  
 Charcoal, absorption of gas by, 242.  
 Children, J. G. Esq. on the effects of a very large galvanic battery, 68.  
 Chloric acid, 128.  
 Chlorine, observations on, 124—objections to Davy's theory of, 211.  
 Chloro-cyanic acid, 470.  
 Christison, Professor, on fluxions, 178, 420.  
 Cinchona, specimens of, 455.  
 Clanny, Dr. Reid, account of the Sunderland lime formation, by, 115.  
 Clift, Mr. William, on the influence of the spinal marrow on the action of the heart of fishes, 222.  
 Cloportæ, respiratory organs of, 227.  
 Clovelly, North Devon, account of, 64.  
 Coal-field at Bradford, near Manchester, described, 56.  
 Coal gas, method of illuminating the streets by, 17.  
 Coal-mines, on, 108—queries respecting the ventilation of, 416.  
 Colours used in painting by the ancients, 222.  
 Conybeare, Rev. William, on the origin of a remarkable class of organic impressions occurring in nodules in flint, 58—account of Clovelly, by, 64.  
 Cornwall, Royal Geological Society of, 466.  
 Coxe, Dr. John Redman, observations on crystallization, by, 101.  
 Crystallization, observations on, 101.  
 Crystals, antiquity of the theory of, 463.  
 Cube roots of binomials, extraction of, 152—further observations on Mr. Lockhart's extraction of, 309.  
 Cuvier on the mouths of fishes, 228.  
 Cyanogen gas, properties of, 470.

## D.

Dalton's theory of chemical composition, observations on, 371.  
 Daniel, Mr. on solution, 454.  
 Davy, Sir Humphry, on iodine, 136—on the combustion of the diamond, 139—on the colours used by the ancients, 222—his method of preventing explosions in coal-mines, 453.

Davy, Dr. John, on animal heat, 140.  
 Depolarization of light, experiments on, 220.  
 Desvaux, observations, by, on the Algæ, 149.  
 Devar, island of, structure of, 61.  
 Diamond, combustion of, 139—largest, 391.  
 Dick, Thomas Lauder, Esq. on a toad found in the trunk of a beech, 11.  
 Distillation, double, by the same heat, 140.  
 Donovan, Mr. on a new vegetable acid, 66.  
 Dorsal vessel in insects, on the uses of, 34.  
 Draught of carriages, experiments on, 106.  
 Drig in Cumberland, on the vitreous tubes found near, 65.  
 Dunblane, mineral water of, analyzed, 256.  
 Dutrochet, M. on the envelopes of the fœtus, 226.

## E.

Edgeworth, R. L. Esq. experiments by, on the draught of carriages, 106—correction of an error in these experiments, by, 314.  
 Ewart, Peter, Esq. on the Daltonian theory, 371.  
 Explosion at the Success coal-pit, near Newcastle, 55—another, 153.

Fatty bodies, nature of, 156.  
 Fig, varieties of, 224.  
 Flax, new mode of manufacturing, 230.  
 Fleming, Rev. Dr. on the mineralogy of the Red Head, 142.  
 Floetz strata of England, older, remarks on, 20.  
 Fluo-arsenate of lime, 151.  
 Fluxions, observations on, 178, 420—queries respecting, 394—answers to, 464.  
 Fœtus, on the envelopes of, 226.  
 Fossil remains of an animal most nearly allied to fishes, 139.  
 Fox, James, jun. Esq. register of the weather in Plymouth for six months, by, 366.  
 Fucus vesiculosus, 396.

## G.

Gadolinite, 151.  
 Galena sublimed during the burning of London bricks, 304.

Galvanic battery, very large, effects of, 63—elementary, described, 209.

— experiment, new, 234.

Gases, absorption of, by different bodies, 241—by liquids, 338.

Gay-Lussac, observations, by, on chlorine, 124.

Gehlen, A. F. death of, 392.

Geological Society, Transactions of, 56—meetings of, 140.

Glass, heated, effects of, on light, 136.

Gough, Mr. John, on the collision of hard bodies, 414.

Great Britain, rapid intercourse through, 312.

Groombridge, Stephen, Esq. on atmospheric refraction, 135.

Guglielmini seems to have had some notion of the structure of crystals, 463.

Gum-arabic, analysis of, 431.

## H.

Hard bodies, on the collision of, 414.

Heart, action of, experiments to determine on what it depends, 221.

Heat, animal, some experiments on, 140.

Hemp, new mode of manufacturing, 230.

Henry, Dr. confirms Mr. Rose's discovery that urea is wanting in urine in hepatitis, 392—on bleaching by oxymuriatic acid, 421.

— Mr. Thomas, his experiments on bleaching with oxymuriatic acid, 422.

Herschell, Dr. on the satellites of the Georgium Sidus, 68.

Hey, Dr. Richard, on some properties of tangents to circles, &c. 135.

Home, Sir Everard, on the respiration of certain vermes that live in water, 69—on the mode of generation of the lamprée and mixine, 68—on the functions of the brain, 136—on the fossil remains of an animal allied to fishes, 139—on the influence of the nerves on the action of the arteries, 139.

Horner, W. G. Esq. on new and important combinations with the camera lucida, 281.

Huel Peever, account of, 141.

Hydro-cyanic acid, 469.

Hydrogen gas, specific gravity of, 322.

Hydrophane, absorption of gases by, 251.

## I.

Jameson, Professor, on the old red sand-stone formation, 13—on the places where fossil elephants have

been found, 142—on the indurated talc of the Zetlands, 142.

Iceland, weather in, during 1814, 395.

Indigogen, 75.

Institute, labours of, 146, 223, 387, 436.

Instrument for performing mechanically the involution and evolution of numbers, 220—for registering the rise and fall of the tide, 273—for ensuring the attention of watchmen, 418.

Iodine, experiments and observations on, 136—discovery of, 183—test of, 312.

Johnson, Mr. on fossil remains found at Lynn, 455.

Jorullo, volcano of, 146.

Iridium, memoir on, 433.

Iron, native, new mass of, discovered, 151.

## K.

Kater, Capt. Henry, on an improved method of dividing astronomical circles, 136.

Kid, Dr. on the production of salt-petre, 138.

## L.

Labradore, notices relative to the geology of, 63.

Lamouroux, M. on the algæ, 149.

Latreille, M. on the respiratory organs of the cloportæ, 227.

Linnæan Society, meetings of, 70, 455.

Lockart, Mr. imaginary cube roots of, observations on, 72—on the extraction of the cube roots of binomials, 152.

London bridge, numbers that pass over it in a day, 71.

Longmire, Mr. John B. on rents, 43, 213, 411—on the origin of carburated hydrogen gas in coal-mines, 172.

Luminous appearance in the heavens, 393.

## M.

Macculloch, Dr. on the junction of trap and sand-stone at Stirling Castle, 57—miscellaneous geological remarks, by, 59—on quartz rock, 63—on staffs, 64—on vegetable remains preserved in chalcedony, 65—on the Isle of Sky, 140.

Magnetical observations, 51, 133, 218, 293, 378.

Mammoth, tooth of, discovered in Hudson's Bay, 142.

Mauua, analysis of, 431.

Marcel de Serres, M. on the uses of the dorsal vessel in insects, 34.  
 Meerschaum, absorption of gases by, 248.  
 Meteor, account of, 465.  
 Meteorological table, 79, 159, 239, 318, 399, 473.  
 Mines of Cornwall and Devon, economy of, 58.  
 Montague, George, Esq. death of, 77.  
 Mother-of-pearl, optical phenomena of, 135.  
 Mountains, formation of, explained, 411.  
 Mouths of fishes, 228.  
 Moyle, Mr. on valves, 305.  
 Murray, Dr. John, analysis, by, of the mineral waters of Dunblane and Pitcaithly, 256, 347—his method of preventing explosions in coal-mines, 471.

## N.

Nautical Almanac for 1815, defects of, 394.  
 Nerves, influence of, on the action of the arteries, 139.  
 New curve, 154.  
 Nickel-antimonerz, 154.  
 Nomenclature, chemical, on, 232.

## O.

Office, proposal to establish one in Newcastle to register every thing respecting the collieries, 388.  
 Organic impressions on flint explained, 58.  
 — substances, on the analysis of, 269.  
 Osmium, memoir on, 433.  
 Orthoceratite in marble, 152;  
 Ouzel, water, or dipper, new species of, 142.  
 Oxide of tin, crystals of, described, 59.  
 Oxygen gas, specific gravity of, 321.  
 Oxymuriatic acid, bleaching by, on the history of, 422.

## P.

Parmentier, M. biographical account of, 161.  
 Parry, Dr. on the cause of the pulsation of the arteries, 66.  
 Patents, list of, 158, 237, 316, 397.  
 Petit-Thouars, M. du, observations, by, on plants, 149.

Philip, Dr. A. P. Wilson, experiments, by, to determine on what the action of the heart depends, 221.  
 Philips, Mr. William, description of the crystals of oxide of tin, by, 59.  
 Philosophical Transactions for 1814, part ii. 134—for 1815, part i. 219.  
 Pitcaithly, mineral water of, analyzed, 256.  
 Plymouth, weather in, for six months, 366.  
 Polar ice, account of, 142.  
 Polarization of light by reflection from transparent bodies, 222.  
 Potassium, easier mode of obtaining, 139.  
 Pressure, effects of, in producing that species of crystallization which forms two oppositely polarized images, 221.  
 Prevost, M. on the equilibrium of radiant heat, 379.  
 Prichard, Dr. J. C. on the older floetz strata of England, 20—geological observations on North Wales, by, 363.  
 Prout, Dr. on the analysis of organic substances, 269.  
 Prussic acid, nature of, 468.

## Q.

Quartz rock, on, 63.

## R.

Radiant heat, on the equilibrium of, 379.  
 Radiatrix, 154.  
 Red head, mineralogy of, 142.  
 Red sand-stone formation, described, 13.  
 Refraction, atmospherical, observations on, 135.  
 Relation between the specific gravity of bodies in their gaseous state and the weight of their atoms, 32.  
 Rents, essay on, 43, 213, 411.  
 Roget, Dr. on a new instrument for performing mechanically the involution and evolution of numbers, 220.  
 Rome, ancient, number of inhabitants in, 75.  
 Rona, island of, structure of, 60.  
 Royal Geological Society of Cornwall, 466.  
 — Medical Society of Edinburgh, prize by, for 1816, 70.  
 — Society, meetings of, 66, 453.  
 Rum, island of, structure of, 60.

## S.

- Sale of minerals, 74.  
 Saliva, 397.  
 Saltpetre, on the production of, 138.  
 Satellites of the Georgium Sidus, 68.  
 Saussure, Theodore de, on the absorption of the gases by different bodies, 241—on the conversion of starch into sugar, 424.  
 Scoresby, Mr. on polar ice, and the practicability of going to the north pole, 143—on the woops, and the size of the whale, 313.  
 Seppings, Mr. his method of constructing ships of war, 134.  
 Septaria, on the formation of, 408.  
 Ships of war, new construction of, 134.  
 Silk, raw, absorption of gases by, 252.  
 Skeleton from *Œnigen* shown to be that of a salamander, 146.  
 Sky, isle of, geological account of, 140.  
 Solution, observations on, 454.  
 Sorbic acid, account of, 66.  
 Spinal marrow, experiments to determine its action on the hearts of fishes, 222.  
 Spring carriages, on, 314.  
 Staffa, account of, 64.  
 Starch, on the conversion of, into sugar, 424—analysis of, 427.  
 Steam engine, explosion of, 236—queries respecting, 465.  
 Steinheilite, 150.  
 Storer, Dr. John, on an ebbing and flowing well, 221.  
 Stratification, on, 216.  
 Stream, on an ebbing and flowing, 221.  
 Sugar of grapes, analysis of, 428.  
 — from starch, analysis of, 427.  
 Sulphate of lime, absorption of gases by, 251.  
 Sunderland lime-stone formation described, 115.

## T.

- Table mountain at the Cape of Good Hope, structure of, 315.  
 Talc, indurated, of the Zetlands, 142.  
 Taylor, Mr. John, on the economy of the mines of Cornwall and Devon, 58.  
 Teneriffe, geological account of, 57.  
 Tennant, Smithson, Esq. biographical account of, 1, 81—on an easier mode of obtaining potassium, 139—on the

- means of producing a double distillation with the same heat, 140.  
 Thermometer, on, 231.  
 Toad found in the trunk of a beech, 11.  
 Trap and sand-stone, junction of, at Stirling Castle, 57.  
 Tungsten, experiments on, 198.

## V.

- Valves, queries respecting, 305.  
 Vascular and extra-vascular parts of animals, on the connection between, 174.  
 Vauquelin, M. accident which happened to, 157—memoir, by, on iridium and osmium, 392.  
 Urea wanting in urine during hepatitis, 392.

## W.

- Wainwright, Rev. Latham, on the literary and scientific pursuits at Cambridge, 294.  
 Wales, north, geological observations on, 363.  
 Walker, Mr. Alex. on the intellectual functions of man and animals, 26, 118—attempt of, to systematize anatomy, physiology, and pathology, 283.  
 Water, resistance of, 278.  
 Webster, Mr. Thomas, on some new varieties of fossil alcyonia, 59.  
 Wells, Dr. answer to Prevost, by, respecting dew, 432.  
 Werner's collection of minerals, 78.  
 Wernerian Society, meetings of, 142.  
 Whale, size of, 74, 313.  
 Wilkinson, Dr. C. on septaria, 408.  
 Williams, J. Esq. on Huel Peever, 141.  
 Wind, force and velocity of, 277.  
 Woops, description of, 313.  
 Wollaston, Dr. W. Hyde, description of an elementary galvanic battery, by, 209.  
 Woods, absorption of gases by, 252.  
 Wool, absorption of gases by, 252.

## Y.

- Ytthro-cerite, 150.  
 Yule, Dr. on the germination and economy of ferns, 142.

### ERRATUM IN VOL. V.

- P. 397, line 1, *for or Changelica, read Archangelica.*

---

### ERRATA IN VOL. VI.

- P. 78, line 6 from bottom, *for eighth, read ninth.*  
P. 276, *for Noldens, read Holden.*  
P. 277, fourth column, line 16, *for 8·295, read 8·225.*  
P. 277, fifth column, line 10, *for 2·268, read 2·368.*  
P. 277, sixth column, line 16, *for 5·988, read 5·980.*  
P. 277, seventh column, line 7, *for 1·490, read 1·590.*  
P. 277, seventh column, line 8, *for 2·070, read 2·079.*  
P. 278, seventh column, line 16, *for 1·486, read 1·480.*  
P. 278, *for 43°, read 45°.*  
P. 280, *for setting more or less on the same tack, read setting more or less sail on the same tack.*







