

Historic, Archive Document

Do not assume content reflects current scientific
knowledge, policies, or practices

& Son.

62.61

Annual Catalogue

...of



SEEDS AND BULBS

✦ ✦ ✦ ✦
 ✦ ✦ ✦ ✦

Offered by

O. W. CLARK & SON.

59 SENECA ST.
cor. Ellicott.

Buffalo, New York

Useful Formulas for Spraying.

PLANT.	FIRST APPLICATION.	SECOND APPLICATION.	THIRD APPLICATION.	FOURTH APPLICATION.
Apple	Before the buds burst, copper sulphate solution.	Just before blossoms open, Bordeaux.	When blossoms have fallen, Bordeaux and arsenites.	8-12 days later, Bordeaux and arsenites. Repeat 14 days later, if necessary.
Cherry	As buds are breaking, Bordeaux. When aphids appear, kerosene emulsion.	When fruit has set, Bordeaux.	10-14 days later if rot appears, Bordeaux.	10-14 days later, ammoniacal copper carbonate.
Currant	At first sign of worms, arsenites.	10 days later, hellebore. If leaves mildew, Bordeaux.	If worms persist, hellebore.	
Gooseberry (English)	When leaves expand, Bordeaux.	10-14 days later, Bordeaux.	10-14 days later, ammoniacal copper sulphate.	10-14 days later, repeat third.
Grape	In spring before buds swell, copper sulphate solution.	When leaves are 1 to 1½ inches in diameter, Bordeaux.	When flowers are open, Bordeaux.	10-14 days later, Bordeaux. Repeat if disease again appears.
Peach, Nectarine	Before buds swell, copper sulphate solution.	Before flowers open, Bordeaux.	When fruit is grown, Bordeaux.	5-7 days later, ammoniacal copper carbonate.
Pear	As buds are swelling, copper sulphate solution.	Just before blossoms open, Bordeaux. Kerosene emulsion when leaves open, for psylla.	After blossoms have fallen, Bordeaux and arsenites.	8-12 days later, repeat third. Repeat if disease again appears.
Plum	When buds are swelling, copper sulphate solution.	When blossoms have fallen, Bordeaux and arsenites.	10-14 days later, Bordeaux and arsenites.	10-20 days later, Bordeaux.
Potato	When beetles first appear, arsenites.	When vines are two-thirds grown, Bordeaux and arsenites.	5-15 days later, Bordeaux.	

BORDEAUX MIXTURE.

Copper sulphate 6 pounds.
 Quicklime 4
 Water 40 gallons.

Bordeaux mixture is made by dissolving 6 pounds of copper sulphate in say 5 gallons of hot water. Take 4 pounds of fresh caustic lime, adding water enough to make a thin whitewash; fasten a piece of coarse sacking over the barrel containing the solution of bluestone, and strain the thin whitewash into it. When this is done, add enough water to bring the whole up to 40 gallons. The cost of this will not exceed 1½ cents per gallon. It is necessary to add the lime in order to prevent the copper sulphate from injuring the foliage. In order to kill the apple worms before they have time to eat their way into the apples, it is necessary to add Paris green to poison the worms. The proportion that is advised is at the rate of 1 pound of Paris green to 200 gallons of water. This would require 62-5 ounces of Paris green to be added to the 40 gallons of Bordeaux mixture. Six ounces, however, will be found to be sufficient. By thus combining the poisonous Paris green with the copper sulphate, we are able to kill two birds with one stone: to prevent the fungus from making the apple scabby, and the young worms of the codling moth from spoiling the fruit.

AMMONIACAL COPPER CARBONATE.

Copper carbonate 1 ounce.
 Ammonia enough to dissolve the copper.
 Water 9 gallons.

The copper carbonate is best dissolved in large bottles, where it will keep indefinitely, and should be diluted with water as required. For same purpose as Bordeaux.

COPPER SULPHATE.

Fresh white hellebore 1 ounce.
 Water 3 gallons.

Apply when thoroughly mixed. For insects which chew.

KEROSENE EMULSION.

Hard soap ½ pound.
 Boiling water 1 gallon.
 Kerosene 2 gallons.

Dissolve the soap in the water, add the kerosene, and churn with a pump for 5 to 10 minutes. Dilute ten times before applying. For insects which suck, cabbage worms, and all insects which have soft bodies.

COPPER SULPHATE SOLUTION.

Copper sulphate 1 pound.
 Water 15 gallons.

Dissolve copper sulphate in the water, when it is ready for use. This should never be applied to foliage, but must be used before the buds break. For peaches and nectarines, use 25 gallons of water. For fungous diseases.

PARIS GREEN.

Paris green 1 pound.
 Water 250 gallons.

If this mixture is to be used upon peach trees, 1 pound of quicklime should be added. Repeated applications will injure most foliage, unless lime is added. Paris green and Bordeaux can be applied together with perfect safety. The action of neither is weakened, and the Paris green loses all caustic properties. For insects which chew.

VALUABLE TABLES.

Quantity of Seed Requisite to Produce a Given Number of Plants and Sow an Acre.

Quantity per acre		Quantity per acre		Quantity per acre	
Artichoke, 1 oz. to 500 plants	6 ozs.	Corn, rice (shelled)	2 qts.	Oats	2 bus.
Asparagus, 1 oz. to 30 ft. of drill	8 lbs.	Corn, sweet, 1 qt. to 200 hills	6 "	Okra, 1½ ozs. to 100 ft. of drill	8 lbs.
Asparagus roots	7.25 bus.	Cress, ½ oz. to 100 ft. of drill	12 lbs.	Onion Seed, 1 oz. to 100 ft. of drill	5 lbs.
Barley	2½ bus.	Cucumber, 1 oz. to 50 hills	2 "	Onion Seed for Sets	40 to 50 "
Beans, dwarf, 1 qt. to 20 ft. of drill	1 "	Egg-Plant, 1 oz. to 1,500 plants	4 ozs.	Onion Sets, 1 qt. to 40 ft. of drill	8 bus.
Beans, pole, 1½ pts. to 100 hills	½ "	Endive, ½ oz. to 100 ft. of drill	4½ "	Parsnip, 1 oz. to 150 ft. of drill	4 lbs.
Beet, garden, 1 oz. to 75 ft. of drill	5 lbs.	Garlic, bulbs, 1 lb. to 10 ft. of drill	4 "	Parsley, 1 oz. to 150 ft. of drill	3 "
Beet, Mangel, 1 oz. to 60 ft. of drill	6 "	Grass, Kentucky Blue	4 bus.	Peas, garden, 1 pt. to 75 ft. of drill	2 bus.
Broccoli, 1 oz. to 5,000 plants	2 ozs.	Grass, Hungarian and Millet	½ "	Peas, field	3 "
Broom Corn	10 lbs.	Grass, Mixed Lawn	1 "	Pepper, 1 oz. to 1,500 plants	3 ozs.
Brussels Sprouts, 1 oz. to 5,000 plants	2 ozs.	Grass, Orchard, Perennial Rye, Red Top, Fowl Meadow and Wood Meadow	2 "	Potatoes	8 bus.
Buckwheat	½ bus.	Grass, Red Top, Fancy Clean	8 to 10 lbs.	Pumpkin, 1 pt. to 100 hills	4 lbs.
Cabbage, 1 oz. to 3,500 plants	3 ozs.	Grass, Timothy	½ bus.	Radish, 1 oz. to 100 ft. of drill	10 "
Carrot, 1 oz. to 150 ft. of drill	3 lbs.	Horse Radish Roots	15,000 to 20,000 "	Rye	1½ bus.
Cauliflower, 1 oz. to 3,500 plants	2½ ozs.	Kale, 1 oz. to 5,000 plants	2 ozs.	Salsify, 1 oz. to 150 ft. of drill	8 lbs.
Celery, 1 oz. to 5,000 plants	2 "	Kohl-Rabi, ½ oz. to 100 ft. of drill	4 lbs.	Spinach, 1 oz. to 100 ft. of drill	1 "
Chicory	4 lbs.	Leek, ½ oz. to 100 ft. of drill	4 "	Sunflower	8 "
Clover, Alsike and White Dutch	6 "	Lettuce, ½ oz. to 100 ft. of drill	3 "	Squash, Summer, 4 oz. to 100 hills	2 "
Clover, Lucerne, Large Red and Crimson Trefoil	8 lbs.	Melon, Musk, 1 oz. to 60 hills	2 "	Squash, Winter, 6 oz. to 100 hills	2 "
Clover, Medium	10 "	Melon, Water, 1 oz. to 30 hills	3 "	Tomato, 1 oz. to 3,500 plants	2 ozs.
Collards, 1 oz. to 3,000 plants	3 ozs.	Nasturtium, 2 oz. to 100 ft. of drill	15 "	Turnip, 1 oz. to 200 ft. of drill	1½ lbs.
				Vetches	2 bus.
				Wheat	1½ "



O. W. CLARK & SON'S

Annual Catalogue of

VEGETABLE, FIELD AND FLOWER SEEDS.

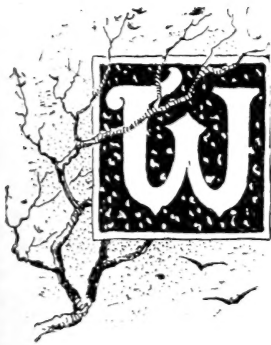

WE TAKE pleasure in presenting to our many friends and customers our Thirtieth Annual Catalogue of **Seeds, Bulbs, Garden Tools, Supplies, Etc., Etc.**

That **Clark's Seeds** continue to increase in popularity is shown by the steady growth of our business, which encourages us to continue the straightforward, systematic policy which we have always adhered to. Quality is our first consideration, and purchasers placing their orders with us may feel assured of receiving only goods of the highest standard of excellence.

In compiling this book, we have endeavored to list only the best of Standard Varieties of Vegetables and Flowers, together with Novelties and Specialties that have proved themselves worthy of a place in the garden.

ORDERING GOODS BY MAIL from any first-class house is as safe, as sure, and you will be as honestly treated, as if you gave the order in person, handing your money over the counter.

We send free by mail, safe arrival guaranteed, all Vegetable and Flower Seeds ordered at Catalogue rates in packets or ounces.

When Seeds are ordered in quantities of one-quarter pound and upwards, postage must be added at the rate of 8 cents per pound, except Beans and Peas, for which add 15 cents per quart, and for Corn and Onion Sets 10 cents per quart, to the Catalogue prices.

HOW TO ORDER.

Orders should be written on the order sheet separate from letter. Keep a copy of your order, and be sure to sign your name, post office, express office, county and state. Neglect of this often causes much annoyance. If you do not receive your Seeds in a reasonable time after ordering them, write again, telling what was ordered, amount of money sent, etc. When goods are to be shipped by Freight or Express, give plain

shipping directions; otherwise we will use our best judgment in the matter. If you want only a few packages, do not hesitate to send for them. We take as much pains to send them promptly as we do large orders.

Any express company will receive through their agents orders for our goods, making no additional charge for their services.

REMITTANCES.

Orders, to insure prompt attention, should always be accompanied by a remittance, or good reference. We will be responsible for money sent to us by Post Office Order, Registered Letter, Bank Draft, or Express. When these are not obtainable, or to make proper change, we accept postage stamps the same as cash (two-cent stamps preferred).

C. O. D. Orders amounting to over \$10 may be sent by Express, C. O. D., if desired, provided one-fourth of the amount accompanies the order. Plants or other goods of a perishable nature cannot be sent C. O. D.

We guarantee all shipments of Seeds, Bulbs, Plants, Implements, Etc., to reach the purchaser safely and in good condition.

WARRANTIES.

We test our seeds as to vitality, and can assure our customers that none are superior to them in purity. Complaints sometimes made that Seeds are not good may quite as often be attributed to other causes as to the quality of the Seeds. There are hundreds of contingencies continually arising to prevent the best Seeds from always giving satisfaction, such as sowing too deeply, into too wet or dry soil, insects of all descriptions destroying the plant as soon as it appears, wet weather, cold weather, frosts, etc., etc. A very common cause is heavy rains after sowing, and the consequent baking of the ground afterward, and from many other causes which the planter cannot govern. It is, therefore, impossible for us to guarantee Seeds under any circumstances, nor will we be in any way responsible for the crop. If our Seeds are not accepted on these terms, they must be returned at once, and the money that has been paid for them will be refunded.

As the Seed season continues only for a few months in the year, there is, of course, a great pressure of business just at the *sowing season*. Except in cases of extreme urgency all orders will be executed in rotation as received. Please forward your orders as soon as possible after the receipt of this Catalogue.

IRWIN B. CLARK.

O. W. CLARK & SON,

59 Seneca Street, Cor. Ellicott, Buffalo, N. Y.

TELEPHONE, SENECA, 174.





Selected Seeds.

NEW AND STANDARD VEGETABLES,

Embracing all the best varieties in cultivation, with directions for their culture.

IMPORTANT.—Market-gardeners, public institutions and clubs who use seeds in large quantities will save money by writing us for special quotations. It is no trouble to give estimates or information.

☞ Half-pounds supplied at pound rates; half-pecks at peck rates; half-bushels at bushel rates

Artichoke.

French, ARTICHAUT. German, Artischofe. Spanish, Alcachofa.

CULTURE.—One ounce will produce 500 plants. Sow in drills 1 foot apart and 2 inches deep, in moist rich soil, and transplant to permanent beds, allowing a space of 3 feet between the rows and 4 feet between each plant. Liberal treatment will insure fine heads.

Large Green Globe. The best for general cultivation

Oz.	¼lb.	Lb.
\$0 30	\$1 00	\$3 50

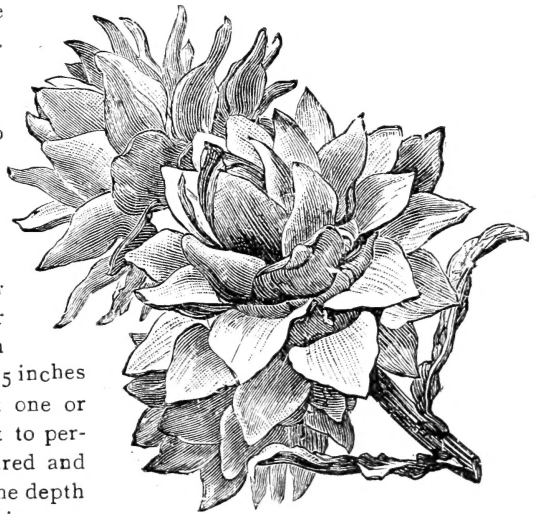

Artichoke.

Asparagus.

French, ASPERGE. German, Spargel. Spanish, Esparrago.

CULTURE.—One ounce will produce 600 plants, and sow 60 feet of drill. Beds are usually formed by setting out 2 or 3-year-old roots, but if you wish to raise from seed, sow in drills 18 inches apart and 1½ inches deep; thin early, leaving 15 inches between the plants. At one or two years old transplant to permanent beds, well manured and thoroughly trenched to the depth of 2 feet. Set the plants in rows 3 to 4 feet apart and 2 feet distant in the rows, carefully spreading out the roots and covering from 6 to 8 inches. Every fall apply a good dressing of thoroughly decomposed manure, and in spring fork this in thoroughly. A dressing of coarse salt, given once a year at the rate of 2 pounds to the square yard, will be beneficial. Cutting may commence the third year from sowing.

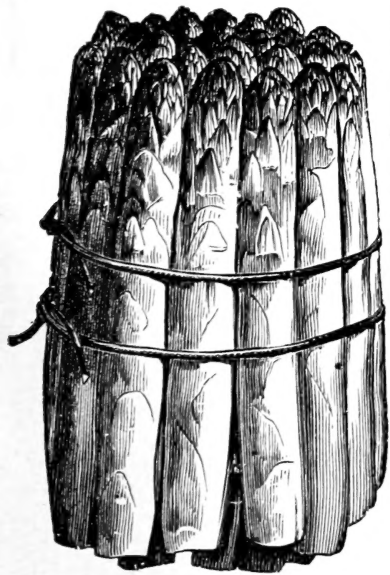

Palmetto Asparagus.

	Oz.	¼lb.	Lb.
Columbian Mammoth White. A large, early variety; the best for general use	\$0 10	\$0 15	\$0 50
Two-year old roots per 100	\$1, 1,000	\$8 .	
Palmetto. A recent introduction; very productive, and of a bright green color	10	25	75
Two-year-old roots per 100	\$1, 1,000	\$8 .	

☞ If roots are ordered by mail, add 50 cents per hundred for postage.

All packets in this Catalogue are 5 cents, except where noted.

Beans.

DWARF SNAP, or BUSH.

French, HARICOTS NAINS. German, Busch-Bohnen. Spanish, Frijole Nano.

Under this head are classed all the low-growing sorts, variously called Bush, Snap, String, Wax or French Beans.

CULTURE.—One quart for 100 feet of drill, two bushels for an acre. In our latitude Beans should not

be planted until the first or second week in May, or when the ground has become warm and all danger of frost is past. A succession of sowings may be made until August. Plant in drills, about 2 inches deep, and from 18 inches to 2 feet apart, according to the richness of the soil; the poorer the soil the closer they may be planted. The seeds should be dropped about 3 inches apart.

Davis Kidney Wax. Undoubtedly the finest market variety in existence. Pods 7 to 9 inches in length, creamy white color, straight and handsome. Entirely free from rust, and exceedingly prolific. Pkt. 10 cts., pt. 35 cts., qt. 60 cts., $\frac{1}{2}$ pk. \$2.25.



Challenge Dwarf Black Wax.

Wardwell's Kidney Wax. This is a very robust and hardy variety, producing a heavy crop of long broad, flat pods of a delicate waxy yellow, entirely stringless; extremely tender and of excellent flavor. Pkt. 10 cts., qt. 30 cts., pk. \$1.75, bus. \$4.50.

Improved Golden Wax. A vigorous grower, enormously productive and of grand quality; a great improvement on the old variety. Qt. 25 cts., pk. \$1.25, bus. \$3.50.

Keeney's Rustless Golden Wax. A handsome Bush Bean; pods meaty and well filled; rich yellow color, entirely stringless; will not rust. Pkt. 10c., pt. 30c., qt. 50c.

The Challenge Dwarf Black Wax Bean. Extra early. This is a decided improvement over the Dwarf Black Wax; is one of the earliest of the Wax Beans, wonderfully productive and unexcelled in quality. The vines are vigorous and extremely hardy. Pkt. 10 cts., qt. 25 cts., pk. \$1.25, bus. \$4.

Black Wax, or Butter. The pods, when ripe, are of a waxy yellow, transparent, very tender and delicious; an excellent variety. Qt. 25 cts., pk. \$1.25, bus. \$3.50.

Improved Red Valentine. Ten days earlier than the Early Valentine; ready to pick in 35 days after planting. The pods are very thick and fleshy, of finest quality, and unequalled in uniformity of ripening, which latter fact, combined with its earliness, makes it one of the most profitable sorts for the gardener. Qt. 25 cts., pk. \$1.25, bus. \$3.50.

Long Yellow Six Weeks. A standard sort for market or family use. Pkt. 10 cts., qt. 25 cts., pk. \$1.25, bus. \$3.50.

Extra Early Refugee Wax Bean. A perfect Refugee, with long, round, yellow wax pods; an immense yielder, and suitable for either early or late sowing. A valuable acquisition to the list. Pkt. 10c., qt. 25c., pk. \$1.50, bu. \$5.



Burpee's Bush Lima.

Extra Early Refugee. A selection from and possessing all the first-rate qualities Pkt. Qt. Pk. Bus.

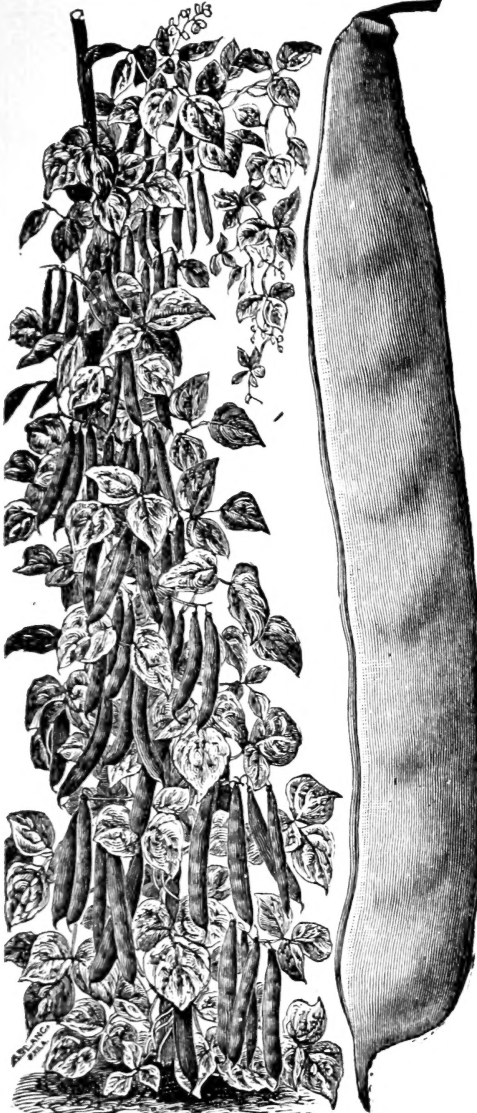

Dutch Case-Knife Bean.

of the well-known Refugee, which it is gradually superseding. It is an immense yielder, and sure to produce a crop; is an excellent shipper, and fast becoming one of the most popular green-podded Beans in cultivation \$0 10 \$0 25 \$1 25 \$3 50

Burpee's Bush Lima. Grows from 18 to 20 inches high, erect and stout, branching so vigorously that each plant develops into a circular bush 2 or 3 feet in diameter. The bush character is thoroughly established, not one plant in a thousand showing any disposition to run. It yields immensely, bearing handsome, large, well-filled pods, the Beans being identical in size and flavor with the well-known large Pole Limas 10 40 2 50 8 00

Beans, Pole or Running.

French, HARICOTS A RAMES. German, Stangen-Bohnen. Spanish, *Frijole Vastago.*

CULTURE.—One quart will plant 60 to 70 hills; half a bushel will plant an acre. The soil should be mellow, rich and warm. Lay the ground out in hills 4 feet apart each way, and set poles 8 or 10 feet long firmly in the hills before putting in the seed. Plant 5 or 6 Beans in a hill, and cover about 2 inches deep; leave 3 healthy plants at each pole, and when a few inches high draw a little earth around them as support. Use the cultivator freely to keep the soil mellow and clean.

- Golden Cluster.** Produces long, golden yellow, stringless pods, tender and of delicious quality 10 40 2 25
- Horticultural, or Speckled Cranberry.** Popular old favorite; useful either green or dried 10 40 2 00
- Scarlet Runner.** Ornamental and useful; produces brilliant scarlet flowers, and the Beans are used either green or shelled 10 40 2 00

	Pkt.	Qt.	Pk.
Extra Early Jersey Lima. Fully two weeks earlier than any other Pole Lima; they are always tender and delicious	\$0 10	\$0 40	\$2 25
Dreer's Lima. Smaller Beans, but earlier and more prolific than Large Lima	10	40	2 00
Large White Lima. Always popular, and only surpassed by other sorts in earliness	10	40	2 25
Dutch Case-Knife. An old-fashioned productive and early variety	10	40	2 00

Broccoli.

French, CHOU BROCOLI. German, Spargel-Rohf. Spanish, *Brocoli.*

CULTURE.—One ounce will produce 3,000 plants. Sow thinly in seed beds. For permanent location select fresh land, deeply tilled. When the plants are strong enough, set out in rows 2 feet apart each way, setting the plants well down to their lower leaves. Cultivate frequently, and give a plentiful supply of water during all stages of their growth.

- White Cape.** Dwarf, compact habit; firm white heads of fine quality. Oz. 25 cts., ¼ lb. 75 cts.
- Improved Purple Cape.** A standard sort; very hardy and productive. Oz. 30 cts., ¼ lb. 85 cts.



Broccoli.

Remember that postage on Beans is 15 cents a quart.

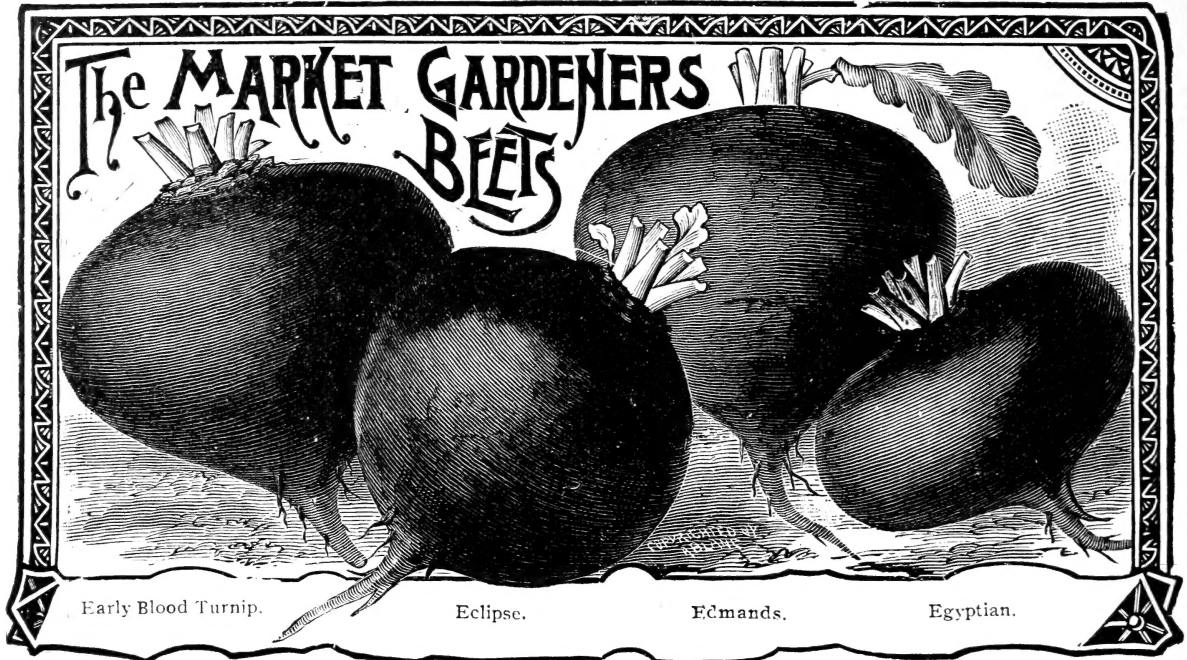

Beets.

French, *BETTERAVE*. German, *Runkelrüben*. Spanish, *Remolacha*.

CULTURE.—One ounce will sow 50 feet of drill; 5 pounds will sow an acre. Rich, deep soil not too recently manured is best for this crop; sow about 1 inch deep in drills 15 inches apart, and when well established, thin the plants to 6 inches apart in the row.

Detroit Dark Red. New; upright-growing tops, with few leaves and small neck; firm-fleshed and perfectly shaped roots, with dark red, tender, crisp sweet flesh, make this an ideal early and general market sort, popular alike with grower and consumer. Oz. 10 cts., $\frac{1}{4}$ lb. 20 cts., lb. 60 cts.

Dewing's Extra Early Turnip. Flesh deep blood-red, tender and sweet. Oz. 10 cts. $\frac{1}{4}$ lb. 20 cts., lb. 60 cts.

Eclipse. Extra early, uniform shape; bright red, fine grained and delicious. Oz. 10 cts., $\frac{1}{4}$ lb. 20 cts., lb. 60 cts.

Edmand's. Handsome shape; flesh of a dark blood-red, sweet and tender. Oz. 10 cts., $\frac{1}{4}$ lb. 20 cts., lb. 60 cts.

Egyptian Blood Turnip. Well-known variety, of a rich, deep crimson color. Oz. 10 cts., $\frac{1}{4}$ lb. 20 cts., lb. 60 cts.

Early Bassano. Very early; flesh pink, zoned with white, sweet and tender when young. Oz. 10c., $\frac{1}{4}$ lb. 15c., lb. 50c.

Early Blood Turnip. Dark red, tender, and keeps well. Oz. 10c., $\frac{1}{4}$ lb. 15c., lb. 50c.

Long Smooth Blood. An excellent large, late variety. Oz. 10 cts., $\frac{1}{4}$ lb. 15 cts., lb. 50 cts.

Swiss Chard. Known also as *Silver or Sea Kale Beet*. Cultivated only for its leaves, the midribs of which are cooked like asparagus. Oz. 10 cts., $\frac{1}{4}$ lb. 25 cts., lb. 75 cts.

Mangel-Wurzel and Sugar Beets.

CULTURE.—Five or 6 pounds will sow one acre. The seed should be planted in rows 2 feet apart and thinned to 8 inches in the rows. To obtain the best results from

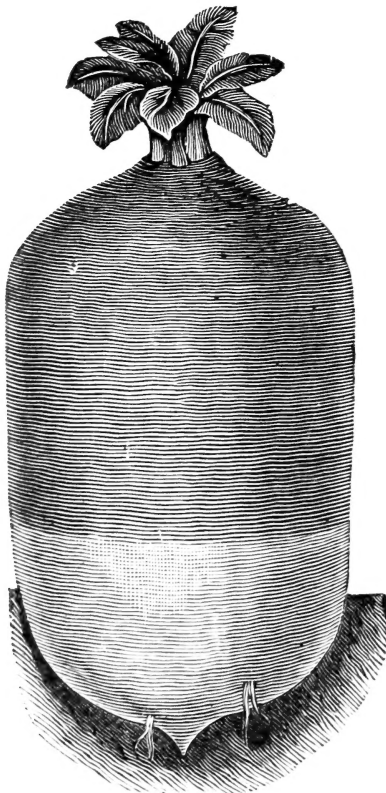

Golden Tankard Mangel-Wurzel.

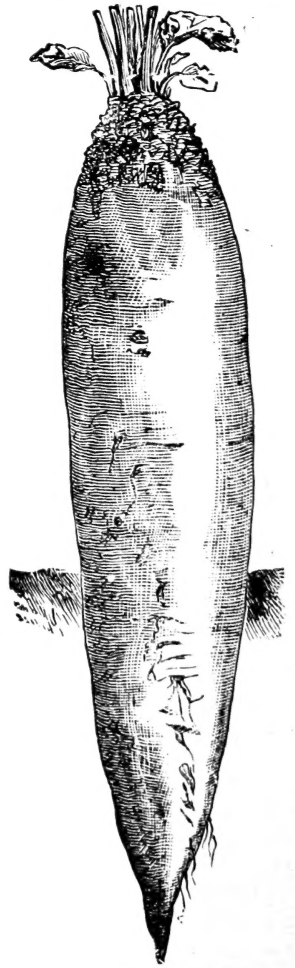

Long Red Mangel.

this crop, use deep soil, well plowed; if the soil is thin, a liberal application of an honest chemical fertilizer is necessary. The value of Beets for stock feeding cannot be over-estimated. The results from their use are clearly shown in the improved health and condition of animals, the increased yield of milk in cows, and the great saving of hay. They can be raised at a very trifling cost, and yield immensely.

Golden Tankard Mangel-Wurzel. Nutritious, and valued for its milk-producing qualities. Oz. 10 cts., $\frac{1}{4}$ lb. 15 cts., lb. 35 cts.

Lane's Improved Sugar Beet. A popular variety, yielding as high as 30 tons per acre; the roots, are of large size and symmetrical. Oz. 10 cts., $\frac{1}{4}$ lb. 15 cts., lb. 35 cts.



Brussels Sprouts.

Mammoth Long Red Mangel-Wurzel. This variety grows to an immense size, and is the most desirable sort to grow for stock-feeding. Oz. 10 cts., $\frac{1}{4}$ lb. 15 cts., lb. 30 cts.

Orange Globe. Useful in shallow ground; productive, and a good keeper. Oz. 10 cts., $\frac{1}{4}$ lb. 15 cts., lb. 35 cts.

Red Globe. Similar to the preceding, except in color. Oz. 10 cts., $\frac{1}{4}$ lb. 15 cts., lb. 35 cts.

Brussels Sprouts.

French, CHOU DE BRUXELLES. German, Rosenkohl. Spanish, *Berza de Brusels.*

CULTURE.—One ounce will produce 3,000 plants. Sow as directed for broccoli, and set the plants 2½ feet apart each way. They require a long season of growth, but with suitable soil and liberal manuring an excellent crop of this most delicious vegetable can be secured. The splendid flavor of properly cooked Brussels Sprouts would commend them to epicures and others, if generally known. Though of the cabbage family, the flavor is far more delicate and pleasing than that of any cabbage. This is one of the old world's productions which has yet to become thoroughly appreciated in the new world.

Improved Dwarf. Very productive, tender and of rich flavor. Pkt. 10 cts., oz. 25 cts., $\frac{1}{4}$ lb. \$1.75.

Cabbage.

French, CHOU. German, Kohl. Spanish, *Berza de repollo.*

CULTURE.—One ounce will produce 3,000 plants; 5 ounces will produce sufficient plants for an acre. Commence to sow the seed early for succession. Transplant as soon as large enough to fresh, rich soil, in rows 2 feet apart and 18 inches in the rows. For late use, sow the Drumhead sorts in spring, and transplant to well-manured ground 3 feet apart each way. In planting Cabbage or cauliflower, care should be observed that the stem is set under the ground as far as the first leaf. The ground should be well worked, to produce good heads, and hoed as many as three times during the season, drawing the earth slightly about the stems. Should the Cabbage-worm or other insect pests annoy, "Hammond's Slug-Shot" is safe, easily applied and effectual; do not delay in thus removing any insect that may appear.

Extra Early Etampes. A variety of the Wakefield type, but earlier; valuable for family use. Oz. 20 cts., $\frac{1}{4}$ lb. 50 cts., lb. \$1.50.

Selected Early Jersey Wakefield. Heads compact, cone shaped and of medium size; a general favorite in the New York and Philadelphia markets. Oz. 30 cts., $\frac{1}{4}$ lb. 60 cts., lb. \$2.

Burpee's Allhead Early. Deep, flat heads, remarkably solid, few loose leaves; uniform in size and shape; earliest of all large Cabbages. Oz. 25 cts., $\frac{1}{4}$ lb. 60 cts., lb. \$1.75.

Burpee's Surehead. Produces large, round, flattened heads of the Flat Dutch type, uniform, hard and firm. Oz. 25 cts., $\frac{1}{4}$ lb. 60 cts., lb. \$1.75.

Acme Flat Dutch. This excellent strain differs from the Premium Flat Dutch in that it is quicker growing, matures earlier, and may therefore be started later; a sure header. Oz. 25 cts., $\frac{1}{4}$ lb. 60 cts., lb. \$1.75.

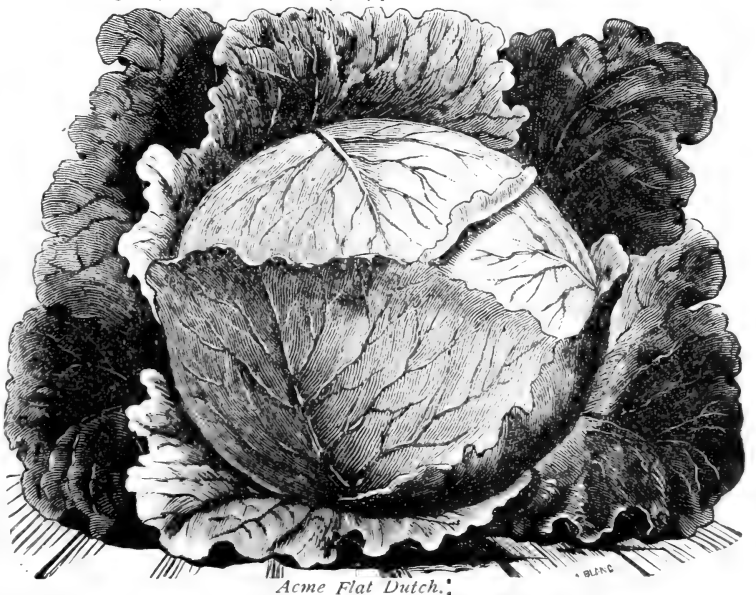

Acme Flat Dutch.

Our selected Seeds are all new crop and of high germinating power.

CABBAGE, continued.

Henderson's Early Summer. One of the best large, early sorts; uniform and of excellent quality	Oz. 30	¼lb. \$0 60	Lb. \$1 75
Early Winnigstadt. Medium-sized, conical-shaped heads, very hard; one of the best for general use	20	50	1 50
Fottler's Brunswick. Heads large, solid, flat, and of best quality; will stand long without cracking	25	50	1 50
All Seasons. A general favorite in this section; heads of good size and fine quality; one of the best varieties yet introduced	25	60	1 75
Henderson's Succession. Desirable for medium early, main crop or late use; true to its type	25	60	1 75
Henderson's Autumn King. The introducers of this Cabbage claim it to be the finest of all for winter; very large heads and a good keeper	50	75	2 00
Premium Late Flat Dutch. Our stock of this variety is from carefully selected heads, and we believe superior to any other strain	25	60	1 75
Premium Late Drumhead. One of the largest, most solid, and best-keeping late varieties; seldom fails to head, and is of good quality	25	60	2 00
Vick's Improved Danish Ballhead. A favorite variety with our market-gardeners; a sure header, very hard and firm	40	1 00	3 00
Early Paris Savoy. Heads round and solid, and of excellent table quality	30	75	2 50
Perfection Drumhead Savoy. For winter use this variety is unsurpassed; heads large, solid, and very tender. Oz. 25 cts., ¼lb. 75 cts., lb. \$2.50.			
Mammoth Rock Red. The largest and surest heading Red Cabbage; deep red color, very hard and solid. Oz. 25 cts., ¼lb. 60 cts., lb. \$2.			
Earliest Blood-Red Erfurt. The earliest deep red variety; heads hard, of medium size. Pkt. 25c., ¼lb. 75c., lb. \$2.50.			

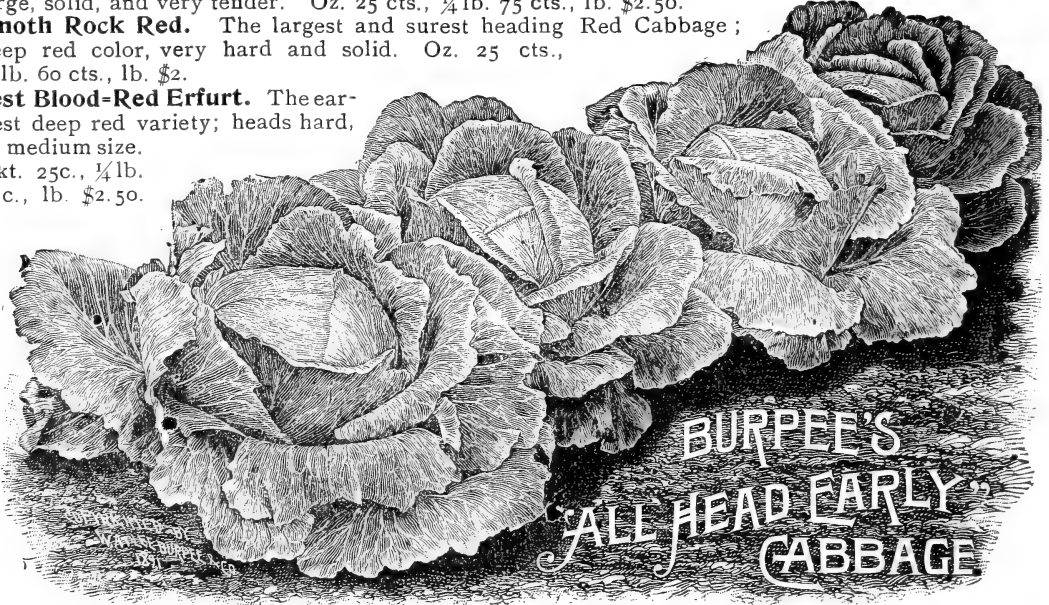

Corn-Salad, or Fetticus.

French, MACHE. German, Stedtsalat. Spanish, Canonigos.

CULTURE.—One ounce will sow 60 feet of drill. Mellow, rich soil, in a rather open situation, is desirable. The drills should be 6 inches apart and very shallow—not more than one-fourth of an inch deep. Thin the plants to 4 inches in the row, and keep well cultivated.

Large-Seeded. The best variety for general use	Oz. \$0 10	¼lb. \$0 15	Lb. \$0 50
---	------------	-------------	------------



True Water-Cress.

Cress, or Pepper-Grass.

French, CRESSON. German, Kresse. Spanish, Mastuerzo.

CULTURE. One ounce will sow 100 feet of drill. Sow thickly in shallow drills about 6 inches apart; repeat at short intervals, as it soon runs to seed. The seed of Water Cress should be scattered by the side of running water or near springs, and is soon in full bearing, and lasts a long time.

Extra-Curled. of beautiful appearance and fine flavor	Oz. \$0 10	¼lb. \$0 15	Lb. \$0 50
True Water-Cress. Mild and tender	50	1 50	5 00

The best forcing Lettuce: Clark's Hubbard Market.

Cauliflower.

French, CHOUFLEUR. German, Blumenkohl. Spanish, *Coliflor*.

CULTURE.—One ounce will produce 3,000 plants. The cultural directions given for cabbage will apply to this crop, but the soil should be more heavily manured. Keep them well hoed, and bring the earth gradually up to the stems. Water freely in dry weather, and especially when they begin to head. Never allow the plants to become crowded in the seed-bed; transplant them with great care, as any check will injure, if not entirely prevent, the formation of the head.

	Pkt.	Oz.
Extra Early Dwarf Erfurt. For earliness and delicacy of flavor this has no equal; without exception the best variety grown	\$0 50	\$5 00
Henderson's Early Snowball. An extremely early dwarf variety, producing magnificent heads of fine quality; market-gardener's favorite	25	3 50
Early Paris. Large, and recommended for early use	10	75
Half-Early Paris. Desirable as a second early	10	60
Large Algiers. Extra-fine, late variety, and a sure header	\$0 10	\$0 60
Lenormand. Short-stemmed late sort, with very heavy heads	10	60
Veitch's Autumn Giant. Very large, firm white heads; choice late sort	10	60

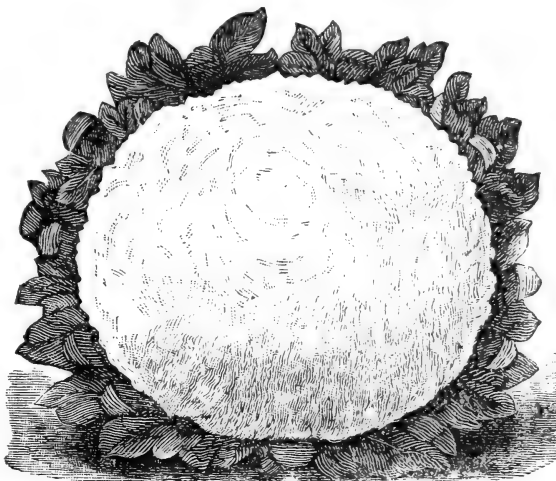

Henderson's Early Snowball.

Pkt. Oz.

Chicory.

French, CHICOREE. German, Cichorie. Spanish, *Endivia*.

CULTURE.—One ounce will sow 100 feet of drill. Sow in rich soil in rows 1 foot apart, and thin to 9 inches in the row. In the fall lift the roots, pack in boxes, and blanch in dark cellar. The leaf-growth furnishes a delicious salad, or may be cooked in the same manner as sea-kale. The large-rooted variety should be sown in the spring, the roots dug in the fall, cut in small pieces and dried.

	Oz.	¼lb.	Lb.
Common. (<i>Barbe de Capucine</i> .) Much prized as a salad	\$0 15	\$0 35	\$1 25
Large-Rooted. Roots of this variety are used as a substitute for coffee	15	50	1 50

Carrots.

French, CAROTTE. German, Möhre. Spanish, *Zanahoria*.

CULTURE.—One ounce will sow 150 feet of drill; 3 pounds are required for an acre. The most suitable soil is a rich, deep, sandy loam, not too recently manured. Sow rather thinly in drills 12 to 15 inches apart, according to the sorts, thinning out to 6 or 7 inches between the plants. In field culture the rows should be at least 2 feet apart, so that the crop can be worked with the horse cultivator.



Danvers.

	Oz.	¼lb.	Lb.
Earliest French Forcing. Roots small, globe-shaped; delicious flavor; the very best early. \$0 15 \$0 30 \$1 00			
Early Scarlet Horn. Deep red flesh, tender and delicate	10	25	75
Chantenay. One of the very best half-long stump-rooted sorts; both in color and shape superior to any other	10	25	75
Danver's Half-Long. Of good quality and exceedingly productive	10	25	75
Guerande, or Oxheart. Thick and short; of fine color and flavor	10	30	1 00
Improved Long Orange. St. Valery strain, a careful selection; bright orange-red; excellent for main crop	10	25	60
Long White Belgian. A productive variety for field culture	10	20	50

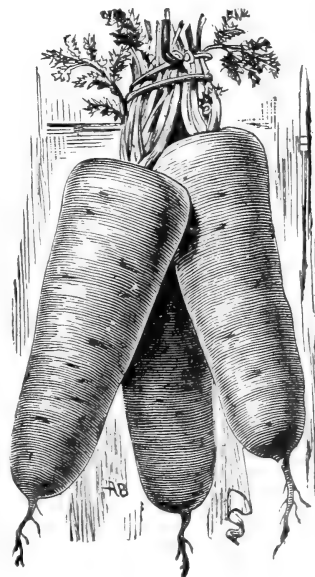

Chantenay.

Celery.

French, CELERI. German, Sellerie. Spanish, *Apio*.

CULTURE.—One ounce will produce 7,000 plants. Sow in light, rich soil, in shallow drills, and cover the seed lightly with finely sifted mold. Prick the seedlings out into beds of very rich soil, 3 inches apart. Water freely, and shade from sun until established. When the plants are 5 to 6 inches high, transplant to rows 3 to 4 feet apart, according to the variety, allowing 8 inches between the plants in the row. Cultivate freely, and earth up to blanch the stems, pressing the soil firmly around the plant almost to the top, care being taken not to cover the tops of center shoots. Remember that this crop well repays generous treatment.

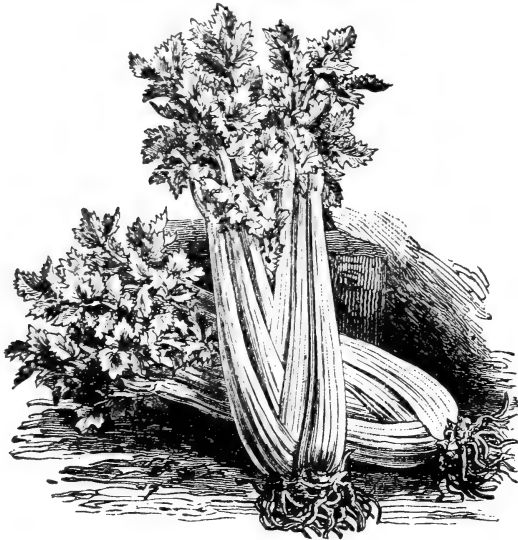

Perfection Heartwell.

Henderson's Perfected White Plume. The best early variety for market-gardeners or for family use; we have an exceptionally fine strain \$0 40 \$1 25 \$4 00

Perfection Heartwell. (Thorburn's Strain.) A very large, solid growing variety of excellent flavor and creamy white color; large golden

yellow heart; the finest of all for winter use	Oz.	¼lb.	Lb.	25	75	3 00
Giant Golden Heart. An improved strain; excellent for winter use; market-gardeners find it especially desirable				25	75	3 00
Giant Pascal. The stalks are very large, thick, solid, crisp, and of a rich, nutty flavor, free from any trace of bitterness; it blanches very easily and quickly, and retains its freshness a long time; the heart is golden yellow; very full and attractive.	Oz.	¼lb.	Lb.	\$0 25	\$0 60	\$1 75
Golden Self-Blanching. An early sort; rich color, fine flavor; easily blanched.				40	1 25	4 00
Kalamazoo. A large, ribbed, good half-dwarf; favorite market sort.				20	50	1 50
Boston Market. An old favorite; tender, crisp, and of mild flavor.				25	75	2 50

Celeriac.

Large Smooth Prague. A variety of Celery with turnip-shaped roots, white-fleshed, comparatively tender, with the flavor of celery stalks 25 60 1 50

Chervil.

French, CERFEUIL. German, Garten-Kerbel. Spanish, *Perifollo*.

CULTURE.—One ounce will sow 50 feet of drill. Sow in rows 1 foot apart, and cover very lightly. When the plants show themselves, thin out to 8 inches apart in the drills. If cut down close the stems will soon sprout again.

Curled. Used in soups and salads; also for garnishing. \$0 15 \$0 40 \$1 50

Tuberous-Rooted. A variety with edible roots 20 75 2 50



Golden Self-Blanching.

Corn, Sweet or Sugar.

French, MAIS DE SUCRE. German, Zucker Weisßkorn. Spanish, *Maiz*.

CULTURE.—Plant about the middle of May, or as soon as the ground is dry (if planted too early, Corn is apt to rot), in hills 3 ft. apart each way; 7 or 8 kernels in a hill; hoe often and draw up dirt to the stems; thin to 4 stalks, and break off side shoots. Use plenty of old, fine manure. For succession, plant every 2 or 3 weeks until the last of July.

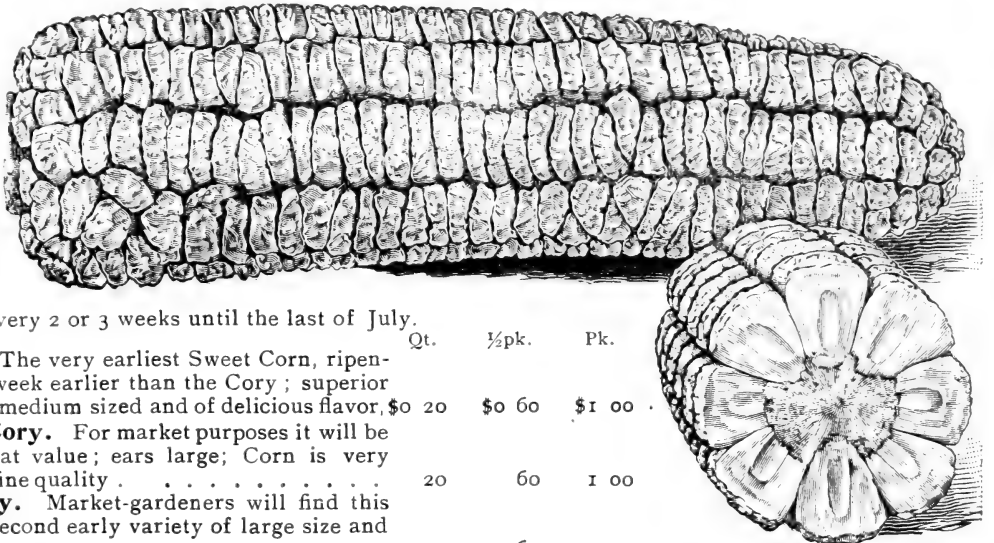

First of All.

	Qt.	½pk.	Pk.
First of All. The very earliest Sweet Corn, ripening nearly a week earlier than the Cory; superior quality; ears medium sized and of delicious flavor, \$0 20	20	\$0 60	\$1 00
Extra-Early Cory. For market purposes it will be found of great value; ears large; Corn is very sweet and of fine quality	20	60	1 00
Shaker's Early. Market-gardeners will find this an excellent second early variety of large size and fine flavor	20	60	1 00
Clark's Nonesuch. A second early and very superior market sort; strong grower and heavy yielder; of finest table quality. Large-sized ears, 12 to 14 rowed	\$0 20	\$0 60	\$1 00



Early White Flint.

Early Crosby. One of the best early sorts; of dwarf habit; good-sized ears with small kernels; a desirable sort	20	50	75
Early Minnesota. Small ears of excellent quality; very productive	20	50	75
Stabler's Early. Of larger size than usual for the early kinds. It is remarkable for fine flavor, sweetness and earliness; desirable for canning, and popular with market-gardeners	20	50	75
Country Gentlemen. Large ears with very small cob; kernels deep. The tenderest and sweetest of all. Late	20	50	75
Stowell's Evergreen. A favorite late, sweet variety, and largely grown by market-gardeners; popular for canning; remains tender a long time.	20	50	75
Excelsior Sugar. A superb sort, with large, well-filled ears; very sweet	25	50	75
Black Mexican. Late; very sweet, and of excellent flavor	20	50	75
Late Mammoth. The largest variety grown; excellent for market	20	50	75

Field and Ensilage Corn.

	Bus.
Early White Flint. A very desirable variety for field culture; ears 8-rowed, about 10 inches long; kernel white, very sound and heavy; very desirable sort for field culture, \$1 25	\$1 25
Longfellow Flint. A standard variety for a main crop; ears long, set low on the stalk, which grows tall; color deep yellow, and similar to the Early White Flint	1 35
Early Mastodon Dent. The earliest of the large-eared Dent varieties, and will mature in 100 days with favorable Corn weather	1 25
White Cap Yellow Dent. Ears as large as Leaming, and matures a week earlier	1 25
Leaming. The best variety for ensilage or dry fodder, for which it is largely used	1 00
Red Cob Ensilage. Our stock of this well-known variety is genuine. Look for registered trade-mark on each bag	75
White Rice. A very choice white variety; best for popping; may be sown thickly in rows; requires ordinary culture	2 00

Cucumbers.

French, CONCOMBRE. German, Gurke. Spanish, Pepino.

CULTURE.—One ounce will plant 100 hills; 2 pounds will plant 1 acre. They succeed best in a warm, moist, rich, loamy soil. Plant in hills 4 feet apart each way. Leave 4 of the strongest plants to each hill, but do not thin out until plants are strong enough to resist the attacks of insects. The English forcing varieties can be grown in hotbeds where the temperature does not fall below 65 degrees at night. Many of this class grow from 20 to 30 inches in length.

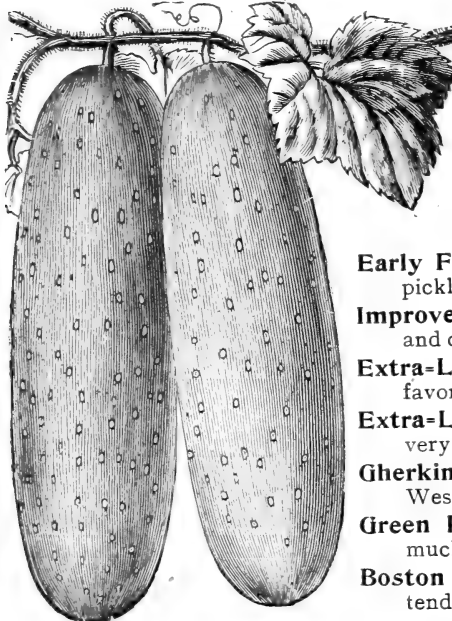

Improved White Spine.

	Oz.	¼lb.	Lb.
Early Russian. One of the earliest; fruit small and produced in pairs	\$0 10	\$0 25	\$0 75
Early Frame. An excellent early; used largely for pickles	10	15	50
Improved White Spine. Very popular; flesh crisp and of good flavor	10	15	50
Extra-Long White Spine. The market-gardener's favorite, either for forcing under glass or outside	10	25	75
Extra-Long Green. Handsome in shape and color; very desirable	10	15	50
Gherkin. Used only for pickles. Known also as West India Bur	20	60	2 00
Green Prolific. Resembles Boston Pickling, but much earlier	10	15	50
Boston Pickling. Of uniform size; dark green, tender and productive	10	15	50
Hill's Forcing White Spine. Of medium size and good color; excellent for forcing under glass	10	20	60
Thorburn's Everbearing. Very early and enormously productive; the peculiar merit of this variety is that the vines continue to flower and produce fruit, whether the ripe Cucumbers are picked off or not, thus becoming almost a perpetual bearer	10	20	60
Thorburn's Commercial Pickle. Highly recommended for pickles	10	20	60

Thorburn's Everbearing. Very early and enormously productive; the peculiar merit of this variety is that the vines continue to flower and produce fruit, whether the ripe Cucumbers are picked off or not, thus becoming almost a perpetual bearer

Thorburn's Commercial Pickle. Highly recommended for pickles

English Frame Cucumbers.

These require to be grown in a frame or greenhouse, and, so provided for, produce wonderfully large and fine fruits. The varieties offered are the best known.

Duke of Edinburgh, Telegraph, Tender and True, and Sion House Improved.
Each, per pkt., 25 cts.



Gherkins.

Egg-Plant.

French, AUBERGINE. German, Eierpflanze. Spanish, Berengena.

CULTURE.—One ounce will produce 2,000 plants. A strong, uniform heat is required to germinate these seeds, and a thoroughly pulverized, well-enriched soil is necessary to perfect the fruiting. Transplant to 3 feet apart each way, and when about a foot high, support the plants by drawing earth up around them. Owing to their tenderness, repeated sowings are sometimes necessary. Care should be taken, in cutting the fruit, not to disturb the plant.

	Oz.	¼lb.
Black Pekin. Fruit round and solid, jet-black	\$0 30	\$0 80
New York Improved. The best; very large and of fine quality	40	1 00



Egg-Plant.

Thorough cultivation oftentimes saves a crop.

Endive.

French, *Endive*. German, *Endivie*. Spanish, *Endibia*.

CULTURE.—One ounce will sow 150 feet of drill. Sow in any ordinary dry soil, in drills one foot apart, covering lightly. When the plants are about 2 inches high, thin to about 12 inches in the row. When the plants have attained full size, gather up the leaves, tying together at the tips. This excludes the air from the inner leaves, which in the course of 4 or 5 weeks will become beautifully blanched.

Broad-leaved Batavian. A large summer variety; very productive, and one of the best. Oz. 20 cts., ¼lb. 50 cts., lb. \$1.50.

Green Curled. Best for use; very ornamental. Oz. 20., ¼lb. 50 cts., lb. \$1.50.

White Curled. Similar to above; pale green foliage. Oz. 20c., ¼lb. 50 cts., lb. \$1.50.



Endive.

Kale, or Borecole.

French, *CHOU VERT*. German, *Blatterfohl*.

CULTURE.—Kale, or Borecole, may be grown in almost any soil, but the richer it is the more abundant the product. Sow from the middle of April to the beginning of May, in prepared beds, covering the seed thinly and evenly. Transplant in June, and treat same as cabbage.

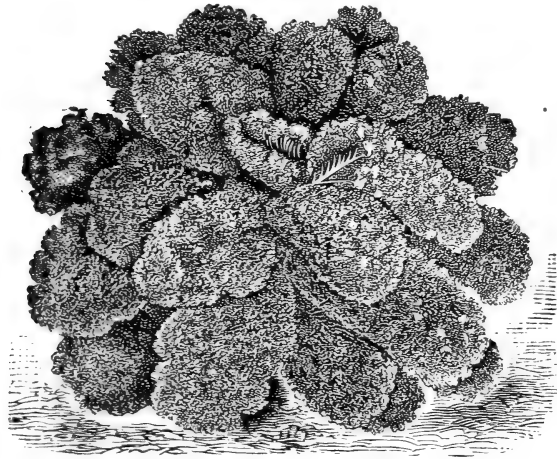

Dwarf Curled Green Scotch Kale.

Sow in rows 18 inches apart, afterwards thinning to 8 or 10 inches. When young, Kohlrabi is a delicate and palatable vegetable, and is very popular in Germany and other countries of Europe, where it is more generally used than in America.

Early Purple Vienna. A favorite and successful sort; largely grown \$0 30 \$0 80 \$3 00

Early White Vienna. The best variety; tender white flesh; very popular where known. 40 1 25 4 00

Green Curled Scotch. A dwarf variety, spreading under good cultivation to 3 feet in diameter; leaves of a bright green, beautifully curled. Oz. 15 cts., ¼lb. 30 cts.

Brown German Curled. A very hardy and useful variety. Oz. 15 cts., ¼lb. 30 cts.

Sea Kale. Oz. 30 cts., ¼lb., 80 cts.

Kohlrabi.

(Turnip-Rooted Cabbage.)

French, *CHOU RAVE*. German, *Kohlrabi*. Spanish, *Colinabo*.

CULTURE.—One ounce will produce 2,500 plants.

Oz. ¼lb. Lb.

Leek.

French, *POIREAU*. German, *Lauch*. Spanish, *Puerro*.

CULTURE.—One ounce will sow 100 feet of drill. Succeeds best in a light, rich soil. Sow in drills 1 inch deep and 1 foot apart; when or 8 inches high, transplant in rows 10 inches apart, and set deep, so as to blanch the neck as much as possible.

Oz. ¼lb. Lb.

American Large Flag. Of strong, vigorous growth; the best of all. \$0 25 \$0 75 \$2 50

Giant Carentan. A favorite European sort, of mild flavor 25 75 2 50

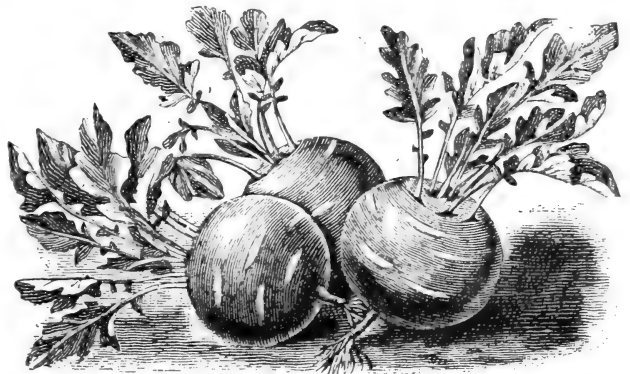

Early White Vienna Short-Top Kohlrabi.

Large Buyers ask for Special Terms.

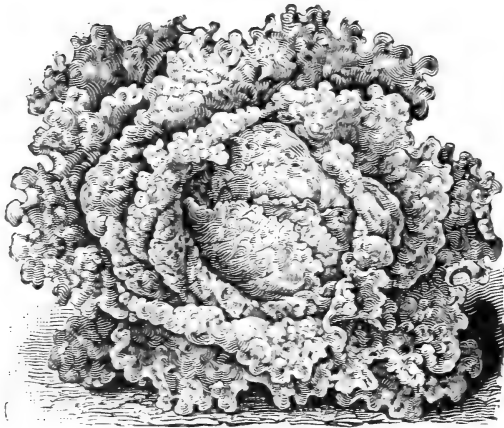

Grand Rapids Forcing.



Cos Lettuce.



Early Prize Head.

Lettuce.

French, *Laitue*. German, *Lattich*.

CULTURE.—Sow in frames in March, or in the open ground as early as the weather will permit, and transplant in rows one foot apart each way. Sow a month apart for succession. Sow seed thinly, and thin out well to make strong plants. Hoe carefully, and keep free from weeds. In October plant in frames, to head in winter and early spring. Many gardeners set out between early cabbage and corn.

	Oz.	¼lb.	Lb.
Clark's Hubbard Market. The most popular variety with our market-gardeners.			
We have the original Hubbard stock	\$0 40	\$1 25	\$4 00
Vick's Premium Cabbage. An excellent variety for forcing	20	60	2 00
Thorburn's Market-Gardener's Private Stock. Highly recommended for glass for early spring transplanting outside	20	60	2 00
New Hothouse Forcing. A large heading variety, especially adapted to greenhouse and hot-bed culture	20	50	1 50
Tennisball, Black Seed. Much used for forcing; forms a good head, with few outer leaves; early	15	40	1 25
Tennisball, White Seed. Known also under the name of Boston Market; early	15	40	1 25
Henderson's New York. Very large heads; fine for summer use	15	40	1 25
Henderson's Selected Salamander. Extensively used for summer planting. Heads large, resisting hot sun and drouth	20	60	2 00
Grand Rapids Forcing. Extra large, tender heads; one of the best early-forcing varieties	15	40	1 25
Big Boston. Highly recommended for forcing; similar to the old Boston Market, but much larger in size	15	40	1 25
Denver Market. Either for forcing or open ground. The leaves have the blistered appearance of the Savoy cabbage; an excellent sort, crisp, tender and of good flavor	15	40	1 25
Silver Ball. An early, firm, silvery white head, with handsomely curled leaves	15	40	1 25
Early Curled Simpson. One of the earliest and best for market	15	40	1 25
Black-Seeded Simpson. Nearly double in size of the ordinary Curled Simpson; stands the summer well	15	40	1 25
Salamander, or Satisfaction. An excellent summer variety, forming good-sized heads that stand the drouth and heat without injury longer than any other sort	15	40	1 25
Deacon. A large, solid cabbage Lettuce for summer	15	40	1 25
Early Prize Head. An early hardy variety of large size, very tender and crisp, of superior flavor; slow to run to seed, and stands the summer heat well	15	40	1 25
All the Year Round. A very hardy, compact variety, white, solid and crisp; for summer and winter use or for forcing this variety is unsurpassed	15	40	1 25
Hanson. A superior curled heading variety, of large size; sweet, tender and crisp	15	40	1 25
Royal White Cabbage. One of the largest and best summer Lettuces; blanches naturally; tender and crisp	15	40	1 25
White Paris Cos. Best Cos.	20	50	1 50
Hardy Green. A hardy, compact variety	20	50	1 50

Martynia.

A strong-growing annual plant, bearing curiously-shaped seed-pods, which, when young and tender, make excellent pickles. Sow in the open ground in May, and thin out the plants to 2 or 3 feet apart.

Martynia. Per pkt. 10 cts., oz. 30 cts., ¼lb. 75 cts.

Melon, Musk.

French, MELON. German, Melone.

CULTURE.—One ounce will plant 80 hills; 2 pounds will plant an acre. Plant in hills 6 feet apart each way, a dozen seeds in a hill. Thin out to 2 or 3 plants, when out of danger of bugs. Manure well with old rotten compost. A light, dry, sandy soil is the best. Use plenty of slug-shot, soot, or wood ashes to keep off the bugs. They are very apt to hybridize; the different kinds should be kept far apart.

Grand Rapids Market. Flesh pure yellow color; skin finely netted; very early and uniform in ripening. Oz. 10 cts., ¼ lb. 30 cts., lb. \$1.

Long Island Beauty. A splendid new variety of the Hackensack type, originated on Long Island. Superior quality, flesh green and densely netted. Very attractive appearance, and *earliest* of all. Oz. 15 cts., ¼ lb. 30 cts., lb. \$1.

Surprise. Yearly growing more popular, and is now considered the best melon in cultivation. The seed we offer is saved from the best specimens. Oz. 15 cts., ¼ lb. 30 cts., lb. \$1.

Osage. Known also as "Miller's Cream" and "Princess." Shape oval; skin light green color, slightly netted; flesh salmon, very sweet and of fine flavor. Oz. 15 cts., ¼ lb. 25 cts., lb. 75 cts.

Extra-Early Hackensack. The far-famed melon so extensively grown by New Jersey market gardeners for the New York markets. Fruit large, round and netted; flesh green and deliciously flavored; very productive. A good shipper, and consequently a favorite of market-gardeners everywhere . . . \$0 15

Delmonico. Deeply netted, oval; orange flesh; fine quality . . . 15

Emerald Gem. Entirely distinct, extra-early and very prolific. The skin, while ribbed, is perfectly smooth and of emerald-green color; flesh salmon and very thick; ripens thoroughly to the rind, and is juicy and rich; the vines are hardy and thrifty in growth; very prolific . . . 15

Fine White Japan. Early; medium size, round; skin white, flavor good . . . 15

Green-Fleshed Nutmeg. Skin deep green, finely netted; sweet and good flavor . . . 15

Cassaba. Large variety; shape oblong; flesh yellowish green, good flavor . . . 15

Cantaloupe. Flesh reddish orange, sweet and good . . . 15

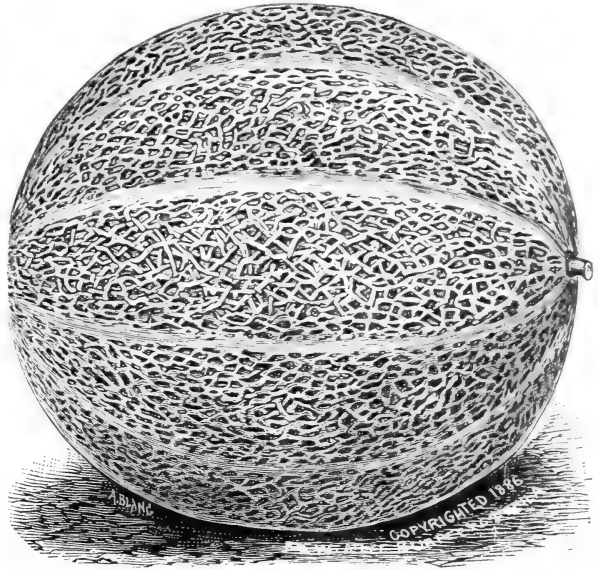

	Oz.	¼ lb.	Lb.
Grand Rapids Market.	\$0 15	\$0 25	\$0 75
Delmonico.	15	30	1 00
Emerald Gem.	15	25	75
Fine White Japan.	15	25	75
Green-Fleshed Nutmeg.	15	25	75
Cassaba.	15	25	75
Cantaloupe.	15	25	75

Melon, Water.

French, MELON D'EAU. German, Waffermelone.

CULTURE.—One ounce will plant 25 to 30 hills; 4 pounds will plant an acre. Treat as recommended for Muskmelon, except that the hills should not be less than 8 feet apart.

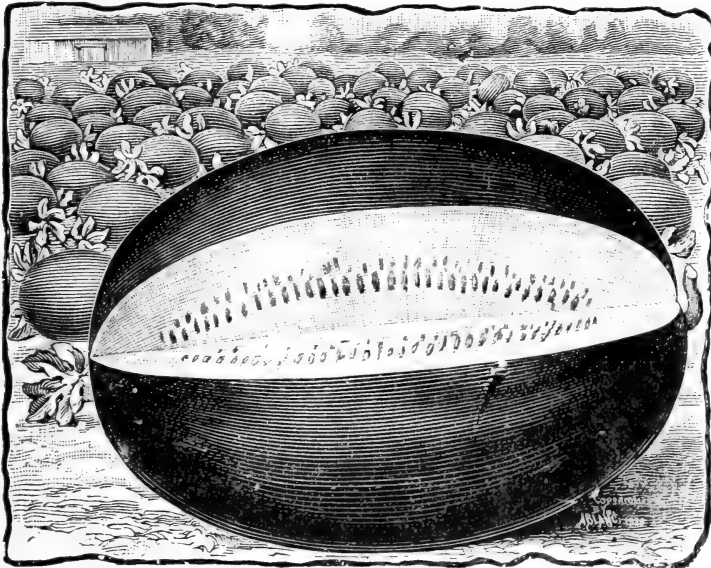

Green and Gold.

Kolb's Gem is by far the finest melon that ever came to this city. It is of delicious flavor; splendid keeper, firm, juicy, and sought for by everybody in preference to all other kinds; a great favorite with shippers. Oz. 10 cts., ¼ lb. 25 cts., lb. 75 cts.

Pride of Georgia. Round in shape; ridged like an orange; large, crisp; flesh bright red. Oz. 10 cts., ¼ lb. 25 cts., lb. 75 cts.

Vick's Early. Very early; oblong; bright pink flesh. Oz. 10 cts., ¼ lb. 25 cts., lb. 75 cts.

Green and Gold. Grows to good size; early; very productive, and of fine flavor. Oz. 10 cts., ¼ lb. 25 cts., lb. 75 cts.

Cuban Queen. A fine variety; bright red flesh. Oz. 10 cts., ¼ lb. 25 cts., lb. 75 cts.

Mushroom Spawn.

French, BLANC DE CHAMIGNON. German, Champignonbrut. Spanish, *Seta*.

CULTURE.—Ten pounds will spawn ten feet square. Mushrooms of excellent quality can be grown with ease almost the year round, the only requirement being unfermented manure, a small quantity of good soil, and reliable spawn. Full instructions on the preparation and management of the beds will be found in "Mushroom Culture," by W. Robinson, which will be sent free by mail for 50 cents. Our spawn can be thoroughly depended on, and, being specially manufactured for us, is fresh and reliable at all times.

English Spawn. In bricks weighing 1 lb. each, 15 cts.; 100 lbs., \$8.

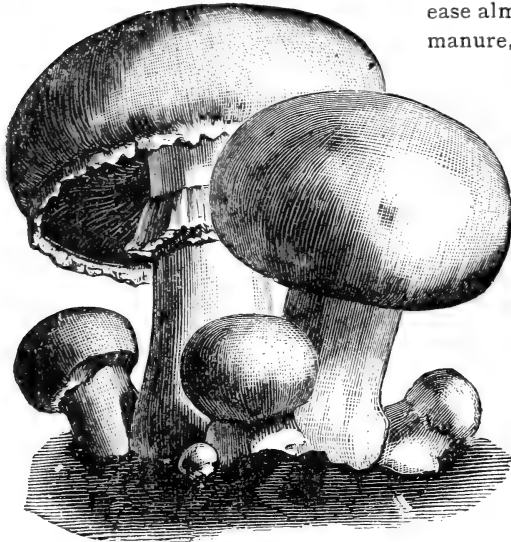

Mushrooms.

Mustard.

French, MOUTARDE. German, Senf. Spanish, *Mostaza*.

CULTURE.—One ounce will sow a drill 50 feet long. Sow thickly in rows 6 inches apart, and when about 2 inches high it can be cut and used with Cress, forming a pleasant pungent salad.

White or Yellow. Of very rapid growth and agreeable flavor. Oz. 5 cts., ¼ lb. 10 cts., lb. 25 cts.

Nasturtium.

French, CAPUCINE. German, Nasturtium. Spanish, *Maraneula*.

CULTURE.—One ounce will sow 50 feet of drill. Sow in drills one inch deep as soon as danger from frost is past, the tall varieties by the side of a fence, trellis work or other support, to climb upon. The seed pods, which resemble capers, and have a strong and pungent but pleasant taste, are held in high esteem by many persons, by whom they are gathered while green and tender and used for pickling, while the flowers and the young and tender leaves are used in salads.

	Oz.	¼lb.	Lb.
Dwarf Mixed. All colors	\$0 15	\$0 50	\$1 50
“ Scarlet	20	50	1 50
“ Yellow	20	50	1 50
Tall Mixed. All colors	15	40	1 25
“ Crimson	15	40	1 25
“ Yellow	15	40	1 25

Okra or Gumbo.

French, GOMBAUD. German, Safran. Spanish, *Quimbombo*.

CULTURE.—One ounce will plant 100 hills. Of easy cultivation in any good soil; plant about 2 inches deep, in drills 3 feet apart, and when well established thin to 3 plants in the hills; keep the soil well worked, and occasionally draw a little up around the stalks to support them. Gather the pods while young and tender.

White Velvet. Handsome and productive; long, smooth white pods. Oz. 10 cts., ¼ lb. 25 cts., lb. 75 cts.

We guarantee all shipments of Plants, Bulbs, Seeds, etc., to reach the purchaser in good condition.



White Velvet Okra.

Tomato, Cabbage and Celery Plants in season.

Onion.

French, OIGNON. German, Zwiebel. Spanish, Cebolla.

CULTURE.—One ounce will sow 100 feet of drill; 6 pounds will plant one acre. A deep, rich soil, thoroughly worked, is best for this crop. Sow thinly in shallow drills about 12 feet apart; when the plants are about 3 inches high, thin to the distance of 3 or 4 inches, according to the variety. Oz. ¼lb. Lb.

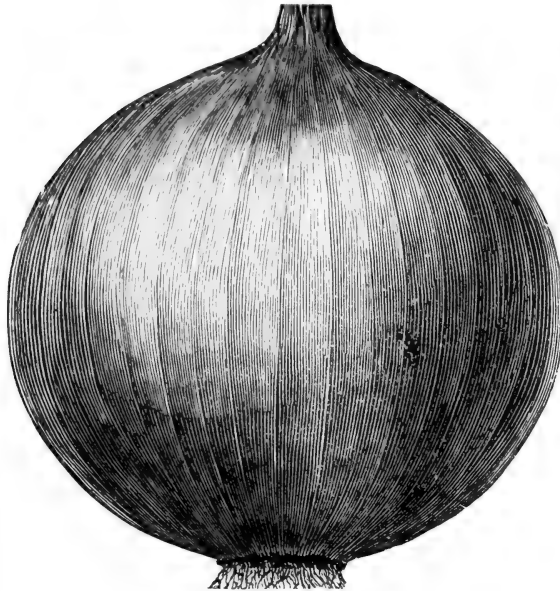

Yellow Globe Danvers.

Yellow Globe Danvers. The favorite market variety; uniform in size; an excellent keeper. The strain we offer is equal to any in existence \$0 15 \$0 30 \$1 00

Michigan Yellow Globe. Some of our customers prefer this to Globe Danvers. A heavy yielder, uniform in size and shape, and of attractive color 25 50 1 50

Round Yellow Danvers. A good market sort; an excellent keeper, but not as globular in shape 15 25 90

Large Red Wethersfield. Grows to large size; deep red in color, and an excellent keeper 25 50 1 50

Early White Barletta. Very early, small white; extensively used for pickling 20 60 2 00

White Queen. A fine-flavored, small, white pickling sort. 15 50 1 50

Prize Taker. Grows to large size, mild flavor, and of exceedingly handsome appearance, but not a good keeper 25 75 2 50

White Globe. Silvery white skin; of mild flavor, and a good keeper 25 75 2 50
White Pearl. An early small white sort, good either for early pulling or for pickling 25 75 2 50

Onion Sets, Etc.

CULTURE.—Plant in drills 12 inches apart and 4 inches between the sets. Prices are subject to market fluctuations as the season advances.

White Onion Sets	} Market price.
Yellow " "	
Top Onions	
Potato-Onions	



Parsley.

French, PERSIL. German, Petersilie. Spanish, Perejil.

CULTURE.—One ounce will sow 100 feet of drill. Sow thinly in drills 1 foot apart, and thin out the plants to 3 or 4 inches between each. The seed germinates slowly, sometimes three or four weeks passing before the plants show.

Champion Moss-Curled. Very select strain; compact and beautifully curled. Per oz. 10 cts., per ¼lb. 25 cts., per lb. 80 cts.

Fern-Leaved. A distinct and attractive dwarf variety; highly ornamental. Per oz. 15 cts., per ¼lb. 25 cts., per lb. 80 cts.

Plain Parsley. Hardier than the curled variety; good for flavoring. Per oz. 10 cts., per ¼lb. 15 cts., per lb. 50 cts.

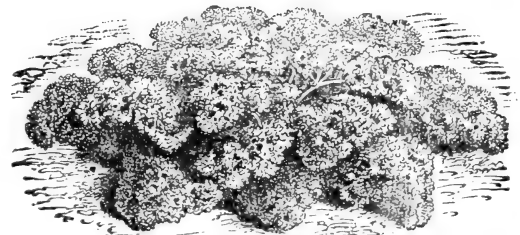

Champion Moss-Curled.

Parsnip.

French, PANAIS. German, Pastinake. Spanish, Chirivía.

CULTURE.—One ounce will sow 200 feet of drill; 5 pounds will plant an acre. This crop requires a very rich soil. Sow in drills 18 inches apart, and thin to 8 inches in the row. Besides being desirable as a table vegetable, they are valuable for feeding stock.

Oz. ¼lb. Lb.

Long Smooth, or Hollow Crown. Of excellent flavor; tender and sweet \$0 10 \$0 15 \$0 50

Student. Handsome shape and splendid flavor 10 15 50

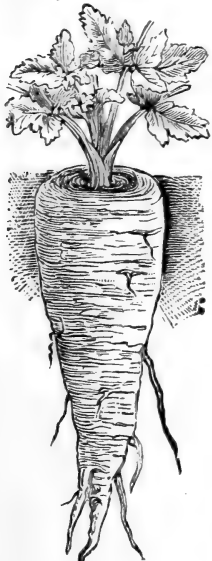

Hollow Crown

Peas.

French, Pois. German, Erbsen. Spanish, *Chicaros o Guisantes*.

CULTURE.—One quart for 75 feet of drill, 2 to 3 bushels for an acre. Peas mature earliest in a light,



American Wonder.

rich soil; for a general crop, a deep, rich loam, or inclining to clay, is the best. When grown in the garden, sow in double rows, 6 to 8 inches apart. When grown for a market crop, sow in single rows, 1 inch apart and 2 to 3 inches deep, the rows from 2 to 4 feet apart, according to the variety. Begin sowing the extra-early varieties as soon as the ground can be worked in March; continue for a succession every 2 weeks until June, then discontinue until the middle of

August, when a good crop may be secured by sowing the extra-early sorts for fall use. They should be kept clean, and earthed up twice during growth. The wrinkled varieties are not as hardy as the smooth sorts, and if planted early should have a dry soil, as they are liable to rot in the ground; they are, however, the sweetest and best flavored varieties. The dwarf varieties are best suited, from their habit, for small gardens or for forcing, and can be planted in rows 1 foot apart.

Extra-Early Peas.

American Wonder. Height 1 foot. Extra-early dwarf, wrinkled. Very fine quality, and best for general use. Qt. 25 cts., pk. \$1.75, bus. \$6.

Clark's Improved Extra-Early. Height, 2½ feet. Ripens evenly; pods well filled. Most profitable early market variety. Qt. 25 cts., pk. \$1, bus. \$3.50.

Early Alaska, or First of All. Height, 2½ feet. One of the very earliest blue Peas; productive. A good market variety. Qt. 25 cts., pk. \$1.25, bus. \$4.25.

Rural New-Yorker. Height, 2½ feet. Very early, prolific and uniform in ripening. Favorite with market-gardeners. Qt. 25 cts., pk. \$1, bus. \$3.25.

First and Best. Height, 2½ feet. An improved strain of Extra-Early Philadelphia. Qt. 25 cts., pk. \$1, bus. \$3.25.

Extra-Early Philadelphia. Height, 2½ feet. Known also as Early Kent. A well-known standard market variety. Qt. 25 cts., pk. 90 cts., bus. \$3.

Daniel O'Rourke. Height, 2½ feet. A valuable extra-early; fine quality; very productive. Qt. 25 cts., pk. 90 cts., bus. \$3.25.

Premium Gem. Height, 1 foot. One of the best extra-early dwarfs; wrinkled; especially desirable for family use. Qt. 25 cts., pk. \$1.75, bus. \$6.

McLean's Little Gem. Height, 1 foot. Similar to the above; very sweet, tender and delicious. Qt. 25 cts., pk. \$1.75, bus. \$6.

Tom Thumb. Height, 1 foot. Very dwarf; not wrinkled; yields abundantly; fine quality. Qt. 25 cts., pk. \$1.25, bus. \$4.50.

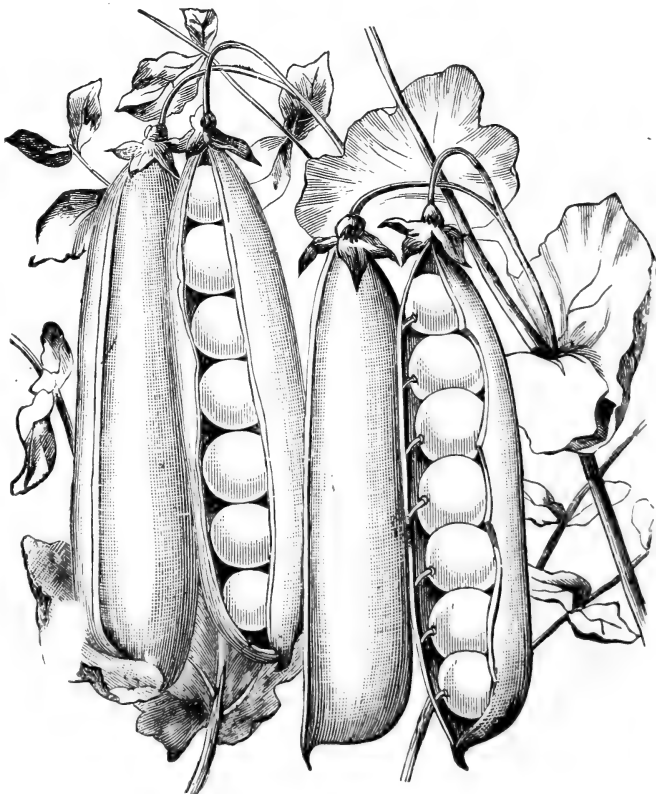

Clark's Improved Extra-Early.

Remember that postage on Peas is 15 cents a quart.

Medium, or Second-Early Peas.

	Qt.	Pk.	Bus.
Horsford's Market Garden. The finest medium early in cultivation. A strong grower, very productive; popular with market-gardeners	\$0 25	\$1 25	\$4 50
McLean's Advancer. An excellent wrinkled variety, of delicious table quality	25	1 00	3 50
Bliss' Everbearing. Matures about the same time as Advancer, but continues longer in bearing	30	1 25	4 50
Yorkshire Hero. Not as early as the above; more branching habit. Very sweet, excellent quality for family use	30	1 25	4 50
Nott's Excelsior. An excellent new sort. Very small vine, but exceedingly vigorous. Pods well filled; of superior quality.	40	2 25	
Admiral. Height, 3 to 4 feet. Ripens about same time as Telephone. Very productive, and of fine table quality.	30	1 50	5 00

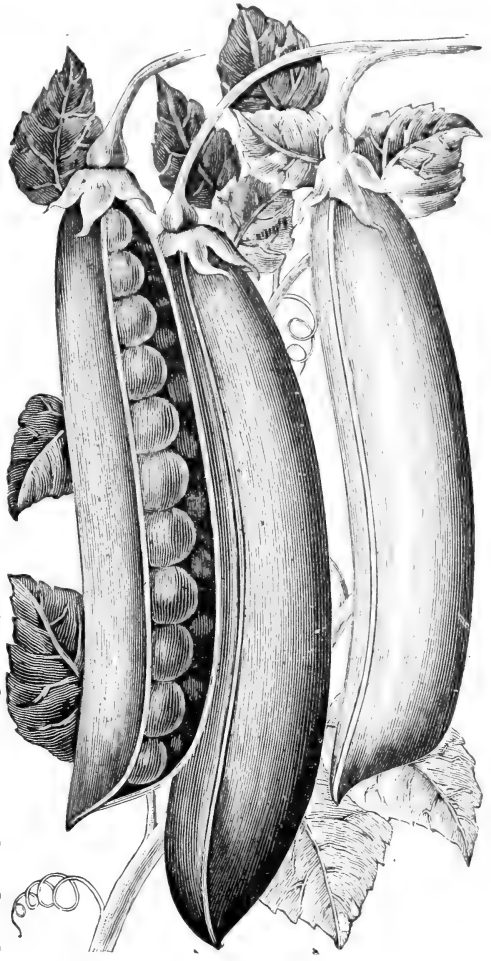

Telephone.

Late, or Main Crop Peas.

	Qt.	Pk.	Bus.
Champion of England. One of the best and most popular Peas in cultivation	\$0 25	\$1 25	\$4 00
Stratagem. A dwarf wrinkled variety; a heavy yielder, producing large, well-filled pods of fine flavor	30	1 50	5 00
Telephone. Very large pods; very productive and of superior flavor. An excellent late market variety	25	1 25	4 00
Shropshire Hero. A valuable new English variety, well worthy of cultivation. Pods very large	30	1 50	5 00
White Marrowfat. Pure white. A heavy yielder; large pods, and a general favorite.	15	50	1 50
Black-Eyed Marrowfat. Very hardy and productive. Excellent for general use	15	50	1 50
White Field. For sowing		1 25	

Pepper.

French, PIMENT. German, Pfeffer. Spanish, Pimiento.

CULTURE.—One ounce will produce 1,500 plants. Good, rich, mellow ground is best for Peppers. Sow early in April in a hotbed in shallow drills, 6 inches apart, and transplant to the open ground as soon as the weather is warm and settled. Transplant into rows 2 feet between the plants each way. Keep the soil open and free with the cultivator. The seed may also be sown in the open ground, but not until all danger from frost is past.



Ruby King.

	Oz.	¼lb.	Lb.
Large Bell, or Bull-Nose. Early and of pleasing flavor	\$0 25	\$0 75	\$2 25
Large Squash. Very productive; fleshy and mild	25	75	2 25
Long Red Cayenne. Bright red pods; very pungent; prolific	25	75	2 25
Red Chili. Bright red, cone-shaped pods; very pungent	25	75	2 25
Ruby King. Enormously productive and of immense size; of mild flavor	25	75	2 25
Sweet Mountain. Large, early variety; of mild flavor	25	75	2 25

For a beautiful Lawn, use Queen City Lawn Seed.

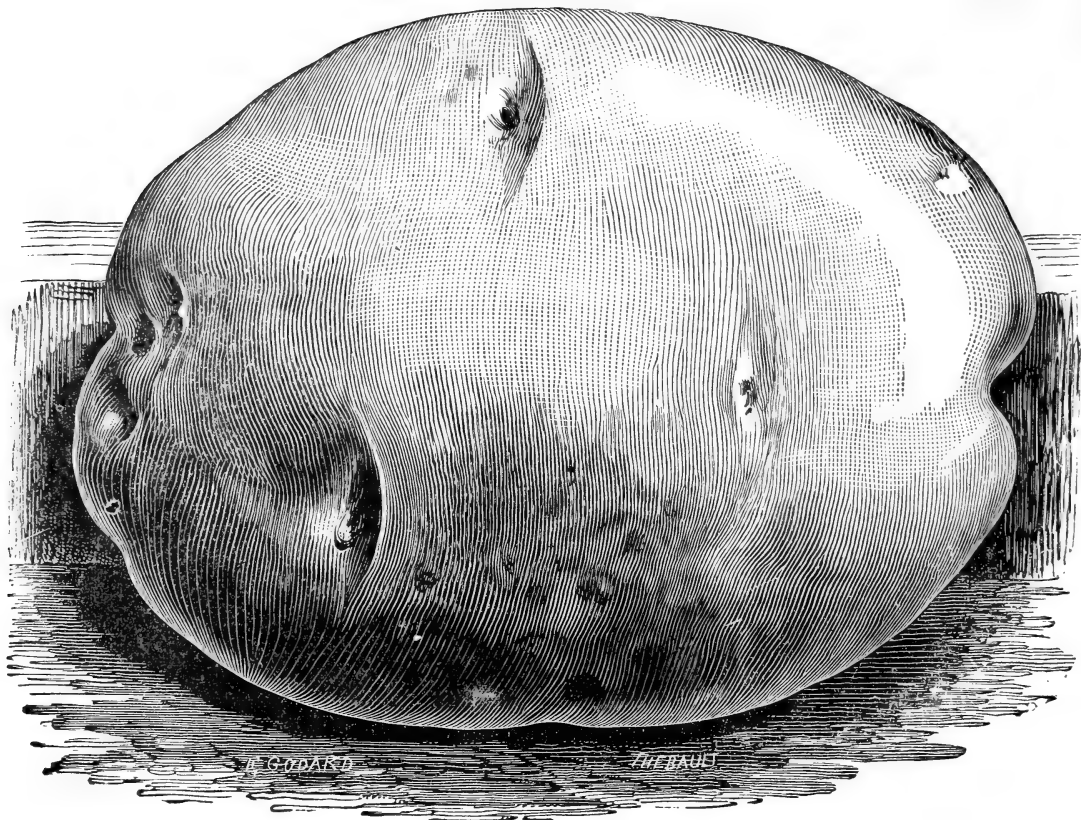

Carman No. 1 Potato.

Potato.

French, POMME DE TERRE. German, Kartoffel. Spanish, *Patata*.

CULTURE.—To plant an acre, 8 bushels are required. If a very early crop is desired, start in small boxes of good soil; even stout paper bags have been successfully used. Place these in a hotbed or warm room from 4 to 5 weeks before required for outside. During this time shoots will start strong and vigorous, so that as soon as planted they will send out good roots and grow rapidly. In order to have best success in growing Potatoés, and to secure healthy, vigorous growth, and a crop free from rot, plant as early as the ground can be made ready. Select a good, rich soil, and plant in rows 3 feet apart and 1 foot apart in the rows. Keep the plants well hoed. If the potato beetle makes its appearance, the vines should be dusted with Paris green mixed with about 80 parts of plaster or flour; or better still, mix the Paris green in water, one small tablespoonful to a pail, and apply with a watering pot. Be careful to stir the mixture often, or the Paris green will settle to the bottom. Two or three applications will be found sufficient.

	Pk.	Bus.	Bbl.
New Queen. A new seedling of the Beauty of Hebron, which it resembles in shape and color; very early; a heavy yielder	\$0 40	\$1 50	\$3 00
Freeman. An excellent yielder; fine table quality; early	40	1 50	3 00
Carman No. 1. Resembles the Rural New-Yorker No. 2 in some respects, but surface not quite so smooth; medium early	1 25	2 00	4 50
American Wonder. Large, white, solid, uniform, smooth and handsome; a heavy yielder	40	1 50	3 00
Money Maker. A long, handsome, well-shaped white variety, best for general crop; fine grained and highest table quality; a rank, strong grower, and exceptionally hardy. We advise our friends to give it a trial, for we know that it will please	50	1 50	3 00
Fillbasket. This new variety takes front rank in productiveness, vigor of growth and table qualities; admirably adapted for main crop	40	1 50	3 00
Clay Rose. Oblong-shaped, pink skin, blight-proof; vines are strong and vigorous; especially adapted to heavy soils	30	1 00	2 75
Snowflake. We can supply a limited quantity of this old favorite, the finest of all in table quality, but not a yielder	50	1 50	3 00
Rural New-Yorker. Known also as Carman No. 2; intermediate in ripening; pure white skin; immense yielder	40	1 50	3 00

A Trial Order will Convince.

Pumpkin.

French, POTIRON. German, Kürbis. Spanish, Calabaza.

CULTURE.—One pound will plant 40 hills; 5 pounds will plant an acre. Plant in hills 8 or 10 feet apart each way, allowing 4 seeds to a hill. In other respects they are cultivated as melons and cucumbers.

Connecticut Field, or Large Yellow.

The best for field culture and for feeding stock \$0 10 \$0 25

Large Cheese. Flesh fine-grained, sweet and well flavored; a favorite for making pies 10 40



Large Cheese Pumpkin.

Radish.

French, RADIS. German, Rettig. Spanish, Rabanitos.

CULTURE.—One ounce will sow 100 feet of drill; 2 pounds will be required for 1 acre. Radishes do best in a light, rich soil. Sow in drills about 10 inches apart, covering about half an inch, and thin the plants to 2 inches apart. A rapid growth is essential to produce showy, crisp Radishes of a mild flavor. Sow every 10 days for a succession of crops.

	Oz.	¼lb.	Lb.
Non Plus Ultra. Very early; round, deep scarlet; very small top; the best variety for growing under glass	\$0 10	\$0 25	\$0 60
Early Scarlet Globe. We have a superior strain of this, the finest variety for early market or general use	10	20	60
Early Scarlet Turnip. Deep scarlet; very early, tender and crisp	10	20	50
Early Scarlet Gem, or Scarlet Turnip White-Tipped. The handsomest Radish grown. Fine for forcing or outside	10	20	60
Early White Turnip. Very early, tender and crisp. Pure white	10	20	50
Philadelphia White Box. A pure white turnip-shaped. Very early; does not become pithy. Fine for the "box" or frame	10	25	60
Olive-Shaped Scarlet. Oblong-shaped, small top; does well under glass	10	20	60
French Breakfast. A general favorite for forcing or outside use. Oval form, bright scarlet color, tipped with white	10	20	60
Long Scarlet Short-Top. The well-known standard sort; very long; bright color	10	15	40
Long Brightest Scarlet. An improved strain of the above. Very uniform in shape; color bright scarlet	10	20	60
Chartier Long Scarlet. A long scarlet, white-tipped sort; fine quality; excellent for market	10	20	60
White Delicacy. A new half-long, pure white variety. Tender, crisp and of fine flavor; valuable market sort	10	30	75

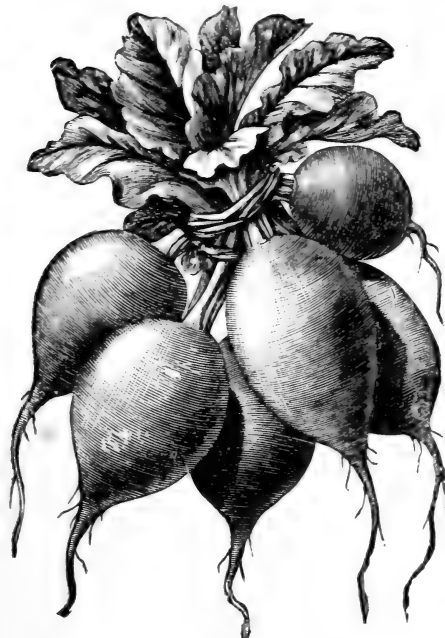

Early Scarlet Globe.

White Strasburg. Though not a new variety, it is one that should be more largely grown. The roots are oblong, of a pure white color, very brittle and of mild flavor. For summer and fall use this variety will be found very desirable	10	20	60
Early White Giant Stuttgart. An early and remarkably quick-growing variety of large size; flesh and skin pure white, crisp and of excellent flavor; turnip-shaped. It is one of the best summer varieties, as it withstands the severest heat	10	20	60
Yellow Summer Turnip, or Golden Globe. A turnip shaped, grey or russet-colored variety, growing to a large size, and standing the heat and drouth of summer	10	20	60
Large White Summer Turnip. Shaped similar to the preceding, but of larger size; pure white	10	20	60
Black Spanish Winter, Long. Very hardy, and fine for winter use	10	20	60
Chinese Rose Winter. Color bright rose; excellent flavor; good at all seasons	10	25	75
California Mammoth White. A large, white-fleshed fall Radish	10	20	60

Rhubarb.

French, RHUBARBE. German, Rhabarber. Spanish, *Ruibarbo*.

CULTURE.—One ounce will sow 125 feet of drill. The seed bed should be of light, rich soil. Sow very thinly in rows 1 foot apart, and cover the seed about 1 inch. When the plants are 2 inches high, thin to the distance of 6 inches in the drill. In about six months they will be strong enough to set out in their permanent location, the distance allowed being about 3 feet each way.

	Oz.	¼lb.	Lb.
Victoria	\$0 20	\$0 50	\$1 50

Roots of either variety, \$1.50 per dozen, by express, at purchaser's expense.

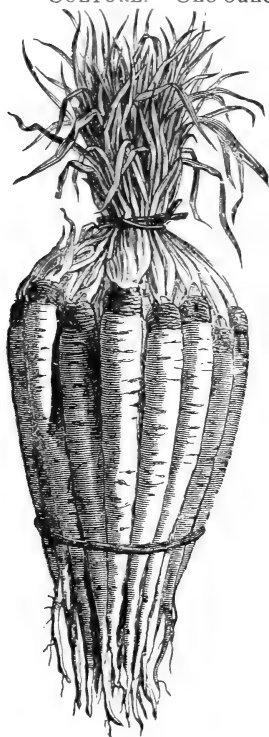

Salsify.

Salsify, or Vegetable Oyster.

French, SALSIFIS. German, Haferwurzel. Spanish, *Ostra Vegetal*.

CULTURE.—One ounce will sow a drill 60 feet; 5 pounds will sow 1 acre. The soil should be rich and well worked to a depth of at least 18 inches. Sow in drills 15 inches apart, covering the seeds with fine soil 1½ inches in depth. When the plants are strong enough, thin out to about 9 inches apart.

	Oz.	¼lb.	Lb.
Large White French. Small-growing, but of good flavor	\$0 10	\$0 30	\$1 00
Mammoth Sandwich Island. A great improvement on the old variety; very large	10	40	1 25

Spinach.

French, EPINARD. German, Spinat. Spanish, *Espinaca*.

CULTURE.—One ounce will sow 100 feet of drill; 10 pounds will sow 1 acre. An exceedingly rich, well-worked soil is necessary. Sow thinly in drills 10 inches apart, half an inch deep. When the young plants are established, thin out to the distance of 3 or 4 inches in the row, and in a future thinning every alternate plant may be removed, as Spinach does not do well when crowded.

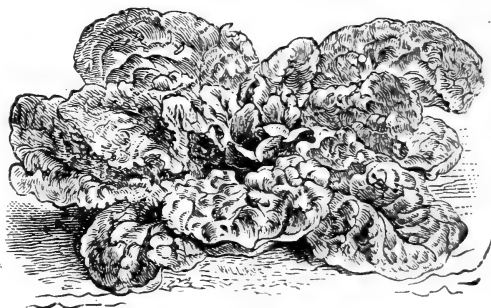

Long Standing Spinach.

Round-Leaved. Leaves large, thick and fleshy; generally used for spring sowing, though equally good for fall. Oz. 10 cts., ¼lb. 15 cts., lb. 30 cts.

Large Thick-Leaved, or Viroflay. Leaves larger and thicker than the preceding; the favorite with market-gardeners. Oz. 10 cts., ¼lb. 15 cts., lb. 30 cts.

Long Standing. This sort has all the advantages in addition to that of not running to seed early; an excellent sort. Oz. 10 cts., ¼lb. 15 cts., lb. 30 cts.

Prickly. The hardiest variety; used for fall sowing. Oz. 10 cts., ¼lb. 15 cts., lb. 40 cts.

Squash.

French, COURGE. German, Kürben Kürbiß. Spanish, *Calabaza*.

CULTURE.—One ounce will plant 50 hills; 4 to 6 pounds, according to variety, is required for 1 acre. Plant in well-manured hills, the bush varieties 3 or 4 feet apart, and the running sorts from 6 to 8 feet. Eight or 10 seeds to a hill, thinning out after danger of bugs is over, and leaving 3 or 4 of the strongest to a hill.

Mammoth Summer Crookneck. Grows to a large size, early and fine quality; a great improvement on the old variety Oz. ¼lb. Lb. \$0 10 \$0 25 \$0 75

Early White Scallop. Very early and productive; attractive appearance 10 20 75

Hubbard. Most popular winter sort; excellent keeper; finest quality 10 20 60

Boston Marrow. Bright orange skin; good keeper; very productive 10 20 60

Early Orange Marrow. A little earlier than the preceding; equally as good; fine for fall. Oz. 10 cts., ¼lb. 25 cts., lb. 75 cts.

Dunlap's Prolific Marrow. A superior strain of Boston Marrow; a little earlier. Oz. 10 cts., ¼lb. 25 cts., lb. 75 cts.

Sibley. Known also as "Pike's Peak;" flesh fine-grained; rich flavor. Oz. 10 cts., ¼lb. 25 cts., lb. 75 cts.

Vegetable Marrow. A delicious English variety, with white, soft flesh of a rich flavor; distinct from other sorts; worth attention. Oz. 15 cts., ¼lb. 30 cts., lb. \$1.

Mammoth Chili. Of immense size; rich, thick flesh of good quality. Pkt. 10 cts., oz. 20 cts., ¼lb. 50 cts., lb. \$1.50.

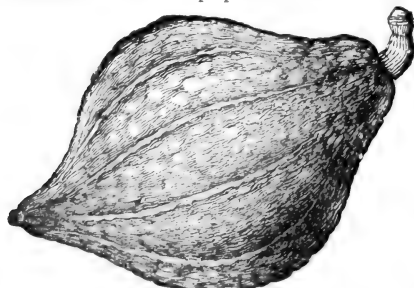

Hubbard.

Tomato.

French, TOMATO. German, Liebesapfel. Spanish, Tomates.

CULTURE.—One ounce will produce 3,000 plants; 2 ounces will produce enough for 1 acre. They do

best on a light, warm, not over-rich soil, and success depends to a very great extent on securing a rapid, vigorous, unchecked growth the early part of the season. Transplant, as soon as the plants are fit to handle, into shallow boxes, setting them 4 or 5 inches apart. When strong and stocky, set out in hills 4 feet apart. By training the vines on trellises or other supports, they will be more productive, and the fruit will be of much better quality.



Hubbard's Conqueror. Oz. ¼lb. Lb.
Very early; perfectly smooth, solid, and an excellent keeper; a general market favorite. . . \$0 25 \$0 75 \$2 50

Early Ruby. One of the earliest; large-sized; combining good form, deep crimson color and solidity. . . 25 75 2 50

Fordhook First. A new variety of last season; color purplish red; very uniform in size and shape, solid and early. Pkt. 10 cts. . . 25 75 2 50

Acme. One of the most popular sorts; color deep crimson . . . 25 75 2 50

Beauty. (Livingston's.) Very handsome, medium-sized and smooth; a good keeper. . . 25 75 2 50

Favorite. (Livingston's.) Large and perfect shape; ripens early and evenly, holding its size to end of the season . . . 25 75 2 50

Dwarf Champion. Early and wonderfully prolific; dwarf habit, needing but little support. . . 25 75 2 50

Early Michigan, or Early Red Apple. An extra early, round, smooth, solid sort; color deep red. . . 25 75 2 50

Royal Red. An excellent main crop variety; skin and flesh intense red color . . . 25 75 2 50

New Jersey. (Thorburn's.) A fine new sort; large, solid, smooth and bright red. . . 25 75 2 50

Long keeper. (Thorburn's.) Bright scarlet color; productive and longest keeper of all. . . 25 75 2 50

Conqueror. An old favorite with our most successful growers . . . 25 75 2 50

Matchless. Bright red, medium-sized, productive and a good shipper . . . \$0 25 \$0 75 \$2 50

Perfection. (Livingston's.) Early, regular and uniform in shape . . . 25 75 2 50

Optimus. Very prolific; one of the earliest; large, red smooth variety . . . 25 75 2 50

Atlantic Prize. One of the earliest; smooth, bright red and very solid . . . 25 75 2 50

Livingston's Stone. One of the very best of recent introductions; large, perfectly smooth, and of attractive color . . . 25 75 2 50

Canada Victor. Very early, solid, bright red; a good market sort . . . 25 75 2 50

Golden Queen. Medium-size; of a beautiful yellow color. . . 30 80 3 00



Dwarf Champion.

Turnip.

French, NAVET. German, Rübe. Spanish, Nabo.

CULTURE.—One ounce will sow 150 feet of drill; 2 pounds will sow 1 acre. This crop does best in highly enriched, light, sandy soil. Sow in drills from 12 to 15 inches, and thin early to 8 or 9 inches apart. A good crop when cultivated with judgment.

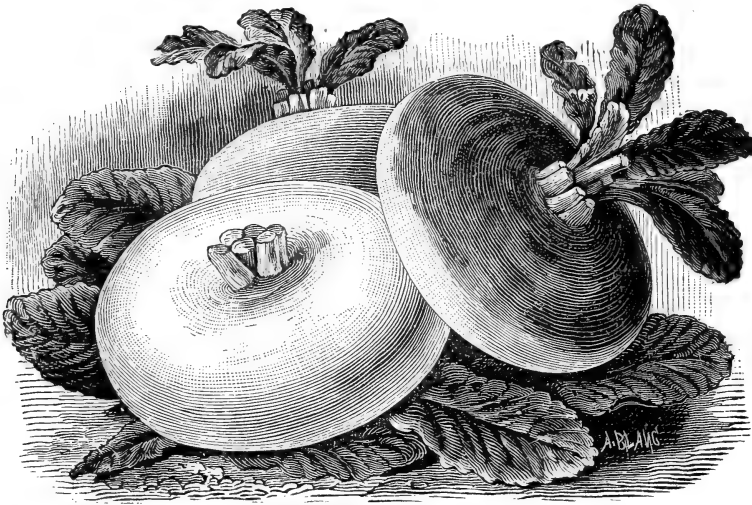

Red or Purple-Top Strap-Leaf.

Red or Purple-Top Strap-Leaf.

Rapid grower and mild flavor; the most popular variety for early use, either for the table or stock. Oz. 10 cts., ¼ lb. 15 cts., lb. 50 cts.

White Egg. Belongs to the class of quick-growing fall Turnips; in shape is nearly oval or egg, as its name would indicate; flesh very firm and fine grained; thin and perfectly smooth skin, and both flesh and skin are of snowy whiteness. Oz. 10 cts., ¼ lb. 15 cts., lb. 50 cts.

Red or Purple-Top White Globe.

A globe-shaped variety; a decided improvement upon the

preceding for market-garden purposes. Oz. 10 cts., ¼ lb. 15 cts., lb. 50 cts.

Early Flat Dutch. An excellent garden variety, resembling White Strap Leaf; the best variety for spring sowing . . .	Oz.	¼ lb.	Lb.
	\$0 10	\$0 15	\$0 50
Early White Strap-Leaf. Differs from Red-Top Strap-Leaf only in color	10	20	60
Early White Globe. Pure white, solid, sweet and mild flavor	10	15	50
Yellow Globe. Flesh a rich, pale yellow color; excellent keeper	10	15	50

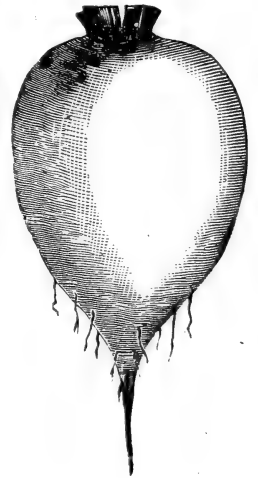

White Egg.

Ruta-Baga, or Swedish Turnip.

Monarch. Very large, with small top and neck; flesh a rich yellow, solid and fine grained; will outyield any other variety. Oz. 10 cts., ¼ lb. 20 cts., lb. 60c.

Laing's Improved. One of the earliest of the Ruta-Bagas; forms a handsome bulb of a good quality; keeps well; good for table use

	Oz.	¼ lb.	Lb.
	\$0 10	\$0 20	\$0 60

Champion Purple-Top. An English variety; resembles the preceding; very productive and of high quality.

	10	20	60
--	----	----	----

Skirving's Purple-Top. A very heavy cropper; one of the best for field culture

	10	15	50
--	----	----	----

White Sweet Russian. This variety is now very extensively cultivated, and is given preference in many sections for its white flesh; it is very hardy and productive, keeps well until late in the spring, and is highly esteemed by farmers and cattle raisers for its sweet, delicate flavor

	10	20	60
--	----	----	----

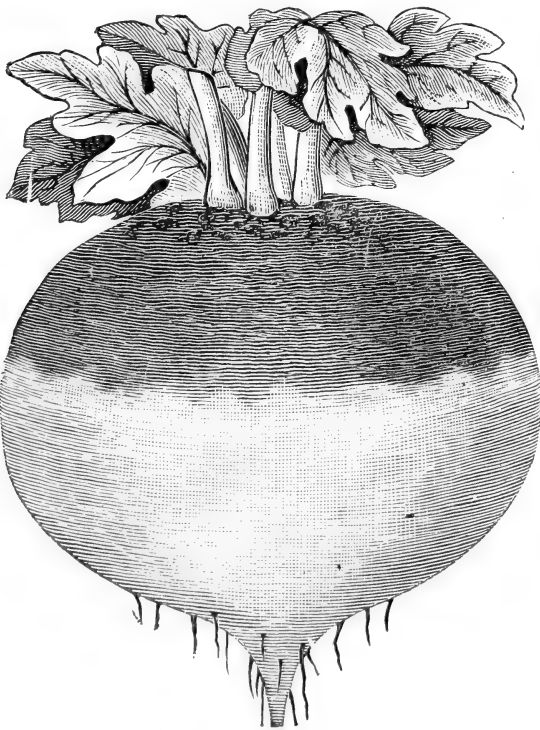

Laing's Improved Ruta-Baga.

If you receive two Catalogues, give your Neighbor one.



Sweet Basil.

Sage.

Sweet Marjoram.

Summer Savory.

Thyme.

MISCELLANEOUS SEEDS AND ROOTS.

If any of the undermentioned Seeds are desired by mail, postage must be added at the rate of 8 cts. per pound. Packets, ounces and quarter pounds are mailed free.

Sweet, Pot and Medicinal Herbs.

No garden is complete without a few herbs for culinary or medicinal purposes, and care should be taken to harvest them properly. This should be done on a dry day, just before they come into full bloom, then dried quickly and packed closely, entirely excluded from the air. Sow in spring in shallow drills, 1 foot apart, and when well up thin out or transplant to a proper distance apart.

Basil, Sweet. The leaves and tops of the shoots are used for highly seasoned dishes, soups, stews and sauces. Pkt. 5 cts., oz. 20 cts.

Borage. Much used in claret and other drinks; an excellent bee plant. Pkt. 5 cts., oz. 20 cts.

Catnip. Pkt. 10 cts., oz. 50 cts.

Dill. The leaves are used in soups and sauces, and for flavoring pickles. Pkt. 5 cts., oz. 10 cts., ¼ lb. 25 cts., lb. 75 cts.

Fennel. The leaves, boiled, enter into many fish sauces, and raw form a beautiful ornament. Pkt. 5 cts., oz. 10 cts., ¼ lb. 25 cts.

Hop Seed. Pkt. 25 cts., oz. \$1.50.

Horehound. Principally used for medicinal purposes. Pkt. 5 cts., oz. 30 cts.

Lavender. A popular aromatic herb. Pkt. 5 cts., oz. 20 cts., ¼ lb. 60 cts.

Marjoram, Sweet. For seasoning. Pkt. 5 cts., oz. 20 cts., ¼ lb. 60 cts.

Sage. The leaves and tender tops are used in stuffing and sauces. Pkt. 5 cts., oz. 25 cts., ¼ lb. 60 cts., lb. \$2.

Savory, Summer. Used for seasoning. Pkt. 5 cts., oz. 20 cts., ¼ lb. 50 cts.

Thyme, Broad-leaved. For seasoning, etc. Pkt. 5 cts., oz. 40 cts., ¼ lb. \$1.25.

Wormwood. Used for medicinal purposes; it is also beneficial to poultry, and should be planted in poultry grounds. Pkt. 5 cts., oz. 35 cts.

Bird Seeds.

Clark's Mixed Bird Seed has become famous for its superior quality; we use nothing but freshest high-grade seed, free from mildew and dust; our blend of seeds is particularly relished by canaries. Lb. 10 cts., 100 lbs. \$6.

Clark's Mixed Parrot Food. A superior seed-mixture for parrots. Lb. 10 cts., 100 lbs. \$7.

Shepherd's Bird Tonic. Per bottle 25 cts.

Dr. Gunning's Song Restorer. Per bottle 25 cts.

Bird Manna. Box 15 cts.

Excelsior Prepared Mocking Bird Food. Bottle 30 cts.

Canary. Best Sicily. Lb. 10 cts., 100 lbs. \$5.50.

Hemp. Lb. 10 cts., 100 lbs. \$6.

Lettuce. Oz. 5 cts., lb. 40 cts.

Maw. Lb. 20 cts., 100 lbs. \$16.

Millet. Lb. 10 cts., 100 lbs. \$2.50.

Rape. Lb. 10 cts., 100 lbs. \$6.50.

Rough Rice. Lb. 10 cts., 100 lbs. \$7.50.

Peas for Pigeons. Bus. \$1.

Cuttle Fish Bone. Each 5 cts., lb. 50 cts.

Washed Silver Gravel. Pt. 5 cts., qt. 10 cts.

Wild Rice. (*Zizania aquatica*) Much sought after owing to its having attractions for water fowl. Lb. 25 cts., 100 lbs. \$20.

Vegetable Roots and Plants.

Artichokes, Jerusalem. Qt. 25 cts., pk. \$1.25, bus. \$4, 3 lbs. by mail 75 cts.

Asparagus Roots. (See page 3.)

Chives. Bunch or clump 25 cts.

Horse-Radish Roots. Doz. 25 cts., 100 75 cts., 1,000 \$6.

Mint. Each 20 cts., doz. \$2, 100 \$8.

Rhubarb Roots. (See page 22.)

Tarragon Plants. Each 35 cts., doz. \$3.50.

Queen City Lawn Seed is the best offered.

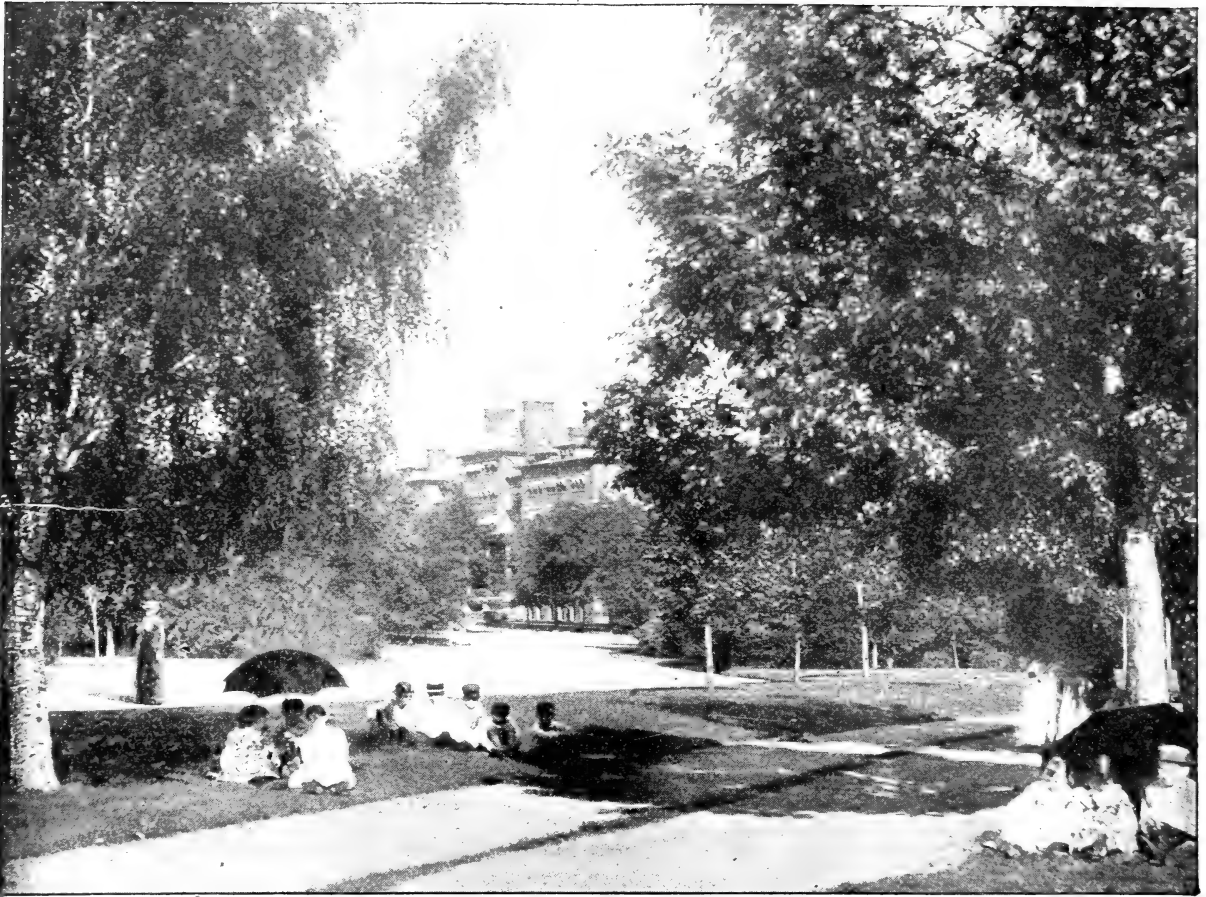

LAWN GRASS SEEDS.

Special Mixture of Selected Grasses Adapted for Lawns, Parks, Tennis and Croquet Grounds.

How to Make a Beautiful Lawn.

A Beautiful Lawn, with its close, velvety turf, is a most essential feature in the adornment of a home. Without it the finest flowering plants and beds seem out of place, while with it handsome grounds are assured, even with no other adornment.

Some gardeners still continue the expensive plan of sodding because of its quicker effects, but it is generally admitted that a turf formed by seeding is far more compact and durable. In preparing the soil for a perfect Lawn, it must not be forgotten that as much care should be exercised as for vegetables, flowers or any other garden crop. The ground should be thoroughly plowed or dug to a depth of at least a foot, and enriched, if necessary, with a liberal application of Lawn Fertilizer. The best time for sowing is, in spring, from March to June, or in the autumn, from August to the middle of October. After sowing, the ground should be thoroughly rolled and "firmed," which will greatly aid in the germination of the seed.

The "Queen City" Lawn Grass Seed.

(Weighs 20 Pounds per Measured Bushel.)

Our rapidly increasing sales of Lawn Grass Seeds prove conclusively that their merits are becoming widely known by those who recognize the fact that to produce permanent results seeds of first quality are absolutely necessary.

By a judicious use of some of the best English grasses, combined with the standard American lawn grasses, we are enabled to offer our customers a mixture which is unsurpassed. In our "QUEEN CITY" LAWN GRASS SEED, we offer an improved mixture, which we are confident will supersede "Central Park," which we have sold with great success for the past five years.

It is unquestionably the cheapest seed ever offered, as it is perfectly clean and pure.

A quart will sow a space 15 x 20 feet, a peck 25 x 100 feet, and for an acre 4 to 5 bushels will be required. For renovating old lawns, use one-third to one-half the quantity.

Price, per qt. 25 cts., 4 qts. 75 cts., pk. \$1.25, bus. \$5.

"Central Park" Lawn Grass Seed.

This is the most popular Lawn mixture ever sold in this country, deriving its name from New York's famous park. It is composed of the finest American grasses, thoroughly re-cleaned, and in proper proportions to produce a most neat, velvety appearance and fine, compact growth.

Price, per qt. 20 cts., pk. \$1, bus. \$4.

Grasses, Meadow and Pasture.

- Red Top Grass.** (*Agrostis vulgaris*.) It is valuable as a mixture in pasture or lawn grasses. It is a good permanent grass. Lb. 15 cts., 100 lbs. \$10. Absolutely clean, valuable for fine lawns, lb. 25 cts., 100 lbs. \$20.
- Kentucky Blue Grass.** (*Poa pratensis*.) Fancy grade; sometimes called June Grass. It is valuable for lawns and pasture lands. Lb. 15 cts., 100 lbs. \$10.
- Orchard Grass.** (*Dactylis glomerata*.) Widely known; valuable in pastures; of rapid growth, resisting drought. Lb. 15 cts., 100 lbs. \$12.
- Rhode Island Bent Grass.** (*Agrostis canina*.) A fine variety for lawns. Lb. 30 cts.
- Creeping Bent Grass.** (*Agrostis stolonifera*.) An excellent variety for lawns, succeeding well in moist situations. Lb. 30 cts.
- Tall Meadow Grass.** (*Avena elatior*.) Is highly recommended for soiling, being rapid and luxuriant in its growth. Lb. 30 cts.
- Wood Meadow Grass.** (*Poa nemoralis*.) Well adapted for either pasture or pleasure grounds, having succulent and nutritious herbage of early growth, and thriving well under trees. Lb. 50 cts.
- Italian Rye Grass.** (*Lolium Italicum*.) A variety of great value. Lb. 15 cts., 100 lbs. \$12.
- Crested Dog's-tail.** (*Cynosurus cristatus*.) An excellent grass for hard, dry soils; valuable for pastures and lawns. Lb. 35 cts.
- Sweet Vernal Grass.** (*Anthoxanthum odoratum*.) One of the earliest spring grasses; has an agreeable odor when cut; about 10 lbs. to the bushel. Lb. 40 cts.
- Timothy, or Herd's Grass.** (*Phleum pratense*.) Market price.
- Hard Fescue.** (*Festuca duriuscula*.) One of the most desirable dwarf grasses; excellent for dry soils; 30 lbs. to the acre. Lb. 30 cts.

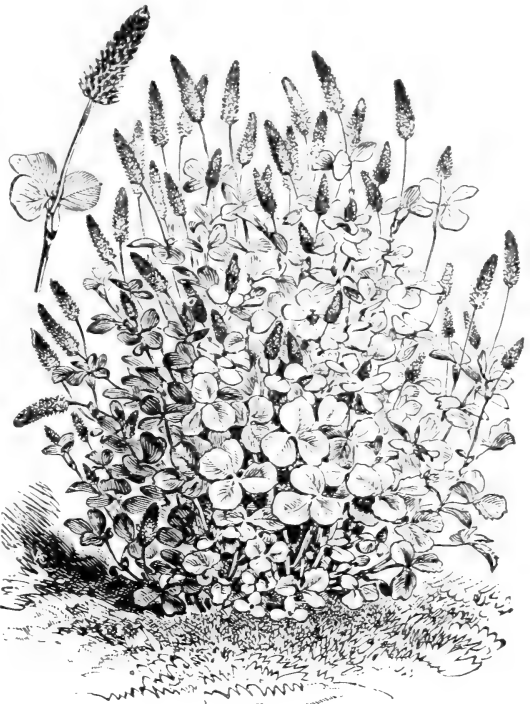

Crimson Clover.

- Meadow Fescue.** A valuable grass for permanent pastures; very productive and nutritious. 50 lbs. to the acre. Lb. 25 cts., 100 lbs. \$15.
- Sheep's Fescue.** (*Festuca ovina*.) An excellent grass for sheep pastures; 30 lbs. to the acre. Lb. 25 cts.
- English Rye Grass.** (*Lolium perenne*.) A very nutritious, rapid-growing variety; valuable for meadows and pastures. Lb. 15 cts., 100 lbs. \$10.

Millet.

- Common Millet.** (*Panicum miliaceum*.) Bus. \$1.
- German Millet.** Medium early. Bus. \$1.25.
- Hungarian Grass.** (*Panicum Germanicum*.) A valuable variety for soiling; not affected by drought. Bus. \$1.25.

Clovers.

- Alfalfa.** (*Lucerne*.) Requires a deep, rich soil, and in such will produce several crops every season; one of the best green-fodder plants. 10 to 15 lbs. to the acre. Price variable.
- Alsike Clover.** (*Trifolium hybridum*.) Resembles in growth, duration, etc., the Red Clover; thrives well in cold, wet and stiff soils. 10 lbs. to the acre. Price variable.
- Large Red, or Pea Vine Clover.** (*Trifolium pratense*.) The English Cow Grass; a variety for plowing under. Price variable.
- Medium Red Clover.** (*Trifolium pratense*.) It is perennial, but of very few years' duration; is considered the most nutritious of all species, and most valuable in most locations. Price variable.
- White Clover.** (*Trifolium repens*.) Valuable for lawns and pastures. Lb. 30 cts., 100 lbs. \$25.
- Crimson Clover.** (*Trifolium incarnatum*.) Sown in August or September, will yield a large crop of early green fodder the following spring. Lb. 10 cts., bus. \$3.50.



Tall Meadow Grass.

Insecticide's (Insect Destroyers.)

- London Purple.** Very poisonous, and equally as efficacious as Paris green, while more soluble in water. Lb. 25 cts.; 100 lbs., 20 cts. per lb.
- Paris Green.** Largely used for the destruction of potato bugs, caterpillars, worms, etc.; being deadly poison, great caution is necessary when using it. Lb. 30 cts.
- Slug-Shot.** A cheap, popular and effective insecticide, easily applied, and not injurious or dangerous to animals. 5-lb. package, 30 cts.; per barrel, in bulk, price on application.
- Grape Dust.** A non-poisonous powder for the remedy of mildew and rot on grapes, gooseberries, roses, etc. 5-lb. package, 35 cts.; per barrel, in bulk, price on application.
- Hellebore.** Powdered white hellebore, for the destruction of caterpillars, slugs, worms, etc. Lb. 40 cts.
- Persian Insect Powder, Pyrethrum, or Buhach.** We offer a superior grade. A most effective non-poisonous, impalpable powder, destroying all kinds of insects. Lb. 40 cts.; 10 lbs., 30 cts. per lb.
- C. H. Joosten's Fostite.** This well-known insecticide is largely used for preventing mildew and black-rot on carnations, roses, chrysanthemums, verbenas, cinerarias, grape-vines, potatoes, etc. 5-lb. package, 50 cts., 25 lbs. \$2, 50 lbs. \$3.50, 100 lbs. \$6.50.
- Fir-Tree Oil Soap.** Fir-Tree Oil is one of the most effective insecticides for general use. The one great objection has been that, owing to its oily nature, it could not be readily diluted with water, when applying. In the new soap, of which the fir-tree oil is the basis, this objection is entirely overcome, and we have a perfect insecticide for all plants, trees and shrubs. Tin, 25 cts.
- Tobacco Soap.** Easy of application, and fatal to all insect life, whether on plants or animals. Packages, 10 and 25 cts.
- Tobacco Stems.** Indispensable for the fumigation of greenhouses, etc., and for the destruction of black aphid, green fly, and other insects. Bale of about 250 lbs., \$3.50.
- Whale Oil Soap.** Excellent wash for trees and plants, to prevent insects from lodging in the bark, and for smearing on the trunks of trees to prevent worms from crawling up. 1-lb. tin, 20 cts.; in bulk, in quantities of 10 lbs. and over, 10 cts. per lb.

Fertilizers.

These Fertilizers are especially prepared for us, are reliable and efficient. In using them, care should be taken to thoroughly mix with the soil, so as not to come in contact with and destroy the seed.

- "Buffalo" Lawn Fertilizer.** This lawn dressing was introduced by us several years ago, and sales since that time have increased largely each year. Stable dressing is always unsightly and otherwise objectionable, while often containing weed seeds. The Buffalo Lawn Fertilizer is perfectly clean, odorless, cheap, and in no way objectionable, while it supplies to the soil the requisite food for a luxurious and uniform growth of grass. It may be applied at any time during the year without injury to young grass, and a remarkable improvement will soon be noticed. The quantity required varies somewhat, according to the condition of the lawn, but in most cases a 10-lb. bag will be found sufficient to cover 300 square feet of space. 5-lb. package 25 cts., 10 lbs. 50 cts., 25 lbs. \$1, 50 lbs. \$1.50.
- Crocker's Complete Manure.** This Fertilizer is especially designed for the market-gardener, and for use on all crops, such as corn, tomatoes, potatoes, peas, beans and early vegetables; is also well suited for grain and for seeding down grass. Guaranteed analysis: Ammonia, 6 to 7 per cent.; available phosphoric acid, 6 to 7 per cent.; equal to bone phosphate of lime, 13 to 16 per cent.; sulphate of potash, 11 to 15 per cent. 10 lbs. 50 cts., 25 lbs. \$1, 100 lbs. \$3, ton \$43.
- Crocker's Special Potato Manure.** Those of our customers who used this fertilizer on potatoes last season were much pleased with the results. It may be used equally as well on other root crops, vines, shrubs, fruit trees, etc. Guaranteed analysis: Ammonia, $4\frac{1}{2}$ to $5\frac{1}{2}$ per cent.; available phosphoric acid, 8 to 9 per cent.; equal to bone phosphate of lime, 17 to 20 per cent.; sulphate of potash, 10 to 12 per cent. 10 lbs. 50 cts., 25 lbs. \$1, 100 lbs. \$3, ton \$40.



- Pure Ground Bone.** Excellent for general use or for mixing with soil for potting purposes. 5 lbs. 25 cts., 50 lbs. \$1.25, 100 lbs. \$2.
- Pure Bone Meal.** Very finely powdered. 100 lbs. \$2.
- Nitrate of Soda.** Highest grade. Market-gardeners are finding this a valuable stimulant for use in forcing early vegetables in the greenhouse or hotbed. 10 lbs. 50 cts., 25 lbs. \$1, 100 lbs. \$3.50.
- Pulverized Sheep Manure.** For general use. 5 lbs. 30 cts., 25 lbs. \$1.25, 50 lbs. \$2, 100 lbs. \$3.
- Plant Food.** When the house-plants become weak and sickly, our plant food will be found useful. Its effects are shown immediately in the renewed vigor and growth of the plant. In packages, 10, 15, 25 and 35 cts. each.

Horticultural and Garden Implements, Tools and Requisites.

Asparagus Buncher. Used for bunching asparagus for market	Each	\$2 50
Bellows—		
For slug-shot, hellebore, pyrethrum, tobacco dust, etc	60 cts. to	1 00
Joosten's Fostite Bellows, strong and durable		3 50
Woodason's. For powder or liquid; best made	\$2 to	3 00
Daisy Grubber. An excellent lawn weeder	40 cts. to	75
Flower Pots. Standard, Bulb Pots, Seed Pans for propagating, etc., Lily Bowls, etc., all prices.		
Forks, Hand-Weeding. Best English make; durable	40 cts. to	75
Fumigator, "Eureka." For burning tobacco stems	\$1.50, \$2 and	2 25
Garden Lines. Finest braided		30
Garden Reels for above. Wrought iron. 75c. to		1 00
Grafting Wax. In ¼, ½ and 1-lb. packages.	Lb., 40 cts.	
Hedge Shears. English; 8 to 10-inch blade.	\$1.50 to	3 00
Hoes. Scuffle, Dutch or push		50
Hyacinth Glasses. For growing bulbs		15
Knives. Budding or pruning. Best English make		75
Knives, Grass Edging. Best English make		50
Labels— Wooden, Pot or Garden, painted—		
	Per 100	1,000
3½-inch tree	\$0 15	\$1 00
4-inch	20	1 25
5-inch	20	1 50
6-inch	25	1 75
12-inch	75	5 00
Lawn Rakes. Steel wire	Each	\$0 50
Moss, Spagnum. For packing, potting and mulching. Indispensable in the greenhouse. Bale, \$1.50.		
Plant Sticks. Round, painted green—		
2, 2½, 3 and 4 feet	1½ cts. per foot.	
5 and 6 feet	2 cts. per foot.	
Pruner, "Levin." Made of the best steel; very strong	75 cts. to	1 00
Pruning Shears. Heavy	\$2.50 to	3 50

Pumps, Myer's Spray. For fruit trees	Each	\$4 50
Putty Bulbs, Scollay's. Saves time in glazing		1 00
Raffia. Cheaper than twine for tying	Lb., 20 cts.; 5 lbs., 80 cts.	
Sprinklers, Rubber. For sprinkling seedlings, cut-flowers, or delicate plants	50, 60, 90 cts. and	1 00
Syringes—		
No. 0. Brass, length 18 inches, one stream, one spray rose		2 00
No. 1. Brass, length 14 inches, one stream, two spray roses		2 50
No. 2. Brass, length 16 inches, one stream, two spray roses		3 00
No. 3. Brass, length 18 inches, one stream, two spray roses		3 50
No. 4. Brass, patent valve, finely finished		5 00
No. 5. " " " " " "		5 50
No. 6. " " knuckle joint		7 50
Cheap zinc. Will not corrode		75



Trowels—		
Solid Steel. Best English make	Each	\$0 35
Forged steel. American	40 cts. to	50
Cleve's Angle. Very useful; 3 sizes	15 cts., 25 cts.,	35
Tree Tubs. Cedar, painted green, with iron handles; all sizes	\$1.75 to	5 00
Trellises. For pot-plants. All sizes and prices.		
Water Pots. Philadelphia pattern, made of galvanized iron; long spout, with two copper-faced roses; very strong and durable; best make.		
4-quart size		1 50
6-quart size		1 75
8-quart size		2 00
10-quart size		2 25
12-quart size		2 50
Weeders.—		
Excelsior		15
Lang's		25
Noyes'		25
Hazeltine's		20
Ross'		40

Books on Horticulture and Agriculture.

Henderson's Handbook of Plants and General Horticulture. New edition	\$4 00
Henderson's Gardening for Profit	2 00
Henderson's Gardening for Pleasure	2 00
Henderson's How the Farm Pays	2 50
Henderson's Practical Floriculture	1 50
Henderson's Garden and Farm Topics	1 00

General List of

FLOWER SEEDS.

Embracing the Choicest Strains of Standard Sorts.

All Flower Seeds Sent by Mail on Receipt of Price.

Annuals grow, bloom and die the first year from Seed.

Biennials bloom the second year from Seed, and then die; though many, if sown early in the Spring, will flower the first year.

Perennials usually bloom the second year from Seed, and continue to grow and bloom for many years. Some will also bloom the first year, if sown early.

ABRONIA.

Beautiful trailing plant, with pretty Verbena-like clusters of sweet-scented flowers; valuable for hanging baskets or vases. Half-hardy annual.

Umbellata. A charming creeping plant, with delicious, fragrant rosy-lilac flowers; ½ ft. Pkt. 5 cts.

ADONIS.

This genus embraces several popular border flowers. They are quite showy, remaining a long time in bloom. Hardy annual.

Æstivalis. (Flos Adonis.) Scarlet. Pkt. 5 cts.

AGERATUM.

A very showy plant, blooming through the summer, and if taken out of the ground in fall and potted, will keep up a succession of flowers during winter. Half-hardy annual.

Mexicanum. Fine for bedding or pot culture; blue; 1 ft. Pkt. 5 cts.

Imperial Dwarf. Blue. Pkt. 10 cts.

"Little Dorrit." White. Pkt. 10 cts.

Swanley Blue. Pkt. 10 cts.

ALYSSUM.

One of the sweetest and most useful of summer flowers; may be used for edgings, borders, rock-work, hanging-baskets, etc.; continues in bloom the entire season.

Sweet. Flowers, white; 1 ft.; hardy annual. Pkt. 5 cts.

Saxatile compactum. (Rock, or Golden Alyssum.) Showy yellow; ¼ ft.; Hardy perennial. Pkt. 5 cts.



Adonis.

AGROSTEMMA. (Rose of Heaven.)

Cœli-rosa. A pretty free-flowering Hardy annual; bright rose; 1½ ft. Pkt. 5 cts.

AMARANTHUS.

Ornamental foliage plants of an extremely graceful and interesting character, producing a striking effect either in the conservatory or flower garden.

Half-hardy annual.

Bicolor. Leaves crimson and green; 2 ft. Pkt. 5 cts.



Snapdragon.

Melancholicus ruber. Foliage blood-red; 2 ft. Pkt. 5 cts.

Caudatus. (Love-lies-bleeding.) Graceful; 3 ft. Pkt. 5 cts.

Salicifolius. (Fountain Plant.) Beautiful and distinct variety, with gracefully drooping willow-shaped leaves, brilliantly marked with orange-carmine and bronze; 4 to 6 ft. Pkt. 10 cts.

Tricolor. (Joseph's Coat.) Leaves scarlet, yellow and green, beautiful; 2 ft. Pkt. 5 cts.

ANTIRRHINUM. (Snapdragon.)

Handsome, free-flowering border plants, with flowers of interesting form, striped and spotted in many rich colors. Half-hardy perennial.

Majus, white. From the choicest named varieties; 2 ft. Pkt. 5 cts.

Striped. Beautifully spotted. Pkt. 10 cts.



Comet Aster.

AUBRIETIA.

Quite an ornamental genus, of dwarf-growing character, and for that reason is a most appropriate plant for rockwork or for planting in edgings. Culture same as given for Auricula.

Græca. Lilac. ½ foot. Hardy perennial. Pkt. 10 cts.

Eryi. Dark blue. Pkt. 10 cts.

ASTERS.

These are among the prettiest annuals in their season, blooming profusely, and producing in great diversity of color flowers of the most perfect and beautiful form. Half-hardy annual.

Truffaut's Pæony-Flowered Perfection. The finest varieties in cultivation; flowers very large and double, the petals beautifully incurved. 1½ feet. Brilliant colors mixed. Pkt. 10 cts.

Snow White. Pkt. 15 cts.

Light Blue and White. Pkt. 10 cts.

Rose and White. Pkt. 10 cts.

Crimson and White. Pkt. 10 cts.

Mixed. Pkt. 10 cts.

Victoria. The finest class of dwarf Asters, and also best for pots.

White. Pkt. 15 cts.

White to Rose. Pkt. 10 cts.

White to Lilac. Pkt. 10 cts.

Mixed. Pkt. 10 cts.

ASTERS, Dwarf Chrysanthemum-Flowered. A very beautiful class of semi-dwarf.

White. Pkt. 10 cts.

Copper-red. Pkt. 15 cts.

Claret. Pkt. 15 cts.

White to Azure. Pkt. 10 cts.

White to Rose. Pkt. 10 cts.

Crown or Cocardeau. White center.

Crimson. Pkt. 10 cts.

Violet. Pkt. 10 cts.

Washington. Splendid, very large flowering, extra double; valuable for exhibition purposes.

White. Pkt. 15 cts.

White, Tinged with Rose. Pkt. 15 cts.

Peach Blossom. Pkt. 15 cts.

Violet. Pkt. 15 cts.

Silver Grey. Pkt. 15 cts.

Comet. Mixed. Pkt. 15 cts.

Ball or Jewel. Mixed. Pkt. 15 cts.

Queen of the Earliest. Pkt. 15 cts.

Vick's Branching. Pkt. 15 cts.

AQUILEGIA. (Columbine.)

Extremely handsome early-blooming plants, with flowers of curious form and attractive colors. Hardy perennials.

Vulgaris flore pleno. Double, 1¼ feet. 5 cts.

ASPERULA. (Woodruff.)

This hardy annual attains a height of 12 inches, bearing beautiful light blue flowers; sweet scented.

Azurea setosa. Blue. 1 foot. Pkt. 5 cts.

Odorata. Pkt. 10 cts.

BALSAM. (Lady's Slipper.)

Magnificent, whether for conservatory or outdoor decoration, producing in gorgeous profusion flowers of the most beautiful and varied colors. Half-hardy perennial.

Double Rose-Flowered. Very double, and of perfect form. Pkt. 10 cts.

Camellia-Flowered. From a magnificent collection of double varieties; fine mixed colors. 2 feet. Pkt. 10 cts.

Double Blotched. Very fine quality. Pkt. 10 cts.

Double White. The finest strain ever offered; highly prized by the New York florists. Pkt. 10c.

Double Mixed Colors. Pkt. 10 cts.

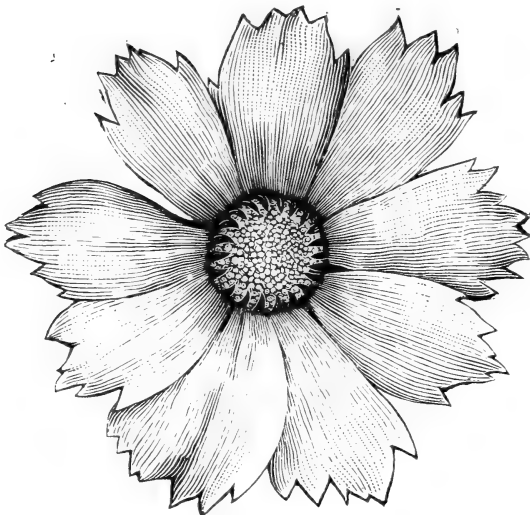

Camellia-Flowered Balsam.

*Calliopsis.***BRACHYCOME. (Swan River Daisy.)**

Fine for edging; should be sown in hotbeds.
Pkt. 5 cts.

BROWALLIA.

Very handsome, profuse-blooming plants, growing freely in any rich soil. Half-hardy Annual.

Elata grandiflora. Sky-blue; large and handsome; $1\frac{1}{2}$ ft. Pkt. 10 cts.

CACALIA. (Tassel Flower.)

A very beautiful and profuse flowering-plant, with tassel-shaped flowers. Hardy annual.

Coccinea. Orange-scarlet; flowering in clusters; pretty; $1\frac{1}{2}$ ft. Pkt. 5c.

CALCEOLARIA.

Plants of a highly decorative character; indispensable for a greenhouse or flower garden. Half-hardy perennial.

Hybrida grandiflora. Magnificent prize varieties. Pkt. 50 cts.

Rugosa. Choice dwarf bedding varieties; mixed. Pkt. 25 cts.

*Calendula. (Marigold.)***CALENDULA. (Marigold.)**

A very showy, free-flowering genus of plants, producing a very pretty effect in beds or mixed borders, and growing freely in almost any soil. Hardy annual. Double.

Pongei. Double white. Pkt. 5 cts.

Le Proust. Double; nankeen yellow. Pkt. 5 cts.

Meteor. Light orange, striped; double. Pkt. 5c.

Bright Yellow. Pkt. 5 cts.

Prince of Orange. It is a very marked improvement on the parent (Meteor) sort, the flowers being striped with a more intense shade of orange, and this glowing tone is imparted to the whole flower. Pkt. 5 cts.

Ranunculus. Pkt. 5 cts.

Sulphurea. Double. Pkt. 5 cts.

CALLIOPSIS. (Coreopsis.)

These very profuse and continuous blooming plants are among the most graceful and effective of hardy annuals. 2 feet.

Drummondii. Bright yellow, with dark center. Very showy. Pkt. 5 cts.

*Rocket Candytuft.***CAMPANULA.**

A well-known tribe of extremely beautiful annuals and perennials.

Media. (Canterbury Bells.) Finest double varieties; mixed; $2\frac{1}{2}$ ft. Pkt. 5 cts.

Carpathica. Mauve. Hardy perennial. 1 foot. Pkt. 5 cts.

CANARY-BIRD FLOWER.

See *Tropaeolum perigrinum*.

CANDYTUFT.

Very pretty, profuse-blooming plants, adapted for ribbons and flower beds. Cultivated in pots, they form neat and pretty plants for the conservatory during the winter. Hardy annual.

Fragrant. Pure white; 1 foot. Pkt. 5 cts.

Dunnett's Crimson. Very dark; 1 ft. Pkt. 5c.

Rocket. White, large trusses; 1 foot. Pkt. 5 cts.

Empress. Very robust; 1 foot. Pkt. 10 cts.

Splendid Mixed. All colors; 1 foot. Pkt. 5 cts.

Perennial. Very hardy; pure white; $\frac{1}{2}$ foot. Pkt. 10 cts.

CANNA. (*Indian Shot.*)

With foliage and tropical luxuriance, this plant is particularly suitable for forming groups on lawns, or placed as backgrounds for dwarfier growing plants, for which purposes it is now largely used. Of late years this tribe has developed great beauty and variety in flowers, giving them added interest and value. Half-hardy perennial.

Choice Mixed Varieties. All colors. Pkt. 5 cts.
Crozy's Early. New and fine. Pkt. 10 cts.

CARDIOSPERMUM. (*Balloon Vine.*)

A rapid-growing, handsome and interesting climber, remarkable for its inflated membraneous capsule. Half-hardy annual.

White. Pkt. 5 cts.

CARNATION.

These well-known charming plants are highly prized for the delicious perfume of their flowers. Varieties raised from seed are infinitely more floriferous than from cuttings, and first quality seed usually produces about 80 per cent. double flowers. Half-hardy perennial.

Finest Double Mixed. From the finest German collection. Brilliant colors, and very fragrant. Pkt. 25 cts.

Double Mixed. Very good quality. Pkt. 10 cts.

Perpetual or Tree, Double. Fine for winter blooming. Pkt. 25 cts.

Red Grenadin. Blooms from two to three weeks earlier than other Carnations. Dwarf habit; color brilliant scarlet. Valuable for either garden or pot culture; double. Pkt. 15 cts.

Marguerite. Sown in spring, will commence flowering in early summer, and continue until frost. New and excellent sort. Pkt. 10 cts.

CELOSIA.

Very singular, attractive and showy plants, producing magnificent spikes of beautiful feathery-looking flowers. They succeed well in the garden, if planted out in June. Graceful and beautiful half-hardy annual.

Cristata. (Cockscomb.) From selected Cockscombs; velvety crimson. 1 foot. Pkt. 5 cts.

Plumosa coccinea. Rich carmine. 3 ft. Pkt. 5 cts.



Marguerite Carnation.



Japanese Chrysanthemums.

CENTAUREA. (*Dusty Miller.*)

Valuable silver-leaved, ornamental bedding plants, growing in any good soil; fine for conservatory and parlor decoration; succeed well when potted and kept through the winter. Greenhouse perennial.

Clementi. Very handsome and ornamental; the leaves, which are deeply cut and fringed, being covered with silvery white down. 2 ft. Pkt. 10 cts.

Candidissima. Splendid silvery, broad-cut leaves. 1 foot. Pkt. 15 cts.

Gymnocarpa. A very graceful, silver variety; valuable for bedding. 1½ feet. Pkt. 10 cts.

Cyanus, Emperor William. (Bachelor's Button.) Hardy annual. 2 feet. Pkt. 5 cts.

Americana. A strong-growing annual variety; flowers reddish purple. 1 foot. Pkt. 5 cts.

CENTRANTHUS.

A pretty, free-flowering, compact-growing plant; does well in any common soil; very effective in beds, edgings, ribbons or borders. Hardy annual.

Mixed Red and White. 2 feet. Pkt. 5 cts.

Albus. White; very pretty. 1 foot. Pkt. 5 cts.

CHRYSANTHEMUM.

The following varieties, when well-grown, are among the most beautiful and showy of summer-blooming plants.

Japonicum. The Japanese long-petaled or fringed varieties; a mixture which should produce many showy varieties. Hardy perennial. Pkt. 15 cts.

Indicum. Extra fine mixed, large-flowering varieties. Half-hardy perennial. Pkt. 15 cts.

Dunneti album. Double white. Pkt. 5 cts.

Dunneti aureum. Double yellow. Pkt. 5 cts.

Eclipse. Yellow and brown. An exceedingly showy variety. Pkt. 10 cts.

Frutescens. (Marguerite, or White Paris Daisy.) Pkt. 10 cts.



Cineraria.

CINERARIA.

A well-known, free-flowering, favorite plant; blooms through a great portion of the year; has a range and brilliancy of color scarcely surpassed. Requires about the same culture as the Calceolaria. Greenhouse perennial.

Hybrida. Extra choice mixed colors; from prize varieties; 2 ft. Pkt. 25 cts.

CLARKIA.

An old favorite, the varieties of which are described below, and which should be treated the same as the Aster. Hardy annual.

Elegans, Double. Pure white. Pkt. 5 cts.

Finest Mixed. Double and single varieties. Pkt. 5 cts.

CLINTONIA.

Dwarf-growing plant for summer flowering; the colors are various shades of blue, purple, white, striped, etc. Suitable for rockwork. Hardy annual.

Elegans. Pkt. 10 cts.

COBÆA SCANDENS.

Handsome half-hardy perennial climber, with purple-lilac flowers of a bell-shape; valuable for the conservatory; may be planted out of doors in June. Elegant climber.

Purple. Pkt. 10 cts.

COIX LACHRYMA. (Job's Tears.)

A curious ornamental grass, the flowers having the appearance of large tears. Pkt. 5 cts.

COLEUS.

One of the most popular ornamental foliage plants. It is very decorative in the flower border, and easily grown from seed, which frequently produces new and distinct varieties. Half-hardy perennial. Seeds saved from new and beautiful hybrids. Pkt. 25 cts.

COLLINSIA.

Very pretty plants, with purple, blue and white flowers. Hardy annual.

Mixed. 1½ feet. Pkt. 5 cts.

CONVOLVULUS, DWARF.

A beautiful, showy plant, with handsome, richly-colored flowers, producing a brilliant effect. Sow middle of May. Hardy annual.

Tricolor minor. Rich violet-purple, with white center; trailer. Hardy annual. Pkt. 5 cts.

Finest Mixed Varieties. Hardy annual. Pkt. 5c.

Azureus. Blue. Pkt. 5 cts.

Mauritanicus. The most beautiful creeping variety introduced. Porcelain-blue, very floriferous; a charming plant for baskets, vases, etc. Hardy perennial; 1 foot. Pkt. 10 cts

Aureus superbus. Yellow. Pkt. 10 cts.

COSMOS.

The plant grows from 5 to 6 feet high; completely covered in the autumn with bloom. Very easily grown, and excellent for cutting purposes.

Mammoth White. Pkt. 15 cts.

Mammoth Pink. Pkt. 10 cts.

CYPRESS VINE.

Among the most beautiful climbing plants which adorn the flower garden. The dark green, very graceful foliage, thickly studded with brilliant starry flowers, is very effective. Half-hardy annuals.

Crimson. Very brilliant; 15 to 20 feet. Pkt. 5 cts.

White. Beautiful and graceful; 15 feet. Pkt. 5c.

Mixed. Fine. Pkt. 5 cts.

DATURA. (Trumpet Flower.)

An ornamental genus of plants; some of the varieties possessing attractions of the highest order. Very effective in shrubbery borders. Half-hardy perennials.

Fastuosa. This is a very showy variety, remarkable for its handsome, large, double flowers; purple and white; 2 feet. Pkt. 5 cts.



Mammoth Cosmos.

DELPHINIUM. (Larkspur.)

One of the most showy and useful plants, possessing almost every requisite for the adornment of the garden, the hardy perennials producing splendid spikes of flowers in profusion throughout the summer. If sown early they bloom the first year from seed. The hardy annuals are profuse bloomers, and succeed best if sown in the autumn, or very early in the spring.



Delphinium.

Formosum. Beautiful spikes of brilliant, rich blue flowers, with a white center. 2½ feet. Pkt. 10 cts.

Nudicaule. Dwarf of compact growth, with spikes of bright scarlet flowers. 18 inches. Pkt. 10 cts.

Cashmerianum. A beautiful dark blue; blooms in corymbs of 6 or more. 15 inches. Pkt. 10 cts.

Elatum. (Bee Larkspur.) Rich, deep blue; very free-blooming. Pkt. 10 cts

Emperor. (Hyacinth-flowered Larkspur.) Finest mixed. 1 foot. Pkt. 5 cts.

Double Tall. A tall, branching variety, with beautiful spikes of flowers of various colors; fine for cut-flowers. 2 feet. Pkt. 5 cts.

DIANTHUS. (Pink.)

A beautiful genus, which embraces some of the most popular and elegant flowers in cultivation, including the Carnation, Picotee Pink and Sweet William.

Chinensis. (China or Indian Pink.) Containing a fine assortment of exquisite colors, a large proportion of the flowers being double. Hardy annual. ½ foot. Pkt. 5 cts.

Heddewigii. A fine variety from Japan, producing flowers 2 to 3 inches in diameter, the colors



Dianthus Chinensis.

varying from a rich velvety crimson to a delicate rose. Hardy annual. 1 foot. Pkt. 10 cts.

Diadem, Double. Splendid large, double flowers of various colors, beautifully edged and marbled. Pkt. 10 cts.

Eastern Queen. Large, single, white-fringed flowers, marbled and streaked with carmine rose. Pkt. 10 cts.

Crimson Belle. Large, single, fringed flowers color velvety crimson; very beautiful. Pkt. 10c.

Snowflake. Large, snow-white, fringed flowers. Pkt. 10 cts.

Bride. Fringed, large single flowers; edge pure white, shading to deep crimson; maroon center. Pkt. 10 cts.

Mourning Pink. Fringed, double flowers; colors shading from rich purple maroon to almost velvet black, sharply edged with clear white. Pkt. 10 cts.

Imperial Double. A charming variety in good mixture. Pkt. 5 cts.

DIGITALIS. (Foxglove.)

Handsome ornamental plants of stately growth and varied colors. Hardy perennials.

Gloxinia-flowered. Fine mixed varieties. Pkt. 10c.



Double Daisy. Longellow.

DOUBLE DAISY.

A well-known hardy perennial plant; suitable for edgings or pot culture.

Finest Varieties. Mixed. ¼ foot. Pkt. 10 cts.

ECHINOCTYSIS LOBATA. (Wild Cucumber.)

An old-fashioned favorite, excellent for covering verbenas and for training over arbors, fences, etc. A very rapid grower. Pkt. 5 cts.

EVERLASTING FLOWERS.

The following is a selection of the very best varieties of this class. They are highly prized as an ornament to the garden when growing, and for the winter decoration of vases, etc., they have no superior.

Acroclinium. Mixed, rose and white. Pkt. 5 cts.

Gomphrena. Mixed. (Bachelor's Button.) Pkt. 5c.

Helichrysum. Dwarf varieties, mixed. Pkt. 5 cts.

Rhodanthe. Mixed. Pkt. 5 cts.

Xeranthemum. Mixed. Pkt. 5 cts.

Mixed Everlastings. Many varieties other than above. Pkt. 5 cts.

A beautiful Lawn is of first importance.

ERYSIMUM.

Showy, free-flowering, handsome, hardy annuals, very effective in beds or mixed borders.

Arkansanum. (Western Wallflower.) Sulphur-yellow. 1½ feet. Pkt. 5 cts.

Peroffskianum. Beautiful shade of orange. Pkt. 5 cts.

ESCHSCHOLTZIA.
(California Poppy.)

A showy, profuse-flowering plant, with rich and beautiful colors; a good bloomer; adapted for bedding or massing; delights

*Eschscholtzia.*

in a rich soil. A handsome, half-hardy perennial.

Yellow. Pkt. 5 cts.

White. Pkt. 10 cts.

Mixed. Beautiful for contrasts. Pkt. 10 cts.

ERYTHRINA. (Coral Tree.)

Forms a shrub about 5 feet high, bearing large spikes of deep scarlet, pea-shaped blossoms. Half-hardy shrub.

Crista-galli. Scarlet. Pkt. 15 cts.

EUPATORIUM.

A very pretty, herbaceous, hardy, perennial plant, blooming the first season from seed, producing clusters of showy white flowers; fine for cutting and bouquets. 1½ feet.

Fraseri. Pkt. 10 cts.

EUPHORBIA.

Variiegata. White foliage, nicely veined and margined with white. Half-hardy annual. 2 feet. Pkt. 5 cts.

EUTOCA.

A very attractive border plant, of simple culture, from California. Hardy annual.

Finest Mixed Varieties. 1 foot. Pkt. 5 cts.

EVENING PRIMROSE. (*Oenothera biennis*.)

A beautiful hardy perennial, opening its large yellow flowers in the evening. Pkt. 5 cts.

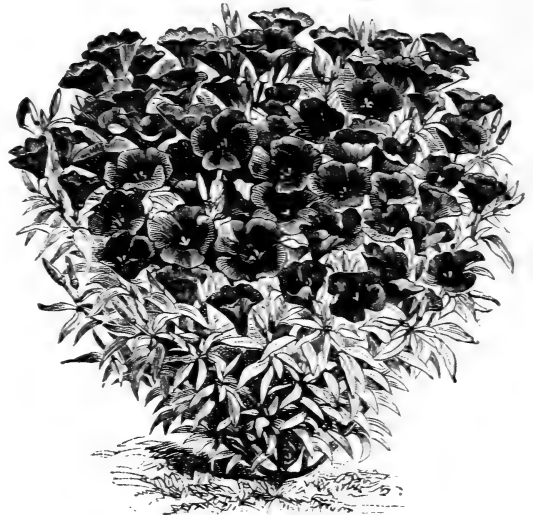
*Oenothera or Evening Primrose.**Godetia Lady Albemarle.***FUCHSIA.**

A well-known and much-admired plant, alike suitable for the parlor and conservatory. Hardy perennial.

Fine Mixed. Pkt. 25 cts.

GAILLARDIA.

Very showy plants, with flowers remarkable for their profusion, size and brilliancy of color, blooming throughout the summer and autumn. Thrive in any rich soil. Half-hardy annual.

Grandiflora. Crimson and yellow. 1½ feet. Pkt. 10 cts.

Picta Lorenziana. Known as the double variety. Entirely distinct from the single. Pkt. 5 cts.

GILIA.

A very pretty dwarf annual. Will bloom in almost any situation; grows well in pots. Hardy annual.

Tricolor. White, lilac and purple. 1 foot. Pkt. 5 cts.

GLOXINIA.

This is a superb genus of greenhouse plants, producing magnificent flowers of the richest colors. Perennial.

Tigered and Spotted. From a famous collection of erect and flowering varieties. Pkt. 25 cts.

GODETIA.

Very attractive and exceedingly beautiful plants, embracing a great variety of rich colors; effective in beds, masses and mixed borders. Hardy annuals.

Duchess of Albany. Flowers white. 4 inches across. Pkt. 5 cts.

Lady Albemarle. Crimson, very handsome. Pkt. 5 cts.

*Gloxinia.*

GOURDS, ORNAMENTAL. (Cucurbita.)

Very ornamental climbers, with fruit of the most singular description, both as to shape and marking; of rapid growth and luxuriant foliage. Very desirable for trellis work, etc. Tender annual.



Gourds.

Orange. (Mock Orange.) Pkt. 5 cts.

Bottle-Shaped. Pkt. 5 cts.

Hercules' Club. Pkt. 5 cts.

Dish Cloth. Pkt. 10 cts.

Egg-Shaped. Pkt. 10 cts.

Mixed. Pkt. 5 cts.

GYPSOPHILA.

Elegans. A very graceful plant, with beautiful white and pink flowers. Fine for table bouquets. Hardy annual. 1½ feet. Pkt. 5 cts.

HELIOTROPE.

Well-known, deliciously fragrant plants, excellent for bedding or pot culture. Half-hardy perennials.

Finest Mixed. 18 inches. Pkt. 10 cts.

HELIANTHUS. (Sunflower.)

The following varieties are remarkable for their majestic growth and fine, bold outline. Admirably adapted for intermingling in shrubberies, where their brilliant, large flowers are very effective. Hardy annual.

Californicus. Very large, double orange flowers. 5 ft. Pkt. 5 cts.

Globosus fistulosus. The finest variety in cultivation. Flowers 1 foot in diameter, of bright, rich saffron color. 5 feet. Pkt. 10 cts.



Heliotrope.

Russian Mammoth. Immense flowers; very showy. 6 feet. Pkt. 5 cts.

Macrophyllus giganteus. A very tall variety, with large yellow flowers. 10 feet. Pkt. 10 cts.

Dwarf Double. Pkt. 10 cts.

HIBISCUS.

A very ornamental and showy hardy annual; color a rich cream, with brown center.

Africanus. 1½ feet. Pkt. 5 cts.

HOLLYHOCK.

Sow from June to August in light soil. Thin out the seedlings sufficiently early to allow individual development of growth. In October plant out where to bloom. The plants should have a mulching of leaves or litter for winter protection, or should be planted in cold-frames for early flowering. In our climate it is best to sow every season, treating the plant as a biennial. This fine old plant, once so popular, deserves a place in every flower garden.

Extra Choice Mixed, Double. Pkt. 10 cts.

Separate Colors. Crimson, Scarlet, Pink, White, Yellow, Striped. Pkt. 10 cts.

The double Hollyhocks are now as regular and refined in form as the single ones are picturesque. Besides the type shown in the illustration, there are others more closely approaching the Rose in shape.



Double Hollyhock.

HONESTY.

Interesting summer-blooming plants, suitable for shrubberies or woodland walks. Very handsome in bouquets of dried flowers, for which it has been much used in the past. Hardy biennial.

Purple. 2 feet. Pkt. 5 cts.

HYACINTH BEAN.

A rapid growing plant, flowering freely in clusters. For covering arbors, trellises, etc. Sow the seed in the garden where desired. Tender annual. 10 feet.

Dolichos, Mixed. Pkt. 5 cts., oz. 25 cts.

Our Summer-flowering Bulbs are large and fine, sure to produce grand beds. See special department.

*Japanese Hop.***JAPANESE HOP.** (*Humulus.*)

An extremely rapid-growing climber, suitable for fences and arbors. Pkt. 10 cts.

ICE PLANT. (*Mesembryanthemum crystallinum.*)

A pretty trailing plant of dwarf habit, suitable for rock-work and flower borders. The leaves are covered with crystal-like, icy globules, and are extensively employed in garnishing. Half-hardy annual. Pkt. 5 cts.

IPOMOPSIS. (Standing Cypress.)

Most beautiful plants, with long spikes of dazzling orange and scarlet flowers. Half-hardy biennial.

Elegans. Scarlet. 3 feet. Pkt. 5 cts.

Aurantiaca. Orange. 3 feet. Pkt. 5 cts.

JACOBÆA. (*Senecio.*)

For large beds and mixed borders the Jacobæa has long been a favorite. It is a continuous bloomer, and with its rich array of colors produces a splendid effect. Hardy annual.

Purple. 1 foot. Pkt. 5 cts.

White. 1 foot. Pkt. 5 cts.

Tall. Double mixed. Pkt. 5 cts.

LARKSPUR.

See Delphinium.

LEUCANTHEMUM.

The common large white Daisy; it is a very floriferous plant when under cultivation. Pkt. 10 cts.

LEPTOSIPHON.

Although a native of this country, this pretty little annual is much more appreciated in Europe than here at home. All of the varieties are of the easiest culture, and well suited for marginal lines in ribbon beds.

Hybridus. Fine mixed. Pkt. 10 cts.

LINARIA.

A particularly effective plant in rock-work or ribbon lines. Hardy annual.

Cymbalaria. (Kenilworth Ivy.) 2½ feet. Pkt. 15c.

LINUM.

Grandiflorum rubrum. One of the handsomest annuals ever introduced; for brilliancy of color and duration of bloom it is unsurpassed; brilliant scarlet. Hardy annual. 1 foot. Pkt. 5 cts.

LOASA. (*Caiphora.*)

A handsome, rapid-growing, free-flowering climber, with curious looking, beautiful flowers.

Tricolor. Shaded yellow. Hardy annual. Pkt. 10c.

LOBELIA.

Mostly dwarf-growing, valuable and beautiful class of plants, with delicate, drooping habit. The profusion of their charming flowers renders them very ornamental for vases and hanging baskets, borders or ribbons. Half-hardy annual.

Erinus gracilis. Light blue trailer. Pkt. 10 cts.

Emperor William. Light blue. Pkt. 10 cts.

Cardinalis. Cardinal flower. Pkt. 10 cts.

Crystal Palace compacta. Intense blue. ½ foot. Pkt. 10 cts.

Compacta alba. Pure white. ½ foot. Pkt. 10 cts.

*Linum grandiflorum.*

See our Pansy List, on page 41.

LOPHOSPERMUM.

Scandens. A beautiful climbing plant, with large trumpet-shaped flowers. Half-hardy annual. Pkt. 10 cts.



Lophospermum.

LUPINUS.

A splendid genus of handsome and ornamental garden plants, with long, graceful flower-spikes of rich and varied colors; valuable for mixed borders. Annual and perennial. Pkt. 5 cts.

LYCHNIS.

A hardy, ornamental and handsome genus of plants, easy of culture; has a good effect in shrubbery and borders. Hardy perennial.

Haageana hybrida. Finest mixed; colors very beautiful. Pkt. 10 cts.

Haageana, Crimson. A charming variety, new and distinct. Pkt. 10 cts.

Scarlet. 2 feet. Pkt. 10 cts.



Lupinus.

MALOPE.

Handsome plants of a branching habit, producing large flowers in profusion; succeed in any good soil. Hardy annual.

Grandiflora. Rose. 2 feet. Pkt. 5 cts.

MARIGOLD. (Tagetes.)

A well-known plant, with handsome flowers of rich and beautiful colors, and of neat, compact green foliage. The African is the tallest and most striking in large beds and shrubbery borders, while the French fills it in front or is used for small beds. Half-hardy annual.

African Lemon. Double. 2 feet. Pkt. 5 cts.

Orange. Double. 2 feet. Pkt. 5 cts.

French. Cloth of Gold. Pkt. 5 cts.

Finest Mixed Colors. Pkt. 5 cts.

Signata pumila. Pkt. 5 cts.

MARVEL OF PERU. (Four O'clock.)

Extremely handsome border plants, remarkable for their compact growth, rich, glossy leaves, profusion of bloom, and diversity of color in flower and foliage. Half-hardy perennial. Finest mixed, brilliant colors. 2 feet. Pkt. 5 cts.



Marvel of Peru.

MATHIOLA.

Bicornis. An evening-scented Stock, growing over a foot high. During the daytime the blossoms of pink and lilac are partially closed, and the scent is slight and feeble, but towards evening it expands

fully, remaining so during the night, emitting a delicious fragrance. Pkt. 10 cts.

MAURANDYA.

These charming climbers cannot be too highly praised for their beautiful flowers and foliage. From their graceful, slender growth they are admirably adapted for hanging baskets, vases, or any form of trellis-work. Half-hardy perennial.

Barclayana. Deep violet. 10 feet. Pkt. 10 cts.

Finest Mixed Colors. Pkt. 10 cts.



Maurandya.

MORNING-GLORY. (Convolvulus Major.)

Fine Mixed Colors. Hardy annual. 20 feet. Pkt. 5 cts.

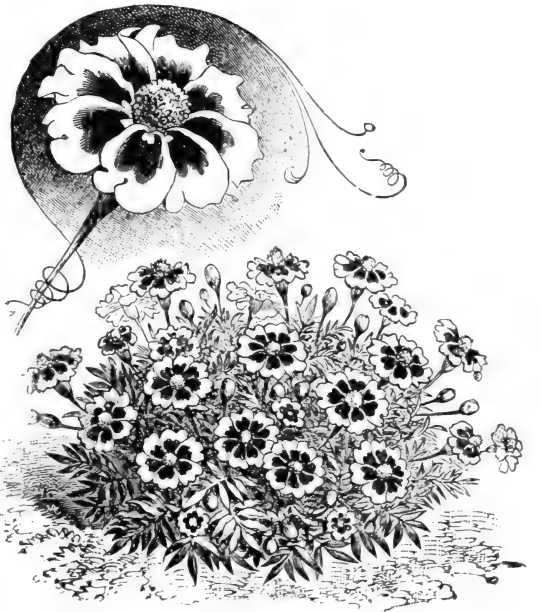

Marigold.

Every flower lover should try a few Tuberous Begonias,

MESEMBRYANTHEMUM.

Dwarf-growing plants of great beauty; well suited for edgings and covering rock-work; produce their star-like flowers in great abundance the whole summer. Half-hardy annual.

Tricolor. (Wax Pink.) Mixed colors. $\frac{1}{2}$ foot. Pkt. 5 cts.

Cordifolium. Curious and beautiful. Pkt. 10 cts.

Pomeridiana. Gold and yellow. Pkt. 10 cts.

MIGNONETTE.

A well-known fragrant favorite. If the plants are thinned out they will grow stronger and produce larger spikes of flowers; fine for pot or garden culture, and can be had during the whole year by sowing at intervals. Hardy annual.

Sweet-Scented. (Odorata.) The only variety with small spikes. 1 foot. Pkt. 5 cts.

Grandiflora Ameliorara. Plants pyramidal; flowers large and distinct, having stamens of a reddish tint. 15 inches. Pkt. 5 cts.

Golden Queen. A very attractive variety, forming a dense pyramid, and throwing up numerous flower stalks, terminating in spikes of golden yellow. 15 inches. Pkt. 10 cts.

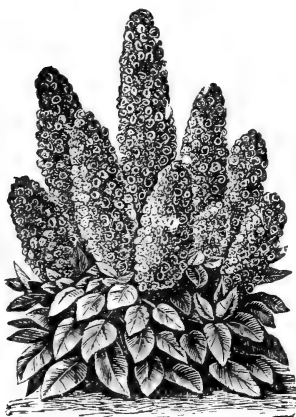
*Mignonette.***Parson's White.**

large spikes, pure white and very fragrant. 1 foot. Pkt. 10 cts.

Crimson Queen.

Very fine, robust; excellent for pots; red-flowered. Pkt. 10 cts.

Gabrielle. Large spikes of red flowers; very fine. Pkt. 10 cts.

Machet. Well adapted for pot culture; perfectly true from seed; dwarf, pyramidal growth, bearing numerous flower stalks. Pkt. 10 cts.

MIMULUS. (Monkey Flower.)

Extremely handsome, profuse-blooming plants, with flowers of singular form and brilliant colors, distinguished by their rich and beautiful markings. Seeds sown in spring make fine bedding plants for summer. Half-hardy perennial.

Cupreus tigrinus. Flowers large and handsome; stained, spotted, blotched and speckled in the most curious and striking manner. Pkt. 10 cts.

Finest Mixed Varieties. Pkt. 10 cts.

Moschatus. (Musk Plant.) Yellow. $\frac{1}{2}$ foot. Pkt. 10 cts.

MIMOSA. (Sensitive Plant.)

A very interesting and curious plant, its leaves closing if touched or shaken. Half-hardy perennial.

Pudica. $1\frac{1}{2}$ feet. Pkt. 5 cts.

MUSK PLANT.

See Mimulus.

MYOSOTIS. (Forget-me-not.)

Neat and beautiful little plants with star-like flowers, succeeding best in a shady situation; half-hardy perennial; blooming the first year from seed if sown early.

Azorica caelestina.

Handsome sky-blue flowers produced in great profusion. 1 foot. Pkt. 15 cts.

Dissitiflora.

Compact habit, profuse bloomer, exquisite blue; an attractive bedding plant. 6 inches. Pkt. 10 cts.

Palustris.

The true Forget-me-not; beautiful blue flowers. 6 inches. Pkt. 10 cts.

Alpestris Victoria. Of bushy habit, bearing large, bright azure flowers. This beautiful Forget-me-not is the best for growing in pots. Pkt. 15 cts.

*Myosotis.***NASTURTIUM. (Dwarf.)**

These will always be valuable summer flowering-plants, for the reason that they stand any amount of heat and drouth, growing vigorously and flowering freely, no matter how high the thermometer may record. They flower better, however, in a poor, rocky soil, as a rich one has a tendency to make them "run to leaf." The "Tom Thumb" varieties are splendid bedding sorts. Hardy annual.

Tom Thumb. Scarlet. 1 foot. Pkt. 5 cts.

Empress of India. Crimson. Pkt. 10 cts.

Ruby King. Deep scarlet. Pkt. 5 cts.

Golden King. Yellow. Pkt. 5 cts.

King of Tom Thumbs. Intense scarlet. Pkt. 5 cts.

Crystal Palace Gem. Sulphur yellow. Pkt. 10 cts.

King Theodore. Dark scarlet. Pkt. 10 cts.

Lady Bird. Yellow and crimson. Pkt. 10 cts.

*Dwarf Nasturtium.*

To beautify an unsightly wall or fence, plant a row of Sweet Peas.

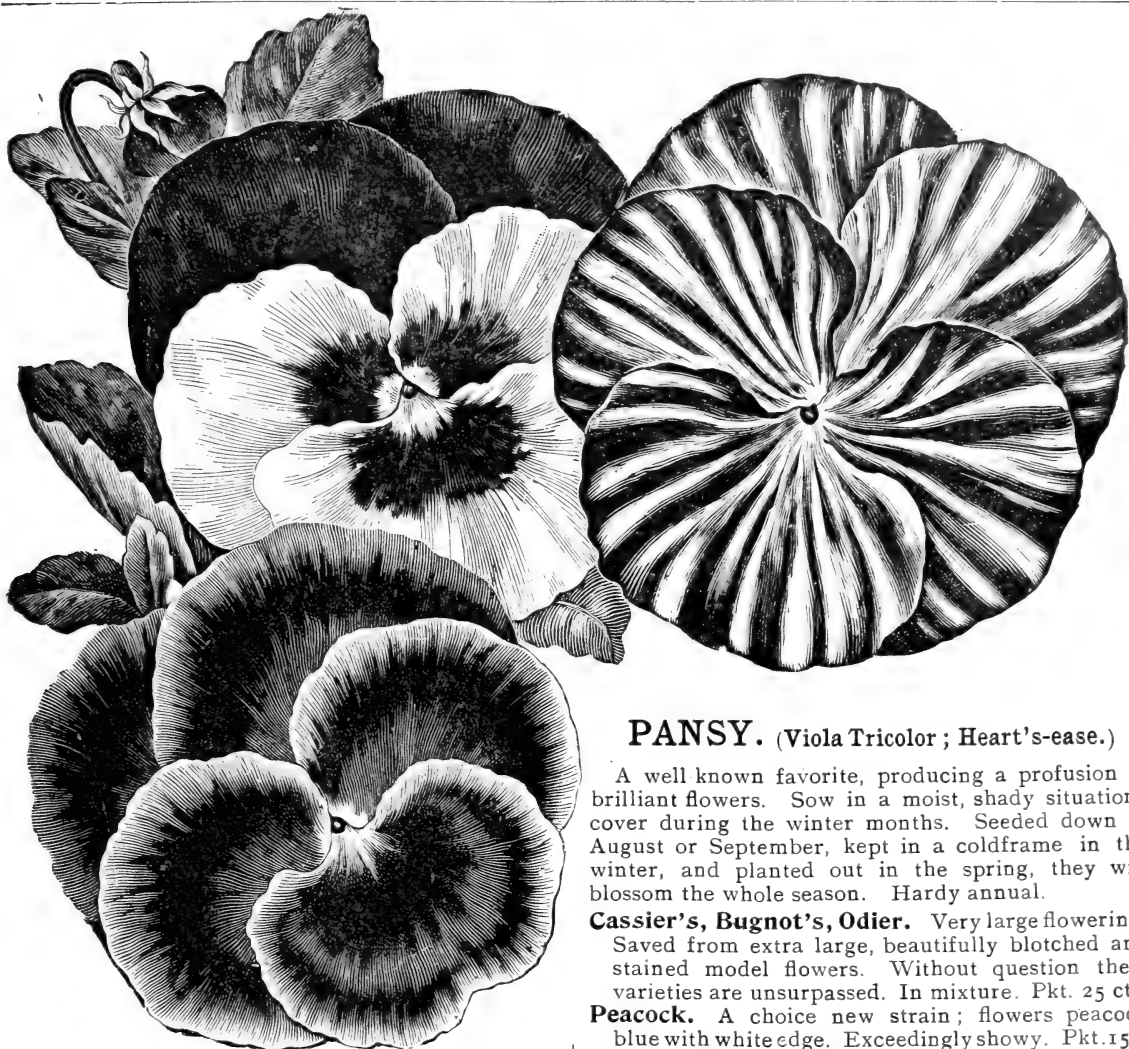

Pansy.

NEMOPHILA.

A genus of exceedingly beautiful dwarf-growing plants. Their height and habit of growing being so uniform, and the colors so varied and striking, they are always pleasing. Beautiful hardy annual.

Insignia. Clear blue, white center. $\frac{1}{2}$ ft. Pkt. 5 c.

Fine Mixed. All colors. Pkt. 5 cts.

NICOTIANA AFFINIS.

A remarkable species, producing at the extremities of long, hairy tubes, large, pure white flowers. They are in full beauty morning and evening, and emit a delicious fragrance. Annual. Pkt. 5 cts.

NIGELLA.

Beautiful border plants, with prettily cut foliage and curiously formed flowers. Hardy annual.

Damascena Double. $\frac{1}{2}$ foot. Pkt. 5 cts.

NOLANA.

Very showy when in flower, and should be planted in the border; a fine trailer.

Mixed. Pkt. 5 cts.

NYCTERINIA.

Sweet-scented little plants, with large heads of star-shaped flowers, well suited for edgings; succeeds in light, rich soil. Half-hardy annual.

Capensis. White, yellow center. $\frac{1}{2}$ foot. Pkt. 5c.

PANSY. (Viola Tricolor; Heart's-ease.)

A well known favorite, producing a profusion of brilliant flowers. Sow in a moist, shady situation; cover during the winter months. Seeded down in August or September, kept in a coldframe in the winter, and planted out in the spring, they will blossom the whole season. Hardy annual.

Cassier's, Bugnot's, Odier. Very large flowering. Saved from extra large, beautifully blotched and stained model flowers. Without question these varieties are unsurpassed. In mixture. Pkt. 25 cts.

Peacock. A choice new strain; flowers peacock blue with white edge. Exceedingly showy. Pkt. 15c.

Trimardeau or Giant. A distinct and beautiful race. Each flower is marked with three large blotches or spots, and the plants produce an endless variety of beautiful shades. Pkt. 15 cts.

Trimardeau Yellow. Pure yellow with dark eye.

One of the finest and showiest Pansies. Pkt. 25 cts.

Trimardeau White. Pure white, with purple eye.

Very beautiful. Pkt. 25 cts.

Non Plus Ultra, or Giant Five-Spotted. Enormous flowers of perfect symmetry; beautifully blotched petals. Pkt. 25 cts.

Silver Edged. Dark purple, with distinct white edge. Very striking. Pkt. 10 cts.

Gold Edged. Pkt. 10 cts.

Large Parisian Stained. Unsurpassed for shape, markings and richness of color. Pkt. 15 cts.

Victoria. New reddish bronze; large. Pkt. 10 cts.

Snowflake, or Snow Queen. A pure satiny white; very fine. Pkt. 10 cts.

Yellow Gem. Pure yellow. Pkt. 10 cts.

Fawn. Bronze yellow. Pkt. 10 cts.

Faust, or King of the Blacks. Flowers intensely black. Pkt. 10 cts.

Beaconsfield. Large-flowering, purple and violet. Pkt. 10 cts.

Emperor William. Deep ultra-marine blue; solid color. Pkt. 10 cts.

Mahogany. Velvety red-brown. Pkt. 10 cts.

Good Mixed. Pkt. 10 cts.

PASSIFLORA. (Passion Flower.)

A greenhouse climber. A very handsome and curious plant. Pkt. 15 cts.

PENTSTEMON.

In shape the flowers somewhat resemble the gloxinia's, and are shaded and mottled in white, blue, crimson and scarlet. Half-hardy perennial.

Fine Mixed. Pkt. 10 cts.

PERILLA.

As a bedding plant, in certain situations, the Perilla presents a matchless effect. Its habit of growth is neat and shrubby, while its dark bronze foliage forms a beautiful and striking contrast, especially to plants of the silver-leaved order. Half-hardy annual.

Nankinensis. Deep mulberry foliage; from China; 1½ feet. Pkt. 5 cts.

PETUNIA.

A highly ornamental and profuse-flowering, easily cultivated garden favorite; equally effective and beautiful, whether grown in pots, for the decoration of the greenhouse and sitting-room window, or planted out in beds or mixed borders. The brilliancy and variety of its colors, combined with the duration of its blooming period, render it invaluable. Half-hardy annual.

Pure White. Single. Pkt. 10 cts.

Fine Mixed. Single. Many beautiful and fancy colors. Pkt. 10 cts.

Hybrida grandiflora plena. The finest double variety grown. Pkt. 25 cts.



Petunia hybrida grandiflora plena.

PHLOX DRUMMONDII.

For brilliant effect and continuous blooming in the flower garden, it is hardly possible to overestimate the *Phlox Drummondii*. As a plant of simple culture and accommodating habit, it is not excelled by any annual in cultivation. Half-hardy annual. 1 foot.

Alba. Pure white. 1 foot. Pkt. 10 cts.

Coccinea. Fine deep scarlet. 1 foot. Pkt. 10 cts.

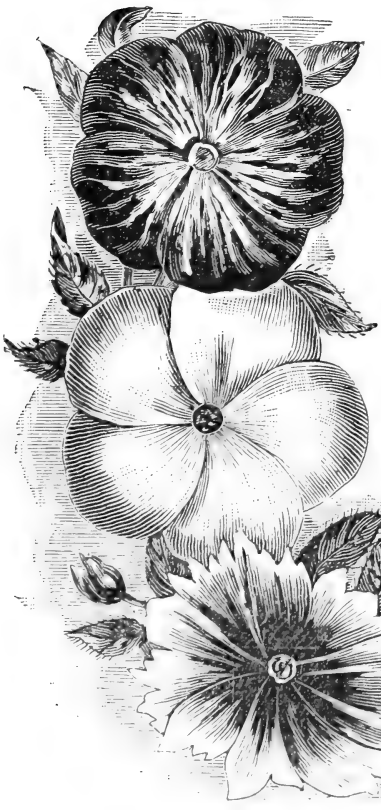

Grandiflora splendens. A charming variety, with large, bright, scarlet flowers, which are rendered very striking by a conspicuous pure white center. Pkt. 10 cts.

Purpurea. Fine deep purple. 1 foot. Pkt. 10 cts.

Cuspidata. (Star of Quedlinburg.) Pkt. 10 cts.

Fine Varieties. Mixed. Pkt. 10 cts.

PICOTEE PINK.

Of all florststs' flowers, none can surpass this in beauty, delicacy of marking, form and deliciousness of fragrance. Half-hardy perennial.

Choice Varieties. Mixed, 1½ feet. Pkt. 25 cts.

PYRETHRUM. (Feverfew.)

Very beautiful and exceedingly ornamental, herbaceous plants; succeeding in any garden soil. Hardy perennial.

Parthenifolium aureum. (Golden Feather.) Golden foliage; fine for bedding. 1 foot. Pkt. 10 cts.

Parthenium fl. pl. (Double Feverfew.) White. Pkt. 10 cts.



The Shirley Poppy.

POPPY.

A genus of extremely showy free-flowering plants, which, by their stately form, brilliant and effective colors, are admirably adapted to enliven shrubbery and mixed borders. Hardy annual.

Carnation. Double mixed. From many varieties. 2 feet. Pkt. 5 cts.

The Shirley. These charming Poppies are generally single or semi-double. The range of color, extending from pure white through the most delicate shades of pale pink, rose and carmine to deepest crimson, is so varied that scarcely two are alike, while many are very delicately edged and striped. Pkt. 10 cts.

Croceum. Orange. Pkt. 5 cts.

Mephisto. Scarlet, with black spots. Pkt. 10 cts.

Umbrosum. Vermilion, with black spots. Pkt. 5 cts.

Danebrog. New single. Brilliant scarlet. Pkt. 5 cts.

Pæony-Flowered. Double mixed. 2 feet. Pkt. 5 cts.

French or Ranunculus. Double. Choice mixed. 2 feet. Pkt. 5 cts.

Tulip. Scarlet. Pkt. 10 cts.

Mikado. Fringed white, with crimson stripe. Pkt. 10 cts.

Fairy Blush. New. Pkt. 10 cts.

Iceland. White. Pkt. 10 cts.

Fine Mixed. Including the above. Pkt. 5 cts.

PORTULACA.

For brilliancy, delicacy, diversity and beauty of color, the Portulaca surpasses all other outdoor plants. It luxuriates in light soils and sunny situations, rapidly carpeting the ground with its flowers and foliage. For small beds, edgings, rock-work or hanging baskets, it is incomparably the finest annual grown. Half-hardy annual.

Fine Mixed. Single, all colors. Pkt. 5c.

Grandiflora, Double. Finest mixed.

The seeds are selected from large double flowers of the most beautiful and brilliant colors. Pkt. 20 cts.

PRIMULA. (Chinese Primrose.)

For winter decorations, the Primula is one of the most important greenhouse plants. The seed offered has been saved from the finest types, the flowers being large, rich in color, and of great substance, while the habit of the plant is robust, and the flowers stand well above the foliage. Greenhouse perennial.

Sinensis rubra. Common and Chinese Primrose. ¾ foot. Pkt. 25 cts.

Alba. White. Pkt. 25 cts.

Kermesina. Fringed crimson. Pkt. 50 cts.

Pulcherrima. White, with violet eye. Pkt. 50 cts.

True Yellow Primrose. Pkt. 20 cts.

Japanese Primrose. Pkt. 10 cts.

Obconica. New, a profuse bloomer; flowers pure white, shading to lilac. Pkt. 30 cts.

RICINUS. (Castor Oil Bean.)

These plants are cultivated for the stately, picturesque, and highly ornamental character of their growth and foliage. From seed they quickly attain gigantic proportions, and are ornamental until destroyed by frost. Hardy annual.

Giganteus. Leaves of immense size. 12 feet. Pkt. 5 cts.

Mixed Varieties. Containing the above. Pkt. 5c.

SALPIGLOSSIS.

Large-Flowering. Finest mixed varieties, including scarlet, sky-blue, yellow and black. 1½ feet. Pkt. 10 cts.

SANVITALIA.

Very effective, compact-growing plants; admirably adapted for small beds or rock-work. Hardy annual.

Procumbens. A very dense and compact-growing plant, covered with beautiful rich brown and yellow blossoms. 1½ feet. Pkt. 5 cts.



Primula Sinensis.

SALVIA.

Magnificent bedding plants of the most brilliant and effective character. Laden with gorgeous scarlet spikes. A bed of *Salvia Splendens* forms a beautiful and highly attractive object.

*Scabiosa.*

masses of minute cross-shaped rose and white flowers, which continue blooming all summer. Hardy annual.

Calabrica. Rich, deep pink. $\frac{1}{2}$ foot. Pkt. 5 cts.
Alba. Pure white. $\frac{1}{2}$ foot. Pkt. 5 cts.

SCABIOSA.

(Sweet Scabious, or Mourning Bride.)

A very showy, free-flowering plant, producing a great profusion of beautiful and richly-colored flowers. A half-hardy biennial.

Tall German Mixed. Very showy. 2 ft. Pkt. 5c.
Dwarf Mixed. 1 foot. Pkt. 5 cts.
Candidissima. Pkt. 5 cts.

SCHIZANTHUS.

A beautiful plant of splendid growth, with a profusion of magnificent flowers. Half-hardy annual.

Grandiflorus oculatus. Various shades. $1\frac{1}{2}$ feet. Pkt. 5 cts.

SILENE.

A beautiful genus of free-flowering plants, with bright, attractive flowers; admirably adapted for spring and summer blooming in beds, rock-work, etc.

Pendula compacta. During the season are perfectly solid with bloom. Pkt. 5 cts.

Carnea fl. pl. Producing beautiful double flowers of a delicate pink. Pkt. 10 cts.

Alpestris. For rock-work. Pkt. 10 cts.

SMILAX.

(*Myrsiphyllum Asparagoides.*)

In many respects the Smilax is the most useful and it is certainly one of the most graceful climbers which adorn the greenhouse or conservatory; for bouquets and floral decorations it is indispensable. Tender perennial. Pkt. 10 cts.

STOCK. (Gilliflower.)

The Stock Gilliflower is one of the most popular, beautiful and important of our garden favorites, and whether for bedding, massing, edging, ribboning or pot-culture, it is unsurpassed, either for brilliancy and diversity of color, or profusion and duration of bloom. All the varieties are delightfully fragrant. Half-hardy annual.

DWARF GERMAN DOUBLE TEN-WEEKS.

New Large-Flowering. The finest variety grown; many magnificent colors; mixed. $1\frac{1}{2}$ ft. Pkt. 10c.

Snowflake. New, white. Pkt. 15 cts.

Giant Perfection. Mixed. Pkt. 15 cts.

German Dwarf. Finest mixed. 1 foot. Pkt. 10 cts.

Ten-Weeks. All colors, mixed. Pkt. 10 cts.

INTERMEDIATE, or AUTUMN-FLOWERING.

The Intermediate Stocks are valuable on account of their flowering late in autumn; also as pot plants for early spring blooming, for which purpose the seeds should be sown in July or August. Half-hardy biennial.

Intermediate Scarlet. Pkt. 15 cts.

White. Pkt. 15 cts.

Purple. Pkt. 15 cts.

Mixed. Pkt. 15 cts.

Our Stock
Seed is
Extra Fine.
Try It
and See.

*German Stocks.*

Use Grape-Dust for Mildew on Rose.

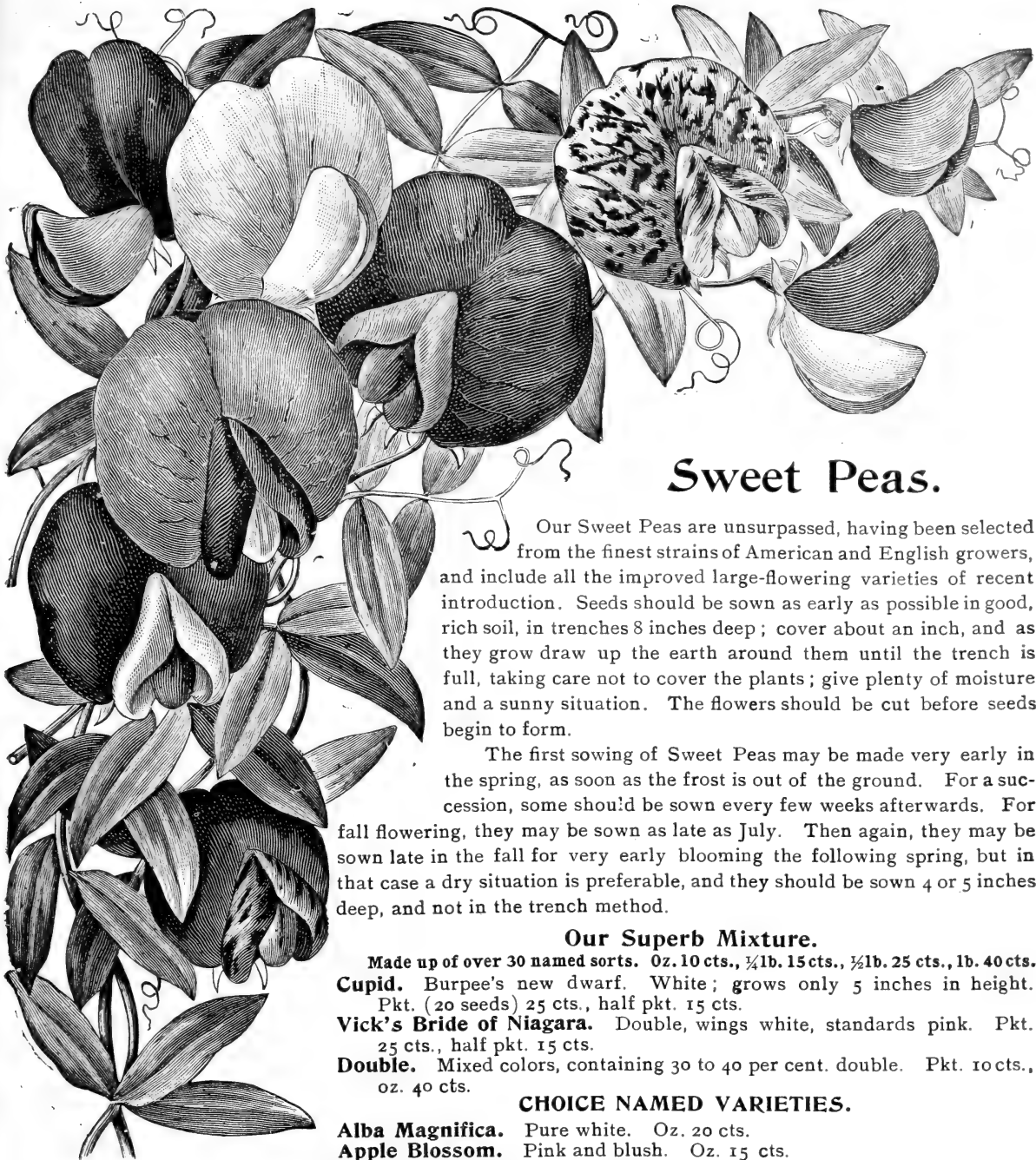

Sweet Peas.

Our Sweet Peas are unsurpassed, having been selected from the finest strains of American and English growers, and include all the improved large-flowering varieties of recent introduction. Seeds should be sown as early as possible in good, rich soil, in trenches 8 inches deep; cover about an inch, and as they grow draw up the earth around them until the trench is full, taking care not to cover the plants; give plenty of moisture and a sunny situation. The flowers should be cut before seeds begin to form.

The first sowing of Sweet Peas may be made very early in the spring, as soon as the frost is out of the ground. For a succession, some should be sown every few weeks afterwards. For fall flowering, they may be sown as late as July. Then again, they may be sown late in the fall for very early blooming the following spring, but in that case a dry situation is preferable, and they should be sown 4 or 5 inches deep, and not in the trench method.

Our Superb Mixture.

Made up of over 30 named sorts. Oz. 10 cts., $\frac{1}{4}$ lb. 15 cts., $\frac{1}{2}$ lb. 25 cts., lb. 40 cts.
Cupid. Burpee's new dwarf. White; grows only 5 inches in height. Pkt. (20 seeds) 25 cts., half pkt. 15 cts.
Vick's Bride of Niagara. Double, wings white, standards pink. Pkt. 25 cts., half pkt. 15 cts.
Double. Mixed colors, containing 30 to 40 per cent. double. Pkt. 10 cts., oz. 40 cts.

CHOICE NAMED VARIETIES.

Alba Magnifica. Pure white. Oz. 20 cts.
Apple Blossom. Pink and blush. Oz. 15 cts.
Blushing Beauty. A handsome new pink. Oz. 20 cts.
Mrs. Eckford. White, shaded with primrose. Oz. 20 cts.
Mrs. Gladstone. Delicate soft pink, with rosy blush wings. Oz. 15 cts.
Mrs. Sankey. The purest white, the most perfect form, the largest size; a profuse bloomer. Oz. 20c.
Nellie Jaynes. White and light pink. Oz. 15 cts.
Princess of Wales. White striped with lavender and mauve. Oz. 15 cts.
Painted Lady. Rosy crimson and blush white. Oz. 15 cts.
Primrose. Pale primrose yellow, novel and distinct. Oz. 20 cts.
Queen of the Isles. Red and white striped. Oz. 15c.
Red and White Striped. Oz. 15 cts.
Scarlet Invincible. Crimson scarlet. Oz. 15 cts.
Senator. Chocolate and creamy white. Oz. 20 cts.
Splendor. Coppery crimson, suffused with rosy pink. Oz. 15 cts.
The Queen. Bright pink, shaded with heliotrope. Oz. 15 cts.

Boreatton. Crimson purple, very dark. Oz. 15 cts.
Butterfly. Pale grey, with porcelain edge. Oz. 15c.
Captain of the Blues. Bright purple and pale blue. Oz. 15 cts.
Captain Clark. Tricolor. Oz. 15 cts.
Cardinal. Crimson scarlet. Oz. 15 cts.
Countess of Radnor. Lavender. Oz. 25 cts.
Delight. White, crested with crimson. Oz. 15 cts.
Eckford's Hybrids. All colors mixed. Oz. 15 cts.
Emily Henderson. Pure white. Oz. 25 cts.
Empress of India. Rosy pink standards, white wings. Oz. 20 cts.
Firefly. Intense glowing crimson scarlet. Oz. 20c.
Ignea. Fiery crimson scarlet, slightly flushed with purple. Oz. 25 cts.
Isa Eckford. Creamy white and rosy pink. Oz. 15c.
Lemon Queen. Blush and lemon. Oz. 25 cts.
Lottie Eckford. Rose and white, edged with blue.
Miss Blanche Ferry. Pink and white. Oz. 15 cts.
Miss Hunt. Carmine salmon and soft pink. Oz. 15c.
Monarch. Bronze, crimson and blue. Oz. 20 cts.

SWEET WILLIAM.

The much improved form in which this old and popular favorite is now offered renders it more desirable than ever. One of our best perennials.

*Sweet William.*

Mixed. Double and single. Pkt. 5 cts.

THUNBERGIA.

Slender, rapid-growing climbers, with extremely pretty and much admired flowers.

Mixed. All colors. Pkt. 5 cts.

VERBENA.

Seedling Verbenas are more robust in growth and produce larger and finer flowers than those grown from cuttings, and the light-colored varieties frequently have fragrant flowers when grown from seed. This is one of our brightest and best bedding plants, and its fine trusses of flowers represent every shade of every color except yellow. Plants from seed sown early in spring keep their beds gay with flowers from midsummer until frost; they are trailing in habit, and wide-spreading, loving a rich, sandy soil, plenty of room and full sunshine. A well-known and universal favorite, furnishing a continuous bloom throughout the entire season.

Cœrulea. Beautiful blue. Pkt. 10 cts.

Coccinea. Brilliant scarlet. Pkt. 10 cts.

Lemon. The popular fragrant shrub. Pkt. 10 cts.

Mammoth. Mixed colors of this recent introduction; flowers over twice the size of the old variety. A great improvement on the old. Pkt. 15 cts.

Striata. Beautifully striped. Pkt. 10 cts.

White. Of various shades. Pkt. 5 cts.

Mixed. Ordinary variety. Pkt. 5 cts.

*Verbena.***WALLFLOWER.**

Greatly prized on account of their delicious fragrance, and their profuse blooming renders them exceedingly attractive. Flowers are very bright-colored.

Mixed. Double. Pkt. 5c.

Mixed. Single. Pkt. 5c.

*Wallflower.***ZEA JAPONICA.**

A valuable ornamental foliage plant, presenting a beautiful appearance, with broad foliage, striped white and green.

Fol. variegata. Pkt. 5c.

ZINNIA.

Annuals of great beauty and brilliancy, the effective display they make in the late season being simply unequalled.

Canary. Pale yellow. Pkt. 10 cts.

Pompon. Small-flowered variety. Pkt. 10 cts.

Rose. Salmon color. Pkt. 10 cts.

Scarlet. Very brilliant. Pkt. 10 cts.

Striped. Many fine colors. Pkt. 10 cts.

White. Beautiful flowers. Pkt. 10 cts.

Mixed. Large-flowered sorts. Pkt. 10 cts.

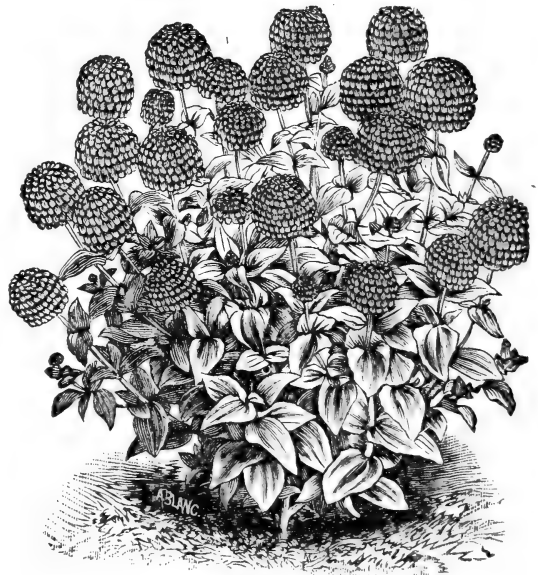
*Zinnia.*

Our Fall Catalogue
OF
Hyacinths, Tulips, Crocus,
and other Bulbs
will be ready in
SEPTEMBER.

What do you think of our Collection of Sweet Peas?

SUMMER FLOWERING BULBS.

GLADIOLI.

One
Of Our
Leading
Specialties.

GLADIOLUS.

Our Grand Mixed Gladiolus is composed of choice varieties only, and our customers can depend upon getting a large and magnificent variety of colors and markings. They cannot be too highly praised. 3 for 10 cts., 30 cts. per doz., \$1 for 50, \$1.75 per 100.

GLADIOLI UNDER COLOR.

Pink. This class comprises a wide range of colors, from light orange and very deep rose through various shades of pink to light rosy blush; large, well-formed flowers. 5 cts. each, 40 cts. per doz., \$3.25 per 100.

Salmon and Buff. This very rare class of Gladioli colors in a bouquet are very effective and pleasing; they are all of the most beautiful shades of salmon and buff. 5 cts. each, 60 cts. per doz., \$4.25 per 100.

Shades of Red Mixed. This mixture embraces various shades of red, and makes a very bright effect in bedding. 3 cts. each, 25 cts. per doz., \$1.75 per 100.

White and Light. Containing the very lightest colors in Gladioli, some of them very nearly pure white. 5 cts. each, 50 cts. per doz., \$3.50 per 100.

Yellow. Various shades of yellow and golden; among the most beautiful of all Gladioli. 5 cts. each, 40 cts. per doz., \$2.75 per 100.

Brenchleyensis. Brilliant scarlet; unsurpassed for planting in masses or groups. 5 cts. each, 35 cts. per doz.

Snow White. The best White Gladiolus; flowers of fine shape and large size. 20 cts. each, \$2 per doz.

NEW DWARF FRENCH CANNAS.

Mad. Montefiore. This grand variety is similar to Florence Vaughan, but of a much lighter shade of yellow, more on the style of Captain Suzzoni. This variety, when planted in masses, will give, even at a short distance, a clear yellow effect, while Florence Vaughan, on account of the deep yellow color and heavy spots, under the same conditions has more of an orange appearance. The flowers, which are of a fine, clear, light, yellow, spotted with red, are fully as large as Comte de Bouchard, while its habit of growth is also similar to that variety. This is undoubtedly finest Canna yet introduced for planting where a yellow effect is desired. 50 cts. each.

Florence Vaughan. Undoubtedly one of the finest yellow spotted varieties yet sent out; in color it is of a bright rich golden yellow, spotted with bright red; the flowers, which are of the largest size, of great substance and of perfect form, are borne in large heads and in the greatest profusion; the foliage is massive and of a rich green color; the plants rarely exceed 3 feet in height. 25 cts. each, \$2.50 per doz.

Charles Henderson. A grand variety, of a fine crimson color, that has become very popular. While it is not quite so rich in color as Alphonse Bouvier, its habit of growth is much more compact and uniform, rarely exceeding 3½ feet in height, which makes it a desirable companion to such varieties as Florence Vaughan and Madame Crozy. 25 cts. each, \$2.50 per doz.

Madame Crozy. The immense flower-heads of deepest vermilion, gold-bordered, are double the diameter of a Gladiolus spike, and these flower-spikes or heads follow each other so rapidly that the plant is always in bloom. The petals are very wide, and broadly rounded. It is especially in this size of individual flowers that Madame Crozy excels all Cannas. It is being extensively planted for cut-flower purposes. 20 cts. each, \$2 per doz.



Superb Tuberos-Rooted Begonias.

OUR STRAIN OF BEGONIAS IS UNEXCELLED.

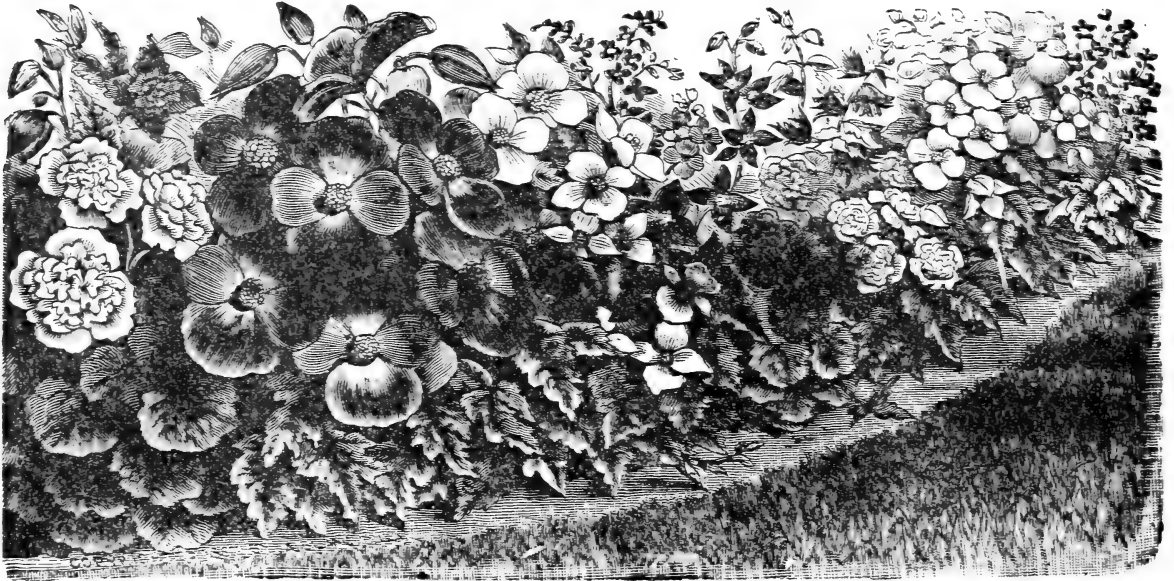

No class of plants of equal decorative value can be grown with less labor and attention than the Begonia. Plant about May 15, and you will have a mass of beautiful foliage set off with unsurpassed sprays of immense flowers, measuring from 4 to 7 inches across. The glistening leaves droop gracefully to the ground, and form a dense pyramid, crowned with an unbroken mass of flowers endless in color, from warm, rich scarlet, soft rose, golden yellow, pure white, etc. The plants are covered with bloom the entire season. When the foliage dies down in September or October, they should be set away in a warm, dry place to remain until planting time the following spring. Our strain of both double and single is superb, and must not be judged by ordinary bulbs. Those who plant our Begonia bulbs will be astonished at the great size and brilliancy of the flowers.

Single White, Pink, Yellow, Dark Crimson, Scarlet, Orange. 15 cts. each, \$1.50 per doz., \$10 per 100.

Single Mixed. All colors; a magnificent strain. 10 cts. each, \$1 per doz., \$9 per 100.

Double Mixed. All colors; a magnificent strain of finest large-flowered double sorts. They are perfectly magnificent. 25 cts. each, \$2.50 per doz.

TUBEROSES.

One of the most delightfully fragrant and beautiful of the summer-flowering bulbs. By skillful management a succession of flowers may be obtained all the year round. For early flowers they can be started in February or March in the greenhouse or hotbed, and for a succession they can be planted at intervals as late as August. For flowering in the open border, plant about the first of May.

Excelsior Pearl. Extra large bulbs. 5 cts. each, 35 cts. per doz., \$2 per 100.

New Early Branching Tuberose "Albino." Beautiful single-flowering variety; splendid for forcing and cutting. 10 cts. each, \$1 per doz.

CALADIUM ESCULENTUM.

(Elephant's Ear.)

One of the most effective plants in cultivation for the flower border or for planting out upon the lawn; it will grow in any good garden soil, and is of the easiest culture. Give plenty of water. Foliage, light green. When full size it stands 6 feet high, and bears immense leaves 3 to 4 feet long by 2½ feet wide.

Large bulbs, 8 to 10 inches in circumference, 25c. each, \$2.50 per doz.

Second size bulbs, 6 to 8 inches in circumference, 15 cts. each, \$1.50 per doz.



Caladium Esculentum.

DAHLIAS.**Large Flowering—Double.**

A complete range of color is always included in an assorted dozen.

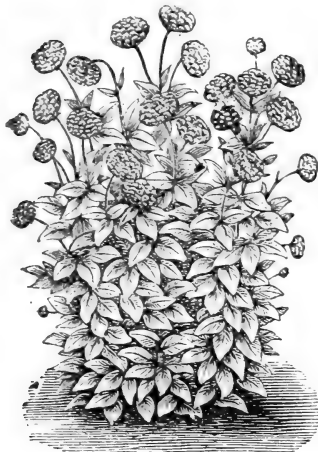
*Dahlias.*

Named Varieties.
20 cts. each, \$2 per doz.

Finest Mixed. 15
cts. each, \$1.50 per
doz.

**Bouquet, or Pompon.
Named Varieties.**
20 cts. each, \$2 per
doz.

Finest Mixed. 15
cts. each, \$1.50 per
doz.

PÆONIES.

The Herbaceous Pæonies are exceedingly hardy, and will succeed in any ordinary garden soil, well

enriched with good manure. During the summer months, mulching will be beneficial to the roots, especially on dry soils. We offer a splendid assortment in 12 distinct varieties, embracing all the leading shades—white, pink, crimson, rose, purple, etc. Good, strong roots, 25 cts. each, \$2.50 per doz.

LILIES—Lilium.

Auratum. (*Golden Japan Lily.*) Delicate white thickly studded with crimson spots, and through the center of each petal is a bright gold band, large and fragrant. Strong bulbs. 15 cts. each, \$1.50 per doz.

Lancifolium. (*Speciosum.*) The varieties of Lancifolium are perhaps the most popular Lilies grown; easy of cultivation; very showy and fragrant.

Lancifolium Album. Pure white; very fragrant. 20 cts. each, \$2 per doz.

Lancifolium Monstrosum Album. Distinct variety; pure white flowers; very floriferous. 20 cts. each, \$2 per doz.

Lancifolium Roseum. White, spotted rose. 15 cts. each, \$1.50 per doz.

Lancifolium Rubrum.
Rose, spotted with
crimson. 15c. each,
\$1.50 per doz.

*Pæonies.**Lilium Auratum*

Tigrinum. (*Tiger Lily.*) Orange salmon. 10 cts. each, \$1 per doz.

Tigrinum Flore Plena. (*Double Tiger Lily.*) 10 cts. each, \$1 per doz.

MADEIRA VINE.

A rapid-growing graceful vine, with smooth, glossy leaves, bearing racemes of tiny, white, fragrant flowers. 5 cts. each, 50 cts. per doz., \$3 per 100.

TIGRID IA.

Grandiflora Alba. Flowers are large, pearly white, marked at base reddish brown. 5 cts. each, 50c. per doz.

GLOXINIAS.

Including all the most gorgeous shades, varied and spotted. 20 cts. each, \$2 per doz.

The Crimson Rambler Rose.

This Rose is unquestionably an acquisition, a novelty of high order, and most distinct in its character-

istics. It is a running or climbing Rose, of vigorous habit, strong and rapid growth, with handsome shining foliage, and produces in marvelous abundance clusters of the brightest crimson semi-double Roses. Its clustered form, its brilliancy, the abundance of its bloom, and the great length of time the flowers remain on the plant without losing their brilliancy are qualities which will make this new claimant for admiration an assured favorite. For verandas, walls, pillars, and fences it is a most suitable plant. If grown in beds, and pegged down, it produces marvelous heads of bloom, or it can be grown in bush form, and thus become a most striking object. Large, very fine plants, \$1 each, \$9 per doz.; plants from 3-inch pots 30 cts. each, \$3 per doz.; small plants 15 cts. each, \$1.50 per doz.

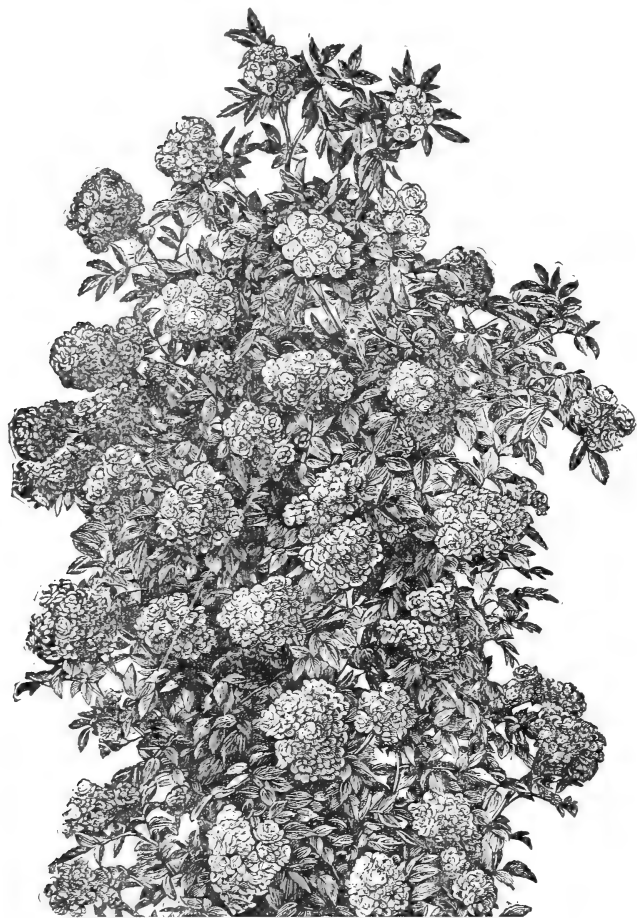

Crimson Rambler.

Twelve Best Hardy Roses.

- Anna de Diesbach.** Beautiful carmine; large, double.
- Boule de Neige.** ("Ball of Snow.") Pure white; very free in blooming.
- Caprice.** The best striped hardy Rose; ground color bright carmine, striped very broadly and distinctly with white.
- Gen. Jacqueminot.** Color, rich crimson; of fine shape and exquisite fragrance. This grand old variety holds its own against all new-comers, and is undoubtedly the finest hardy Rose of its color.
- Mad. Masson.** Clear, bright rosy red; deliciously fragrant.
- Magna Charta.** Deep pink; large and full; a grand rose.
- Mme. Plantier.** Perfectly hardy, pure white, double.
- Paul Neyron.** A beautiful shade of deep rose, occasionally lightening to a satiny pink in the center.
- Prince Camille de Rohan.** One of the grandest hardy red Roses, best described as blackish crimson.
- Queen of Queens.** Pink, with blush edges.
- Ulrich Brunner.** The flower is large and cupped; bright cherry red, and very fragrant.
- Xavier Olibo.** Deep rich crimson; perfectly formed flowers.
- 50 cts. each for large 2-year-old Plants, 30 cts. each for 1-year-old Plants.

The Memorial Rose.

It creeps along the ground almost as closely as Ivy, growing 10 feet in one season, and forming a dense mat of dark green lustrous foliage, with thornless stems. The flowers are produced in clusters on the ends of short side-branches. They are single, pure white and fragrant. This Rose is largely used in the famous park system of Boston for covering rocky slopes, embankments and such places as it is desirable to cover quickly with foliage, as it readily adapts itself to all conditions of soil. Extra-large plants 60 cts. each, 2 for \$1, 5 for \$2, 12 for \$4.50; small plants 40 cts. each, 3 for \$1, 12 for \$3.

Twelve Monthly Everblooming Roses.

- Bridesmaid.** Deep brilliant pink.
- Catherine Mermet.** Delicate rosy pink, unapproached in any other Rose. The buds are large, long and pointed.
- Mad. Hoste.** Creamy white, with a clear amber center.
- Niphotos.** The White Rose *par excellence*—large pointed buds.
- Papa Gontier.** Glowing carmine crimson.
- Perle des Jardins.** Rich shade of yellow; large and of perfect form; tea fragrance.
- Souvenir de Wootten.** Beautiful crimson; deliciously fragrant; a constant and most prolific bloomer.
- Sunset.** This exquisite orange-yellow variety is one of the finest Tea Roses grown.
- The Bride.** A pure white Rose, of large size and most perfect form.
- Marie Lambert.** Pure white, everblooming; of large size and most perfect form.
- Hermosa.** This grand pink bedding Rose is most prolific in blooming; and is almost entirely hardy.
- Agrippina.** Rich crimson.
- 50 cts. each for large 2-year-old Plants, 30 cts. each for 1-year-old Plants.

Clematis. (Large-Flowering.)

During recent years the Clematis has been subject to a fungoid disease, which destroyed thousands of fine plants. This disease seems to be confined to the imported plants, which constitute the major portion sold in the country, and to avoid it, we have secured a complete new stock of home-grown plants on their own roots, which, while not as large as the others, are infinitely better, being free from the fatal disease.

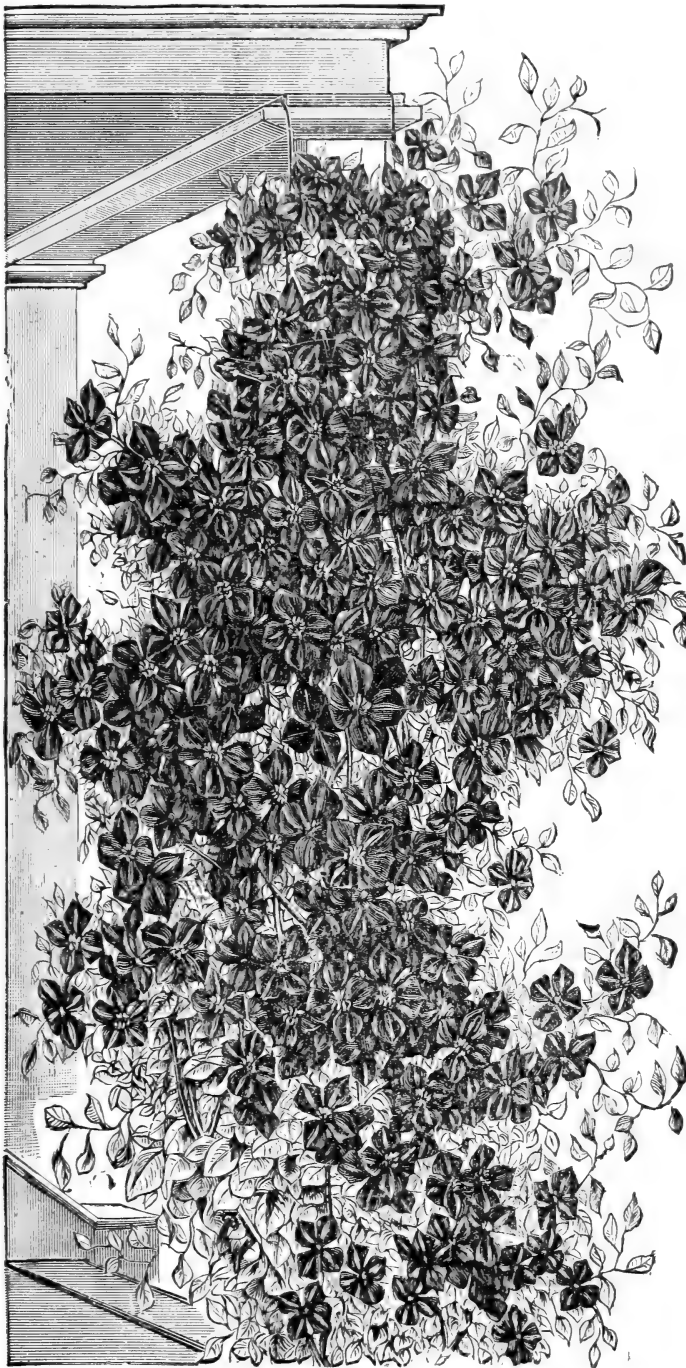

Clematis Jackmanni.

NEW PINK CLEMATIS, **Mme. Baron Veillard.** A unique shade in Clematis, a pretty lavender pink; a fine contrast to the stronger-colored sorts. 75 cts. each, \$7.50 per doz.

NEW RED CLEMATIS, **Madame Edouard Andre.** The nearest approach to a bright red ever sent out. The plant is a strong, vigorous grower, being a hybrid of the popular Jackmanni, which it resembles in freedom of bloom, strong, vigorous growth and shape and size of flower. 75 cts. each, \$7.50 per doz.

C. Jackmanni. A perfect mass of bloom when in full flower. Color, dark, rich, royal purple. (See *cut.*) 1st size, 75 cts. each, \$7.50 per doz.; 2d size, 50 cts. each, \$5 per doz.

C. Henryi. Recognized as by far the finest of the single white sorts. It is a much stronger grower than most of the other varieties, and is *entirely hardy*. Large, strong plants, 75 cts. each, \$7.50 per doz.; 2d size, 50 cts. each, \$5 per doz.

C. Duchess of Edinburgh. Distinct from *C. Henryi* in form, being perfectly double, like a rosette. 1st size, large plants, 75 cts. each, \$7.50 per doz.; 2d size, 50 cts. each, \$5 per doz.

C. Large-Flowering, Assorted. In addition to those previously mentioned, we can supply Double Blue, Single Blue, Lilac, Lavender, and many intermediate shades, all strong plants. 75 cts. each, \$7.50 per doz.; 2d size, 50 cts. each, \$5 per doz.

C. Small-Flowered Varieties.

C. paniculata. One of the most beautiful of our hardy fall-blooming vines. The flowers are pure white, very fragrant, and are borne in great clusters of bloom, fairly covering the plant, so that it is a mass of fleecy white; the fragrance is delicious. 20 cts. each, 3 for 50 cts., 6 for \$1.

C. coccinea. Bright vermilion scarlet. Flowers conical, about 1½ ins. long, 1 in. thick at the base. 25 cts. each, 5 for \$1.

C. crispa. The flowers are bell-shaped, purplish blue, and emit a rich fragrance. 25 cts. each, 5 for \$1.

C. flammula. (*Virgin's Bower.*) Pure white blooms in clusters; delicate fragrance. 20 cts. each, 6 for \$1.

Ampelopsis Veitchii.

(Sometimes called "Boston Ivy" and "Japan Ivy.")

Entirely hardy, clinging to walls with the greatest tenacity. In the summer the foliage is a rich shade of green, but in the fall it assumes the most gorgeous tints of scarlet, crimson and orange. 1st size, extra strong pot-grown plants, 2 to 3 feet, 50 cts. each, \$4.50 per doz.; 2d size, pot-grown, 1½ to 2 feet, 30 cts. each, \$3 per doz.; 3d size, pot-grown, 6 to 12 inches, 15 cts. each, \$1.50 per doz.



Strawberries.

Strawberries can be more successfully grown over a wider field and on a greater variety of soil than any other of the small fruits, come into fruiting in shortest time after planting, and are the first fruits of the year to ripen. Will fruit fairly well on any soil and with little or no culture, yet respond most readily to kindly location and liberal feeding and culture. Every home builder who fails to have the delicious, health-giving Strawberry as one of the foundation supports, misses a chance of great things for little money. How best to do it is told in Judge Biggle's berry book, just issued, which we can furnish at the low price of 50 cents.

Judge Biggle made up his berry book by asking 20 different questions of his friends, and the different answers to these questions are grouped in so many chapters, so that really each chapter is only the combined wisdom of our best fruit growers.

Promising New and Recently Introduced Varieties.

Those marked (P.) have pistillate or imperfect flowers, and must be planted near perfect-flowering kinds in order that the flowers may be fertilized.

Lovett. Large, round, conical, uniform, seldom ill-shaped; bright crimson; quality good. A variety of merit, not early but continuing good through the season. We regard it as one of the best of the newer kinds. 30 cts. per doz., \$1.50 per 100.

Crescent. (P.) Medium to large, conical, slightly depressed at the apex; color, bright scarlet; flesh soft, quite acid; plant very vigorous and hardy, and for productiveness has scarcely an equal; very profitable for home market; season early to late. 50 cts. per doz., \$2.50 per 100.

Gandy. Large and handsome, roundish conical; uniform in size and shape; bright scarlet; firm, fair quality; vigorous and productive; a valuable late variety. 30 cts. per doz., \$1.50 per 100.

Bubach. (No. 5.) (P.) Fruit large and handsome, roundish conical; bright scarlet; moderately firm, of fair quality. Plant a strong grower, with large, healthy foliage, and very productive; succeeds on light or heavy soil. Desirable for home use and near-by market. One of the best of the later introductions. Season early to medium. 30 cts. per doz., \$1.50 per 100.

Sharpless. This variety originated in Pennsylvania, and was introduced 16 years ago. It has been fruited extensively ever since, and is still regarded as one of the very largest and best Strawberries in cultivation. Plant very hardy, enduring both heat and cold without injury here. To secure the best results, we advise "hill culture."

Our selection of Small Fruits is very choice, and all who love really fine berries would do well to study the lists. Varieties selected for the home garden or fruit-lot should be of much higher grade as to quality than those grown chiefly for productiveness in commercial culture.

STRAWBERRIES, continued.

Parker Earle. A splendid berry; uniformly large, regular, conical with a short neck; color glossy scarlet crimson; ripens all over; flesh moderately firm, no hollow core; quality good; flowers perfect; always setting perfect fruit. Plant very vigorous, healthy and remarkably productive. It is said to have yielded at the rate of 15,000 quarts per acre. Its robust habit will, we think, render it capable of enduring extremes of heat and cold, and to thrive on a great variety of soils.

Greenville. (P.) This variety comes so highly recommended that we catalogue it, appending the description of the introducer: "Berries of large size, good quality, medium texture, very productive; season medium to late; color very even and fine; plant very vigorous and free from rust."

Timbrell. (P.) Another new variety highly spoken of, but which we have not yet fruited. The description is that of the raiser: "Berries large to very large, dark crimson; very firm, a good shipper; plant strong and healthy, very prolific." Has been very widely advertised.

Haverland. (P.) Large, long, light red; moderately firm, medium quality, ripens all over. Very vigorous and healthy and a great yielder; appears to be a valuable addition to the list of varieties for home use or near market, and one of the best of recent introduction. Needs to be well mulched to keep fruit clean; season early.

Marshall. Very large, roundish, dark rich crimson; quality fine; firm, plant vigorous, productive; season medium to late. \$1 per doz., \$5 per 100.

Any of the above varieties, 60 cts. per doz., \$3 per 100, except where noted.

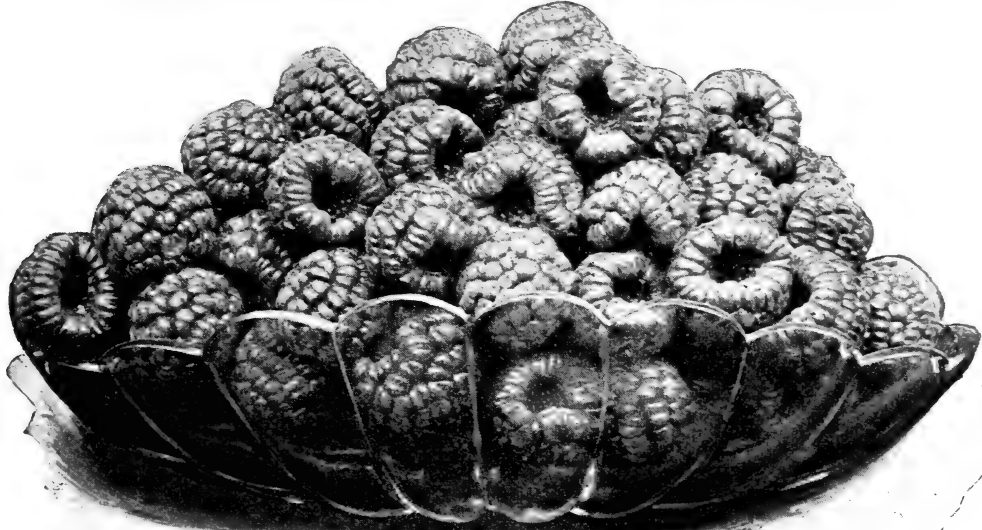

Raspberries.

Really the most reliable and profitable of all the small fruits, unless, perhaps, it be the currant. While Raspberries will thrive fairly well on almost any soil except that which is low and wet, they come to their highest perfection on a deep, rich, moist loam. The blackcaps often grow well and fruit to perfection on quite light, dry sand.

The red and yellow varieties, such as are propagated from division of the roots, may be planted in the autumn, after the leaves fall, or in early spring; while the cap varieties, that are propagated by layering the tips, should always be planted in spring, either quite early, before the crowns start, or late, when they are 3 to 6 inches high, when they may be handled much the same as other hardy plants in a growing condition.

The ground should always be liberally manured for Raspberries, or any crop, for that matter, unless it be naturally in a high state of fertility. Well-rotted stable manure, supplemented with potash in some form, or any good commercial fertilizer rich in phosphoric acid and potash, will answer. Plow the ground deeply and well. Whatever fertilizer is used apply broadcast after plowing, and work in with the harrow. Most people make the mistake of planting too closely. The strong-growing red varieties, if liberally fed, will give best returns if planted in check rows, not closer than 7 x 7 feet, while 5 x 5 is close enough for the blackcaps; and if one has an abundance of land, extending each of these a foot will result in better berries.

Red Varieties.

Thompson's Early Prolific. Probably the best early red Raspberry for general cultivation that we now have. An excellent grower; canes erect, stout and hardy. Berries are medium to large, bright crimson and very productive. 60 cts. per doz., \$4 per 100, \$20 per 1,000.

Cuthbert. The leading market variety. Canes hardy; large, healthy foliage. Berries large, dark crimson, quite firm and of good flavor. Season late. 50 cts. per doz., \$3 per 100, \$15 per 1,000.

Turner. (*Southern Thornless.*) Very desirable as an early sort for the home garden. Very productive. Berries of good size, bright crimson color, soft and of honeyed sweetness. The plants sucker immoderately, and these should be treated as weeds. 50 cts. per doz., \$3 per 100, \$15 per 1,000.

Loudon. A seedling of Turner crossed with Cuthbert, combining earliness, hardiness, beauty and sweetness of the one with the great vigor, size and productiveness of the other. 50c. each, \$5 per doz.

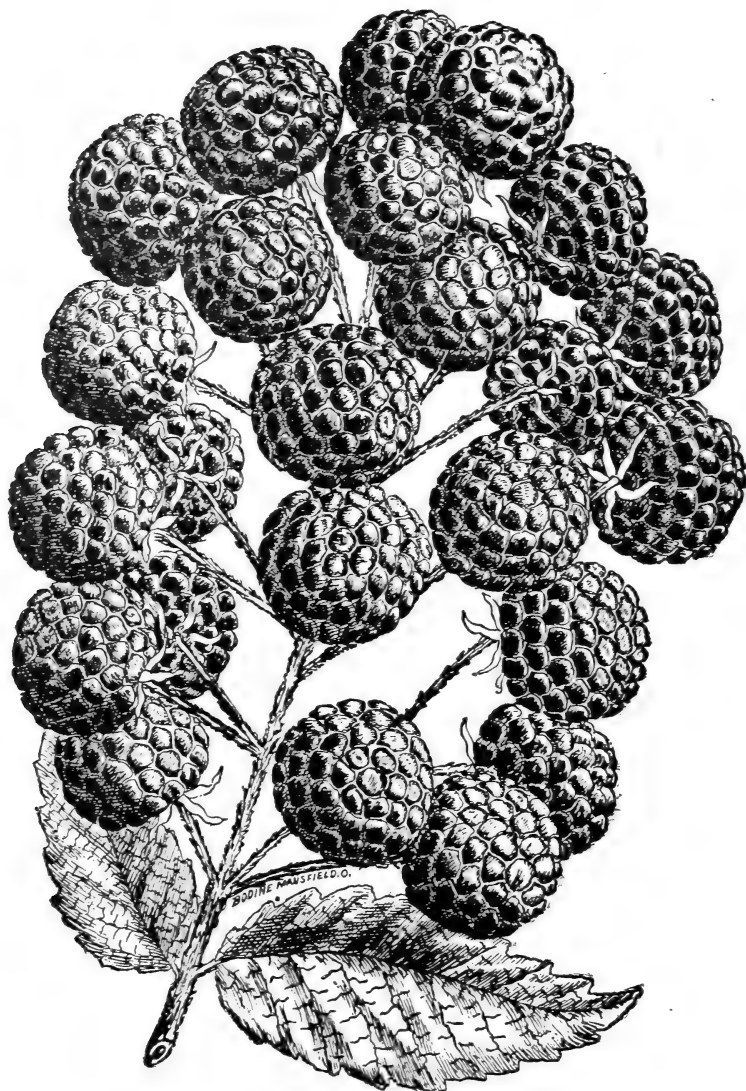

Black or "Cap" Raspberries.

Gregg. Largest and latest of all. Valuable for family use, and for such markets as can profitably handle late fruits. 50 cts. per doz., \$2 per 100, \$10 per 1,000.

Palmer. Very early and a grand fruit for either family or market; vigorous and hardy, with foliage healthy, and free from rust. 50 cts. per doz., \$3 per 100.

Older. No one will make a mistake in planting the Older, either for home use or for market. Enormously productive; fruit very large, solid and high-flavored. 50 cts. per doz., \$3 per 100.

Kansas. A very heavy, stocky grower of the Gregg type; exceedingly productive of very large black berries; fine-grained, solid and showy. Ripens about with the Older. 50 cts. per doz., \$3 per 100.

Currants.

None of the small fruits can be so easily and cheaply grown as the Currant, and once a plantation is established it may be continued in fruiting for many years. As a staple farm crop, as many bushels per acre can be grown as corn, and at almost the same cost one year with another, while the currants will sell at from four to six times as much. Why not try Currants? It will mean a steady cash income every year.

Fay's Prolific. Has been carefully cultivated alongside of all the popular varieties, and proved by far the most prolific of all; color, rich red; as compared with the Cherry Currant, Fay's Prolific is equal in size, better flavor, with much less acid, and five times as prolific; also, from its peculiar stem, less expensive to pick. It is one of the few good things that will sustain all the claims made for it. 1-year, 75 cts. per doz., \$4 per 100; 2-year, \$1 per doz., \$7 per 100.

Cherry, or Versailles. 1-year, 50 cts. per doz., \$3 per 100; 2-year, 75 cts. per doz., \$5 per 100.

White Grape. 1-year, 75 cts. per doz., \$4 per 100; 2-year, \$1 per doz., \$6 per 100.



Blackberries.

Blackberries are usually grown in rows 6 to 8 feet apart, with plants $2\frac{1}{2}$ to $3\frac{1}{2}$ feet in the row, and allowed to grow so as to form a solid hedge-row. They will grow and fruit well on land of modern fertility; on very rich soil they are inclined to make too much wood growth. Careful thinning and close pruning of the canes will, however, insure plenty of fruit.

Snyder. The great Blackberry for market in the north, as it is the most vigorous, hardy, productive and reliable of all; has never been known to winterkill; fruit of medium size and good quality; ripens medium to late. 50 cts. per doz., \$2 per 100.

Wachusett Thornless. A grand berry for the family garden; it is perfectly hardy; strong, vigorous; canes free from thorns; fruit of good size and fine flavor; ripens medium to late, and continues in bearing for a long time, often into September; productive under high culture, but will not thrive on dry, thin soil. 75 cts. per doz., \$3 per 100.

Erie. It is the most vigorous and healthy plant of any Blackberry we have ever grown, and thus far absolutely hardy; very productive of berries of the largest size; coal-black, firm and solid, and sells in the market at highest prices; fine form, and ripens early; is being extensively planted both in family and market gardens. 50 cts. per doz., \$2 per 100.

Hardy Grapes in Variety.

Agawam. (*Rogers' No. 15.*) Berries large; of bronze color; bunches of good size and form. 25 cts. each, \$2.50 per doz.

Concord. One of the best old sorts; bunch and berries large; color black, with a rich bloom. 20 cts. each, \$2 per doz.

Delaware. Red; bunches compact; berries small, sweet and of the most excellent flavor. 25 cts. each, \$2.50 per doz.

Golden Pocklington. Very large; deep amber in color. One of the most attractive Grapes grown. 25 cts. each, \$2.50 per doz.

Moore's Early. Resembling the Concord in style of growth and berry, ripening two weeks earlier. 30 cts. each, \$3 per doz.

Martha. One of the best greenish-white Grapes; exquisite flavor. 20 cts. each, \$2 per doz.

Merrimack. (*Rogers' No. 19.*) Large berry; jet black; fine quality. 25 cts. each, \$2.50 per doz.

Niagara. A grand white Grape; hardy, fine quality. 25 cts. each, \$2.50 per doz.

Salem. (*Rogers' No. 53.*) A splendid coppery red Grape, ripening with Concord; tender; juicy; one of the very best. 25 cts. each, \$2.50 per doz.

Worden. Black; very juicy; large size; early. 25 cts. each, \$2.50 per doz.

Wilder. (*Rogers' No. 4.*) An excellent variety; berries medium; bunches large; color black. 25 cts. each, \$2.50 per doz.

Perfect Glazier Points.

These are made of steel wire, and galvanized, having double points, and lap over the glass in such a manner as to positively keep it from sliding. They may be used on either side of the sash-bar, thus preventing the annoyance of rights and lefts. Box of 1,000, 60 cts., by mail 75 cts.; lots of 5,000 and over, per box, 55 cts.; pincers for driving, 50 cts.

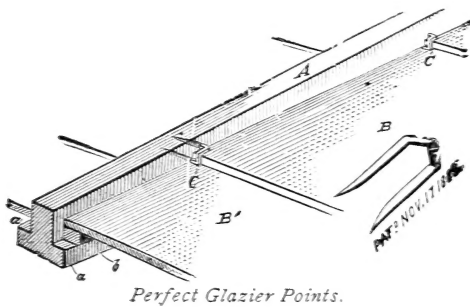

Perfect Glazier Points.

Bellows.

Very effective and useful in the application of the various insecticides and fungicides which are used. Single cone \$1, double cone \$3, spraying \$2, sulphur \$1.50.

Water-Barrel Truck.

The Water-Barrel Truck is designed for carrying water to the garden or lawn, and will be found of great service during the hot summer months. By its use the flower garden and lawn can be kept well watered with an expenditure of very little time and labor, and, instead of the lawn or garden becoming burned and dried up by the scorching sun, the few minutes spent in the morning or evening watering will be amply repaid by the fresh and beautiful appearance of both flowers and grass. Considering the innumerable purposes for which this truck is adapted, it becomes indispensable after once using. The barrel can be raised from the ground, carried to the place desired, and instantly detached, all *without handling*. Net price: Truck, complete with barrel, \$10 net.

New Model Seed Drill.

ITS FEATURES.

Regulations of Discharge. Drills of similar construction are usually provided with a series of holes of varying sizes, through which the seed is passed, which, of course, do not always give an opening of the exact size required. The operator is usually told, in substance, that "if one hole doesn't suit, try another." This adjustment in the Model is accomplished in a very simple and effective manner by the use of a slide with a pear-shaped opening passing under the bottom of the seed reservoir, which is provided with a perforation of similar shape in a reversed position. This slide can be instantly adjusted to size, indicated by Index, or to a hair-breadth variation between—a vital point in a perfect seed drill. This Index, or indicator, is plain, convenient and reliable. It is placed in open sight, immediately under the eye of the operator and can be quickly adjusted to the slightest variation desired. As the names of the principal seeds are plainly shown on the Index itself, it is not necessary to refer to any table of reference.

Cut-off. The flow of seed can be instantly stopped, when desired, by a swinging cut-off, conveniently operated by a cord and ring on handles.

Marker. Is simple, easily adjusted, and firmly held.

Broad Wheel. The main wheel is of large size and of unusual width, preventing its sinking into soft earth.

Covering Roller. It is attached by a swinging frame, enabling the operator to roll lightly or otherwise, by varying the pressure on the handles.

Opening Plow. It is of steel, adjustable in depth. Price \$7.50.

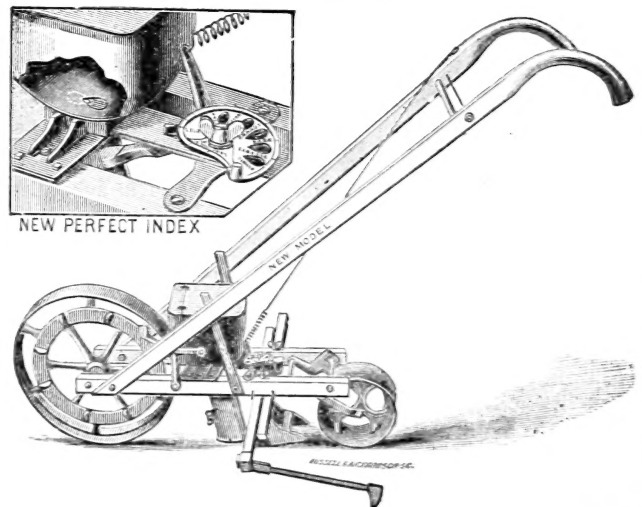

New Model Seed Drill.

"Planet Jr." Garden Tools.

Space will not permit illustrating and describing all of the "Planet Jr." tools, but we will gladly send a fully illustrated catalogue to any who desire it; and we can supply promptly anything ordered. "Planet Jr." goods are standard machines and the best on the market. Prices are greatly reduced from last year, and are so low that the manufacturers now insist that everybody shall sell at the same price. In sending your orders to us you can therefore rely on getting bottom prices.

The New "Planet Jr." No. 3 Hill-Dropping Seed Drill. SOWS EITHER IN HILLS OR IN CONTINUOUS ROW.

Until recently there was no such thing as a Hill-Dropping Seeder, the most modern Drills sowing continuously only, but the demand for a machine that could be adjusted to sow in hills was very great.

This Drill will sow in a continuous row, in the ordinary way, with the greatest regularity; but its distinctive feature is that it will drop neatly in hills, either four, six, eight, twelve or twenty-four inches apart. It opens the furrow, drops in hills or drills, covers, rolls down and marks the next row, all at one operation. The hopper holds three quarts. The wheel is thirteen inches high. It is changed in a moment from hill-dropping to drill work. It has a force-feed, sows equally well whether the hopper is full or contains only a paper of seed, and will not injure delicate seed, such as radish, cabbage etc. The manufacturers guarantee it to give entire satisfaction. **Price, \$9.**

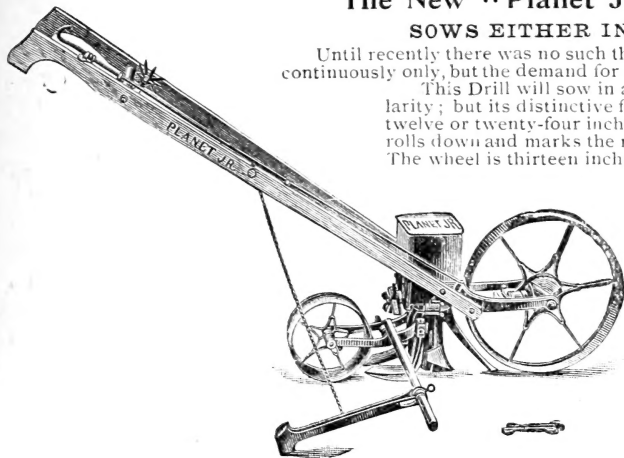

The "Planet Jr." Combined Drill and Wheel Hoe.

This combined tool has a complete set of cultivating tools, and all its operations are rapid, easy, perfect and delightful. When used as a Drill the seed is sown with great regularity and at uniform depth, regulated at pleasure. The hopper holds one quart. The door, when opened, forms a convenient spout for filling with seed. From a Drill it is changed to its other uses by unscrewing but two bolts, when any of the attachments shown in the cut can be instantly attached. In short, every purchaser of this machine will find it an excellent seed sower; a first-class double wheel hoe for use when plants are small; a first-class single wheel hoe; an excellent furrower; an admirable wheel cultivator; a capital garden rake; a rapid and efficient wheel garden plow; and that it is without an equal in variety of tools, easy adjustment, lightness, strength and beauty. **The Price is \$9.**

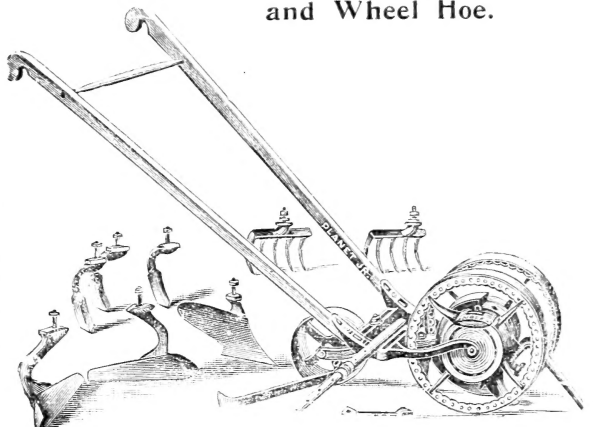

The "Planet Jr." Double Wheel Hoe.

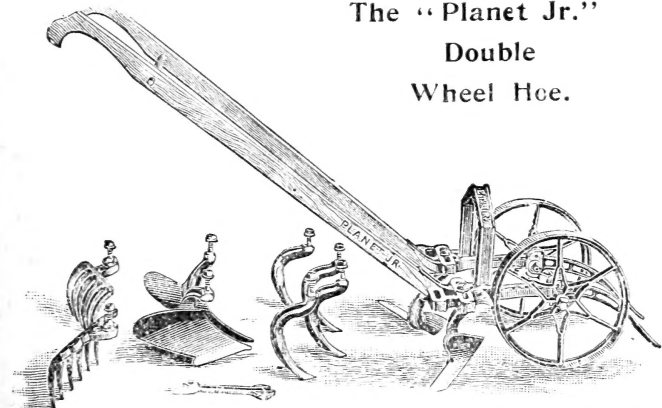

Thousands of farmers and gardeners who own this tool save its cost one or more times every year, for in an onion field and among many other crops, one can do more and better work with it than six men with ordinary hoes. It is invaluable for all market garden crops. The wheels are only ten inches high, as a high wheel is wrong for a Wheel Hoe, since the wheels are simply depth regulators, not load carriers.

The "Planet Jr." Double Wheel Hoe will straddle plants eighteen inches high, and finish rows from six to eighteen inches apart at one passage. One hoe sets slightly ahead of the other to prevent dragging out young plants. The new frame permits the changing of attachments *without removing the nuts*. All the tools shown in the cut go with the machine for the price; and all the blades are steel, hardened in oil and polished. The wheels are adjustable to make the work shallow or deep, as required, and to adapt the machine to all width rows. The tool is charming in every style and kind of work, the admiration of all who see it in operation and is the acknowledged standard the world over. **Price, \$6.**

To accommodate those who have little work but hoeing, we offer the above machine with hoes only under the name of "Planet Jr." Plain Double Wheel Hoe, at **\$3.50**. The other parts can be added at any time and will be found to fit.

The "Planet Jr." Single Wheel Hoe.

This Wheel Hoe is considerably lighter than the Double, but does almost the same variety of work, being used mostly between the rows, yet it can be used to hoe both sides at once, while plants are small, by placing the wheel at one side of the frame. The form of the hoes insures a forward slanting cut next to the plant and consequent close work without danger, and thorough cultivation of the soil. The rakes and cultivator teeth and the hoes and plow enable the operator to perform almost every variety of work, either in the field or garden. All rows from six to eighteen inches apart can be hoed at one passage. The frame is quickly raised or lowered to regulate depth; and the wheel has an extra broad face. It is pronounced by practical men without an equal in design and finish, ease of operation, variety of adjustment and perfection of work, and we feel confident that everyone who tries this tool will be glad he did so. **Price, \$4.50.** To supply a demand for a cheap **Single Wheel Hoe**, we offer the above machine, with the hoes only, at **\$2.75**, and the other attachments can be added at any time, and will be found to fit.

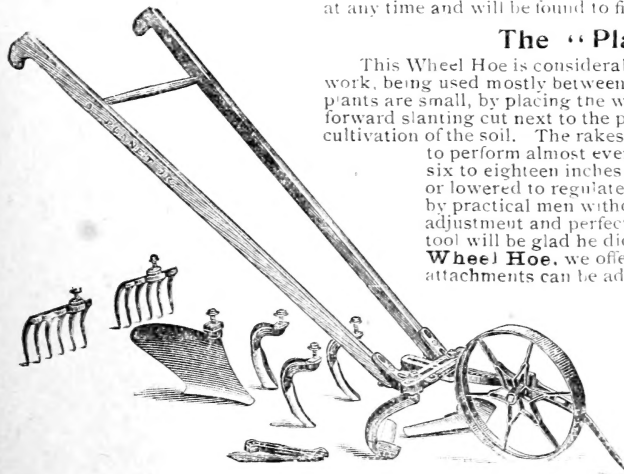

The "Fire-Fly" Single Wheel Hoe, Cultivator and Plow.

This popular tool is exactly the same as the "Planet Jr." Single Wheel Hoe, excepting that it does not have the rakes or leaf lifter. The attachments are a pair of hoes that can be set to work to or from the row, a set of three reversible cultivator teeth, and a large garden plow. The whole tool is light and strong and capable of standing hard usage for years. **Price, \$3.75.**

